



SIMATIC IDENT

Industrial identification for company-wide data intelligence

[siemens.com/ident](https://www.siemens.com/ident)

SIEMENS

Let the **data**
journey begin

Discover and explore Siemens' comprehensive industrial identification portfolio. Find the right product for your application directly using intuitive navigation.



Industrial identification: Enabler for the IIoT

Industrial identification turns a regular object into a smart object. It makes it possible to read these objects and exchange data with them. This integrates the objects not only in automation, but also in the Industrial Internet of Things (IIoT), and makes industrial identification a key technology for the digital transformation.

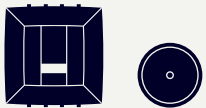

Radio Frequency Identification (RFID)

RFID is based on radio waves. A reader communicates contactlessly with a data storage device – also known as a transponder, tag, or SmartLabel – attached to the object. The data exchange requires no line-of-sight connection between the read/write device and the transponder. Because transponders need no energy storage (such as a battery), RFID is especially eco-friendly.



Optical identification (OID)

For OID, a camera is the central element in the fast, accurate reading and verification of various codes and in object recognition. Its purpose is to seamlessly track products and components across the entire value chain. Reflective or soiled surfaces, difficult lighting conditions, and different reading ranges are no problem.

How RFID works

Wireless technology for locating and tracking objects.

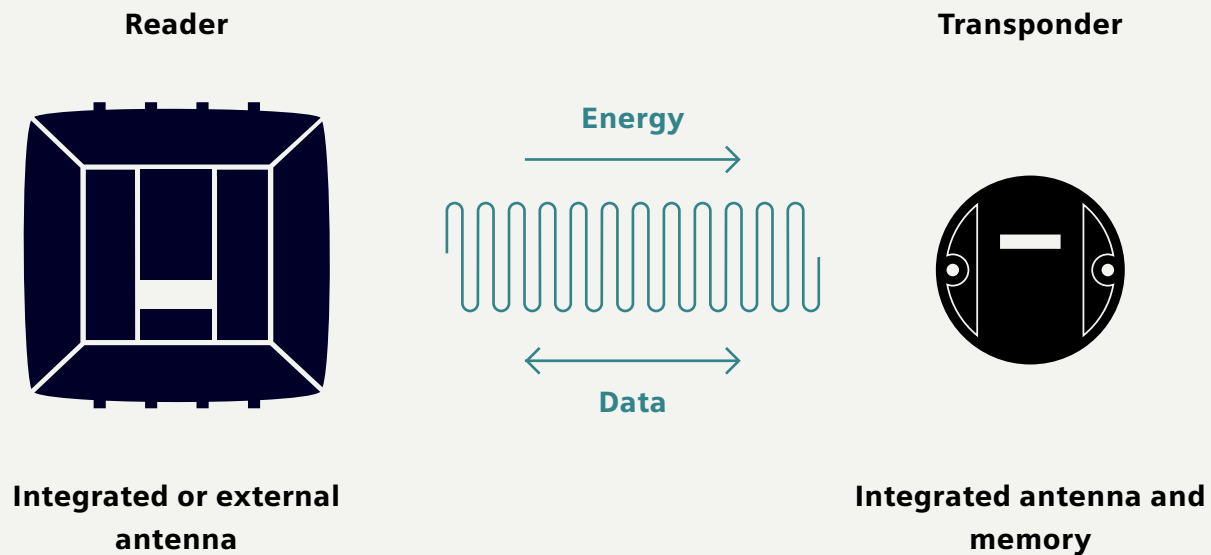

- Reads and writes – no direct line of sight required
- Possible to read multiple transponders simultaneously

- Passive transponders (without battery), hard tags, and labels for a variety of applications

How OI D works

Optical technology for identifying objects.

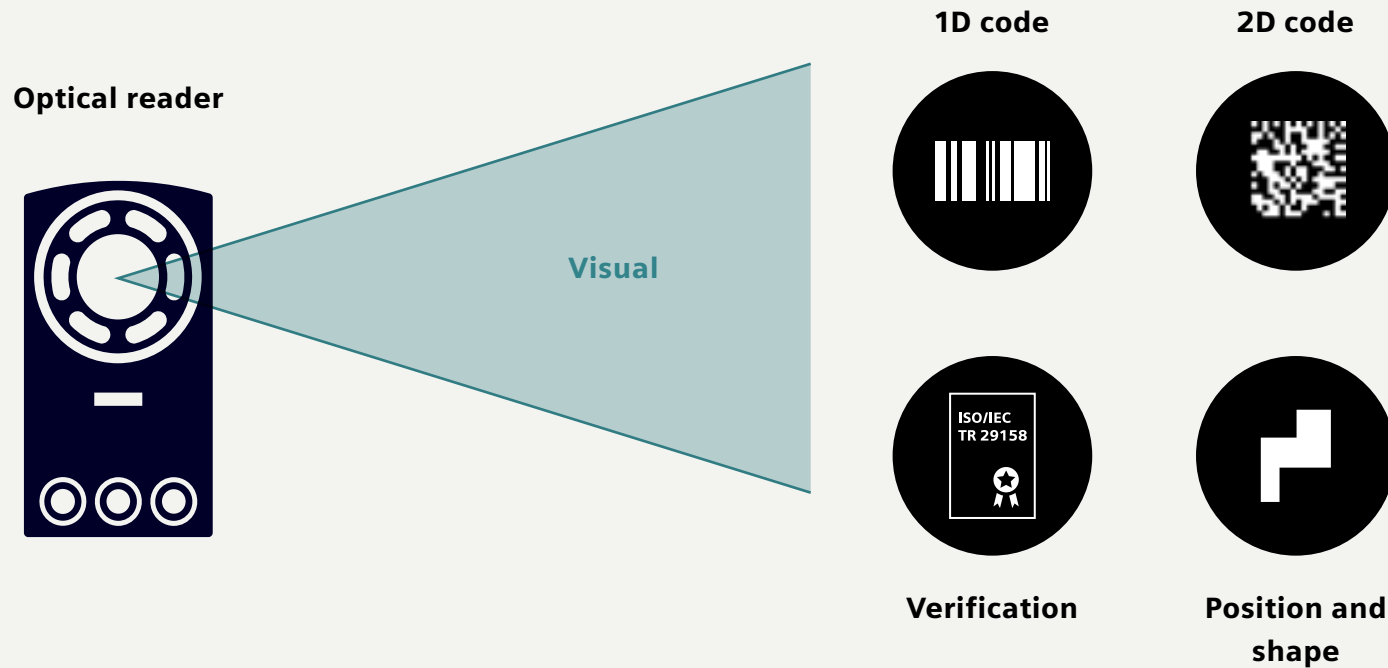

- Direct line of sight required
- Code reading, object recognition and verification

- Direct identification of products and components
- Printed, lasered, or dot-peened

Integration

Communication modules for various integration options



Direct integration on the device

OPC UA

EtherNet/IP

PROFINET

PROFINET

Radio Frequency Identification (RFID)

Readers

Short ranges (HF)

Works quickly and flexibly and is especially cost-efficient



Short ranges (HF)

Equipped with a large memory and transmits data at record speed



Long ranges (UHF)

Reliably tracks thousands of objects



Access control (LF/HF)

Handles access management using existing employee IDs



Antennas



Transponders



SIMATIC Ident Systems

Complete, pre-configured, ready to use systems for identifying and tracking objects

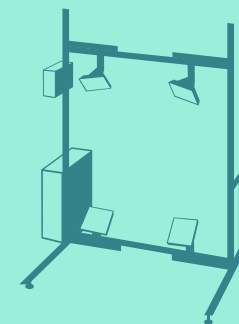

Optical identification (OID)

Code reader, including object recognition and verification

Reliably reads at record speed, even under difficult conditions



Sits comfortably in your hand and suitable for mobile use



If you need help with the selection of SIMATIC Ident components, you can use the TIA Selection Tool: www.siemens.com/tst

Areas of application for industrial identification

The potential applications for industrial identification vary widely and are highly beneficial for many industries.

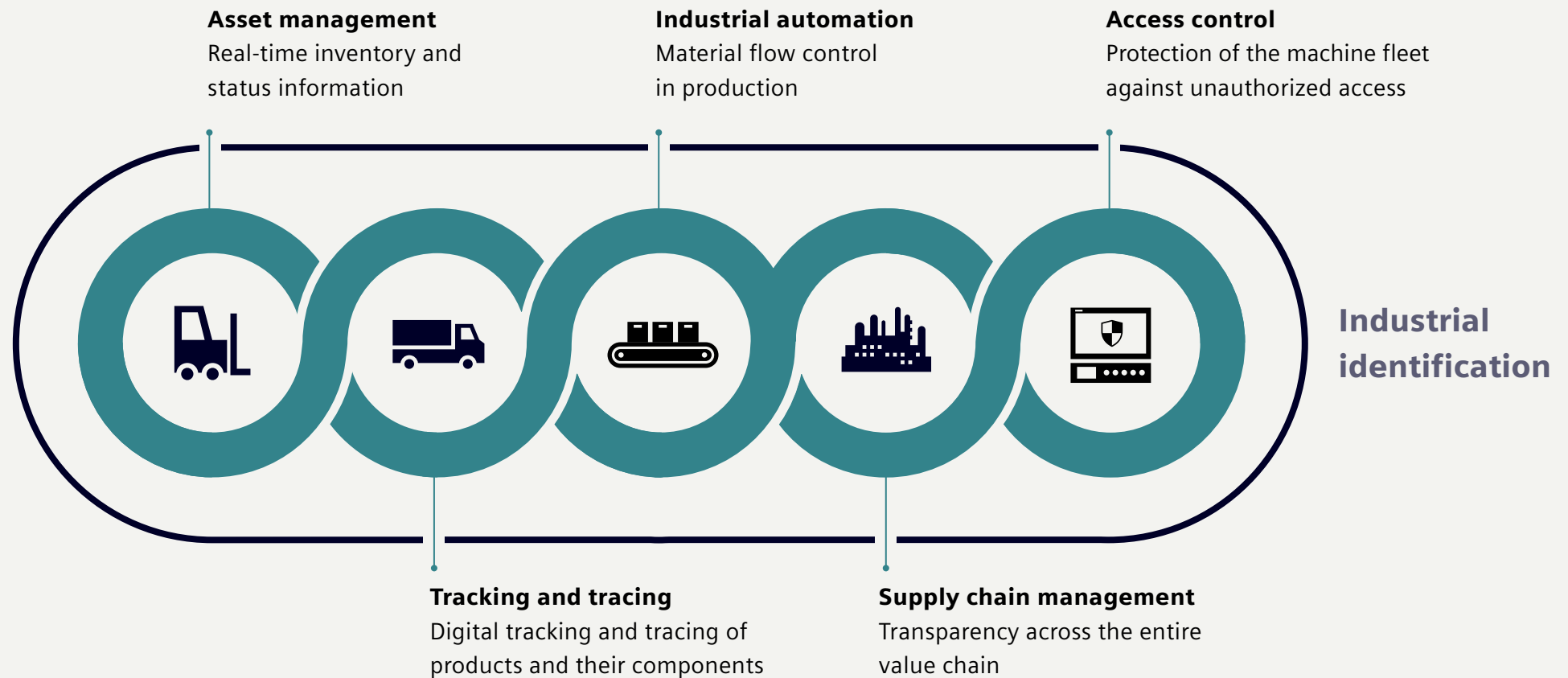

Basic characteristics of RFID technology

Each SIMATIC Ident RFID family has characteristics that are designed for a specific application area. The following graphics provide an overview of which reader and transponder combinations are recommended for which area of application.

Technology

As part of our extensive SIMATIC RF portfolio, we offer you systems for the HF and UHF range.

SIMATIC RF1000
125 kHz + 13.56 MHz
SIMATIC RF200/RF300
13.56 MHz
SIMATIC RF600
868/915 MHz

Range

The distance between the reader and transponder must be taken into account when selecting the RFID system.

System	Range (mm)
SIMATIC RF1000	30
SIMATIC RF200	650
SIMATIC RF300	230
SIMATIC RF600	8000

Storage capacity

Storage capacity refers to how much data can be stored on a transponder.

System	Storage Capacity
SIMATIC RF600	256 B
SIMATIC RF200	8 kB
SIMATIC RF300	64 kB

Basic characteristics of RFID technology

Attachment to metal

To select the right RFID solution, it's important to know how the reader and transponder will be attached to metal.

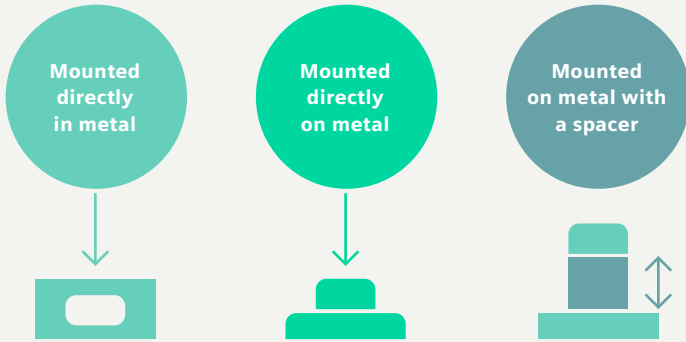

- Mounted directly in metal
- Mounted directly on metal
- Mounted on metal with a spacer

Environment

The specific environmental conditions vary as widely as the applications themselves.

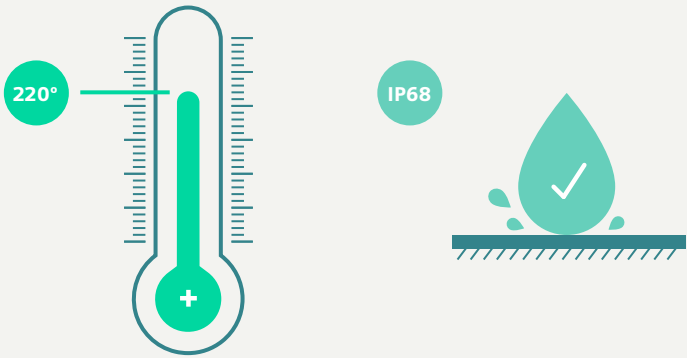

- 220°
- IP68

Read / write speed

The speed at which the transponder moves through the radio field also needs to be taken into account.



SIMATIC RF200 / 1000

SIMATIC RF300 / 600

Multitag / bulk capability

Selecting the optimal RFID system also depends on the number of transponders that occupy the radio field at one time.

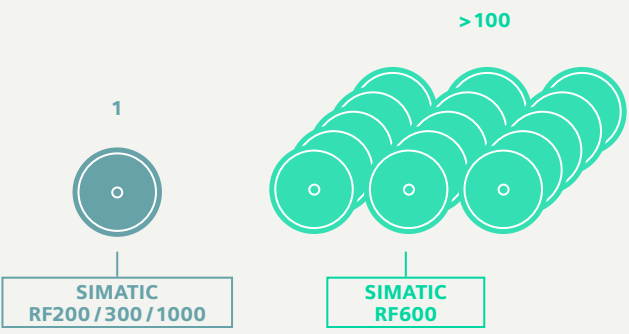

- 1
- >100

SIMATIC RF200 / 300 / 1000

SIMATIC RF600

Seamless transparency in a wide range of applications

Discover how you can perfectly control and continuously optimize your material flow with SIMATIC Ident. The following use cases illustrate typical areas of application.

USE CASES

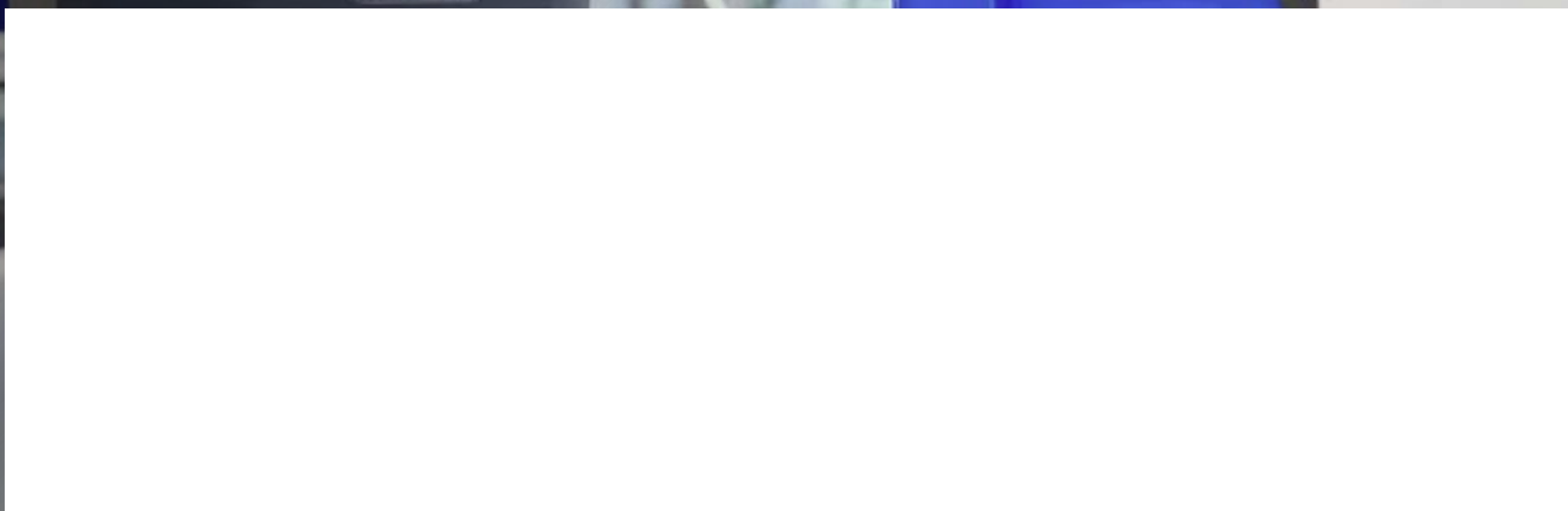

Reliable identification in harsh environments

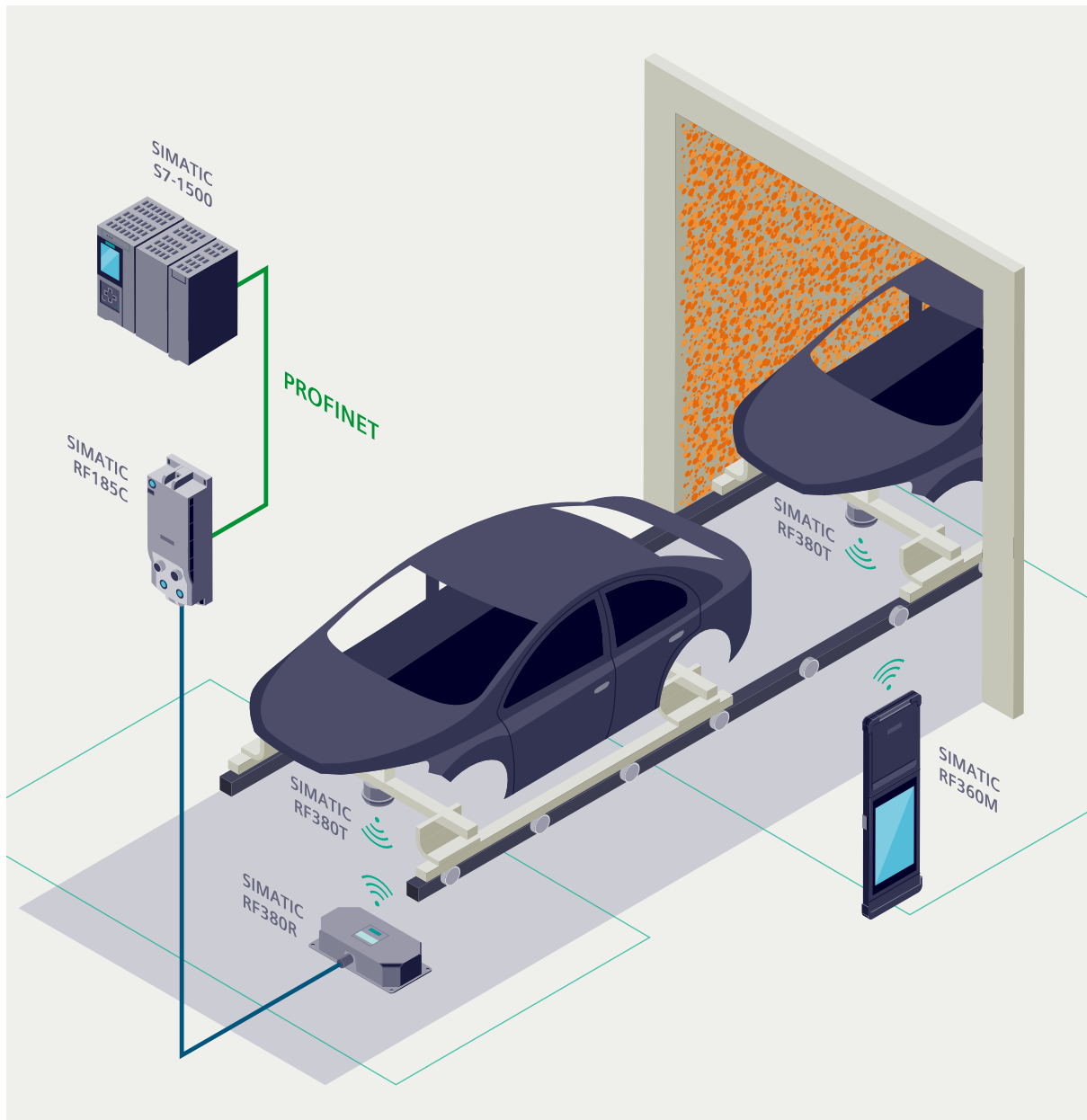

Task

Unambiguous identification of skids and car bodies for order-specific color selection and application under extremely challenging environmental conditions, such as the use of chemicals and drying processes at temperatures of up to 220 °C.

Solution

The SIMATIC RF380R reader mounted on the plant floor reads / writes the production data stored on the SIMATIC RF380T transponder. For maintenance purposes, this data can also be read using the SIMATIC RF360M mobile handheld reader.

Benefits

- Reliable identification even in harsh environments
- High security of investment thanks to durable and robust components
- Greater quality / productivity thanks to continuous identification at every workstation
- High plant safety thanks to Ex-certified components
- Distributed data storage thanks to the high storage capacity of transponders

Click the icons for more information

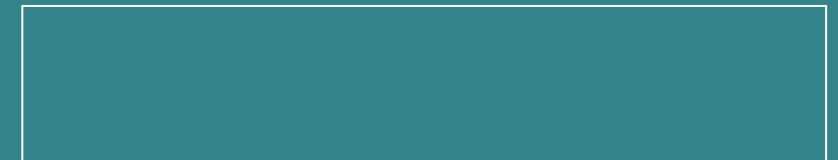

Secure access control for machines and plants

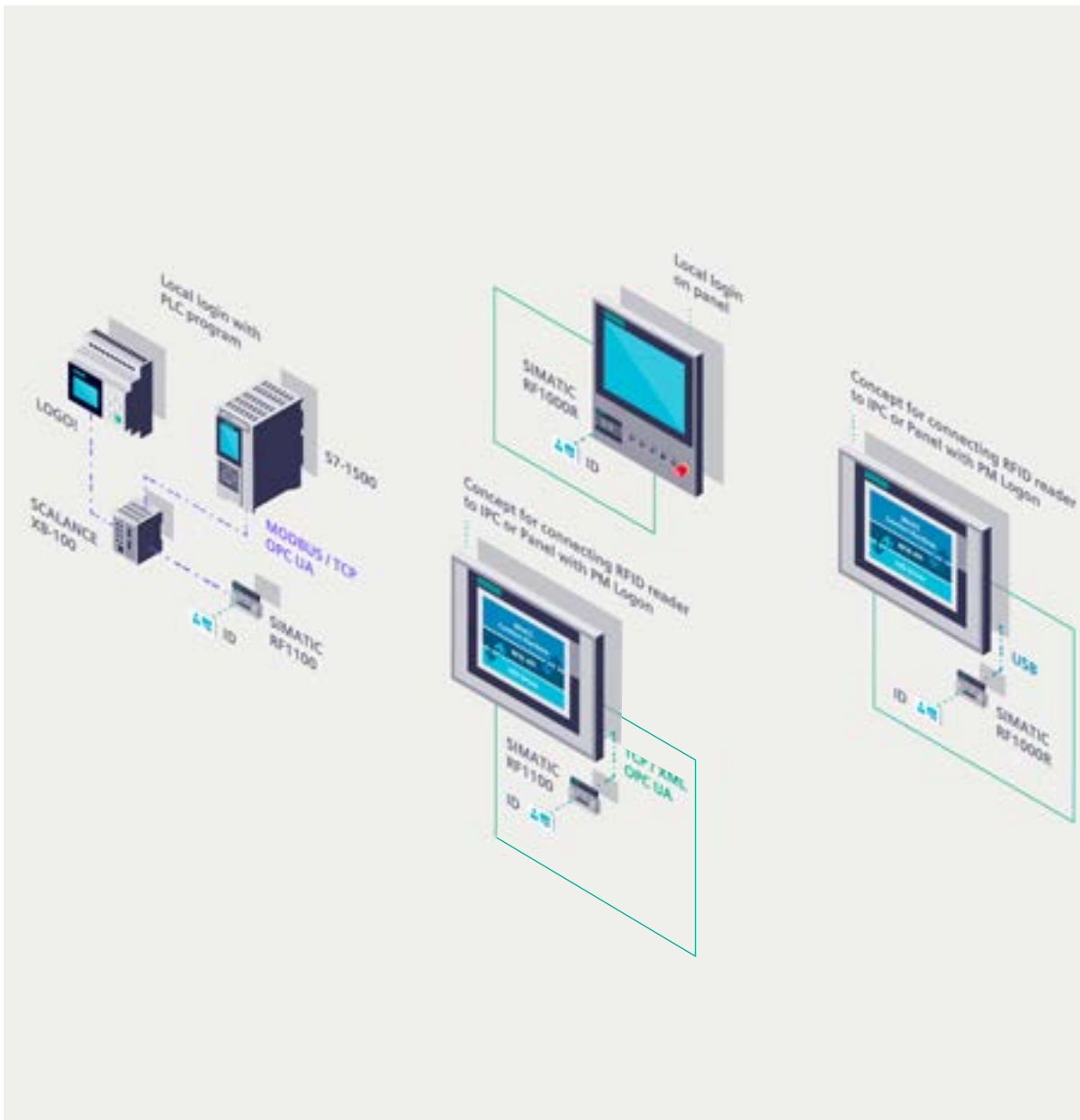

Task

Unambiguous identification of operators at machines and plants for controlling access and establishing an audit trail.

Solution

Based on existing employee IDs, readers in the SIMATIC RF1000 series permit simple and flexible implementation of electronic access control and management. This increases user-friendliness and reduces costs.

Benefits

- Maximum process reliability and efficiency
- Enhanced process security and transparency
- Easy integration in existing hardware (HMI devices, IPCs, and panels)
- Prevention of operating errors thanks to secure and documented access
- Individualized, central assignment of user authorizations
- Traceability of parameter changes
- Generation of customer-specific reader configurations

Click the icons for more information

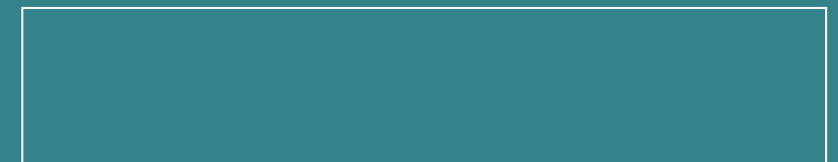

Individualized access to e-car charging stations

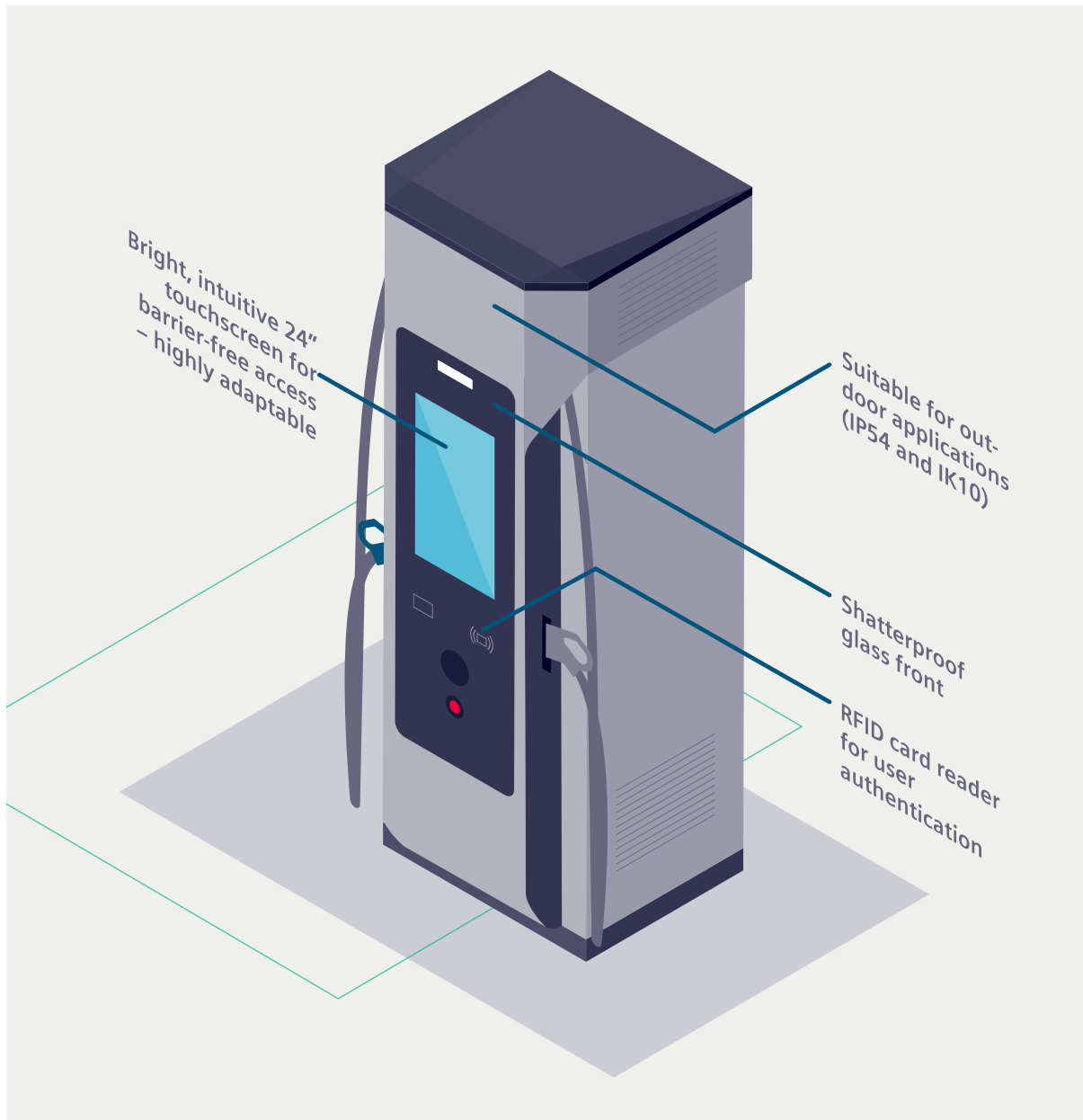

Task

Reliable authentication of e-car users at charging stations.

Solution

The robust SIMATIC RF1000 reader enables simple and reliable user identification. The system can be used for logging the user in at a charging station.

Benefits

- Extreme reliability
- Storage of encrypted information on the card
- High data transfer rates

Click the icons for more information



Identification of load carriers in production

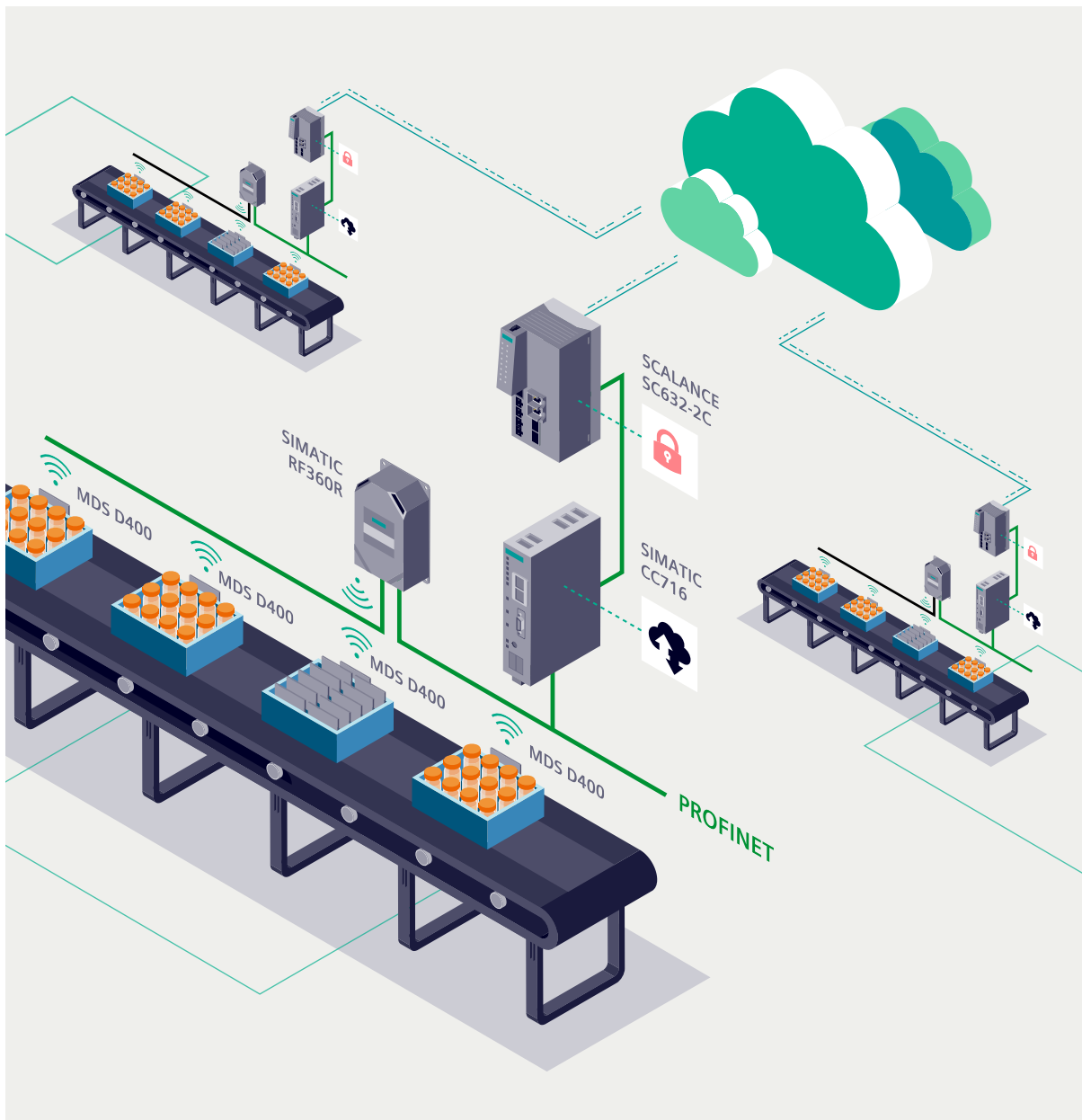

Task

Track production and logistics processes when manufacturing valuable products in order to prevent counterfeits and recalls as well as distribution and process errors.

Solution

Installation of SIMATIC RF360R readers at all production and transfer locations and MDS D400 transponders on load carriers. This makes it possible to seamlessly track and document each individual product during production and after logistics processes.

Benefits

- Possibility of unambiguous traceability
- Faster processing at each production location when implementing the serialization project
- Prevents the sale of counterfeit products via the supply chain (piracy protection)

Click the icons for more information



Positioning of Automated Guided Vehicles

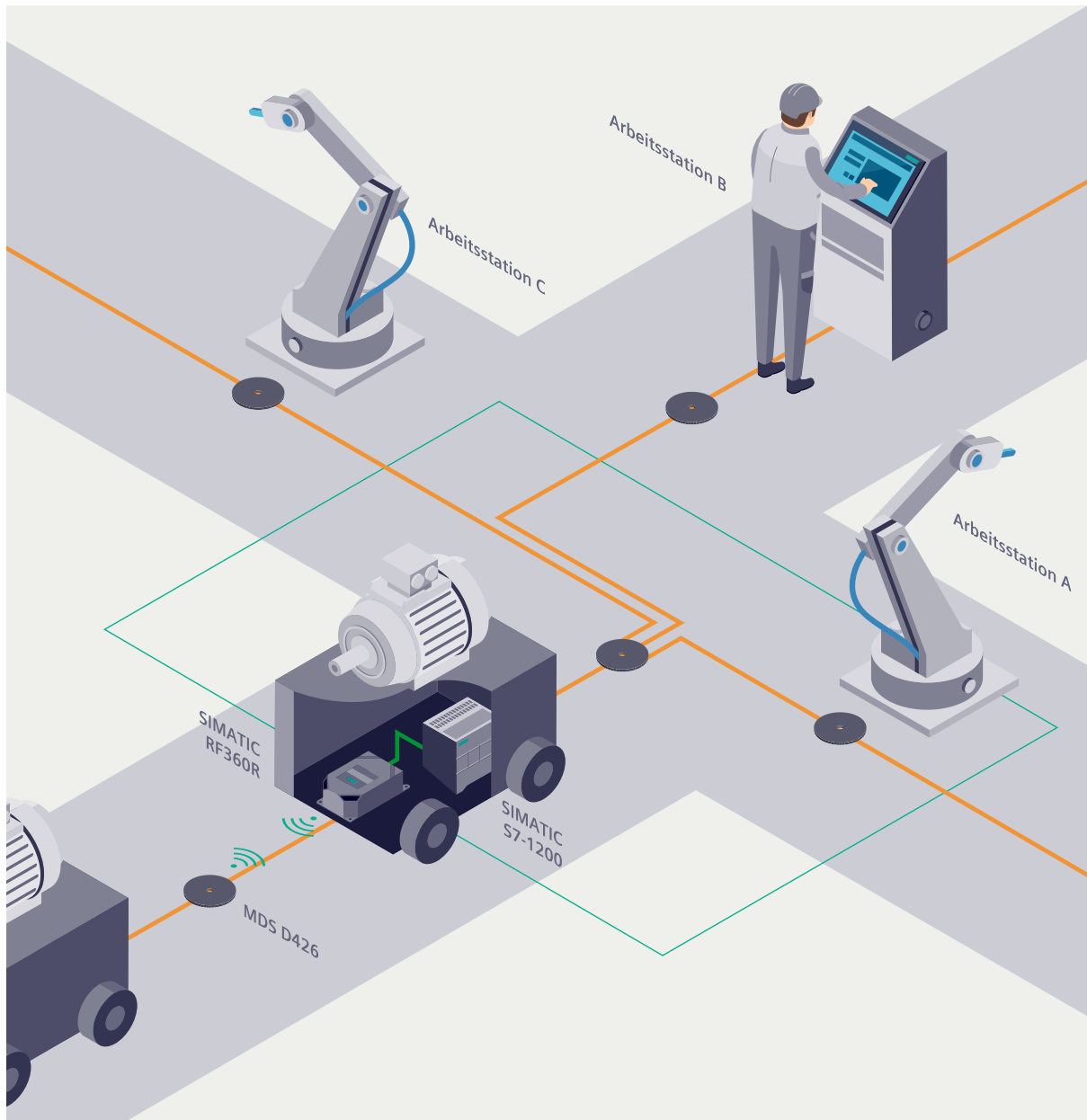

Task

As a megatrend, customization is responsible for highly dynamic markets worldwide. Flexibility is becoming a key success factor in many industries. As a result, Automated Guided Vehicles (AGVs) are becoming more and more important as mobile workpiece carriers.

Solution

A SIMATIC RF360R reader is attached to the underbody of the AGV and MDS D426 transponders are integrated in the hall floor along its route. When the AGV drives over these transponders, the AGV's controller detects its current position.

Benefits

- Simple implementation of automatic positioning
- Cost-effective design thanks to the use of only two different components
- Integration of a reader even in the limited space on an AGV

Click the icons for more information



Electric motor production in the automotive industry

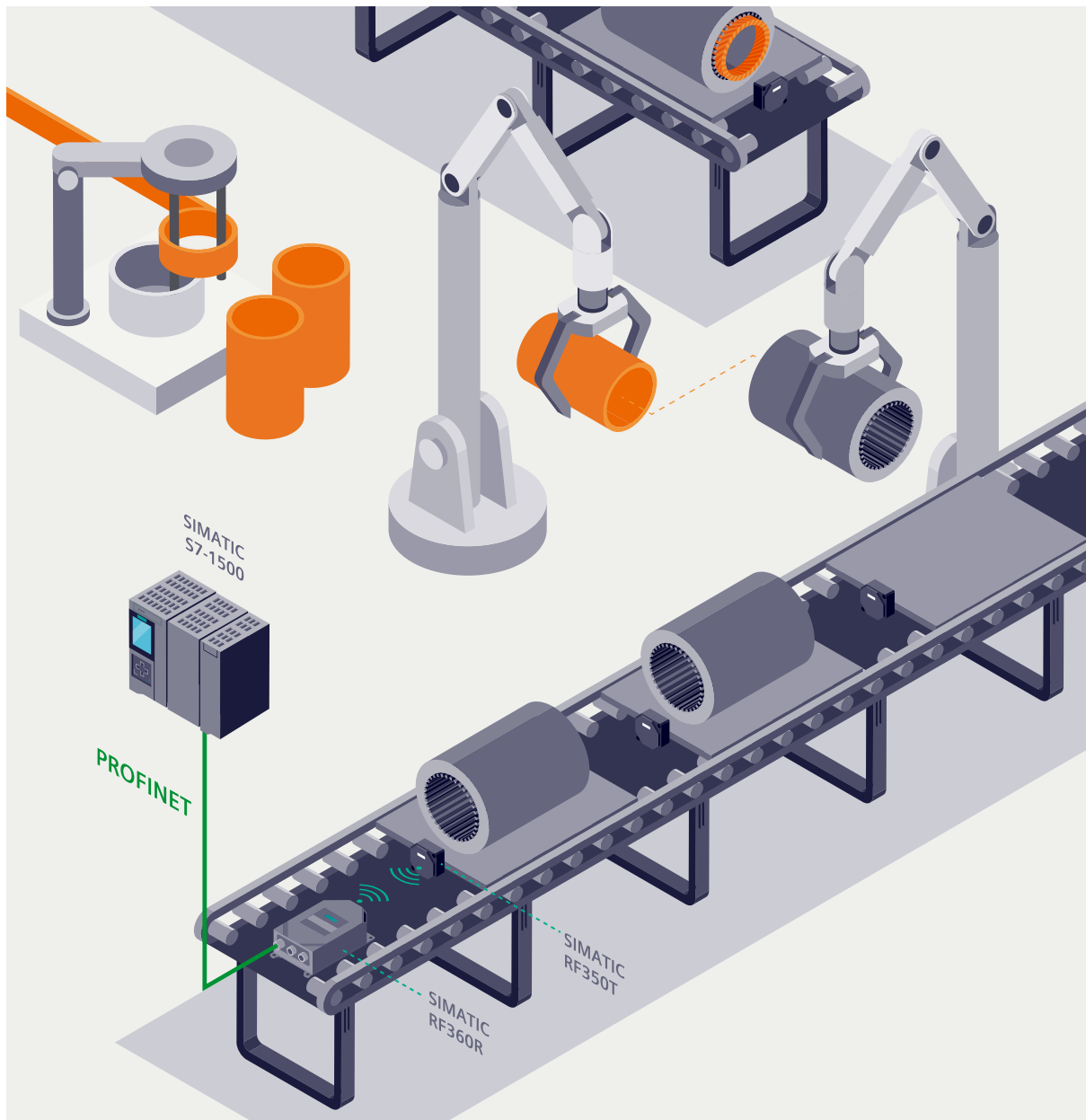

Task

The global trend toward electromobility requires fast, efficient and flexible manufacturing of electric motors. In the process, the traceability of quality-related materials and components must be guaranteed.

Solution

In motor production, every workpiece carrier is fitted with a SIMATIC RF350T transponder on which all the production-related information is stored. With the aid of the SIMATIC RF360R reader, this data is read and written at the workstations.

Benefits

- More flexible production thanks to the high-performance SIMATIC RF300 RFID system
- Space-saving and cost-efficient combination of the features of a communication module and reader in one device, the SIMATIC RF360R

Click the icons for more information

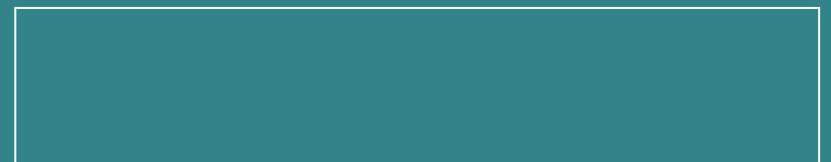

Process control in industrial production

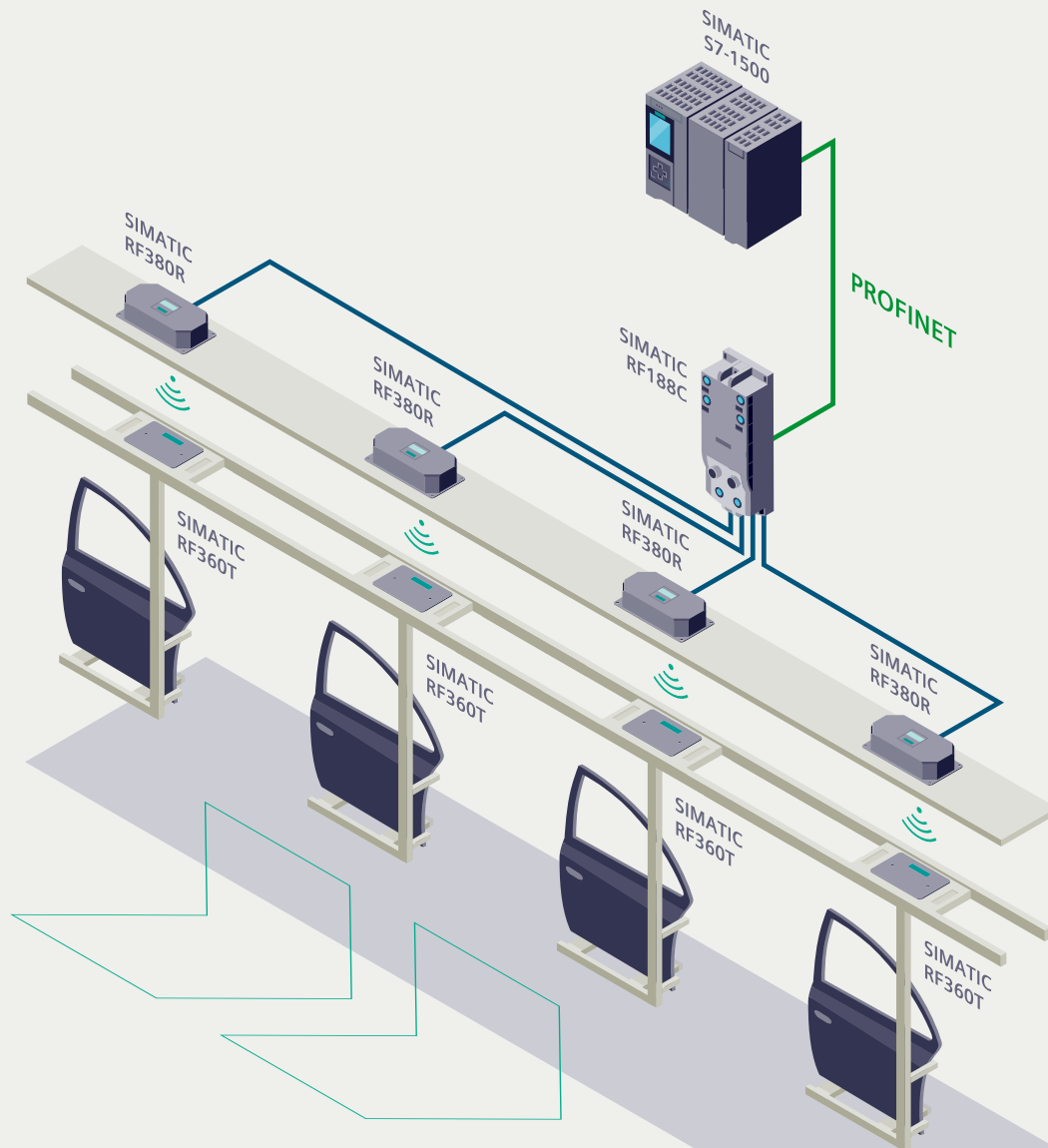

Task

To enable the strategic control of manufacturing processes, production and quality data from workpieces on electric monorail systems has to be automatically identified and assigned.

Solution

Each carrier is fitted with a SIMATIC RF360T transponder storing the data necessary for production that is read and modified by a reader such as the SIMATIC RF380R. In this way, the SIMATIC RF300 RFID system enables fast and reliable identification.

Benefits

- High conveyor speed thanks to extremely high data transfer rates
- Dynamic reading / writing without stopping the conveyor system
- Seamless integration in automation environments because SIMATIC RF300 is an integral part of Totally Integrated Automation (TIA Portal)

Click the icons for more information



Monitoring of internal logistics processes

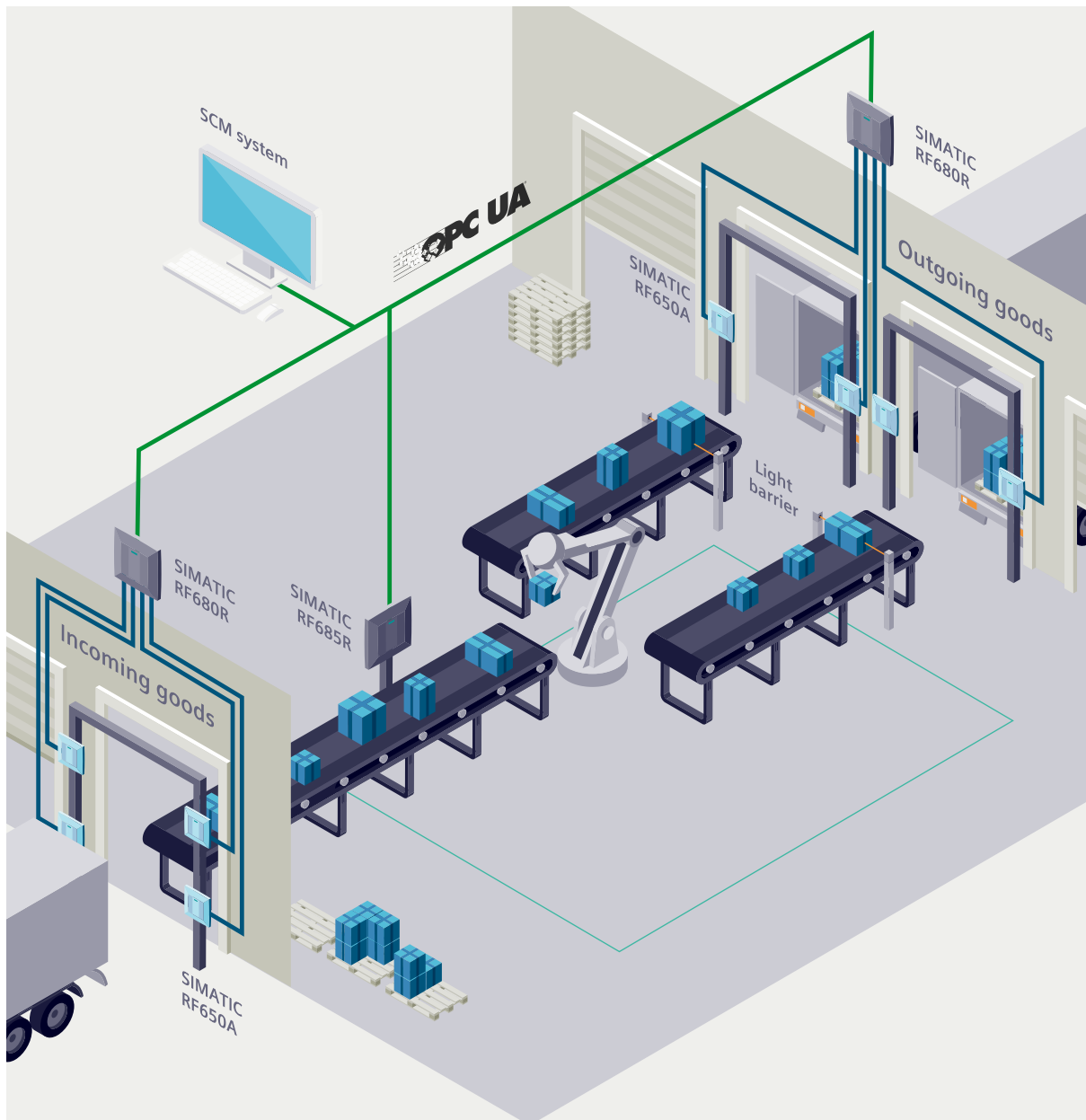

Task

The position and path of parts and product components must be monitored. This applies to incoming goods, outgoing goods, and distribution of goods.

Solution

A SIMATIC RF680R reader monitors incoming goods, reads sender data from the transponder, and communicates this data to the higher-level system. The packages are removed from the pallets, order-picked, and furnished with new transponders on which the receiver data is stored. After the packages have been checked, either the outgoing gate at outgoing goods opens - or an alarm is issued.

Benefits

- A high level of automation saves time, prevents errors, and thereby increases throughput
- The OPC UA interface integrated in the reader permits standardized communication with higher-level systems and reduces integration effort
- Combination of multiple read points in one reader saves money

Click the icons for more information



Cloud-based monitoring of logistics chains

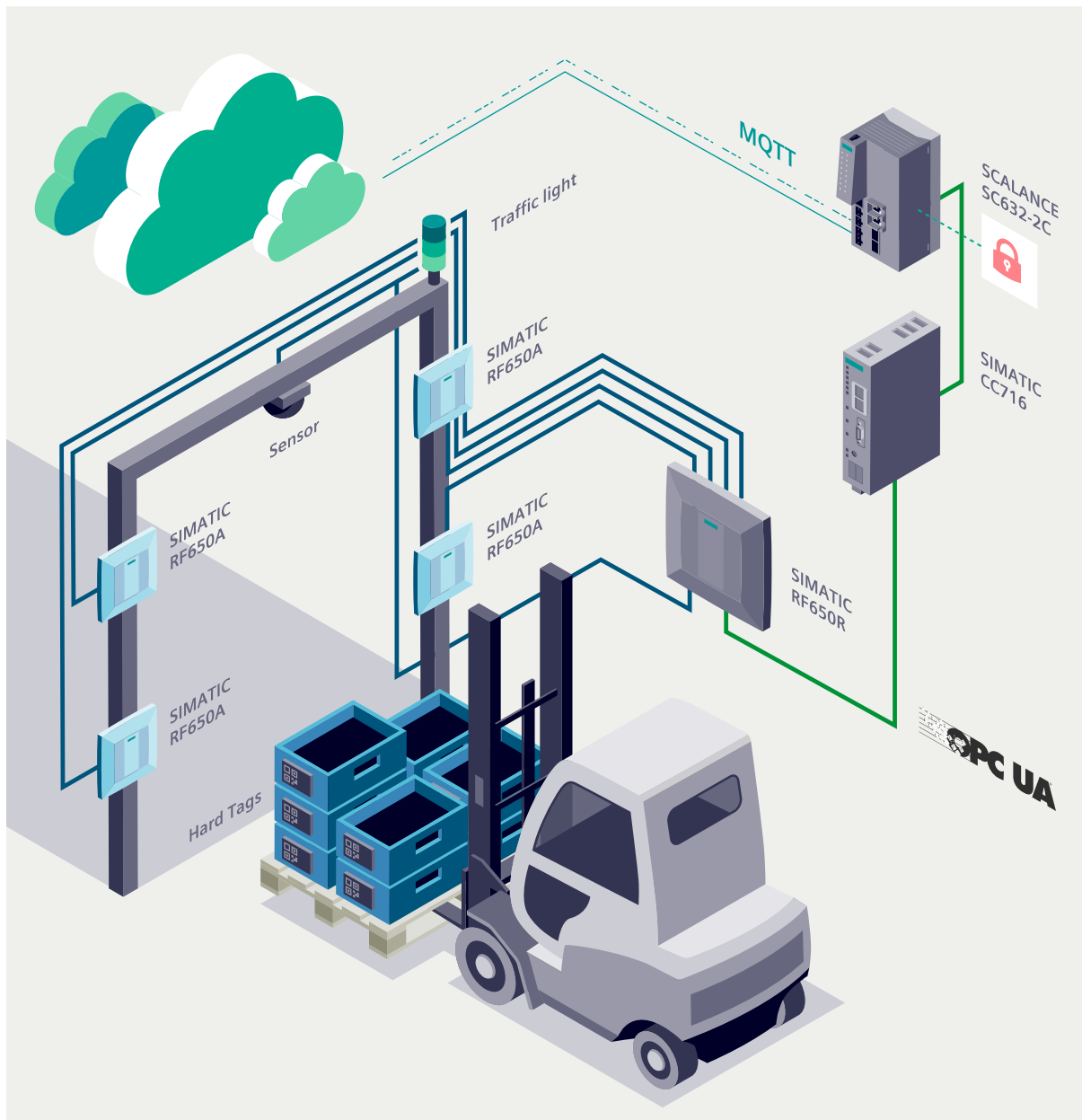

Task

The current position and path of goods must be tracked via an automated, cross-location tracking and tracing system.

Solution

A SIMATIC RF650R reader and four SIMATIC RF650A antennas are mounted on a gate. The process of reading the transponders on the goods is started and stopped via the sensors. A (traffic light) signal displays red for errors and green if passage and loading are permitted. The system forwards the data acquired to the cloud platform.

Benefits

- Transparency of material flow
- Prevention of errors thanks to a high level of automation
- Worldwide availability of data that is always up to date, including across company boundaries

Click the icons for more information

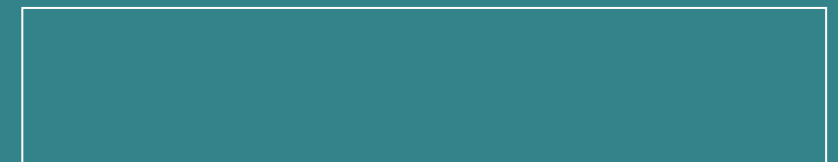

Tracking & tracing objects on conveyors

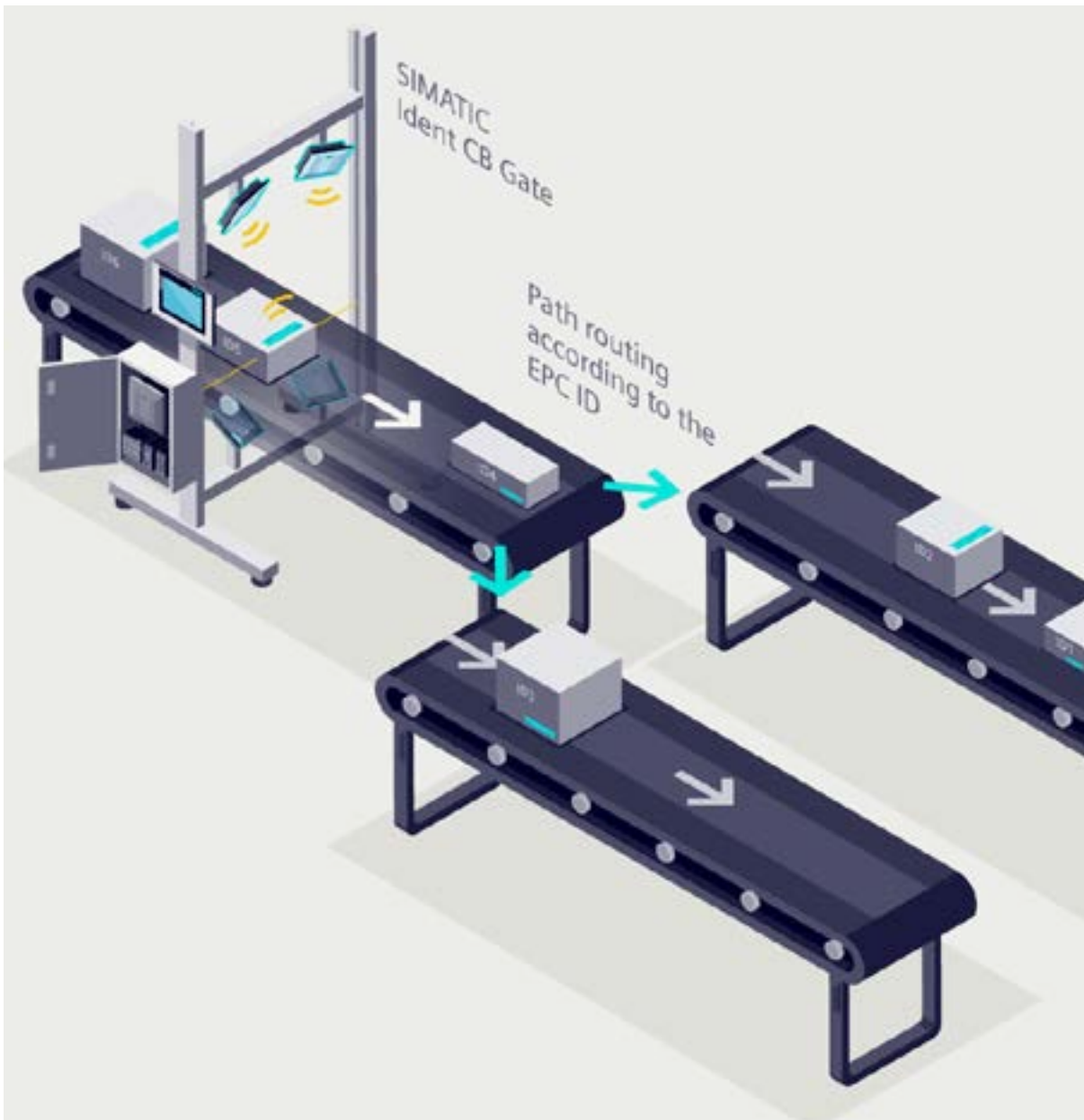

Task

Transport of objects (e.g., transport containers, workpiece carriers) and identification on a conveyor belt. After the identification, it can be decided which further way the object should go in the process.

Solution

The SIMATIC IDENT CB Gate system has everything on board that is necessary to fulfill identification tasks. The four antennas ensure a reliable reading on both sides. The object reading is triggered by a photoelectric barrier. The connection to an upper-layer system from the PLC can be modified.

Benefits

- One full functional system, right out of the box
- Save time, prevent errors and increase throughput with an ingenious path-routing and sorting system
- Simple integration and communication with TCP/IP connection
- Local processing of trigger signals and reading events by digital IOs

Click the icons for more information



Code reading at the conveyor belt

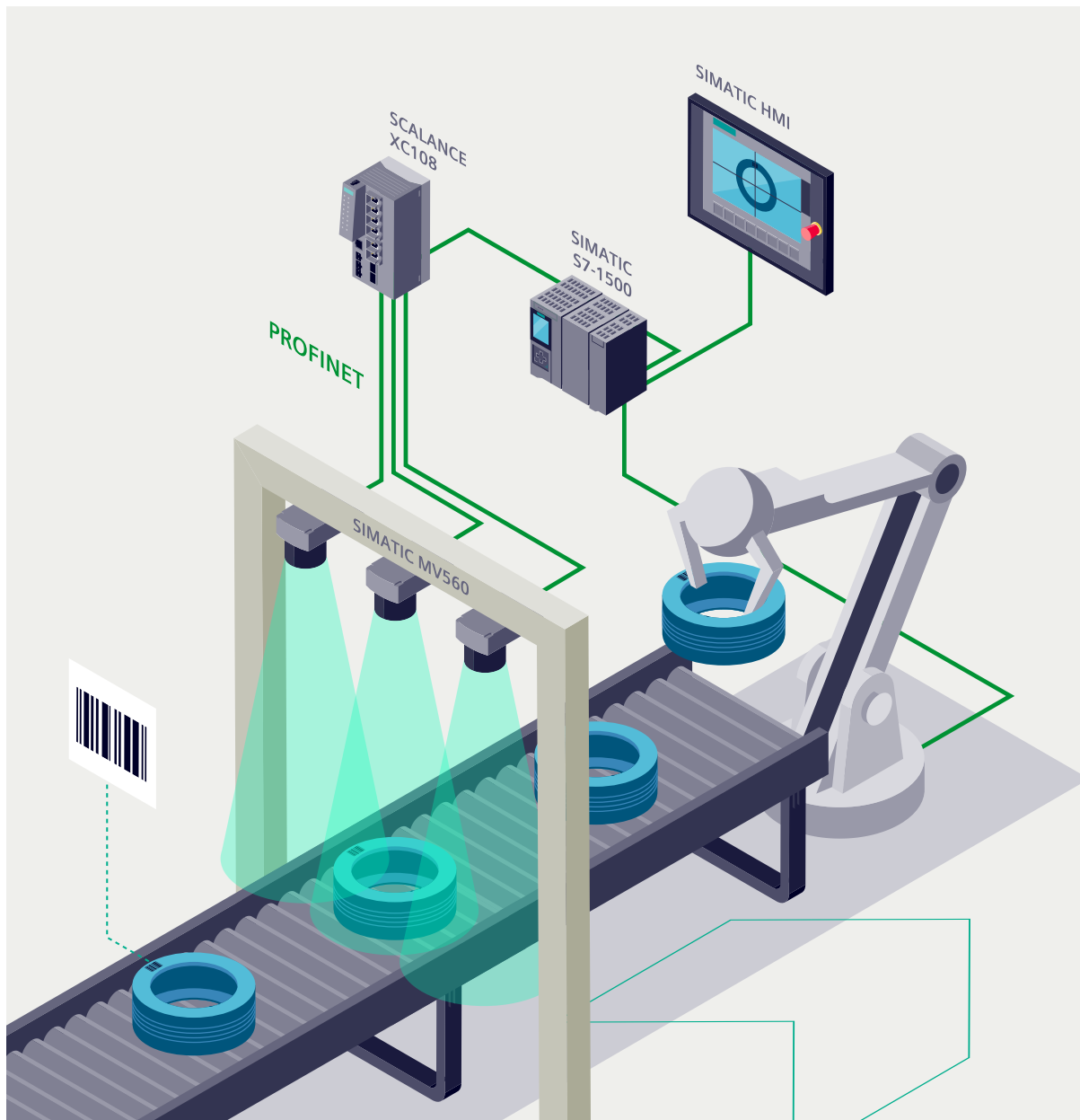

Task

When producing industrial goods, identifying a product ID by reading a barcode is essential. Large image fields (approx. 1 x 1 m) and high product frequencies (0.5 Hz) must be taken into account.

Solution

The SIMATIC MV500 optical reader provides users with powerful lighting technology and processing power so that they can reliably read barcodes, even in challenging situations and in different rotational positions.

Benefits

- Maximum functional safety thanks to industry-compliant components
- Extremely easy maintenance and excellent remote support
- Security of investment thanks to standard components
- Global rollout (service / certificates)

Click the icons for more information

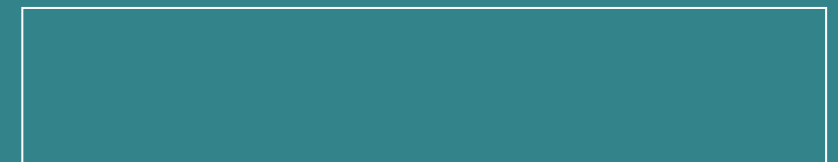

Position detection for interaction between components and robots

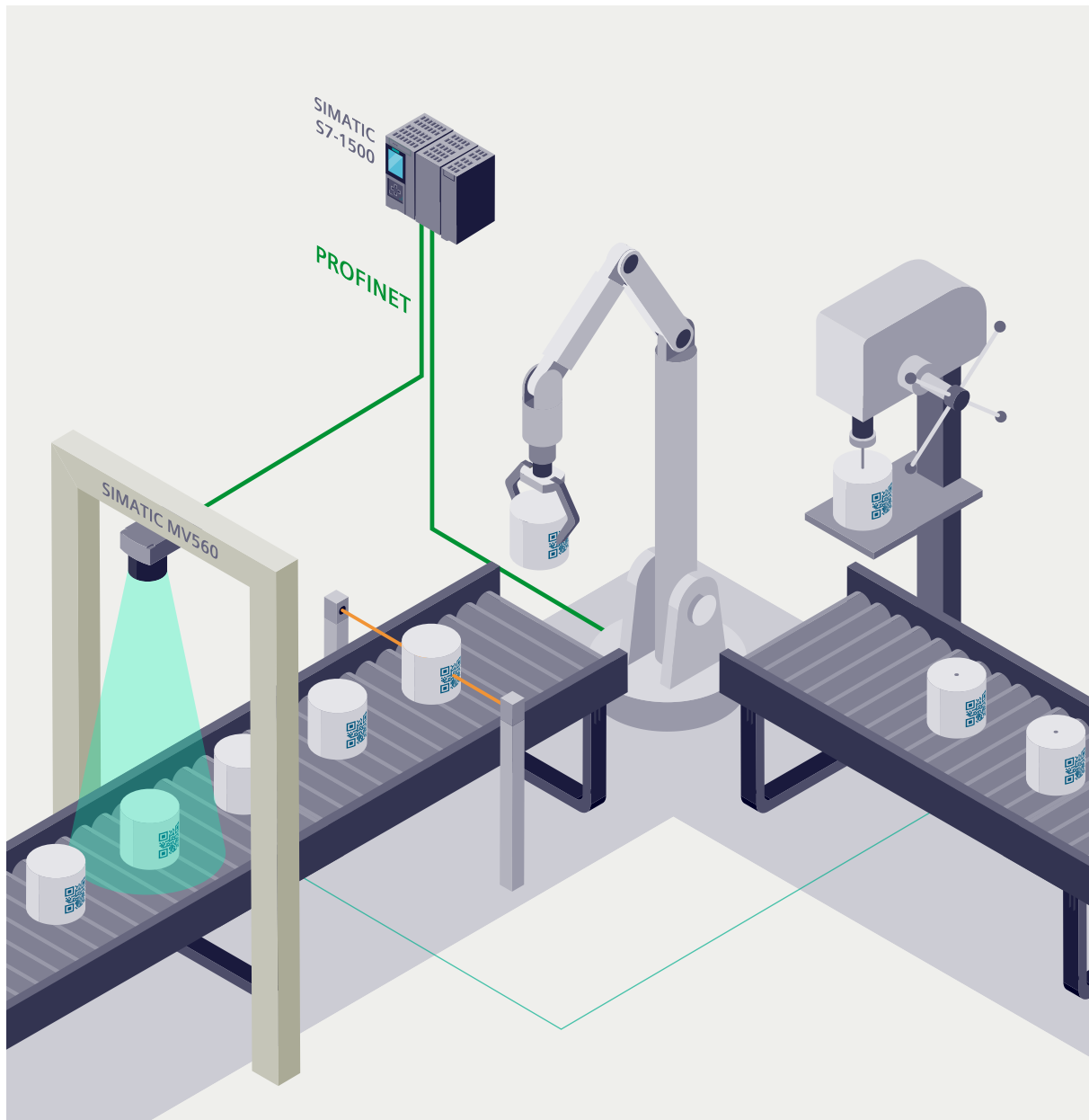

Task

To correctly pick and place product blanks in automation, robots have to detect their position. To do so, they must be able to read the workpiece ID.

Solution

SIMATIC MV500 detects the location and shape of the workpiece and communicates the position of correct workpieces, including the workpiece ID, to the robot so that the workpieces can be transported to their processing position. Defective parts are also detected and ejected before further processing.

Benefits

- Camera has large image field to cover a large range
- High processing speed
- SINUMERIK connection available as a sample application
- Easy configuration thanks to web-based management

Click the icons for more information

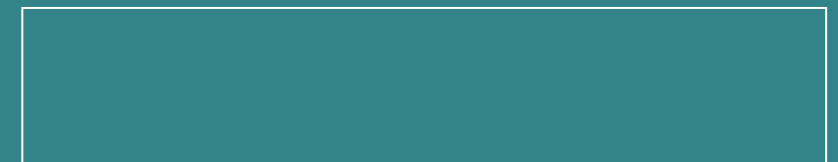

Quality control using optical identification

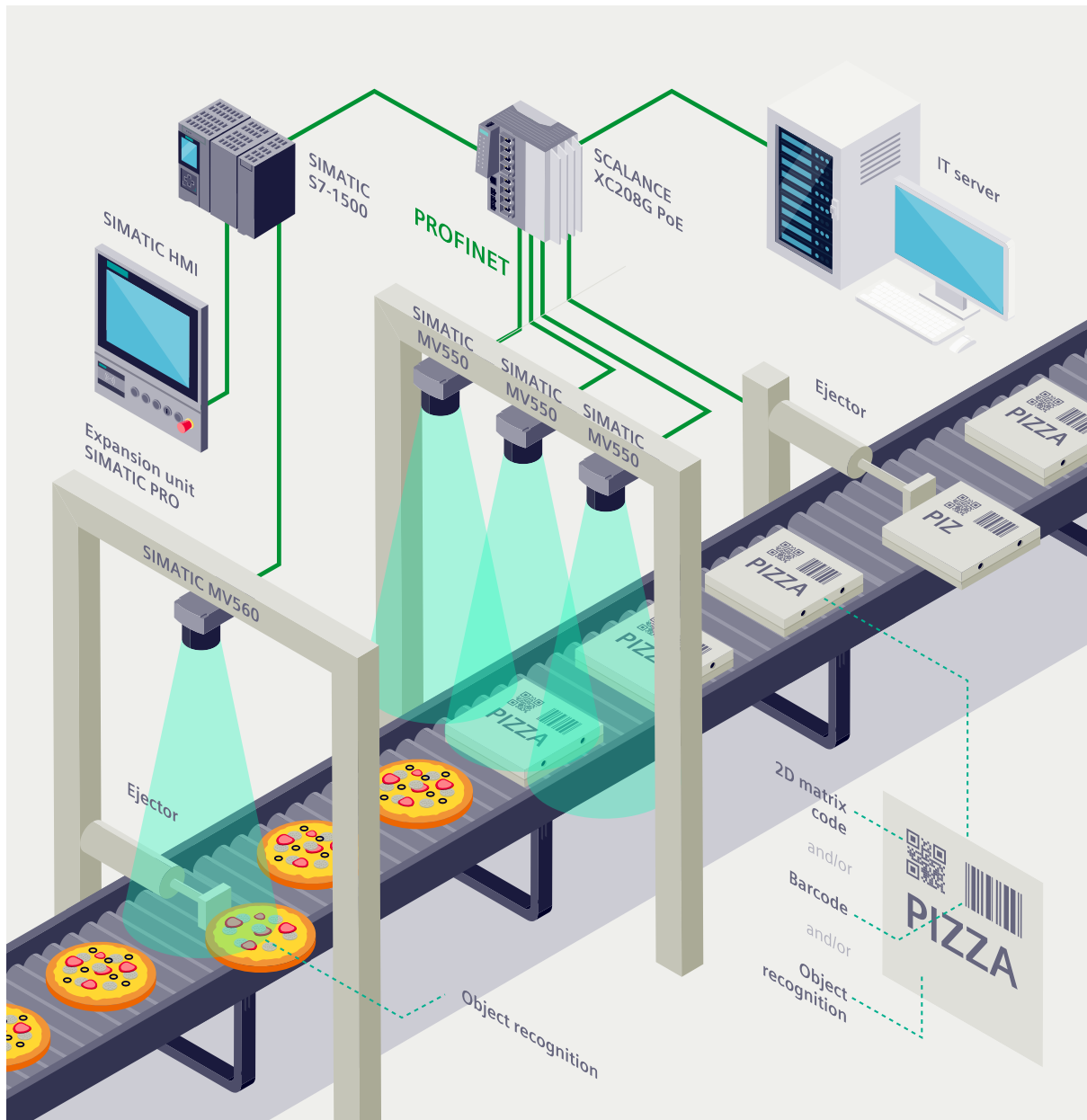

Task

Reliable optical identification systems permit food, food packaging, and labels to be unambiguously checked.

Solution

At the first inspection station, the food's production quality is checked. For this purpose, the SIMATIC MV560 optical reading system – which has a sufficiently large image field – is mounted on a gate. The second gate monitors the packaging for damage and labeling. Because this requires a higher resolution, multiple SIMATIC MV550 readers operate in parallel.

Benefits

- Reliable identification of production errors prevents costly product recalls and safeguards the brand's reputation
- Graphical documentation of all quality issues thanks to the separate Gigabit Ethernet interface
- Comprehensive solution from a single source

Click the icons for more information

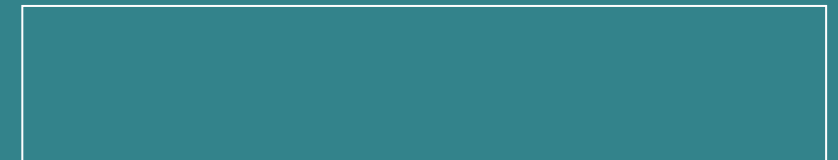

Starting point for your digital transformation

No matter what you want to identify, our broad range of reliable and industry-compliant SIMATIC Ident components can be used to implement almost any application, from the field level to the cloud. Select the right identification system and associated integration components for your project.

SELECTION CRITERIA

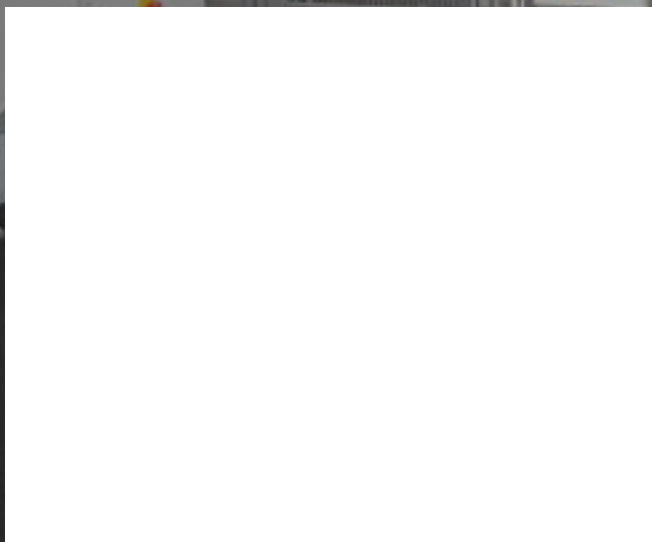

On the fast track to your optimal RFID system

All RFID systems are not alike. When selecting the solution that's right for you, many aspects have to be taken into account – such as read range, memory size, and transponder costs. Or maybe you need SmartLabels on rolls for your printer. This is why our RFID portfolio includes different product families and technologies, so you're sure to find the system that's right for you.



SELECTION CRITERIA

RFID



SIMATIC RF200 overview

Works quickly and flexibly and is especially cost-efficient.



SIMATIC RF200 is the economical solution for identification tasks of medium performance in the HF range, and is suitable for use in industrial production in small assembly lines or intralogistics. Thanks to their compact design, these RFID system readers can be optimally installed even in confined spaces. Readers with an IO-Link interface are available for especially simple and open identification solutions.

Your benefits at a glance:

- Seamless integration in the TIA automation environment: function blocks available, cost-efficient installation, faster commissioning, simple parameterization thanks to technology objects
- Communication and integration: connection to almost any system via standards (industrial buses, IO-Link, RS232)
- Comprehensive transponder portfolio: open standard, flexibly usable worldwide for any application

Get to know the members of the product family

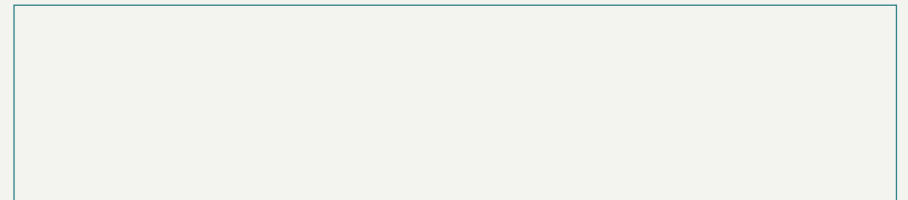

SIMATIC RF200: readers

Rely on a tireless workhorse for your RFID tasks.



SIMATIC RF210R

M18 reader; extremely compact; ideal for use on small assembly lines; also available with standardized IO-Link interface.



SIMATIC RF220R

Compact M30 reader – ideal for small assembly lines with a slightly higher range and field size; also available with standardized IO-Link interface.



SIMATIC RF240R

Especially compact reader with a high degree of protection and a robust design; also available with standardized IO-Link or RS232 interface (ASCII protocol and scan mode).



SIMATIC RF250R

Reader for operation with external antennas of various designs with many potential applications; also available with IO-Link or RS232 interface (ASCII protocol and scan mode).



SIMATIC RF260R

Compact reader with a high degree of protection and a robust design for the harshest conditions; also available with standardized IO-Link or RS232 interface (ASCII protocol and scan mode).



SIMATIC RF280R

Ideal reader for use in assembly lines with a longer range and dynamic applications; also available with RS232 interface (ASCII protocol and scan mode).

SIMATIC RF200: readers

Rely on a tireless workhorse for your RFID tasks.



SIMATIC RF290R

Very high-performance long-range reader (up to 60 cm) – ideal for use in production control and intralogistics; for operation with external antennas of various designs.



SIMATIC RF210M

Mobile cabled handheld reader with integrated RF210R M18 reader – including for manual and reworking stations.



SIMATIC RF360M

High-performance mobile handheld terminal for applications in production logistics, distribution, and service; available in two versions: with integrated antenna and for external antennas.

SIMATIC RF200: antennas

Refuse to compromise when it comes to reliable data transmission.



ANT 1 for
SIMATIC RF250R

Universally usable flat antenna; also for dynamic applications; dimensions 75 x 75 x 20 mm (L x W x H).



ANT 3 for
SIMATIC RF250R

Flat, compact antenna, can be very precisely positioned even in cramped conditions; dimensions 50 x 28 x 10 mm (L x W x H).



ANT 8 for
SIMATIC RF250

Cylindrical antenna, permits highly precise positioning thanks to its extremely small design; primarily used for tool identification using the small MDS D117, D127, D421, and D521 transponders; dimensions M8 x 38 mm (Ø x L).



ANT 12 for
SIMATIC RF250

Cylindrical antenna; primarily used for tool identification; dimensions M12 x 40 mm (Ø x L).



ANT 18 for
SIMATIC RF250

Cylindrical antenna; primarily used for small assembly lines and tool identification; dimensions M18 x 40 mm (Ø x L).



ANT 30 for
SIMATIC RF250R

Cylindrical antenna; primarily used for assembly lines and tool identification; dimensions M30 x 40 mm (Ø x L).

SIMATIC RF200: antennas

Refuse to compromise when it comes to reliable data transmission.



ANT D5 for
SIMATIC RF290R

Universally usable antenna for warehouses, logistics, and distribution; also for dynamic applications; dimensions 380x380x110 mm (WxHxD).



ANT D6 for
SIMATIC RF290R

Universally usable antenna for warehouses, logistics, and distribution; dimensions 480x580x110 mm (WxHxD).



ANT 10 for
SIMATIC RF290R

Universally usable antenna for warehouses, logistics, and distribution; dimensions 365x1150x115 mm (WxHxD).

SIMATIC RF200: transponders

Proving themselves daily in countless applications worldwide.

Transponder categories

Our RF200 transponders are available for the following use cases:



Standard



Logistics



SmartCard



Heat resistant



On metal



In metal



Special applications



MDS D100

85 x 54 x 0.8 mm (L x W x H), ISO 15693, frequency 13.56 MHz, NXP ICODE SLI, 112-byte user memory, printable on both sides, up to +80 °C, IP68, 650 mm range.



MDS D117

4 x 5 mm (Ø x H), ISO 15693, frequency 13.56 MHz, NXP ICODE SLI, 112-byte user memory, non-printable, adhesive, up to +125 °C, IP68, 4 mm range.



MDS D124

27 x 4 mm (Ø x H), ISO 15693, frequency 13.56 MHz, NXP ICODE SLI, 112-byte user memory, non-printable, heat-resistant up to +180 °C, IP68, 300 mm range.



MDS D126

50 x 3.6 mm (Ø x H), ISO 15693, frequency 13.56 MHz, NXP ICODE SLI, 112-byte user memory, non-printable, up to +100 °C, IP68, 500 mm range.



MDS D127

6 x 6 mm (Ø x H), ISO 15693, frequency 13.56 MHz, NXP ICODE SLI, 112-byte user memory, non-printable, in metal, up to +125 °C, IP68, 5 mm range.

SIMATIC RF200: transponders

Proving themselves daily in countless applications worldwide.



MDS D139

85 x 15 mm (Ø x H), ISO 15693, frequency 13.56 MHz, NXP ICODE SLI, user memory 112-bytes / 896-bits, screw-on, non-printable, -40 to +220 °C cyclic, IP68, 600 mm range, ATEX II.



MDS D160

16 x 3 mm (Ø x H), ISO 15693, frequency 13.56 MHz, NXP ICODE SLI, 112-byte user memory, non-printable, heat-resistant up to +175 °C, IP68, 180 mm range.



MDS D200

86 x 54 x 0.8 mm (L x W x H), ISO 15693, frequency 13.56 MHz, TI TAGIT HFI, 256-byte user memory, printable on both sides, adhesive, up to +60 °C, IP67, 600 mm range.



MDS D226S

30 x 3.2 mm (Ø x H), ISO 15693, frequency 13.56 MHz, NXP SLI-X2, 316-byte user memory, non-printable, up to +90 °C, IP68/IPX9K, 280 mm range.



MDS D324

27 x 4 mm (Ø x H), ISO 15693, frequency 13.56 MHz, INFINEON SRF 55V10P, 992-byte user memory, non-printable, M3 screw, adhesive, heat-resistant up to +140 °C, IP67, 280 mm range.



MDS D339

85 x 15 mm (Ø x H), ISO 15693, frequency 13.56 MHz, INFINEON SRF 55V10P, 992-byte user memory, non-printable, M5 screw, heat-resistant up to +220 °C, IP68, 480 mm range.

SIMATIC RF200: transponders

Proving themselves daily in countless applications worldwide.



MDS D400

85x54x0.8 mm (LxWxH), ISO 15693, frequency 13.56 MHz, FUJITSU MB89R118, 2000-byte FRAM user memory, adhesive, printable on both sides, up to +60 °C, IP67, 650 mm range.



MDS D421

10x4.5 mm (ØxH), ISO 15693, frequency 13.56 MHz, FUJITSU MB89R118, 2000-byte FRAM user memory, adhesive, non-printable, up to +100 °C, IP67, 8 mm range.



MDS D422

20x6 mm (ØxH), ISO 15693, frequency 13.56 MHz, FUJITSU MB89R118, 2000-byte FRAM user memory, thread M20x1, adhesive, non-printable, up to +100 °C, IP68, 19 mm range.



MDS D423

30x8 mm (ØxH), ISO 15693, frequency 13.56 MHz, FUJITSU MB89R118, 2000-byte FRAM user memory, M4 countersunk screw on metal, non-printable, up to +100 °C, IP68, 80 mm range.



MDS D424

27x4 mm (ØxH), ISO 15693, frequency 13.56 MHz, FUJITSU MB89R118, 2000-byte FRAM user memory, M3 screw, adhesive, non-printable, up to +100 °C, IP67, 300 mm range.



MDS D425

24x10 mm (ØxH), ISO 15693, frequency 13.56 MHz, FUJITSU MB89R118, 2000-byte FRAM user memory, screws (M6), non-printable, up to +125 °C, IP68, 45 mm range.

SIMATIC RF200: transponders

Proving themselves daily in countless applications worldwide.



MDS D426S

30x3 mm (ØxH), ISO 15693, frequency 13.56 MHz, FUJITSU MB89R118, 2000-byte FRAM user memory, screws (M4), non-printable, up to +90 °C, IP68/IPX9K, 280 mm range.



MDS D426

50x3.2 mm (ØxH), ISO 15693, frequency 13.56 MHz, FUJITSU MB89R118, 2000-byte FRAM user memory, screws (M4), non-printable, up to +100 °C, IP68, 400 mm range.



MDS D428

24x20 mm (ØxH), ISO 15693, frequency 13.56 MHz, FUJITSU MB89R118, 2000-byte FRAM user memory, screw-fit transponders M8 long, non-printable, up to +125 °C, IP68, 150 mm range.



MDS D460

16x3 mm (ØxH), ISO 15693, frequency 13.56 MHz, FUJITSU MB89R118, 2000-byte FRAM user memory, patch, adhesive, non-printable, up to +100 °C, IP67, 160 mm range.



MDS D521

10x4.5 mm (ØxH), ISO 15693, frequency 13.56 MHz, FUJITSU MB89R118, 8192-byte FRAM user memory, adhesive, non-printable, up to +100 °C, IP67, 5 mm range.



MDS D522

20x6 mm (ØxH), ISO 15693, frequency 13.56 MHz, FUJITSU MB89R118, 8192-byte FRAM user memory, thread M20 x 1, adhesive, non-printable, up to +100 °C, IP68, 35 mm range.

SIMATIC RF200: transponders

Proving themselves daily in countless applications worldwide.



MDS D524

27 x 4 mm (Ø x H), ISO 15693, frequency 13.56 MHz, FUJITSU MB89R118, 8192-byte FRAM user memory, M3 screw, adhesive, non-printable, up to +100 °C, IP67, 300 mm range.



MDS D525

24 x 10 mm (Ø x H), ISO 15693, frequency 13.56 MHz, FUJITSU MB89R118, 8192-byte FRAM user memory, screw-fit transponders M6 short, non-printable, up to +125 °C, IP68, 50 mm range.



MDS D526

50 x 3.2 mm (Ø x H), ISO 15693, frequency 13.56 MHz, FUJITSU MB89R118, 8192-byte FRAM user memory, M4 screw, non-printable, up to +100 °C, IP68, 400 mm range.



MDS D528

24 x 20 mm (Ø x H), ISO 15693, frequency 13.56 MHz, FUJITSU MB89R118, 8192-byte FRAM user memory, screw-fit transponders M8 long, non-printable, up to +125 °C, IP68, 80 mm range.



MDS D560

16 x 3 mm (Ø x H), ISO 15693, frequency 13.56 MHz, FUJITSU MB89R118, 8192-byte FRAM user memory, patch, adhesive, non-printable, up to +90 °C, IP68, 160 mm range.



MDS D165

86 x 54 x 0.3 mm (L x W x H), ISO 15693, frequency 13.56 MHz, NXP ICODE SLI, 112-byte user memory, printable, adhesive, up to +85 °C, IP65, 500 mm range.

SIMATIC RF200: transponders

Proving themselves daily in countless applications worldwide.



SIMATIC RF300 overview

Has a large user memory and transfers data in record time.



SIMATIC RF300 offers fast data transmission and a large data memory in a compact design, and is ideal for handling challenging applications in automation. The HF RFID system ensures seamless data transparency all the way to the cloud – a basic requirement for the perfect control and systematic optimization of your material flow.

Your benefits at a glance:

- High-end system: extremely fast data transmission, very high immunity to noise, and a large memory
- Seamless integration in the TIA automation environment: function blocks available, cost-efficient installation, faster commissioning, simple parameterization thanks to technology objects
- Versions with Ex approval for applications in Ex zones

Get to know the members of the product family

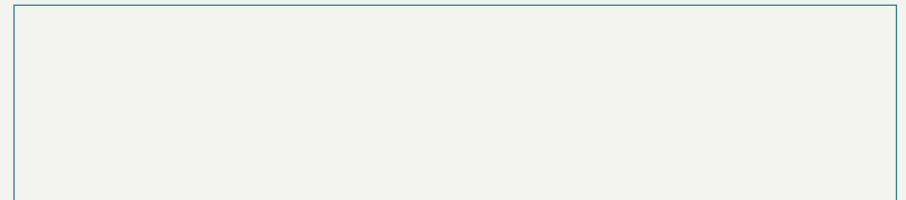

SIMATIC RF300: readers

Rely on extremely fast data transmission.



SIMATIC RF310R

Extremely compact reader; high degree of protection; ideal for small assembly lines; available with RS422 interface for the RFID communication modules and scan mode.



SIMATIC RF340R

Compact reader; high degree of protection; medium performance range; ideal for assembly lines and dynamic applications; with RS422 interface for the RFID communication modules.



SIMATIC RF350R

Universal reader; high degree of protection; for operation with external antennas; flexibly usable in industrial production; with RS422 interface for the RFID communication modules.



SIMATIC RF360R

High-performance compact reader with integrated interface connection; high degree of protection; simple parameterization thanks to integrated web server (WBM).



SIMATIC RF380R

Reader for the upper performance range; high degree of protection; for assembly lines with longer ranges and highly dynamic applications; with RS422 and RS232 interfaces.



SIMATIC RF382R

Scan mode reader for the upper performance range with integrated special antenna; high degree of protection; for conveyor systems and dynamic applications; with RS422 and RS232 interfaces.

SIMATIC RF300: readers

Rely on extremely fast data transmission.



SIMATIC RF360M

High-performance mobile handheld terminal for applications in production logistics, distribution, and service; available in two versions: with integrated antenna and for external antennas.

SIMATIC RF300: antennas

Discover fast data transmission in a wide range of application areas.



ANT 1 for
SIMATIC RF350R

Universally usable flat antenna; also for dynamic applications; dimensions 75 x 75 x 20 mm (L x W x H).



ANT 3 for
SIMATIC RF350R and RF360M

Flat, compact antenna; can be very precisely positioned even in cramped conditions; dimensions 50 x 28 x 10 mm (L x W x H).



ANT 8 for
SIMATIC RF350R and RF360M

Cylindrical antenna; permits highly precise positioning thanks to its extremely small design; primarily used for tool identification using the small MDS D117, D127, D421, and D521 transponders; dimensions M8 x 38 mm (Ø x L).



ANT 12 for
SIMATIC RF350R and RF360M

Cylindrical antenna; permits highly precise positioning thanks to its extremely small design; primarily used for tool identification; dimensions M12 x 40 mm (Ø x L).



ANT 18 for
SIMATIC RF350R and RF360M

Cylindrical antenna; primarily used for small assembly lines and tool identification; dimensions M18 x 40 mm (Ø x L).



ANT 30 for
SIMATIC RF350R and RF360M

Cylindrical antenna; primarily used for assembly lines and tool identification; dimensions M30 x 40 mm (Ø x L).

SIMATIC RF300: transponders

Large data storage that maintains a minimal size profile.

Transponder categories

Our RF300 transponders are available for the following use cases:



Standard



Logistics



SmartCard



Heat resistant



On metal



In metal



Special applications



MDS D100

85 x 54 x 0.8 mm (L x W x H), ISO 15693, frequency 13.56 MHz, NXP ICODE SLI, 112-byte user memory, printable on both sides, up to +80 °C, IP68, 650 mm range.



MDS D117

4 x 5 mm (Ø x H), ISO 15693, frequency 13.56 MHz, NXP ICODE SLI, 112-byte user memory, non-printable, adhesive, up to +125 °C, IP68, 4 mm range.



MDS D124

27 x 4 mm (Ø x H), ISO 15693, frequency 13.56 MHz, NXP ICODE SLI, 112-byte user memory, non-printable, heat-resistant up to +180 °C, IP68, 300 mm range.



MDS D126

50 x 3.6 mm (Ø x H), ISO 15693, frequency 13.56 MHz, NXP ICODE SLI, 112-byte user memory, non-printable, up to +100 °C, IP68, 500 mm range.



MDS D127

6 x 6 mm (Ø x H), ISO 15693, frequency 13.56 MHz, NXP ICODE SLI, 112-byte user memory, non-printable, in metal, up to +125 °C, IP68, 5 mm range.

SIMATIC RF300: transponders

Large data storage that maintains a minimal size profile.



MDS D139

85 x 15 mm (Ø x H), ISO 15693, frequency 13.56 MHz, NXP ICODE SLI, user memory 112-bytes / 896-bits, screw-on, non-printable, -40 to +220 °C cyclic, IP68, 600 mm range, ATEX II.



MDS D160

16 x 3 mm (Ø x H), ISO 15693, frequency 13.56 MHz, NXP ICODE SLI, 112-byte user memory, non-printable, heat-resistant up to +175 °C, IP68, 180 mm range.



MDS D200

86 x 54 x 0.8 mm (L x W x H), ISO 15693, frequency 13.56 MHz, TI TAGIT HFI, 256-byte user memory, printable on both sides, adhesive, up to +60 °C, IP67, 600 mm range.



MDS D226S

30 x 3.2 mm (Ø x H), ISO 15693, frequency 13.56 MHz, NXP SLI-X2, 316-byte user memory, non-printable, up to +90 °C, IP68/IPX9K, 280 mm range.



MDS D324

27 x 4 mm (Ø x H), ISO 15693, frequency 13.56 MHz, INFINEON SRF 55V10P, 992-byte user memory, non-printable, M3 screw, adhesive, heat-resistant up to +140 °C, IP67, 280 mm range.



MDS D339

85 x 15 mm (Ø x H), ISO 15693, frequency 13.56 MHz, INFINEON SRF 55V10P, 992-byte user memory, non-printable, M5 screw, heat-resistant up to +220 °C, IP68, 480 mm range.

SIMATIC RF300: transponders

Large data storage that maintains a minimal size profile.



Icons: SIMATIC logo, printer, list

MDS D400

85x54x0.8 mm (LxWxH), ISO 15693, frequency 13.56 MHz, FUJITSU MB89R118, 2000-byte FRAM user memory, adhesive, printable on both sides, up to +60 °C, IP67, 650 mm range.



Icons: printer, star

MDS D421

10x4.5 mm (ØxH), ISO 15693, frequency 13.56 MHz, FUJITSU MB89R118, 2000-byte FRAM user memory, adhesive, non-printable, up to +100 °C, IP67, 8 mm range.



Icon: printer

MDS D422

20x6 mm (ØxH), ISO 15693, frequency 13.56 MHz, FUJITSU MB89R118, 2000-byte FRAM user memory, thread M20x1, adhesive, non-printable, up to +100 °C, IP68, 19 mm range.



Icons: printer, printer

MDS D423

30x8 mm (ØxH), ISO 15693, frequency 13.56 MHz, FUJITSU MB89R118, 2000-byte FRAM user memory, M4 countersunk screw on metal, non-printable, up to +100 °C, IP68, 80 mm range.



Icon: list

MDS D424

27x4 mm (ØxH), ISO 15693, frequency 13.56 MHz, FUJITSU MB89R118, 2000-byte FRAM user memory, M3 screw, adhesive, non-printable, up to +100 °C, IP67, 300 mm range.



Icons: printer, star

MDS D425

24x10 mm (ØxH), ISO 15693, frequency 13.56 MHz, FUJITSU MB89R118, 2000-byte FRAM user memory, screws (M6), non-printable, up to +125 °C, IP68, 45 mm range.

SIMATIC RF300: transponders

Large data storage that maintains a minimal size profile.



MDS D426S

30x3 mm (ØxH), ISO 15693, frequency 13.56 MHz, FUJITSU MB89R118, 2000-byte FRAM user memory, screws (M4), non-printable, up to +90 °C, IP68/IPX9K, 280 mm range.



MDS D426

50x3.2 mm (ØxH), ISO 15693, frequency 13.56 MHz, FUJITSU MB89R118, 2000-byte FRAM user memory, screws (M4), non-printable, up to +100 °C, IP68, 400 mm range.



MDS D428

24x20 mm (ØxH), ISO 15693, frequency 13.56 MHz, FUJITSU MB89R118, 2000-byte FRAM user memory, screw-fit transponders M8 long, non-printable, up to +125 °C, IP68, 150 mm range.



MDS D460

16x3 mm (ØxH), ISO 15693, frequency 13.56 MHz, FUJITSU MB89R118, 2000-byte FRAM user memory, patch, adhesive, non-printable, up to +100 °C, IP67, 160 mm range.



MDS D521

10x4.5 mm (ØxH), ISO 15693, frequency 13.56 MHz, FUJITSU MB89R118, 8192-byte FRAM user memory, adhesive, non-printable, up to +100 °C, IP67, 5 mm range.



MDS D522

20x6 mm (ØxH), ISO 15693, frequency 13.56 MHz, FUJITSU MB89R118, 8192-byte FRAM user memory, thread M20x1, adhesive, non-printable, up to +100 °C, IP68, 35 mm range .

SIMATIC RF300: transponders

Large data storage that maintains a minimal size profile.



MDS D524

27x4 mm (ØxH), ISO 15693, frequency 13.56 MHz, FUJITSU MB89R118, 8192-byte FRAM user memory, M3 screw, adhesive, non-printable, up to +100 °C, IP67, 300 mm range.



MDS D525

24x10 mm (ØxH), ISO 15693, frequency 13.56 MHz, FUJITSU MB89R118, 8192-byte FRAM user memory, screw-fit transponders M6 short, non-printable, up to +125 °C, IP68, 50 mm range.



MDS D526

50x3.2 mm (ØxH), ISO 15693, frequency 13.56 MHz, FUJITSU MB89R118, 8192-byte FRAM user memory, M4 screw, non-printable, up to +100 °C, IP68, 400 mm range.



MDS D528

24x20 mm (ØxH), ISO 15693, frequency 13.56 MHz, FUJITSU MB89R118, 8192-byte FRAM user memory, screw-fit transponders M8 long, non-printable, up to +125 °C, IP68, 80 mm range.



MDS D560

16x3 mm (ØxH), ISO 15693, frequency 13.56 MHz, FUJITSU MB89R118, 8192-byte FRAM user memory, patch, adhesive, non-printable, up to +90 °C, IP68, 160 mm range.



SIMATIC RF320T

Universally usable; compact, 20-byte EEPROM + 4-byte serial number; in button format; dimensions 27x4 mm (ØxH).

SIMATIC RF300: transponders

Large data storage that maintains a minimal size profile.



SIMATIC RF330T

Universally usable; compact; high degree of protection IP68/IPx9K; can be used on metal and flush-mounted in metal; suitable for identifying metal workpiece carriers, tools, or containers.



SIMATIC RF340T

Universally usable; especially suitable for small workpiece carriers; can be mounted directly on metal; dimensions 25 x 15 x 48 mm (W x H x D).



SIMATIC RF350T

Universally usable; can be mounted directly on metal; dimensions 50 x 20 x 50 mm (W x H x D).



SIMATIC RF360T

Universally usable; in credit card format; can be mounted on metal with a spacer; dimensions 55 x 2.5 x 86 mm (W x H x D).



SIMATIC RF370T

Universally usable; in cuboid format; can be mounted directly on metal; dimensions 75 x 41 x 75 mm (W x H x D).



SIMATIC RF380T

Heat-resistant; designed for skid identification in paintshops; maximum temperature range up to +220 °C (cyclic).

SIMATIC RF300: transponders

Large data storage that maintains a minimal size profile.



MDS E600

Data memory (752-byte EEPROM) in credit card format; universally usable; degree of protection IP68, up to +60 °C; max. read/write range 70 mm.



MDS E611

Data memory (752-byte EEPROM) in credit card format; universally usable; degree of protection IP68; up to +85 °C; max. read/write range 100 mm.



MDS E623

10x4.5 mm (ØxH); small data memory; 752-byte EEPROM; designed especially for tool coding according to DIN 69873; can be flush-mounted in metal.



MDS E624

27x4 mm (ØxH); universally usable compact data memory; 752-byte EEPROM; degree of protection IP67/IP X9K 1; temperature range up to +125 °C; max. read/write range 40 mm.



MDS D165

86x54x0.3 mm (LxWxH), ISO 15693, frequency 13.56 MHz, NXP ICODE SLI, 112-byte user memory, printable, adhesive, up to +85 °C, IP65, 500 mm range.



MDS D261

55x55x0.3 mm (LxWxH), ISO 15693, frequency 13.56 MHz, STM LRI2K, 316-byte user memory, printable, adhesive, up to +85 °C, IP65, 450 mm range.

SIMATIC RF600 overview

Keeps an eye on a thousand objects.



SIMATIC RF600 is the enabler for seamless production and supply chain solutions that can monitor, track, and identify thousands of objects. In logistics applications with large numbers of containers, pallets, or even finished products, the system's full potential can be realized – for example, in tasks involving long read ranges and bulk reading. The high-performance UHF RFID system transfers this data to the cloud where it is evaluated for the purpose of optimizing production processes and supply chains based on the knowledge gained.

Your benefits at a glance:

- High reliability with long read ranges and robust handling of overreach
- Maximum flexibility in terms of connectivity: connection options for all fields of application (industry, cloud, logistics)
- Reduced project expenditure thanks to quick and easy access to proven configuration, commissioning, and diagnostic tools via a web browser

Get to know the members of the product family

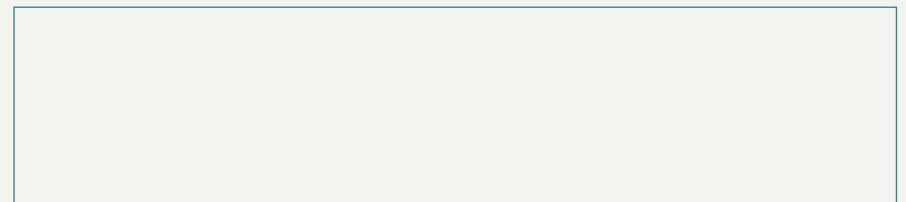

SIMATIC RF600: readers

Take a giant step closer to digitalization with a high-performance, standard-setting UHF RFID system.



SIMATIC RF610R

Compact; integrated, circular, polarized antenna; high degree of protection IP67; read range up to 1.8 m; wide range of communication options; dimensions 133 x 133 x 45 mm (W x H x D).



SIMATIC RF615R

Compact; integrated, circular, polarized antenna; external antenna connection; high degree of protection IP67; read range up to 4 m; wide range of communication options; dimensions 133 x 133 x 45 mm (W x H x D).



SIMATIC RF680R

With four flexibly configurable antenna connections; high degree of protection IP65; read range up to 8 m; wide range of communication options; dimensions 258 x 258 x 80 mm (W x H x D).



SIMATIC RF685R

Integrated adaptive antenna and external antenna connection; high degree of protection IP65; wide range of communication options; dimensions 258 x 258 x 80 mm (W x H x D).



SIMATIC RF690R

Ultra-high reading rate for logistics applications with large tag populations; four configurable antenna connections; PoE; wide range of communication options; dimensions 245 x 209 x 41 mm (W x H x D).



SIMATIC RF695R

Ultra-high reading rate for logistics applications with large tag populations; eight configurable antenna connections; PoE; wide range of communication options; dimensions 245 x 209 x 41 mm (W x H x D).

SIMATIC RF600: readers

Take a giant step closer to digitalization with a high-performance, standard-setting UHF RFID system.



Mobile handheld terminal
SIMATIC RF660M

Compact; for applications in the areas of production logistics, warehouse management, inventory, and service; important tool for commissioning and testing RFID systems.

SIMATIC RF600: antennas

Robust and with a high degree of protection, they are also suitable for harsh industrial use.



SIMATIC RF615A

Extremely compact; ideal for use in production, e.g. for assembly lines or track-guided conveyor systems; dimensions 52 x 52 x 16 mm (W x H x D).



SIMATIC RF622A

Extremely compact; ideal for use in production, e.g. for assembly lines or track-guided conveyor systems; dimensions 76 x 76 x 20 mm (W x H x D).



SIMATIC RF642A

Robust and compact; for industrial applications in production and logistics; with its linear polarization, especially suitable for severely metallic environments; dimensions 185 x 185 x 45 mm (W x H x D).



SIMATIC RF650A

Robust and compact; for industrial applications; with its circular polarization, especially suitable for reading transponders in varying orientations; dimensions 198 x 198 x 60 mm (W x H x D).



SIMATIC RF662A

Suitable for a wide range of production and logistics applications requiring extended reading range; universal UHF antenna; robust design; high degree of protection; dimensions 312 x 312 x 68 mm (W x H x D).



SIMATIC RF680A

Adaptive antenna with switchable polarization (can be set to horizontal, vertical, or circular); makes project planning more reliable even in challenging radio environments; dimensions 198 x 198 x 60 mm (W x H x D).

SIMATIC RF600: hard tags

Passive and maintenance-free, they guarantee smooth operation.

Transponder categories

Our RF600 hard tags are available for the following use cases:



Standard



Logistics



SmartCard



Heat resistant



On metal



In metal



Special applications



SIMATIC RF610T

Flexible card in ISO format; versatile; can be flexibly mounted on a wide range of materials; plastic enclosure designed for food safety; wideband.



SIMATIC RF620T

Container transponder; resistant to environmental influences and cleaning agents; can be mounted on plastic, wood, and glass – and on metal with a spacer; food-safe plastic enclosure; wideband.



SIMATIC RF621T

Container transponder; high range; resistant to environmental influences and cleaning agents; can be mounted on metal with a spacer; wideband.



SIMATIC RF625T

Disk transponder; can be countersunk in metal and flush-mounted on surfaces; robust; high degree of protection (IP68); two frequency versions: 865 to 868 MHz (ETSI) and 902 to 928 MHz (FCC, CMIIT).



SIMATIC RF630T

Screw transponder with M6 grub screw; robust; resistant to cleaning agents; two frequency versions: 865 to 868 MHz (ETSI) and 902 to 928 MHz (FCC, CMIIT).

SIMATIC RF600: hard tags

Passive and maintenance-free, they guarantee smooth operation.



SIMATIC RF640T

Robust, compact tool transponder in IP68/IPx9K; two frequency versions, for 865 to 868 MHz (ETSI) and 902 to 928 MHz (FCC, CMIIT); can be used directly on metal; European version with ATEX approval.



SIMATIC RF645T

Passive, maintenance-free on-metal data storage medium; robust and compact; high degree of protection (IP68); large memory (448-bit EPC/2048-bit user); resistant to mineral oils, lubricants, and cleaning agents; wideband.



SIMATIC RF650T

High range; high degree of protection (IP68); self-adhesive; storage capacity 128-bit EPC, no user memory.



SIMATIC RF670T OEM

Heat-resistant; high range; can be mounted on-metal; high degree of protection (IP67); withstands temperatures up to 250 °C; storage capacity up to 62 Byte/ 496-bit EPC plus up to 752-bit user memory; used in paintshops.



SIMATIC RF670T LOGISTIC

High range; can be mounted on-metal; high degree of protection (IP68/IPx9K); heat resistant up to 140 °C; storage capacity up to 62 Byte/ 496-bit EPC plus up to 752-bit user memory.



SIMATIC RF671T

High range; can be mounted on-metal; high degree of protection (IP67); storage capacity 12 Byte/ 96-bit EPC plus 32-bit user memory.

SIMATIC RF600: hard tags

Passive and maintenance-free, they guarantee smooth operation.



Heat-resistant; high range; high degree of protection (IP68/IPx9K); silicon-free; withstands temperatures up to 220 °C; storage capacity 96/ 240-bit EPC plus 512-bit user memory; wideband.



Heat-resistant; high range; high degree of protection (IP68/IPx9K), silicon-free; withstands temperatures up to 220 °C; storage capacity 256-bit EPC plus 3072-bit user memory; wideband.



Heat-resistant; high range; high degree of protection (IP68/IPx9K); withstands temperatures up to 220 °C; storage capacity 32-byte/ 256-bit EPC plus 384-byte/ 3kbit user memory.

SIMATIC RF600: SmartLabels

Passive and maintenance-free, they guarantee smooth operation.

Transponder categories

Our RF600 SmartLabels are available for the following use cases:



Standard



Logistics



Heat resistant



On metal



Special applications



SIMATIC RF630L
6GT2810-2AB02-0AX2

PET transparent, 97x27 mm, 860 to 930 MHz, EPC 56-byte/ 448-bit, user memory 256-byte/2048-bit, adhesive on one side, not printable, -40 to +80 °C, 76.2 mm (3") core diameter, 5 m range.



SIMATIC RF630L
6GT2810-2AB03

PET, 54x34 mm, 860 to 930 MHz, EPC 30-byte/240-bit, user memory 64-byte/ 512-bit, adhesive on one side, printable, -40 to +80 °C, 76.2 mm (3") core diameter, 5 m range.



SIMATIC RF630L
6GT2810-2AC84

PET, 73x12.5 mm, 860 to 930 MHz, EPC 56-byte/448-bit, user memory 256-byte/2048-bit, adhesive on one side, printable, -20 °C to +70 °C, 76.2 mm (3") core diameter, 5 m range.



SIMATIC RF630L
6GT2810-2AE81-0AX3

PET, 75x20 mm, 860 to 930 MHz, EPC 56-byte/448-bit, user memory 256-byte/2048-bit, strongly adheres to plastic, printable, -25 °C to +85 °C (short term 120 °C), 76.2 mm (3") core diameter, 4 m range.



SIMATIC RF630L
6GT2810-2AE82-1AX0

PET white, 80x26 mm, 860 to 930 MHz, EPC 16-byte/128-bit, no user memory, strongly adheres to plastic, printable, -25 °C to +85 °C short term 160 °C), 76.2 mm (3") core diameter, 5 m range.

SIMATIC RF600: SmartLabels

Passive and maintenance-free, they guarantee smooth operation.



SIMATIC RF630L
6GT2810-2AE82-0AX0

PET white, 90x30mm, 860 to 930MHz, EPC 16-byte/128-bit, no user memory, strongly adheres to plastic, printable, -25 °C to +85 °C (short term 160 °C), 76.2 mm (3") core diameter, 5 m range.



SIMATIC RF630L
6GT2810-2AE82-0AX1

PET white, 90x30mm, 860 to 930MHz, EPC 16-byte/128-bit, no user memory, strongly adheres to plastic, printable, -25 °C to +85 °C (short term 160 °C), 152.4 mm (6") core diameter, 5 m range.



SIMATIC RF630L
6GT2810-2AE82-0AX2

SmartLabel like RF630L 6GT2810-2AE82-0AX1 as tamper-proof version with safety perforation.



SIMATIC RF630L
6GT2810-2AE82-2AX0

PET white, 45x20mm, 860 to 930MHz, EPC 16-byte/128-bit, no user memory, strongly adheres to plastic, printable, -25 °C to +85 °C (short term 160 °C), 76.2 mm (3") core diameter, 5 m range.



SIMATIC RF630L
6GT2810-2AE83-0AX0

PET white, 75x25mm, 860 to 930MHz, EPC 16-byte/128-bit, no user memory, strongly adheres to plastic, printable, -25 °C to +85 °C (short term 130 °C), 76.2 mm (3") core diameter.



SIMATIC RF630L
6GT2810-2AE83-0AX1

PET white, 105x25mm, 860 to 930MHz, EPC 56-byte/448-bit, user memory 256-byte/2048-bit, strongly adheres to plastic, printable, -25 °C to +85 °C (short term 130 °C), 76.2 mm (3") core diameter, 5 m range.

SIMATIC RF600: SmartLabels

Passive and maintenance-free, they guarantee smooth operation.



SIMATIC RF630L
6GT2810-2AE83-1AX0

PET white, 45x20mm, 860 to 930MHz, EPC 16-byte / 128-bit, no user memory, strongly adheres to plastic, printable, -25 °C to +85 °C (short term 130 °C), 76.2 mm (3") core diameter, 5 m range.



SIMATIC RF630L
6GT2810-2AB04-0AX1

Paper white, 4 x 2", 860 to 930 MHz, EPC 56-byte / 448-bit, user memory 256-byte / 2048-bit, strongly adheres to plastic, printable, -25 °C to +80 °C, 76.2 mm (3") core diameter, 5 m range.



SIMATIC RF642L
6GT2810-3AC00

PET, 50x22.5x1.6mm; 860 to 868MHz/902 to 928MHz, EPC 56-byte / 448-bit, user memory 256-byte / 2048-bit, self-adhesive on metal/plastic, printable, -25 °C to 85 °C, 76.2 mm (3") core diameter, 4 m range.



SIMATIC RF642L
6GT2810-3AC10

PET, 50x22.5x1.6mm; 860 to 868MHz/902 to 928MHz, EPC 56-byte / 448-bit, user memory 256-byte / 2048-bit, self-adhesive on metal/plastic, printable, -25 °C to 85 °C, 76.2 mm (3") core diameter, 4 m range.



SIMATIC RF682L
6GT2810-2AG84-0AX2

Nomex, 156x40x0.4mm, 860 to 930 MHz, EPC 56-byte / 448-bit, user memory 256-byte / 2048-bit, for assembly, printable, -40 °C to 200 °C (short term 230 °C), stacked, no core diameter, 6 m range.

SIMATIC Ident Systems overview

Fully functional, best-in-class reading system with a single order.



Complete, pre-configured and ready-to-use system for identifying and tracking objects on conveyors using RFID. Industry-proven components and “UHF for Industry” algorithms ensure a reliable reading system for Tires, Intralogistics and Discrete Industries.

Your benefits at a glance:

- Identify and track various objects on conveyors in intra-logistics or production and easily achieve product ID-driven sorting and path routing
- “UHF for Industry” algorithms and industrial-proven components deliver outstanding reading performance
- Easy and quick installation, commissioning and integration into existing automation systems, no expert knowledge needed
- Reliable combination of hardware, software and services

Get to know the members of the product family

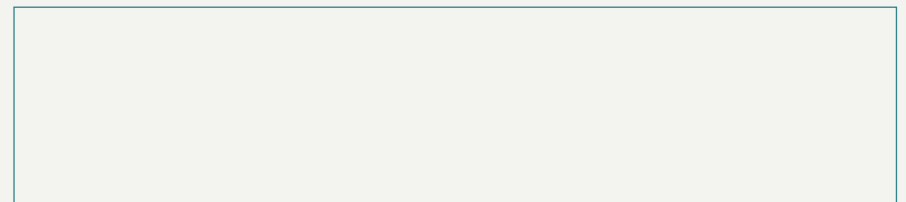

SIMATIC Ident Systems: SIMATIC Ident CB Gate

Identify and track various objects on conveyors.

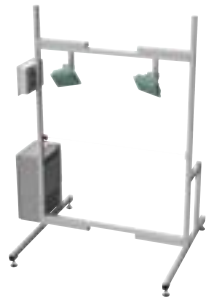

SIMATIC Ident
CB 2H Gate

System with two antennas; standard acquisition software; RFID and automation components incl. HMI panel, control cabinet and metal structure; ETSI, FCC, CMIIT versions; expandable 1.55–1.95x2x1.2 m (WxHxD), weight 53 kg.

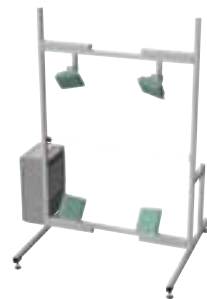

SIMATIC Ident
CB 4 Gate

System with four antennas; standard acquisition software; RFID and automation components incl. control cabinet and metal structure; ETSI version; expandable 1.55–1.95x2x1.2 m (WxHxD), weight 53 kg.

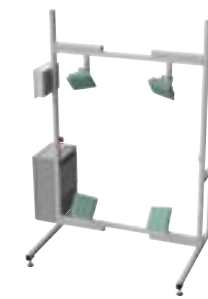

SIMATIC Ident
CB 4H Gate

System with four antennas; standard acquisition software; RFID and automation components incl. HMI panel, control cabinet and metal structure; ETSI, FCC, CMIIT versions; expandable 1.55–1.95x2x1.2 m (WxHxD), weight 53 kg.

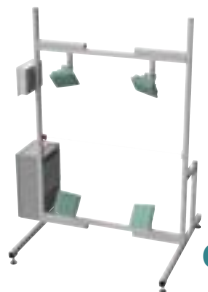

SIMATIC Ident
CB 4H Gate for Tire

System with four antennas; special acquisition software for tire incl. side detection; RFID and automation components incl. HMI panel, control cabinet and metal structure; ETSI, FCC, CMIIT versions; expandable 1.55–1.95x2x1.2 m (W x H x D), weight 53 kg.

SIMATIC RF1000 overview

Permits access management using existing employee IDs.



You can easily and flexibly boost process security thanks to electronic access management. SIMATIC RF1000 uses existing employee IDs as the basis for the necessary identification, allowing you to implement finely-graded access concepts, document processes, or store user-specific notes and instructions at a minimal cost.

Your benefits at a glance:

- Individual control of access rights and prevention of operating errors
- Individual, centralized assignment of rights via central databases including Active Directory
- Easy integration in HMIs via PM-Logon and PLC/ PC integration via Modbus TCP and XML

Get to know the members of the product family

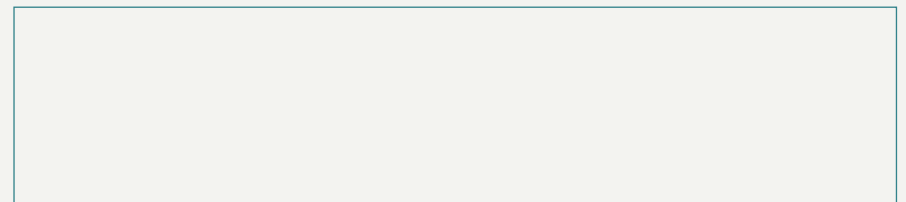

SIMATIC RF1000: readers

Discover a new level of simplicity in access control for machines and plants.



SIMATIC RF1040R

Robust, compact, shallow mounting depth; standards: HF, LF; USB interface (1.8 m cable with USB connector, type A) and additional RS232 interface.



SIMATIC RF1060R

Robust, compact, shallow mounting depth; standards: HF; USB interface (1.8 m cable with USB connector, type A) for connecting to Windows-based computers.



SIMATIC RF1070R

Robust, compact, shallow mounting depth; standards: HF including Legic; with USB and RS232 interfaces.



SIMATIC RF1070R OEM

Robust, compact, shallow mounting depth; standards: HF including Legic; OEM version with neutral front film for customer-specific design; with USB and RS232 interfaces.



SIMATIC RF1140R

Robust, compact, shallow mounting depth; standards: HF, LF; Power over Ethernet or 24 V connector; RJ45 interface; Web-based management; XML and Modbus TCP protocols.



SIMATIC RF1170R

Robust, compact, shallow mounting depth; standards: HF, including Legic; Power over Ethernet or 24 V connector; RJ45 interface; Web-based management; XML and Modbus TCP protocols.

SIMATIC RF1000: transponders

With RFID for secure access control for machines and plants.

The transponders listed below are ideal for use with the SIMATIC RF1000 system.



MDS D100

85 x 54 x 0.8 mm (L x W x H), ISO 15693, frequency 13.56 MHz, NXP ICODE SLI, 112-byte user memory, printable on both sides, up to +80 °C, IP68, 650 mm range.



MDS D124

27 x 4 mm (Ø x H), ISO 15693, frequency 13.56 MHz, NXP ICODE SLI, 112-byte user memory, non-printable, heat-resistant up to +180 °C, IP68, 300 mm range.



MDS D200

86 x 54 x 0.8 mm (L x W x H), ISO 15693, frequency 13.56 MHz, TI TAGIT HFI, 256-byte user memory, printable on both sides, adhesive, up to +60 °C, IP67, 600 mm range.



MDS D324

27 x 4 mm (Ø x H), ISO 15693, frequency 13.56 MHz, INFINEON SRF 55V10P, 992-byte user memory, non-printable, M3 screw, adhesive, heat-resistant up to +140 °C, IP67, 280 mm range.



MDS D400

85 x 54 x 0.8 mm (L x W x H), ISO 15693, frequency 13.56 MHz, FUJITSU MB89R118, 2000-byte FRAM user memory, adhesive, printable on both sides, up to +60 °C, IP67, 650 mm range.

SIMATIC RF1000: transponders

With RFID for secure access control for machines and plants.



MDS D424

27x4 mm (ØxH), ISO 15693, frequency 13.56 MHz, FUJITSU MB89R118, 2000-byte FRAM user memory, M3 screw, adhesive, non-printable, up to +100 °C, IP67, 300 mm range.



MDS D524

27x4 mm (ØxH), ISO 15693, frequency 13.56 MHz, FUJITSU MB89R118, 8192-byte FRAM user memory, M3 screw, adhesive, non-printable, up to +100 °C, IP67, 300 mm range.



MDS E600

Data memory (752-byte EEPROM) in credit card format; universally usable; degree of protection IPA; up to +60 °C; max. read / write range 70 mm.



MDS E611

Data memory (752-byte EEPROM) in credit card format; universally usable; degree of protection IP68; up to +85 °C; max. read / write range 100 mm.

On a fast track to your optimal OID system

Our high-end readers with high-performance image capture excel thanks to their reading reliability, even under the most difficult conditions. Select the perfect camera to meet your needs from our extensive portfolio. Products include fully pre-equipped – as well as individually configurable – devices with various resolutions and comprehensive accessories, like ring lights and lenses. The intuitive user interface of the integrated web server makes commissioning seem like child's play.

SELECTION CRITERIA

OID



SIMATIC MV500 overview

Reliably reads in record time, even under difficult conditions.



Thanks to their multicore processor, these high-end readers feature high reading performance even under the most difficult conditions. These devices can be flexibly adapted to your particular task in terms of resolution, lighting, and lenses. The intuitive user interface of the web server makes commissioning easy.

Your benefits at a glance:

- Easy handling thanks to a one-button operating concept for network and reading configuration
- Seamless integration into the TIA automation environment: function blocks available, cost-efficient installation, faster commissioning, simple parameterization thanks to technology objects

Get to know the members of the product family

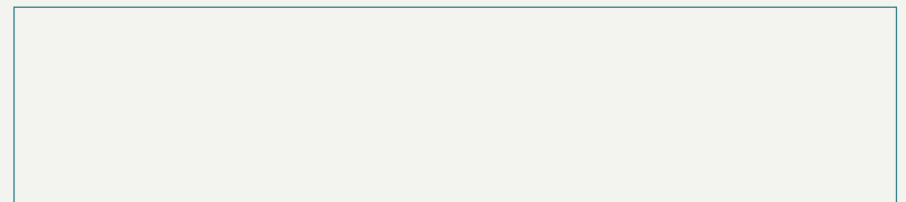

SIMATIC MV500: stationary optical readers

Experience a new level of reading performance that can be scaled to your specific task.



SIMATIC MV530

Compact optical readers with image capture rates ≤ 100 images per second; resolution: SD and HD; image field and operating distance (approx. 5 cm to approx. 20 cm) predefined; PROFINET/IE (PoE), IP67.



SIMATIC MV540

Optical readers with image capture rates ≤ 100 images per second; resolution: SD and HD; image field and operating distance selectable depending on lens; PROFINET/IE (PoE), IP67.



SIMATIC MV550

Optical readers with image capture rates ≤ 100 images per second plus Gigabit Ethernet interface; resolution: SD and HD; image field and operating distance selectable depending on lens; PROFINET/IE (PoE), GigE, IP67.



SIMATIC MV560

Optical readers with image capture rates ≤ 60 images per second plus Gigabit Ethernet interface; resolution: UD and XD; image field and operating distance selectable depending on lens; PROFINET/IE (PoE), GigE, IP67.

SIMATIC MV300 overview

Sits comfortably in your hand and is suitable for mobile use.



SIMATIC MV300 optical handheld readers are suitable for the portable reading of DMCs and barcodes on many different surfaces. This especially applies to labels with higher contrasts but it can also easily be used for codes with lower contrasts on an application-specific basis. A variety of interfaces – RS232, USB, or Bluetooth – open up new opportunities for universal use.

Your benefits at a glance:

- Powerful 1D/2D code reading, including low-contrast codes
- Flexible interface connection (RS232, USB, Bluetooth, communication module connection)
- Robust, ergonomic design for manual workstations

Get to know the members of the product family

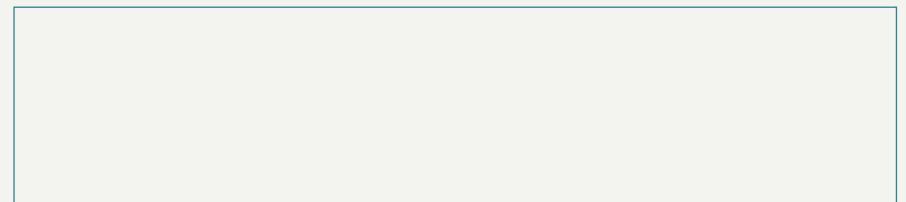

SIMATIC MV300: optical handheld readers

Don't compromise when it comes to reliably reading 1D and 2D codes with handheld readers.



SIMATIC **MV320**

Robust, high-performance barcode and data matrix reader (high resolution); cabled communication.



SIMATIC **MV326**

Robust, high-performance barcode and data matrix reader (high resolution); suitable for wireless communication.

Easy integration in all standard automation environments

To fully display their strengths, industrial identification systems must be seamlessly integrated in existing automation. The communication modules that this requires are also available in the SIMATIC Ident portfolio. They are especially compact devices with a high degree of protection that makes them suitable for harsh industrial environments and able to be used in applications where space is at a premium. The standardized connection between readers and communication modules permits maximum transfer rates. Moreover, the communication modules are extremely easy and flexible to integrate in standard industrial systems.

SELECTION CRITERIA

INTEGRATION



Communication modules for connecting to industrial bus systems

Seamless integration via various protocols.

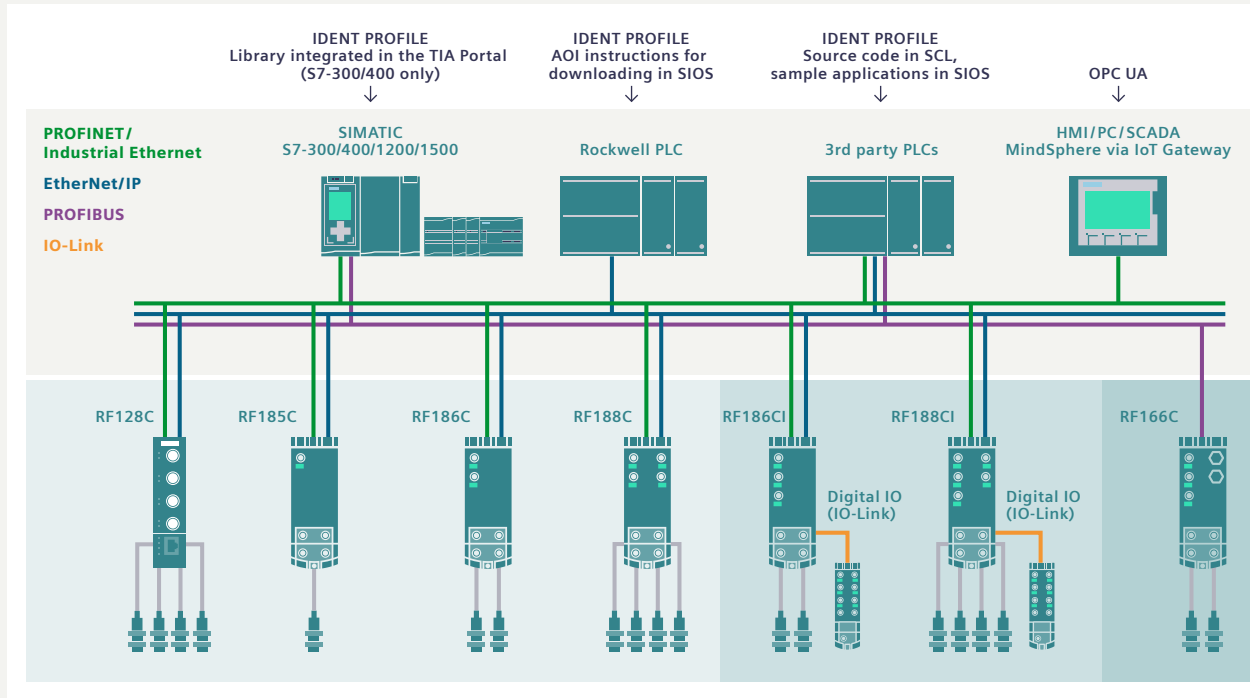

The RF128C, RF185C, RF186C/CI, RF188C/CI, and RF166C communication modules offer a variety of options for connecting to automation. Parallel reader control with optimized function blocks ensures top performance. The configuration can also be adapted during operation via integrated web-based management. Any errors can be efficiently corrected using the integrated diagnostics options.

Your benefits at a glance:

- Tailored configuration thanks to different connection versions (1-, 2-, or 4-channel)
- Modular system configuration with standard function blocks in the TIA Portal
- Parallel connection to two applications – e.g. control system and cloud monitoring
- Integrated IO-Link master for connecting various standard sensors or actuators

Communication modules for connecting to industrial bus systems

Seamless integration via various protocols.



RF128C

For connecting up to four readers to PROFINET, EtherNet/IP, and XML, with IP20.



RF185C

For connecting a reader to PROFINET, EtherNet/IP, OPC UA, and XML.



RF186C

For connecting up to two readers to PROFINET, EtherNet/IP, OPC UA, and XML.



RF186CI

For connecting up to two readers and up to eight sensors and eight actuators to PROFINET, EtherNet/IP, OPC UA, and XML.



RF188C

For connecting up to four readers to PROFINET, EtherNet/IP, OPC UA, and XML.



RF188CI

For connecting up to four readers and up to eight sensors and eight actuators to PROFINET, EtherNet/IP, OPC UA, and XML.

Communication modules for connecting to industrial bus systems

Seamless integration via various protocols.



RF166C

For connecting up to four readers to PROFIBUS.

Communication modules for connecting to SIMATIC controllers and distributed I/Os

Direct connection to SIMATIC S7-300, SIMATIC S7-1200, and SIMATIC ET 200pro.

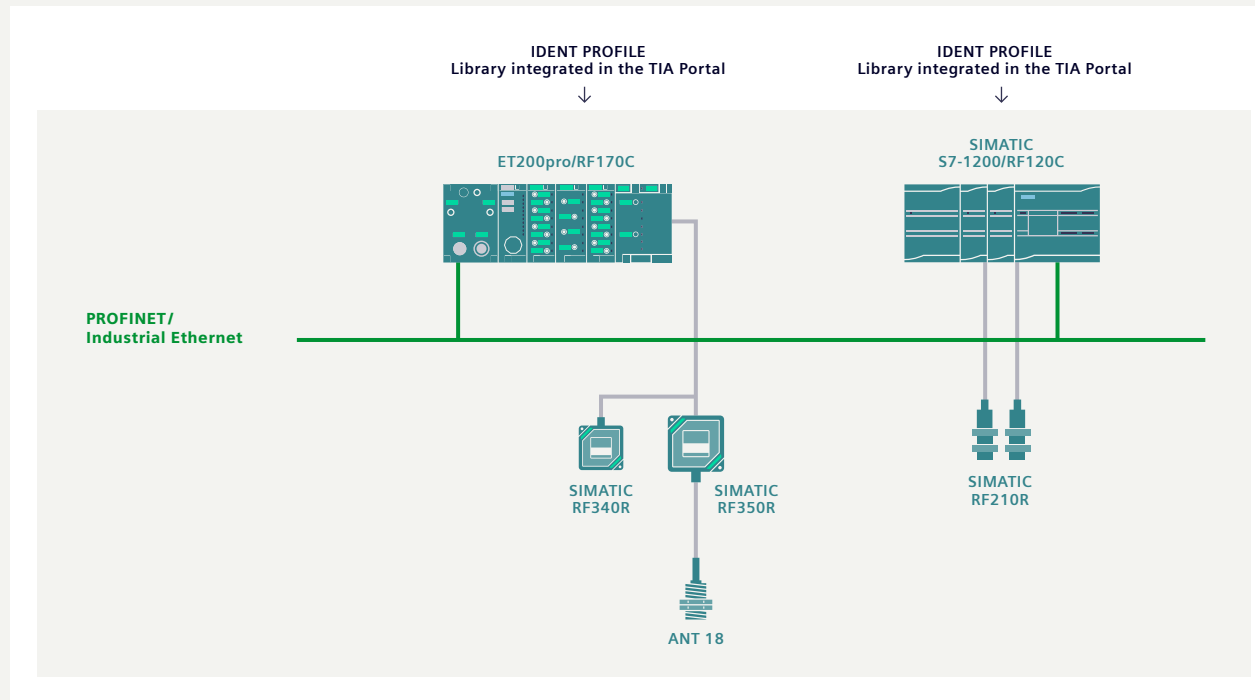

With the RF120C and RF170C communication modules, you can connect a SIMATIC Ident device directly to SIMATIC S7-300 and SIMATIC S7-1200 controllers as well as to SIMATIC ET 200pro distributed I/Os. Bus systems with the corresponding additional cables or hardware components are not required.

Your benefits at a glance:

- Cost-efficient and high-performance integration into the automation environment
- TIA Portal system integration with standard function blocks
- Suitable cabinet installation thanks to proven DIN rail mounting

Communication modules for connecting to SIMATIC controllers and distributed I/Os

Direct connection to SIMATIC S7-300, SIMATIC S7-1200, and SIMATIC ET 200pro.



RF120C

For connecting SIMATIC Ident systems to SIMATIC S7-1200 controllers.



RF170C

For connecting SIMATIC Ident systems to the SIMATIC ET 200pro distributed I/O system.

IoT gateways for connecting to cloud applications

Direct connection to cloud applications.

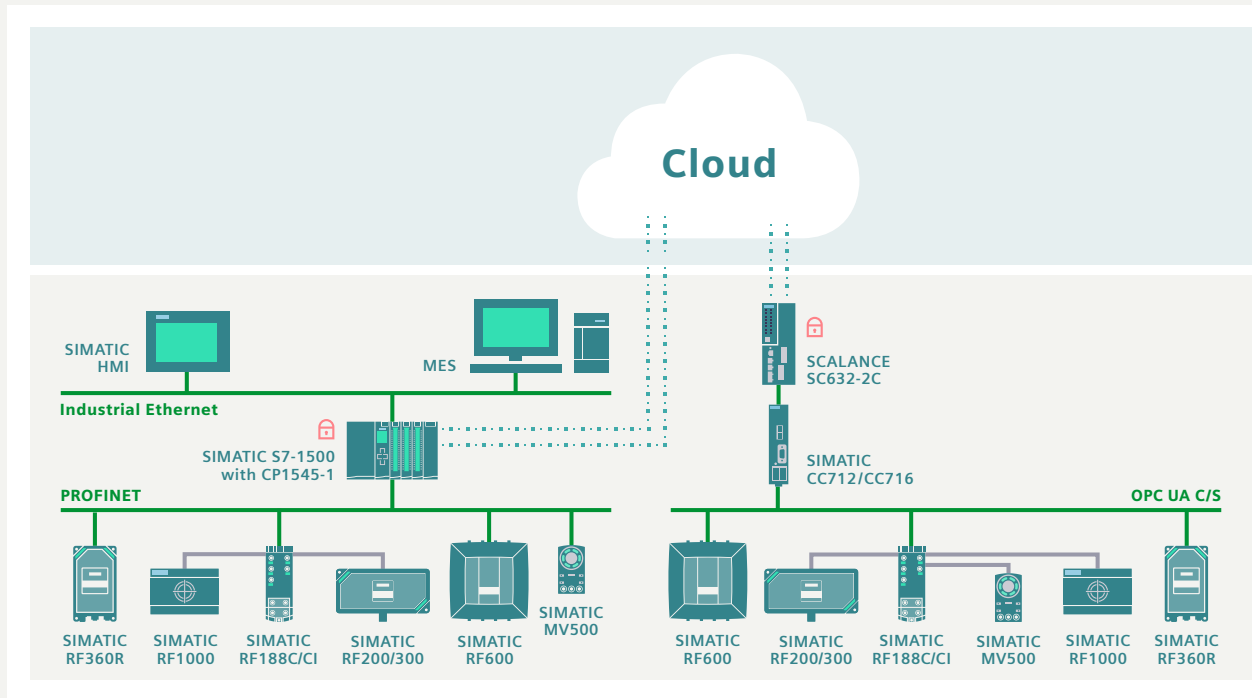

For future-oriented operation in the IIoT environment, our readers and communication modules can be connected to various cloud applications via OPC UA in a way that is standardized and secure. In this case, CP1545-1 and SIMATIC CC712 and CC716 serve as IoT gateways. Object data can then be used for cross-manufacturer communication and analysis, resulting in a long-term increase in transparency within the supply chain.

Your benefits at a glance:

- Universal options for cloud integration from a single source
- Standardized OPC UA Stack (according to OPC UA AutoID Companion Specification)
- Parallel connection to PROFINET possible

IoT gateways for connecting to cloud applications

Direct connection to cloud applications.



SIMATIC CC712

Transfers data to various cloud platforms like MindSphere; 2 x Ethernet RJ45; field protocols: S7, Modbus MES / Cloud; protocols: MQTT, OPC UA.



SIMATIC CC716

Transfers data to various cloud platforms like MindSphere; 2 x Ethernet RJ45, 1 x MPI / PB; field protocols: S7, Modbus MES / Cloud; protocols: MQTT, OPC UA.



SIMATIC CP 1243-1

Communications processor for connection of SIMATIC S7-1200 as additional Ethernet interface and for connection to control centers via telecontrol protocols (DNP3, IEC 60870, TeleControl Basic), security (Firewall, VPN).



SIMATIC CP 1243-7 LTE

Communications processor for connection of SIMATIC S7-1200 to LTE network.



SIMATIC CP 1545-1

Enables simple and reliable data transfer to MindSphere or another cloud solution that supports the standardized MQTT protocol.

IO-Link master modules for integration in IO-Link master systems

Seamless integration in IO-Link master systems.

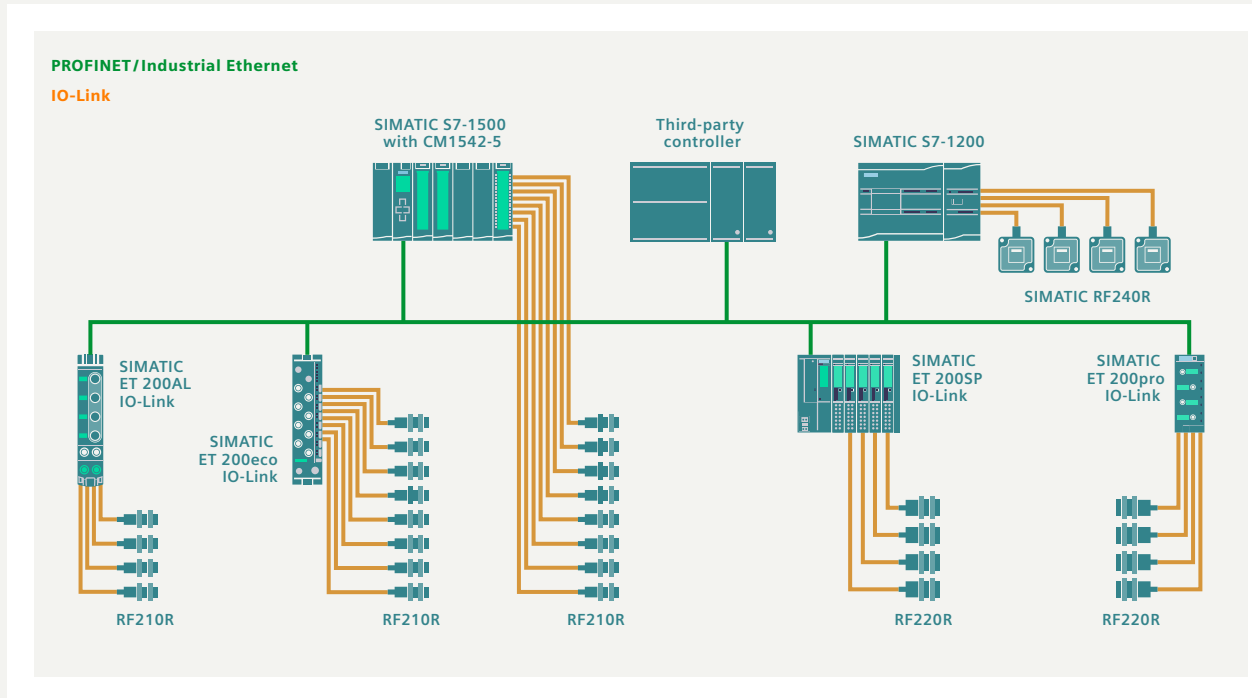

Our portfolio contains numerous IO-Link master modules for all peripheral devices. The standardized IO-Link interface makes it possible to integrate our RFID readers in IO-Link master systems from different manufacturers. In addition, a simple point-to-point connection significantly reduces wiring effort.

Your benefits at a glance:

- No RFID-specific programming necessary
- Cost-efficient integration of numerous RFID reading points
- Up to eight IO-Link ports based on IO-Link Specification V1.1 or V1.0

IO-Link master modules for integration in IO-Link master systems

Seamless integration in IO-Link master systems.



**IO-Link Master
for ET 200SP**

For integrating SIMATIC ET 200SP distributed I/Os and up to four SIMATIC RF200 IO-Link readers.



**IO-Link Master
ET 200AL**

For integrating SIMATIC ET 200AL distributed I/Os and up to four SIMATIC RF200 IO-Link readers.



**IO-Link Master
ET 200pro**

For integrating SIMATIC ET 200pro distributed I/Os and up to four SIMATIC RF200 IO-Link readers.



**IO-Link Master
S7-1200 Basis**

For integrating the S7-1200 controller and up to four SIMATIC RF200 IO-Link readers.



**IO-Link Master
S7-1500 Basis**

For integrating SIMATIC ET 200MP distributed I/Os and SIMATIC S7-1500 controllers and up to eight SIMATIC RF200 IO-Link readers.



**IO-Link Master
ET 200eco PN**

For integrating SIMATIC ET 200eco PN distributed I/Os and up to eight SIMATIC RF200 IO-Link readers.

Professional services and training courses covering all aspects of industrial identification

As a partner to industry, we offer you more than just first-class products and systems. We round off our comprehensive portfolio with a wide range of services and training courses.



Professional Services

Expert support and consulting for future-proof solutions with industrial identification:

- On-site service and support
- Health check
- Design and consulting
- Integration and implementation

simatic-ident.industry@siemens.com



Industrial Identification Education

Training courses and certifications for industrial identification:

- SIMATIC Ident
 - RFID
 - Optical identification

certification.ci.industry@siemens.com



Contact

[Support Services](#)

**Published by
Siemens AG**

Digital Industries
Process Automation
Östliche Rheinbrückenstr. 50
76187 Karlsruhe
Germany

Article No.: DIPA-I10296-00-7600

WS 22080.0

© Siemens 2025

siemens.com/ident

Subject to changes and errors. The information provided in this brochure contains descriptions or performance characteristics which, in case of actual use, do not always apply as described or which may change as a result of further development of the products. The desired performance characteristics are only binding if expressly agreed in the contract. Availability and technical specifications are subject to change without notice.

All product designations may be trademarks or product names of Siemens AG or supplier companies, the use of which by third parties for their own purposes may violate the rights of the owners.

Security information

Siemens provides products and solutions with industrial security functions that support the secure operation of plants, systems, machines and networks.

In order to protect plants, systems, machines and networks against cyber threats, it is necessary to implement – and continuously maintain – a holistic, state-of-the-art industrial security concept. Siemens' products and solutions constitute one element of such a concept.

Customers are responsible for preventing unauthorized access to their plants, systems, machines and networks. Such systems, machines and components should only be connected to an enterprise network or the internet if and to the extent such a connection is necessary and only when appropriate security measures (e.g. firewalls and/or network segmentation) are in place.

For additional information on industrial security measures that may be implemented, please visit

<https://www.siemens.com/industrialsecurity>

Siemens' products and solutions undergo continuous development to make them more secure. Siemens strongly recommends that product updates are applied as soon as they are available and that the latest product versions are used. Use of product versions that are no longer supported, and failure to apply the latest updates may increase a customer's exposure to cyber threats.

To stay informed about product updates, subscribe to the Siemens Industrial Security RSS Feed under

<https://www.siemens.com/industrialsecurity>