

EFFECTIVE
09.30.24

September 2024

Retail* Price List & Product Information Guide

*10% tariff has been included.

Contents

General Information »	3
Production Time, Pricing & Terms, Returns, Changes & Cancellations, Shipping, Installation, Dimension Key, Materials, Finishes, PTH Perfect Match™	
Portfolio Collection »	
1 1/8" Diameter Finial Collections	7
Modern, Clean Deco, Transitional Luxe, Bohemian Chic, Rustic Retreat	
1 3/8" Finial Collections	14
Modern, Today's Traditional, Heritage Classics	
2 1/4" Finial Collections	22
Today's Traditional, Heritage Classics	
Traverse Systems »	
1 3/8" Motorized Metal Traverse	32
R-TEC Automation® Motorized System	
Motorized Heavy Duty Traverse	42
R-TEC Automation® or Somfy®	
Metal Manual Baton Draw Traverse	63
1 1/8" - 1 3/8" Diameters, Baton Draw	
Heavy Duty Manual Traverse	74
1 3/8" - 2 1/4" Diameters, Corded or Baton	
Quick Ship Collection »	
1 1/8" Diameter Finial Collections	87
Modern, Clean Deco, Transitional Luxe	
1 3/8" Finial Collections	93
Modern, Today's Traditional, Heritage Classics	
2 1/4" Finial Collections	102
Today's Traditional, Heritage Classics	
Sales Tools »	106

FABRICUT®

PTH
PARIS TEXAS
HARDWARE™



Designed to *Inspire.*



» For over 30 years, Paris Texas Hardware has been dedicated to evolving our legacy of providing exceptional design and superior service. Our in-house design team places you at the center of the design process while staying true to our heritage of curating designs that are uniquely our own.

We respect the important relationship between style and function in design and are excited to introduce many customized solutions that are perfectly balanced to inspire your vision into a reality.

Whether it's a Modern finial silhouette that has never been seen before, a Heritage Classic with a new twist or a customized traverse solution integrated with the latest smart home technology, we promise to provide you with something different – a collective style designed to inspire that you cannot find anywhere else in the world.



Trusted Heritage

In celebration of our 30 year anniversary, we promise to deliver on our rich legacy of providing high quality products, unique & elegant designs, a wide selection of finishes and superior service combined with designer expertise to elevate your design vision.



High Quality Products

Our products are tailored specifically to your needs and designed to be unrivaled in their ability to stand alone as the perfect combination of smart, decorative, durable and functional.



Wide Selection of Finishes

With a choice between our 35 Hand Painted Portfolio Finishes, 6 Quick Ship Metal Finishes, 5 Quick Ship Wood & Resin Finishes and PTH Perfect Match™, the possibilities are endless. Our talented artisans enjoy the challenge of creating any finish that you can envision.

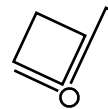

Available Stock | Quick Ship

When you need products to complete a project in a hurry, our Quick Ship Collection offers products that are in stock and ship within 24 hours. Available in 6 plated metal finish options, 5 wood & resin finish options, over 50 finial designs and many bracket and accessory styles.



Superior Service

Paris Texas Hardware promises to offer an enjoyable customer experience that includes honest dialogue and responsive feedback.



Designer Expertise



Our talented team, with years of experience, are ready to help design the perfect window treatment solution for your project. Look for the icon throughout the catalog for tips, techniques and inspiration provided by our design experts, and download the full booklet using the QR code above, or by visiting: bit.ly/PTH-DE

Dimension Key

Poles

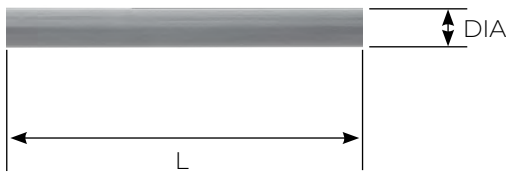

Finials

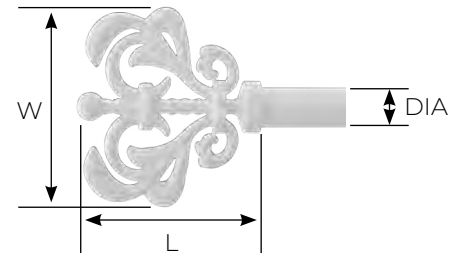
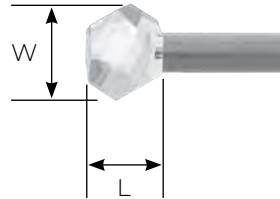

Wall Mount Brackets

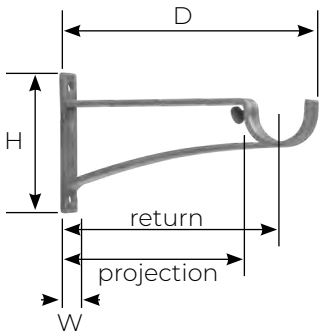

Ceiling Mount Brackets

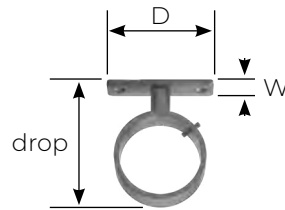

Inside Mount Brackets

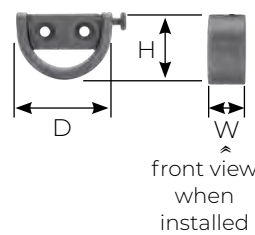

Elbows

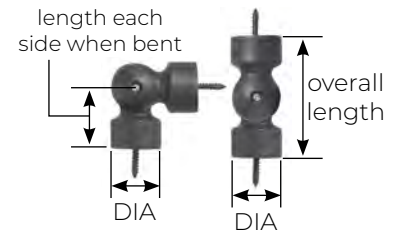

Rings

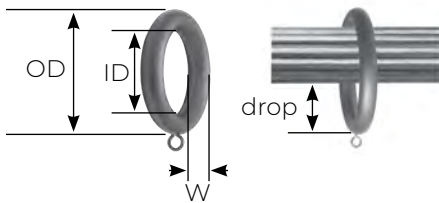

Materials

Some finials, brackets, holdbacks and rings are made of resin composite materials. Resin may be damaged by cutting, drilling or attempting to alter the size or shape of products. Some items are made of cast aluminum or stamped steel. Wood poles and wood rings are made of various hardwoods. Metal poles and metal rings are made of metal or steel.

Poles & Rods

Wood poles may be spliced together using a dowel splicing screw, which is included with each pole. Metal poles may be spliced together using our pole splice, sold separately, or a dowel splicing screw where plastic inserts are included. We recommend a center support bracket for pole lengths in excess of four feet. We cannot guarantee against sagging caused by unsupported spans greater than our recommended four feet.

Finials

All finials are sold as pairs. Most resin finial bases have a 1/8" recess for a clean pole fit. Resin finials are fitted with a dowel screw that may not be removed without damaging the finial. 1 1/8" metal finials are supplied with plastic inserts to attach the finials. 1 3/8" metal finials are fitted with a set screw, which can be tightened using an allen wrench provided.

Brackets

Brackets are sold individually. Depending on the style of the bracket, there are three wall mounting styles; key lock, round mounting plate or front drill. Some heavier treatments may require stronger fasteners (mollies and screws) than those included with the brackets. Brackets should be installed securely into wall studs.

Rings

Rings are sold individually. Eyelets are not detachable from rings. Excessive movement of rings on the top of the pole will naturally abrade the finish. We recommend three to four rings per foot of finished pole length, or six to seven rings per width of fabric.

General Information

Production Time

Purchase orders are processed once they are received by Paris Texas Hardware. Incomplete information will delay processing and shipping. Quick Ship collections are in stock and ship within 24 hours. Quick Ship orders received before noon CST ship the same day. Portfolio custom collection is hand finished and ships within 10-15 business days.

Heavy Duty Corded or Baton & Motorized Traverse Systems

Heavy duty traverse systems are available with or without decorative wood fascia, available in 1 3/8" or 2 1/4" smooth, reeded or grooved / fluted profiles with coordinating finials, 1 7/8" slim round smooth profile, 2 1/4" flat smooth profile with flush ends or mitered returns, in Portfolio, PTH Perfect Match™ and Quick Ship Wood & Resin. Production time for traverse system orders is 10-15 business days. Please refer to pages 49 & 77 for available fascia styles, sizes and finishes.

Metal Baton Draw & Motorized Traverse Systems

Metal traverse systems are available in 1 1/8" and 1 3/8" Portfolio (except Antique Gold Leaf), PTH Perfect Match™, Quick Ship Metal and Quick Ship Wood & Resin. **All 1 1/8" and Wood & Resin 1 3/8" require Transitional Cuff / Finial Adapters to attach finials, sold separately.** Production time for traverse system orders is 10-15 business days. Please refer to pages 32 - 41 and 63 - 73 for available metal track sizes and finishes.

Pricing & Terms

Pricing found in the Paris Texas Hardware Price List are our Suggested Retail Prices. Prices are subject to change without notice. Due to the U.S. government's current policy on China tariffs, all products are subject to a tariff surcharge as of September 1, 2019. Prices are quoted exclusive of Freight and Packaging. The Buyer should always inspect the product upon receipt.

IMPORTANT: Please note that your order will be placed with an authorized Paris Texas Hardware Distributor. While most of the following will generally apply, your distributor may have terms and conditions of the sale that will vary from what is stated here.

Returns, Changes & Cancellations

All Portfolio and PTH Perfect Match™ products are custom painted and may not be Returned. Orders may not be changed or canceled once production has begun.

Quick Ship items may be Returned if poles are uncut and all products are received in sellable condition. A restocking fee of 40% will apply and the customer will prepay freight. All Returns must be authorized by the Paris Texas Hardware customer service department, and are authorized at our discretion, given the circumstances and nature of each order. A Return Authorization Number (RA#) must be issued by customer service, and the RA#

must be noted on all Return packages. Return Credit is issued on Returned goods that are inspected and deemed undamaged. Customers should exercise care to adequately package Return goods. Return Credit will not be issued for unauthorized Returns or damaged Returns.

Shipping (NET Fees)

All hardware orders are shipped FOB Dallas, Texas. Standard size orders ship using normal guidelines via UPS or FedEx ground. Average transit time is three to seven business days. Three Day Select, Second-Day or Next-Day Air services may be requested. Poles over 92" MUST be shipped by common carrier. **For current common carrier freight rates and orders subject to actual freight costs, visit www.paristexashardware.com/freight-rate.** Shipments exceeding these limits will require a special freight quote. Expedited shipments are not available in all areas. Any additional charges for expedited shipments will be in addition to the published net fees. Orders that contain a Li-ion battery will be charged a \$25.00 shipping surcharge.

Packaging Fees (NET Fees)

A net packaging fee of \$10.00 per order will apply to any order that has a pole. A net packaging fee of \$10.00 will apply to any order with a traverse rod less than 16 feet. The net packaging fee increases to \$25.00 for all orders with rods with returns; motorized traverse track; or poles, rods and corded traversing track 16 feet or longer.

Damaged Goods & Freight Claims

Immediately upon receipt, your order should be inspected to ensure that there is no damage from shipping. To report a claim, contact your Paris Texas Hardware distributor. Damage and freight claims must be made within 15 days of receipt of goods. Claims reported after 15 days will not be accepted. To expedite the claim process, please provide your distributor with the following information: purchase order number, Paris Texas Hardware order number, shipping phone number and address, a complete list of damaged items and a picture of the box/packaging. Freight companies require all packaging materials and damaged items to be kept for inspection. Merchandise damaged in shipping will be replaced. Our policy is that we replace damaged product per the original order. Please note on the Bill of Lading if there is any possibility of damage. If shipping through a 3rd party, distributor is responsible for claiming damages and the remakes will be at charge.

Installation

We recommend using a professional installer. Installation hardware is included. The fasteners (screws and mollies) may not be appropriate for every installation or wall material. Brackets and holdbacks should be installed securely into wall studs when possible. Paris Texas Hardware will not assume responsibility for damages incurred by improperly mounted or inadequately supported hardware.

Portfolio Finishes	
AM	Amulet
AND	Andiron
AG	Antique Gold
AGL	Antique Gold Leaf
AB	Art Bronze
BW	Barnwood
BL	Black
BLU	Blush
BP	Bronzed Pewter
CO	Concrete
COU	Couture
DC	Dark Chocolate
FL	Firelight
GOS	Gossamer
GRE	Greige
HA	Halo
JA	Java
LIN	Linen
LU	Luminous
MA	Manor
MK	Mink
ML	Moonlight
MYS	Mystic
NAB	New Age Bronze
PAT	Patina
SH	Shimmer
SM	Silver Maple
SPW	Spicewood
SPG	Spun Gold
STA	Stardust
ST	Starlet
TTM	Titanium
TRU	Truffle
URB	Urban Bronze
WH	White
Quick Ship Wood & Resin 1 3/8" and 2 1/4" Finishes	
AB	Antique Brass
ORB	Oil Rubbed Bronze
PL	Platinum
RG	Rose Gold
WAL	Walnut
Quick Ship Metal 1 1/8" and 1 3/8" Finishes	
BZ	Brushed Bronze
BN	Brushed Nickel
CZ	Charcoal Zinc
MK	Matte Black
RGD	Rose Gold
SG	Satin Gold
PTH Perfect Match™ Finishes	
PPMEF	Eggshell Sheen Level
PPMHGF	High-Gloss Sheen Level
PPMGLITTER	Glitter Highlights
PPMGOLD	Gold Highlights
PPMROSEGOLD	Rose Gold Highlights
PPMSILVER	Silver Highlights

Finishes

Finishes with antiquing, dusting or glazing will vary from product to product depending on the level of detail. Areas with deeper recesses will appear darker than smooth areas.

For the best possible finish match, refer to the 2022 Paris Texas Hardware Finish Chips. These chips have smooth, fluted and carved detailed areas, enabling you to see the beautiful shadings and highlights that make our finishes so special.

Portfolio

Portfolio Strike-offs: For a fee of \$50 (net) per finish / strike-off, Paris Texas Hardware will provide a sample of your Portfolio finish on any 6" wood or metal pole as requested. Customer approval of the strike-off sample is required before production will begin.

Portfolio Touch up paint: For a fee of \$20 per vial, touch-up paint can be sent to the customer on request.

PTH Perfect Match™

On your purchase order, specify the following:

- Benjamin Moore® color name and number
- Sheen level: high-gloss or eggshell
- Highlight color, if desired (silver, gold, rose gold or glitter)

Each color specified (every time we purchase paint) will be subject to a separate minimum. If you have different colors for different rooms of hardware, please put them on separate purchase orders. Purchase includes 1 oz of touch-up paint. If there is enough of your Benjamin Moore® paint leftover, we'll keep it for 30 days. After 30 days, we'll dispose of it using an environmentally responsible paint service.

Single Color - No Highlight:

10% upcharge or \$100 minimum (net)

Strike-off available: For a fee of \$50 (net) per color, a sample of your Benjamin Moore® paint will be provided on a PTH sample chip. When you place your order, we will credit \$25 of this fee toward your order with that paint color.

Single Color - With Highlight:

15% upcharge or \$150 minimum (net)

Strike-off available: For a fee of \$60 (net) per color with highlight, a sample of your Benjamin Moore® paint with highlight will be provided on a PTH sample chip. When you place your order, we will credit \$30 of this fee toward your order with that paint color.

Order must be received within 30 days or strike-off paint will be disposed and no credit will be issued. In lieu of purchasing strike-offs, we encourage you to use your Benjamin Moore® paint deck for color reference.

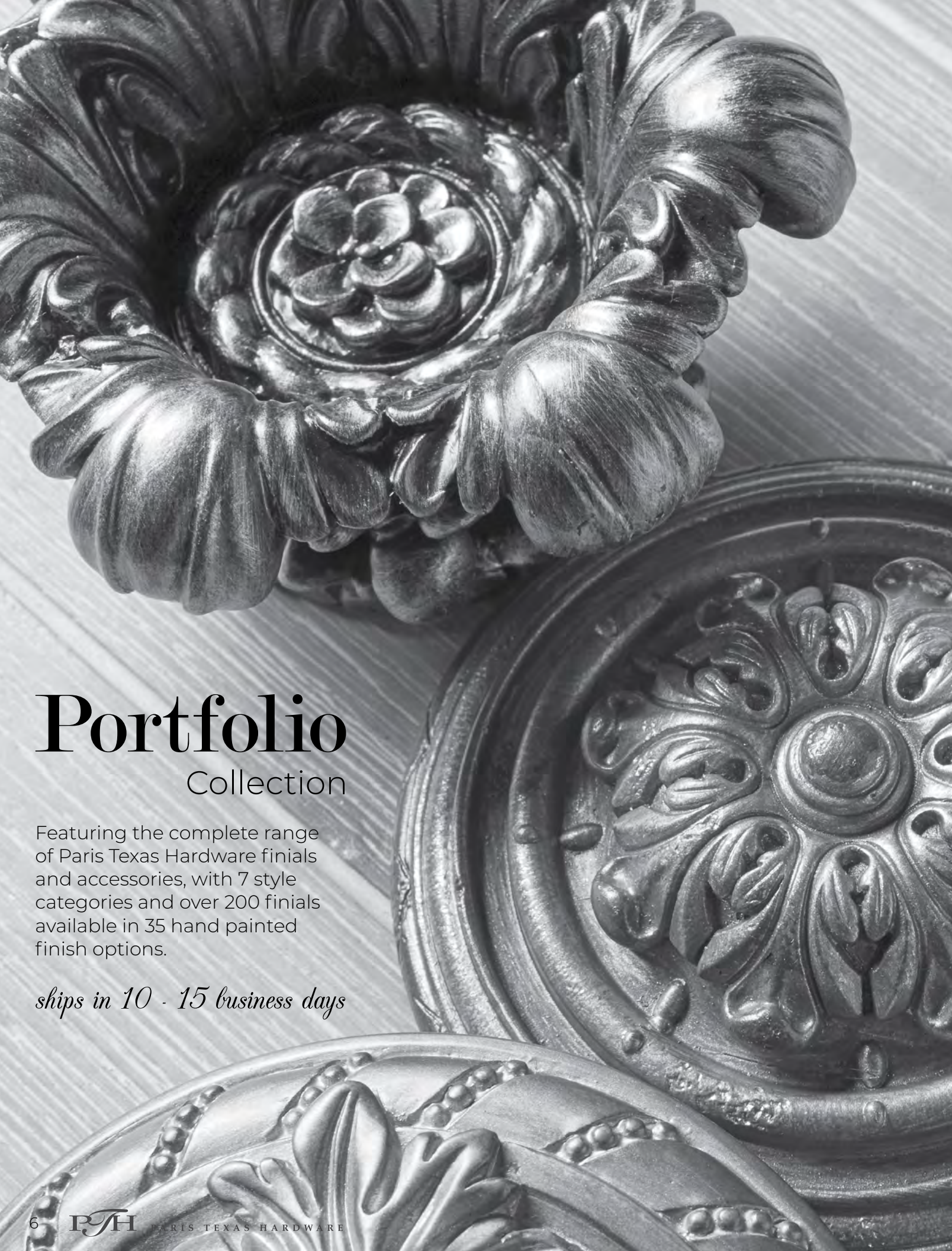











Portfolio

Collection

Featuring the complete range of Paris Texas Hardware finials and accessories, with 7 style categories and over 200 finials available in 35 hand painted finish options.

ships in 10 - 15 business days

1 1/8" Modern Finial Collection fits 1 1/8" poles. Finial adapters are required to adapt to 1 1/8" metal traverse, sold separately on page 10.

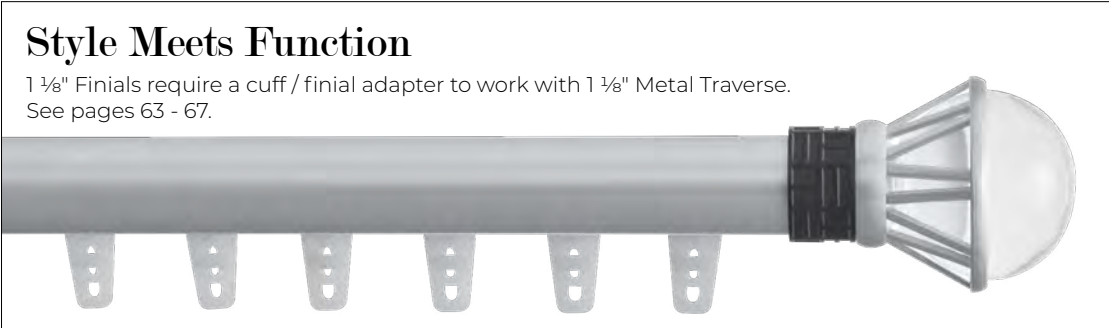
 PO118COFI Cole 3 3/4" L x 1 1/2" W Metal \$107.27 pair*	 PO118ELAFI Ella 1 5/8" L x 1 5/8" W Metal \$94.45 pair*	 PO118EMFI Elm 1 1/8" L x 2" W Metal \$94.45 pair*	 PO118EMFIGL Elm - Smoke Glass 1 1/8" L x 2" W Metal / Glass \$107.27 pair*	 PO118EMEC Emery End Cap 3/4" L x 1 1/4" W Metal \$39.64 pair*
 PO118EVEC Evan End Cap 3/4" L x 1 3/4" W Metal \$39.64 pair*	 PO118KNFI Knox - Crystal 1 1/4" L x 2 5/8" W Crystal, Metal Pole \$167.90 pair*	 PO118LXFI Lex 1 7/8" L x 2" W Metal \$94.45 pair*	 PO118LOFI London - Crystal 1 7/8" L x 3" W Metal / Crystal \$194.72 pair*	 PO118REFI Reese - Crystal 2 3/4" L x 2 1/2" W Crystal, Metal Pole \$167.90 pair*
 PO118RYFI Ryder - Crystal 1 3/4" L x 1 3/4" W Metal / Crystal \$167.90 pair*	<h3>Style Meets Function</h3> <p>1 1/8" Finials require a cuff / finial adapter to work with 1 1/8" Metal Traverse. See pages 63 - 67.</p> 			





1 1/8" Clean Deco Finial Collection fits 1 1/8" poles. Finial adapters are required to adapt to 1 1/8" metal traverse, sold separately on page 10.

 PO118ANFI Andes 2 1/2" L x 2 5/8" W Metal \$121.26 pair*	 PO118DAFI Dakota - Crystal 2 3/4" L x 2 1/2" W Metal / Crystal \$194.72 pair*	 PO118DEEC Deco End Cap 3/4" L x 1 3/8" W Metal \$39.64 pair*	 PO118NVFI Neve - Crystal 2 1/2" L x 2" W Metal / Crystal \$194.72 pair*	 PO118PEFI Penelope 1 1/8" L x 2 3/4" W Metal \$107.27 pair*
 PO118VIFI Viktor 1 1/2" L x 2 3/4" W Metal / Acrylic \$107.27 pair*	 PO118WRFI Wren 2" L x 1 7/8" W Metal \$107.27 pair*	 PO118WIFI Wright - Crystal 2 1/2" L x 2 3/4" W Metal / Crystal \$194.72 pair*	 PO118ZAE Zane End Cap 5/8" L x 2 3/8" W Metal \$53.64 pair*	

*Sold in pairs only.

1 1/8" Transitional Luxe Finial Collection fits 1 1/8" poles. Finial adapters are required to adapt to 1 1/8" metal traverse, sold separately on page 10.

 <p>PO118BEEC Beale End Cap 1/2" L x 2" W Resin \$46.64 pair*</p>	 <p>PO118CAFI Callie 1 1/2" L x 2 5/8" W Resin \$121.26 pair*</p>	 <p>PO118FBFI Fairbanks 3 1/4" L x 2" W Resin \$121.26 pair*</p>	 <p>PO118HUEC Hudson End Cap 7/8" L x 1 7/8" W Resin \$53.64 pair*</p>	 <p>PO118JUFI Jules 2 7/8" L x 2 3/4" W Resin \$121.26 pair*</p>
-------------------------------------------------------------------------------------------------------------------------------------------------------------------	--------------------------------------------------------------------------------------------------------------------------------------------------------------------	-------------------------------------------------------------------------------------------------------------------------------------------------------------------	--------------------------------------------------------------------------------------------------------------------------------------------------------------------------	---------------------------------------------------------------------------------------------------------------------------------------------------------------------

 <p>PO118KEFI Kensington - Crystal 2 5/8" L x 2 5/8" W Resin / Crystal \$194.72 pair*</p>	 <p>PO118NLFI Nola 2 3/4" L x 2 3/8" W Resin \$121.26 pair*</p>	 <p>PO118NOFI Nora 2 1/8" L x 2 3/8" W Metal \$107.27 pair*</p>	 <p>PO118NOFIGL Nora - Mercury Glass 2 1/8" L x 2 3/8" W Metal / Glass \$167.90 pair*</p>	 <p>PO118PIFI Piper 3 1/8" L x 2 5/8" W Resin / Glass \$167.90 pair*</p>
-------------------------------------------------------------------------------------------------------------------------------------------------------------------------------------------	------------------------------------------------------------------------------------------------------------------------------------------------------------------	------------------------------------------------------------------------------------------------------------------------------------------------------------------	---------------------------------------------------------------------------------------------------------------------------------------------------------------------------------------------	-----------------------------------------------------------------------------------------------------------------------------------------------------------------------------





See page 10 for our 1 1/8" Finial Accessories!

- Mix & Match finishes and materials for the ultimate customized style, or use to adapt your 1 1/8" Finial to work with Baton Draw Metal Traverse on pages 63 - 67
- Transitional Style » Transitional Cuff / Finial Adapter PO118CUFF
- Need Some Glamour? » Crystal Band PO118CRMEBAND
- Clean Deco Style » Deco Cuff / Finial Adapter PO118DECUFF

1 1/8" Bohemian Chic Finial Collection fits 1 1/8" poles. Finial adapters are required to adapt to 1 1/8" metal traverse, sold separately on page 10.



 <p>PO118ACFI Achilles 4 1/8" L x 1 7/8" W Resin \$121.26 pair*</p>	 <p>PO118ASFI Astor 1 3/8" L x 2 1/4" W Resin \$94.45 pair*</p>	 <p>PO118MOFI Monet 2 1/4" L x 2 7/8" W Resin \$107.27 pair*</p>	 <p>PO118NEFI Nerissa 4 1/2" L x 3 3/8" W Resin \$121.26 pair*</p>	 <p>PO118PAFI Patience 5 1/8" L x 5 1/2" W Metal \$121.26 pair*</p>
-----------------------------------------------------------------------------------------------------------------------------------------------------------------------	--------------------------------------------------------------------------------------------------------------------------------------------------------------------	---------------------------------------------------------------------------------------------------------------------------------------------------------------------	------------------------------------------------------------------------------------------------------------------------------------------------------------------------	--------------------------------------------------------------------------------------------------------------------------------------------------------------------------

 <p>PO118PHFI Phoebe 2 3/8" L x 3" W Resin / Glass \$167.90 pair*</p>	 <p>PO118TBFI Tybalt 2" L x 1 5/8" W Resin \$94.45 pair*</p>
-------------------------------------------------------------------------------------------------------------------------------------------------------------------------	-----------------------------------------------------------------------------------------------------------------------------------------------------------------

1 1/8" Rustic Retreat Finial Collection fits 1 1/8" poles. Finial adapters are required to adapt to 1 1/8" metal traverse, sold separately on page 10.

 <p>PO118AAFI Annabel 2" L x 2 1/2" W Resin</p> <p>\$107.27 pair*</p>	 <p>PO118AHFI Ash 3 1/4" L x 2 3/4" W Resin</p> <p>\$107.27 pair*</p>	 <p>PO118CHFI Cheyenne - Crystal 2 1/2" L x 2 1/2" W Metal / Crystal</p> <p>\$194.72 pair*</p>	 <p>PO118FIFI Finley 3" L x 2 1/4" W Resin</p> <p>\$107.27 pair*</p>	 <p>PO118KAFI Kane 2 1/2" L x 2 1/4" W Resin</p> <p>\$107.27 pair*</p>
 <p>PO118LEEC Lena End Cap 3/4" L x 1 1/2" W Resin</p> <p>\$53.64 pair*</p>	 <p>PO118RHF1 Rhea 2" L x 2 7/8" W Resin</p> <p>\$107.27 pair*</p>	 <p>PO118STFI Stowe 2 1/4" L x 3 3/8" W Resin</p> <p>\$107.27 pair*</p>		

1 1/8" French Returns fit the 1 1/8" pole. Look for coordinating brackets on pages 11 - 12 marked with the  icon. Also, check out our NEW French Returns for Traverse on page 67.

 <p>PO118MEFRS French Return with Square Mount Plate (Includes Pole Splice; Metal Pole sold separately on page 13) 3 1/2" return, 6 1/16" Elbow L, 2 3/16" backplate square, 3/8" plate thickness Metal</p> <p>\$87.45 pair*</p>	 <p>PO118MEFRR French Return with Round Mount Plate (Includes Pole Splice; Metal Pole sold separately on page 13) 3 1/2" return, 6 1/16" Elbow L, 2 3/16" backplate DIA, 3/8" plate thickness Metal</p> <p>\$87.45 pair*</p>	 <p>PO118MEFRBAND French Return Band Used to secure the drapery ensuring minimal light gap or to cover the seams of the pole. 1 1/8" ID, 1 3/8" OD Metal</p> <p>\$39.64 each</p>
--------------------------------------------------------------------------------------------------------------------------------------------------------------------------------------------------------------------------------------------------------------------------------------------------------------------------------------------	----------------------------------------------------------------------------------------------------------------------------------------------------------------------------------------------------------------------------------------------------------------------------------------------------------------------------------------	---------------------------------------------------------------------------------------------------------------------------------------------------------------------------------------------------------------------------------------------------------------------------------------------

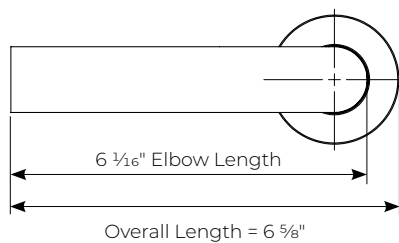
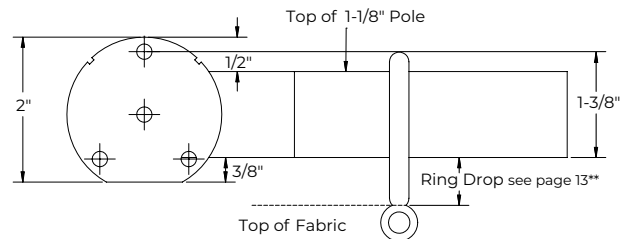
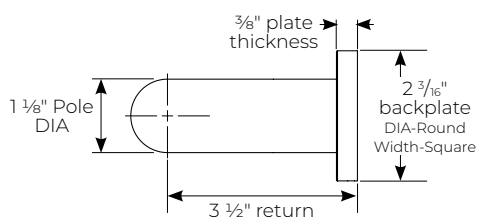

*Round Mount Plate shown; Square Mount Plate measurements are the same.

1 1/8" Mix & Match create an even more *customized* design!

 <p>PO118CUFF Transitional Cuff / Finial Adapter 3/4" L x 1 1/4" W Metal</p> <p>\$39.64 pair*</p>	 <p>PO118DECUFF Deco Cuff / Finial Adapter 3/4" L x 1 3/8" W Metal</p> <p>\$39.64 pair*</p>	 <p>PO118CRMEBAND Crystal Band 3/4" L x 1 1/4" W Dark Metal with Inlaid Crystals</p> <p>\$39.64 each</p>
------------------------------------------------------------------------------------------------------------------------------------------------------------------------------------------------	------------------------------------------------------------------------------------------------------------------------------------------------------------------------------------------	---------------------------------------------------------------------------------------------------------------------------------------------------------------------------------------------------------

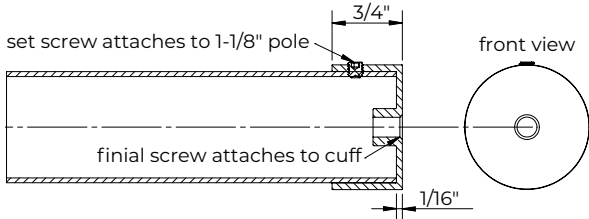

Transitional and Deco Cuffs / Finial Adapters

Style Meets Function

1 1/8" Baton Draw Metal Traverse Systems include End Caps, but are designed to work with all 1 1/8" Finials across five style categories using either Cuff / Finial Adapter. See pages 63 - 67.

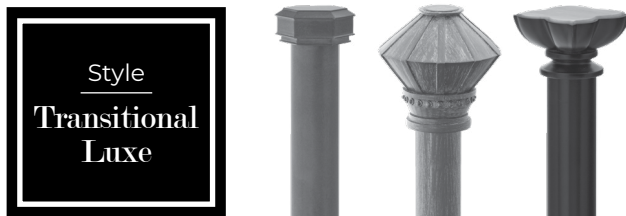
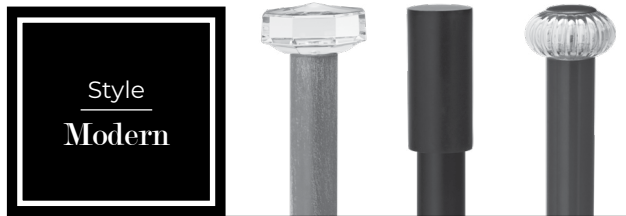

How To Add Your Cuff / Finial Adapter »

- 1** Select your Cuff style and finish - Mix & Match for the ultimate customization.

- 2** Place Cuff onto metal pole and tighten set screw with Allen Wrench.





- 3** Install finials by screwing into the Cuff / Finial Adapter.







1 1/8" Modern Metal Brackets fit the 1 1/8" pole.

Note: Return indicates distance from wall to center of pole.

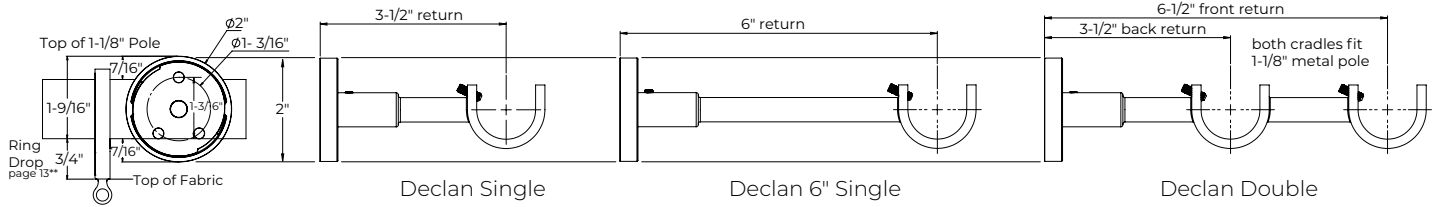
Look for coordinating brackets for French Returns marked with the  icon.





 <p>PO118DESBK  Declan Single</p> <p>2" DIA backplate, 3 1/2" return</p> <p>\$58.30 each</p>	 <p>PO118DES6BK Declan 6" Single</p> <p>2" DIA backplate, 6" return</p> <p>\$64.13 each</p>	 <p>PO118DEDBK Declan Double</p> <p>2" DIA backplate, 6 1/2" front return and 3 1/2" back return</p> <p>\$69.96 each</p>
--------------------------------------------------------------------------------------------------------------------------------------------------------------------------------------------------------------------------------------------------------------------	----------------------------------------------------------------------------------------------------------------------------------------------------------------------------------	-----------------------------------------------------------------------------------------------------------------------------------------------------------------------------------------------------------------

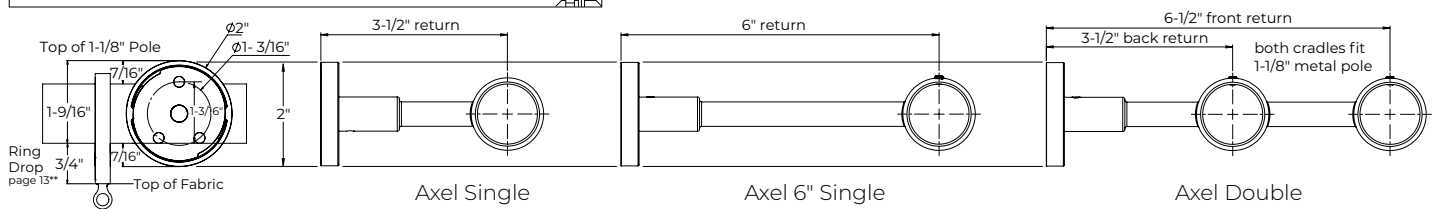

 <p>PO118AXSBK  Axel Single</p> <p>2" DIA backplate, 3 1/2" return</p> <p>\$58.30 each</p>	 <p>PO118AXS6BK Axel 6" Single</p> <p>2" DIA backplate, 6" return</p> <p>\$64.13 each</p>	 <p>PO118AXDBK Axel Double</p> <p>2" DIA backplate, 6 1/2" front return and 3 1/2" back return</p> <p>\$69.96 each</p>
------------------------------------------------------------------------------------------------------------------------------------------------------------------------------------------------------------------------------------------------------------------	--------------------------------------------------------------------------------------------------------------------------------------------------------------------------------	---------------------------------------------------------------------------------------------------------------------------------------------------------------------------------------------------------------

Designer Expertise » Use Axel Brackets for ceiling mount!



<p>Bypass Support Brackets Use with Caden C-Ring.</p> <p>*CAUTION: Aiden Brackets do not have full cradles. Self-threading screw installs through bottom of cradle and into 1 1/8" pole to secure it.</p> <p>Declan Brackets must be installed at each end to secure 1 1/8" pole.</p>	 <p>PO118AESBK  Aiden Single</p> <p>2" DIA backplate, 3 1/2" return, use with Caden C-Rings</p> <p>\$58.30 each</p>	 <p>PO118AEDBK Aiden Double</p> <p>2" DIA backplate, 6 1/2" front return and 3 1/2" back return, 9/16" clearance above backplate, use with Caden C-Rings</p> <p>\$69.96 each</p>	 <p>PO118IMBK Inside Mount</p> <p>1 13/16" DIA backplate x 1 1/4" D, 3/16" thick backplate per bracket</p> <p>\$69.96 pair*</p>
-------------------------------------------------------------------------------------------------------------------------------------------------------------------------------------------------------------------------------------------------------------------------------------------	-----------------------------------------------------------------------------------------------------------------------------------------------------------------------------------------------------------------------------------------------------------------------------------------------	--------------------------------------------------------------------------------------------------------------------------------------------------------------------------------------------------------------------------------------------------------------------------	--------------------------------------------------------------------------------------------------------------------------------------------------------------------------------------------------------------------------

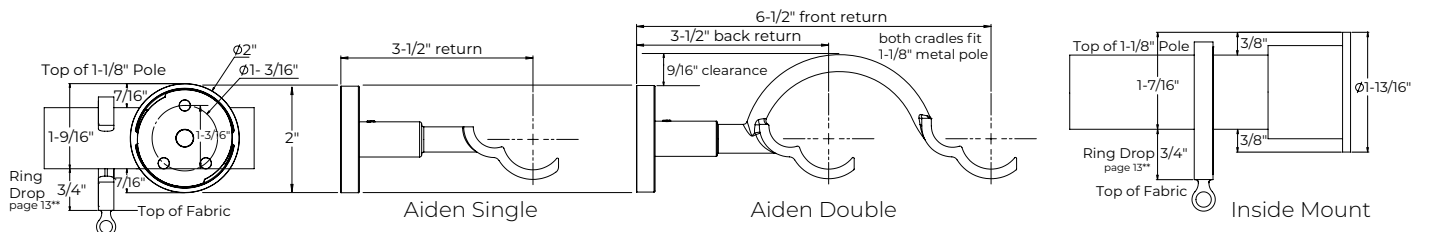

*Sold in pairs only.



1 1/8" Metal Brackets fit the 1 1/8" pole.

Note: Return indicates distance from wall to center of pole.



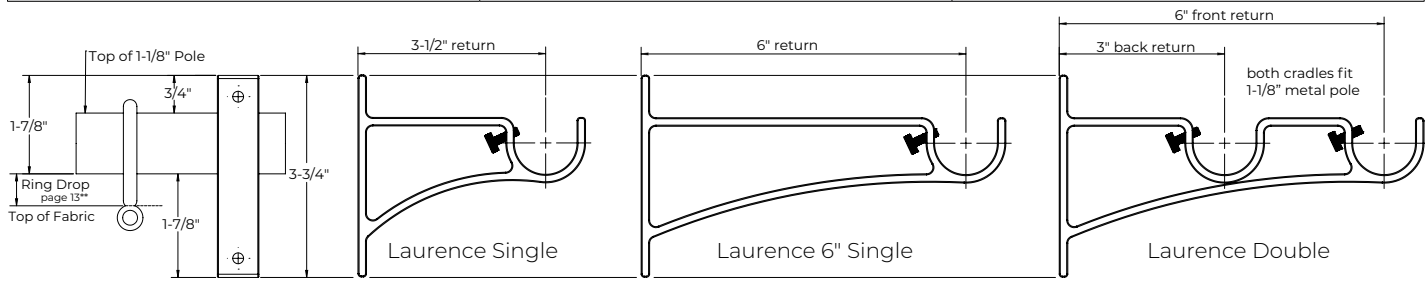

Look for coordinating brackets for French Returns marked with the FR icon.

 <p>POT18LASBK Laurence Single FR</p> <p>3/4" W x 3 3/4" H backplate, 3 1/2" return</p> <p>\$58.30 each</p>	 <p>POT18LAS6BK Laurence 6" Single</p> <p>3/4" W x 3 3/4" H backplate, 6" return</p> <p>\$64.13 each</p>	 <p>POT18LADBK Laurence Double</p> <p>3/4" W x 3 3/4" H backplate, 6" front return and 3" back return</p> <p>\$69.96 each</p>
---------------------------------------------------------------------------------------------------------------------------------------------------------------------------------------------------------	-----------------------------------------------------------------------------------------------------------------------------------------------------------------------------------------------	----------------------------------------------------------------------------------------------------------------------------------------------------------------------------------------------------------------------

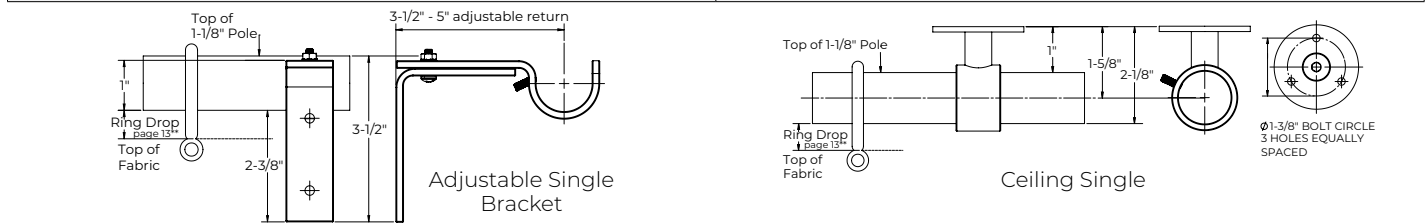

 <p>POBKT118 Adjustable Single Bracket FR</p> <p>1" W x 3 1/4" H backplate, 3 1/2" - 5" adjustable return</p> <p>\$58.30 each</p>	 <p>POT18MCMBK Ceiling Single</p> <p>2" DIA backplate, 1 5/8" drop</p> <p>\$58.30 each</p> <div style="border: 1px solid black; padding: 5px; width: fit-content;"> <p>Designer Expertise » </p> <p>Be sure to check the clearance to make sure your preferred finial works</p> </div>
-------------------------------------------------------------------------------------------------------------------------------------------------------------------------------------------------------------------------------	------------------------------------------------------------------------------------------------------------------------------------------------------------------------------------------------------------------------------------------------------------------------------------------------------------------------------------------------------------------------------------------------------------------------------------------------------------------



<p>Bypass Support Brackets Use with Small C-Ring.</p> <p>*CAUTION: Gregory Brackets do not have full cradles. Self-threading screw installs through bottom of cradle and into 1 1/8" pole to secure it.</p> <p>Laurence Brackets must be installed at each end to secure 1 1/8" pole.</p>	 <p>POT18GRSBK Gregory Single FR</p> <p>3/4" W x 3 3/4" H backplate, 3 1/2" return, use with Small C-Rings</p> <p>\$58.30 each</p>	 <p>POT18GRS6BK Gregory 6" Single</p> <p>3/4" W x 3 3/4" H backplate, 6" return, use with Small C-Rings</p> <p>\$64.13 each</p>	 <p>POT18GRDBK Gregory Double</p> <p>3/4" W x 3 3/4" H backplate, 6" front return and 3" back return, use with Small C-Rings</p> <p>\$69.96 each</p>	 <p>POT18GRSHBK Gregory Horizontal Single FR</p> <p>2 3/8" W x 3/4" H backplate, 3 1/2" return, use with Small C-Rings</p> <p>\$58.30 each</p>
-------------------------------------------------------------------------------------------------------------------------------------------------------------------------------------------------------------------------------------------------------------------------------------------	----------------------------------------------------------------------------------------------------------------------------------------------------------------------------------------------------------------------------------	------------------------------------------------------------------------------------------------------------------------------------------------------------------------------------------------------------------------	----------------------------------------------------------------------------------------------------------------------------------------------------------------------------------------------------------------------------------------------	------------------------------------------------------------------------------------------------------------------------------------------------------------------------------------------------------------------------------------------------

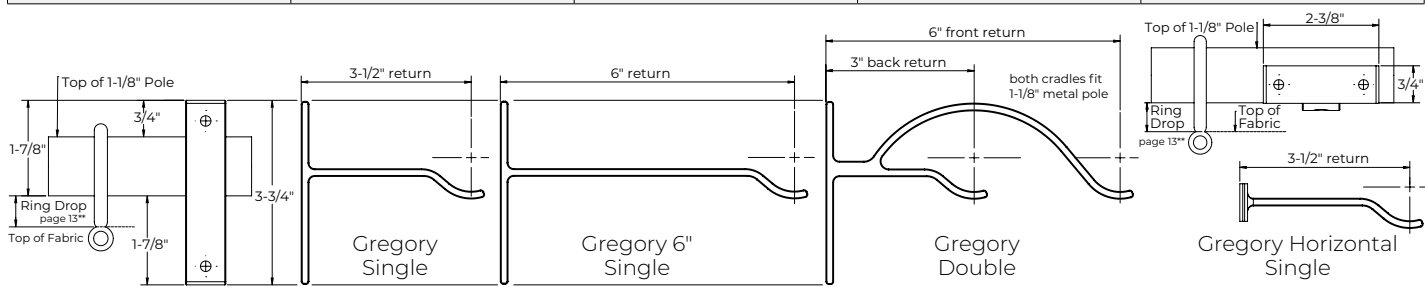

1 1/8" Metal Pole

1 1/8" metal poles are sold in 2' increments. 2' minimum. Poles will be cut to specified lengths; fall off will not be saved or shipped. Maximum continuous length up to 12'. 1 1/8" metal poles are supplied with plastic inserts to attach the finials.



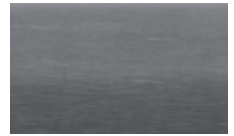

Note: All orders with poles and/or traverse track will incur a \$10.00 packaging fee per order.

PO118ME02 2'	PO118ME04 4'	PO118ME06 6'	PO118ME08 8'	PO118ME10 10'	PO118ME12 12'
\$33.81 each	\$67.63 each	\$101.44 each	\$135.26 each	\$169.07 each	\$202.88 each





1 1/8" Metal Rings fit the 1 1/8" pole.

Note: Ring drop indicates distance from bottom of pole to bottom of ring. A ring's drop changes on different diameter poles.**

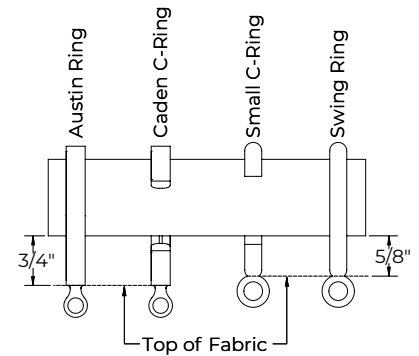
			
PO118SWRI Swing Ring 1 1/4" ID, 1 5/8" OD, 5/8" drop Metal	PO118SCRI Small C-Ring 1 1/4" ID, 1 5/8" OD, 5/8" drop, use with Gregory brackets Metal	PO118AURI Austin Ring 1 1/4" ID, 1 5/8" OD, 3/4" drop Metal	PO118CACRI Caden C-Ring 1 1/4" ID, 1 5/8" OD, 3/4" drop, use with Aiden brackets Metal
\$7.00 each	\$7.00 each	\$8.16 each	\$8.16 each



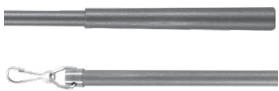

1 1/8" Metal Accessories

	
Metal Baton 3/8" DIA, Metal	Clear Acrylic Baton 1/2" DIA, Acrylic
POME36WAND - 36" - \$66.46 each	AC36WAND - 36" - \$52.47 each
POME48WAND - 48" - \$72.29 each	AC48WAND - 48" - \$58.30 each
POME60WAND - 60" - \$78.12 each	AC60WAND - 60" - \$64.13 each



PO118MEL Hinged Elbow
1 1/8" DIA, 2 7/8" overall length, 1 3/4" L each side when bent
Metal

\$53.64 each

	
Handicap Metal Baton 4" Loop, ADA Compliant, Metal	Handicap Clear Acrylic Baton 4" Loop, ADA Compliant, Acrylic
POME48HWAND - 48" - \$72.29 each	AC48HWAND - 48" - \$58.30 each
POME60HWAND - 60" - \$78.12 each	AC60HWAND - 60" - \$64.13 each
	AC72HWAND - 72" - \$69.96 each



PSME118403 Pole Splice
4 5/8" L, must be ordered separately



\$5.83 each

1 3/8" Modern Finial Collection fits the 1 3/8" metal pole and metal traverse.

 <p>PO138ADFI</p> <p>Adair</p> <p>3 3/8" L x 3" W Metal</p> <p>\$107.27 pair*</p>	 <p>PO138AIEC</p> <p>Ainsley End Cap</p> <p>3/4" L x 1 1/2" W Metal</p> <p>\$46.64 pair*</p>	 <p>PO138ASEC</p> <p>Asher End Cap</p> <p>1" L x 2 1/4" W Metal</p> <p>\$46.64 pair*</p>	 <p>PO138COFI</p> <p>Cohen</p> <p>1 7/8" L x 3 3/8" W Metal / Clear Acrylic</p> <p>\$221.54 pair*</p>	 <p>PO138EXFI</p> <p>Exton</p> <p>2 3/4" L x 2 1/4" W Metal</p> <p>\$107.27 pair*</p>
 <p>PO138LOFI</p> <p>London - Crystal</p> <p>2 5/8" L x 3 3/8" W Metal / Crystal</p> <p>\$233.20 pair*</p>	 <p>PO138QUFI</p> <p>Quinn</p> <p>1 3/4" L x 2 1/4" W Metal</p> <p>\$107.27 pair*</p>	 <p>PO138REFI</p> <p>Remi - Crystal</p> <p>3 1/4" L x 3" W Metal / Crystal</p> <p>\$209.88 pair*</p>	 <p>PO138STFI</p> <p>Sterling - Crystal</p> <p>2 1/4" L x 3" W Metal / Crystal</p> <p>\$209.88 pair*</p>	 <p>PO138ZAFI</p> <p>Zara</p> <p>2 1/2" L x 3 1/2" W Metal / Clear Acrylic</p> <p>\$233.20 pair*</p>

1 3/8" French Returns fit the 1 3/8" pole. Look for coordinating brackets on pages 15 & 19 marked with the **FR** icon.

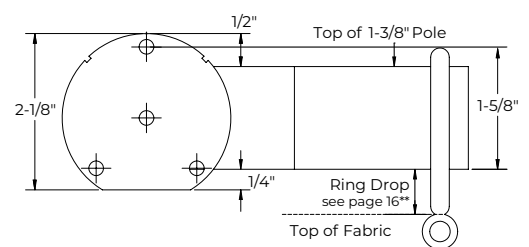
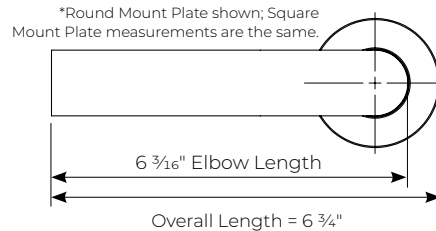
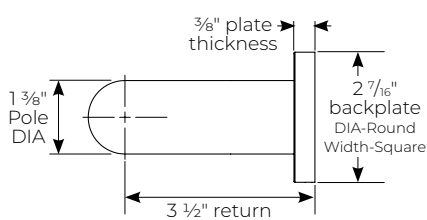

Also, check out our NEW French Returns for Traverse on pages 40 & 72.

 <p>PO138MEFRS</p> <p>French Return with Square Mount Plate (Includes Pole Splice; Metal Pole sold separately on page 16)</p> <p>3 1/2" return, 6 3/16" Elbow L, 2 7/16" backplate square, 3/8" plate thickness Metal</p> <p>\$99.11 pair*</p>	 <p>PO138MEFRR</p> <p>French Return with Round Mount Plate (Includes Pole Splice; Metal Pole sold separately on page 16)</p> <p>3 1/2" return, 6 3/16" Elbow L, 2 7/16" backplate DIA-Round, 3/8" plate thickness Metal</p> <p>\$99.11 pair*</p>	 <p>PO138MEFRBAND</p> <p>French Return Band Used to secure the drapery ensuring minimal light gap or to cover the seams of the pole.</p> <p>1 7/16" ID, 1 5/8" OD Metal</p> <p>\$45.47 each</p>
-------------------------------------------------------------------------------------------------------------------------------------------------------------------------------------------------------------------------------------------------------------------------------------------------------------------------------------------------	----------------------------------------------------------------------------------------------------------------------------------------------------------------------------------------------------------------------------------------------------------------------------------------------------------------------------------------------------	-----------------------------------------------------------------------------------------------------------------------------------------------------------------------------------------------------------------------------------------------------------------------------------------------------



1 3/8" Modern Metal Brackets fit the 1 3/8" pole.

Note: Return indicates distance from wall to center of pole. Look for coordinating brackets for French Returns marked with the FR icon.

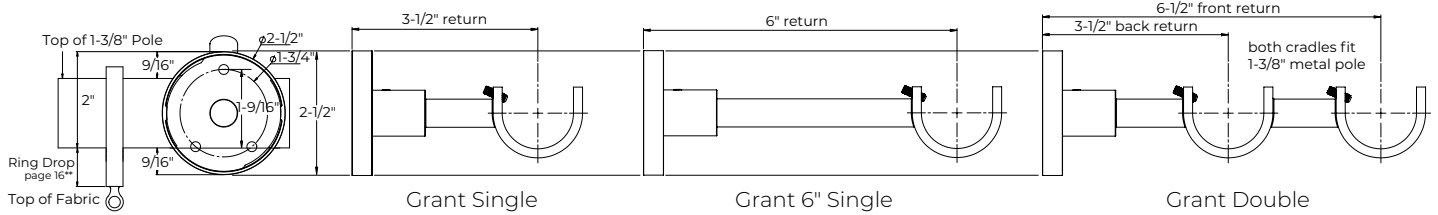

 <p>PO138GASBK Grant Single FR</p> <p>2 1/2" DIA backplate, 3 1/2" return</p> <p>\$64.13 each</p>	 <p>PO138GAS6BK Grant 6" Single</p> <p>2 1/2" DIA backplate, 6" return</p> <p>\$69.96 each</p>	 <p>PO138GADBK Grant Double</p> <p>2 1/2" DIA backplate, 6 1/2" front return and 3 1/2" back return</p> <p>\$75.79 each</p>
-----------------------------------------------------------------------------------------------------------------------------------------------------------------------------------------------	-------------------------------------------------------------------------------------------------------------------------------------------------------------------------------------	--------------------------------------------------------------------------------------------------------------------------------------------------------------------------------------------------------------------

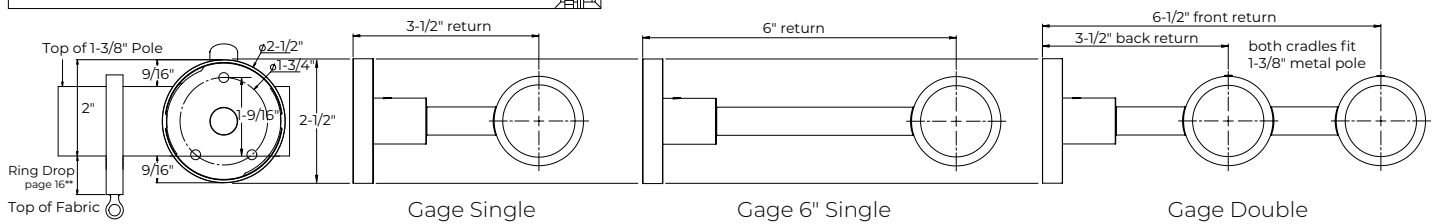

 <p>PO138GGSBK Gage Single FR</p> <p>2 1/2" DIA backplate, 3 1/2" return</p> <p>\$64.13 each</p>	 <p>PO138GGS6BK Gage 6" Single</p> <p>2 1/2" DIA backplate, 6" return</p> <p>\$69.96 each</p>	 <p>PO138GGDBK Gage Double</p> <p>2 1/2" DIA backplate, 6 1/2" front return and 3 1/2" back return</p> <p>\$75.79 each</p>
----------------------------------------------------------------------------------------------------------------------------------------------------------------------------------------------	------------------------------------------------------------------------------------------------------------------------------------------------------------------------------------	-------------------------------------------------------------------------------------------------------------------------------------------------------------------------------------------------------------------

Designer Expertise » Use Gage Brackets for ceiling mount!



<p>Bypass Support Brackets Use with Calla C-Ring.</p> <p>*CAUTION: Talon Brackets do not have full cradles. Self-threading screw installs through bottom of cradle and into 1 3/8" pole to secure it.</p> <p>Grant Brackets must be installed at each end to secure 1 3/8" pole.</p>	 <p>PO138TASBK Talon Single FR</p> <p>2 1/2" DIA backplate, 3 1/2" return, use with Calla C-Rings</p> <p>\$64.13 each</p>	 <p>PO138TADBK Talon Double</p> <p>2 1/2" DIA backplate, 6 1/2" front return and 3 1/2" back return, 3/8" clearance above backplate, use with Calla C-Rings</p> <p>\$75.79 each</p>	 <p>PO138IMBK Inside Mount</p> <p>2" DIA backplate x 1 9/16" D, 1/4" thick backplate per bracket</p> <p>\$75.79 pair*</p>
------------------------------------------------------------------------------------------------------------------------------------------------------------------------------------------------------------------------------------------------------------------------------------------	-------------------------------------------------------------------------------------------------------------------------------------------------------------------------------------------------------------------------	-----------------------------------------------------------------------------------------------------------------------------------------------------------------------------------------------------------------------------------------------------------------------------	--------------------------------------------------------------------------------------------------------------------------------------------------------------------------------------------------------------------

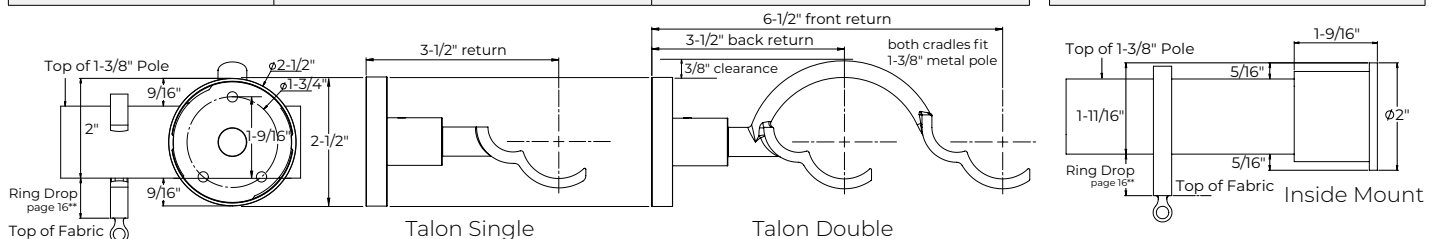

*Sold in pairs only.

1 3/8" Metal Pole | 1 3/8" Acrylic Pole

1 3/8" metal poles are sold in 2' increments, 2' minimum. Poles will be cut to specified lengths; fall off will not be saved or shipped. Maximum continuous length up to 12'. 1 3/8" metal poles are supplied with plastic inserts to attach wood & resin finials, if desired. Acrylic poles only work with the 1 3/8" Modern Finial Collection.

Note: All orders with poles and/or traverse track will incur a \$10.00 packaging fee per order.

PO138ME02	PO138ME04	PO138ME06	PO138ME08	PO138ME10	PO138ME12
2'	4'	6'	8'	10'	12'
\$40.81 each	\$81.62 each	\$122.43 each	\$163.24 each	\$204.05 each	\$244.86 each

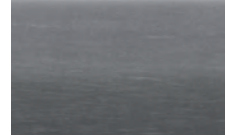



PO138AC02	PO138AC04	PO138AC06	PO138AC08	PO138AC10	PO138AC12
2'	4'	6'	8'	10'	12'
\$89.78 each	\$179.56 each	\$269.35 each	\$359.13 each	\$448.91 each	\$538.69 each





1 3/8" Metal Rings fit the 1 3/8" pole.

Note: Ring drop indicates distance from bottom of pole to bottom of ring. A ring's drop changes on different diameter poles.**

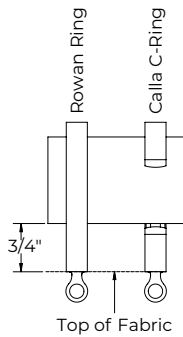

	
PO138RORI Rowan Ring	PO138CLCRI Calla C-Ring
2" ID, 2 3/8" OD, 3/4" drop Metal	2" ID, 2 3/8" OD, 3/4" drop, use with Talon brackets Metal
\$8.75 each	\$8.75 each

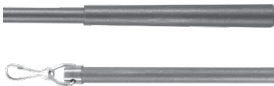

1 3/8" Metal Accessories

	
Metal Baton	Clear Acrylic Baton
3/8" DIA, Metal	1/2" DIA, Acrylic
POME36WAND - 36" - \$66.46 each	AC36WAND - 36" - \$52.47 each
POME48WAND - 48" - \$72.29 each	AC48WAND - 48" - \$58.30 each
POME60WAND - 60" - \$78.12 each	AC60WAND - 60" - \$64.13 each

PO138MEL Hinged Elbow
1 3/8" DIA, 2 7/8" overall length, 2" L each side when bent Metal
\$59.47 each

	
Handicap Metal Baton	Handicap Clear Acrylic Baton
4" Loop, ADA Compliant, Metal	4" Loop, ADA Compliant, Acrylic
POME48HWAND - 48" - \$72.29 each	AC48HWAND - 48" - \$58.30 each
POME60HWAND - 60" - \$78.12 each	AC60HWAND - 60" - \$64.13 each
	AC72HWAND - 72" - \$69.96 each

PSME138403 Pole Splice
4 3/4" L, must be ordered separately
\$8.16 each

1 3/8" Today's Traditional Finial Collection fits the 1 3/8" wood poles and heavy duty traverse.

				
PO138AUEC Aubrie End Cap 3/4" L x 2 1/4" W Resin	PO138BRFI Bradford 3 1/4" L x 2 3/4" W Resin	PO138ESEC Essex End Cap 3/4" L x 2" W Resin	PO138EVFI Everette 2 7/8" L x 3 1/4" W [2 1/2" square] Resin	PO138JUFI June 2 3/4" L x 2 5/8" W Resin
\$53.64 pair*	\$109.60 pair*	\$53.64 pair*	\$109.60 pair*	\$109.60 pair*

				
PO138LEFI Leo 3 1/2" L x 2 3/4" W Resin	PO138LIFI Lillian 4" L x 3 3/8" W Resin	PO138LIFIGL Lillian - Mercury Glass 4" L x 3 3/8" W Resin / Glass	PO138LYFI Lyla 2 5/8" L x 2 3/4" W Resin	PO138ROFI Rose - Crystal 2 1/2" L x 2 3/4" W Resin / Crystal
\$109.60 pair*	\$109.60 pair*	\$180.20 pair*	\$109.60 pair*	\$244.86 pair*

1 3/8" Heritage Classics Finial Collection fits the 1 3/8" wood poles and heavy duty traverse.

				
PO138AEFI Adele 3 5/8" L x 2 5/8" W Metal / Glass	PO138AMFI Amboise 5 1/4" L x 2 7/8" W Resin	PO138AVFI Avon 3 5/8" L x 3 3/4" W Resin	PO138BYFI Blythe 3 5/8" L x 2 7/8" W Metal / Glass	PO138BLFI Brielle 4" L x 3" W Resin
\$244.86 pair*	\$109.60 pair*	\$109.60 pair*	\$244.86 pair*	\$109.60 pair*

				
PO138GSFI Gaston 3 5/8" L x 3 3/8" W Resin	PO138HAFI Harper 3" L x 2 3/4" W Resin	PO138LAFI Lane 3 5/8" L x 3 1/2" W Resin	PO138LOEC Lowell End Cap 1" L x 2" W Resin	PO138SEFI Severn 3 3/4" L x 3" W Resin
\$109.60 pair*	\$109.60 pair*	\$109.60 pair*	\$53.64 pair*	\$109.60 pair*



1 3/8" Transitional Cuff / Finial Adapter PO138CUFF

See next page for more details

· 3/4" L x 1 1/2" W

- Metal, Available in any of our 35 Portfolio Hand Painted Finishes or PTH Perfect Match™
- Mix & Match finishes and materials for the ultimate customized style, or use to adapt your 1 3/8" Today's Traditional or Heritage Classics Finial to work with R-TEC Automation® Metal Traverse on pages 32 - 41 and Baton Draw Metal Traverse on pages 68 - 73. Finial Adapters required, sold separately.

\$45.47 pair*

*Sold in pairs only.

1 3/8" Mix & Match create an even more customized design!



POI38CUFF
Transitional Cuff / Finial Adapter

3/4" L x 1 1/2" W

- Metal, Available in any of our 35 Portfolio Hand Painted Finishes or PTH Perfect Match™
- Use to adapt your 1 3/8" Today's Traditional or Heritage Classics Finial to work with Metal Traverse (required)

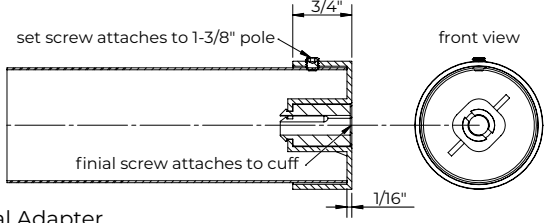

set screw attaches to 1-3/8" pole
finial screw attaches to cuff

front view

Style Meets Function



Rose - Crystal Finial with Transitional Cuff

\$45.47 pair*

1 3/8" R-TEC and Baton Draw Metal Traverse Systems include End Caps, but are designed to work with all 1 3/8" Finials across three style categories. Today's Traditional and Heritage Classics Finials require the use of the Transitional Cuff / Finial Adapter to work with Metal Traverse. Modern Finials do not require the use of the Finial Adapter.



*Transitional Cuff / Finial Adapter POI38CUFF not required with Metal Traverse Systems on pages 32 - 41 and 68 - 73



*Requires Transitional Cuff / Finial Adapter POI38CUFF to work with Metal Traverse Systems on pages 32 - 41 and 68 - 73



*Requires Transitional Cuff / Finial Adapter POI38CUFF to work with Metal Traverse Systems on pages 32 - 41 and 68 - 73

How To Add Your Transitional Cuff / Finial Adapter »



1 Select your Cuff style and finish - Mix & Match for the ultimate customization.





2 Place Cuff onto metal traverse and tighten set screw with Allen Wrench.





3 Install finials by screwing into the Cuff / Finial Adapter.

1 3/8" Metal Brackets fit the 1 3/8" wood poles.

Note: Return indicates distance from wall to center of pole. Look for coordinating brackets for French Returns marked with the FR icon.

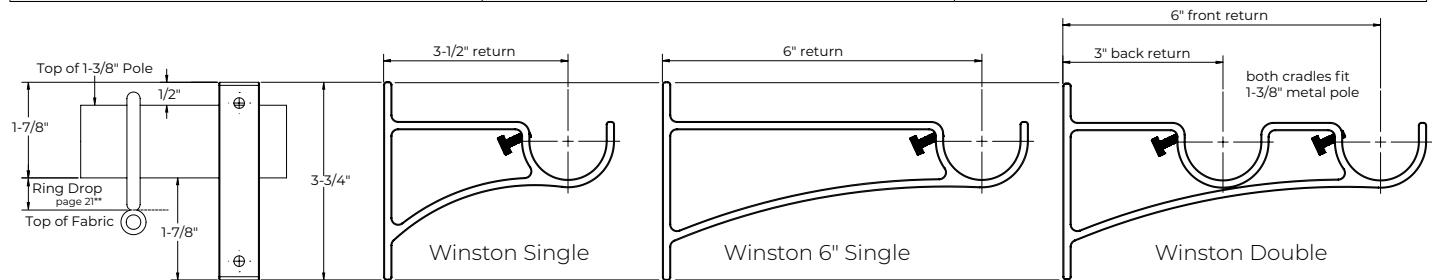
 <p>PO138WSSBK Winston Single FR</p> <p>3/4" W x 3 3/4" H backplate, 3 1/2" return</p> <p style="text-align: center;">\$64.13 each</p>	 <p>PO138WSS6BK Winston 6" Single</p> <p>3/4" W x 3 3/4" H backplate, 6" return</p> <p style="text-align: center;">\$69.96 each</p>	 <p>PO138WSDBK Winston Double</p> <p>3/4" W x 3 3/4" H backplate, 6" front return and 3" back return</p> <p style="text-align: center;">\$75.79 each</p>
----------------------------------------------------------------------------------------------------------------------------------------------------------------------------------------------------------------------------------------------------------------------------------------------------------------------	------------------------------------------------------------------------------------------------------------------------------------------------------------------------------------------------------------------------------------	-----------------------------------------------------------------------------------------------------------------------------------------------------------------------------------------------------------------------------------------------------------

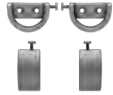

 <p>POBKT138 Adjustable Single Bracket FR</p> <p>1" W x 3 1/4" H backplate, 3 1/2" - 5" adjustable return</p> <p style="text-align: center;">\$64.13 each</p>	 <p>PO138MCMBK Ceiling Single</p> <p>2 3/4" H, 2" DIA backplate, 2 5/8" drop</p> <p style="text-align: center;">\$64.13 each</p>	 <p>PO138MIBK Inside Mount</p> <p>1" W x 1 1/4" H x 1 7/8" D, 1/4" thick backplate per bracket</p> <p style="text-align: center;">\$93.28 pair*</p>
---------------------------------------------------------------------------------------------------------------------------------------------------------------------------------------------------------------------------------------------------------------------------------------------------------------------------------------------	---------------------------------------------------------------------------------------------------------------------------------------------------------------------------------------------------------------------------------	------------------------------------------------------------------------------------------------------------------------------------------------------------------------------------------------------------------------------------------------------

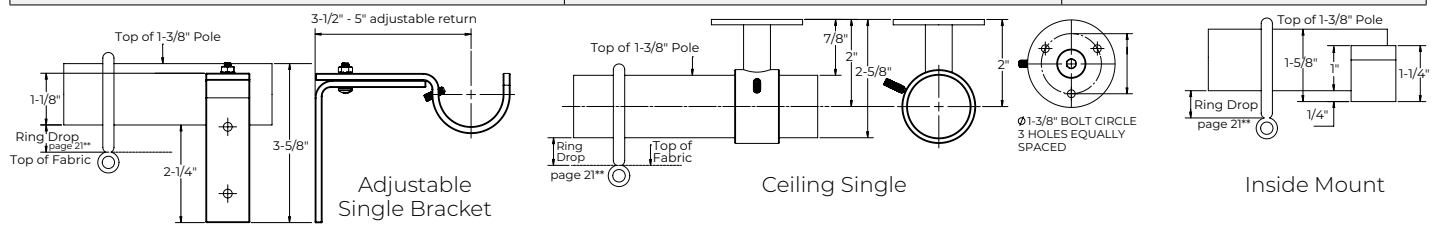

<p>Bypass Support Brackets Use with Medium C-Ring.</p> <p>*CAUTION: Gregory Brackets do not have full cradles. Self-threading screw installs through bottom of cradle and into 1 3/8" pole to secure it.</p> <p>Winston Brackets must be installed at each end to secure 1 3/8" pole.</p>	 <p>PO138GRSBK Gregory Single FR</p> <p>3/4" W x 3 3/4" H backplate, 3 1/2" return, use with Medium C-Rings</p> <p style="text-align: center;">\$64.13 each</p>	 <p>PO138GRS6BK Gregory 6" Single</p> <p>3/4" W x 3 3/4" H backplate, 6" return, use with Medium C-Rings</p> <p style="text-align: center;">\$69.96 each</p>	 <p>PO138GRDBK Gregory Double</p> <p>3/4" W x 3 3/4" H backplate, 6" front return and 3" back return, use with Medium C-Rings</p> <p style="text-align: center;">\$75.79 each</p>	 <p>PO138GRSHBK Gregory 3 1/2" Horizontal Single FR</p> <p>2 3/8" W x 3/4" H backplate, 3 1/2" return, use with Medium C-Rings</p> <p style="text-align: center;">\$64.13 each</p>
------------------------------------------------------------------------------------------------------------------------------------------------------------------------------------------------------------------------------------------------------------------------------------------------------	-------------------------------------------------------------------------------------------------------------------------------------------------------------------------------------------------------------------------------------------------------------------------------------------------------------------------------------------------	---------------------------------------------------------------------------------------------------------------------------------------------------------------------------------------------------------------------------------------------------------------	--------------------------------------------------------------------------------------------------------------------------------------------------------------------------------------------------------------------------------------------------------------------------------------	----------------------------------------------------------------------------------------------------------------------------------------------------------------------------------------------------------------------------------------------------------------------------------------------------------------------------------------------------------------------

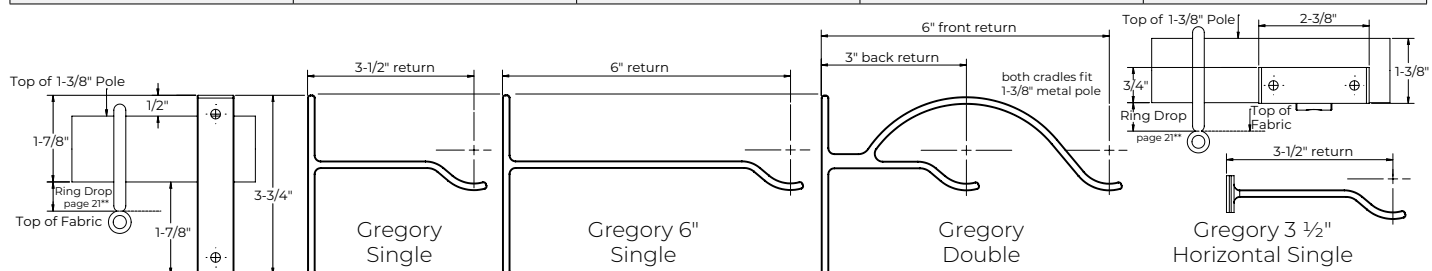

*Sold in pairs only.

1 ³/₈" Wood & Resin Brackets fit the 1 ³/₈" wood poles.

Note: Return indicates distance from wall to center of pole.

 <p>PO138WISBK William Single</p> <p>1" W x 3 ⁷/₁₆" H backplate, 3 ⁵/₈" return, Resin</p> <p>\$64.13 each</p>	 <p>PO138WIS6BK William 6 ⁵/₈" Single</p> <p>1" W x 3 ⁷/₁₆" H backplate, 6 ⁵/₈" return, Resin</p> <p>\$69.96 each</p>	 <p>PO138WIDBK William Double</p> <p>1" W x 3 ⁷/₁₆" H backplate, 6 ¹/₂" front return and 3 ¹/₄" back return, Resin</p> <p>\$75.79 each</p>
-------------------------------------------------------------------------------------------------------------------------------------------------------------------------------------------------------------------------------------------------------	-------------------------------------------------------------------------------------------------------------------------------------------------------------------------------------------------------------------------------------------------------------------------------------	------------------------------------------------------------------------------------------------------------------------------------------------------------------------------------------------------------------------------------------------------------------------------------------------------------

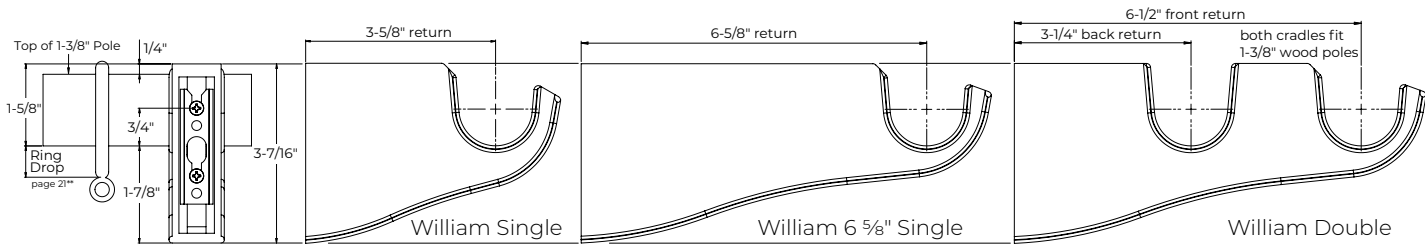

 <p>PO138SHBK Shelburne Single</p> <p>1 ³/₈" W x 4 ¹/₈" H backplate, 3 ¹/₂" return, Resin</p> <p>\$69.96 each</p>	 <p>PO138GRBK Grace Single</p> <p>1 ³/₈" W x 7 ³/₈" H backplate, 3 ⁵/₈" return, Resin</p> <p>\$75.79 each</p>	 <p>PO138WOJCBK Ceiling Single</p> <p>1 ³/₄" W x 4 ¹/₄" D x ¹/₂" H backplate, 3 ¹/₄" drop, Wood</p> <p>\$75.79 each</p>	 <p>PO138WOIBK Inside Mount</p> <p>1 ³/₈" W, 1 ¹³/₁₆" H, 1 ¹³/₁₆" D, ¹³/₁₆" thick backplate per bracket Wood</p> <p>\$75.79 pair*</p>
----------------------------------------------------------------------------------------------------------------------------------------------------------------------------------------------------------------------------------------------------------------------------------	------------------------------------------------------------------------------------------------------------------------------------------------------------------------------------------------------------------------------------------------------------------------------	---------------------------------------------------------------------------------------------------------------------------------------------------------------------------------------------------------------------------------------------------------------------------------------------------------------	------------------------------------------------------------------------------------------------------------------------------------------------------------------------------------------------------------------------------------------------------------------------------------------------------------------------------

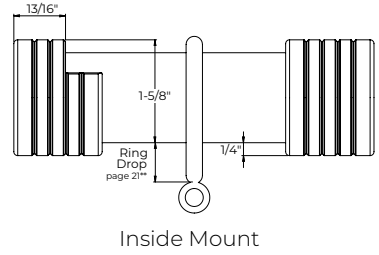
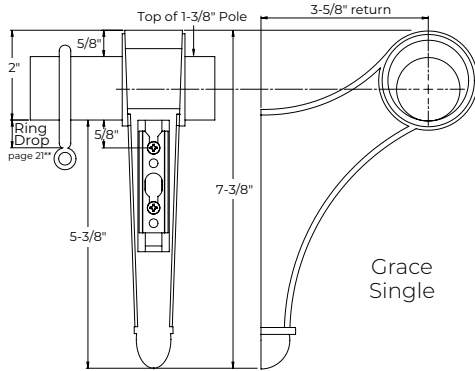
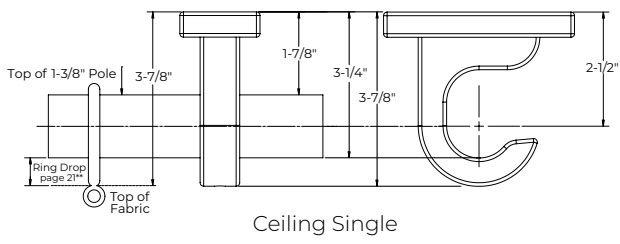
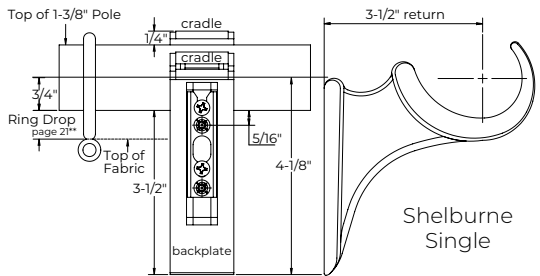

*Sold in pairs only.

1 3/8" Wood Poles

1 3/8" wood poles are sold in 2' increments. 2' minimum. Poles will be cut to specified lengths; fall off will not be saved or shipped. Maximum continuous length up to 16'.

Note: All orders with poles and/or traverse track will incur a \$10.00 packaging fee per order.

PO138SM02 Smooth - 2'	PO138SM04 Smooth - 4'	PO138SM06 Smooth - 6'	PO138SM08 Smooth - 8'	PO138SM10 Smooth - 10'	PO138SM12 Smooth - 12'	PO138SM14 Smooth - 14'	PO138SM16 Smooth - 16'
\$69.96 each	\$139.92 each	\$209.88 each	\$279.84 each	\$349.80 each	\$419.76 each	\$489.72 each	\$559.68 each
PO138GR02 Grooved / Fluted - 2'	PO138GR04 Grooved / Fluted - 4'	PO138GR06 Grooved / Fluted - 6'	PO138GR08 Grooved / Fluted - 8'	PO138GR10 Grooved / Fluted - 10'	PO138GR12 Grooved / Fluted - 12'	PO138GR14 Grooved / Fluted - 14'	PO138GR16 Grooved / Fluted - 16'
\$69.96 each	\$139.92 each	\$209.88 each	\$279.84 each	\$349.80 each	\$419.76 each	\$489.72 each	\$559.68 each
PO138RE02 Reeded - 2'	PO138RE04 Reeded - 4'	PO138RE06 Reeded - 6'	PO138RE08 Reeded - 8'	PO138RE10 Reeded - 10'	PO138RE12 Reeded - 12'	PO138RE14 Reeded - 14'	PO138RE16 Reeded - 16'
\$69.96 each	\$139.92 each	\$209.88 each	\$279.84 each	\$349.80 each	\$419.76 each	\$489.72 each	\$559.68 each

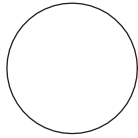

Smooth

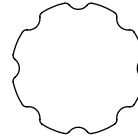

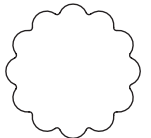

Grooved / Fluted



Reeded

1 3/8" Wood & Metal Rings fit the 1 3/8" wood poles.

Note: Ring drop indicates distance from bottom of pole to bottom of ring. A ring's drop changes on different diameter poles.**

 PO138WRI Wood Ring 1 3/4" ID, 2 5/8" OD, 3/4" drop Wood	 PO138MRI Metal Ring 1 3/4" ID, 2 1/4" OD, 5/8" drop Metal	 PO138MCRI Medium C-Ring 2" ID, 2 3/8" OD, 3/4" drop, use with Gregory brackets Metal
\$10.49 each	\$9.33 each	\$9.33 each

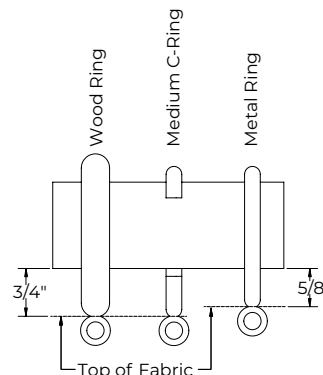

EZ Glide Tape

Included with pole order. Allows rings and grommets to slide effortlessly across the drapery rod without damaging the finish.









1 3/8" Accessories

 Fiberglass Baton 3/8" DIA, Fiberglass	 Clear Acrylic Baton (for Handicap, see page 16) 1/2" DIA, Acrylic
PORE36WAND - 36" - \$67.63 each	AC36WAND - 36" - \$52.47 each
PORE48WAND - 48" - \$73.46 each	AC48WAND - 48" - \$58.30 each
PORE60WAND - 60" - \$79.29 each	AC60WAND - 60" - \$64.13 each

 PO138REL Hinged Elbow 1 5/8" DIA, 3 7/8" OL, 2" L each side when bent Resin
\$53.64 each



2 1/4" Today's Traditional Finial Collection fits the 2 1/4" wood poles and heavy duty traverse.

 <p>PO214AMFI Amelie 2" L x 3 1/4" W Resin \$121.26 pair*</p>	 <p>PO214AMFIGL Amelie - Glass 2" L x 3 1/4" W Resin / Glass \$209.88 pair*</p>	 <p>PO214APFI Aspen 4 1/2" L x 4 1/2" W Resin \$135.26 pair*</p>	 <p>PO214APFIGL Aspen - Glass 4 1/2" L x 4 1/2" W Resin / Glass \$209.88 pair*</p>	 <p>PO214EDFI Edward 4 1/4" L x 3 1/4" W Resin \$135.26 pair*</p>
---------------------------------------------------------------------------------------------------------------------------------------------------------------	----------------------------------------------------------------------------------------------------------------------------------------------------------------------------------	-------------------------------------------------------------------------------------------------------------------------------------------------------------------	--------------------------------------------------------------------------------------------------------------------------------------------------------------------------------------	----------------------------------------------------------------------------------------------------------------------------------------------------------------------

 <p>PO214HZFI Hazel - Crystal 2 5/8" L x 3 3/8" W Resin / Crystal \$262.35 pair*</p>	 <p>PO214LNFI Landon 5 1/2" L x 4" W Resin \$135.26 pair*</p>	 <p>PO214LEFI Leighton 3" L x 4 1/8" W Resin \$135.26 pair*</p>	 <p>PO214LEFIGL Leighton - Glass 3" L x 4 1/8" W Resin / Glass \$209.88 pair*</p>	 <p>PO214NOFI Nolan 4 5/8" L x 3 1/2" W Metal / Glass \$262.35 pair*</p>
--------------------------------------------------------------------------------------------------------------------------------------------------------------------------------------	----------------------------------------------------------------------------------------------------------------------------------------------------------------	------------------------------------------------------------------------------------------------------------------------------------------------------------------	-------------------------------------------------------------------------------------------------------------------------------------------------------------------------------------	-----------------------------------------------------------------------------------------------------------------------------------------------------------------------------

 <p>PO214OPFI Opal 3 3/8" L x 3 3/4" W Resin \$135.26 pair*</p>	 <p>PO214SIFI Sidney 3 1/8" L x 4 1/8" W [3" square] Resin \$121.26 pair*</p>	 <p>PO214STFI Stella 2 1/2" L x 3 1/4" W Resin \$121.26 pair*</p>
-------------------------------------------------------------------------------------------------------------------------------------------------------------------	--------------------------------------------------------------------------------------------------------------------------------------------------------------------------------------	----------------------------------------------------------------------------------------------------------------------------------------------------------------------

2 1/4" Heritage Classics Finial Collection fits the 2 1/4" wood poles and heavy duty traverse.

 <p>PO214ADFI</p> <p>Adelaide</p> <p>5" L x 3 1/2" W Resin</p> <p>\$135.26 pair*</p>	 <p>PO214ADFIGL</p> <p>Adelaide - Mercury Glass</p> <p>5" L x 3 1/2" W Resin / Glass</p> <p>\$209.88 pair*</p>	 <p>PO214BOFI</p> <p>Bordeaux</p> <p>4 5/8" L x 4" W Resin</p> <p>\$160.91 pair*</p>	 <p>PO214DUEC</p> <p>Durham End Cap</p> <p>1" L x 3" W Resin</p> <p>\$67.63 pair*</p>	 <p>PO214FAFI</p> <p>Farrin - Mercury Glass</p> <p>4 1/2" L x 4 7/8" W Metal / Glass</p> <p>\$209.88 pair*</p>
 <p>PO214FIFI</p> <p>Fiona</p> <p>4" L x 5" W Resin</p> <p>\$160.91 pair*</p>	 <p>PO214GKFI</p> <p>Greek</p> <p>5" L x 4 1/4" W Resin</p> <p>\$135.26 pair*</p>	 <p>PO214LCEC</p> <p>Large Carved End Cap</p> <p>1 3/8" L x 2 3/4" W Resin</p> <p>\$67.63 pair*</p>	 <p>PO214LYFI</p> <p>Lyon</p> <p>4 1/2" L x 4 5/8" W Resin</p> <p>\$160.91 pair*</p>	 <p>PO214MAEC</p> <p>Margot End Cap</p> <p>3/4" L x 3" W Resin</p> <p>\$67.63 pair*</p>
 <p>PO214MIFI</p> <p>Michael</p> <p>6 1/2" L x 4" W Resin</p> <p>\$160.91 pair*</p>	 <p>PO214OLFI</p> <p>Oliver</p> <p>3 5/8" L x 3 7/8" W Resin</p> <p>\$135.26 pair*</p>	 <p>PO214QNFI</p> <p>Quentin</p> <p>5" L x 3 1/2" W Metal / Glass</p> <p>\$262.35 pair*</p>	 <p>PO214RYFI</p> <p>Rydal</p> <p>5 3/4" L x 4 1/4" W Resin</p> <p>\$160.91 pair*</p>	 <p>PO214VVFI</p> <p>Vivian</p> <p>5 1/4" L x 4" W Metal / Glass</p> <p>\$262.35 pair*</p>

*Sold in pairs only.

2 1/4" Metal Brackets fit the 2 1/4" wood poles.

Note: Return indicates distance from wall to center of pole.

 <p>PO214HASBK Harlan Single</p> <p>3 3/4" H x 3/4" W backplate, 4 1/8" return</p> <p>\$69.96 each</p>	 <p>PO214HAS6BK Harlan 6" Single</p> <p>3 3/4" H x 3/4" W backplate, 6" return</p> <p>\$75.79 each</p>	 <p>PO214HADBK Harlan Double</p> <p>3 3/4" H x 3/4" W backplate, 6" front return, 2 1/2" back return, front cradle holds 2 1/4" DIA pole; back cradle holds 1 3/8" DIA pole</p> <p>\$81.62 each</p>
----------------------------------------------------------------------------------------------------------------------------------------------------------------------------------------------------	---------------------------------------------------------------------------------------------------------------------------------------------------------------------------------------------------------------	---------------------------------------------------------------------------------------------------------------------------------------------------------------------------------------------------------------------------------------------------------------------------------------------------

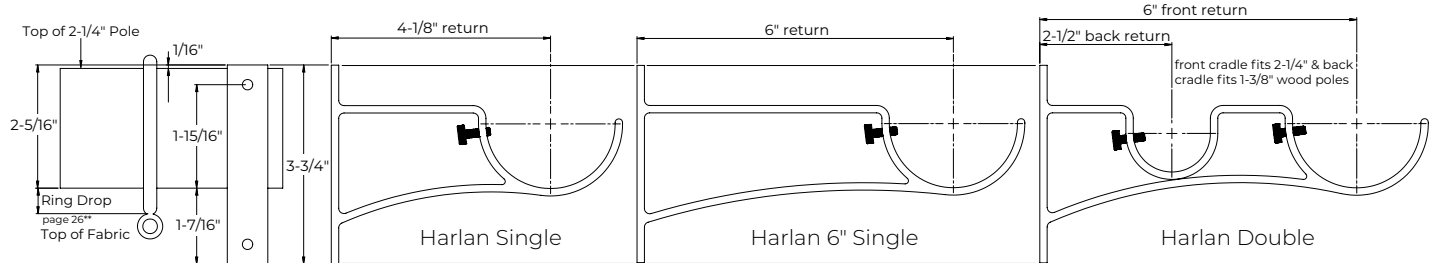

 <p>POBKT214 Adjustable Single Bracket</p> <p>1" W x 3 1/2" H backplate, 3 7/8" - 5" adjustable return</p> <p>\$69.96 each</p>	 <p>PO214MCMBK Ceiling Single</p> <p>3 3/4" H x 3 1/4" D, 3 1/2" drop</p> <p>\$69.96 each</p>	 <p>PO214MIBK Inside Mount</p> <p>1" W x 1 5/8" H x 2 7/8" D, 1/4" thick backplate per bracket</p> <p>\$110.77 pair*</p>
-----------------------------------------------------------------------------------------------------------------------------------------------------------------------------------------------------------------------------	--------------------------------------------------------------------------------------------------------------------------------------------------------------------------------------------	-------------------------------------------------------------------------------------------------------------------------------------------------------------------------------------------------------------------------

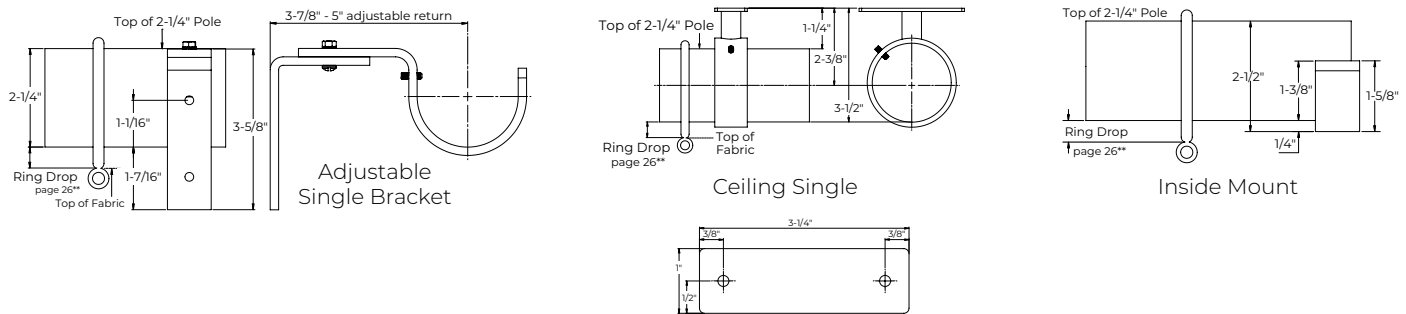



2 1/4" Wood & Resin Brackets fit the 2 1/4" wood poles.

Note: Return indicates distance from wall to center of pole.

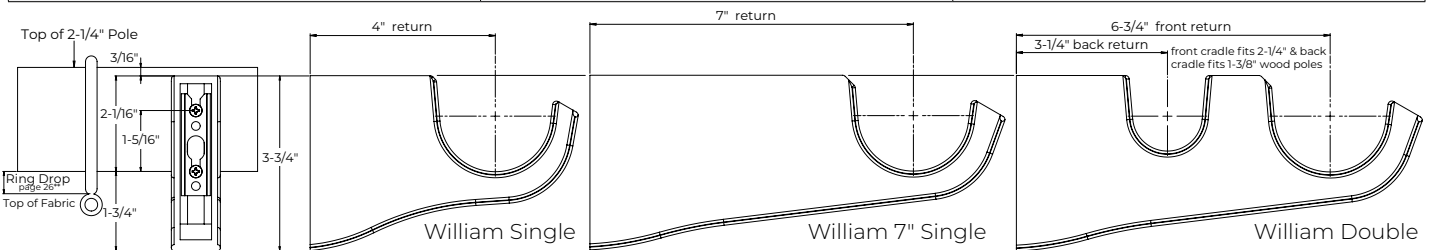
 <p>PO214WISBK William Single 1" W x 3 3/4" H backplate, 4" return, Resin</p> <p style="text-align: center;">\$69.96 each</p>	 <p>PO214WIS6BK William 7" Single 1" W x 3 3/4" H backplate, 7" return, Resin</p> <p style="text-align: center;">\$75.79 each</p>	 <p>PO214WIDBK William Double 1" W x 3 3/4" H backplate, 6 3/4" front return, 3 1/4" back return, front cradle holds 2 1/4" DIA pole; back cradle holds 1 3/8" DIA pole, Resin</p> <p style="text-align: center;">\$81.62 each</p>
--------------------------------------------------------------------------------------------------------------------------------------------------------------------------------------------------------------------------------------	----------------------------------------------------------------------------------------------------------------------------------------------------------------------------------------------------------------------------------------------------------------	---------------------------------------------------------------------------------------------------------------------------------------------------------------------------------------------------------------------------------------------------------------------------------------------------------------------------------------------



 <p>PO214PRBK Preston Single 1 1/2" W x 4 5/8" H backplate, 4 1/8" return, Resin</p> <p style="text-align: center;">\$75.79 each</p>	 <p>PO214WOJCBK Ceiling Single 1 3/4" W x 5 1/2" D x 1/2" H backplate, 4 7/8" drop, Wood</p> <p style="text-align: center;">\$75.79 each</p>
----------------------------------------------------------------------------------------------------------------------------------------------------------------------------------------------------------------------------------------------	--------------------------------------------------------------------------------------------------------------------------------------------------------------------------------------------------------------------------------------------------------

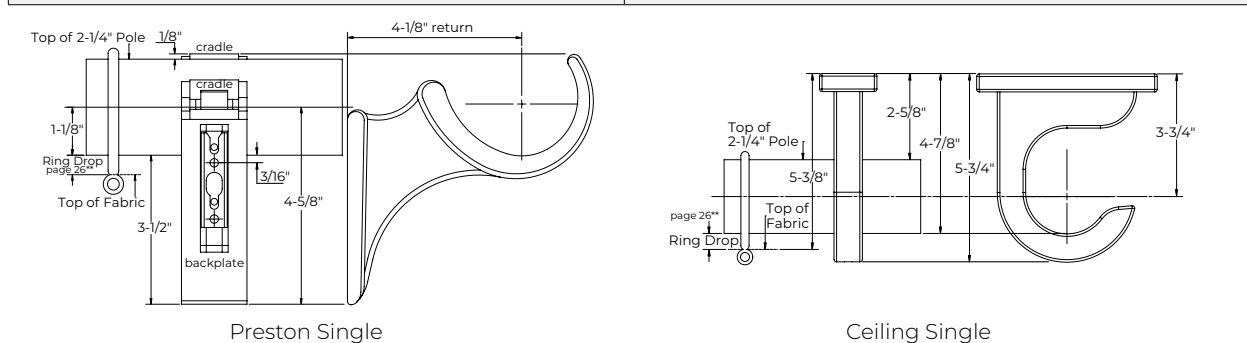

2 1/4" Wood Poles

2 1/4" wood poles are sold in 2' increments. 2' minimum. Poles will be cut to specified lengths; fall off will not be saved or shipped. Maximum continuous length up to 16'.

Note: All orders with poles and/or traverse track will incur a \$10.00 packaging fee per order.

PO214SM02	PO214SM04	PO214SM06	PO214SM08	PO214SM10	PO214SM12	PO214SM14	PO214SM16
Smooth - 2'	Smooth - 4'	Smooth - 6'	Smooth - 8'	Smooth - 10'	Smooth - 12'	Smooth - 14'	Smooth - 16'
\$93.28 each	\$186.56 each	\$279.84 each	\$373.12 each	\$466.40 each	\$559.68 each	\$652.96 each	\$746.24 each

PO214GR02	PO214GR04	PO214GR06	PO214GR08	PO214GR10	PO214GR12	PO214GR14	PO214GR16
Grooved / Fluted - 2'	Grooved / Fluted - 4'	Grooved / Fluted - 6'	Grooved / Fluted - 8'	Grooved / Fluted - 10'	Grooved / Fluted - 12'	Grooved / Fluted - 14'	Grooved / Fluted - 16'
\$93.28 each	\$186.56 each	\$279.84 each	\$373.12 each	\$466.40 each	\$559.68 each	\$652.96 each	\$746.24 each

PO214RE02	PO214RE04	PO214RE06	PO214RE08	PO214RE10	PO214RE12	PO214RE14	PO214RE16
Reeded - 2'	Reeded - 4'	Reeded - 6'	Reeded - 8'	Reeded - 10'	Reeded - 12'	Reeded - 14'	Reeded - 16'
\$93.28 each	\$186.56 each	\$279.84 each	\$373.12 each	\$466.40 each	\$559.68 each	\$652.96 each	\$746.24 each

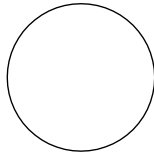
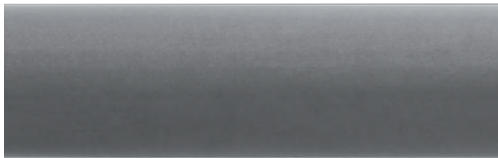

Smooth Wood Pole PO214SM

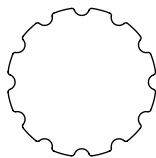

Grooved / Fluted Wood Pole PO214GR

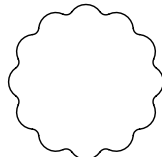
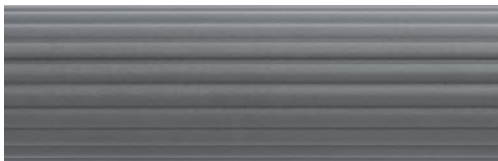

Reeded Wood Pole PO214RE

EZ Glide Tape

Included with pole order. Allows rings and grommets to slide effortlessly across the drapery rod without damaging the finish.



EZ Glide Tape

1/2" W

no charge

2 1/4" Rings fit the 2 1/4" wood poles.

Note: Ring drop indicates distance from bottom of pole to bottom of ring. A ring's drop changes on different diameter poles.**

 <p>PO214WRI Wood Ring</p> <p>2 5/8" ID, 3 5/8" OD, 7/8" drop Wood</p> <p>\$11.66 each</p>	 <p>PO214MRI Metal Ring</p> <p>2 1/2" ID, 3" OD, 1/2" drop Metal</p> <p>\$10.49 each</p>	 <p>PO214FORI Forrest Ring</p> <p>2 3/4" ID, 3 1/8" OD, 3/4" drop Metal</p> <p>\$10.49 each</p>
-------------------------------------------------------------------------------------------------------------------------------------------------------------------------------------------	-----------------------------------------------------------------------------------------------------------------------------------------------------------------------------------------	------------------------------------------------------------------------------------------------------------------------------------------------------------------------------------------------

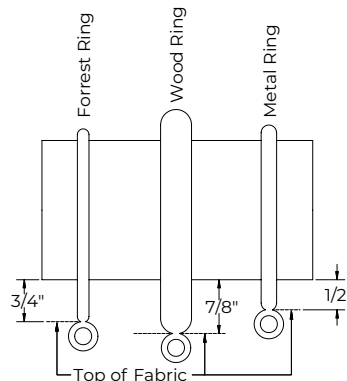

2 1/4" Accessories

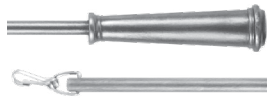

Fiberglass Baton

3/8" DIA, Fiberglass

PORE36WAND - 36" - \$67.63 each

PORE48WAND - 48" - \$73.46 each

PORE60WAND - 60" - \$79.29 each



PO214REL

Hinged Elbow

2 3/8" DIA, 5 1/8" OL,
2 9/16" L each side
when bent
Resin

\$73.46 each



Clear Acrylic Baton

1/2" DIA, Acrylic

AC36WAND - 36" - \$52.47 each

AC48WAND - 48" - \$58.30 each

AC60WAND - 60" - \$64.13 each



Handicap Clear Acrylic Baton







4" Loop, ADA Compliant, Acrylic

AC48HWAND - 48" - \$58.30 each

AC60HWAND - 60" - \$64.13 each

AC72HWAND - 72" - \$69.96 each

Modern Holdback Medallions fit modern or transitional resin holdback stems.

					
POACHB Achilles 2 ½" square, ½" TH Metal	POBKHB Blake - Mercury Glass 3" DIA, 2 ⅜" TH Metal / Glass	POHAHB Hadley 3 ½" DIA, 1" TH Metal	POJEHB Jem 2 ½" DIA, ⅜" TH Metal	POMARHB Mara 3" DIA, 7/8" TH Metal	POPAHB Parker 3 ¼" square, 1" TH Metal
\$104.94 pair*	\$157.41 pair*	\$81.62 pair*	\$81.62 pair*	\$116.60 pair*	\$81.62 pair*

Modern Holdback Stems must order separately. Projection indicates distance from wall to back of medallion.



		
POMHBSTEM2 2" PROJ Base: 2 ⅜" DIA Stem: ½" DIA Metal	POMHBSTEM4 4" PROJ Base: 2 ⅜" DIA Stem: ½" DIA Metal	POMHBSTEM6 6" PROJ Base: 2 ⅜" DIA Stem: ½" DIA Metal
\$53.64 pair*	\$60.63 pair*	\$65.30 pair*

**« Don't forget to
order your
Holdback Stems
separately**

Holdback Arms May be used with any 1 ⅛" metal or resin finial without Cuff. Finials are sold separately.

	
POHBARM Holdback Arm 7" W, ½" DIA stem 1 ⅝" H backplate, 5 ½" D, 4 ½" PROJ Metal	Holdback Arm shown with Achilles Finial (sold separately) Metal
\$69.96 pair*	

Holdback Medallion Bands Attaches any Holdback Medallion to the front of a pole. Holdback Medallions sold separately.

		
PO118MEBAND 1 ⅛" Band ¾" W, 1 ⅜" ID, 1 ⅝" OD Metal	PO138MEBAND 1 ⅜" Band ¾" W, 1 7/16" ID, 1 ⅝" OD Metal	PO214MEBAND 2 ¼" Band ¾" W, 2 ⅝" ID, 2 ½" OD Metal
\$39.64 pair*	\$45.47 pair*	\$51.30 pair*

Common uses for Medallion Bands:

1. Repeated decorative embellishment along the length of a pole.
2. Hold gathered rod pocket drapery panel in place.
3. Ring stop.

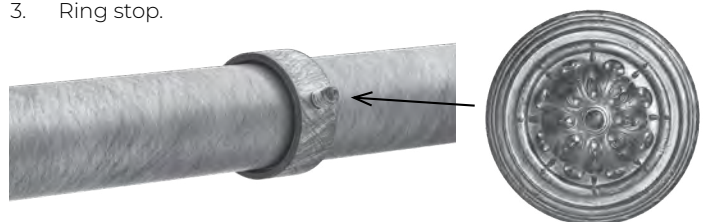

Transitional Holdback Medallions fit modern or transitional resin holdback stems.

					
POBEHB Bernadette 4 ½" DIA, 1 ¼" TH Resin	POBLHB Blois 3 ¾" DIA, ¾" TH Resin	POBRHB Brooks 4" DIA, 1 ¼" TH Resin	POCHHB Chenonceau 3 ¾" DIA, ¾" TH Resin	POGEHB Genette 4" DIA, 1 ¼" TH Resin	POGLHB Gloria 5" DIA, 1 ⅜" TH Resin
\$139.92 pair*	\$81.62 pair*	\$104.94 pair*	\$81.62 pair*	\$116.60 pair*	\$139.92 pair*

					
POISHB Isabelle 5 ½" DIA, 1 ¼" TH Resin	POLYHB Lyon 4 ¾" DIA, 2 ½" TH Resin	POMIHB Miranda 5" DIA, 1 ½" TH Resin	POMRHB Mirna 4 ½" DIA, 1 ¼" TH Resin	POSWHB Swindon 5 ⅞" DIA, 1 ¼" TH Resin	POTRHB Trudy 4 ¾" DIA, ¾" TH Resin
\$104.94 pair*	\$139.92 pair*	\$104.94 pair*	\$139.92 pair*	\$104.94 pair*	\$104.94 pair*

Transitional Holdback Stems must order separately. Projection indicates distance from wall to back of medallion.

		
POTHBSTEM2 2" PROJ Base: 3" DIA Stem: ⅝" DIA Metal	POTHBSTEM4 4" PROJ Base: 3" DIA Stem: ⅝" DIA Metal	POTHBSTEM6 6" PROJ Base: 3" DIA Stem: ⅝" DIA Metal
\$65.30 pair*	\$72.29 pair*	\$76.96 pair*

**« Don't forget to
order your
Holdback Stems
separately**



**Designer
Expertise**

**Coordinating Holdback Medallions
really tie the full window together »**

*Sold in pairs only.



Traverse

Systems

Motorized and Manual Systems, featuring the **RTEC** AUTOMATION® Collection Traverse Systems available in Portfolio or Quick Ship finishes.

ships in 10 - 15 business days



Featuring the
RTEC AUTOMATION®
Slim Drapery Motor.

Designed to install seamlessly behind the drapery panel, providing the ultimate integrated functionality without compromising the look of your window treatment.

RTEC AUTOMATION® 1 3/8" Motorized Metal Traverse Systems

Motorized 1 3/8" Metal traverse systems create smart design solutions for both residential and commercial environments.

The slim drapery motor is designed to install seamlessly behind the drapery panel with quiet start / stop operation, the ability to easily charge without having to remove the motor and up to 500 open and close cycles per charge, providing the ultimate integrated functionality without compromising the look of your window treatment.

Our NEW French Returns for Traverse may be ordered separately. Finials may be ordered separately from 1 3/8" Diameter Collections. Modern Finial Collection do not require use of Cuff and attach using set screw. Today's Traditional and Heritage Classics Finial Collections require the use of the Transitional Cuff / Finial Adapter (sold separately). See page 40.

Select from 35 Portfolio hand painted finishes (**except Antique Gold Leaf**), 6 Quick Ship Metal finishes, 5 Quick Ship Wood & Resin finishes or PTH Perfect Match™.



Single Traverse System, Wall Mount

- Wall Bracket: 3 1/2" or 6" return options
- Traverse system includes track, motor, power option, drive belt & clips, pulleys, pendants, brackets, glides, master carriers, Ainsley end caps and a Push5 handheld remote with wall mount
- 1 3/8" collection finials and additional remote options sold separately



Double Traverse System, Wall Mount

- Wall bracket: 3" and 7 1/2" returns
- Traverse system includes tracks, motors, power options, drive belt & clips, pulleys, pendants, brackets, glides, master carriers, Ainsley end caps and a Push5 handheld remote with wall mount
- 1 3/8" collection finials and additional remote options sold separately



Single Traverse System, Ceiling Mount

- Ceiling bracket: 3 11/16" drop
- Traverse system includes track, motor, power option, drive belt & clips, pulleys, pendants, brackets, glides, master carriers, Ainsley end caps and a Push5 handheld remote with wall mount
- 1 3/8" collection finials and additional remote options sold separately



Double Traverse System, Ceiling Mount

- Ceiling bracket: 4" drop, 4 1/2" between centers of tracks
- Traverse system includes tracks, motors, power options, drive belt & clips, pulleys, pendants, brackets, glides, master carriers, Ainsley end caps and a Push5 handheld remote with wall mount
- 1 3/8" collection finials and additional remote options sold separately



Single Traverse System, Low-Profile Ceiling Mount

- Ceiling bracket: 1 1/2" drop
- Traverse system includes track, motor, power option, drive belt & clips, pulleys, pendants, brackets, glides, master carriers, Ainsley end caps and a Push5 handheld remote with wall mount
- 1 3/8" collection finials and additional remote options sold separately

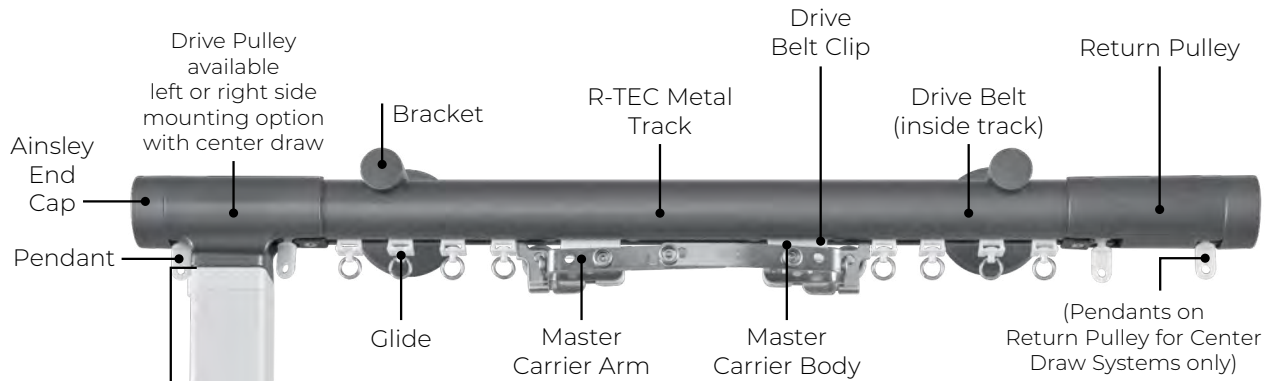

Included in System: R-TEC Automation® Metal Traverse Track(s), Metal End Caps, Brackets, Components, Motor(s), Power Option(s) & Push5 Handheld Remote with Wall Mount

R-TEC Automation® Slim Drapery Motor

- Slim Drapery Motor, 1 per track
- Maximum drapery weight: 77 lbs
- Maximum track length: 24'
- Power Option: Li-ion Battery (includes Battery Charger & USB Cable) or 110v AC/DC Power Transformer (includes 10' Cord with 3 Conductor Male Plug)
- Motor can be mounted on right or left for Center Draw
- Return Hooks/Snaps included; available in white or bronze /BR
- Motor available in white
- 5 Year Warranty



R-TEC Automation® Push5 Handheld Remote with Wall Mount RTMHR5C

- 5 Channel Remote with simple buttons.
- 4 3/4" H x 2" W x 3/8" D
 - 1 Remote Control per system
 - Range: 65'
 - Programmable Favorite Position to set your favorite drapery position
 - Off-White

R-TEC Metal Traverse Track

- Track sold in 1 foot increments, 4' minimum
- Maximum continuous length is 12' on select finishes (see below bullets); spliced lengths up to 24' (maximum of 2 splices per metal traverse track system)
- Maximum continuous length is 12' on 35 Portfolio Finishes (**except Antique Gold Leaf**), BN and MK Quick Ship Metal Finishes, 5 Quick Ship Wood & Resin Finishes and PTH Perfect Match™
- Maximum continuous length is 8' on SG, RGD, BZ and CZ Quick Ship Metal Finishes

Slim Drapery Motor (cannot be top mounted)

Li-ion Battery shown (110v AC/DC Power Transformer option available)

Motor & Power Options



Slim Drapery Motor RTMLDSS50



Li-ion Battery RTMLDSSB



Battery Charger RTMLDSSBC



USB Charger Cable RTMLDSSUSB



110v AC/DC Power Transformer 10' (plug included) RTMDSST

Motor Weight Capacity

Use the Motor Weight Capacity chart below to determine if the slim drapery motor accommodates your length of track and your drapery weight. The System Features chart on page 34 lists the varied functions of the motor.

		maximum drapery weight per total length of system (lbs)			
Motor		18' or less	20'	22'	24'
R-TEC AUTOMATION®	Slim Drapery Motor	77	77	77	77

Note: 77 lbs. is the maximum weight for one-way or center draw panels for each track on single and double traverse systems. Capacity ratings are based on internal system friction only. External loads caused by fabric friction, drag or obstructions will adversely affect pulling capacity or stop motor due to resistance.

System Features	R-TEC Automation® Slim Drapery Motor
System Features	
Center Draw or One-Way Draw Available	X
White or Bronze Track, Components & Brackets Available	X
Track Maximum Length	24'
Maximum Number of Track Splices	2
Motor Features	
Battery Power Option	X
Motor Cord Length as Purchased	10' (custom length up to 20' available)
2-Way RF Communication	X
Adjustable Speed	X
Preferred Open / Close Position	X
Favorite Position	X
Obstruction Detection	X
Manual Override	X
Quiet Operation	X
Soft Start / Stop	X
Average Linear Speed	5.5" (14 cm)/sec
Motorized Track Noise Level	44 dB
Maximum Weight	77 lbs
Motor Unit can be Installed on Either End of Track	X
Control Options	
Sun Control	X
Digital Technology	ARC™
Solar Power	X
Installation Features	
Programming Buttons on Motor Unit	X
Power Supply	Li-Ion Battery or 110v AC/DC Power Transformer
Amperage	1.3 A
Power Consumption	20 W
Power Cable Type	3 Conductor Male Plug
Standard Accessories Included with System	
5 Channel Handheld Remote with Wall Mount (Remote Control; White)	X
Carrier Features	
White or Bronze Pinch Pleat Glides	X
White or Bronze Ripplefold Glides (Choose 60%, 80%, 100% or 120% Fullness)	X

Additional R-TEC Smart Controls

can be ordered at additional cost



MT02-0401-067001 Automate™ Pulse 2 Hub; 2-way RF; Wi-Fi built in
 · 4 1/2" H x 1 1/4" W x 4 1/2" D
 · Range: 60'



RTMHRIC Handheld Remote with Wall Mount, 1 Channel
 · 5 3/16" H x 1 1/4" W x 1/2" D
 · Range: 65'
 · Available in White



RTMHR5C Push5 Handheld Remote with Wall Mount, 5 Channel
 · 4 3/4" H x 2" W x 3/8" D
 · Range: 65'
 · Available in Off-White



RTMHRP15C (/k) Push15 Handheld Remote with Wall Mount, 15 Channel
 · 4 3/4" H x 2" W x 3/8" D
 · Range: 65'
 · Available in White or Black



RTMHR15C Handheld Remote with Wall Mount, 15 Channel
 · 5 3/16" H x 1 1/4" W x 1/2" D
 · Range: 65'
 · Available in White



RTMW5R5C Surface Mount Wall Switch, 5 Channel
 · 4 1/2" H x 2 3/4" W x 7/8" D
 · Range: 65'
 · Available in White



RTMWCR1C RTMWCR2C RTMWSR15C Cut-In Wall Mount Switch, 1, 2 or 15 Channel
 · 4 1/2" H x 2 3/4" W x 1" D
 · Range: 65'
 · Available in White
 · RTMSMB/W required for installation



RTMISS Interior Sun Sensor
 · 1 3/4" H x 1 3/4" W x 5/8" D
 · Range: 65'
 · Available in White



RTMUSR ARC™ USB Signal Repeater
 · 2" L x 2 1/2" L with USB x 1 5/16" W
 · Extends the wireless range of the Hub and remotes up to 60'
 · Maximum 2 repeaters per system or network
 · Available in White (color may vary)



RTMLDSSBC Wall Charger for USB Signal Repeater
 · 1 7/16" W x 1 13/16" L
 · Available in White (color may vary)



RTMSOLAR2 Solar Panel Battery Charger
 · 4 5/8" H x 12 3/16" W x 1 3/8" D
 · Includes I-bracket, cables & fastener

ECO friendly

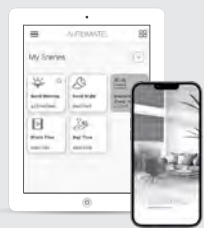

Control your window coverings with a smartphone or tablet. The Automate™ Pulse 2 App enables simple, intuitive control and system configuration from your smartphone or tablet.



Pair the Automate™ Pulse 2 Hub and App with these systems:



(not sold by Rowley):

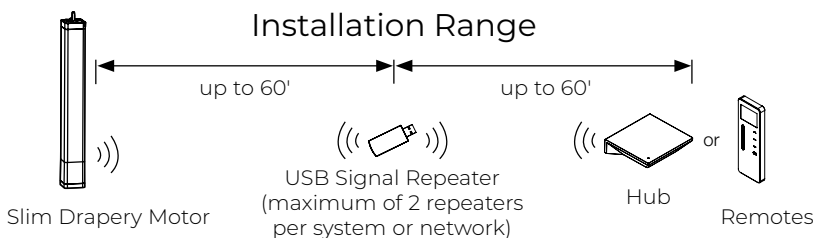

1 3/8" Motorized Metal Traverse Systems Finishes

35 Portfolio finishes (except Antique Gold Leaf), PTH Perfect Match™, 6 Quick Ship Metal finishes or 5 Quick Ship Wood & Resin finishes.

Diameter	Track Finish	Component Color	Max. Continuous Length
1 3/8"	Amulet	White	12'
1 3/8"	Andiron	White	12'
1 3/8"	Antique Gold	White	12'
1 3/8"	Art Bronze	Bronze	12'
1 3/8"	Barnwood	Bronze	12'
1 3/8"	Black	Bronze	12'
1 3/8"	Blush	White	12'
1 3/8"	Bronzed Pewter	Bronze	12'
1 3/8"	Concrete	White	12'
1 3/8"	Couture	White	12'
1 3/8"	Dark Chocolate	Bronze	12'
1 3/8"	Firelight	White	12'
1 3/8"	Gossamer	Bronze	12'
1 3/8"	Greige	White	12'
1 3/8"	Halo	White	12'
1 3/8"	Java	Bronze	12'
1 3/8"	Linen	White	12'
1 3/8"	Luminous	Bronze	12'
1 3/8"	Manor	White	12'
1 3/8"	Mink	Bronze	12'
1 3/8"	Moonlight	Bronze	12'
1 3/8"	Mystic	White	12'
1 3/8"	New Age Bronze	Bronze	12'
1 3/8"	Patina	White	12'
1 3/8"	Shimmer	Bronze	12'
1 3/8"	Silver Maple	White	12'
1 3/8"	Spicewood	Bronze	12'
1 3/8"	Spun Gold	White	12'
1 3/8"	Stardust	White	12'
1 3/8"	Starlet	White	12'
1 3/8"	Titanium	White	12'
1 3/8"	Truffle	Bronze	12'
1 3/8"	Urban Bronze	Bronze	12'
1 3/8"	White	White	12'
1 3/8"	PTH Perfect Match™	please specify	12'
1 3/8"	Brushed Nickel	White	12'
1 3/8"	Brushed Bronze	Bronze	8'
1 3/8"	Charcoal Zinc	White	8'
1 3/8"	Matte Black	White	12'
1 3/8"	Rose Gold	White	8'
1 3/8"	Satin Gold	White	8'
1 3/8"	Antique Brass	White	12'
1 3/8"	Oil Rubbed Bronze	Bronze	12'
1 3/8"	Platinum	White	12'
1 3/8"	Rose Gold	White	12'
1 3/8"	Walnut	Bronze	12'

1 3/8" Motorized Metal Traverse Systems Pricing

Orders with R-TEC motorized traverse systems will incur a \$25 packaging fee. Orders that contain a Li-ion battery will be charged a \$25.00 shipping surcharge.

Li-ion Battery or 110v AC/DC Power, Ripplefold or Pinch Pleat

Systems are sold in 1 ft increments

Item #	4'	5'	6'	7'	8'	9'	10'	11'	12'	price per ft
Single Traverse System, Wall Mount, 3 1/2" return (includes track, motor, power option, brackets, Ainsley end caps, 5 channel remote & components)										
CSRPTHM138400	\$1,769.99	\$1,862.10	\$1,954.22	\$2,046.33	\$2,138.44	\$2,230.56	\$2,322.67	\$2,414.79	\$2,506.90	\$92.11
Single Traverse System, Wall Mount, 6" return (includes track, motor, power option, brackets, Ainsley end caps, 5 channel remote & components)										
CSRPTHM138401	\$1,858.60	\$1,961.21	\$2,063.82	\$2,166.43	\$2,269.04	\$2,371.64	\$2,474.25	\$2,576.86	\$2,679.47	\$102.61
Double Traverse System, Wall Mount (includes tracks, motors, power options, brackets, Ainsley end caps, 5 channel remote & components)										
CSRPTHM138402	\$3,539.98	\$3,724.20	\$3,908.43	\$4,092.66	\$4,276.89	\$4,461.12	\$4,645.34	\$4,829.57	\$5,013.80	\$184.23
Single Traverse System, Ceiling Mount (includes track, motor, power option, brackets, Ainsley end caps, 5 channel remote & components)										
CSRPTHM138403	\$1,769.99	\$1,862.10	\$1,954.22	\$2,046.33	\$2,138.44	\$2,230.56	\$2,322.67	\$2,414.79	\$2,506.90	\$92.11
Double Traverse System, Ceiling Mount (includes tracks, motors, power options, brackets, Ainsley end caps, 5 channel remote & components)										
CSRPTHM138404	\$3,539.98	\$3,724.20	\$3,908.43	\$4,092.66	\$4,276.89	\$4,461.12	\$4,645.34	\$4,829.57	\$5,013.80	\$184.23
Single Traverse System, Low-Profile Ceiling Mount (includes track, motor, power option, brackets, Ainsley end caps, 5 channel remote & components)										
CSRPTHM138406	\$1,761.91	\$1,854.03	\$1,946.14	\$2,038.26	\$2,130.37	\$2,222.48	\$2,314.60	\$2,406.71	\$2,498.83	\$92.11

Item #	Name	NET Price
--------	------	-----------

R-TEC Automation® Motor Kits

RTMLDKIT	Slim Drapery Motor with Li-ion Battery, Wall Charger & USB Cable (included)	\$371.00
RTMLDS2KIT	Slim Drapery Motor with Li-ion Battery & Solar Panel Charger	\$498.20
RTMLDACKIT	Slim Drapery Motor with 110v AC/DC Power Transformer 10' with 3 Conductor Male Plug	\$312.70

Item #	Name	NET Price
--------	------	-----------

R-TEC Motor & Components

RTMLDSS50	Slim Drapery Motor	\$212.00
RTMLDSSB	Li-ion Battery	\$127.20
RTMLDSSBC	Battery Wall Charger	\$15.90
RTMLDSSUSB	USB Cable	\$15.90
RTMDSSPT	110v AC/DC Power Transformer 10' with 3 Conductor Male Plug	\$74.20
RTMDSSPTCS	110v AC/DC Power Transformer 20' (plug RTMP sold separately) specify ft.	\$79.50
RTMP	3 Conductor Male Plug	\$26.50

Item #	Name	Color	NET Price
--------	------	-------	-----------

R-TEC Smart Controls

Push5 Handheld or Wall Mount Remote - 5 channel included

RTMHRIC	Handheld Remote with Wall Mount, 1 ch	White	\$68.90
RTMHR5C	Push5 Handheld Remote with Wall Mount, 5 ch	Off-White	\$74.20
RTMHRP15C RTMHRP15C/K	Push15 Handheld Remote with Wall Mount, 15 ch	White or Black	\$79.50
RTMHR15C	Handheld Remote with Wall Mount, 15 ch	White	\$90.10
RTMWSR5C	Surface Wall Mount Switch, 5 ch	White	\$74.20
RTMWCRIC	Cut-In Wall Mount Switch, 1 ch*	White	\$53.68
RTMWCR2C	Cut-In Wall Mount Switch, 2 ch*	White	\$59.99
RTMWSR15C	Cut-In Wall Mount Switch, 15 ch*	White	\$79.50
RTMSMB/W	*Surface Mount Wall Back Box	White	\$9.01
MT02-0401-067001	Wi-Fi to ARC Bridge Hub-2-Way RF-includes USB Power Cord, Power Plug & Ethernet Cable	White	\$270.30
RTMISS	Interior Sun Sensor	White	\$47.70
RTMUSR	ARC USB Signal Repeater	White	\$127.20
RTMLDSSBC	Wall Charger for USB Signal Repeater	White	\$15.90
RTMSOLAR2	Solar Panel Battery Charger-includes L-Bracket, Cables & Fastener	Black	\$127.20

*RTMSMB/W required for installation.

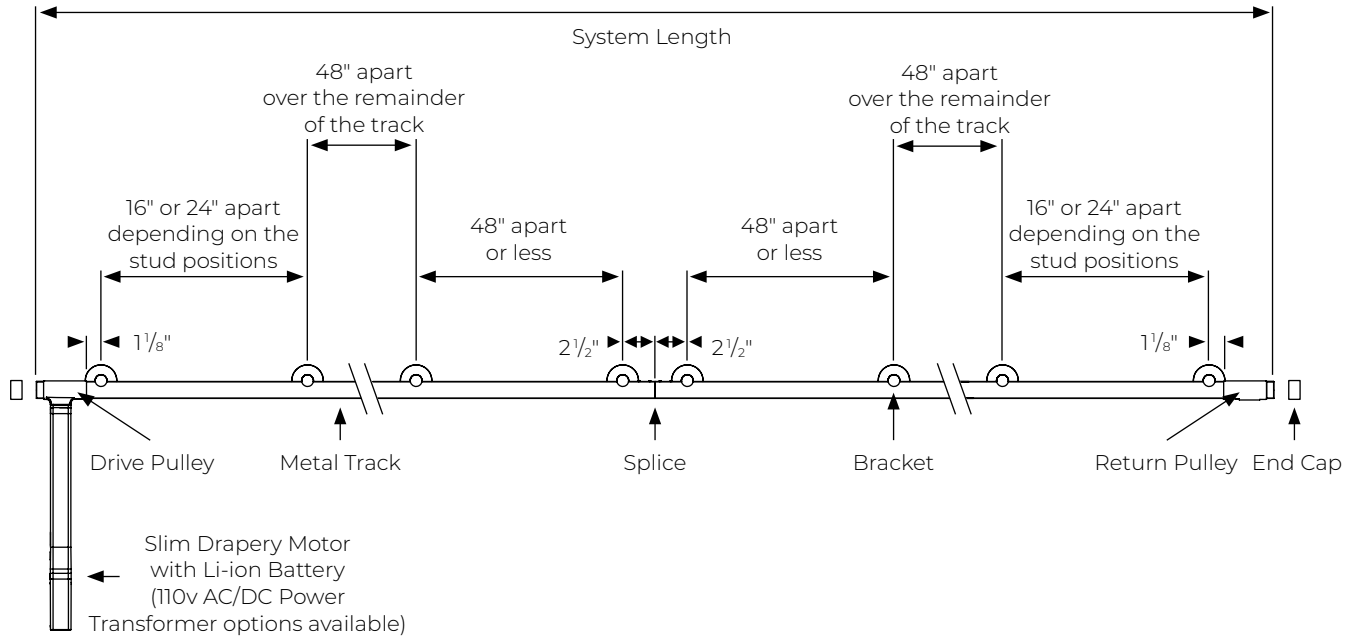

Quantity Per System

Quantity included per system based on cut track length	4'	5'	6'	7'	8'	9'	10'	11'	12'	13'	14'	15'	16'	17'	18'	19'	20'	21'	22'	23'	24'
Glides [4 per foot, includes master carriers & end caps (2)]	16	20	24	28	32	36	40	44	48	52	56	60	64	68	72	76	80	84	88	92	96
Brackets	2	3	4	4	4	5	5	5	5	6	6	6	6	7	7	7	8	8	8	8	8

PTH Motorized Traverse Tips

- Specified custom system length is from drapery return to drapery return including pulleys. Ainsley end caps included with the system, and will add 1/2" at each end, totaling 1".
- Track will be spliced in the center of overall length.
- R-TEC Motorized Traverse Systems carry a 5 year warranty; WARNING: Modifications of internal components will void R-TEC warranty.

Motorized Stack Back Calculation (each drapery panel)

R-TEC: master carrier + (# carriers on panel x carrier width) + 3.75" = stack per drapery panel

Ex: R-TEC 20 ft. one-way draw, Ripplefold® style 80% fullness
 $6.75" + (98 \times .563") + 3.375" = 65.3"$ stack, underlap master panel *BEFORE* drapery fabric is installed

Please note: Calculations result in stack back width *BEFORE* drapery fabric is installed. Stack back width will increase once draperies are installed. Factors such as thickness of drapery fabric, type of drapery pleat and fullness of treatment affect the final stack back width. Please consult your workroom to determine your final stack back based on your draperies.

1 3/8" Motorized Metal Traverse Systems Information

1 3/8" Brackets & Connectors for additional brackets. See below for diagrams/dimensions.

					
PTHMT138400 Wall Mount 3 1/2" return	PTHMT138401 Wall Mount 6" return	PTHMT138402 Wall Mount Double	PTHMT138403 Ceiling Mount Single	PTHMT138404 Ceiling Mount Double	PTHMT138405 Ceiling Bracket Extender
\$32.65 each	\$44.31 each	\$58.30 each	\$32.65 each	\$90.95 each	\$16.32 each

	
PTHMT138406 Low-Profile Ceiling Single	PTHMT138407 Connector / Splice
\$18.66 each	\$8.16 each

Wall Mount 3 1/2" return
PTHMT138400

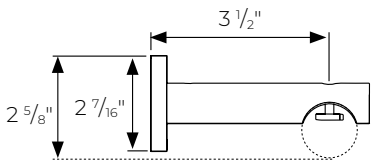

Wall Mount 6" return
PTHMT138401

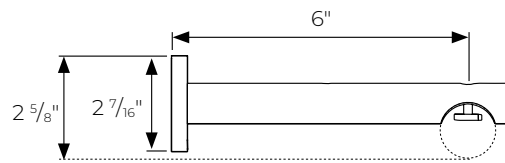

Wall Mount Bracket Mounting Plate

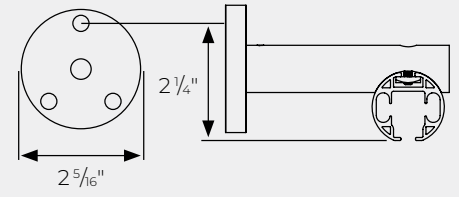

Wall Mount Double
PTHMT138402

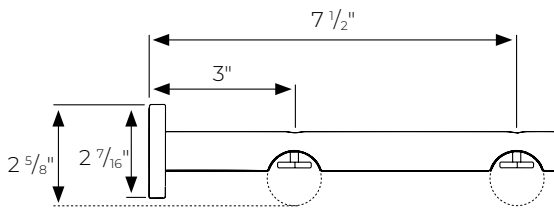

Ceiling Mount Single
PTHMT138403

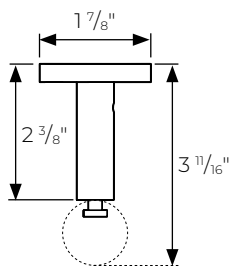

Ceiling Mount Double
PTHMT138404

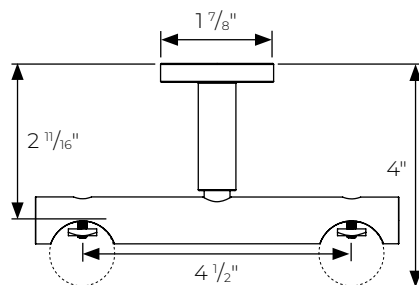

Ceiling Bracket Extender
PTHMT138405

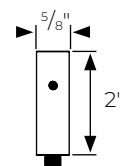

Low-Profile Single Ceiling
PTHMT138406

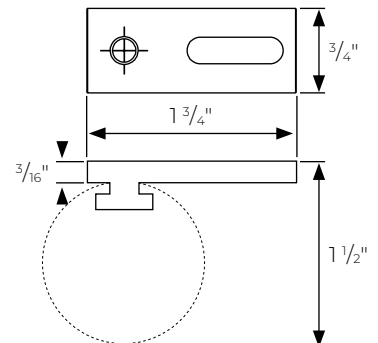

Carriers for additional carriers.

Pinch Pleat Glides



Pinch Pleat Glides
CP40 CP40/BR **/BR**

Wheel for smooth movement. Available in white or bronze /BR. Included in system; additional glides may be ordered separately.

\$3.45 NET pack (10 pieces)

Ripplefold® Style Glides



Ripplefold® Style Glides
R4060/P R4060/P/BR **/BR**
R4080/P R4080/P/BR
R4100/P R4100/P/BR
R4120/P R4120/P/BR

Ripplefold Glides with detachable pendants. 60%, 80%, 100% or 120% fullness - specify fullness on order. Available in white or bronze /BR.

\$0.67 NET each

Included in system; additional glides may be ordered separately.

R-TEC pinch pleat glide
4 per foot, unless otherwise specified

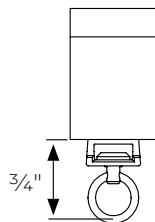

R-TEC Ripplefold glide
see specs to the right

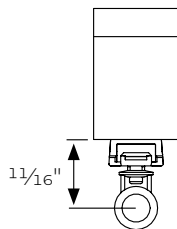

60% carrier fullness: 2 5/8" spacing
80% carrier fullness: 2 3/8" spacing
100% carrier fullness: 2 1/8" spacing
120% carrier fullness: 1 7/8" spacing

Snap tape*: 4 1/4" spacing
*Snap tape not included with system

IMPORTANT: Drapery workroom must apply specific snap tape to drapery panel when using Ripplefold glides.

R-TEC Automation® Ripplefold glides are compatible with Rowley R-TEX and clear Ripplefold snap tapes. Kirsch Ripplefold snap tapes may also fit.

Master carrier body is required for each master carrier arm - sold separately; look for the /BR icon for components available in bronze and add /BR at the end of the item number to order. See page 53 for measurements & diagrams.



Master Carrier Body
RTPTH138MCB
RTPTH138MCB/BR **/BR**

Select from different arms to assemble into one MC Body; order two if ordering Center Draw MC Arms - sold separately. Available in white or bronze /BR.

\$11.13 NET each



Overlap Master Carrier Arms for Center Draw
RTPTH138CD

Pair. Pinch pleat or Ripplefold; order two MC Bodies - sold separately. Available in Stainless Steel only.

\$5.83 NET pair*



Master Carrier Arm for One-Way Draw
RTPTH138PPOR
RTPTH138PPOL

Right (R) or Left (L). Pinch pleat or Ripplefold; order one MC Body - sold separately. Available in Stainless Steel only.

\$5.68 NET each



Ripplefold Butt Master Carrier Arms for Center Draw
RTMDTCDB

Pair. Ripplefold only; order two MC Bodies - sold separately. Do not overlap, allowing some light to filter between draperies on center draw treatments. Available in Stainless Steel only.

\$5.79 NET pair*



Ripplefold Butt Master Carrier Arm for One-Way Draw
RTPTH138OBR
RTPTH138OBL

Right and left use. Ripplefold only; order one MC Body - sold separately. Available in Stainless Steel only.

\$4.24 NET each

*Sold in pairs only.

Upgrade your End Cap with French Returns or Finials

1 3/8" R-TEC Motorized Metal Traverse Systems include End Caps, but are designed to work with our NEW 1 3/8" French Returns for Traverse and all 1 3/8" Finials across three style categories. Today's Traditional and Heritage Classics Finials require the use of the Transitional Cuff / Finial Adapter to work with Metal Traverse. Modern Finials do not require the use of the Finial Adapter.

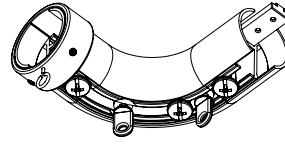

NEW

PTHMT138440

French Return for Metal Traverse

(Includes 1 Return, 1 Splice, 1 French Return Ring to reduce sidelight, 4 End Stops, 4 Ripplefold Carriers, 2 Pinch Pleat Carriers, 1 Allen Wrench and 2 Extra Set Screws)

Metal, 3 1/2" return, Ripplefold or Pinch Pleat

Available in any of our 35 Portfolio Hand Painted Finishes or PTH Perfect Match™

\$102.30 each



Portfolio page 14 | Quick Ship page 93 | *Transitional Cuff / Finial Adapter PO138CUFF not required



Portfolio page 17 | Quick Ship page 97 | *Requires Transitional Cuff / Finial Adapter PO138CUFF or QS138CUFF below



Portfolio page 17 | Quick Ship page 97 | *Requires Transitional Cuff / Finial Adapter PO138CUFF or QS138CUFF below

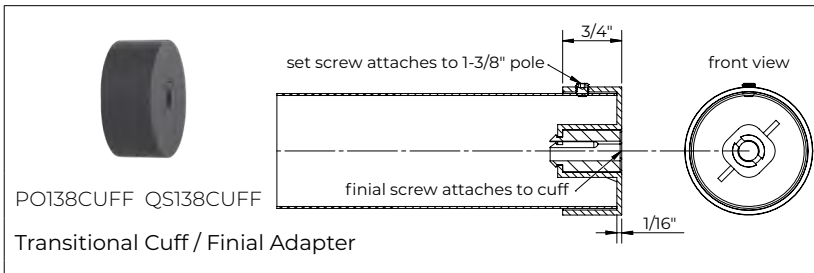

3/4" L x 1 1/2" W

- Metal, Available in any of our 35 Portfolio Hand Painted Finishes, 5 Quick Ship Wood & Resin Finishes or PTH Perfect Match™
- Use to adapt your 1 3/8" Today's Traditional or Heritage Classics Finial to work with Metal Traverse (required)

Style Meets Function

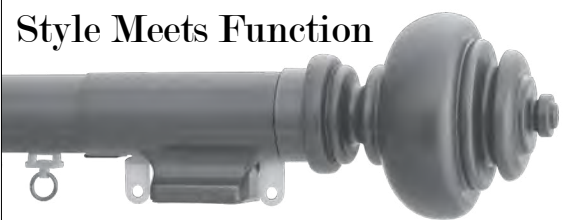

Lillian Finial with Transitional Cuff

\$45.47 pair*

**Sold in pairs only.*

Metal Motorized Traverse Order Form



PO #	Side Mark	Ship via	Date
Shipping Information			
Company Name	Acct #	Company Name	Acct #
Contact Person		Contact Person	
Street Address		Street Address	
City	State	City	State
Email	ZIP	Email	ZIP
Phone	Fax	Phone	Fax

MOTORIZED TRAVERSE SYSTEMS - Consult Price List for detailed specifications.
Specified custom cut length indicates track length including pulleys.

Item #	R-TEC Motor	Power Option **see additional R-TEC options below	Custom Cut Length (inches)	System Length (sold by 1')	Finish Code	Draw Preference		Glides pinch pleat OR Ripplefold® style*	Qty	Price per Unit	Subtotal
						Center	Motor Location				
	Slim	<input type="checkbox"/> U-ion Battery <input type="checkbox"/> 110v AC/DC Power				<input type="checkbox"/> L <input type="checkbox"/> R	<input type="checkbox"/> L <input type="checkbox"/> R	<input type="checkbox"/> PP <input type="checkbox"/> RF			
	Slim	<input type="checkbox"/> U-ion Battery <input type="checkbox"/> 110v AC/DC Power				<input type="checkbox"/> L <input type="checkbox"/> R	<input type="checkbox"/> L <input type="checkbox"/> R	<input type="checkbox"/> PP <input type="checkbox"/> RF			
	Slim	<input type="checkbox"/> U-ion Battery <input type="checkbox"/> 110v AC/DC Power				<input type="checkbox"/> L <input type="checkbox"/> R	<input type="checkbox"/> L <input type="checkbox"/> R	<input type="checkbox"/> PP <input type="checkbox"/> RF			
	Slim	<input type="checkbox"/> U-ion Battery <input type="checkbox"/> 110v AC/DC Power				<input type="checkbox"/> L <input type="checkbox"/> R	<input type="checkbox"/> L <input type="checkbox"/> R	<input type="checkbox"/> PP <input type="checkbox"/> RF			

MOTORIZED TRAVERSE COORDINATING ACCESSORIES AND ADDITIONAL FEES
Order finals, cuffs & collars, additional brackets and accessories here.

Item #	Finish Code	Description	Qty	Price per Unit	Subtotal

Glide and Bracket Information

Quantity included per system based on cut track length

4'	5'	6'	7'	8'	9'	10'	11'	12'	13'	14'	15'	16'	17'	18'	19'	20'	21'	22'	23'	24'
16	20	24	28	32	36	40	44	48	52	56	60	64	68	72	76	80	84	88	92	96
2	3	4	4	4	4	5	5	5	6	6	6	6	7	7	7	8	8	8	8	8

Glides [4 per foot, includes master carriers & end caps (2)]

Brackets

Special Instructions

TOTAL

*When ordering Ripplefold carriers, answer these questions

1. Select Ripplefold fullness:
 60% 80% 100% 120%

2. Select Ripplefold masters:
 Butt Master Overlap

Fascia Profiles for Motorized Heavy Duty Systems

1 3/8"

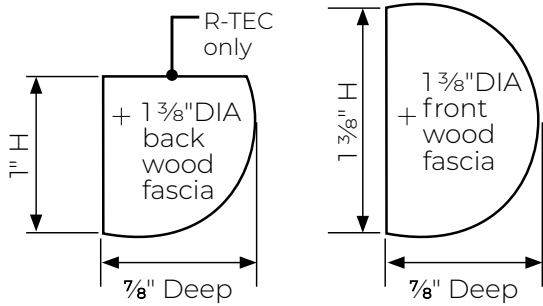

2 1/4"

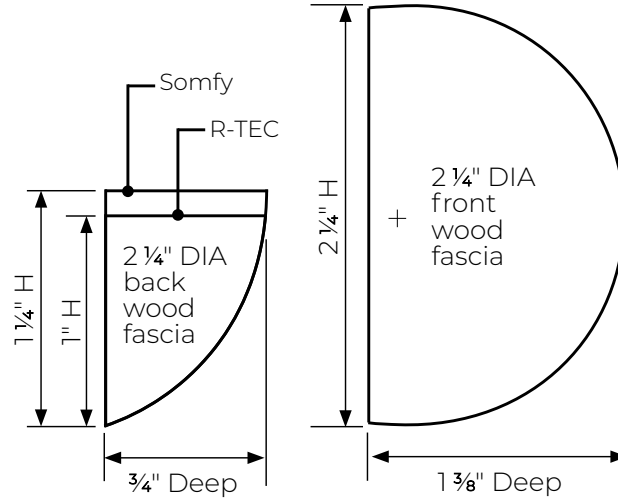

Flat

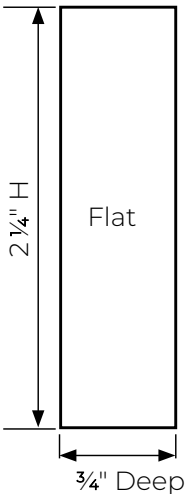

*Fascia Profile is not available for back track in double systems and does not accept finials.

Slim Round

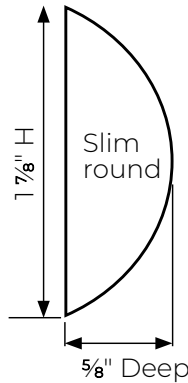

*Fascia Profile is not available for back track in double systems and does not accept finials.

R-TEC AUTOMATION® Motorized Heavy Duty Traverse Systems

Create a commercial look with the benefits of motorization using our R-TEC Automation® Track.

The slim drapery motor is designed to install seamlessly behind the drapery panel with quiet start / stop operation, the ability to easily charge without having to remove the motor and up to 500 open and close cycles per charge, providing the ultimate integrated functionality without compromising the look of your window treatment.

Decorative wood fascia available in 1 3/8" or 2 1/4" smooth, reeded or grooved / fluted profiles with coordinating finials, 1 7/8" slim round smooth profile, 2 1/4" flat smooth profile with flush ends or mitered returns.

Select from 35 Portfolio Hand Painted Finishes, PTH Perfect Match™ or 5 Quick Ship Wood and Resin Finishes.

Single



Single Traverse System With Fascia

- Standard single brackets are adjustable: 2 7/8" - 3 1/4" return
- Longer return bracket options may be substituted at no charge
- Traverse system includes track, fascia, motor, power option, drive belt & clips, pulleys, pendants, brackets, glides, master carriers and a Push5 handheld remote with wall mount
- Coordinates with all fascia profiles
- 1 3/8" and 2 1/4" finials and additional remote options sold separately

Double



(front fascia shown; front and back fascia also available)

Double Traverse System With Fascia

- Standard double brackets are 5 1/4" front return and 2" back return
- Longer return bracket options may be substituted at no charge
- Traverse system includes tracks, fascia(s), motors, power options, drive belt & clips, pulleys, pendants, brackets, glides, master carriers and a Push5 handheld remote with wall mount
- Coordinates with all fascia profiles
- 1 3/8" and 2 1/4" finials and additional remote options sold separately



Single Traverse System With Mitered Returns

- Standard single brackets are adjustable: 2 7/8" - 3 1/4" return
- Longer return bracket options may be substituted at no charge
- Traverse system includes track, fascia, motor, power option, drive belt & clips, pulleys, pendants, brackets, glides, master carriers and a Push5 handheld remote with wall mount
- Coordinates with all fascia profiles
- Additional remote options sold separately



(front fascia shown; front and back fascia also available; mitered returns on front only)

Double Traverse System With Mitered Returns

- Standard double brackets are 5 1/4" front return and 2" back return
- Longer return bracket options may be substituted at no charge
- Traverse system includes tracks, fascia(s), motors, power options, drive belt & clips, pulleys, pendants, brackets, glides, master carriers and a Push5 handheld remote with wall mount
- Coordinates with all fascia profiles
- Additional remote options sold separately



Single or Double Traverse System Without Fascia

- Standard single brackets are adjustable: 2 1/8" - 3 1/4" return
- Standard double brackets are adjustable 4 5/8" - 5 1/4" front return and adjustable 2" - 2 7/16" back return
- Longer return bracket options may be substituted at no charge
- Traverse system includes track(s), motor(s), power option(s), drive belt & clips, pulleys, pendants, brackets, glides, master carriers and a Push5 handheld remote with wall mount
- Available with no fascia; ceiling mount only available without fascia
- Additional remote options sold separately



(back track shown with fascia & finials)

Stationary Front Pole With Back Traverse

- Traverse system coordinates with all 2 1/4" round fascia profiles; flat and slim fascia may not be used
- Coordinates with 2 1/4" poles for stationary front pole; back track available with or without wood fascia.
- Stationary front pole and TBKT bracket are included
- Finials and additional remote options sold separately
- Full rings available on stationary

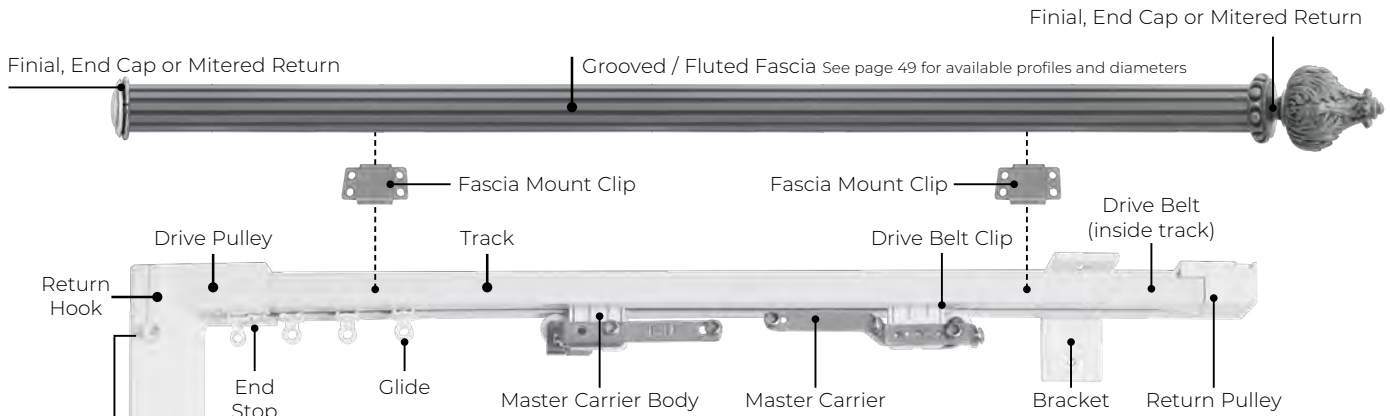

Included in System: R-TEC Automation® Track(s), Fascia(s), Brackets, Components, Motor(s), Power Option(s) & Push5 Handheld Remote with Wall Mount

System requirements:
1 Drive Pulley & 1 Return Pulley for One-Way Draw;
2 Drive Pulleys for Center Draw

Slim Drapery Motor* (can be top mounted)

Li-ion Battery shown (110v AC/DC Power Transformer option available)

R-TEC Automation® Slim Drapery Motor

- Slim Drapery Motor, 1 per track
- Maximum drapery weight: 110 lbs
- Maximum track length: 36'
- Power Option: Li-ion Battery (includes Battery Charger & USB Cable) or 110v AC/DC Power Transformer (includes 10' Cord with 3 Conductor Male Plug)
- Motor can be mounted on right or left for Center Draw, or top mounted
- Return Hooks/Snaps included; available in white or bronze /BR
- Motor available in white
- 5 Year Warranty



R-TEC Automation® Push5 Handheld Remote with Wall Mount RTMHR5C

- 5 Channel Remote with simple buttons.
- 4 3/4" H x 2" W x 3/8" D
- 1 Remote Control per system
- Range: 65'
- Programmable Favorite Position to set your favorite drapery position
- Off-White

R-TEC Automation® Track

- Track sold in 1 foot increments, 4' minimum
- Maximum continuous length is 19'; spliced lengths up to 36'
- Available in white or bronze /BR
- May be ordered with or without Fascia
- Fascia options shown on page 49

*Tandem alternative option: see page 52 for details.

Motor & Power Options



Slim Drapery Motor RTMLDSS50



Li-ion Battery RTMLDSSB



Battery Charger RTMLDSSBC



USB Charger Cable RTMLDSSUSB



110v AC/DC Power Transformer 10' (plug included) RTMDSSPT

Motor Weight Capacity

Use the Motor Weight Capacity chart below to determine if the slim drapery motor accommodates your length of track and your drapery weight. The System Features chart on the next page lists the varied functions of the motor.

		maximum drapery weight per total length of system (lbs)									
Motor		18' or less	20'	22'	24'	26'	28'	30'	32'	34'	36'
R-TEC AUTOMATION®	Slim Drapery Motor	110	110	110	110	110	110	110	110	110	110

Note: Capacity ratings are based on internal system friction only. External loads caused by fabric friction, drag or obstructions will adversely affect pulling capacity or stop motor due to resistance. **Maximum System Lengths:** If you need more than the maximum spliced length for a system, two one-way systems can butt against each other behind fascia. Must be specified on your order form. An additional arm component is needed to create an overlap between the two individual systems; sold separately.

System Features	R-TEC Automation® Slim Drapery Motor
System Features	
Center Draw or One-Way Draw Available	X
White or Bronze Track, Components & Brackets Available	X
Track Maximum Length	36'
Maximum Number of Track Splices	2
Motor Features	
Battery Power Option	X
Motor Cord Length as Purchased	10' (custom length up to 20' available)
2-Way RF Communication	X
Adjustable Speed	X
Preferred Open / Close Position	X
Favorite Position	X
Obstruction Detection	X
Manual Override	X
Quiet Operation	X
Soft Start / Stop	X
Average Linear Speed	5.5" (14 cm)/sec
Motorized Track Noise Level	44 dB
Maximum Weight	110 lbs
Motor Unit can be Installed on Either End of Track	X
Control Options	
Sun Control	X
Digital Technology	ARC™
Solar Power	X
Installation Features	
Programming Buttons on Motor Unit	X
Power Supply	Li-Ion Battery or 110v AC/DC Power Transformer
Amperage	1.3 A
Power Consumption	20 W
Power Cable Type	3 Conductor Male Plug
Standard Accessories Included with System	
5 Channel Handheld Remote with Wall Mount (Remote Control; White)	X
Carrier Features	
White or Bronze Pinch Pleat Glides	X
White or Bronze Ripplefold Glides (Choose 60%, 80%, 100% or 120% Fullness)	X

Additional R-TEC Smart Controls

can be ordered at additional cost



MT02-0401-067001 **Automate™ Pulse 2 Hub**; 2-way RF; Wi-Fi built in
 · 4 ½" H x 1 ¼" W x 4 ½" D
 · Range: 60'



RTMHRIC Handheld Remote with Wall Mount, 1 Channel
 · 5 ⅜" H x 1 ¼" W x ½" D
 · Range: 65'
 · Available in White



RTMHR5C Push5 Handheld Remote with Wall Mount, 5 Channel
 · 4 ¾" H x 2" W x ⅜" D
 · Range: 65'
 · Available in Off-White



RTMHRP15C (/K) Push15 Handheld Remote with Wall Mount, 15 Channel
 · 4 ¾" H x 2" W x ⅜" D
 · Range: 65'
 · Available in White or Black



RTMHR15C Handheld Remote with Wall Mount, 15 Channel
 · 5 ⅜" H x 1 ¼" W x ½" D
 · Range: 65'
 · Available in White



RTMW5R5C Surface Mount Wall Switch, 5 Channel
 · 4 ½" H x 2 ¾" W x ⅞" D
 · Range: 65'
 · Available in White



RTMWCR1C RTMWCR2C RTMWSR15C Cut-In Wall Mount Switch, 1, 2 or 15 Channel
 · 4 ½" H x 2 ¾" W x 1" D
 · Range: 65'
 · Available in White
 · RTMSMB/W required for installation



RTMISS Interior Sun Sensor
 · 1 ¾" H x 1 ¾" W x ⅝" D
 · Range: 65'
 · Available in White



RTMUSR ARC™ USB Signal Repeater
 · 2" L x 2 ½" L with USB x 1 ⅝" W
 · Extends the wireless range of the Hub and remotes up to 60'
 · Maximum 2 repeaters per system or network
 · Available in White (color may vary)



RTMLDSSBC Wall Charger for USB Signal Repeater
 · 1 ⅞" W x 1 ⅜" L
 · Available in White (color may vary)



RTMSOLAR2 Solar Panel Battery Charger
 · 4 ⅝" H x 12 ⅝" W x 1 ⅜" D
 · Includes I-bracket, cables & fastener



Control your window coverings with a smartphone or tablet. The Automate™ Pulse 2 App enables simple, intuitive control and system configuration from your smartphone or tablet.



Pair the Automate™ Pulse 2 Hub and App with these systems:



(not sold by Rowley):

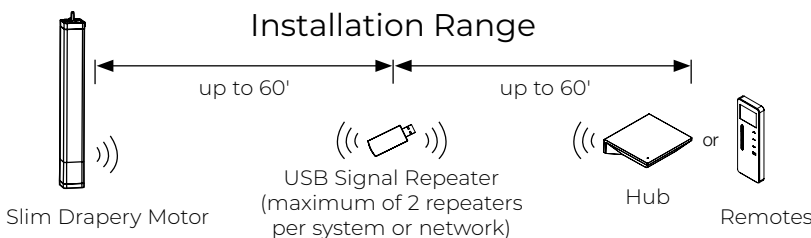

ECO friendly

R-TEC Motorized Heavy Duty Traverse Systems Pricing

Li-ion Battery or 110v AC/DC Power, Ripplefold or Pinch Pleat

Item #	Name	4'	5'	6'	7'	8'	9'	10'	
Motorized Traverse System with Wood Fascia									
Single Track System with Wood Fascia for 1 3/8" round									
CSRPTH138WF	R-TEC Slim Drapery Motor	\$1,897.08	\$1,975.20	\$2,053.33	\$2,131.45	\$2,209.57	\$2,287.69	\$2,365.81	
Double Track Systems with Wood Fascia Front Only for 1 3/8" round									
CSRPTH138WFFDBL	R-TEC Slim Drapery Motor	\$3,370.91	\$3,495.67	\$3,620.43	\$3,745.19	\$3,869.95	\$3,994.72	\$4,119.48	
Double Track System with Wood Fascia Front and Back for 1 3/8" round									
CSRPTH138WFDL	R-TEC Slim Drapery Motor	\$3,794.16	\$3,950.41	\$4,106.65	\$4,262.90	\$4,419.14	\$4,575.38	\$4,731.63	
Single Track System with Wood Fascia for 1 7/8" slim, 2 1/4" flat smooth or 2 1/4" round									
CSRPTH214WF	R-TEC Slim Drapery Motor	\$2,050.99	\$2,207.24	\$2,363.48	\$2,519.73	\$2,675.97	\$2,832.21	\$2,988.46	
Double Track Systems with Wood Fascia Front Only for 1 7/8" slim, 2 1/4" flat smooth or 2 1/4" round									
CSRPTH214WFFDBL	R-TEC Slim Drapery Motor	\$3,524.82	\$3,727.70	\$3,930.59	\$4,133.47	\$4,336.35	\$4,539.24	\$4,742.12	
Double Track System with Wood Fascia Front and Back for 2 1/4" round									
CSRPTH214WFDL	R-TEC Slim Drapery Motor	\$4,101.99	\$4,414.48	\$4,726.96	\$5,039.45	\$5,351.94	\$5,664.43	\$5,976.92	
Double Track Systems with Stationary Front Only 2 1/4" Wood Pole									
CSRPTH214SDBL	R-TEC Slim Drapery Motor	\$1,944.89	\$2,164.10	\$2,359.98	\$2,555.87	\$2,751.76	\$2,947.65	\$3,143.54	
Double Track Systems with Stationary Front 2 1/4" Wood Pole & Wood Fascia Back for 2 1/4" round									
CSRPTH214WFBSDBL	R-TEC Slim Drapery Motor	\$2,545.38	\$2,850.87	\$3,156.36	\$3,461.85	\$3,767.35	\$4,072.84	\$4,378.33	

Motorized Traverse System without Wood Fascia

Item #	Name	4'	5'	6'	7'	8'	9'	10'	
Single Track System track available in white and bronze									
CSRPTHTRACK	R-TEC Slim Drapery Motor	\$1,473.82	\$1,520.46	\$1,567.10	\$1,613.74	\$1,660.38	\$1,707.02	\$1,753.66	
Double Track System track available in white and bronze									
CSRPTHTRACKDBL	R-TEC Slim Drapery Motor	\$2,947.65	\$3,040.93	\$3,134.21	\$3,227.49	\$3,320.77	\$3,414.05	\$3,507.33	

Additional R-TEC Traverse Fees

PTHFEEMITER-EACH Wood Fascia Mitered Return per return	\$80.00
PTHFEEMITER-45 Wood Fascia Mitered Cut 45° angle (90° corner) per connection	\$65.00
PTHFEEMITER-NON45 Wood Fascia Mitered Cut non-45° angle (non-90° corner) per connection	\$65.00
PTHFEEBLEND Blended Fascia Splice per blend	\$108.00
PTHFEEFASCUT Fascia Fabrication Fee (if ordering fascia alone, order full pole and specify fascia fabrication) per Fascia	\$65.00
PTHFEERESTRING Restraining Fee per track	\$100.00
Standard 45 Fascia Splice	No Charge

Item #	Name	NET Price
R-TEC Automation® Motor Kits		
RTMLDKIT	Slim Drapery Motor with Li-ion Battery, Wall Charger & USB Cable (included)	\$371.00
RTMLDS2KIT	Slim Drapery Motor with Li-ion Battery & Solar Panel Charger	\$498.20
RTMLDACKIT	Slim Drapery Motor with 110v AC/DC Power Transformer 10' with 3 Conductor Male Plug	\$312.70

Quantity Per System

	4'	5'	6'	7'	8'	9'	10'	11'	12'	13'	14'	15'	16'	17'	18'	19'
Pinch Pleat Glides	21	27	33	38	44	50	55	61	67	72	78	84	89	95	100	106
Brackets	3	4	4	5	5	6	6	7	7	8	8	9	9	10	10	11

Motorized Stack Back Calculation (each drapery panel)

R-TEC: master carrier + (# glides on panel x carrier width) + 3.375" = stack per drapery panel

Ex: R-TEC Automation® 10ft. center draw, pinch pleat (standard 4 glides per ft.)
 4.2" + [(40/2) x .563"] + 3.375" = 18.84" stack, for each panel BEFORE drapery fabric is installed

Please note: Calculations result in Stack Back Width BEFORE drapery fabric is installed. Stack back width will increase once draperies are installed. Factors such as thickness of drapery fabric, type of drapery pleat, and fullness of treatment affect the final stack back width. Please consult your workroom to determine your final stack back based on your draperies.

Orders with R-TEC motorized traverse systems will incur a \$25 packaging fee.

Orders that contain a Li-ion battery will be charged a \$25.00 shipping surcharge.

Available in all profiles for 1 3/8", 1 7/8" and 2 1/4" diameter fascias or without a wood fascia.

Systems are sold in 1 ft increments

Pricing Includes R-TEC Automation® Track, Brackets, Components, Motor, Power Option & Push5 Channel Handheld Remote with Wall Mount

Spliced systems begin at 19'

	11'	12'	13'	14'	15'	16'	17'	18'	19'	per add'l ft
	\$2,443.94	\$2,522.06	\$2,600.18	\$2,678.30	\$2,756.42	\$2,834.55	\$2,912.67	\$2,990.79	\$3,068.91	\$78.12
	\$4,244.24	\$4,369.00	\$4,493.76	\$4,618.53	\$4,743.29	\$4,868.05	\$4,992.81	\$5,117.57	\$5,242.34	\$124.76
	\$4,887.87	\$5,044.12	\$5,200.36	\$5,356.60	\$5,512.85	\$5,669.09	\$5,825.34	\$5,981.58	\$6,137.82	\$156.24
	\$3,144.70	\$3,300.95	\$3,457.19	\$3,613.43	\$3,769.68	\$3,925.92	\$4,082.17	\$4,238.41	\$4,394.65	\$156.24
	\$4,945.01	\$5,147.89	\$5,350.77	\$5,553.66	\$5,756.54	\$5,959.43	\$6,162.31	\$6,365.19	\$6,568.08	\$202.88
	\$6,289.40	\$6,601.89	\$6,914.38	\$7,226.87	\$7,539.36	\$7,851.84	\$8,164.33	\$8,476.82	\$8,789.31	\$312.49
	\$3,339.42	\$3,535.31	\$3,731.20	\$3,927.09	\$4,122.98	\$4,318.86	\$4,514.75	\$4,710.64	\$4,906.53	\$195.89
	\$4,683.82	\$4,989.31	\$5,294.81	\$5,441.80	\$5,905.79	\$6,211.28	\$6,516.77	\$6,822.27	\$7,127.76	\$305.49

Spliced systems begin at 19'

	11'	12'	13'	14'	15'	16'	17'	18'	19'	per add'l ft
	\$1,800.30	\$1,846.94	\$1,893.58	\$1,940.22	\$1,986.86	\$2,033.50	\$2,080.14	\$2,126.78	\$2,173.42	\$46.64
	\$3,600.61	\$3,693.89	\$3,787.17	\$3,880.45	\$3,973.73	\$4,067.01	\$4,160.29	\$4,253.57	\$4,346.85	\$93.28

Item #	Name	NET Price
R-TEC Motor & Components		
RTMLDSS50	Slim Drapery Motor	\$212.00
RTMLDSSB	Li-ion Battery	\$127.20
RTMLDSSBC	Battery Wall Charger	\$15.90
RTMLDSSUSB	USB Cable	\$15.90
RTMDSSPT	110v AC/DC Power Transformer 10' with 3 Conductor Male Plug	\$74.20
RTMDSSPTCS	110v AC/DC Power Transformer 20' (plug RTMP sold separately) specify ft.	\$79.50
RTMP	3 Conductor Male Plug	\$26.50

PTH Motorized Traverse Tips

- Specified custom cut length indicates track length including drive gears; fascia will be 1/4" longer at each end of track (1/2" total); mitered fascia will add the following to the traverse system:

Fascia	Depth	+ to traverse system
1 3/8"	7/8"	2"
2 1/4"	1 3/8"	3"
Flat	3/4"	1 3/4"
Slim Round	5/8"	1 1/2"

- Track and fascia will be spliced in the center of overall length.
- Blended fascia is available for an additional fee per blend; PTH will properly connect splice(s) and ship your fascia in one continuous length.
- Back fascia can accommodate decorative end caps; decorative end caps sold separately.
- R-TEC Motorized Traverse Systems carry a 5 year warranty; WARNING Modifications of internal components will void R-TEC warranties.

Item #	Name	Color	NET
R-TEC Smart Controls <i>Push5 Handheld Remote with Wall Mount - 5 channel included</i>			
RTMHRIC	Handheld Remote with Wall Mount, 1 ch	White	\$68.90
RTMHR5C	Push5 Handheld Remote with Wall Mount, 5 ch	Off-White	\$74.20
RTMHRP15C RTMHRP15C/K	Push15 Handheld Remote with Wall Mount, 15 ch	White or Black	\$79.50
RTMHR15C	Handheld Remote with Wall Mount, 15 ch	White	\$90.10
RTMWSR5C	Surface Wall Mount Switch, 5 ch	White	\$74.20
RTMWCRIC	Cut-In Wall Mount Switch, 1 ch*	White	\$53.68
RTMWCR2C	Cut-In Wall Mount Switch, 2 ch*	White	\$59.99
RTMWSR15C	Cut-In Wall Mount Switch, 15 ch*	White	\$79.50
RTMSMB/W	*Surface Mount Wall Back Box	White	\$9.01
MT02-0401-067001	Wi-Fi to ARC Bridge Hub-2-Way RF-includes USB Power Cord, Power Plug & Ethernet Cable	White	\$270.30
RTMISS	Interior Sun Sensor	White	\$47.70
RTMUSR	ARC USB Signal Repeater	White	\$127.20
RTMLDSSBC	Wall Charger for USB Signal Repeater	White	\$15.90
RTMSOLAR2	Solar Panel Battery Charger-includes L-Bracket, Cables & Fastener	Black	\$127.20

*RTMSMB/W required for installation.

R-TEC Motorized Heavy Duty Traverse Systems Finishes

Decorative wood fascia available in 1 3/8" or 2 1/4" smooth, reeded or grooved / fluted profiles with coordinating finials, 1 7/8" slim round smooth profile, 2 1/4" flat smooth profile with flush ends or mitered returns. See next page for Fascia Profiles. Select from 35 Portfolio Hand Painted Finishes, PTH Perfect Match™ or 5 Quick Ship Wood and Resin Finishes.

Diameter	Wood Fascia Finish	Track and Bracket* Color	Component Color	Max. Continuous Length
1 3/8" or 2 1/4" smooth, reeded or grooved / fluted profiles with coordinating finials	Amulet	White	White	16'
	Andiron	White	White	16'
	Antique Gold	White	White	16'
	Antique Gold Leaf	White	White	16'
	Art Bronze	Bronze	Bronze	16'
	Barnwood	Bronze	Bronze	16'
	Black	Bronze	Bronze	16'
	Blush	White	White	16'
	Bronzed Pewter	Bronze	Bronze	16'
	Concrete	White	White	16'
	Couture	White	White	16'
	Dark Chocolate	Bronze	Bronze	16'
	Firelight	White	White	16'
	Gossamer	Bronze	Bronze	16'
	Greige	White	White	16'
1 7/8" slim round smooth profile	Halo	White	White	16'
	Java	Bronze	Bronze	16'
	Linen	White	White	16'
	Luminous	Bronze	Bronze	16'
	Manor	White	White	16'
2 1/4" flat smooth profile	Mink	Bronze	Bronze	16'
	Moonlight	Bronze	Bronze	16'
	Mystic	White	White	16'
	New Age Bronze	Bronze	Bronze	16'
	With flush ends or mitered returns	Patina	White	White
Shimmer		Bronze	Bronze	16'
Silver Maple		White	White	16'
Spicewood		Bronze	Bronze	16'
Spun Gold		White	White	16'
Stardust		White	White	16'
Starlet		White	White	16'
Titanium		White	White	16'
Truffle		Bronze	Bronze	16'
Urban Bronze		Bronze	Bronze	16'
White		White	White	16'
PTH Perfect Match™		please specify	please specify	16'
Antique Brass		White	White	12'
Oil Rubbed Bronze		Bronze	Bronze	12'
Platinum		White	White	12'
Rose Gold	White	White	12'	
Walnut	Bronze	Bronze	12'	

White brackets may be substituted upon request.

Motorized Heavy Duty Traverse Systems Fascia Profiles



Smooth

- 1 3/8" and 2 1/4" diameters available with R-TEC Systems
- 2 1/4" diameter available with Somfy Systems
- See below for coordinating finial options



Reeded

- 1 3/8" and 2 1/4" diameters available with R-TEC Systems
- 2 1/4" diameter available with Somfy Systems
- See below for coordinating finial options



Grooved / Fluted

- 1 3/8" and 2 1/4" diameters available with R-TEC Systems
- 2 1/4" diameter available with Somfy Systems
- See below for coordinating finial options

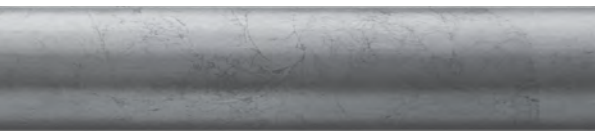

Slim Round Smooth, No Finials

- 1 7/8" diameter, available with flush ends or mitered returns

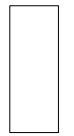

Flat Smooth, No Finials

- 2 1/4" height, available with flush ends or mitered returns



Mitered Returns (sold separately)

- 1 3/8", 1 7/8" and 2 1/4" diameters available
- All profiles

Upgrade your Motorized HD Traverse with Finial Styles

Finials are sold separately. 1 3/8" or 2 1/4" Portfolio and Quick Ship Wood and Resin finials are compatible across two style categories. Somfy systems are not available with 1 3/8" fascias and finials.



1 3/8" Portfolio page 17 | 1 3/8" Quick Ship page 97 | 2 1/4" Portfolio page 22 | 2 1/4" Quick Ship page 102



1 3/8" Portfolio page 17 | 1 3/8" Quick Ship page 97 | 2 1/4" Portfolio page 23 | 2 1/4" Quick Ship page 102

R-TEC Motorized Heavy Duty Traverse Systems Brackets



R-TEC Single TB035-R /BR	2 11/16" H x 1 1/2" W backplate, adjustable up to 3 1/4" return Available in white or bronze /BR.	\$33.52 each
R-TEC Single or Double TB060-R /BR	3 5/16" H x 1 1/2" W backplate, 5 1/4" front return and 2" back return Available in white or bronze /BR.	\$53.64 each
R-TEC Single, Double or Triple TB100-R /BR	4 1/2" H x 1 1/2" W backplate, adjustable up to 9" return Available in white or bronze /BR.	\$53.64 each
Ceiling Mount Clip Single RTMDTBCM	1/4" H x 2 1/4" D x 1 1/16" W May only be used in systems without fascia. <i>For double ceiling mount installation, install two brackets into ceiling.</i> Available in white.	\$3.18 NET each
Fascia Mount Clip RTMDTFC	1/2" H x 1" W Use to attach fascia to traverse systems; included. Available in zinc.	\$2.65 NET each

R-TEC Single Motorized Bracket
TB035-R

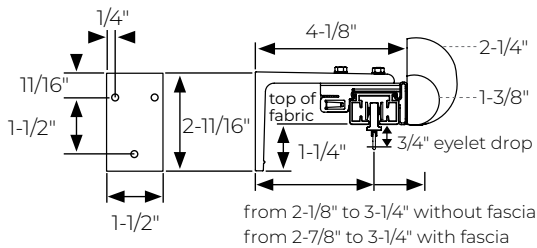

R-TEC Single or Double Motorized Bracket
TB060-R

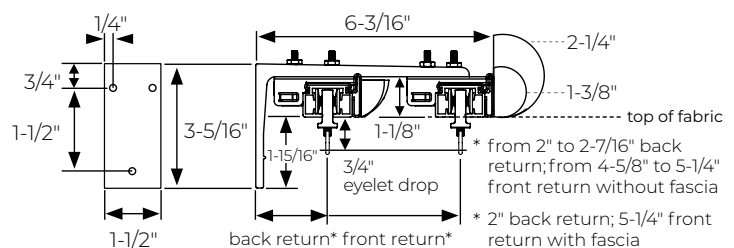

R-TEC Single, Double or Triple Motorized Bracket
TB100-R

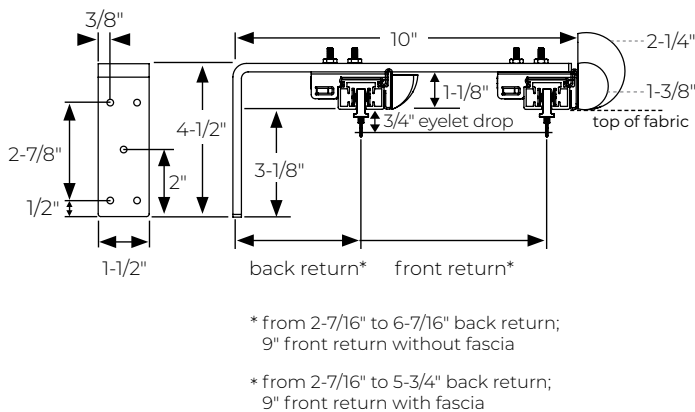

R-TEC Ceiling Mount Bracket
RTMDTBCM

Please note: Ceiling Bracket will not accommodate fascia and finials.

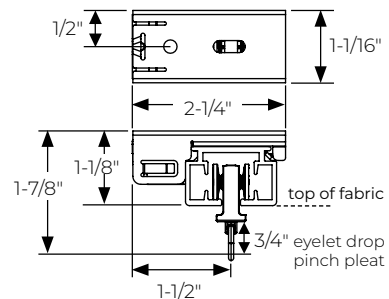



Custom Over-Bracket Single
TBKT214-R

3 1/2" H x 3/4" W backplate, 7 7/8" front return and 3" back return
Use to combine 2 1/4" full wood pole with single traverse systems;
includes traverse ceiling mount bracket attached onto the bottom of the over-bracket.

Steel

*Available in any of our 35 Portfolio hand painted finishes, 5 Quick Ship Wood & Resin finishes or PTH Perfect Match™

\$93.86 each



Custom Ceiling Single
CMTB-R

2 3/4" H x 3/4" W backplate
for double ceiling mount installation, install two brackets into ceiling.

Steel

*Available in any of our 35 Portfolio hand painted finishes, 5 Quick Ship Wood & Resin finishes or PTH Perfect Match™

When ordering, specify:

- A. Fascia diameter and profile.
- B. Projection to carrier and/or to front of fascia.
- C. Drop from ceiling to carrier eyelet and/or from ceiling to top of fascia (tip: finial must clear ceiling).
- D. Width of mounting plate if longer than 2 3/4".

\$80.45 each

R-TEC Custom Traverse Bracket

TBKT214-R

Available in any Portfolio or PTH Perfect Match™ painted finish, or our 5 Quick Ship Wood & Resin finishes.

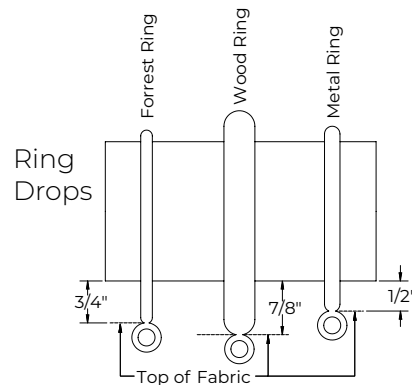
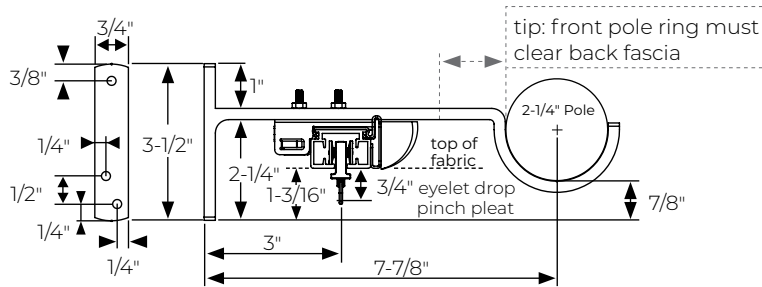

R-TEC Custom Traverse Ceiling Bracket

CMTB-R

Available in any Portfolio or PTH Perfect Match™ painted finish, or our 5 Quick Ship Wood & Resin finishes.

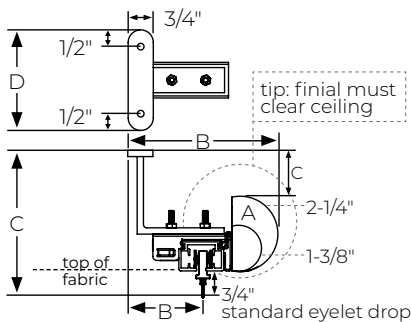

When ordering, specify:

- A. Fascia diameter and profile.
- B. Projection to carrier and/or to front of fascia.
- C. Drop from ceiling to carrier eyelet and/or from ceiling to top of fascia (tip: finial must clear ceiling).
- D. Width of mounting plate if longer than 2 3/4".

R-TEC Motorized Heavy Duty Traverse Systems Information

Carriers for additional carriers.

Pinch Pleat Glides



See page 39 for diagrams.

Pinch Pleat Glides

CP40 CP40/BR **/BR**

Wheel for smooth movement. Available in white or bronze /BR.

Included in system; additional glides may be ordered separately.

\$3.45 NET pack (10 pieces)

Ripplefold® Style Glides



See page 39 for diagrams.

Ripplefold® Style Glides

R4060/P R4060/P/BR **/BR**
R4080/P R4080/P/BR
R4100/P R4100/P/BR
R4120/P R4120/P/BR

Ripplefold Glides with detachable pendants. 60%, 80%, 100% or 120% fullness - specify fullness on order. Available in white or bronze /BR.

Included in system; additional glides may be ordered separately.

\$0.67 NET each

Master carrier body is required for each master carrier arm - sold separately; look for the /BR icon for components available in bronze and add /BR at the end of the item number to order.



Master Carrier Body

RTMDTMCB
RTMDTMCB/BR **/BR**

Select from different arms to assemble into one MC Body; order two if ordering Center Draw MC Arms - sold separately. Available in white or bronze /BR.

\$4.24 NET each



Overlap Master Carrier Arms for Center Draw

RTMDTCD

Pair. Pinch pleat or Ripplefold; order two MC Bodies - sold separately. Available in Stainless Steel only.

\$5.04 NET pair*



Tandem Master Carrier Arms for Center Draw

RTMDTCDTAN

Pair. Pinch pleat or Ripplefold; order two MC Bodies - sold separately. Available in Stainless Steel only.

\$7.42 NET pair*



Master Carrier Arm for One-Way Draw

RTMDTOR
RTMDTOL

Right (R) or Left (L). Pinch pleat or Ripplefold; order one MC Body - sold separately. Available in Stainless Steel only.

\$2.92 NET each



Ripplefold Butt Master Carrier Arms for Center Draw

RTMDTCDB

Pair. Ripplefold only; order two MC Bodies - sold separately. Do not overlap, allowing some light to filter between draperies on center draw treatments. Available in Stainless Steel only.

\$5.79 NET pair*



Ripplefold Butt Master Carrier Arm for One-Way Draw

RTMDTOB

Right and left use. Ripplefold only; order one MC Body - sold separately. Available in Stainless Steel only.

\$2.92 NET each

Tandem Alternative

Tandem alternative ARCTM motorized systems utilize two drapery motors and are used for draperies that exceed the maximum single motor capacity, available in center draw only. Use Tandem Center Draw Overlap Arms RTMDTCDTAN (for pinch pleat or ripplefold draperies) or two Butt Master One-Way Draw Arms RTMDTOB (for ripplefold draperies only).

R-TEC Motorized Carrier Diagrams

R-TEC Motorized Heavy Duty Traverse ONLY
 Universal Master Carrier Arms, Center Draw
 RTMDTCD

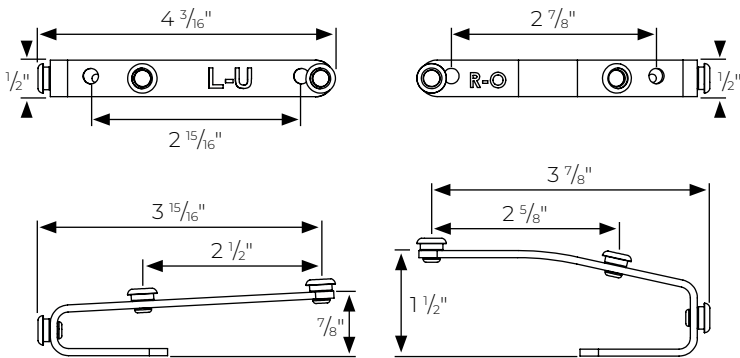

R-TEC Motorized Heavy Duty Traverse ONLY
 Universal Master Carrier Arm, One-Way Draw
 Right - RTMDTOR or Left - RTMDTOL

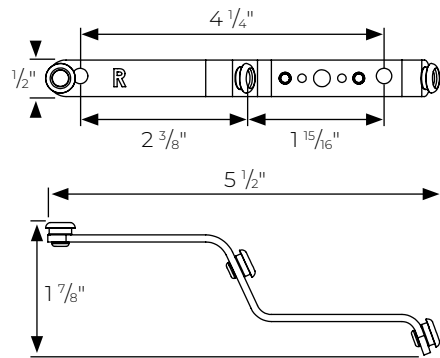

R-TEC Motorized Heavy Duty Traverse ONLY
 Universal Tandem Master Carrier Arms, Center Draw
 RTMDTCDTAN (see page 52 for details)

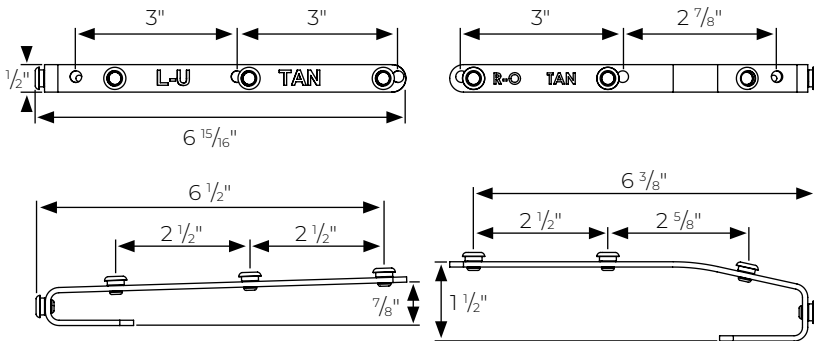

R-TEC Motorized Heavy Duty Traverse ONLY
 Ripplefold Butt Master Carrier Arm, One-Way Draw, Right or Left - RTMDTOB

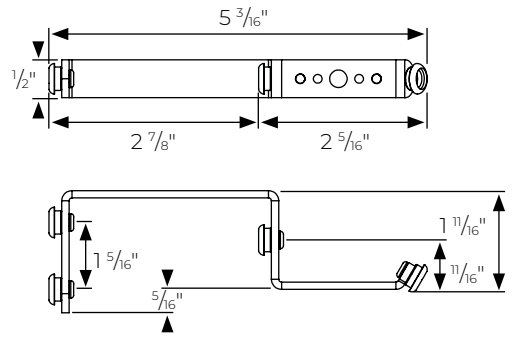

R-TEC Motorized Heavy Duty AND 1 3/8" Metal Traverse
 Ripplefold Butt Master Carrier Arms, Center Draw
 RTMDTCDB

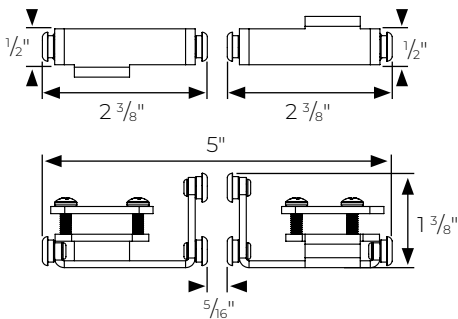

1 3/8" R-TEC Motorized Metal Traverse ONLY
 Ripplefold Butt Master Carrier Arm, One-Way Draw
 Right - RTPTH138OBR or Left - RTPTH138OBL

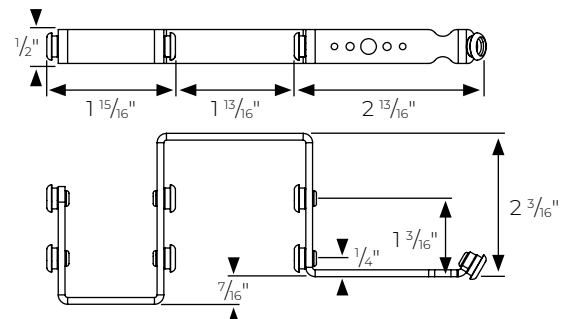

1 3/8" R-TEC Motorized Metal Traverse ONLY
 Pinch Pleat / Ripplefold Master Carrier Arms, Center Draw
 RTPTH138CD

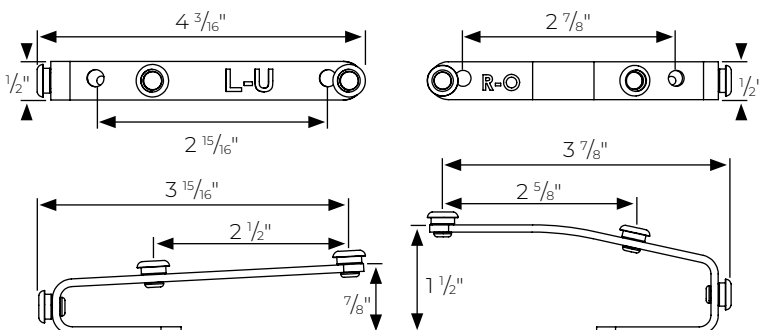

1 3/8" R-TEC Motorized Metal Traverse ONLY
 Pinch Pleat Master Carrier Arm, One-Way Draw
 Right - RTPTH138PPOR or Left - RTPTH138PPOL

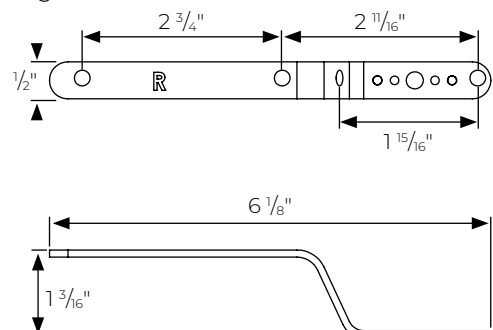

R-TEC Automation® & Somfy Comparison

System Features	R-TEC® Automation® Slim Drapery Motor	Somfy Glydea® ULTRA Motors		Somfy Irisimo™ Motors	
		Heavy Duty	Standard	Standard	Mini
System Features	Slim Drapery Motor	Glydea® ULTRA 60e	Glydea® ULTRA 35e	Irisimo™ 45	Irisimo™ 35
8' System Pricing (Single Track With 2 1/4" Wood Fascia)	\$2,675.97	\$4,139.30	\$3,620.43	\$4,139.30	\$3,620.43
Center Draw or One-Way Draw Available	X	X	X	X	X
White or Bronze Track Available	X	X	X	X	X
White or Bronze Components Available	X	X	X	X	X
Track Maximum Length	36'	36'	32'	33'	32'
Maximum Number of Track Splices	2	2	2	2	2
Minimum Curving Radius		11.8" (30 CM)	11.8" (30 CM)		11.8" (30 CM)
White or Bronze Wall Mount Brackets (Sgl & Dbl)	X	X	X	X	X
White Standard Ceiling Mount Bracket	X	X	X	X	X
1 3/8" Fascia Available	X				
Motor Features	Slim Drapery Motor	Glydea® ULTRA 60e	Glydea® ULTRA 35e	Irisimo™ 45	Irisimo™ 35
Motor Cord Length as Purchased	120" or specify length up to 240"	120"	120"	n/a	158.4"
Touch Motion	X	X	X	X	X
Manual Override	X	X	X	X	X
Soft Start	X	X	X	X	X
Soft Stop	X	X	X	X	X
Speed Control & Adjustment	X	X	X	X	X
Average Linear Speed	5.5 in./s - 8.25 in./s	4.9 in./s - 7.86 in./s (silent: 2.95 in./s)	4.9 in./s - 7.86 in./s (silent: 2.95 in./s)	4.9 in./s - 7.86 in./s	4.9 in./s - 7.86 in./s
Motor Automatically Stops When System Reaches Fully Open or Fully Closed Position	X	X	X	X	X
Adjustable Limits	X	X	X	X	X
Intermediate Position	Favorite Position	My Position	My Position	My Position	My Position
Motorized Track Noise Level	44 db	38 dB in silent mode	38 dB in silent mode	44 dB	44 dB
Maximum Weight	110 lbs	132 lbs	77 lbs	99 lbs	77 lbs
Tandem Alternative Maximum Weight	220 lbs	266 lbs	154 lbs	198 lbs	154 lbs
Motor Unit can be Installed on Either End of Track	X	X	X	X	X
Inverse Mounting of Motor	X	X	X	X	X
Factory Reset	X	X	X	X	X
Control Options***	Slim Drapery Motor	Glydea® ULTRA 60e	Glydea® ULTRA 35e	Irisimo™ 45	Irisimo™ 35
Timer Control		X	X	X	X
Sun Control	X	X	X	X	X
Digital Communication Technology	ARC™	Radio Technology Somfy (RTS)			
Solar Power	X				
Installation Features	Slim Drapery Motor	Glydea® ULTRA 60e	Glydea® ULTRA 35e	Irisimo™ 45	Irisimo™ 35
Programming Buttons on Motor Unit	X	X	X	X	X
Power Supply	Li-ion Battery or 110v AC/DC Power Transformer	120V		25.9 V DC Power (Li-ion Rechargeable)	24V DC Power Supply
Amperage	1.3 A	0.8 A	0.8 A	0.5 A	2 A
Power Consumption	20 W	96 W	96 W	60 W	48 W
Power Cable Type	3 conductor male plug	3 conductor male plug	3 conductor male plug	3 conductor male plug	3 conductor male plug
Certifications	CE	c TUV us, CCC, CE		CE	CE
Standard Accessories Included With System	Slim Drapery Motor	Glydea® ULTRA 60e	Glydea® ULTRA 35e	Irisimo™ 45	Irisimo™ 35
5 Channel Transmitter (Remote Control; White)	X	X	X	X	X
Carrier Features	Slim Drapery Motor	Glydea® ULTRA 60e	Glydea® ULTRA 35e	Irisimo™ 45	Irisimo™ 35
White or Bronze Pinch Pleat or Ripplefold® Style Glides	X	X	X	X	X

*components include: carriers, master carriers, drive gears, return hooks and fascia clips.

**maximum allowable charging current.

***DCT motors are available for Glydea Ultra 60e, 35e and Irisimo 35. Special order required.

Somfy Motorized Heavy Duty Traverse Systems

Motorized System is perfect for all treatments – from lightweight sheers to heavily lined fabrics, and is the ideal solution for treatments mounted where corded systems are not easily reached.

Decorative wood fascia available in 2 1/4" smooth, reeded, grooved / fluted profiles with flush ends or mitered returns. Finials may be ordered separately from 2 1/4" Portfolio or Quick Ship Wood and Resin.

Select from 35 Portfolio Hand Painted Finishes, PTH Perfect Match™ or 5 Quick Ship Wood and Resin Finishes.

Single



Single Traverse System With Fascia

- Standard single bracket is adjustable 2 3/4" - 3 5/8" return
- Longer return bracket options may be substituted at no charge
- Traverse system includes track, fascia, motor, power option, brackets, components and a standard 5 channel remote control
- Coordinates with all fascia profiles
- 2 1/4" finials and additional remote options sold separately



Single Traverse System With Mitered Returns

- Standard single bracket is adjustable 2 3/4" - 3 5/8" return
- Longer return bracket options may be substituted at no charge
- Traverse system includes track, fascia, motor, power option, brackets, components and a standard 5 channel remote control
- Coordinates with all fascia profiles
- Additional remote options sold separately



Single Traverse System Without Fascia

- Standard single bracket is adjustable 2 3/4" - 3 5/8" return
- Longer return bracket options may be substituted at no charge
- Traverse system includes track, motor, power option, brackets, components and a standard 5 channel remote control
- Available with no fascia; ceiling mount only available without fascia
- Additional remote options sold separately

Double



(front fascia shown; front and back fascia also available)
Double Traverse System With Fascia

- Standard double brackets are adjustable 5" - 5 3/8" front return and adjustable 1 3/4" - 2 3/8" back return
- Longer return bracket options may be substituted at no charge
- Traverse system includes tracks, fascia(s), motors, power options, brackets, components and a standard 5 channel remote control
- Coordinates with all fascia profiles
- 2 1/4" finials and additional remote options sold separately



(front fascia shown; front and back fascia also available; mitered returns on front only)
Double Traverse System With Mitered Returns

- Standard double brackets are adjustable 5" - 5 3/8" front return and adjustable 1 3/4" - 2 3/8" back return
- Longer return bracket options may be substituted at no charge
- Traverse system includes tracks, fascia(s), motors, power options, brackets, components and a standard 5 channel remote control
- Coordinates with all fascia profiles
- Additional remote options sold separately



Double Traverse System Without Fascia

- Standard double brackets are adjustable 5" - 5 3/8" front return and adjustable 1 3/4" - 2 1/2" back return
- Longer return bracket options may be substituted at no charge
- Traverse system includes tracks, fascia(s), motors, power options, brackets, components and a standard 5 channel remote control
- Available with no fascia; ceiling mount only available without fascia
- Additional remote options sold separately

Single and Double Systems without Fascia can be curved for an additional fee:

Somfy Glydea®

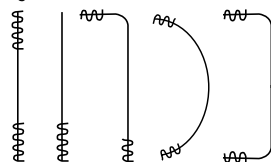

Please note: Somfy Glydea® systems can be curved with a minimum 11.8" radius. All curves require a template. **Curving track reduces weight capacity of motor.** Please refer to motor specifications on page 56.

Somfy Motorized Heavy Duty Traverse Systems Information

Somfy Motorized Track

- Track sold in 1 foot increments, 6' minimum
- Maximum continuous length is 20'; spliced lengths up to 36'
- Includes one motor, standard remote control 5-channel transmitter per track, and fascia with fascia clips when applicable
- Available in white or bronze; track finish will complement fascia finish
- End drive gears available in white
- May be ordered with or without fascia options
- Curved tracks available with minimum 11.8" radius; curving fees apply



Somfy Situo® standard remote control transmitter

- 1870575 (multi-channel handheld remote)
- 5 1/4"H x 1 5/8"W
 - 1 remote control per track
 - 5 channels
 - Programmable My Position to set your favorite drapery position
 - Available in white



Somfy Irismo™ 45 RTS Motor 1002353

- Heavy duty motor, 1 per track
- Maximum drapery weight for motor: 99 lbs
- Maximum length for motor: 33'
- 25.9V Li-ion Battery Power
- Motor can be mounted on right or left for center draw, or top mounted
- Return hooks/snaps included; available in white
- Available in white
- 5 year warranty



Somfy Irismo™ 35 Mini RTS Motor 1003004

- Mini motor, 1 per track
- Maximum drapery weight for mini motor: 77 lbs
- Maximum length for mini motor: 32'
- 24V DC Power Supply cord with plug: 158.4" cord length
- Motor can be mounted on right or left for center draw, or top mounted
- Return hooks/snaps included; available in white
- Available in white
- 5 year warranty



Somfy Glydea® ULTRA 60e RTS Motor 1003159

- Heavy duty motor, 1 per track
- Maximum drapery weight for heavy duty motor: 132 lbs
- Maximum length for heavy duty motor: 36'
- 110V Power Supply cord with plug: 120" cord length
- Motor can be mounted on right or left for center draw, or top mounted; may also be hardwired
- Return hooks/snaps included; available in white
- Available in brushed aluminum
- 5 year warranty (warranty voided if hardwired)



Somfy Glydea® ULTRA 35e RTS Motor 1003152

- Light duty motor, 1 per track
- Maximum drapery weight for light duty motor: 77 lbs
- Maximum length for light duty motor: 32'
- 110V Power Supply cord with plug: 120" cord length
- Motor can be mounted on right or left for center draw, or top mounted; may also be hardwired
- Return hooks/snaps included; available in white
- Available in brushed aluminum
- 5 year warranty (warranty voided if hardwired)

Somfy Motorized Traverse System

includes 1 motor with power supply (1 per track), track(s) with components, brackets, and 1 standard 5 channel transmitter (1 per system), and fascia with fascia clips when applicable.

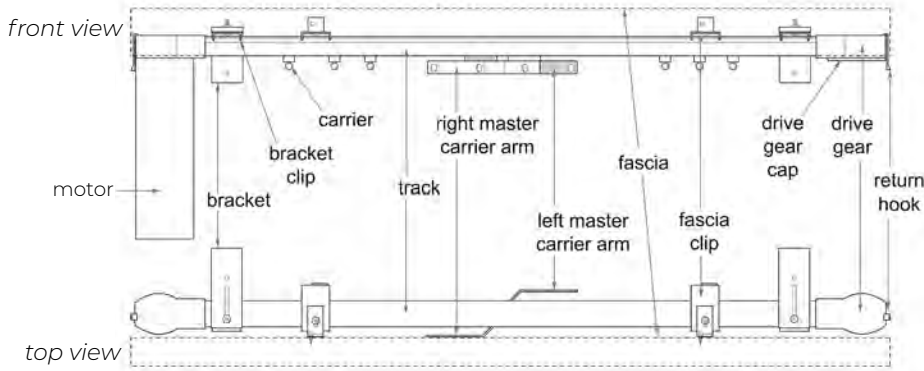

Motor Weight Capacity

Be sure to select the best motor for your window treatment. Use the Motor Weight Capacity chart below to determine which motor best accommodates your length of track and your drapery weight. The System Features chart on page 54 lists the varied functions of each motor.

Motor	maximum drapery weight per total length of system (lbs)												
	18' or less	20'	22'	24'	26'	28'	30'	32'	34'	36'	38'	40'	
Std Glydea® ULTRA 35	77	77	77	77	77	77	77	77	77	-	-	-	-
HD Glydea® ULTRA 60e	132	132	132	132	132	132	132	132	132	132	132	-	-
Std Irismo 45	99	99	99	99	99	99	99	99	99	-	-	-	-
Mini Irismo 35	77	77	77	77	77	77	77	77	77	-	-	-	-

Note: Capacity ratings are based on internal system friction only. External loads caused by fabric friction, drag or obstructions will adversely affect pulling capacity or stop motor due to resistance. Curving: System curves reduce maximum drapery weight capacity by a minimum of 15% per bend. Please call us regarding weight capacity for your curved track. Maximum System Lengths: If you need more than the maximum spliced length for a system, two one-way systems can butt against each other behind fascia. Must be specified on your order form. An additional arm component is needed to create an overlap between the two individual systems; sold separately.

Somfy Motorized Heavy Duty Traverse Systems Finishes

Decorative wood fascia available in 2 1/4" smooth, reeded or grooved / fluted profiles with coordinating finials, 1 7/8" slim round smooth profile, 2 1/4" flat smooth profile with flush ends or mitered returns. See page 49 for Fascia Profiles. Select from 35 Portfolio Hand Painted Finishes, PTH Perfect Match™ or 5 Quick Ship Wood and Resin Finishes.

Diameter	Wood Fascia Finish	Track and Bracket* Color	Component Color	Max. Continuous Length
2 1/4" smooth, reeded or grooved / fluted profiles with coordinating finials	Amulet	White	White	16'
	Andiron	White	White	16'
	Antique Gold	White	White	16'
	Antique Gold Leaf	White	White	16'
	Art Bronze	White	Bronze	16'
	Barnwood	Bronze	Bronze	16'
	Black	White	Bronze	16'
	Blush	White	White	16'
	Bronzed Pewter	Bronze	Bronze	16'
	Concrete	White	White	16'
	Couture	White	White	16'
	Dark Chocolate	Bronze	Bronze	16'
	Firelight	White	White	16'
	Gossamer	Bronze	Bronze	16'
	Greige	White	White	16'
	Halo	White	White	16'
	Java	White	Bronze	16'
	Linen	White	White	16'
	Luminous	White	Bronze	16'
	1 7/8" slim round smooth profile	Manor	White	White
Mink		Bronze	Bronze	16'
2 1/4" flat smooth profile With flush ends or mitered returns	Moonlight	Bronze	Bronze	16'
	Mystic	White	White	16'
	New Age Bronze	Bronze	Bronze	16'
	Patina	White	White	16'
	Shimmer	Bronze	Bronze	16'
	Silver Maple	White	White	16'
	Spicewood	Bronze	Bronze	16'
	Spun Gold	White	White	16'
	Stardust	White	White	16'
	Starlet	White	White	16'
	Titanium	White	White	16'
	Truffle	Bronze	Bronze	16'
	Urban Bronze	White	Bronze	16'
	White	White	White	16'
	PTH Perfect Match™	please specify	please specify	16'
	Antique Brass	White	White	12'
	Oil Rubbed Bronze	White	Bronze	12'
Platinum	White	White	12'	
Rose Gold	White	White	12'	
Walnut	Bronze	Bronze	12'	

White brackets may be substituted upon request.

Somfy Motorized Heavy Duty Traverse Systems Pricing

Item #	Name	Pricing Includes Somfy® Motorized Traverse Track with Motor, Remote and Battery Charger when ordering the Irismo™ 45 Std Motor					
Motorized Traverse System with Wood Fascia		6'	7'	8'	9'	10'	11'
Single Track System with Wood Fascia for 1 7/8" slim, 2 1/4" flat smooth and 2 1/4" round							
STRACKF2S6045	Glydea® ULTRA 60e RTS Heavy Duty Motor or Irismo™ 45 Std Motor	\$3,836.14	\$3,987.72	\$4,139.30	\$4,290.88	\$4,442.46	\$4,594.04
STRACKF2S35	Glydea® ULTRA 35e RTS Std Motor or Irismo™ 35 Mini Motor	\$3,317.27	\$3,468.85	\$3,620.43	\$3,772.01	\$3,923.59	\$4,075.17
Double Track System with Wood Fascia Front Only for 1 7/8" slim, 2 1/4" flat smooth and 2 1/4" round							
STRACKF2DF6045	Glydea® ULTRA 60e RTS Heavy Duty Motor or Irismo™ 45 Std Motor	\$7,304.99	\$7,555.68	\$7,806.37	\$8,057.06	\$8,307.75	\$8,558.44
STRACKF2DF35	Glydea® ULTRA 35e RTS Std Motor or Irismo™ 35 Mini Motor	\$6,267.25	\$6,517.94	\$6,768.63	\$7,019.32	\$7,270.01	\$7,520.70
STRACKF2DFMix	Mixed Motors	\$6,786.12	\$7,036.81	\$7,287.50	\$7,538.19	\$7,788.88	\$8,039.57
Double Track System with Wood Fascia Front and Back for 2 1/4" round only							
STRACKF2DFB6045	Glydea® ULTRA 60e RTS Heavy Duty Motor or Irismo™ 45 Std Motor	\$7,672.28	\$7,975.44	\$8,278.60	\$8,581.76	\$8,884.92	\$9,188.08
STRACKF2DFB35	Glydea® ULTRA 35e RTS Std Motor or Irismo™ 35 Mini Motor	\$6,634.54	\$6,937.70	\$7,240.86	\$7,544.02	\$7,847.18	\$8,150.34
STRACKF2DFBMix	Mixed Motors	\$7,153.41	\$7,456.57	\$7,759.73	\$8,062.89	\$8,366.05	\$8,669.21
Double Track System with Stationary Front Wood Pole & No Back Fascia							
STRACKF2DSF6045	Glydea® ULTRA 60e RTS Heavy Duty Motor or Irismo™ 45 Std Motor	\$4,159.12	\$4,407.48	\$4,655.84	\$4,904.20	\$5,152.55	\$5,400.91
STRACKF2DSF35	Glydea® ULTRA 35e RTS Std Motor or Irismo™ 35 Mini Motor	\$3,640.25	\$3,888.61	\$4,136.97	\$4,385.33	\$4,633.68	\$4,882.04
Double Track System with Stationary Front Wood Pole & Back Wood Fascia for 2 1/4" round only							
STRACKF2DSFB6045	Glydea® ULTRA 60e RTS Heavy Duty Motor or Irismo™ 45 Std Motor	\$4,526.41	\$4,827.24	\$5,128.07	\$5,428.90	\$5,729.72	\$6,030.55
STRACKF2DSFB35	Glydea® ULTRA 35e RTS Std Motor or Irismo™ 35 Mini Motor	\$4,007.54	\$4,308.37	\$4,609.20	\$4,910.03	\$5,210.85	\$5,511.68

Motorized Traverse System without Wood Fascia

Single Track System track available in white or bronze		6'	7'	8'	9'	10'	11'
STRACK6045	Glydea® ULTRA 60e RTS Heavy Duty Motor or Irismo™ 45 Std Motor	\$3,468.85	\$3,567.30	\$3,665.75	\$3,764.20	\$3,862.65	\$3,961.10
STRACK35	Glydea® ULTRA 35e RTS Std Motor or Irismo™ 35 Mini Motor	\$2,949.98	\$3,048.43	\$3,146.88	\$3,245.33	\$3,343.78	\$3,442.23
Double Track System track available in white or bronze							
STRACKDBL6045	Glydea® ULTRA 60e RTS Heavy Duty Motor or Irismo™ 45 Std Motor	\$6,937.70	\$7,135.92	\$7,334.14	\$7,532.36	\$7,730.58	\$7,928.80
STRACKDBL35	Glydea® ULTRA 35e RTS Std Motor or Irismo™ 35 Mini Motor	\$5,899.96	\$6,098.18	\$6,296.40	\$6,494.62	\$6,692.84	\$6,891.06
STRACKDBLMix	Mixed Motors	\$6,418.83	\$6,617.05	\$6,815.27	\$7,013.49	\$7,211.71	\$7,409.93

Quantity Per System

	6'	7'	8'	9'	10'	11'	12'	13'	14'	15'	16'
Pinch Pleat Glides	24	28	32	36	40	44	48	52	56	60	64
Brackets	3	3	4	4	4	5	5	5	6	6	6

Somfy glides are 4 per foot | Somfy brackets are 1 every 3-4 feet

Motorized Stack Back Calculation (each drapery panel)

master carrier + (# glides on panel x carrier width) + 3.75" = stack per drapery panel

Ex: Somfy 10ft. center draw, pinch pleat (standard 4 glides per ft.)

4.67" + [(40/2) x .563"] + 3.75" = 19.7" stack, panel with over arm BEFORE drapery fabric is installed

4.07" + [(40/2) x .563"] + 3.75" = 19.1" stack, panel with under arm BEFORE drapery fabric is installed

Please note: Calculations result in Stack Back Width BEFORE drapery fabric is installed. Stack back width will increase once draperies are installed. Factors such as thickness of drapery fabric, type of drapery pleat, and fullness of treatment affect the final stack back width. Please consult your workroom to determine your final stack back based on your draperies.

PTH Motorized Traverse Tips

- Specified custom cut length indicates track length including drive gears; fascia will be 1/4" longer at each end of track (1/2" total); mitered fascia will add the following to the traverse system:

Fascia	Depth	+ to traverse system
1 3/8"	7/8"	2"
2 1/4"	1 3/8"	3"
Flat	3/4"	1 3/4"
Slim Round	5/8"	1 1/2"

- Track and fascia will be spliced in the center of overall length.
- Blended fascia is available for an additional fee per blend; PTH will properly connect splice(s) and ship your fascia in one continuous length.
- Back fascia can accommodate decorative end caps; decorative end caps sold separately.

Orders with Somfy motorized traverse systems will incur a \$25 packaging fee. Orders that contain a Li-ion battery will be charged a \$25.00 shipping surcharge. Available in all profiles for 1 7/8" and 2 1/4" diameter fascias or without a wood fascia. 1 3/8" not available with Somfy Systems.

	12'	13'	14'	15'	16'	per add'l ft
Systems are sold in 1 ft increments						
	\$4,745.62	\$4,897.20	\$5,048.78	\$5,200.36	\$5,351.94	\$151.58
	\$4,226.75	\$4,378.33	\$4,529.91	\$4,681.49	\$4,833.07	\$151.58
	\$8,809.13	\$9,059.82	\$9,310.51	\$9,561.20	\$9,811.89	\$250.69
	\$7,771.39	\$8,022.08	\$8,272.77	\$8,523.46	\$8,774.15	\$250.69
	\$8,290.26	\$8,540.95	\$8,791.64	\$9,042.33	\$9,293.02	\$250.69
	\$9,491.24	\$9,794.40	\$10,097.56	\$10,400.72	\$10,703.88	\$303.16
	\$8,453.50	\$8,756.66	\$9,059.82	\$9,362.98	\$9,666.14	\$303.16
	\$8,972.37	\$9,275.53	\$9,578.69	\$9,881.85	\$10,185.01	\$303.16
	\$5,649.27	\$5,897.63	\$6,145.99	\$6,394.34	\$6,642.70	\$248.36
	\$5,130.40	\$5,378.76	\$5,627.12	\$5,875.47	\$6,123.83	\$248.36
	\$6,331.38	\$6,632.21	\$6,933.04	\$7,233.86	\$7,534.69	\$300.83
	\$5,812.51	\$6,113.34	\$6,414.17	\$6,714.99	\$7,015.82	\$300.83
Systems are sold in 1 ft increments						
	12'	13'	14'	15'	16'	per add'l ft
	\$4,059.55	\$4,158.00	\$4,256.45	\$4,354.90	\$4,453.35	\$98.45
	\$3,540.68	\$3,639.13	\$3,737.58	\$3,836.03	\$3,934.48	\$98.45
	\$8,127.02	\$8,325.24	\$8,523.46	\$8,721.68	\$8,919.90	\$198.22
	\$7,089.28	\$7,287.50	\$7,485.72	\$7,683.94	\$7,882.16	\$198.22
	\$7,608.15	\$7,806.37	\$8,004.59	\$8,202.81	\$8,401.03	\$198.22

Item #	Name	Color	Price
--------	------	-------	-------

Somfy Motors

1003159	Somfy Glydea® ULTRA 60e Heavy Duty Motor		\$1,609.08
1003152	Somfy Glydea® ULTRA 35e Std Motor		\$1,320.79
1002353	Somfy Irismo™ 45 Std Motor**		\$1,609.08
1003004	Somfy Irismo™ 35 Mini Motor*		\$1,320.79

* Transformers are included **Li-ion battery included; charger sold separately.

Motor Accessories

1003080	Battery Charger for Irismo™ 45 Std Motor	White	\$109.80
9026476	Rechargeable Li-ion Battery	White	\$234.66

Transmitters/Devices

1870575	Situo® Transmitter-5 channel (included)	White	\$301.70
1810652	Telis Transmitter-5 channel	Black	\$378.95
1870571	Situo® Transmitter-1 channel	White	\$204.05
1810639	Telis Transmitter-1 channel	Silver	\$303.16
1810650	Telis Transmitter-1 channel	Black	\$303.16
1811081	Telis16 RTS-16 channel	White	\$918.52
1811082	Telis16 RTS-16 channel	Silver	\$918.52
1810897	Wireless Wall Switch-1 channel	White	\$516.25
1810898	Wireless Wall Switch-1 channel	Ivory	\$516.25
1810899	Wireless Wall Switch-1 channel	Black	\$590.00
1810813	Wireless Wall Switch-5 channel	White	\$536.36
1810814	Wireless Wall Switch-5 channel	Ivory	\$536.36
1810830	Wireless Wall Switch-5 channel	Black	\$623.52
1811185	Table Top Accessory *	White	\$160.91
1810972	Table Top Accessory *	Silver	\$160.91
1811051	Table Top Accessory *	Black	\$160.91

* use with Wireless Wall Switch

Programmable Timers



1811731	Somfy TaHoma® gateway	\$266.84 NET
---------	-----------------------	--------------

Additional Somfy Traverse Fees



PTHFEEMITER-EACH Wood Fascia Mitered Return per return	\$80.00
PTHFEEMITER-45 Wood Fascia Mitered Cut 45° angle (90° corner) per connection	\$65.00
PTHFEEMITER-NON45 Wood Fascia Mitered Cut non-45° angle (non-90° corner) per connection	\$65.00
PTHFEEBLEND Blended Fascia Splice per blend	\$108.00
PTHFEEFASCUT Fascia Fabrication Fee (if ordering fascia alone, order full pole and specify fascia fabrication) per Fascia	\$65.00
PTHFEERESTRING Restraining Fee per track	\$100.00
Standard 45 Fascia Splice	No Charge
Curving Fees (per bend, template required)	Quoted
Crating for Curved Track	\$75.00
Packaging fee per order	\$25.00







Pair with these systems (sold separately):

- 
- 
- 

Somfy TaHoma® gateway NEW
1811731
Free app for iOS and Android:

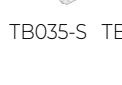
Somfy Motorized Heavy Duty Traverse Systems Information

 <p>TB035-S</p>	<p>Somfy Single TB035-S BR</p> <p>2 11/16" H x 1 1/2" W backplate, adjustable 2 3/4" - 3 5/8" return. Available in white or bronze /BR and included in Single Systems.</p>	<p>\$33.52 each</p>
 <p>TB060-S</p>	<p>Somfy Single or Double TB060-S BR</p> <p>3 5/8" H x 1 1/2" W backplate, adjustable 5" - 5 3/8" front return and adjustable 1 3/4" - 2 1/2" back return. Available in white or bronze /BR and included in Double Systems. May be substituted for Single Systems when longer return is needed.</p>	<p>\$53.64 each</p>
 <p>TB100-S</p>	<p>Somfy Single, Double or Triple TB100-S BR</p> <p>4 1/2" H x 1 1/2" W backplate, adjustable up to 9 3/16" return. Available in white or bronze /BR.</p>	<p>\$53.64 each</p>
 <p>CMBC-S</p>	<p>Ceiling Mount Clip Single CMBC-S BR</p> <p>1/4" H x 1" W x 2" D May only be used in systems without fascia for Single or Double Systems. For double ceiling mount installation, install two brackets into ceiling. Available in white or bronze /BR.</p>	<p>\$26.82 each</p>
 <p>SOMFY CLIP</p>	<p>Somfy Fascia Clip SOMFY CLIP</p> <p>Use to attach fascia to traverse systems; included. Available in zinc.</p>	<p>\$26.82 each</p>

Somfy Single Motorized Bracket TB035-S

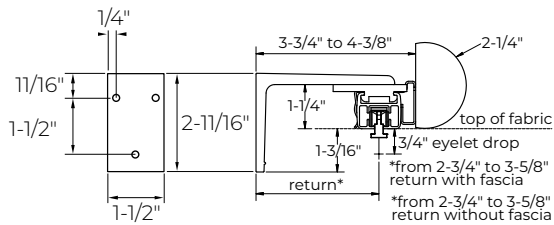

Somfy Single or Double Motorized Bracket TB060-S

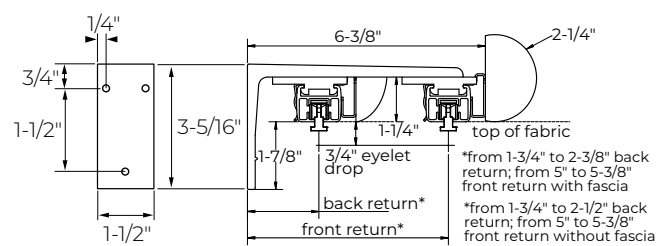

Somfy Single, Double or Triple Motorized Bracket TB100-S

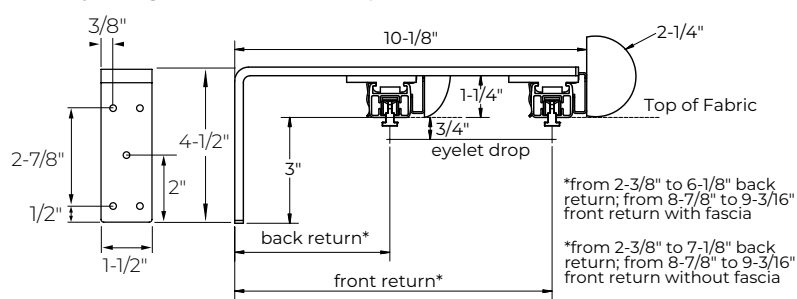

Somfy Ceiling Mount Bracket CMBC-S

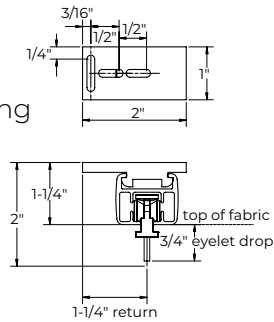

Custom Over-Bracket Single TBKT214-S

3 1/2" H x 3/4" W backplate, 7 7/8" front return and 3" back return. Use to combine 2 1/4" full wood pole with Single Traverse Systems. Traverse mounting bracket simply attaches directly into the bottom of the Over-Bracket. Available in 35 Portfolio and PTH Perfect Match™ finishes. Steel

*Available in any of our 35 Portfolio hand painted finishes, 5 Quick Ship Wood & Resin finishes or PTH Perfect Match™

\$93.86 each

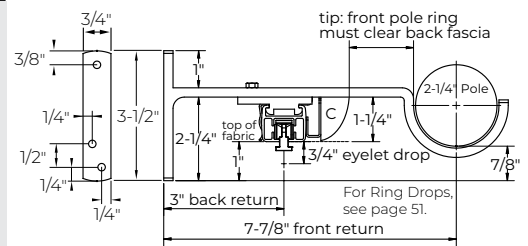

Optional back fascia will be clipped to track. Diagram depicts ensemble when back fascia is desired.



Custom Ceiling Single CMTB-S

2 3/4" H x 3/4" W backplate

May only be used in systems with fascia for Single or Double Systems. Available in 35 Portfolio, 5 Quick Ship Wood & Resin or PTH Perfect Match™ finishes. Steel

for double ceiling mount installation, install two brackets into ceiling.

*Available in any of our 35 Portfolio hand painted finishes, 5 Quick Ship Wood & Resin finishes or PTH Perfect Match™

When ordering, specify:

A. Fascia profile (only 2 1/4" DIA available).

B. Projection to carrier and/or to front of fascia.







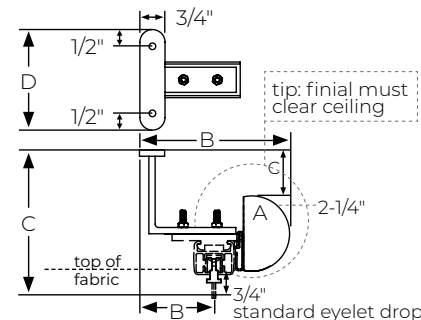

C. Drop from ceiling to carrier eyelet and/or from ceiling to top of fascia (tip: finial must clear ceiling).

D. Width of mounting plate if longer than 2 3/4".

\$80.45 each



Carriers for additional carriers.

	Somfy Standard Pinch Pleat Glide 1781415 white 1782869 bronze	Wheeled for smooth movement. Included in system; additional glides may be ordered separately. Available in white or bronze.	\$1.96 NET each
	Somfy Ripplefold Glide 1780901 white 1782870 bronze 120% 1780902 white 1782871 bronze 100% 1780903 white 1782872 bronze 80%	Snap accepts Ripplefold tape and swivels to create fold. Fullness 80%, 100% or 120% - specify fullness on order. Available in white or bronze.	\$2.76 NET each
	Master Carrier Body 1781344	Select from different arms to assemble into one MC Body; order two if ordering Center Draw MC Arms - sold separately. Pinch pleat or Ripplefold. Available in gray with white only.	\$15.90 NET each
	Overlap Master Carrier Arms for Center Draw 1782320 (Over Arm) 1782321 (Under Arm)	Pinch pleat or Ripplefold; order two MC Bodies - sold separately. Available in Stainless Steel only.	\$13.52 NET each
	Tandem Master Carrier Arms for Center Draw 1782662 (Under Arm) 1780947 (Over Arm)	Pinch pleat or Ripplefold; order two MC Bodies - sold separately. Available in Stainless Steel only.	\$13.52 NET each
	Master Carrier Arm for One-Way Draw 1782320	Right and Left use. Pinch pleat or Ripplefold; order one MC Body - sold separately. Available in Stainless Steel only.	\$13.52 NET each
	Ripplefold Butt Master Carrier Arms for Center Draw 1780953	Each, order 2. Ripplefold only; order two MC Bodies - sold separately. Do not overlap, allowing some light to filter between draperies on center draw treatments. Available in Stainless Steel only.	\$13.52 NET each
	Ripplefold Butt Master Carrier Arms for Center Draw Tandem Option 1782319	Each, order 2. Ripplefold only; order two MC Bodies - sold separately. Do not overlap, allowing some light to filter between draperies on center draw treatments. Available in Stainless Steel only.	\$13.52 NET each
	Ripplefold Butt Master Carrier Arm for One-Way Draw 1782319	Right and left use. Ripplefold only; order one MC Body - sold separately. Available in Stainless Steel only.	\$13.52 NET each

Somfy Pinch Pleat Glide
1781415 white 1782869 bronze
4 per foot, unless otherwise specified

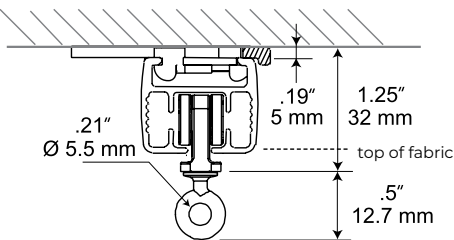

Somfy Ripplefold Glide
1780901 white, 80% 1782870 bronze, 80% 1780902 white, 100% 1782871 bronze, 100%
1780903 white, 120% 1782872 bronze, 120%

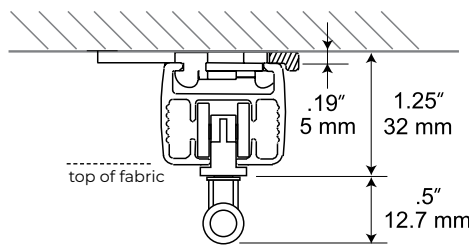

IMPORTANT: Drapery workroom must apply specific snap tape to drapery panel when using Ripplefold glides. Somfy Glydea® Ripplefold glides are only compatible with Kirsch Ripplefold snap tape. Other brand tapes are NOT COMPATIBLE with the Somfy Glydea® Motorized system.

Somfy Ripplefold Butt Master Carrier Arm - One-Way Draw
1782319

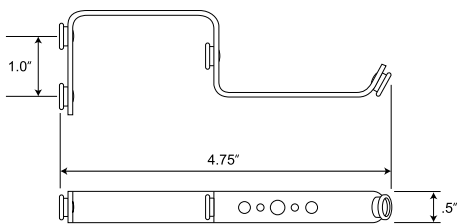

Somfy Pinch Pleat or Ripplefold Master Carrier Arms - Center Draw

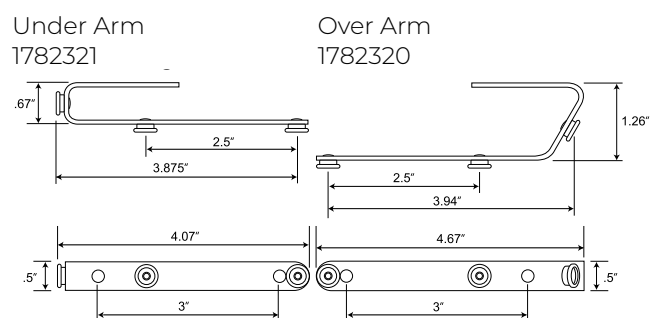

Somfy Ripplefold Butt Master Carrier Arm - Center Draw
1780953

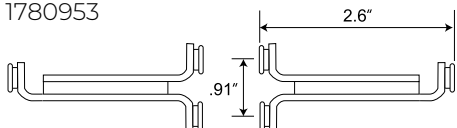

PO # _____ Side Mark _____ Ship via _____ Date _____

Company Information		Shipping Information	
Company Name	Acct #	Company Name	Acct #
Contact Person		Contact Person	
Street Address		Street Address	
City	State	City	State
Email	ZIP	Email	ZIP
Phone	Fax	Phone	Fax

MOTORIZED TRAVERSE SYSTEMS - Consult Price List for detailed specifications.
Specified custom cut length indicates track length including drive gears; Mitered fascia will be up to 3" longer than track length, depending on the profile ordered.

Item #	Motor	Power Option **see additional R-TEC options below	Fascia Type	System Length Up to 36' (per 1')	Custom Cut Track Length (inches)	Fascia Finish Code	Bracket Preference	Draw Preference Center	One-Way	Motor Location	Glide Style pinch pleat or Ripplefold **	Qty	Price per Unit	Subtotal
		<input type="checkbox"/> Li-Ion Battery <input type="checkbox"/> 110v AC/DC Power						<input type="checkbox"/>	<input type="checkbox"/> L <input type="checkbox"/> R	<input type="checkbox"/> L <input type="checkbox"/> R	<input type="checkbox"/> PP <input type="checkbox"/> RF			
		<input type="checkbox"/> Li-Ion Battery <input type="checkbox"/> 110v AC/DC Power						<input type="checkbox"/>	<input type="checkbox"/> L <input type="checkbox"/> R	<input type="checkbox"/> L <input type="checkbox"/> R	<input type="checkbox"/> PP <input type="checkbox"/> RF			
		<input type="checkbox"/> Li-Ion Battery <input type="checkbox"/> 110v AC/DC Power						<input type="checkbox"/>	<input type="checkbox"/> L <input type="checkbox"/> R	<input type="checkbox"/> L <input type="checkbox"/> R	<input type="checkbox"/> PP <input type="checkbox"/> RF			
		<input type="checkbox"/> Li-Ion Battery <input type="checkbox"/> 110v AC/DC Power						<input type="checkbox"/>	<input type="checkbox"/> L <input type="checkbox"/> R	<input type="checkbox"/> L <input type="checkbox"/> R	<input type="checkbox"/> PP <input type="checkbox"/> RF			

MOTORIZED TRAVERSE COORDINATING ACCESSORIES AND ADDITIONAL FEES
***Power Options for R-TEC Motor (NET)*
ADDITIONAL : solar panel \$127.20; 20' cord \$79.50 - specify total feet; plug \$26.50

Item #	Finish Code	Description	Qty	Price per Unit	Subtotal

Additional Information
 NOTE: Minimum track length for R-TEC is 4' and for Somfy is 6'

Quantity included per system based on cut track length	4'	5'	6'	7'	8'	9'	10'	11'	12'	13'	14'	15'	16'	17'	18'	19'	20'
Pinch Pleat Glides [4 per foot, includes master carriers (2) & end caps (2)]	21	27	24	28	32	36	40	44	48	52	56	60	64	68	72	76	80
Brackets (1 per every 3-4 feet)	3	4	4	4	4	4	4	4	4	5	5	6	6	6	7	7	8

Special Instructions

*** When ordering Ripplefold carriers, answer these questions:**

1. Select Ripplefold fullness: 60% 80% 100% 120%

2. Select Ripplefold masters: Overlap Butt Master

TOTAL

1 1/8" Baton Draw Metal Traverse Systems

The perfect modern solution for residential or commercial applications.

Our NEW French Returns for Traverse may be ordered separately. Finials may be ordered separately from 1 1/8" Diameter Collections and require the use of the Transitional or Deco Cuff / Finial Adapter (sold separately). See page 67.

Select from 35 Portfolio hand painted finishes (**except Antique Gold Leaf**), 6 Quick Ship Metal finishes or PTH Perfect Match™.

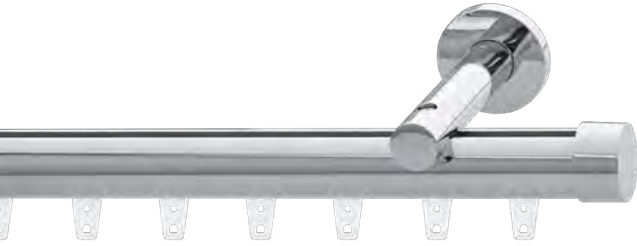

Single Traverse System, Wall Mount

- Wall Bracket: 3 1/2" or 6" return options
- Traverse system includes track, pendants, brackets, glides, master carriers and Emery end caps
- 1 1/8" collection finials and transitional or deco cuffs sold separately



Double Traverse System, Wall Mount

- Wall bracket: 3" and 7 1/2" returns
- Traverse system includes tracks, pendants, brackets, glides, master carriers and Emery end caps
- 1 1/8" collection finials and transitional or deco cuffs sold separately



Single Traverse System, Ceiling Mount

- Ceiling bracket: 3 5/16" drop
- Traverse system includes track, pendants, brackets, glides, master carriers and Emery end caps
- 1 1/8" collection finials and transitional or deco cuffs sold separately

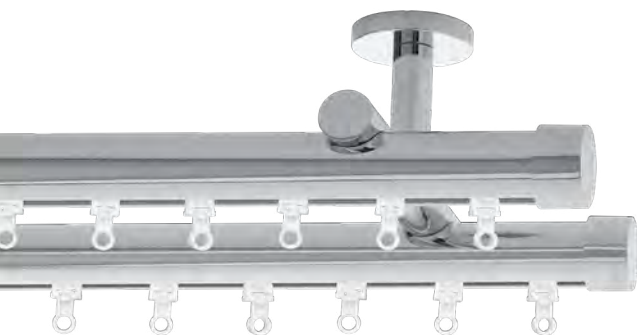

Double Traverse System, Ceiling Mount

- Ceiling bracket: 3 11/16" drop, 4 1/2" between centers of tracks
- Traverse system includes tracks, pendants, brackets, glides, master carriers and Emery end caps
- 1 1/8" collection finials and transitional or deco cuffs sold separately



Single Traverse System, Low-Profile Ceiling Mount

- Ceiling bracket: 1 3/16" drop
- Traverse system includes track, pendants, brackets, glides, master carriers and Emery end caps
- 1 1/8" collection finials and transitional or deco cuffs sold separately

1 1/8" Baton Draw Metal Traverse Systems Pricing

Orders with Baton Draw Metal traverse systems will incur a \$25 packaging fee.

Name & Item #	Price										Systems are sold in 1 ft increments
---------------	-------	--	--	--	--	--	--	--	--	--	-------------------------------------

1 1/8" Baton Draw Metal Traverse System

Single Traverse System Wall Mount 3 1/2" Return	4'	5'	6'	7'	8'	9'	10'	11'	12'	price per ft
CSPTHMT118400	\$279.84	\$349.80	\$419.76	\$489.72	\$559.68	\$629.64	\$699.60	\$769.56	\$839.52	\$69.96
Single Traverse System Wall Mount 6" Return										
CSPTHMT118401	\$317.15	\$396.44	\$475.73	\$555.02	\$634.30	\$713.59	\$792.88	\$872.17	\$951.46	\$79.29
Double Traverse System Wall Mount										
CSPTHMT118402	\$559.68	\$699.60	\$839.52	\$979.44	\$1,119.36	\$1,259.28	\$1,399.20	\$1,539.12	\$1,679.04	\$139.92
Single Traverse System Ceiling Mount										
CSPTHMT118403	\$279.84	\$349.80	\$419.76	\$489.72	\$559.68	\$629.64	\$699.60	\$769.56	\$839.52	\$69.96
Double Traverse System Ceiling Mount										
CSPTHMT118404	\$559.68	\$699.60	\$839.52	\$979.44	\$1,119.36	\$1,259.28	\$1,399.20	\$1,539.12	\$1,679.04	\$139.92
Single Traverse System Low-Profile Ceiling Mount										
CSPTHMT118406	\$223.87	\$279.84	\$335.81	\$391.78	\$447.74	\$503.71	\$559.68	\$615.65	\$671.62	\$55.97

1 1/8" Baton Draw Metal Traverse Systems Information



Quantity Per System

Quantity included per system based on cut track length	4'	5'	6'	7'	8'	9'	10'	11'	12'	13'	14'	15'	16'	17'	18'	19'	20'
Glides [4 per foot, includes master carriers & end caps (2)]	16	20	24	28	32	36	40	44	48	52	56	60	64	68	72	76	80
Brackets	2	3	4	4	4	5	5	5	5	6	6	6	6	7	7	7	8

Batons sold separately.

Note: Metal Baton available in 6 Metal Quick Ship Finishes, 35 Portfolio finishes or PTH Perfect Match™.

					
36" Metal Baton 3/8" DIA, Metal	48" Metal Baton 3/8" DIA, Metal	60" Metal Baton 3/8" DIA, Metal	36" Clear Acrylic Baton 1/2" DIA, Acrylic	48" Clear Acrylic Baton 1/2" DIA, Acrylic	60" Clear Acrylic Baton 1/2" DIA, Acrylic
POME36WAND	POME48WAND	POME60WAND	AC36WAND	AC48WAND	AC60WAND
\$66.46 each	\$72.29 each	\$78.12 each	\$52.47 each	\$58.30 each	\$64.13 each
QSME36WAND	QSME48WAND	QSME60WAND			
\$58.30 each	\$64.13 each	\$69.96 each			

	
48" Handicap Metal Baton 4" Loop, ADA Compliant, Metal	60" Handicap Metal Baton 4" Loop, ADA Compliant, Metal
POME48HWAND	POME60HWAND
\$72.29 each	\$78.12 each
QSME48HWAND	QSME60HWAND
\$64.13 each	\$69.96 each

		
48" Handicap Clear Acrylic Baton 4" Loop, ADA Compliant, Acrylic	60" Handicap Clear Acrylic Baton 4" Loop, ADA Compliant, Acrylic	72" Handicap Clear Acrylic Baton 4" Loop, ADA Compliant, Acrylic
AC48HWAND	AC60HWAND	AC72HWAND
\$58.30 each	\$64.13 each	\$69.96 each

1 1/8" Baton Draw Metal Traverse Systems Finishes



35 Portfolio finishes (except Antique Gold Leaf), PTH Perfect Match™ and 6 Quick Ship Metal finishes

Diameter	Track Finish	Component Color	Max. Continuous Length
1 1/8"	Amulet	White	12'
1 1/8"	Andiron	White	12'
1 1/8"	Antique Gold	White	12'
1 1/8"	Art Bronze	Bronze	12'
1 1/8"	Barnwood	Bronze	12'
1 1/8"	Black	Bronze	12'
1 1/8"	Blush	White	12'
1 1/8"	Bronzed Pewter	Bronze	12'
1 1/8"	Concrete	White	12'
1 1/8"	Couture	White	12'
1 1/8"	Dark Chocolate	Bronze	12'
1 1/8"	Firelight	White	12'
1 1/8"	Gossamer	Bronze	12'
1 1/8"	Greige	White	12'
1 1/8"	Halo	White	12'
1 1/8"	Java	Bronze	12'
1 1/8"	Linen	White	12'
1 1/8"	Luminous	Bronze	12'
1 1/8"	Manor	White	12'
1 1/8"	Mink	Bronze	12'
1 1/8"	Moonlight	Bronze	12'
1 1/8"	Mystic	White	12'
1 1/8"	New Age Bronze	Bronze	12'
1 1/8"	Patina	White	12'
1 1/8"	Shimmer	Bronze	12'
1 1/8"	Silver Maple	White	12'
1 1/8"	Spicewood	Bronze	12'
1 1/8"	Spun Gold	White	12'
1 1/8"	Stardust	White	12'
1 1/8"	Starlet	White	12'
1 1/8"	Titanium	White	12'
1 1/8"	Truffle	Bronze	12'
1 1/8"	Urban Bronze	Bronze	12'
1 1/8"	White	White	12'
1 1/8"	PTH Perfect Match™	please specify	12'
1 1/8"	Brushed Nickel	White	12'
1 1/8"	Brushed Bronze	Bronze	8'
1 1/8"	Charcoal Zinc	White	8'
1 1/8"	Matte Black	White	12'
1 1/8"	Rose Gold	White	8'
1 1/8"	Satin Gold	White	8'

1 1/8" Baton Draw Metal Traverse Systems Information

1 1/8" Brackets & Connectors for additional brackets. See below for diagrams/dimensions.

					
PTHMT118400	PTHMT118401	PTHMT118402	PTHMT118403	PTHMT118404	PTHMT118405
Wall Mount 3 1/2" return	Wall Mount 6" return	Wall Mount Double	Ceiling Mount Single	Ceiling Mount Double	Ceiling Bracket Extender
\$25.65 each	\$34.98 each	\$46.64 each	\$25.65 each	\$69.96 each	\$13.99 each

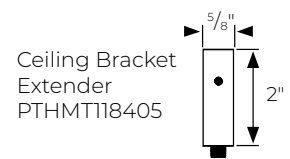
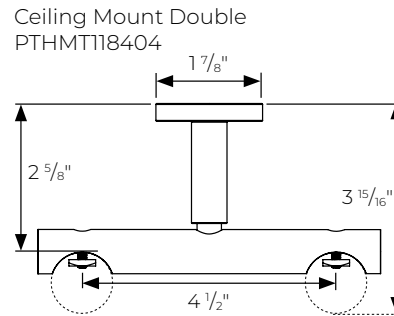
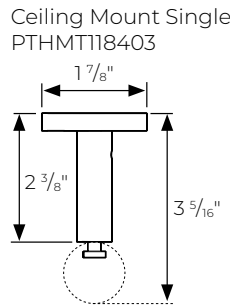
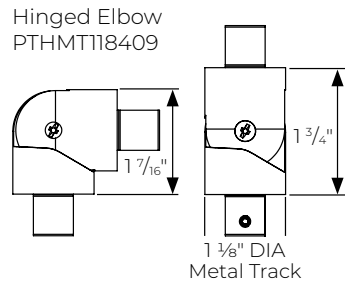
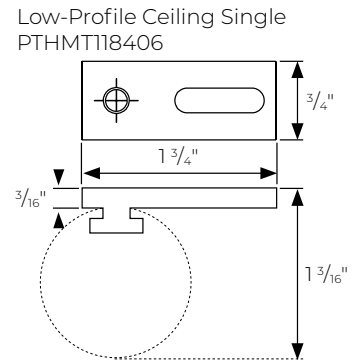
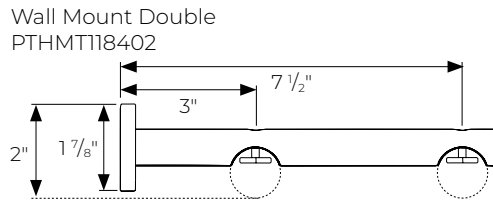
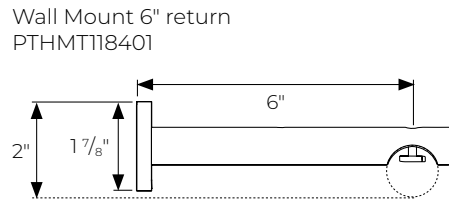
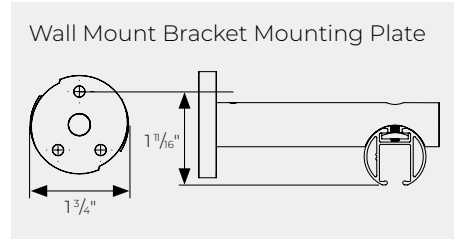
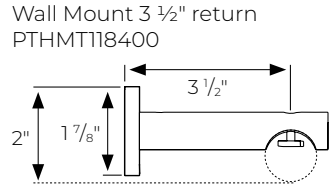

		
PTHMT118406	PTHMT118407	PTHMT118409
Low-Profile Ceiling Single	Connector / Splice	Hinged Elbow
\$16.32 each	\$8.16 each	\$27.98 each





Carriers for additional carriers.
for master carrier diagrams, see page 84.

Pinch Pleat

Ripplefold

	
Pinch Pleat Glide CP10 or CP10/BR /BR	Ripplefold Glide /BR R4060/P R4060/P/BR R4080/P R4080/P/BR R4100/P R4100/P/BR R4120/P R4120/P/BR
Ball Bearing Wheel for smooth movement. Available in white or bronze /BR.	Ripplefold Glides with detachable pendants. Available in 60%, 80%, 100% or 120% fullness - specify fullness on order. Available in white or bronze /BR.
\$3.13 NET pack (10 pieces)	\$0.67 NET each

	
Pinch Pleat Master Carrier BT3005R or BT3005L /BR	Ripplefold Overlap Master Carrier BT3125R or BT3125L /BR
Stainless steel overlap arms with multi-wheel design for smooth movement. Available in white or bronze /BR and left or right.	Stainless steel overlap arms with snaps to accept Ripplefold tape and a multi-wheel design for smooth movement. Available in white or bronze /BR and left or right.
\$5.04 NET each	\$5.99 NET each

	
Glide Stop BT4333	Ripplefold Butt Master Carrier BT3600R or BT3600L /BR
Stainless steel overlap arms with snaps to accept Ripplefold tape and a multi-wheel design for smooth movement. Available in white or bronze /BR and left or right.	Arms with snaps to accept Ripplefold tape and a multi-wheel design for smooth movement. Butt Master Carriers do not overlap, allowing light to filter between draperies on center draw treatments. Must be specified for substitution. Available in white or bronze /BR and left or right.
\$0.58 NET each	\$6.20 NET each

Upgrade your End Caps with French Returns or Finials

1 1/8" Baton Draw Metal Traverse Systems include End Caps, but are designed to work with our NEW 1 1/8" French Returns for Traverse and all 1 1/8" Finials across five style categories using either Cuff / Finial Adapter.

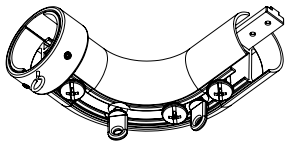

PTHMT118440

French Return for Metal Traverse
 (Includes 1 Return, 1 Splice, 1 French Return Ring to reduce sidelight, 4 End Stops, 4 Ripplefold Carriers, 2 Pinch Pleat Carriers, 1 Allen Wrench and 2 Extra Set Screws)

Metal, 3 1/2" return, Ripplefold or Pinch Pleat
 Available in any of our 35 Portfolio Hand Painted Finishes or PTH Perfect Match™

\$80.30 each



	
PO118CUFF QS118CUFF	PO118DECUFF QS118DECUFF
Transitional Cuff / Finial Adapter	Deco Cuff / Finial Adapter
3/4" L x 1 1/4" W Metal	3/4" L x 1 3/8" W Metal
PO \$39.64 QS \$34.98 pair*	PO \$39.64 QS \$34.98 pair*

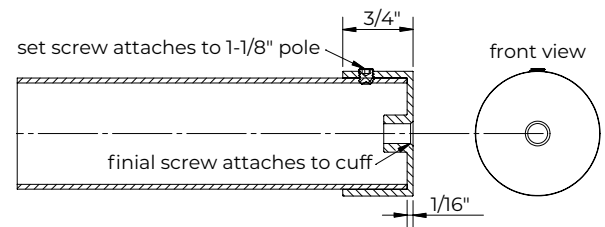

Portfolio page 7 | Quick Ship page 87
 *Requires Transitional or Deco Cuff / Finial Adapter



Portfolio page 8
 *Requires Transitional or Deco Cuff / Finial Adapter



Portfolio page 7 | Quick Ship page 88
 *Requires Transitional or Deco Cuff / Finial Adapter



Portfolio page 9
 *Requires Transitional or Deco Cuff / Finial Adapter

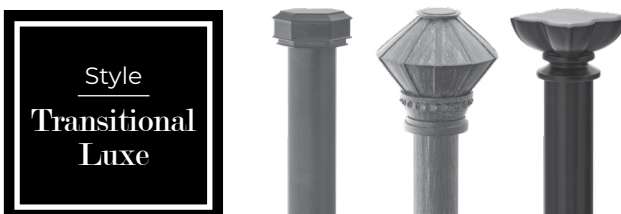

Portfolio page 8 | Quick Ship page 88
 *Requires Transitional or Deco Cuff / Finial Adapter

*Sold in pairs only.

1 3/8" Baton Draw Metal Traverse Systems

The perfect modern solution for residential or commercial applications.

Our NEW French Returns for Traverse may be ordered separately. Finials may be ordered separately from 1 3/8" Diameter Collections. Today's Traditional and Heritage Classics Finial Collections require the use of the Transitional Cuff / Finial Adapter (sold separately). See page 72.

Select from 35 Portfolio hand painted finishes (**except Antique Gold Leaf**), 6 Quick Ship Metal finishes, 5 Quick Ship Wood & Resin finishes or PTH Perfect Match™.



Single Traverse System, Wall Mount

- Wall Bracket: 3 1/2" or 6" return options
- Traverse system includes track, pendants, brackets, glides, master carriers and Ainsley end caps
- 1 3/8" collection finials and additional remote options sold separately



Double Traverse System, Wall Mount

- Wall bracket: 3" and 7 1/2" returns
- Traverse system includes tracks, pendants, brackets, glides, master carriers and Ainsley end caps
- 1 3/8" collection finials and additional remote options sold separately



Single Traverse System, Ceiling Mount

- Ceiling bracket: 3 11/16" drop
- Traverse system includes track, pendants, brackets, glides, master carriers and Ainsley end caps
- 1 3/8" collection finials and additional remote options sold separately



Double Traverse System, Ceiling Mount

- Ceiling bracket: 4" drop, 4 1/2" between centers of tracks
- Traverse system includes tracks, pendants, brackets, glides, master carriers and Ainsley end caps
- 1 3/8" collection finials and additional remote options sold separately



Single Traverse System, Low-Profile Ceiling Mount

- Ceiling bracket: 1 1/2" drop
- Traverse system includes track, pendants, brackets, glides, master carriers and Ainsley end caps
- 1 3/8" collection finials and additional remote options sold separately

1 3/8" Baton Draw Metal Traverse Systems Finishes

35 Portfolio finishes (except Antique Gold Leaf), PTH Perfect Match™, 6 Quick Ship Metal finishes or 5 Quick Ship Wood & Resin finishes.

Diameter	Track Finish	Component Color	Max. Continuous Length
1 3/8"	Amulet	White	12'
1 3/8"	Andiron	White	12'
1 3/8"	Antique Gold	White	12'
1 3/8"	Art Bronze	Bronze	12'
1 3/8"	Barnwood	Bronze	12'
1 3/8"	Black	Bronze	12'
1 3/8"	Blush	White	12'
1 3/8"	Bronzed Pewter	Bronze	12'
1 3/8"	Concrete	White	12'
1 3/8"	Couture	White	12'
1 3/8"	Dark Chocolate	Bronze	12'
1 3/8"	Firelight	White	12'
1 3/8"	Gossamer	Bronze	12'
1 3/8"	Greige	White	12'
1 3/8"	Halo	White	12'
1 3/8"	Java	Bronze	12'
1 3/8"	Linen	White	12'
1 3/8"	Luminous	Bronze	12'
1 3/8"	Manor	White	12'
1 3/8"	Mink	Bronze	12'
1 3/8"	Moonlight	Bronze	12'
1 3/8"	Mystic	White	12'
1 3/8"	New Age Bronze	Bronze	12'
1 3/8"	Patina	White	12'
1 3/8"	Shimmer	Bronze	12'
1 3/8"	Silver Maple	White	12'
1 3/8"	Spicewood	Bronze	12'
1 3/8"	Spun Gold	White	12'
1 3/8"	Stardust	White	12'
1 3/8"	Starlet	White	12'
1 3/8"	Titanium	White	12'
1 3/8"	Truffle	Bronze	12'
1 3/8"	Urban Bronze	Bronze	12'
1 3/8"	White	White	12'
1 3/8"	PTH Perfect Match™	please specify	12'
1 3/8"	Brushed Nickel	White	12'
1 3/8"	Brushed Bronze	Bronze	8'
1 3/8"	Charcoal Zinc	White	8'
1 3/8"	Matte Black	White	12'
1 3/8"	Rose Gold	White	8'
1 3/8"	Satin Gold	White	8'
1 3/8"	Antique Brass	White	12'
1 3/8"	Oil Rubbed Bronze	Bronze	12'
1 3/8"	Platinum	White	12'
1 3/8"	Rose Gold	White	12'
1 3/8"	Walnut	Bronze	12'

1 3/8" Baton Draw Metal Traverse Systems Pricing

Orders with Baton Draw Metal traverse systems will incur a \$25 packaging fee.

Name & Item #	Price										Systems are sold in 1 ft increments
---------------	-------	--	--	--	--	--	--	--	--	--	-------------------------------------

1 3/8" Baton Draw Metal Traverse System

Single Traverse System Wall Mount 3 1/2" Return	4'	5'	6'	7'	8'	9'	10'	11'	12'	price per ft
CSPTHMT138400	\$368.46	\$460.57	\$552.68	\$644.80	\$736.91	\$829.03	\$921.14	\$1,013.25	\$1,105.37	\$92.11
Single Traverse System Wall Mount 6" Return										
CSPTHMT138401	\$410.43	\$513.04	\$615.65	\$718.26	\$820.86	\$923.47	\$1,026.08	\$1,128.69	\$1,231.30	\$102.61
Double Traverse System Wall Mount										
CSPTHMT138402	\$736.91	\$921.14	\$1,105.37	\$1,289.60	\$1,473.82	\$1,658.05	\$1,842.28	\$2,026.51	\$2,210.74	\$184.23
Single Traverse System Ceiling Mount										
CSPTHMT138403	\$368.46	\$460.57	\$552.68	\$644.80	\$736.91	\$829.03	\$921.14	\$1,013.25	\$1,105.37	\$92.11
Double Traverse System Ceiling Mount										
CSPTHMT138404	\$736.91	\$921.14	\$1,105.37	\$1,289.60	\$1,473.82	\$1,658.05	\$1,842.28	\$2,026.51	\$2,210.74	\$184.23
Single Traverse System Low-Profile Ceiling Mount										
CSPTHMT138406	\$293.83	\$367.29	\$440.75	\$514.21	\$587.66	\$661.12	\$734.58	\$808.04	\$881.50	\$73.46





1 3/8" Baton Draw Metal Traverse Systems Information



Quantity Per System

Quantity included per system based on cut track length	4'	5'	6'	7'	8'	9'	10'	11'	12'	13'	14'	15'	16'	17'	18'	19'	20'
Glides [4 per foot, includes master carriers & end caps (2)]	16	20	24	28	32	36	40	44	48	52	56	60	64	68	72	76	80
Brackets	2	3	4	4	4	5	5	5	5	6	6	6	6	7	7	7	8

Batons sold separately.

Note: Metal Baton available in 6 Metal Quick Ship Finishes, 35 Portfolio finishes or PTH Perfect Match™.

					
36" Metal Baton 3/8" DIA, Metal	48" Metal Baton 3/8" DIA, Metal	60" Metal Baton 3/8" DIA, Metal	36" Clear Acrylic Baton 1/2" DIA, Acrylic	48" Clear Acrylic Baton 1/2" DIA, Acrylic	60" Clear Acrylic Baton 1/2" DIA, Acrylic
POME36WAND	POME48WAND	POME60WAND	AC36WAND	AC48WAND	AC60WAND
\$66.46 each	\$72.29 each	\$78.12 each	\$52.47 each	\$58.30 each	\$64.13 each
QSME36WAND	QSME48WAND	QSME60WAND			
\$58.30 each	\$64.13 each	\$69.96 each			

	
48" Handicap Metal Baton 4" Loop, ADA Compliant, Metal	60" Handicap Metal Baton 4" Loop, ADA Compliant, Metal
POME48HWAND	POME60HWAND
\$72.29 each	\$78.12 each
QSME48HWAND	QSME60HWAND
\$64.13 each	\$69.96 each

		
48" Handicap Clear Acrylic Baton 4" Loop, ADA Compliant, Acrylic	60" Handicap Clear Acrylic Baton 4" Loop, ADA Compliant, Acrylic	72" Handicap Clear Acrylic Baton 4" Loop, ADA Compliant, Acrylic
AC48HWAND	AC60HWAND	AC72HWAND
\$58.30 each	\$64.13 each	\$69.96 each

1 3/8" Baton Draw Metal Traverse Systems Information

1 3/8" Brackets & Connectors for additional brackets. See below for diagrams/dimensions.

					
PTHMT138400 Wall Mount 3 1/2" return	PTHMT138401 Wall Mount 6" return	PTHMT138402 Wall Mount Double	PTHMT138403 Ceiling Mount Single	PTHMT138404 Ceiling Mount Double	PTHMT138405 Ceiling Bracket Extender
\$32.65 each	\$44.31 each	\$58.30 each	\$32.65 each	\$90.95 each	\$16.32 each

		
PTHMT138406 Low-Profile Ceiling Single	PTHMT138407 Connector / Splice	PTHMT138409 Hinged Elbow
\$18.66 each	\$8.16 each	\$37.31 each

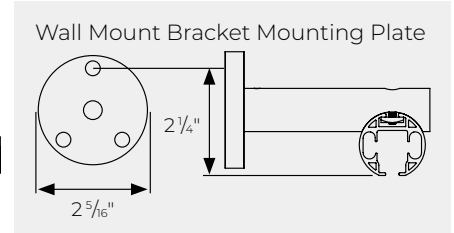
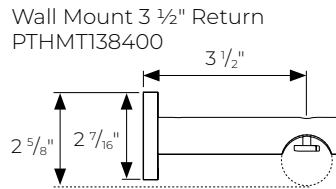

Wall Mount 6" Return
PTHMT138401

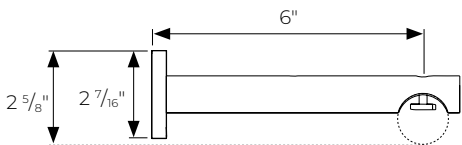

Wall Mount Double
PTHMT138402

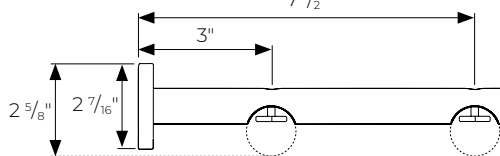

Low-Profile Ceiling Single
PTHMT138406

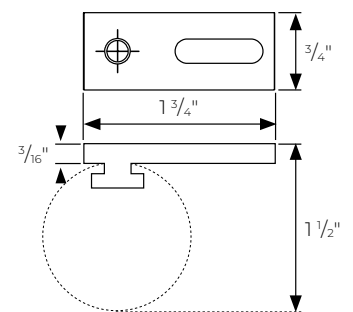

Hinged Elbow
PTHMT138409

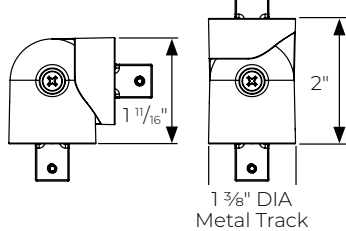

Ceiling Mount Single
PTHMT138403

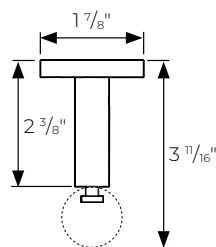

Ceiling Mount Double
PTHMT138404

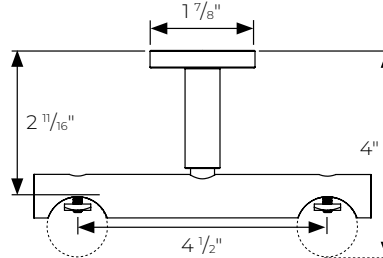

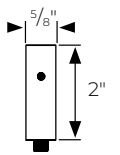

Ceiling Bracket
Extender
PTHMT138405





Carriers for additional carriers.
for master carrier diagrams, see page 84.

Pinch Pleat

Ripplefold

	
Pinch Pleat Glide CP10 or CP10/BR /BR	Ripplefold Glide /BR R4060/P R4060/P/BR R4080/P R4080/P/BR R4100/P R4100/P/BR R4120/P R4120/P/BR
Ball Bearing Wheel for smooth movement. Available in white or bronze /BR.	Ripplefold Glides with detachable pendants. Available in 60%, 80%, 100% or 120% fullness - specify fullness on order. Available in white or bronze /BR.
\$3.13 NET pack (10 pieces)	\$0.67 NET each

	
Pinch Pleat Master Carrier BT3005R or BT3005L /BR	Ripplefold Overlap Master Carrier BT3125R or BT3125L /BR
Stainless steel overlap arms with multi-wheel design for smooth movement. Available in white or bronze /BR and left or right.	Stainless steel overlap arms with snaps to accept Ripplefold tape and a multi-wheel design for smooth movement. Available in white or bronze /BR and left or right.
\$5.04 NET each	\$5.99 NET each

	
Glide Stop BT4333	Ripplefold Butt Master Carrier BT3600R or BT3600L /BR
Stainless steel overlap arms with snaps to accept Ripplefold tape and a multi-wheel design for smooth movement. Available in white or bronze /BR and left or right.	Arms with snaps to accept Ripplefold tape and a multi-wheel design for smooth movement. Butt Master Carriers do not overlap, allowing light to filter between draperies on center draw treatments. Must be specified for substitution. Available in white or bronze /BR and left or right.
\$0.58 NET each	\$6.20 NET each

Upgrade your End Caps with French Returns or Finials

1 3/8" Baton Draw Metal Traverse Systems include End Caps, but are designed to work with our NEW 1 3/8" French Returns for Traverse and all 1 3/8" Finials across three style categories. Today's Traditional and Heritage Classics Finials require the use of the Transitional Cuff / Finial Adapter to work with Metal Traverse. Modern Finials do not require the use of the Finial Adapter.

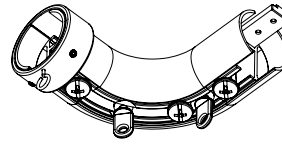

NEW

PTHMT138440

French Return for Metal Traverse

(Includes 1 Return, 1 Splice, 1 French Return Ring to reduce silight, 4 End Stops, 4 Ripplefold Carriers, 2 Pinch Pleat Carriers, 1 Allen Wrench and 2 Extra Set Screws)

Metal, 3 1/2" return, Ripplefold or Pinch Pleat

Available in any of our 35 Portfolio Hand Painted Finishes or PTH Perfect Match™

\$102.30 each

Style
Modern

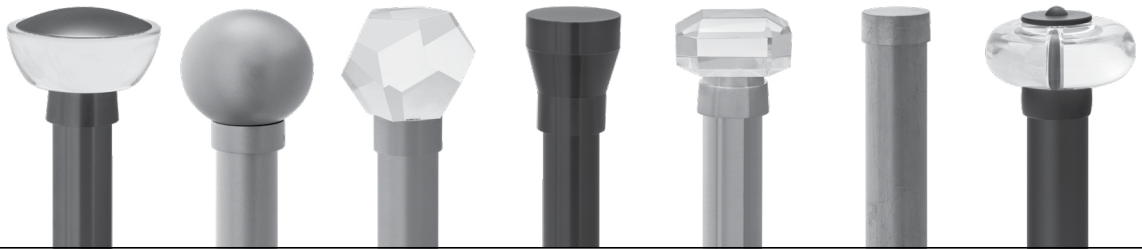

Portfolio page 14 | Quick Ship page 93 | *Transitional Cuff / Finial Adapter PO138CUFF not required

Style
Today's
Traditional



Portfolio page 17 | Quick Ship page 97 | *Requires Transitional Cuff / Finial Adapter PO138CUFF or QS138CUFF below

Style
Heritage
Classics

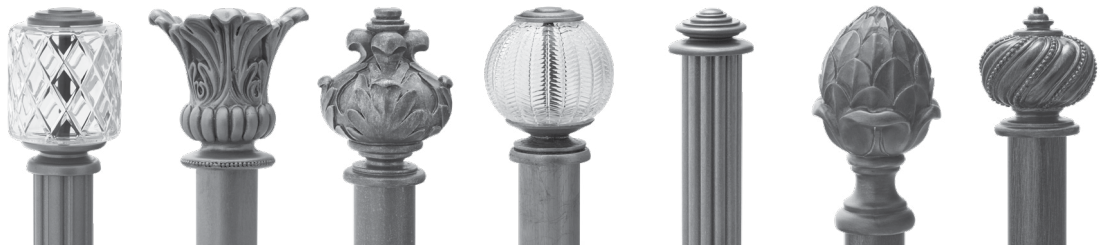

Portfolio page 17 | Quick Ship page 97 | *Requires Transitional Cuff / Finial Adapter PO138CUFF or QS138CUFF below



PO138CUFF QS138CUFF

Transitional Cuff / Finial Adapter

3/4" L x 1 1/2" W

- Metal, Available in any of our 35 Portfolio Hand Painted Finishes, 5 Quick Ship Wood & Resin Finishes or PTH Perfect Match™
- Use to adapt your 1 3/8" Today's Traditional or Heritage Classics Finial to work with Metal Traverse (required)

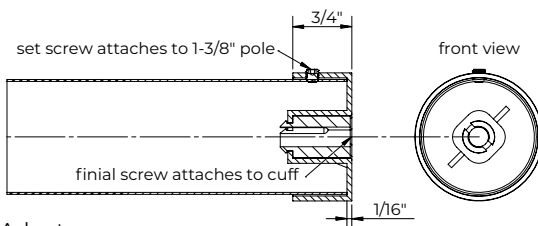

front view

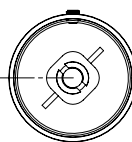

Style Meets Function



Rose - Crystal Finial with Transitional Cuff

\$45.47 pair*

**Sold in pairs only.*



PARIS TEXAS
HARDWARE

Manual Metal Traverse Collection Order Form

PO # _____ Side Mark _____ Ship via _____ Date _____

Company Information		Shipping Information	
Company Name	Acct #	Company Name	Acct #
Contact Person		Contact Person	
Street Address		Street Address	
City	State	City	State
Email	ZIP	Email	ZIP
Phone	Fax	Phone	Fax

METAL TRAVERSE SYSTEMS - Consult Price List for detailed specifications.

Item #	Finish Code	System Length (per 1')	Custom Cut Length (inches)	Draw Preference		Baton (sold separately)	Glides Pinch Pleat or Ripplefold*	Qty	Price per Unit	Subtotal
				Center	One-Way					
				<input type="checkbox"/>	<input type="checkbox"/> L <input type="checkbox"/> R		<input type="checkbox"/> PP <input type="checkbox"/> RF			
				<input type="checkbox"/>	<input type="checkbox"/> L <input type="checkbox"/> R		<input type="checkbox"/> PP <input type="checkbox"/> RF			
				<input type="checkbox"/>	<input type="checkbox"/> L <input type="checkbox"/> R		<input type="checkbox"/> PP <input type="checkbox"/> RF			
				<input type="checkbox"/>	<input type="checkbox"/> L <input type="checkbox"/> R		<input type="checkbox"/> PP <input type="checkbox"/> RF			

METAL TRAVERSE COORDINATING ACCESSORIES AND ADDITIONAL FEES
Order finials, cuffs, batons, additional brackets and accessories here.

Item #	Finish Code	Description	Qty	Price per Unit	Subtotal

Glide and Bracket Information

Quantity included per system based on cut track length

	4'	5'	6'	7'	8'	9'	10'	11'	12'	13'	14'	15'	16'	17'	18'	19'	20'	21'	22'	23'	24'
Glides [4 per foot, includes master carriers & end caps (2)]	16	20	24	28	32	36	40	44	48	52	56	60	64	68	72	76	80	84	88	92	96
Brackets	2	3	4	4	4	5	5	5	5	6	6	6	6	7	7	7	8	8	8	8	8

Special Instructions

* Must specify Ripplefold carrier fullness.

TOTAL

Answer These Questions

1. Select Ripplefold fullness:
 60% 80% 100% 120%

2. Select Ripplefold masters:
 Butt Master Overlap

Fascia Profiles for Manual Heavy Duty Systems

1 3/8"

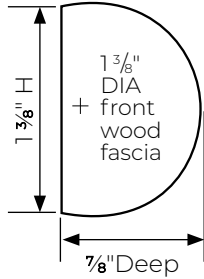
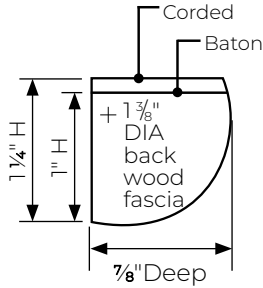

Slim Round

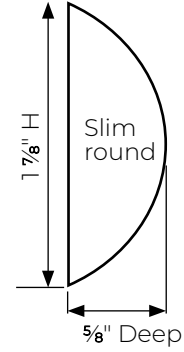

2 1/4"

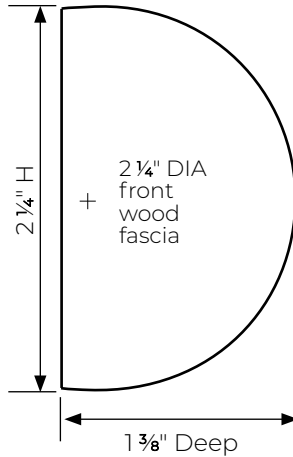
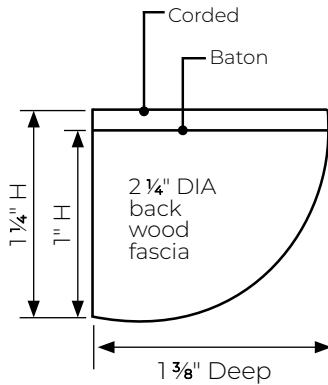

Flat

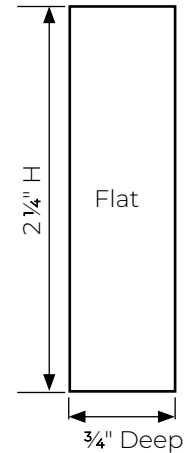

C-Rings with Fascia

Scan the QR code to the right or visit bit.ly/PTH-C-Rings for diagrams of all C-Ring Systems »



1 3/8" Single

*shown on baton draw track

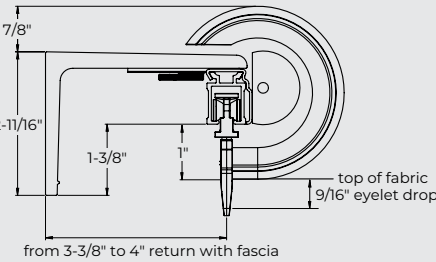

1 3/8" Double

*shown on baton draw track

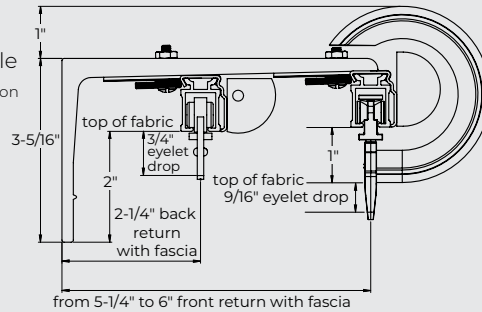

2 1/4" Single

*shown on baton draw track

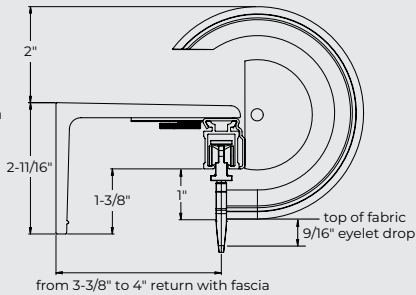

2 1/4" Double

*shown on baton draw track

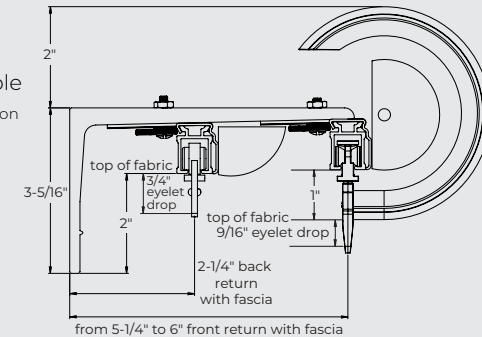

- C-Rings available for 1 3/8" and 2 1/4"
- Corded or baton draw systems
- Pinch pleat only
- Not available for traverse systems with mitered returns or stationary front pole

- For double traverse systems, C-Rings are for the front track only
- Available in any of our 35 Portfolio hand painted finishes, PTH Perfect Match™ or 5 Quick Ship Wood & Resin finishes to match your fascia finish

Heavy Duty Corded or Baton Traverse Systems

Heavy Duty System is recommended for heavier treatments with lining. Longer lengths are versatile for residential or commercial projects.

Decorative wood fascia available in 1 3/8" or 2 1/4" smooth, reeded or grooved / fluted profiles with coordinating finials, 1 7/8" slim round smooth profile, 2 1/4" flat smooth profile with flush ends or mitered returns.

Select from 35 Portfolio Hand Painted Finishes, PTH Perfect Match™ or 5 Quick Ship Wood and Resin Finishes.

Single Traverse System

- Coordinates with all fascia profiles or available with no fascia
- Standard corded single bracket has 3 7/8" - 5 3/8" return;
- standard baton single bracket has adjustable 3 3/8" - 4" return
- Longer return bracket options may be substituted at no charge
- Batons and finials sold separately
- C-Rings available for 1 3/8" and 2 1/4"



Double Traverse System

Back track available with or without wood fascia. Back track shown with fascia and end caps.

- Coordinates with all fascia profiles or available with no fascia
- Standard corded double brackets have 3" back track and adjustable 6" - 7 1/2" front track return; standard baton double brackets have 2 3/4" back track and adjustable 5 1/4" - 6" front track return
- Longer return bracket options may be substituted at no charge
- Batons and finials sold separately
- C-Rings available for 1 3/8" and 2 1/4" (front track)



(front and back fascia shown; front fascia only also available)

Single or Double Traverse System With Mitered Returns

Back track available with or without wood fascia. Finials and c-rings are not available with this option.

- Coordinates with all fascia profiles
- Standard corded single bracket has 4" - 5 1/2" return; standard baton single bracket has adjustable 3 3/8" - 4" return
- Standard corded double brackets have 3" back track and adjustable 6" - 7 1/2" front track return; standard baton double brackets have 2 3/4" back track and adjustable 5 1/4" - 6" front track return
- Batons and mitered returns sold separately
- C-Rings not available

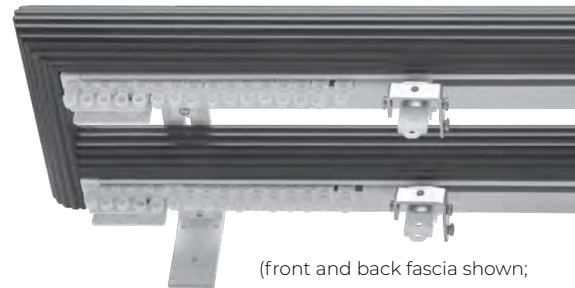

(front and back fascia shown; front fascia only also available; mitered returns on front only)

Stationary Front Pole With Back Traverse System

2 1/4" wood poles can be used. Back track available with or without wood fascia. Back track shown with fascia and end caps.

- Traverse system coordinates with all 2 1/4" round fascia profiles; flat and slim fascia may not be used
- Coordinates with 2 1/4" poles for stationary front pole
- Stationary front pole and TBKT bracket finished to match pole are included
- Batons and finials sold separately
- Full rings available on stationary front pole, sold separately;
- C-Rings not available



(back fascia shown; front pole only also available)



Batons

(if applicable, sold separately)
 Fiberglass or Clear Acrylic | Stainless Steel Clip
 36", 48" or 60"



Note: Fiberglass Baton available in 5 Wood & Resin Quick Ship Finishes, 35 Portfolio finishes or PTH Perfect Match™.

	
36" Fiberglass Baton 3/8" DIA, Fiberglass	36" Clear Acrylic Baton 1/2" DIA, Acrylic
PORE36WAND	AC36WAND
\$67.63 each	\$52.47 each

QSRE36WAND
\$67.63 each

	
48" Fiberglass Baton 3/8" DIA, Fiberglass	48" Clear Acrylic Baton 1/2" DIA, Acrylic
PORE48WAND	AC48WAND
\$73.46 each	\$58.30 each

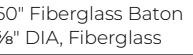
QSRE48WAND
\$73.46 each

	
60" Fiberglass Baton 3/8" DIA, Fiberglass	60" Clear Acrylic Baton 1/2" DIA, Acrylic
PORE60WAND	AC60WAND
\$79.29 each	\$64.13 each

QSRE60WAND
\$79.29 each

AC48HWAND
48" Handicap Clear Acrylic Baton
4" Loop, ADA Compliant, Acrylic
\$58.30 each

AC60HWAND
60" Handicap Clear Acrylic Baton
4" Loop, ADA Compliant, Acrylic
\$64.13 each

AC72HWAND
72" Handicap Clear Acrylic Baton
4" Loop, ADA Compliant, Acrylic
\$69.96 each

Finishes

Decorative wood fascia available in 1 3/8" or 2 1/4" smooth, reeded or grooved / fluted profiles with coordinating finials, 1 7/8" slim round smooth profile, 2 1/4" flat smooth profile with flush ends or mitered returns - see next page. Select from 35 Portfolio Hand Painted Finishes, PTH Perfect Match™ or 5 Quick Ship Wood and Resin Finishes.

Diameter	Fascia Finish	Track and Bracket* Color	Component Color	
1 3/8" or 2 1/4" smooth, reeded or grooved / fluted profiles with coordinating finials	Amulet	White	White	
	Andiron	White	White	
	Antique Gold	White	White	
	Antique Gold Leaf	White	White	
	Art Bronze	Bronze	Bronze	
	Barnwood	Bronze	Bronze	
	Black	Bronze	Bronze	
	Blush	White	White	
	Bronzed Pewter	Bronze	Bronze	
	Concrete	White	White	
	Couture	White	White	
	Dark Chocolate	Bronze	Bronze	
	Firelight	White	White	
	Gossamer	Bronze	Bronze	
	Greige	White	White	
	Halo	White	White	
	Java	Bronze	Bronze	
	Linen	White	White	
	Luminous	Bronze	Bronze	
	Manor	White	White	
	Mink	Bronze	Bronze	
	Moonlight	Bronze	Bronze	
	2 1/4" flat smooth profile	Mystic	White	White
		New Age Bronze	Bronze	Bronze
		Patina	White	White
	With flush ends or mitered returns	Shimmer	Bronze	Bronze
		Silver Maple	White	White
		Spicewood	Bronze	Bronze
		Spun Gold	White	White
		Stardust	White	White
		Starlet	White	White
		Titanium	White	White
		Truffle	Bronze	Bronze
Urban Bronze		Bronze	Bronze	
White		White	White	
PTH Perfect Match™		please specify	please specify	
Antique Brass		White	White	
Oil Rubbed Bronze		Bronze	Bronze	
Platinum		White	White	
Rose Gold		White	White	
Walnut	Bronze	Bronze		

White brackets may be substituted upon request.

Heavy Duty Corded or Baton Traverse Systems Fascia Profiles



Smooth

- 1 3/8" and 2 1/4" diameters available
- See below for coordinating finial options



Reeded

- 1 3/8" and 2 1/4" diameters available
- See below for coordinating finial options



Grooved / Fluted

- 1 3/8" and 2 1/4" diameters available
- See below for coordinating finial options



Slim Round Smooth, No Finials

- 1 7/8" diameter, available with flush ends or mitered returns



Flat Smooth, No Finials

- 2 1/4" height, available with flush ends or mitered returns



Mitered Returns (sold separately)

- 1 3/8", 1 7/8" and 2 1/4" diameters available
- All profiles

Upgrade your Manual HD Traverse with Finial Styles

Finials are sold separately. 1 3/8" or 2 1/4" Portfolio and Quick Ship Wood and Resin finials are compatible across two style categories. Somfy systems are not available with 1 3/8" fascias and finials.



Style
Today's
Traditional

1 3/8" Portfolio page 17 | 1 3/8" Quick Ship page 97 | 2 1/4" Portfolio page 22 | 2 1/4" Quick Ship page 102



Style
Heritage
Classics

1 3/8" Portfolio page 17 | 1 3/8" Quick Ship page 97 | 2 1/4" Portfolio page 23 | 2 1/4" Quick Ship page 102

Heavy Duty Corded or Baton Traverse Systems Pricing

Item # for Corded System	Item # for Baton System	Name				
--------------------------	-------------------------	------	--	--	--	--

Manual Heavy Duty Corded or Baton Traverse System with Wood Fascia

Track System with Wood Corded Systems	Fascia(s) for 1 3/8" round Baton Systems (batons sold separately)		4'	6'	8'	10'
CSPTHC138WF	CSPTHB138WF	Single with Fascia, No Rings	\$489.72	\$731.72	\$973.72	\$1,215.72
CSPTHC138WFFDBL	CSPTHB138WFFDBL	Double with Front Fascia, No Rings	\$816.20	\$1,218.47	\$1,620.74	\$2,023.01
CSPTHC138WFDBL	CSPTHB138WFDBL	Double with Front & Back Fascias, No Rings	\$979.44	\$1,463.44	\$1,947.44	\$2,431.44
CSPTHC138WFC	CSPTHB138WFC	Single with Fascia, C-Rings	\$1,825.75	\$2,231.10	\$2,636.45	\$3,041.80
CSPTHC138WFFCDBL	CSPTHB138WFFCDBL	Double with Front Fascia, C-Rings	\$1,107.70	\$1,688.50	\$2,269.30	\$2,850.10
CSPTHC138WFCDBL	CSPTHB138WFCDBL	Double with Front & Back Fascias, C-Rings	\$1,270.94	\$1,918.29	\$2,565.64	\$3,212.99

Track System with Wood Corded Systems	Fascia(s) for 1 7/8" slim, 2 1/4" flat smooth, 2 1/4" round* Baton Systems (batons sold separately)		4'	6'	8'	10'
---------------------------------------	-----------------------------------------------------------------------------------------------------	--	----	----	----	-----

*available in 2 1/4" round only 1 7/8" slim and 2 1/4" flat smooth double systems are available in the front fascia option only 1 7/8" slim and 2 1/4" flat smooth are not available with c-rings						
CSPTHC214WF	CSPTHB214WF	Single with Fascia, No Rings	\$635.47	\$962.17	\$1,288.87	\$1,615.57
CSPTHC214WFFDBL	CSPTHB214WFFDBL	Double with Front Fascia, No Rings	\$961.95	\$1,464.10	\$1,966.25	\$2,468.40
CSPTHC214WFDBL	CSPTHB214WFDBL	Double with Front & Back Fascias, No Rings *	\$1,270.94	\$1,924.34	\$2,577.74	\$3,231.14
CSPTHC214WFC	CSPTHB214WFC	Single with Fascia, C-Rings *	\$932.80	\$1,416.80	\$1,900.80	\$2,384.80
CSPTHC214WFFCDBL	CSPTHB214WFFCDBL	Double with Front Fascia, C-Rings *	\$1,259.28	\$1,918.73	\$2,578.18	\$3,237.63
CSPTHC214WFCDBL	CSPTHB214WFCDBL	Double with Front & Back Fascias, C-Rings *	\$1,568.27	\$2,378.97	\$3,189.67	\$4,000.37
CSPTHC214SDBL	CSPTHB214SDBL	Double with Stationary Front & No Fascia *	\$820.86	\$1,151.19	\$1,481.52	\$1,811.85
CSPTHC214WFBSDBL	CSPTHB214WFBSDBL	Double with Stationary Front & Back Fascia *	\$1,129.85	\$1,611.43	\$2,093.01	\$2,574.59

Manual Heavy Duty Corded or Baton Traverse System without Wood Fascia

Single Track System Corded Systems	track available in white and bronze Baton Systems (batons sold separately)		4'	6'	8'	10'
CSPTHCTRACK	CSPTHBTRACK	Single with No Fascia	\$326.48	\$501.93	\$677.38	\$852.83
CSPTHCTRACKDBL	CSPTHBTRACKDBL	Double with No Fascia	\$652.96	\$1,003.86	\$1,354.76	\$1,705.66

includes 1 track, components, your choice of brackets, and fascia with fascia clips when applicable.

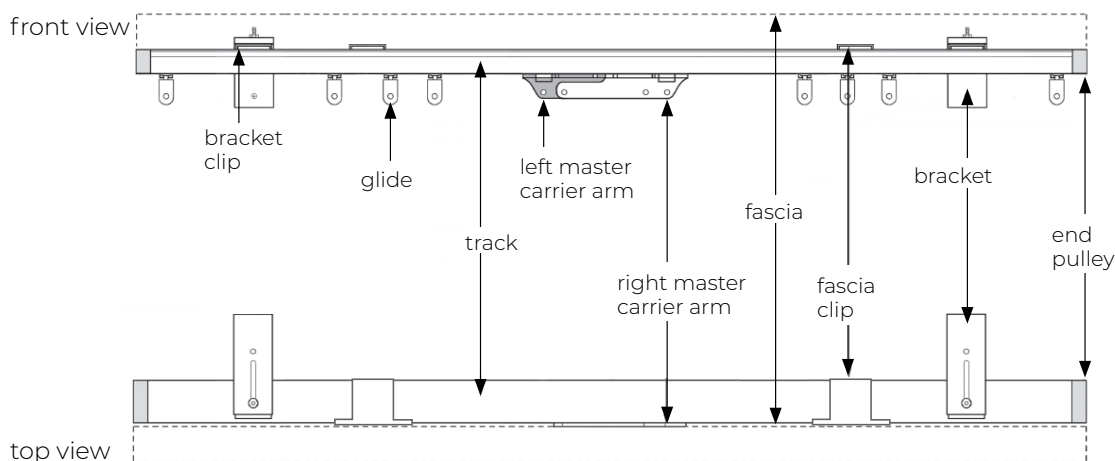

Quantity per System

Quantity included per system based on cut track length	4'	6'	8'	10'	12'	14'	16'	18'	20'
Pinch Pleat Glides [4 per foot, includes master carriers (2) & end caps (2)]	16	24	32	40	48	56	64	72	80
Brackets (1 per every 3-4 feet)	2	3	4	4	5	6	6	7	8

Note: All orders with poles and/or traverse rods will incur a \$10.00 packaging fee per order.

Pricing Includes Track, Components and your choice of TB035-, TB060- or TB100- Brackets

Spliced systems begin at 16' for Corded and 20' for Baton

	12'	14'	16'	18'	20'	per add'l 2 ft
	\$1,457.72	\$1,699.72	\$1,941.72	\$2,183.72	\$2,425.72	\$242.00
	\$2,425.28	\$2,827.55	\$3,229.82	\$3,632.09	\$4,034.36	\$402.27
	\$2,915.44	\$3,399.44	\$3,883.44	\$4,367.44	\$4,851.44	\$484.00
	\$3,447.15	\$3,852.50	\$4,257.85	\$4,663.20	\$5,068.55	\$405.35
	\$3,430.90	\$4,011.70	\$4,592.50	\$5,173.30	\$5,754.10	\$580.80
	\$3,860.34	\$4,507.69	\$5,155.04	\$5,802.39	\$6,449.74	\$647.35
	\$1,942.27	\$2,268.97	\$2,595.67	\$2,922.37	\$3,249.07	\$326.70
	\$2,970.55	\$3,472.70	\$3,974.85	\$4,477.00	\$4,979.15	\$502.15
	\$3,884.54	\$4,537.94	\$5,191.34	\$5,844.74	\$6,498.14	\$653.40
	\$2,868.80	\$3,352.80	\$3,836.80	\$4,320.80	\$4,804.80	\$484.00
	\$3,897.08	\$4,556.53	\$5,215.98	\$5,875.43	\$6,534.88	\$659.45
	\$4,811.07	\$5,621.77	\$6,432.47	\$7,243.17	\$8,053.87	\$810.70
	\$2,142.18	\$2,472.51	\$2,802.84	\$3,133.17	\$3,463.50	\$330.33
	\$3,056.17	\$3,537.75	\$4,019.33	\$4,500.91	\$4,982.49	\$481.58

Spliced systems begin at 16' for Corded and 20' for Baton

	12'	14'	16'	18'	20'	per add'l 2 ft
	\$1,028.28	\$1,203.73	\$1,379.18	\$1,554.63	\$1,730.08	\$175.45
	\$2,056.56	\$2,407.46	\$2,758.36	\$3,109.26	\$3,460.16	\$350.90

Additional Heavy Duty Traverse Fees

PTHFEEMITER-EACH Wood Fascia Mitered Return per return	\$80.00
PTHFEEMITER-45 Wood Fascia Mitered Cut 45° angle (90° corner) per connection	\$65.00
PTHFEEMITER-NON45 Wood Fascia Mitered Cut non-45° angle (non-90° corner) per connection	\$65.00
PTHFEEBLEND Blended Fascia Splice per blend	\$108.00
PTHFEEFASCUT Fascia Fabrication Fee (if ordering fascia alone, order full pole and specify fascia fabrication) per Fascia	\$65.00
PTHFEEERESTRING Restringing Fee per track	\$100.00
Standard 45 Fascia Splice	No Charge

Please specify:

- Item number for track or track with wood fascia
- Track length (custom cut length is finished track length + 1/4" fascia on each end to receive finial)
- Track and matching bracket color (if not specified, we will select color to match fascia finish)
- Bracket return: see page 80 for details.
- Cord location: right or left
- Draw: center, one-way stack right or one-way stack left
- Number of carriers if different than 4 per foot
- Pinch pleat or Ripplefold® style carriers
- Cord drop (standard is 120")
- Finish name for fascia, if selected

Component Colors

	White	Bronze
Track	●	●
Master Carriers	●	●
Glides	●	●
Brackets	●	●
End Pulleys / Caps	●	●

Product information

- Single Corded or Baton traverse system price includes: traversing track, components, brackets (see system quantity chart on previous page) and 3 - 4 carriers per foot.
- Sold in 2' in increments, 4' minimum.
- Cut to specified length. Fall off will not be saved or shipped.
- Track maximum continuous length up to 240 inches (20'); splice lengths available up to 40' for center draw only.
- Track, bracket and components available in White or Bronze.
- Center or One-Way draw available.
- Fascia, if selected, in 1 3/8" or 2 1/4" wood pole profiles, available up to 16' in Portfolio or 12' in Quick Ship, is clipped onto traverse system track with a fascia L-bracket. Fascia over 16' in Portfolio finishes and 12' in Quick Ship finishes will be spliced.
- Standard cord drop: 120"
- Mitered fascia will add the following to the traverse system:

Fascia	Depth	+ to traverse system
1 3/8"	7/8"	2"
2 1/4"	1 3/8"	3"
Flat	3/4"	1 3/4"
Slim Round	5/8"	1 1/2"

Heavy Duty Stack Back Calculation (each drapery panel)

Heavy Duty pinch pleat: master carrier + (# glides on panel x .63") + 2.75" (0") = stack per drapery panel for cord draw (baton draw)

Heavy Duty Ripplefold*: master carrier + (# glides on panel x .563") + 2.75" (0") = stack per drapery panel for cord draw (baton draw)

*note: number of glides on panel depends on which fullness of Ripplefold tape being used. Consult your workroom for quantity.

EX: Heavy Duty pinch pleat, 20ft. one-way cord draw (standard 4 glides per ft.)

4.25" + [80 glides on panel x .63"] + 2.75" = 57.5" stack back, per drapery panel BEFORE drapery fabric is installed

Please note: Calculations result in Stack Back Width BEFORE drapery fabric is installed. Stack back width will increase once draperies are installed. Factors such as thickness of drapery fabric, type of drapery pleat, and fullness of treatment affect the final stack back width. Please consult your workroom to determine your final stack back based on your draperies.

Heavy Duty Corded Traverse Systems Information

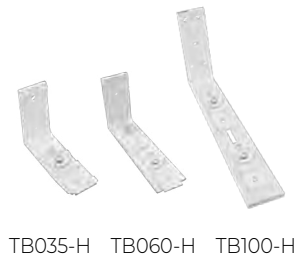

<p>HD Corded Single TB035-H /BR</p>	<p>2 1/16" H x 1 1/2" W backplate, adjustable up to 5 3/8" return Available in white or bronze /BR.</p>	<p>\$33.52 each</p>
-------------------------------------------------------	-------------------------------------------------------------------------------------------------------------	---------------------

<p>HD Corded Single or Double TB060-H /BR</p>	<p>3 5/16" H x 1 1/2" W backplate, adjustable 6" - 7 1/2" front return and 3" back return Available in white or bronze /BR.</p>	<p>\$53.64 each</p>
-----------------------------------------------------------------	-------------------------------------------------------------------------------------------------------------------------------------	---------------------

<p>HD Corded Single, Double or Triple TB100-H /BR</p>	<p>4 1/2" H x 1 1/2" W backplate, adjustable up to 11 1/4" return Available in white or bronze /BR.</p>	<p>\$53.64 each</p>
-------------------------------------------------------------------------	-------------------------------------------------------------------------------------------------------------	---------------------



<p>HD Corded Ceiling Mount Clip Single CD533</p>	<p>5/8" H x 2 5/8" D x 7/8" W May only be used in corded systems without fascia - for double ceiling mount installation, install two brackets into ceiling. Available in white.</p>	<p>\$3.34 NET each</p>
-------------------------------------------------------------	-----------------------------------------------------------------------------------------------------------------------------------------------------------------------------------------	------------------------



<p>HD Corded Fascia Mount Clip CD4001FC</p>	<p>1/2" H x 1" W Use to attach fascia to corded traverse systems; included. Available in zinc.</p>	<p>\$7.79 NET each</p>
--------------------------------------------------------	--------------------------------------------------------------------------------------------------------	------------------------



<p>Corded Pinch Pleat Master Carrier /BR CD3300R or CD3300L</p>	<p>Stainless steel overlap arms with multi-wheel design for smooth movement. Available in white or bronze /BR and left or right.</p>	<p>\$5.99 NET each</p>
-----------------------------------------------------------------------------------	--------------------------------------------------------------------------------------------------------------------------------------	------------------------



<p>Corded Ripplefold Overlap Master Carrier /BR CD3412R or CD3412L</p>	<p>Stainless steel overlap arms with snaps to accept Ripplefold tape and a multi-wheel design for smooth movement. Available in white or bronze /BR and left or right.</p>	<p>\$5.99 NET each</p>
------------------------------------------------------------------------------------------	----------------------------------------------------------------------------------------------------------------------------------------------------------------------------	------------------------

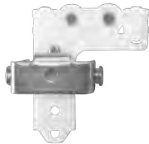

<p>Corded Ripplefold Butt Master Carrier /BR CD3600R or CD3600L</p>	<p>Arms with snaps to accept Ripplefold tape and a multi-wheel design for smooth movement. Butt Master Carriers do not overlap, allowing light to filter between draperies on center draw treatments. Must be specified for substitution. Available in white or bronze /BR and left or right.</p>	<p>\$6.20 NET each</p>
---------------------------------------------------------------------------------------	---------------------------------------------------------------------------------------------------------------------------------------------------------------------------------------------------------------------------------------------------------------------------------------------------	------------------------



<p>Corded Pinch Pleat C-Ring Master Carrier /BR CD3500R or CD3500L</p>	<p>Stainless steel overlap arms with multi-wheel design for smooth movement. Available in white or bronze /BR and left or right.</p>	<p>\$5.04 NET each</p>
------------------------------------------------------------------------------------------	--------------------------------------------------------------------------------------------------------------------------------------	------------------------



<p>Corded Universal End Pulley Body /BR CD4311R or CD4311L</p>	<p>Pendants sold separately. Available in white or bronze /BR and left or right.</p>	<p>\$5.99 NET each</p>
----------------------------------------------------------------------------------	--------------------------------------------------------------------------------------	------------------------



<p>Corded One-Way End Pulley Body /BR CD4310R or CD4310L</p>	<p>Pendants sold separately. Available in white or bronze /BR and left or right.</p>	<p>\$2.92 NET each</p>
--------------------------------------------------------------------------------	--------------------------------------------------------------------------------------	------------------------



<p>HD Custom Over-Bracket Single TBKT214-H</p>	<p>3 1/2" H x 3/4" W backplate, 7 7/8" front return and 3" back return Use to combine 2 1/4" full wood pole with single traverse systems; includes traverse ceiling mount bracket attached onto the bottom of the over-bracket. Fascias sold separately. Available in any of our 35 hand painted Portfolio finishes, 5 Quick Ship Wood & Resin finishes or your own custom PTH Perfect Match™ finish. Steel</p>	<p>\$93.86 each</p>
-----------------------------------------------------------	-------------------------------------------------------------------------------------------------------------------------------------------------------------------------------------------------------------------------------------------------------------------------------------------------------------------------------------------------------------------------------------------------------------------------	---------------------



<p>HD Custom Ceiling Single CMTB-H</p>	<p>2 3/4" H x 3/4" W backplate. Specify drop: contingent upon which fascia or finials are chosen - for double ceiling mount installation, install two brackets into ceiling. Steel When ordering, specify: A. Fascia diameter and profile. B. Projection to carrier and/or to front of fascia. C. Drop from ceiling to carrier eyelet and/or from ceiling to top of fascia (tip: finial must clear ceiling). D. Width of mounting plate if longer than 2 3/4".</p>	<p>\$80.45 each</p>
---------------------------------------------------	----------------------------------------------------------------------------------------------------------------------------------------------------------------------------------------------------------------------------------------------------------------------------------------------------------------------------------------------------------------------------------------------------------------------------------------------------------------------------------------	---------------------

Single Corded Bracket
TB035-H

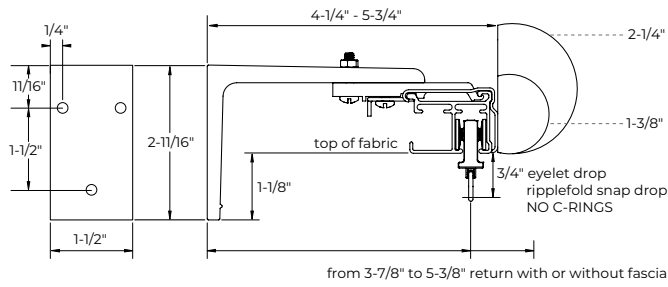

Single or Double Corded Bracket
TB060-H

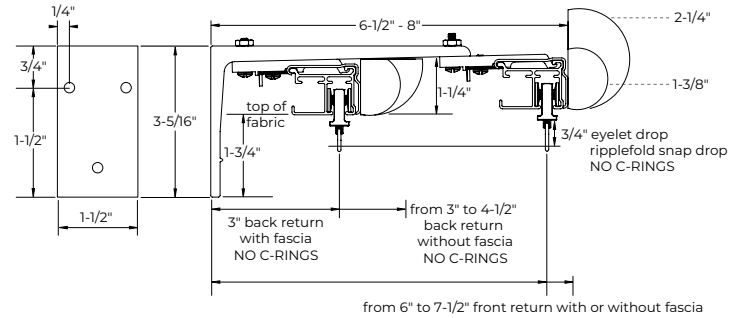

Scan the QR code to the right or visit bit.ly/PTH-C-Rings for diagrams of C-Ring Systems »



Single, Double or Triple Corded Bracket
TB100-H

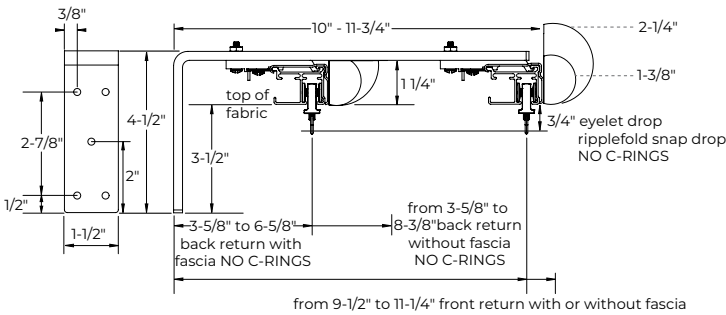

Corded Single Ceiling Mount Bracket
CD533

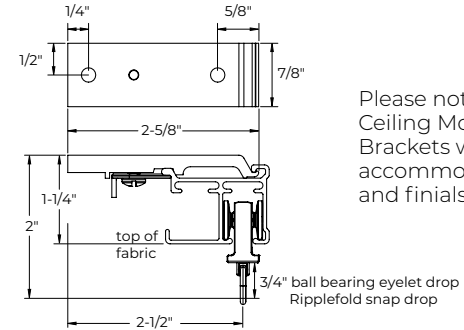

Please note: only Ceiling Mount Brackets will not accommodate fascia and finials.

Custom Over-Bracket
TBKT214-H

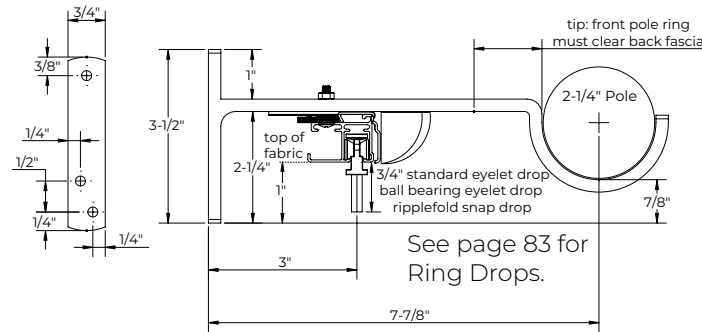

Custom Ceiling Bracket
CMTB-H

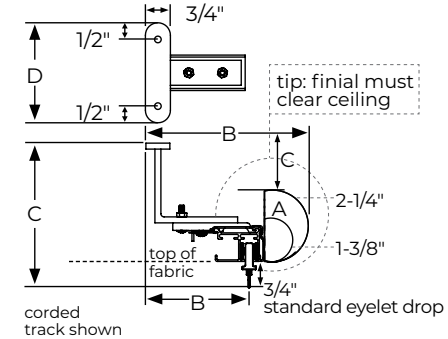

When ordering, specify:
A. Fascia diameter and profile.
B. Projection to carrier and/or to front of fascia.
C. Drop from ceiling to carrier eyelet and/or from ceiling to top of fascia (tip: finial must clear ceiling).
D. Width of mounting plate if longer than 2 3/4".

Corded Track

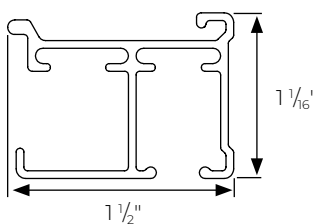

ANSI Standards: Child Safety Warning Tags

ANSI Standard 100.1: Safety of Corded Window Coverings Requires warning tags for child safety on all interior drapery hardware and window covering products that incorporate cords, bead chains, cord shrouds or any type of flexible loop control device in their operation INCLUDING sales collateral materials.

Heavy Duty Baton Traverse Systems Information



TB035-HB

HD Baton Single TB035-HB /BR	2 11/16" H x 1 1/2" W backplate, adjustable up to 4" return Available in white or bronze /BR.	\$33.52 each
----------------------------------------	--------------------------------------------------------------------------------------------------	--------------



TB060-HB

TB100-HB

HD Baton Single or Double TB060-HB /BR	3 3/8" H x 1 1/2" W backplate, adjustable 5 1/4" - 6" front return and adjustable 2 1/4" - 3 1/8" back return Available in white or bronze /BR.	\$53.64 each
-----------------------------------------------------	-------------------------------------------------------------------------------------------------------------------------------------------------------	--------------

HD Baton Single, Double or Triple TB100-HB /BR	4 1/2" H x 1 1/2" W backplate, adjustable up to 9 3/4" return Available in white or bronze /BR.	\$53.64 each
-------------------------------------------------------------	----------------------------------------------------------------------------------------------------	--------------



HD Baton Ceiling Mount Clip Single BT5333	3/4" H x 2 1/4" D x 1" W May only be used in baton systems without fascia - for double ceiling mount installation, install two brackets into ceiling. Available in white.	\$1.06 NET each
-------------------------------------------------	------------------------------------------------------------------------------------------------------------------------------------------------------------------------------------	--------------------



HD Baton Fascia Mount Clip BT4003NFC	1/2" H x 1" W Use to attach fascia to baton traverse systems; included. Available in zinc.	\$7.79 NET each
--------------------------------------------	--------------------------------------------------------------------------------------------------	--------------------



Baton Pinch Pleat Master Carrier /BR BT3005R or BT3005L	Stainless steel overlap arms with multi-wheel design for smooth movement. Available in white or bronze /BR and left or right.	\$5.04 NET each
----------------------------------------------------------------------	-------------------------------------------------------------------------------------------------------------------------------------	--------------------



Baton Ripplefold Overlap Master Carrier /BR BT3125R or BT3125L	Stainless steel overlap arms with snaps to accept Ripplefold tape and a multi-wheel design for smooth movement. Available in white or bronze /BR and left or right.	\$5.99 NET each
--------------------------------------------------------------------------------	---------------------------------------------------------------------------------------------------------------------------------------------------------------------------	--------------------



Baton Ripplefold Butt Master Carrier /BR BT3600R or BT3600L	Arms with snaps to accept Ripplefold tape and a multi-wheel design for smooth movement. Butt Master Carriers do not overlap, allowing light to filter between draperies on center draw treatments. Must be specified for substitution. Available in white or bronze /BR and left or right.	\$6.20 NET each
-----------------------------------------------------------------------------	--------------------------------------------------------------------------------------------------------------------------------------------------------------------------------------------------------------------------------------------------------------------------------------------------------	--------------------



Baton Pinch Pleat C-Ring Master Carrier /BR BT3501R or BT3501L	Stainless steel overlap arms with multi-wheel design for smooth movement. Available in white or bronze /BR and left or right.	\$5.04 NET each
--------------------------------------------------------------------------------	-------------------------------------------------------------------------------------------------------------------------------------	--------------------



Baton Pinch Pleat End Cap /BR BT4013	Available in white or bronze /BR.	\$1.38 NET each
---------------------------------------------------	-----------------------------------	--------------------



Baton Pinch Pleat C-Ring End Cap /BR BT4500	Right or Left. Pinch Pleat with C-Rings. Available in white or bronze /BR.	\$1.38 NET each
----------------------------------------------------------	-------------------------------------------------------------------------------	--------------------



Baton Ripplefold End Cap BT4123	Available in white or bronze /BR.	\$1.48 NET each
---------------------------------------	-----------------------------------	--------------------



HD Custom Over-Bracket Single TBKT214-HB	3 1/2" H x 3/4" W backplate, 7 7/8" front return and 3" back return Use to combine 2 1/4" full wood pole with single traverse systems; includes traverse ceiling mount bracket attached onto the bottom of the over-bracket. Fascias sold separately. Available in any of our 35 hand painted Portfolio finishes, 5 Quick Ship Wood & Resin finishes or your own custom PTH Perfect Match™ finish. Steel	\$93.86 each
---------------------------------------------------	----------------------------------------------------------------------------------------------------------------------------------------------------------------------------------------------------------------------------------------------------------------------------------------------------------------------------------------------------------------------------------------------------------------------------	--------------



HD Custom Ceiling Single CMTB-HB	2 3/4" H x 3/4" W backplate. Specify drop: contingent upon which fascia or finials are chosen - for double ceiling mount installation, install two brackets into ceiling. Steel	\$80.45 each
----------------------------------------	------------------------------------------------------------------------------------------------------------------------------------------------------------------------------------------	--------------

Single Baton Bracket
TB035-HB

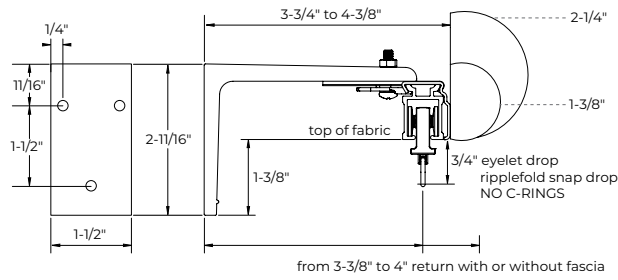

Single or Double Baton Bracket
TB060-HB

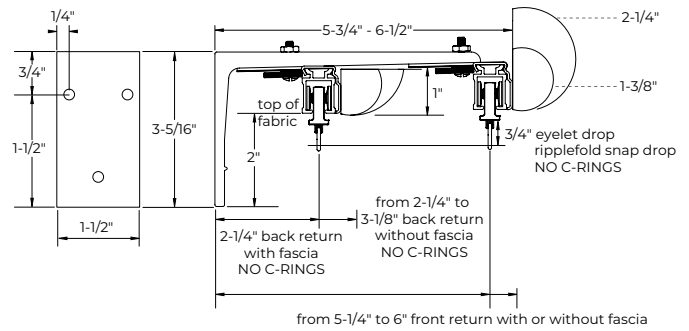

Scan the QR code to the right or visit bit.ly/PTH-C-Rings for diagrams of C-Ring Systems »



Single, Double or Triple Baton Bracket
TB100-HB

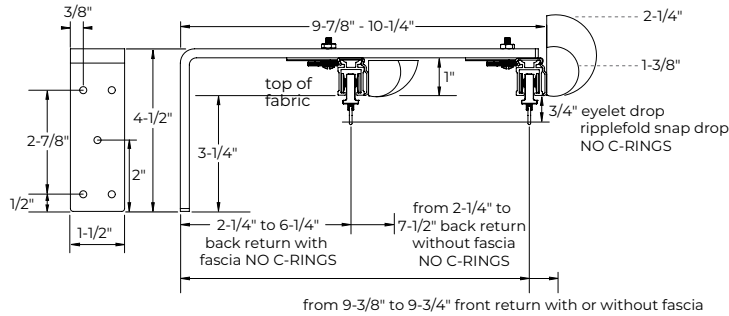

Baton Single Ceiling Mount Bracket
BT5333

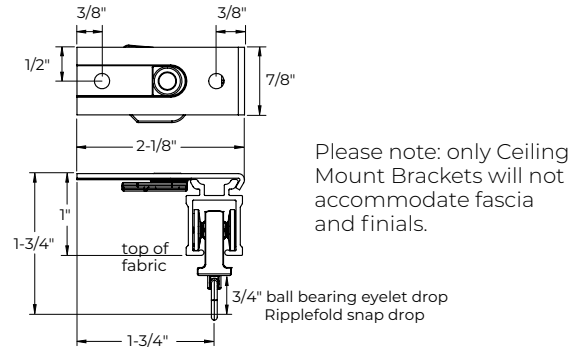

Custom Over-Bracket
TBKT214-HB

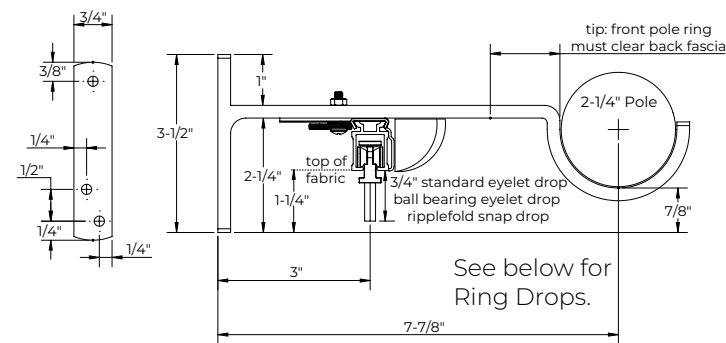

Custom Ceiling Bracket
CMTB-HB

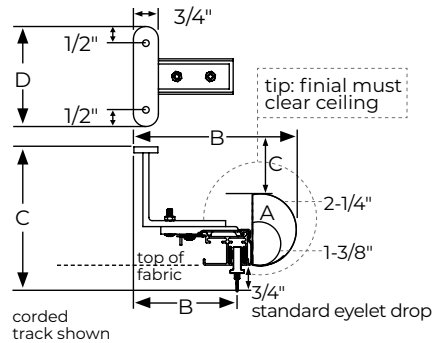

Baton Track

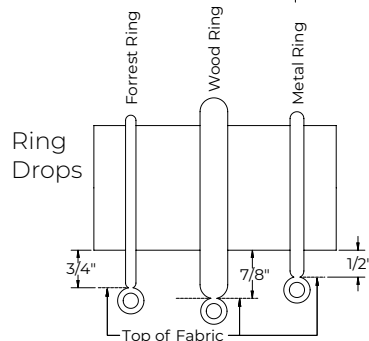
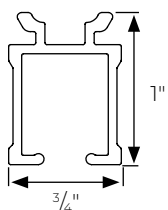

When ordering, specify:
 A. Fascia diameter and profile.
 B. Projection to carrier and/or to front of fascia.
 C. Drop from ceiling to carrier eyelet and/or from ceiling to top of fascia (tip: finial must clear ceiling).
 D. Width of mounting plate if longer than 2 3/4".

Heavy Duty Corded or Baton Traverse Systems Information

Carriers for additional carriers.

Pinch Pleat



Ripplefold



Pinch Pleat with C-Rings



For C-Ring System Diagrams, see page 74.



Pinch Pleat Glide
CP10 or CP10/BR **/BR**

Ball Bearing Wheel for smooth movement. Available in white or bronze /BR.

Included in system pricing.

\$3.13 NET pack
(10 pieces)



Ripplefold Glide **/BR**
R4060/P R4060/P/BR
R4080/P R4080/P/BR
R4100/P R4100/P/BR
R4120/P R4120/P/BR

Ripplefold Glides with detachable pendants. Available in 60%, 80%, 100% or 120% fullness - specify fullness on order. Available in white or bronze /BR.

\$0.67 NET each



1 3/8" C-Rings
carriers sold separately

138CR
2" ID, 3 1/4" OD

Available in all 35 Portfolio custom hand painted finishes, 5 Quick Ship Wood & Resin finishes or PTH Perfect Match™.

\$13.41 each



2 1/4" C-Rings
carriers sold separately

214CR
3 1/8" ID, 4 3/8" OD

Available in all 35 Portfolio custom hand painted finishes, 5 Quick Ship Wood & Resin finishes or PTH Perfect Match™.

\$20.11 each



C-Ring Glide **/BR**
CPC10 or CPC10/BR

\$1.91 NET pack (10 pieces)

See pages 80 & 82 for Master Carrier options.

Pinch Pleat Carriers

Ripplefold Carriers

Heavy Duty Butt Master Carriers

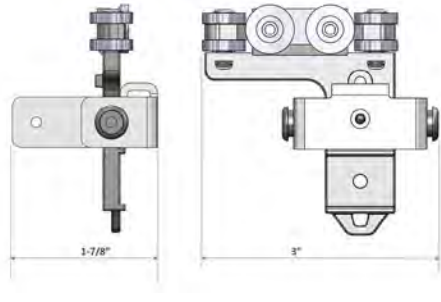
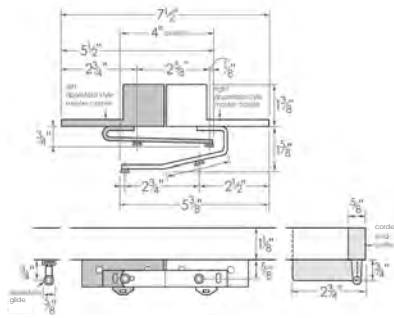
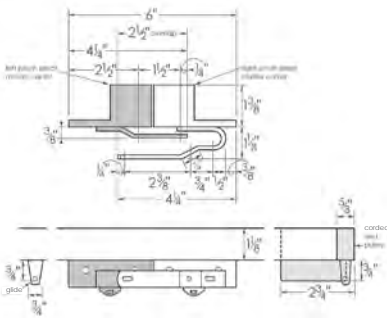

Drapery Return Bracket
CP500

9/16" H x 1/2" W backplate, 1 3/4" return
Allows for return on track hardware in traverse systems; included. Available in zinc only.

\$3.45 NET pack (10 pieces)



Glide Stop
BT4333

Stainless steel overlap arms with snaps to accept Ripplefold tape and a multi-wheel design for smooth movement. Available in white or bronze /BR and left or right.

\$0.58 NET each



Heavy Duty Traverse Order Form

PO # _____ Side Mark _____ Ship via _____ Date _____

Company Information		Shipping Information	
Company Name	Acct #	Company Name	Acct #
Contact Person		Contact Person	
Street Address		Street Address	
City	State	City	State
Email	ZIP	Email	ZIP
Phone	Fax	Phone	Fax

HEAVY-DUTY TRAVERSE SYSTEMS - Consult Price List for detailed specifications.
 Specified custom cut length includes pulleys or end caps. For mitered returns, see page 79.

Item #	Fascia Type	System Length (per 2')	Custom Cut Length (inches)	Fascia Finish Code	Bracket Preference	Draw Preference Center	Draw Preference One-Way	Cord Location	Cord Length (standard 120')	Baton Draw Option*	Glides Pinch Pleat or Ripplefold*	Qty	Price per Unit	Subtotal
						<input type="checkbox"/> L <input type="checkbox"/> R	<input type="checkbox"/> L <input type="checkbox"/> R	<input type="checkbox"/> L <input type="checkbox"/> R			<input type="checkbox"/> PP <input type="checkbox"/> RF			
						<input type="checkbox"/> L <input type="checkbox"/> R	<input type="checkbox"/> L <input type="checkbox"/> R	<input type="checkbox"/> L <input type="checkbox"/> R			<input type="checkbox"/> PP <input type="checkbox"/> RF			
						<input type="checkbox"/> L <input type="checkbox"/> R	<input type="checkbox"/> L <input type="checkbox"/> R	<input type="checkbox"/> L <input type="checkbox"/> R			<input type="checkbox"/> PP <input type="checkbox"/> RF			
						<input type="checkbox"/> L <input type="checkbox"/> R	<input type="checkbox"/> L <input type="checkbox"/> R	<input type="checkbox"/> L <input type="checkbox"/> R			<input type="checkbox"/> PP <input type="checkbox"/> RF			

HEAVY-DUTY TRAVERSE COORDINATING ACCESSORIES AND ADDITIONAL FEES
 Order finals, mitered returns, and accessories here.

Item #	Finish Code	Description	Qty	Price per Unit	Subtotal

Additional Information

Quantity included per system based on cut track length: 4' 6' 8' 10' 12' 14' 16' 18' 20'

Pinch Pleat Glides [4 per foot, includes master carriers (2) & end caps (2)]	16	24	32	40	48	56	64	72	80
Brackets (1 per every 3-4 feet)	2	3	4	4	5	6	6	7	8

TOTAL

* Baton draw option available; batons sold separately.

Special Instructions

* When ordering Ripplefold carriers, answer these questions:

1. Select Ripplefold fullness: 60% 80% 100% 120%

2. Select Ripplefold masters: Overlap Butt Master



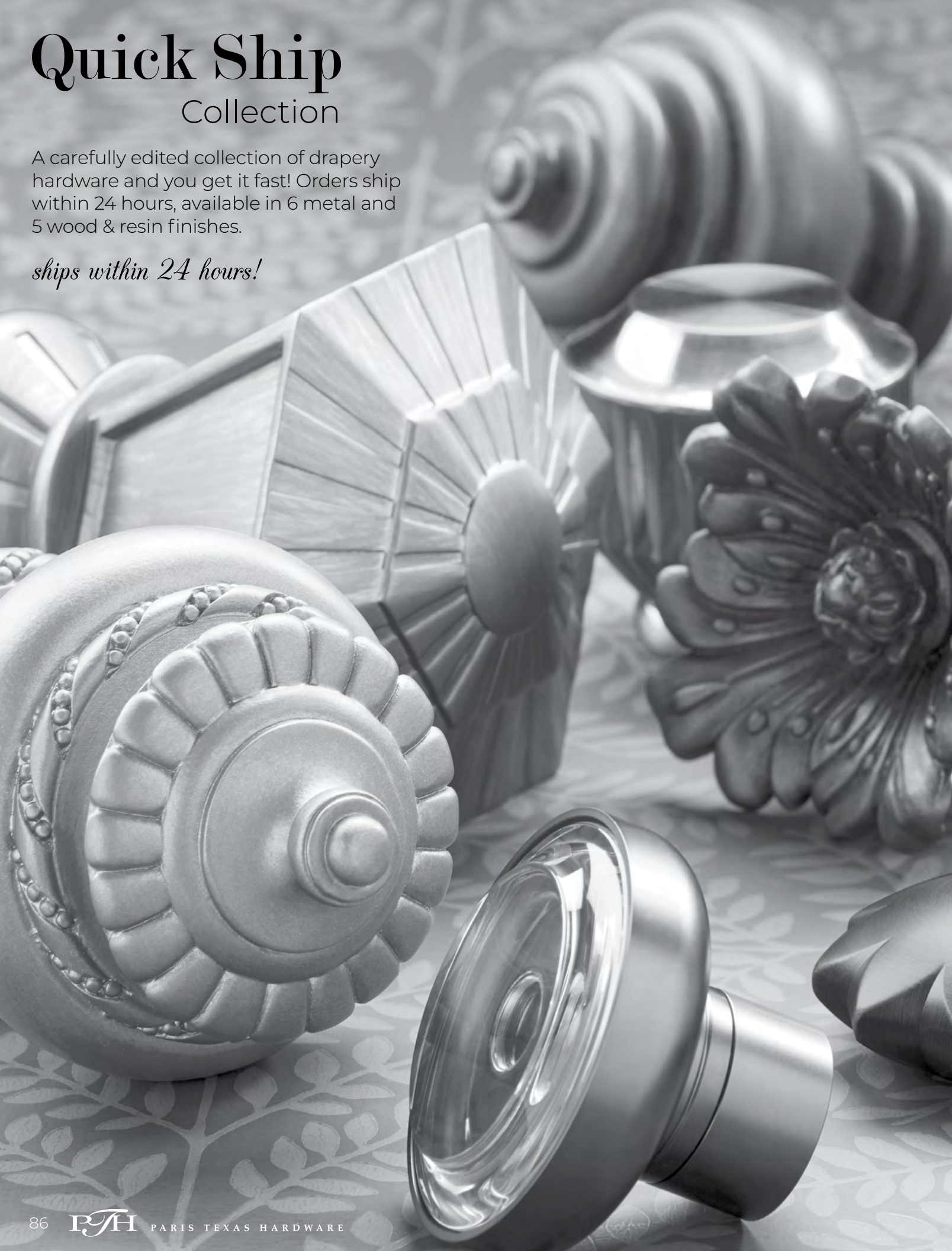

Quick Ship Collection

A carefully edited collection of drapery hardware and you get it fast! Orders ship within 24 hours, available in 6 metal and 5 wood & resin finishes.

ships within 24 hours!



1 1/8" Modern Finial Collection fits 1 1/8" poles. Finial adapters are required to adapt to 1 1/8" metal traverse, sold separately on page 89.

 <p>QS118COFI Cole 3 3/4" L x 1 1/2" W Metal \$93.28 pair*</p>	 <p>QS118ELAFI Ella 1 5/8" L x 1 5/8" W Metal \$81.62 pair*</p>	 <p>QS118EMFI Elm 1 3/8" L x 2" W Metal \$81.62 pair*</p>	 <p>QS118EMFIGL Elm - Smoke Glass 1 1/8" L x 2" W Metal / Glass \$93.28 pair*</p>	 <p>QS118EMEC Emery End Cap 3/4" L x 1 1/4" W Metal \$34.98 pair*</p>
-----------------------------------------------------------------------------------------------------------------------------------------------------------------	------------------------------------------------------------------------------------------------------------------------------------------------------------------	------------------------------------------------------------------------------------------------------------------------------------------------------------	-------------------------------------------------------------------------------------------------------------------------------------------------------------------------------------	--------------------------------------------------------------------------------------------------------------------------------------------------------------------------

 <p>QS118EVEC Evan End Cap 3/4" L x 1 3/4" W Metal \$34.98 pair*</p>	 <p>QS118KNFI Knox - Crystal 1 1/4" L x 2 5/8" W Crystal, Metal Pole \$145.75 pair*</p>	 <p>QS118LXFI Lex 1 7/8" L x 2" W Metal \$81.62 pair*</p>	 <p>QS118LOFI London - Crystal 1 7/8" L x 3" W Metal / Crystal \$169.07 pair*</p>	 <p>QS118REFI Reese - Crystal 2 3/4" L x 2 1/2" W Crystal, Metal Pole \$145.75 pair*</p>
-----------------------------------------------------------------------------------------------------------------------------------------------------------------------	------------------------------------------------------------------------------------------------------------------------------------------------------------------------------------------	------------------------------------------------------------------------------------------------------------------------------------------------------------	-------------------------------------------------------------------------------------------------------------------------------------------------------------------------------------	---------------------------------------------------------------------------------------------------------------------------------------------------------------------------------------------

 <p>QS118RYFI Ryder - Crystal 1 3/4" L x 1 3/4" W Metal / Crystal \$145.75 pair*</p>

Style Meets Function

1 1/8" Finials require a cuff / finial adapter to work with 1 1/8" Metal Traverse. See pages 63 - 67.



*Sold in pairs only.

1 1/8" Clean Deco Finial Collection fits 1 1/8" poles. Finial adapters are required to adapt to 1 1/8" metal traverse, sold separately on next page.

 <p>QS118ANFI</p> <p>Andes</p> <p>2 3/2" L x 2 5/8" W Metal</p> <p>\$104.94 pair*</p>	 <p>QS118DAFI</p> <p>Dakota - Crystal</p> <p>2 3/4" L x 2 1/2" W Metal / Crystal</p> <p>\$169.07 pair*</p>	 <p>QS118DEEC</p> <p>Deco End Cap</p> <p>3/4" L x 1 3/8" W Metal</p> <p>\$34.98 pair*</p>	 <p>QS118NVFI</p> <p>Neve - Crystal</p> <p>2 1/2" L x 2" W Metal / Crystal</p> <p>\$169.07 pair*</p>	 <p>QS118PEFI</p> <p>Penelope</p> <p>1 1/8" L x 2 3/4" W Metal</p> <p>\$93.28 pair*</p>
---------------------------------------------------------------------------------------------------------------------------------------------------------------------------	-------------------------------------------------------------------------------------------------------------------------------------------------------------------------------------------------	--------------------------------------------------------------------------------------------------------------------------------------------------------------------------------	--------------------------------------------------------------------------------------------------------------------------------------------------------------------------------------------	--------------------------------------------------------------------------------------------------------------------------------------------------------------------------------

 <p>QS118VIFI</p> <p>Viktor</p> <p>1 1/2" L x 2 3/4" W Metal / Acrylic</p> <p>\$93.28 pair*</p>	 <p>QS118WRFI</p> <p>Wren</p> <p>2" L x 1 7/8" W Metal</p> <p>\$93.28 pair*</p>	 <p>QS118WIFI</p> <p>Wright - Crystal</p> <p>2 1/2" L x 2 3/4" W Metal / Crystal</p> <p>\$169.07 pair*</p>	 <p>QS118ZAEC</p> <p>Zane End Cap</p> <p>5/8" L x 2 3/8" W Metal</p> <p>\$46.64 pair*</p>
-------------------------------------------------------------------------------------------------------------------------------------------------------------------------------------	----------------------------------------------------------------------------------------------------------------------------------------------------------------------	-------------------------------------------------------------------------------------------------------------------------------------------------------------------------------------------------	---------------------------------------------------------------------------------------------------------------------------------------------------------------------------------

1 1/8" Transitional Luxe Finial Collection fits 1 1/8" poles. Finial adapters are required to adapt to 1 1/8" metal traverse, sold separately on next page.

 <p>QS118NOFI</p> <p>Nora</p> <p>2 3/8" L x 2 3/8" W Metal</p> <p>\$93.28 pair*</p>	 <p>QS118NOFIGL</p> <p>Nora - Mercury Glass</p> <p>2 1/8" L x 2 3/8" W Metal / Glass</p> <p>\$145.75 pair*</p>
---------------------------------------------------------------------------------------------------------------------------------------------------------------------------	-------------------------------------------------------------------------------------------------------------------------------------------------------------------------------------------------------

1 1/8" Mix & Match create an even more *customized* design!

 <p>QS118CUFF Transitional Cuff / Finial Adapter 3/4" L x 1 3/4" W Metal</p> <p>\$34.98 pair*</p>	 <p>QS118DECUFF Deco Cuff / Finial Adapter 3/4" L x 1 3/8" W Metal</p> <p>\$34.98 pair*</p>	 <p>QS118CRMEBAND Crystal Band 3/4" L x 1 1/4" W Dark Metal with Inlaid Crystals</p> <p>\$39.64 each</p>
------------------------------------------------------------------------------------------------------------------------------------------------------------------------------------------------	------------------------------------------------------------------------------------------------------------------------------------------------------------------------------------------	---------------------------------------------------------------------------------------------------------------------------------------------------------------------------------------------------------

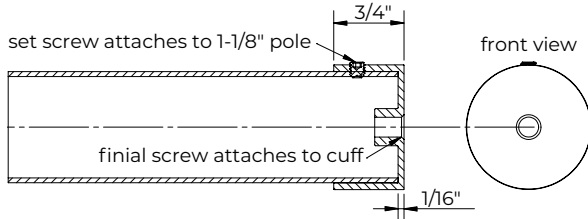

Transitional and Deco Cuffs / Finial Adapters

Style Meets Function

1 1/8" Baton Draw Metal Traverse Systems include End Caps, but are designed to work with all 1 1/8" Finials across five style categories using either Cuff / Finial Adapter. See pages 63 - 67.

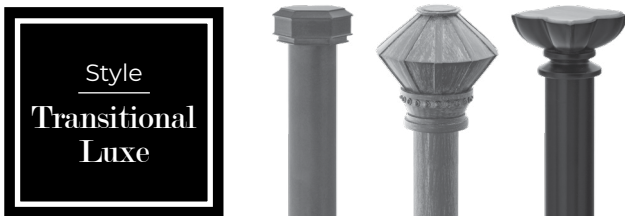

How To Add Your Cuff / Finial Adapter »

- 1** Select your Cuff style and finish - Mix & Match for the ultimate customization.

- 2** Place Cuff onto metal pole and tighten set screw with Allen Wrench.





- 3** Install finials by screwing into the Cuff / Finial Adapter.







*Sold in pairs only.

1 1/8" Modern Metal Brackets fit the 1 1/8" pole.

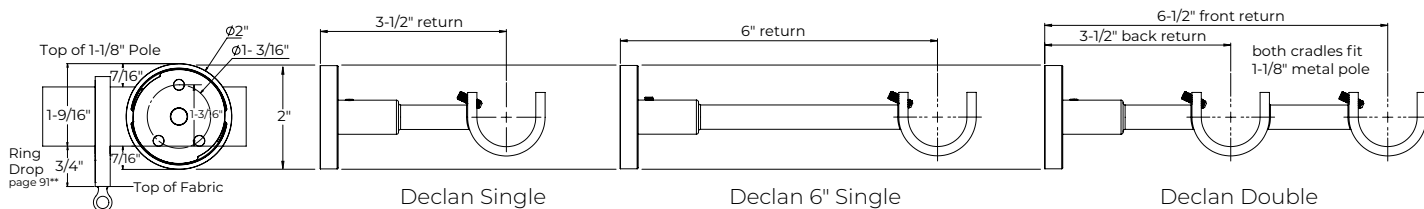
Note: Return indicates distance from wall to center of pole.



 <p>QS118DESBK Declan Single</p> <p>2" DIA backplate, 3 1/2" return</p> <p>\$52.47 each</p>	 <p>QS118DES6BK Declan 6" Single</p> <p>2" DIA backplate, 6" return</p> <p>\$58.30 each</p>	 <p>QS118DEDBK Declan Double</p> <p>2" DIA backplate, 6 1/2" front return and 3 1/2" back return</p> <p>\$64.13 each</p>
----------------------------------------------------------------------------------------------------------------------------------------------------------------------------------	----------------------------------------------------------------------------------------------------------------------------------------------------------------------------------	-----------------------------------------------------------------------------------------------------------------------------------------------------------------------------------------------------------------

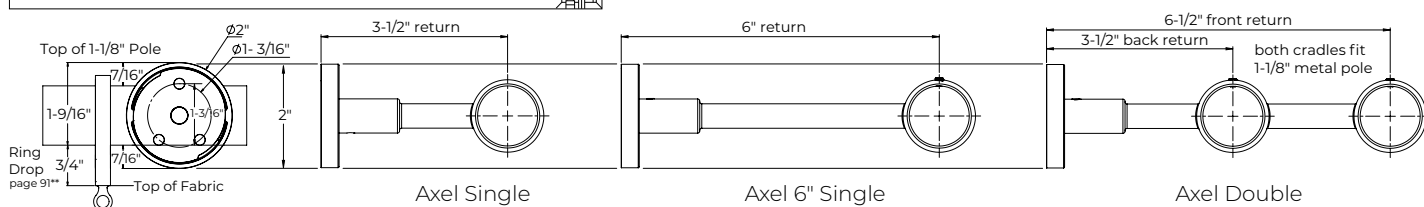

 <p>QS118AXSBK Axel Single</p> <p>2" DIA backplate, 3 1/2" return</p> <p>\$52.47 each</p>	 <p>QS118AXS6BK Axel 6" Single</p> <p>2" DIA backplate, 6" return</p> <p>\$58.30 each</p>	 <p>QS118AXDBK Axel Double</p> <p>2" DIA backplate, 6 1/2" front return and 3 1/2" back return</p> <p>\$64.13 each</p>
--------------------------------------------------------------------------------------------------------------------------------------------------------------------------------	--------------------------------------------------------------------------------------------------------------------------------------------------------------------------------	---------------------------------------------------------------------------------------------------------------------------------------------------------------------------------------------------------------

Designer Expertise » Use Axel Brackets for ceiling mount!



<p>Bypass Support Brackets Use with Caden C-Ring.</p> <p>*CAUTION: Aiden Brackets do not have full cradles. Self-threading screw installs through bottom of cradle and into 1 1/8" pole to secure it.</p> <p>Declan Brackets must be installed at each end to secure 1 1/8" pole.</p>	 <p>QS118AESBK Aiden Single</p> <p>2" DIA backplate, 3 1/2" return, use with Caden C-Rings</p> <p>\$52.47 each</p>	 <p>QS118AEDBK Aiden Double</p> <p>2" DIA backplate, 6 1/2" front return and 3 1/2" back return, 9/16" clearance above backplate, use with Caden C-Rings</p> <p>\$64.13 each</p>	 <p>QS118IMBK Inside Mount</p> <p>1 13/16" DIA backplate x 1 1/4" D, 3/16" thick backplate per bracket</p> <p>\$64.13 pair*</p>
-------------------------------------------------------------------------------------------------------------------------------------------------------------------------------------------------------------------------------------------------------------------------------------------	-----------------------------------------------------------------------------------------------------------------------------------------------------------------------------------------------------------	-------------------------------------------------------------------------------------------------------------------------------------------------------------------------------------------------------------------------------------------------------------------------	--------------------------------------------------------------------------------------------------------------------------------------------------------------------------------------------------------------------------

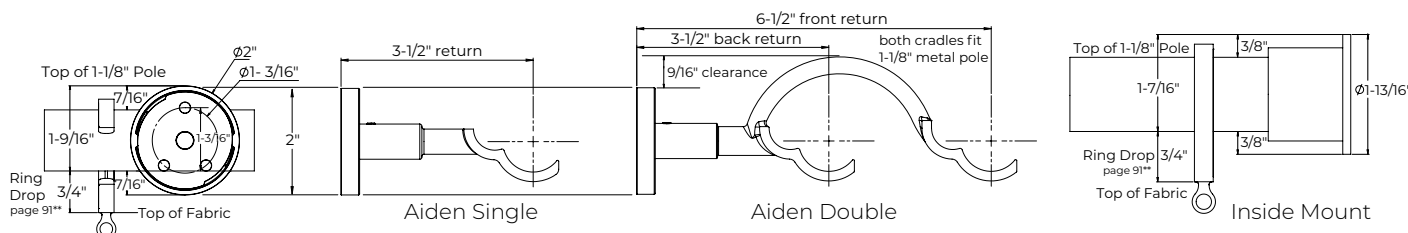

1 1/8" Metal Pole

1 1/8" metal poles are sold in 2' increments. 2' minimum. Poles will be cut to specified lengths; fall off will not be saved or shipped. Maximum continuous length up to 12' on BN, SG, CZ and MK finishes; up to 8' on RGD and BZ finishes. 1 1/8" metal poles are supplied with plastic inserts to attach the finials.

Note: All orders with poles and/or traverse track will incur a \$10.00 packaging fee per order.

QS118ME02	QS118ME04	QS118ME06	QS118ME08	QS118ME10	QS118ME12
2'	4'	6'	8'	10'	12'
\$29.15 each	\$58.30 each	\$87.45 each	\$116.60 each	\$145.75 each	\$174.90 each

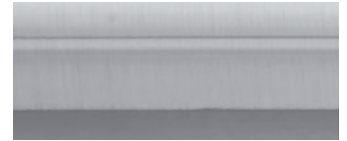



1 1/8" Metal Rings fit the 1 1/8" pole.

Note: Ring drop indicates distance from bottom of pole to bottom of ring. A ring's drop changes on different diameter poles.**

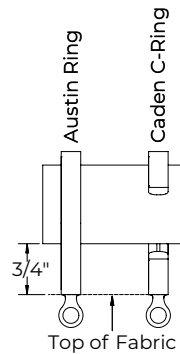

	
QS118AURI Austin Ring 1 1/4" ID, 1 5/8" OD, 3/4" drop Metal	QS118CACRI Caden C-Ring 1 1/4" ID, 1 5/8" OD, 3/4" drop, use with Aiden brackets Metal
\$7.00 each	\$7.00 each



1 1/8" Metal Accessories

	
Metal Baton 3/8" DIA, Metal	Clear Acrylic Baton 1/2" DIA, Acrylic
QSME36WAND - 36" - \$58.30 each	AC36WAND - 36" - \$52.47 each
QSME48WAND - 48" - \$64.13 each	AC48WAND - 48" - \$58.30 each
QSME60WAND - 60" - \$69.96 each	AC60WAND - 60" - \$64.13 each

QS118MEL Hinged Elbow 1 1/8" DIA, 2 7/8" overall length, 1 3/4" L each side when bent Metal
\$46.64 each

	
Handicap Metal Baton 4" Loop, ADA Compliant, Metal Finishes Available: BN, BZ & MK	Handicap Clear Acrylic Baton 4" Loop, ADA Compliant, Acrylic
QSME48HWAND - 48" - \$64.13 each	AC48HWAND - 48" - \$58.30 each
QSME60HWAND - 60" - \$69.96 each	AC60HWAND - 60" - \$64.13 each
	AC72HWAND - 72" - \$69.96 each

PSMET118403 Pole Splice 4 5/8" L, must be ordered separately
\$5.83 each

Modern Holdback Medallions fit modern holdback stems only.

 <p>QSHAHB Hadley 3 1/2" DIA, 1" TH Metal \$69.96 pair*</p>	 <p>QSPAHB Parker 3 1/4" square, 1" TH Metal \$69.96 pair*</p>
--------------------------------------------------------------------------------------------------------------------------------------------------------------	-----------------------------------------------------------------------------------------------------------------------------------------------------------------

Modern Holdback Stems must order separately. Projection indicates distance from wall to back of medallion.

 <p>QSMHBSTEM2 2" PROJ Base: 2 3/16" DIA Stem: 1/2" DIA Metal \$46.64 pair*</p>	 <p>QSMHBSTEM4 4" PROJ Base: 2 3/16" DIA Stem: 1/2" DIA Metal \$52.47 pair*</p>	 <p>QSMHBSTEM6 6" PROJ Base: 2 3/16" DIA Stem: 1/2" DIA Metal \$58.30 pair*</p>
-------------------------------------------------------------------------------------------------------------------------------------------------------------------------------------	--------------------------------------------------------------------------------------------------------------------------------------------------------------------------------------	--------------------------------------------------------------------------------------------------------------------------------------------------------------------------------------

**« Don't forget to
order your
Holdback Stems
separately**

1 3/8" Modern Finial Collection fits the 1 3/8" metal pole and metal traverse.

 <p>QSI38ADFI</p> <p>Adair</p> <p>3 3/8" L x 3" W Metal</p> <p>\$93.28 pair*</p>	 <p>QSI38AIEC</p> <p>Ainsley End Cap</p> <p>3/4" L x 1 1/2" W Metal</p> <p>\$40.81 pair*</p>	 <p>QSI38ASEC</p> <p>Asher End Cap</p> <p>1" L x 2 1/4" W Metal</p> <p>\$40.81 pair*</p>	 <p>QSI38COFI</p> <p>Cohen</p> <p>1 7/8" L x 3 3/8" W Metal / Clear Acrylic</p> <p>\$192.39 pair*</p>	 <p>QSI38EXFI</p> <p>Exton</p> <p>2 3/4" L x 2 1/4" W Metal</p> <p>\$93.28 pair*</p>
 <p>QSI38LOFI</p> <p>London - Crystal</p> <p>2 5/8" L x 3 3/8" W Metal / Crystal</p> <p>\$204.05 pair*</p>	 <p>QSI38QUFI</p> <p>Quinn</p> <p>1 3/4" L x 2 1/4" W Metal</p> <p>\$93.28 pair*</p>	 <p>QSI38REFI</p> <p>Remi - Crystal</p> <p>3 1/4" L x 3" W Metal / Crystal</p> <p>\$180.73 pair*</p>	 <p>QSI38STFI</p> <p>Sterling - Crystal</p> <p>2 1/4" L x 3" W Metal / Crystal</p> <p>\$180.73 pair*</p>	 <p>QSI38ZAFI</p> <p>Zara</p> <p>2 1/2" L x 3 1/2" W Metal / Clear Acrylic</p> <p>\$204.05 pair*</p>

Style Meets Function

1 3/8" Finials work with 1 3/8" Metal Traverse, including R-TEC Automation® Traverse Systems. See pages 32 - 41 and 68 - 73.



Adair Finial on **RTEC** AUTOMATION®

1 3/8" Modern Metal Brackets fit the 1 3/8" pole.

Note: Return indicates distance from wall to center of pole.

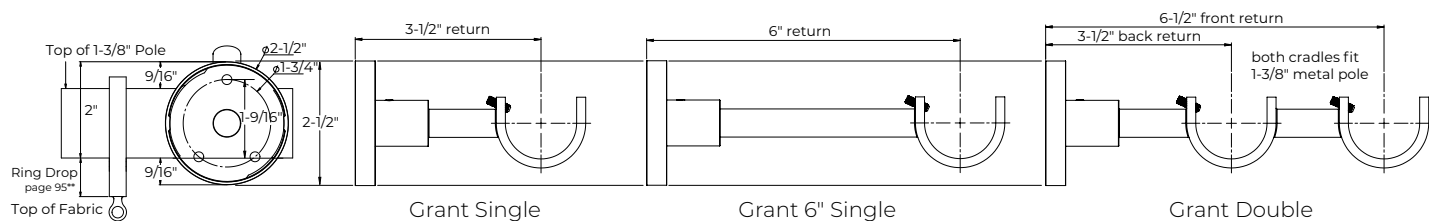

 <p>QSI38GASBK Grant Single</p> <p>2 1/2" DIA backplate, 3 1/2" return</p> <p>\$58.30 each</p>	 <p>QSI38GAS6BK Grant 6" Single</p> <p>2 1/2" DIA backplate, 6" return</p> <p>\$64.13 each</p>	 <p>QSI38GADBK Grant Double</p> <p>2 1/2" DIA backplate, 6 1/2" front return and 3 1/2" back return</p> <p>\$69.96 each</p>
--------------------------------------------------------------------------------------------------------------------------------------------------------------------------------------------	--------------------------------------------------------------------------------------------------------------------------------------------------------------------------------------------	---------------------------------------------------------------------------------------------------------------------------------------------------------------------------------------------------------------------------

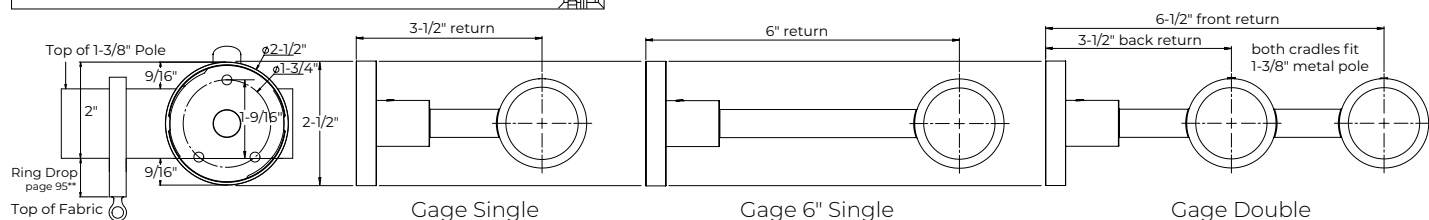

 <p>QSI38GGSBK Gage Single</p> <p>2 1/2" DIA backplate, 3 1/2" return</p> <p>\$58.30 each</p>	 <p>QSI38GGS6BK Gage 6" Single</p> <p>2 1/2" DIA backplate, 6" return</p> <p>\$64.13 each</p>	 <p>QSI38GGDBK Gage Double</p> <p>2 1/2" DIA backplate, 6 1/2" front return and 3 1/2" back return</p> <p>\$69.96 each</p>
-------------------------------------------------------------------------------------------------------------------------------------------------------------------------------------------	-------------------------------------------------------------------------------------------------------------------------------------------------------------------------------------------	--------------------------------------------------------------------------------------------------------------------------------------------------------------------------------------------------------------------------

Designer Expertise » Use Gage Brackets for ceiling mount!



<p>Bypass Support Brackets Use with Calla C-Ring.</p> <p>*CAUTION: Talon Brackets do not have full cradles. Self-threading screw installs through bottom of cradle and into 1 3/8" pole to secure it.</p> <p>Grant Brackets must be installed at each end to secure 1 3/8" pole.</p>	 <p>QSI38TASBK Talon Single</p> <p>2 1/2" DIA backplate, 3 1/2" return, use with Calla C-Rings</p> <p>\$58.30 each</p>	 <p>QSI38TADBK Talon Double</p> <p>2 1/2" DIA backplate, 6 1/2" front return and 3 1/2" back return, 3/8" clearance above backplate, use with Calla C-Rings</p> <p>\$69.96 each</p>	 <p>QSI381MBK Inside Mount</p> <p>2" DIA backplate, 1 9/16" D, 1/4" thick backplate per bracket</p> <p>\$69.96 pair*</p>
------------------------------------------------------------------------------------------------------------------------------------------------------------------------------------------------------------------------------------------------------------------------------------------	----------------------------------------------------------------------------------------------------------------------------------------------------------------------------------------------------------------------	-----------------------------------------------------------------------------------------------------------------------------------------------------------------------------------------------------------------------------------------------------------------------------------	--------------------------------------------------------------------------------------------------------------------------------------------------------------------------------------------------------------------------

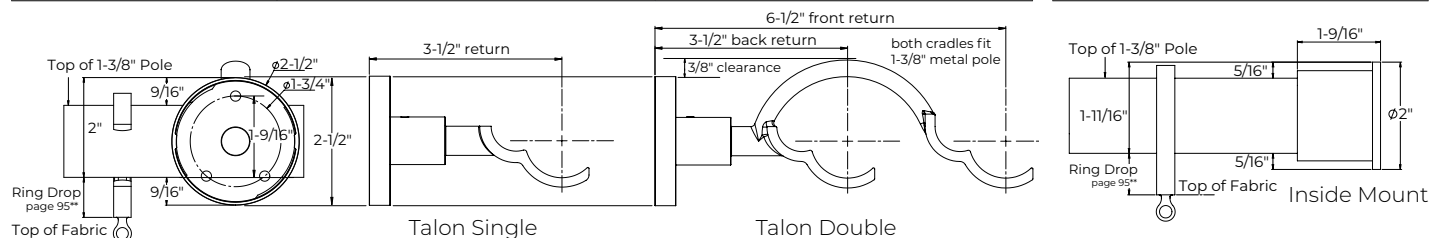

1 3/8" Metal Pole | 1 3/8" Acrylic Pole

1 3/8" metal poles are sold in 2' increments. 2' minimum. Poles will be cut to specified lengths; fall off will not be saved or shipped. Maximum continuous length up to 12' on BN, SG, CZ and MK finishes; up to 8' on RGD and BZ finishes. 1 3/8" metal poles are supplied with plastic inserts to attach wood & resin finials, if desired. Acrylic poles only work with the 1 3/8" Modern Finial Collection.

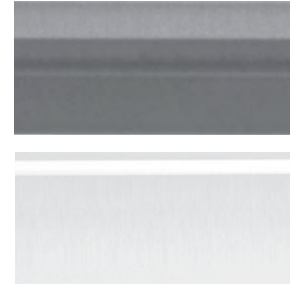

Note: All orders with poles and/or traverse track will incur a \$10.00 packaging fee per order.

QSI38ME02 2' \$34.98 each	QSI38ME04 4' \$69.96 each	QSI38ME06 6' \$104.94 each	QSI38ME08 8' \$139.92 each	QSI38ME10 10' \$174.90 each	QSI38ME12 12' \$209.88 each
QSI38AC02 2' \$89.78 each	QSI38AC04 4' \$179.56 each	QSI38AC06 6' \$269.35 each	QSI38AC08 8' \$359.13 each	QSI38AC10 10' \$448.91 each	QSI38AC12 12' \$538.69 each





1 3/8" Metal Rings fit the 1 3/8" pole.

Note: Ring drop indicates distance from bottom of pole to bottom of ring. A ring's drop changes on different diameter poles.**

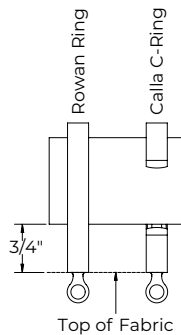
 QSI38RORI Rowan Ring 2" ID, 2 3/8" OD, 3/4" drop Metal \$8.16 each	 QSI38CLCRI Calla C-Ring 2" ID, 2 3/8" OD, 3/4" drop, use with Talon brackets Metal \$8.16 each
--------------------------------------------------------------------------------------------------------------------------------------------------------------------------------------	---------------------------------------------------------------------------------------------------------------------------------------------------------------------------------------------------------------------





1 3/8" Metal Accessories

 Metal Baton 3/8" DIA, Metal QSME36WAND - 36" - \$58.30 each QSME48WAND - 48" - \$64.13 each QSME60WAND - 60" - \$69.96 each	 Clear Acrylic Baton 1/2" DIA, Acrylic AC36WAND - 36" - \$52.47 each AC48WAND - 48" - \$58.30 each AC60WAND - 60" - \$64.13 each
---------------------------------------------------------------------------------------------------------------------------------------------------------------------------------------------------------------------------------------	-------------------------------------------------------------------------------------------------------------------------------------------------------------------------------------------------------------------------------------------



QSI38MEL
Hinged Elbow

1 3/8" DIA, 2 7/8" overall length, 2" L each side when bent
Metal
\$52.47 each

 Handicap Metal Baton 4" Loop, ADA Compliant, Metal QSME48HWAND - 48" - \$64.13 each QSME60HWAND - 60" - \$69.96 each	 Handicap Clear Acrylic Baton 4" Loop, ADA Compliant, Acrylic AC48HWAND - 48" - \$58.30 each AC60HWAND - 60" - \$64.13 each AC72HWAND - 72" - \$69.96 each
-----------------------------------------------------------------------------------------------------------------------------------------------------------------------------------------------------------------------------	---------------------------------------------------------------------------------------------------------------------------------------------------------------------------------------------------------------------------------------------------------------------



PSME138403
Pole Splice

4 3/4" L, must be ordered separately
\$8.16 each

Modern Holdback Medallions fit modern holdback stems only.





 <p>QSHAHB Hadley 3 1/2" DIA, 1" TH Metal \$69.96 pair*</p>	 <p>QSPAHB Parker 3 1/4" square, 1" TH Metal \$69.96 pair*</p>
--------------------------------------------------------------------------------------------------------------------------------------------------------------	-----------------------------------------------------------------------------------------------------------------------------------------------------------------

Modern Holdback Stems must order separately. Projection indicates distance from wall to back of medallion.

 <p>QSMHBSTEM2 2" PROJ Base: 2 3/16" DIA Stem: 1/2" DIA Metal \$46.64 pair*</p>	 <p>QSMHBSTEM4 4" PROJ Base: 2 3/16" DIA Stem: 1/2" DIA Metal \$52.47 pair*</p>	 <p>QSMHBSTEM6 6" PROJ Base: 2 3/16" DIA Stem: 1/2" DIA Metal \$58.30 pair*</p>
-------------------------------------------------------------------------------------------------------------------------------------------------------------------------------------	--------------------------------------------------------------------------------------------------------------------------------------------------------------------------------------	--------------------------------------------------------------------------------------------------------------------------------------------------------------------------------------



« Don't forget to order your Holdback Stems separately

1 3/8" Today's Traditional Finial Collection fits the 1 3/8" wood poles and heavy duty traverse.

 <p>QS138AU EC Aubrie End Cap 3/4" L x 2 1/4" W Resin \$46.64 pair*</p>	 <p>QS138BRFI Bradford 3 1/4" L x 2 1/4" W Resin \$81.62 pair*</p>	 <p>QS138EVFI Everette 2 7/8" L x 3 1/4" W [2 1/2" square] Resin \$81.62 pair*</p>	 <p>QS138JUFI June 2 3/4" L x 2 5/8" W Resin \$81.62 pair*</p>	 <p>QS138LEFI Leo 3 1/2" L x 2 3/4" W Resin \$81.62 pair*</p>
--------------------------------------------------------------------------------------------------------------------------------------------------------------------------	---------------------------------------------------------------------------------------------------------------------------------------------------------------------	-----------------------------------------------------------------------------------------------------------------------------------------------------------------------------------------	------------------------------------------------------------------------------------------------------------------------------------------------------------------	------------------------------------------------------------------------------------------------------------------------------------------------------------------

 <p>QS138LIFI Lillian 4" L x 3 3/8" W Resin \$81.62 pair*</p>	 <p>QS138LIFIGL Lillian - Mercury Glass 4" L x 3 3/8" W Resin / Glass \$157.41 pair*</p>	 <p>QS138LYFI Lyla 2 5/8" L x 2 3/4" W Resin \$81.62 pair*</p>	 <p>QS138ROFI Rose - Crystal 2 1/2" L x 2 3/4" W Resin / Crystal \$215.71 pair*</p>
----------------------------------------------------------------------------------------------------------------------------------------------------------------	-------------------------------------------------------------------------------------------------------------------------------------------------------------------------------------------	-----------------------------------------------------------------------------------------------------------------------------------------------------------------	---------------------------------------------------------------------------------------------------------------------------------------------------------------------------------------

1 3/8" Heritage Classics Finial Collection fits the 1 3/8" wood poles and heavy duty traverse.

 <p>QS138HAFI Harper 3" L x 2 3/4" W Resin \$81.62 pair*</p>	 <p>QS138LAFI Lane 3 5/8" L x 3 1/2" W Resin \$81.62 pair*</p>	 <p>QS138LOEC Lowell End Cap 1" L x 2" W Resin \$46.64 pair*</p>
-----------------------------------------------------------------------------------------------------------------------------------------------------------------	-------------------------------------------------------------------------------------------------------------------------------------------------------------------	---------------------------------------------------------------------------------------------------------------------------------------------------------------------

*Sold in pairs only.

1 3/8" Mix & Match create an even more customized design!

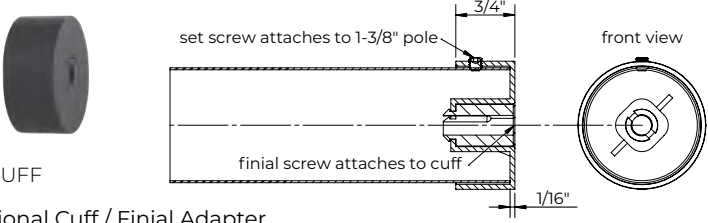

Q5138CUFF
Transitional Cuff / Finial Adapter
3/4" L x 1 1/2" W

- Metal, Available in any of our 5 Quick Ship Wood & Resin Finishes
- Use to adapt your 1 3/8" Today's Traditional or Heritage Classics Finial to work with Metal Traverse (required)

\$45.47 pair*

Style Meets Function

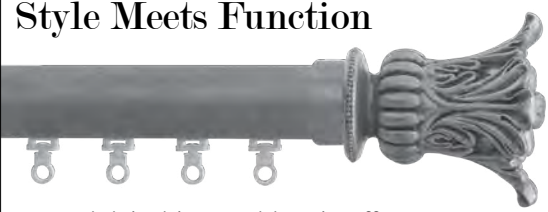

Lane Finial with Transitional Cuff

1 3/8" R-TEC and Baton Draw Metal Traverse Systems include End Caps, but are designed to work with all 1 3/8" Finials across three style categories. Today's Traditional and Heritage Classics Finials require the use of the Transitional Cuff / Finial Adapter to work with Metal Traverse. Modern Finials do not require the use of the Finial Adapter.

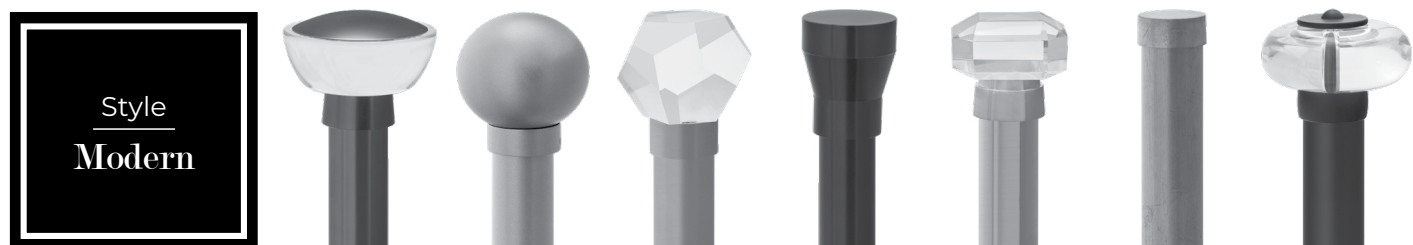

*Transitional Cuff / Finial Adapter Q5138CUFF not required with Metal Traverse Systems on pages 32 - 41 and 68 - 73



*Requires Transitional Cuff / Finial Adapter Q5138CUFF to work with Metal Traverse Systems on pages 32 - 41 and 68 - 73

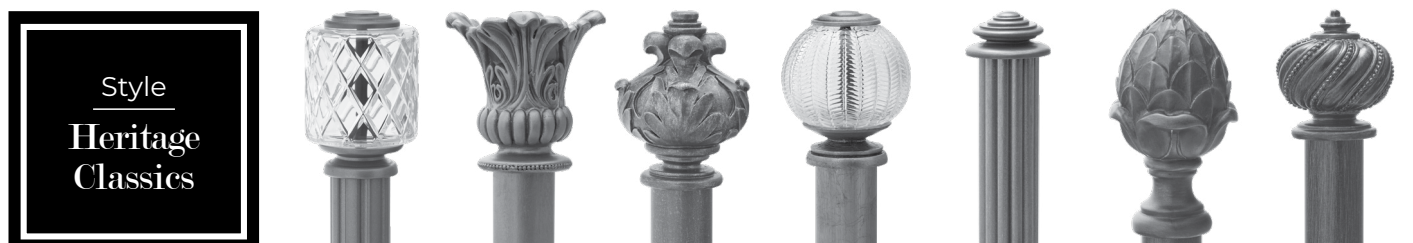

*Requires Transitional Cuff / Finial Adapter Q5138CUFF to work with Metal Traverse Systems on pages 32 - 41 and 68 - 73

How To Add Your Transitional Cuff / Finial Adapter »



1 Select your Cuff style and finish - Mix & Match for the ultimate customization.



2 Place Cuff onto metal traverse and tighten set screw with Allen Wrench.



3 Install finials by screwing into the Cuff / Finial Adapter.

1 3/8" Wood & Resin Brackets fit the 1 3/8" wood poles.

Note: Return indicates distance from wall to center of pole.

 <p>QS138WISBK William Single</p> <p>1" W x 3 3/4" H backplate, 3 7/16" return, Resin</p> <p style="text-align: center;">\$40.81 each</p>	 <p>QS138WIS6BK William 6 5/8" Single</p> <p>1" W x 3 7/16" H backplate, 6 5/8" return, Resin</p> <p style="text-align: center;">\$46.64 each</p>	 <p>QS138WIDBK William Double</p> <p>1" W x 3 7/16" H backplate, 6 1/2" front return and 3 1/4" back return, Resin</p> <p style="text-align: center;">\$46.64 each</p>
-----------------------------------------------------------------------------------------------------------------------------------------------------------------------------------------------------------------------------------------------------	-------------------------------------------------------------------------------------------------------------------------------------------------------------------------------------------------------------------------------------------------------------	------------------------------------------------------------------------------------------------------------------------------------------------------------------------------------------------------------------------------------------------------------------------------------

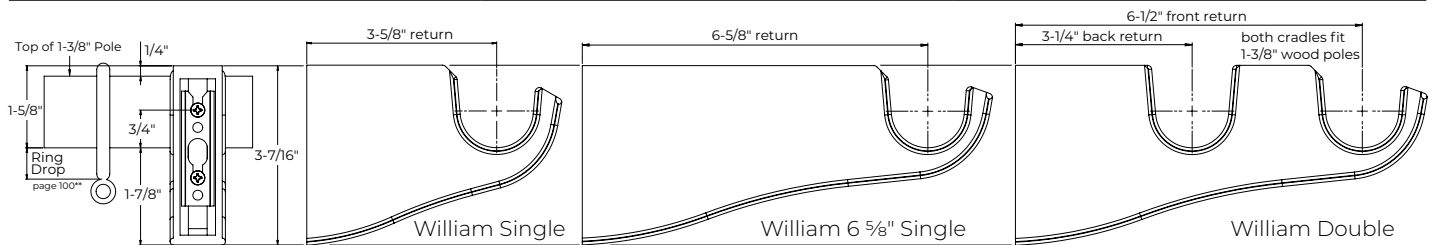



1 3/8" Metal Brackets fit the 1 3/8" wood poles.

Note: Return indicates distance from wall to center of pole.

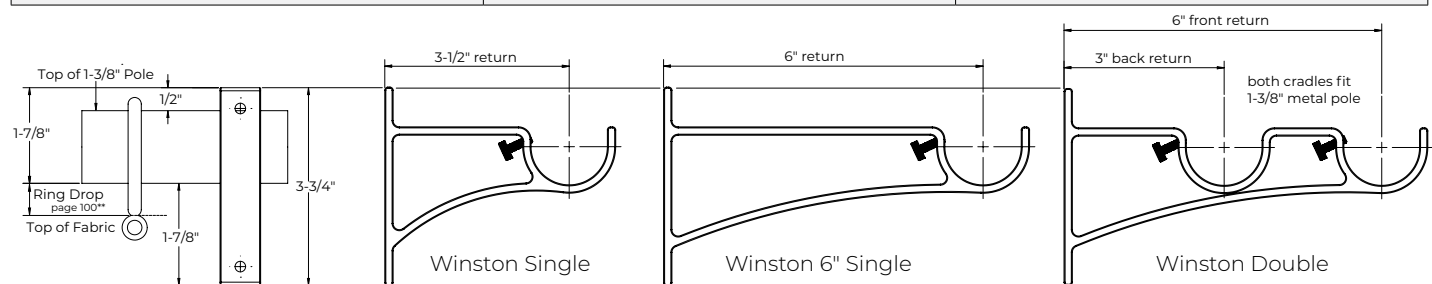
 <p>QS138WSSBK Winston Single</p> <p>3/4" W x 3 3/4" H backplate, 3 1/2" return</p> <p style="text-align: center;">\$46.64 each</p>	 <p>QS138WSS6BK Winston 6" Single</p> <p>3/4" W x 3 3/4" H backplate, 6" return</p> <p style="text-align: center;">\$52.47 each</p>	 <p>QS138WSDBK Winston Double</p> <p>3/4" W x 3 3/4" H backplate, 6" front return and 3" back return</p> <p style="text-align: center;">\$52.47 each</p>
------------------------------------------------------------------------------------------------------------------------------------------------------------------------------------------------------------------------------------------------	------------------------------------------------------------------------------------------------------------------------------------------------------------------------------------------------------------------------------------------------	-----------------------------------------------------------------------------------------------------------------------------------------------------------------------------------------------------------------------------------------------------------------------



 <p>QSBKT138 Adjustable Single Bracket</p> <p>1" W x 3 1/4" H backplate, adjustable 3 1/2" - 5" return</p> <p style="text-align: center;">\$52.47 each</p>	 <p>QS138MCMBK Ceiling Single</p> <p>2 3/4" H, 2" DIA backplate, 2 5/8" drop</p> <p style="text-align: center;">\$46.64 each</p>	 <p>QS138MIBK Inside Mount</p> <p>1" W x 1 1/4" H x 1 7/8" D, 1/4" thick backplate per bracket</p> <p style="text-align: center;">\$89.78 pair*</p>
------------------------------------------------------------------------------------------------------------------------------------------------------------------------------------------------------------------------------------------------------------------------	----------------------------------------------------------------------------------------------------------------------------------------------------------------------------------------------------------------------------------------------	-------------------------------------------------------------------------------------------------------------------------------------------------------------------------------------------------------------------------------------------------------------------

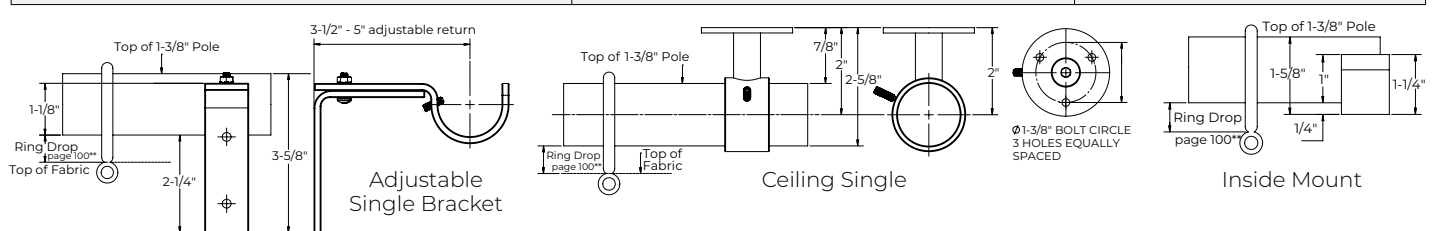

*Sold in pairs only.

1 3/8" Wood Poles

1 3/8" wood poles are sold in 2' increments. 2' minimum. Poles will be cut to specified lengths; fall off will not be saved or shipped. Maximum continuous length up to 12'.

Note: All orders with poles and/or traverse track will incur a \$10.00 packaging fee per order.

QS138SM02 Smooth - 2'	QS138SM04 Smooth - 4'	QS138SM06 Smooth - 6'	QS138SM08 Smooth - 8'	QS138SM10 Smooth - 10'	QS138SM12 Smooth - 12'
\$58.30 each	\$116.60 each	\$174.90 each	\$233.20 each	\$291.50 each	\$349.80 each

QS138GR02 Grooved / Fluted - 2'	QS138GR04 Grooved / Fluted - 4'	QS138GR06 Grooved / Fluted - 6'	QS138GR08 Grooved / Fluted - 8'	QS138GR10 Grooved / Fluted - 10'	QS138GR12 Grooved / Fluted - 12'
\$58.30 each	\$116.60 each	\$174.90 each	\$233.20 each	\$291.50 each	\$349.80 each

QS138RE02 Reeded - 2'	QS138RE04 Reeded - 4'	QS138RE06 Reeded - 6'	QS138RE08 Reeded - 8'	QS138RE10 Reeded - 10'	QS138RE12 Reeded - 12'
\$58.30 each	\$116.60 each	\$174.90 each	\$233.20 each	\$291.50 each	\$349.80 each

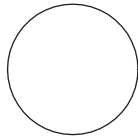

Smooth Wood Pole QS138SM
Wood

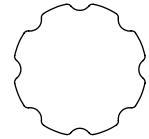

Grooved / Fluted Wood Pole QS138GR
Wood

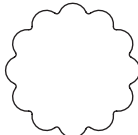

Reeded Wood Pole QS138RE
Wood

1 3/8" Wood & Metal Rings fit the 1 3/8" wood poles.

Note: Ring drop indicates distance from bottom of pole to bottom of ring. A ring's drop changes on different diameter poles.**

 QS138WRI Wood Ring 1/2" W, 1 3/4" ID, 2 5/8" OD, 3/4" drop Wood \$8.16 each	 QS138MRI Metal Ring 1 3/4" ID, 2 1/4" OD, 5/8" drop Metal \$7.58 each
---------------------------------------------------------------------------------------------------------------------------------------------------------------------------------------	---------------------------------------------------------------------------------------------------------------------------------------------------------------------------------

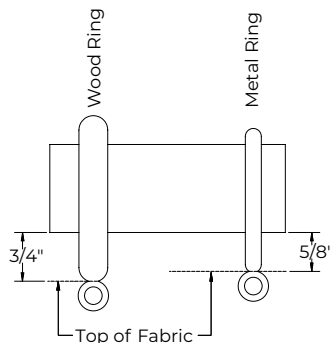

EZ Glide Tape

Included with pole order. Allows rings and grommets to slide effortlessly across the drapery rod without damaging the finish.



1 3/8" Accessories



Fiberglass Baton
3/8" DIA, Fiberglass

QSRE36WAND - 36" - \$67.63 each
QSRE48WAND - 48" - \$73.46 each
QSRE60WAND - 60" - \$79.29 each



Clear Acrylic Baton
1/2" DIA, Acrylic

AC36WAND - 36" - \$52.47 each
AC48WAND - 48" - \$58.30 each
AC60WAND - 60" - \$64.13 each



Handicap Clear Acrylic Baton
4" Loop, ADA Compliant, Acrylic

AC48HWAND - 48" - \$58.30 each
AC60HWAND - 60" - \$64.13 each
AC72HWAND - 72" - \$69.96 each









QSI38REL Hinged Elbow
1 5/8" DIA, 3 7/8" OL, 2" L each side when bent
Resin

\$46.64 each

Transitional Holdback Medallions

fit transitional holdback stems.

		
QSBRHB Brooks 4" DIA, 1 1/4" TH Resin	QSMIHB Miranda 5" DIA, 1 1/2" TH Resin	QSTRHB Trudy 4 3/4" DIA, 3/4" TH Resin
\$81.62 pair*	\$87.45 pair*	\$87.45 pair*

		
QSBKHB Blake - Mercury Glass 3" DIA, 2 3/8" TH Metal / Glass	QSHAHB Hadley 3 1/2" DIA, 1" TH Metal	QSPAHB Parker 3 1/4" DIA, 1" TH Metal
\$139.92 pair*	\$69.96 pair*	\$69.96 pair*

Don't forget to order your Holdback Stems separately ≡

Transitional Holdback Stems must order separately. Projection indicates distance from wall to back of medallion.

		
QSTHBSTEM2 2" PROJ Base: 3" DIA Stem: 5/8" DIA Metal	QSTHBSTEM4 4" PROJ Base: 3" DIA Stem: 5/8" DIA Metal	QSTHBSTEM6 6" PROJ Base: 3" DIA Stem: 5/8" DIA Metal
\$58.30 pair*	\$64.13 pair*	\$69.96 pair*



*Sold in pairs only.

2 1/4" Today's Traditional Finial Collection fits the 2 1/4" wood poles and heavy duty traverse.

 <p>QS214AMFI</p> <p>Amelie</p> <p>2" L x 3 1/4" W Resin</p> <p>\$104.94 pair*</p>	 <p>QS214APFI</p> <p>Aspen</p> <p>4 1/2" L x 4 1/2" W Resin</p> <p>\$110.77 pair*</p>	 <p>QS214EDFI</p> <p>Edward</p> <p>4 1/4" L x 3 1/4" W Resin</p> <p>\$104.94 pair*</p>	 <p>QS214HZFI</p> <p>Hazel - Crystal</p> <p>2 5/8" L x 3 3/8" W Resin / Crystal</p> <p>\$250.69 pair*</p>
-------------------------------------------------------------------------------------------------------------------------------------------------------------------------------	-----------------------------------------------------------------------------------------------------------------------------------------------------------------------------------	------------------------------------------------------------------------------------------------------------------------------------------------------------------------------------	--------------------------------------------------------------------------------------------------------------------------------------------------------------------------------------------------------

 <p>QS214SIFI</p> <p>Sidney</p> <p>3 3/8" L x 4 1/8" W [3" square] Resin</p> <p>\$104.94 pair*</p>	 <p>QS214STFI</p> <p>Stella</p> <p>2 1/2" L x 3 1/4" W Resin</p> <p>\$104.94 pair*</p>
---------------------------------------------------------------------------------------------------------------------------------------------------------------------------------------------------	------------------------------------------------------------------------------------------------------------------------------------------------------------------------------------

2 1/4" Heritage Classics Finial Collection fits the 2 1/4" wood poles and heavy duty traverse.

 <p>QS214ADFI</p> <p>Adelaide</p> <p>5" L x 3 1/2" W Resin</p> <p>\$110.77 pair*</p>	 <p>QS214ADFIGL</p> <p>Adelaide - Mercury Glass</p> <p>5" L x 3 1/2" W Resin / Glass</p> <p>\$180.73 pair*</p>	 <p>QS214FAFI</p> <p>Farrin - Mercury Glass</p> <p>4 1/2" L x 4 7/8" W Metal / Glass</p> <p>\$180.73 pair*</p>	 <p>QS214FIFI</p> <p>Fiona</p> <p>4" L x 5" W Resin</p> <p>\$145.75 pair*</p>
-----------------------------------------------------------------------------------------------------------------------------------------------------------------------------------	--------------------------------------------------------------------------------------------------------------------------------------------------------------------------------------------------------------	--------------------------------------------------------------------------------------------------------------------------------------------------------------------------------------------------------------	------------------------------------------------------------------------------------------------------------------------------------------------------------------------------

 <p>QS214MAEC</p> <p>Margot End Cap</p> <p>3/4" L x 3" W Resin</p> <p>\$58.30 pair*</p>	 <p>QS214OLFI</p> <p>Oliver</p> <p>3 5/8" L x 3 7/8" W Resin</p> <p>\$110.77 pair*</p>
--------------------------------------------------------------------------------------------------------------------------------------------------------------------------------------	--------------------------------------------------------------------------------------------------------------------------------------------------------------------------------------

2 1/4" Wood & Resin Brackets fit the 2 1/4" wood poles.

Note: Return indicates distance from wall to center of pole.

 <p>QS214WISBK William Single</p> <p>1" W x 3 3/4" H backplate, 4" return, Resin</p> <p style="text-align: center;">\$46.64 each</p>	 <p>QS214WIS6BK William 7" Single</p> <p>1" W x 3 3/4" H backplate, 7" return, Resin</p> <p style="text-align: center;">\$52.47 each</p>	 <p>QS214WIDBK William Double</p> <p>1" W x 3 3/4" H backplate, 6 3/4" front return, 3 3/4" back return, front cradle holds 2 1/4" DIA pole; back cradle holds 1 3/8" DIA pole, Resin</p> <p style="text-align: center;">\$52.47 each</p>
------------------------------------------------------------------------------------------------------------------------------------------------------------------------------------------------------------------------------------------------	--------------------------------------------------------------------------------------------------------------------------------------------------------------------------------------------------------------------------------------------------------------------------	-------------------------------------------------------------------------------------------------------------------------------------------------------------------------------------------------------------------------------------------------------------------------------------------------------------------------------------------------------

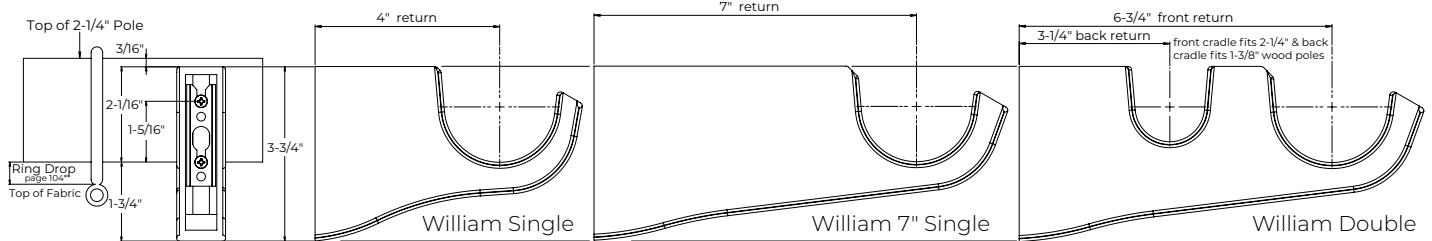



2 1/4" Metal Brackets fit the 2 1/4" wood poles.

Note: Return indicates distance from wall to center of pole.

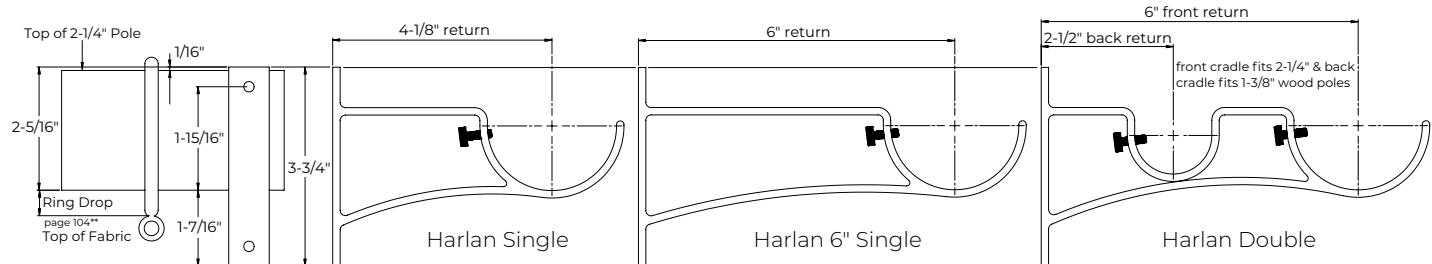
 <p>QS214HASBK Harlan Single</p> <p>3 3/4" H x 3/4" W backplate, 4 1/8" return</p> <p style="text-align: center;">\$52.47 each</p>	 <p>QS214HAS6BK Harlan 6" Single</p> <p>3 3/4" H x 3/4" W backplate, 6" return</p> <p style="text-align: center;">\$58.30 each</p>	 <p>QS214HADBK Harlan Double</p> <p>3 3/4" H x 3/4" W backplate, 6" front return, 2 1/2" back return, front cradle holds 2 1/4" DIA pole; back cradle holds 1 3/8" DIA pole</p> <p style="text-align: center;">\$58.30 each</p>
-----------------------------------------------------------------------------------------------------------------------------------------------------------------------------------------------------------------------------------------------	---------------------------------------------------------------------------------------------------------------------------------------------------------------------------------------------------------------------------------------------------------------------	----------------------------------------------------------------------------------------------------------------------------------------------------------------------------------------------------------------------------------------------------------------------------------------------------------------------------------------------



 <p>QS214MCMBK Ceiling Single</p> <p>3 3/4" H x 3 1/4" D, 3 1/2" drop</p> <p style="text-align: center;">\$52.47 each</p>	 <p>QS214MIBK Inside Mount</p> <p>1" W x 1 5/8" H x 2 7/8" D, 1/4" thick backplate per bracket</p> <p style="text-align: center;">\$93.28 pair*</p>
---------------------------------------------------------------------------------------------------------------------------------------------------------------------------------------------------------------------------------------	-------------------------------------------------------------------------------------------------------------------------------------------------------------------------------------------------------------------------------------------------------------------

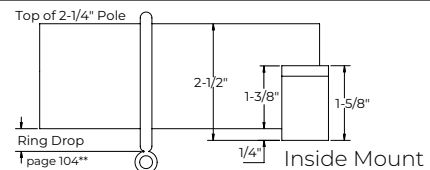
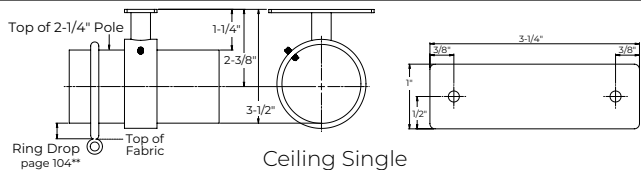

*Sold in pairs only.

2 1/4" Wood Poles

2 1/4" wood poles are sold in 2' increments. 2' minimum. Poles will be cut to specified lengths; fall off will not be saved or shipped. Maximum continuous length up to 12'.

Note: All orders with poles and/or traverse track will incur a \$10.00 packaging fee per order.

QS214SM02 Smooth - 2' \$81.62 each	QS214SM04 Smooth - 4' \$163.24 each	QS214SM06 Smooth - 6' \$244.86 each	QS214SM08 Smooth - 8' \$326.48 each	QS214SM10 Smooth - 10' \$408.10 each	QS214SM12 Smooth - 12' \$489.72 each
------------------------------------------	-------------------------------------------	-------------------------------------------	-------------------------------------------	--------------------------------------------	--------------------------------------------

QS214GR02 Grooved / Fluted - 2' \$81.62 each	QS214GR04 Grooved / Fluted - 4' \$163.24 each	QS214GR06 Grooved / Fluted - 6' \$244.86 each	QS214GR08 Grooved / Fluted - 8' \$326.48 each	QS214GR10 Grooved / Fluted - 10' \$408.10 each	QS214GR12 Grooved / Fluted - 12' \$489.72 each
----------------------------------------------------	-----------------------------------------------------	-----------------------------------------------------	-----------------------------------------------------	------------------------------------------------------	------------------------------------------------------

QS214RE02 Reeded - 2' \$81.62 each	QS214RE04 Reeded - 4' \$163.24 each	QS214RE06 Reeded - 6' \$244.86 each	QS214RE08 Reeded - 8' \$326.48 each	QS214RE10 Reeded - 10' \$408.10 each	QS214RE12 Reeded - 12' \$489.72 each
------------------------------------------	-------------------------------------------	-------------------------------------------	-------------------------------------------	--------------------------------------------	--------------------------------------------

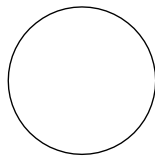

Smooth Wood Pole QS214SM
Wood

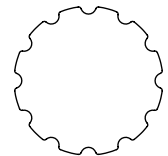

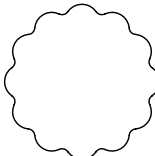
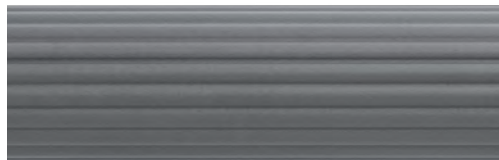

Grooved / Fluted Wood Pole QS214GR
Wood



Reeded Wood Pole QS214RE
Wood

2 1/4" Rings fit the 2 1/4" wood poles.

Note: Ring drop indicates distance from bottom of pole to bottom of ring. A ring's drop changes on different diameter poles.**

 QS214WRI Wood Ring 2 5/8" ID, 3 5/8" OD, 7/8" drop Wood \$9.91 each	 QS214MRI Metal Ring 2 1/2" ID, 3" OD, 1/2" drop Metal \$9.33 each
----------------------------------------------------------------------------------------------------------------------------------------------------------------------------------	--------------------------------------------------------------------------------------------------------------------------------------------------------------------------------

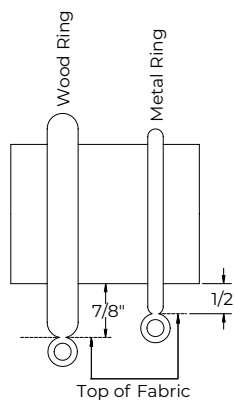

EZ Glide Tape

Included with pole order. Allows rings and grommets to slide effortlessly across the drapery rod without damaging the finish.



2 1/4" Accessories



Fiberglass Baton
3/8" DIA, Fiberglass

QSRE36WAND - 36" - \$67.63 each
QSRE48WAND - 48" - \$73.46 each
QSRE60WAND - 60" - \$79.29 each



Clear Acrylic Baton
1/2" DIA, Acrylic

AC36WAND - 36" - \$52.47 each
AC48WAND - 48" - \$58.30 each
AC60WAND - 60" - \$64.13 each



Handicap Clear Acrylic Baton
4" Loop, ADA Compliant, Acrylic

AC48HWAND - 48" - \$58.30 each
AC60HWAND - 60" - \$64.13 each
AC72HWAND - 72" - \$69.96 each









QS214REL Hinged Elbow
2 3/8" DIA, 5 1/8" OL,
2 9/16" L each side
when bent
Resin

\$64.13 each

Transitional Holdback Medallions

fit transitional holdback stems.

		
QSBHRHB Brooks 4" DIA, 1 1/4" TH Resin	QSMIHB Miranda 5" DIA, 1 1/2" TH Resin	QSTRHB Trudy 4 3/4" DIA, 3/4" TH Resin
\$81.62 pair*	\$87.45 pair*	\$87.45 pair*

		
QSBKHB Blake - Mercury Glass 3" DIA, 2 3/8" TH Metal / Glass	QSHAHB Hadley 3 1/2" DIA, 1" TH Metal	QSPAHB Parker 3 1/4" DIA, 1" TH Metal
\$139.92 pair*	\$69.96 pair*	\$69.96 pair*

Don't forget to order your Holdback Stems separately ≡

Transitional Holdback Stems must order separately. Projection indicates distance from wall to back of medallion.

		
QSTHBSTEM2 2" PROJ Base: 3" DIA Stem: 5/8" DIA Metal	QSTHBSTEM4 4" PROJ Base: 3" DIA Stem: 5/8" DIA Metal	QSTHBSTEM6 6" PROJ Base: 3" DIA Stem: 5/8" DIA Metal
\$58.30 pair*	\$64.13 pair*	\$69.96 pair*

*Sold in pairs only.

Sales Tools

Inspire your clients with professional sales tools designed to showcase Paris Texas Hardware™ and drive revenue for your business. Select from Wall Displays and Table Top Displays with the newest finial designs and finishes.



PTH22POMWDB

Portfolio Metal Wall Display Board
 24" H x 24" W x 6 ¼" Deep
 Wall Mount

\$250.00 NET price



PTH22QSMWDB

Quick Ship Metal Wall Display Board
 24" H x 24" W x 6 ¼" Deep
 Wall Mount

\$250.00 NET price



PTH22POWRDB

Portfolio Wood & Resin Wall Display Board
 24" H x 24" W x 6" Deep
 Wall Mount

\$350.00 NET price



PTH22QSWRDB

Quick Ship Wood & Resin Wall Display Board
 24" H x 24" W x 6" Deep
 Wall Mount

\$350.00 NET price

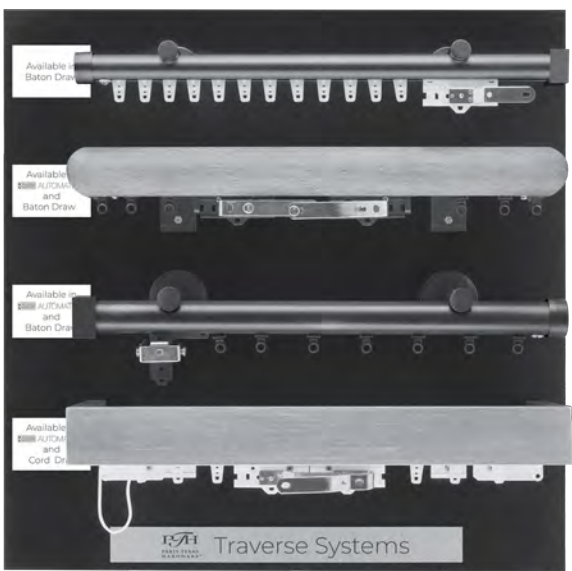

PTH22TDB

Traverse Wall Display Board
24" H x 24" W x 6" Deep
Wall Mount

\$250.00 NET price



R-TEC Automation® Display Kit (case & kit*) RTMDK
30 3/4" H x 26 1/4" W x 8" Deep (case)
*R-TEC Smart Controls not included; see page 45 for our selection.

\$300.00 NET price

Order Modules Separately:

- » R-TEC Automation® Motorized Metal Module RTMDK/FMH \$100.00
- » R-TEC Automation® Track Module with Fascia* RTMDK/TRACK \$100.00
*1 3/8" fascia included for reference only; see page 49 for a full list of fascia styles available in this collection, and choose from any of our 35 Portfolio Hand Painted Finishes, 5 Quick Ship Wood & Resin Finishes or your own PTH Perfect Match™ Finish.
- » Slim Drapery Motor + Battery Kit* RTMLDKIT \$350.00
*Works with motorized metal and track modules above.



PTH22TTPO

Portfolio Table Top Display
12" H x 20" W x 8" Deep

\$200.00 NET price



PTH22TTQS

Quick Ship Table Top Display
8 5/8" H x 20" W x 8" Deep

\$200.00 NET price



PTH

**PARIS TEXAS
HARDWARE™**

ParisTexasHardware.com

FABRICUT®

9303 EAST 46TH STREET
TULSA, OKLAHOMA 74145

PH: 800.763.1348 • FAX: 833.708.0401

FABRICUT.COM

