

AGRICULTURE TIRES TECHNICAL DATABOOK

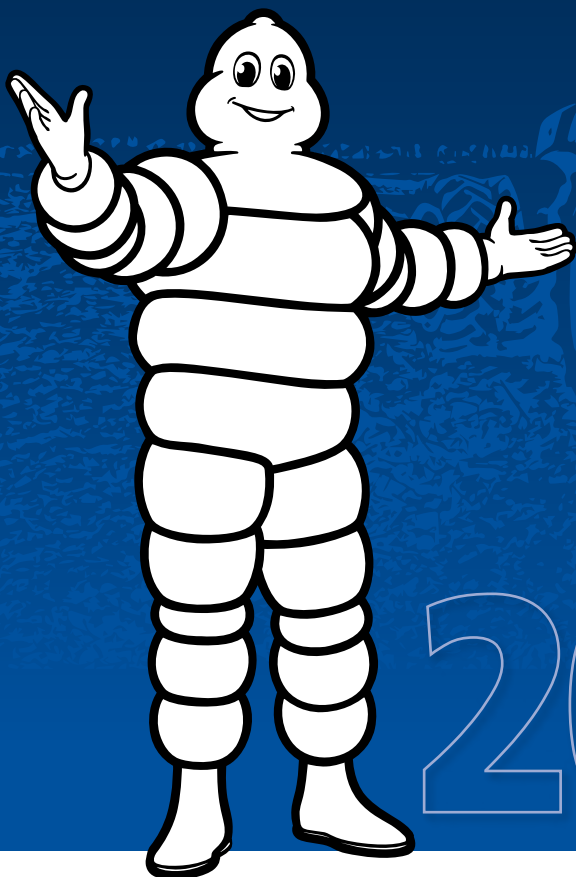

2022

MAY 2022

 [PROFESIONAL.MICHELIN.NO](https://www.profesional.michelin.no)

 [MICHELIN NORDIC](#)



NOTES

Ruled area for notes with horizontal dotted lines.

SUMMARY

READING THE TECHNICAL DATA	4
EQUIVALENCE CHART	5
TIRES BY SIZE	7
ROLLING CIRCUMFERENCE CHART	13
NEW LOAD/PRESSURE	22
PTG - CENTRAL TIRE INFLATION SYSTEM	23
HOW TO CHOOSE AN AGRICULTURAL TIRE?	24
MICHELIN ULTRAFLEX TECHNOLOGIES	26

TRACTORS 27

MICHELIN EVOBIB	27
MICHELIN ROADBIB	29
MICHELIN AXIOBIB 2	33
MICHELIN AXIOBIB	40
MICHELIN MACHXBIB	45
MICHELIN XEOBIB	52
MICHELIN MULTIBIB	56
MICHELIN OMNIBIB	65
MICHELIN YELDBIB	72
MICHELIN AGRIBIB 2	76
MICHELIN AGRIBIB	88

APPLICATION EQUIPMENT 100

MICHELIN AGRIBIB ROW CROP	100
MICHELIN SPRAYBIB CFO	105
MICHELIN SPRAYBIB	111
MICHELIN FLOATXBIB	115

HARVESTERS 118

MICHELIN CEREXBIB 2	118
MICHELIN CEREXBIB	124
MICHELIN MEGAXBIB 2	129
MICHELIN MEGAXBIB	133

TRAILERS & IMPLEMENTS 140

MICHELIN TRAILXBIB	140
MICHELIN CARGOXBIB HIGH FLOTATION	146
MICHELIN CARGOXBIB HEAVY DUTY	151
MICHELIN CARGOXBIB	153
MICHELIN XP 27	156
MICHELIN XS	158

COMPACT LINE 160

RANGES BY USES	160
EQUIVALENT SIZES	161
MICHELIN XMCL	163
MICHELIN BIBLOAD HARD SURFACE	170
MICHELIN CROSSGRIP	175
MICHELIN XF	181
MICHELIN XM 47	183
MICHELIN BIBSTEEL ALL TERRAIN	186
MICHELIN BIBSTEEL HARD SURFACE	189
MICHELIN POWER CL	191

AGRICULTURE USER GUIDE 197

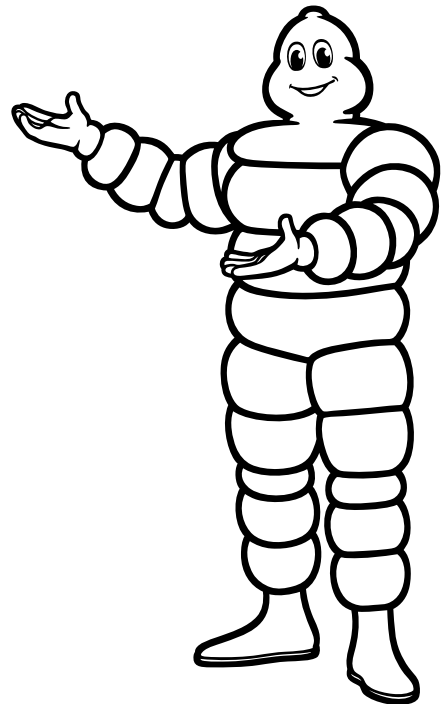

READING THE TECHNICAL DATA

Diagram illustrating the components of a tire marking: \emptyset inches (Rim diameter in inches), CAI (Local country & International Product Code), e mm ((e) Maximum overall section width on measuring rim in millimeters), D mm ((D) Overall diameter in millimeters), R mm ((R') Static laden radius in millimeters), RC mm ((RC) Rolling Circumference in millimeters).

\emptyset inches	Description	CAI	e mm	D mm	R mm	RC mm	Recommended Rim	Acceptable Rim	Tube (Code)	75% internal volume (litres)	Tread depth (mm)
30	VF 540/65 R30 158D/155E TL	296638	536	1460	641	4316	W18L	W16L (NRO)	754	332	48

(TL) Tubeless
(IND) Industrial

Specific markings for very high technology tires

- **IF: Improved Flexion**
(Tires designed to operate at 20% higher rated load than standard tires at the same inflation pressure.)
- **VF: Very High Flexion**
(Tires designed to operate at 40% higher rated load than standard tires at the same inflation pressure.)
- **CFO & CFO+: Improved Flexion Cyclic Field Operation**
(Cyclic Field Operating parameters for IF and VF designated tires)
- **PFO: Pressure Field Operation**
(A tire casing standard that allows tire manufacturers to increase the load capacity of their tires for field use.)

Pressure scale in bar and psi

Bar	0.4	0.6	0.8	0.9	1	1.1	1.2	1.3	1.4	1.5	1.6	1.7	1.8	1.9	2
Psi	6	9	12	13	15	16	17	19	20	22	23	25	26	28	29
65 km/h		2180	2500	2690	2875	3065	3250	3405	3565	3720	3875	3970	4065	4155	4250
70 km/h		2000	2295	2470	2640	2815	2985	3130	3270	3415	3555	3640	3730	3815	3900
65 km/h Dual		1920	2180	2310	2440	2570	2700	2830	2960	3090	3220	3350	3480	3610	3740

Maximum speed in km/h

Load per tire in kg



Important notes for tire use appear at the end of technical data pages for each range.

EQUIVALENCE CHART

STAGE 1

Identify the relevant SRI using the original size.

Speed Radius Index (SRI) is a parameter used to calculate the theoretical speed of vehicles for homologation procedures by vehicle manufacturers and for the interchangeability of different tire sizes.

Ø	SIZES	SRI	Ø	SIZES	SRI	Ø	SIZES	SRI	Ø	SIZES	SRI
16	6.50R16	360	26	480/70R26	650	30.5	600/60R30.5	725	38	580/70R38	875
	7.50R16	390		23.1-26	750		710/50R30.5	700		620/70R38	875
	250/80R16	390		520/80R26	700		850/50R30.5	775		650/65R38	875
	260/70R16	360		540/65R26	650		210/95R32 (8.3R32)	575		650/75R38	925
	280/65R16	360		580/70R26	675		230/95R32 (9.5R32)	600		650/85R38	975
	280/70R16	390		620/70R26	725		270/95R32 (11.2R32)	625		680/75R38	925
18	320/65R16	390	620/75R26	750	320/85R32 (12.4R32)	650	710/60R38	875			
	7.50R18	410	710/65R26	750	650/75R32 (24.5R32)	825	710/70R38	925			
	280/70R18	410	750/50R26	675	680/75R32 (30.5LR32)	875	710/85R38	1025			
	320/65R18	410	750/65R26	750	680/85R32	925	750/65R38	925			
	340/65R18	425	26.5	650/65R26.5	725	800/60R32	875	800/70R38	975		
	7.50R20	425	9.5R28	550	800/65R32	875	900/60R38	975			
20	9.5R20	450	250/85R28	550	800/70R32	925	40	230/95R40 (9.5R40)	700		
	11.2R20	475	280/85R28 (11.2R28)	575	900/60R32	925		270/95R42 (11.2R42)	750		
	12.4R20	500	320/70R28	575	1000/55R32	875		300/95R42 (12.4R42)	800		
	13.6R20	525	320/85R28 (12.4R28)	600	1050/50R32	875		320/90R42	800		
	14.9LR20	525	340/65R28	550	320/85R34	675		480/80R42 (18.4R42)	875		
	260/80R20	450	340/85R28 (13.6R28)	625	380/85R34	725		520/85R42 (20.8R42)	925		
	280/70R20	425	360/70R28	600	420/85R34 (16.9R34)	750		580/85R42	975		
	280/85R20	475	380/70R28	625	420/90R34	775		620/70R42	925		
	300/70R20	450	380/85R28 (14.9R28)	650	460/85R34 (18.4R34)	775		650/65R42	925		
	320/70R20	475	420/65R28	600	480/70R34	750		650/85R42	1025		
	320/85R20	500	420/70R28	650	520/70R34	775		710/60R42	925		
	24	340/65R20	450	420/75R28	650	520/75R34		775	710/70R42	975	
340/75R20		500	420/85R28 (16.9R28)	675	540/65R34	750	710/75R42	1025			
360/70R20		500	440/65R28	625	600/60R34	750	900/50R42	925			
380/70R20		525	480/60R28	625	600/65R34	775	900/60R42	1025			
380/75R20		525	480/65R28	650	620/75R34	825	210/95R44 (8.3R44)	725			
420/65R20		500	480/70R28	675	650/60R34	775	230/95R44 (9.5R44)	750			
440/65R20		525	520/60R28	650	650/65R34	825	270/95R44 (11.2R44)	775			
8.3R24		475	540/65R28	675	650/75R34	875	750/70R44	1025			
250/85R24 (9.5R24)		500	600/60R28	675	710/60R34	825	270/95R46 (11.2R46)	800			
280/85R24 (11.2R24)		525	600/65R28	700	710/75R34	925	300/95R46 (12.4R46)	825			
300/70R24		500	600/70R28	725	210/95R36 (8.3R36)	625	320/90R46	825			
25		320/70R24	525	380/85R30 (14.9R30)	675	230/95R36 (9.5R36)	650	340/85R46 (13.6R46)	825		
	320/85R24 (12.4R24)	550	420/70R30	675	270/95R36 (11.2R36)	675	380/90R46	875			
	340/85R24 (13.6R24)	575	420/85R30 (16.9R30)	700	320/85R36 (12.4R36)	700	420/80R46	875			
	360/70R24	550	420/90R30	725	340/85R36 (13.6R36)	725	480/80R46	925			
	380/70R24	575	460/85R30 (18.4R30)	725	270/95R38 (11.2R38)	700	520/85R46 (20.8R46)	975			
	380/85R24 (14.9R24)	600	480/70R30	700	320/85R38 (12.4R38)	725	620/70R46	975			
	400/70R24	575	480/75R30	700	340/85R38 (13.6R38)	750	750/75R46	≥ 1075			
	420/65R24	550	520/70R30	725	380/80R38	750	900/65R46	≥ 1075			
	420/70R24	600	520/85R30	775	380/95R38	800	230/95R48 (9.5R48)	800			
	420/85R24 (16.9R24)	625	540/85R30	700	400/75R38 (15.5R38)	750	270/95R48 (11.2R48)	825			
	440/65R24	575	600/60R30	700	420/85R38 (16.9R38)	800	340/85R48 (13.6R48)	875			
	460/70R24	600	600/65R30	725	460/85R38 (18.4R38)	825	320/90R50	875			
25	480/65R24	600	600/70R30	750	480/70R38	800	380/90R50	925			
	480/70R24	625	620/70R30	775	520/70R38	825	420/95R50	975			
	500/70R24	625	620/75R30	800	520/85R38 (20.8R38)	875	480/80R50	975			
	540/65R24	625	650/70R30	800	540/65R38	800	480/95R50	1025			
	1000/50R25	750	650/75R30	800	600/60R38	800	52	300/95R52 (12.4R52)	925		
			710/55R30	725	600/65R38	825		270/95R54 (11.2R54)	925		
			710/60R30	750	650/60R38	825		320/105R54	1025		
								320/90R54	925		
								380/90R54	975		

EQUIVALENCE CHART

STAGE 2

Based on the SRI obtained, establish the possible tire size equivalents.

IMPORTANT:

- In no case does the SRI correspond to a specific tread circumference value. Its use in these tables is purely indicative. Verification measurements must be taken.
- Any changes mean you must calculate the axle ratios, evaluate weight distributions and check that the rim widths and diameters are compatible (see technical pages)

SRI	EQUIVALENTS	SRI	EQUIVALENTS	SRI	EQUIVALENTS	SRI	EQUIVALENTS			
360	6.50R16	625	210/95R36 // 8.3R36	750	230/95R44 // 9.5R44	875 (1.85m)	320/90R50			
	260/70R16		270/95R32 // 11.2R32		270/95R42 // 11.2R42		340/85R48 // 13.6R48			
	280/65R16		340/85R28 // 13.6R28		340/85R38 // 13.6R38		380/90R46			
7.50R16	380/70R28		380/80R38		420/80R46					
250/80R16	420/85R24 // 16.9R24		400/75R38 // 15.5R38		480/80R42 // 18.4R42					
280/70R16	440/65R28		420/85R34 // 16.9R34		520/85R38 // 20.8R38					
320/65R16	480/60R28		480/70R34		580/70R38					
7.50R18	480/70R24		540/65R34		620/70R38					
280/70R18	500/70R24		600/60R34		650/65R38					
320/65R18	540/65R24		600/70R30		650/75R34					
425	7.50R20	650	230/95R36 // 9.5R36	775	620/75R26 // 23.1R26	925 (1.95m)	680/75R32 // 30.5L R32			
	280/70R20		320/85R32 // 12.4R32		710/60R30		710/60R38			
	340/65R18		380/85R28 // 14.9R28		710/65R26		800/60R32			
9.5R20	420/70R28		750/65R26		800/65R32					
260/80R20	420/75R28		1000/50R25		1000/55R32					
300/70R20	480/65R28		270/95R44 // 11.2R44		1050/50R32					
340/65R20	480/70R26		420/90R34		270/95R54 // 11.2R54					
11.2R20	520/60R28		460/85R34 // 18.4R34		300/95R52 // 12.4R52					
280/85R20	540/65R26		520/85R30		320/90R54					
320/70R20	270/95R36 // 11.2R36		520/70R34		380/90R50					
8.3R24	320/85R34 // 12.4R34	520/75R34	480/80R46							
500	250/85R24 // 9.5R24	675	380/85R30 // 14.9R30	800	600/65R34	975 (2.05m)	520/85R42 // 20.8R42			
	300/70R24		420/70R30		620/70R30		620/70R42			
	320/85R20 // 12.4R24		420/85R28 // 16.9R28		650/60R34		650/65R42			
	340/75R20		480/70R28		850/50R30.5		650/75R38			
	360/70R20		540/65R28		230/95R48 // 9.5R48		680/75R38			
420/65R20	580/70R26		270/95R46 // 11.2R46		680/85R32					
525	280/85R24 // 11.2R24		700		600/60R28		825 (1.75m)	300/95R42 // 12.4R42	1025 (2.15m)	710/60R42
	320/70R24				750/50R26			320/90R42		710/70R38
	380/70R20				230/95R40 // 9.5R40			380/95R38		710/75R34
	380/75R20 // 13.6R20				270/95R38 // 11.2R38			420/85R38 // 16.9R38		750/65R38
	14.9L R20	320/85R36 // 12.4R36		480/70R38	800/70R32					
440/65R20	420/85R30 // 16.9R30	540/65R38		900/50R42						
250/85R28 // 9.5R28	480/70R30	600/60R38		900/60R32						
320/85R24 // 12.4R24	480/75R30	620/75R30		380/90R54						
340/65R28	520/80R26	650/70R30		420/95R50						
360/70R24	540/65R30	650/75R30		480/80R50						
420/65R24	600/60R30	270/95R48 // 11.2R48	520/85R46 // 20.8R46							
575	210/95R32 // 8.3R32	725	600/65R28	825 (1.75m)	300/95R46 // 12.4R46	1075 (2.30m)	580/85R42			
	280/85R28 // 11.2R28		210/95R44 // 8.3R44		320/90R46		620/70R46			
	320/70R28		320/85R38 // 12.4R38		340/85R46 // 13.6R46		650/85R38			
	340/85R24 // 13.6R24		340/85R36		460/85R38 // 18.4R38		710/70R42			
	380/70R24		380/85R34		520/70R38		800/70R38			
400/70R24	420/90R30		600/65R38		900/60R38					
440/65R24	460/85R30 // 18.4R30		620/75R34		320/105R54					
230/95R32 // 9.5R32	520/70R30		650/75R32 // 24.5R32		480/95R50					
320/85R28 // 12.4R28	600/60R30.5		650/65R34		650/85R42					
360/70R28	600/65R30		650/60R38		710/75R42					
380/85R24 // 14.9R24	600/70R28	710/60R34	710/85R38							
420/65R28	620/70R26		750/70R44							
420/70R24	650/65R26.5		900/60R42							
460/70R24	710/50R30.5		750/75R46							
480/65R24	710/55R30		900/65R46							

TIRES BY SIZE

SEAT	SIZES	EVOBIB	ROADBIB	AXIOBIB 2	AXIOBIB	MACHXBIB	XEOBIB	MULTIBIB	MULTIBIB PLUS	OMNIBIB	YELDBIB	AGRIBIB 2	AGRIBIB	AGRIBIB RC	SPRAYBIB CFO	SPRAYBIB	FLOATXBIB	CEREXBIB 2	CEREXBIB	MEGAXBIB 2	MEGAXBIB	TRAILXBIB	CARGOXBIB HIGH FLOTATION	CARGOXBIB HEAVY DUTY	CARGOXBIB 2	CARGOXBIB	XP27	XS	CROSSGRIP
16	250/80R16																												S
16	270/65R16																										S		
16	280/70R16									S																			
16	320/65R16							S																					
18	270/65R18																										S		
18	320/65R18							S																					
18	340/65R18							S																			S		
18	340/80R18																												S
20	280/70R20									S																			
20	420/65R20							S																					
20	440/65R20							S																					
20.5	24R20.5																											S	
22.5	500/60R22.5																					VF	S	S					
22.5	560/45R22.5																						S						
22.5	560/60R22.5																					VF	S						
22.5	600/50R22.5																					VF		S	S				
22.5	710/45R22.5																					VF	S						
24	280/85R24 (11.2R24)											S	S																
24	320/85R24 (12.4R24)											S	S																
24	340/85R24 (13.6R24)											S	S																
24	380/85R24 (14.9R24)											S	S																
24	420/85R24 (16.9R24)											S	S																
24	320/70R24								S																				
24	360/70R24								S																				
24	360/80R24																												S
24	380/70R24								S																				
24	400/80R24																												S
24	420/65R24							S																					
24	420/70R24								S																				
24	440/65R24							S																					
24	460/70R24																												S

Information IF = Improved Flexion | VF = Very High Flexion | S = Standard

TIRES BY SIZE

SEAT	SIZES	EVOBIB	ROADBIB	AXIOBIB 2	AXIOBIB	MACHXBIB	XEOBIB	MULTIBIB	MULTIBIB PLUS	OMNIBIB	YELDBIB	AGRIBIB 2	AGRIBIB	AGRIBIB RC	SPRAYBIB CFO	SPRAYBIB	FLOATXBIB	CEREXBIB 2	CEREXBIB	MEGAXBIB 2	MEGAXBIB	TRAILXBIB	CARGOXBIB HIGH FLOTATION	CARGOXBIB HEAVY DUTY	CARGOXBIB 2	CARGOXBIB	XP27	XS	CROSSGRIP
24	480/65R24							S																					
24	480/70R24								S																				
24	500/70R24																												S
24	540/65R24							S																					
24	9.5R24												S																
25	1000/50R25															VF			S	S									
26	28LR26																						S						
26	480/80R26									S																			
26	520/80R26																VF	VF											
26	620/70R26																	VF	VF										
26	620/75R26																				S								
26	710/65R26																					VF							
26	750/50R26															VF			S	S									
26	750/65R26																VF	VF		S									
26.5	600/55R26.5																				VF	S/VF							
26.5	650/55R26.5																				VF	S/VF							
26.5	650/65R26.5																					VF							
26.5	710/50R26.5																					VF	S/VF						
26.5	800/45R26.5																									S			
28	280/85R28 (11.2R28)										S																		
28	320/85R28 (12.4R28)											S																	
28	340/85R28 (13.6R28)										S	S																	
28	380/85R28 (14.9R28)										S	S																	
28	420/85R28 (16.9R28)										S	S																	
28	380/70R28								S																				
28	400/80R28																												S
28	420/65R28							S																					
28	420/70R28								S																				
28	440/65R28							S																					
28	440/80R28																												S
28	480/60R28						VF																						

Information IF = Improved Flexion | VF = Very High Flexion | S = Standard

TIRES BY SIZE

SEAT	SIZES	EVOBIB	ROADBIB	AXIOBIB 2	AXIOBIB	MACHYBIB	XEOBIB	MULTIBIB	MULTIBIB PLUS	OMNIBIB	YELDBIB	AGRIBIB 2	AGRIBIB	AGRIBIB RC	SPRAYBIB CFO	SPRAYBIB	FLOATXBIB	CEREXBIB 2	CEREXBIB	MEGAXBIB 2	MEGAXBIB	TRAILXBIB	CARGOXBIB HIGH FLOTATION	CARGOXBIB HEAVY DUTY	CARGOXBIB 2	CARGOXBIB	XP27	XS	CROSSGRIP
28	480/65R28							S																					
28	480/70R28								S																				
28	520/60R28						VF																						
28	540/65R28							S																					
28	600/60R28						VF																						
28	600/65R28					S																							
28	600/70R28					S																							
30	380/85R30 (14.9R30)									S	S																		
30	420/85R30 (16.9R30)									S	S																		
30	460/85R30 (18.4R30)									S	S																		
30	420/90R30								S	S																			
30	480/70R30							S																					
30	520/85R30																	VF	VF										
30	540/65R30		S	VF				S																					
30	600/60R30			VF			VF																						
30	600/70R30	VF	S	VF	IF	S																							
30	620/70R30																	VF											
30	620/75R30			VF	IF																S								
30	650/75R30				IF																								
30	710/55R30					S																							
30	710/65R30																	VF											
30.5	600/60R30.5																				VF				S				
30.5	650/65R30.5																				VF	S							
30.5	710/50R30.5																				VF				S				
30.5	750/60R30.5																				VF	S/VF							
30.5	800/45R30.5																								S				
30.5	850/50R30.5																				VF				S				
32	1000/55R32																IF/VF	IF											
32	1050/50R32																			S	S								
32	650/75R32									S										S	S								
32	680/75R32					S																							
32	680/85R32																		IF										

Information IF = Improved Flexion | VF = Very High Flexion | S = Standard

TIRES BY SIZE

SEAT	SIZES	EVOBIB	ROADBIB	AXIOBIB 2	AXIOBIB	MACHXBIB	XEOBIB	MULTIBIB	MULTIBIB PLUS	OMNIBIB	YELDBIB	AGRIBIB 2	AGRIBIB	AGRIBIB RC	SPRAYBIB CFO	SPRAYBIB	FLOATXBIB	CEREXBIB 2	CEREXBIB	MEGAXBIB 2	MEGAXBIB	TRAILXBIB	CARGOXBIB HIGH FLOTATION	CARGOXBIB HEAVY DUTY	CARGOXBIB 2	CARGOXBIB	XP27	XS	CROSSGRIP
32	800/60R32																					VF	S						
32	800/65R32																		IF	IF	S	S							
32	800/70R32																		IF	IF	S	S							
32	900/60R32																		VF		S	S							
34	420/85R34 (16.9R34)										VF	S																	
34	460/85R34 (18.4R34)											S	S																
34	320/85R34											S	S																
34	380/85R34										VF	S	S																
34	420/90R34														VF														
34	440/80R34																												S
34	480/70R34				IF				S																				
34	480/80R34																												S
34	500/85R34																	VF											
34	520/70R34								S																				
34	540/65R34							S																					
34	600/60R34						VF																						
34	600/65R34							S																					
34	620/75R34																					S							
34	650/60R34		S	VF	IF	S																							
34	650/65R34		S	VF	IF	S																							
34	710/60R34			VF	IF																								
34	710/75R34																				S	S							
36	320/85R36 (12.4R36)											S																	
38	320/85R38 (12.4R38)											S	S/IF																
38	340/85R38 (13.6R38)										S	S																	
38	420/85R38 (16.9R38)										S	S																	
38	460/85R38 (18.4R38)										S	S																	
38	520/85R38 (20.8R38)										S	S																	
38	380/80R38									VF					VF	VF													

Information IF = Improved Flexion | VF = Very High Flexion | S = Standard

TIRES BY SIZE

SEAT	SIZES	EVOBIB	ROADBIB	AXIOBIB 2	AXIOBIB	MACHXBIB	XEOBIB	MULTIBIB	MULTIBIB PLUS	OMNIBIB	YELDBIB	AGRIBIB 2	AGRIBIB	AGRIBIB RC	SPRAYBIB CFO	SPRAYBIB	FLOATXBIB	CEREXBIB 2	CEREXBIB	MEGAXBIB 2	MEGAXBIB	TRAILXBIB	CARGOXBIB HIGH FLOTATION	CARGOXBIB HEAVY DUTY	CARGOXBIB 2	CARGOXBIB	XP27	XS	CROSSGRIP
38	380/95R38										VF		S																
38	480/70R38								S																				
38	480/80R38																												S
38	520/70R38								S																				
38	540/65R38							S																					
38	540/80R38																												S
38	580/70R38									S																			
38	600/60R38						VF																						
38	600/65R38							S																					
38	620/70R38																				S								
38	650/60R38			VF			VF																						
38	650/65R38				IF			S	S																				
38	650/75R38					S																							
38	650/85R38			VF	IF	S															S								
38	680/75R38																		IF										
38	680/80R38																	IF											
38	710/60R38				IF		VF																						
38	710/70R38					S																							
38	710/85R38				IF																								
38	800/70R38			VF	IF	S														IF	IF								
38	900/60R38																	VF	VF										
42	520/85R42 (20.8R42)										S	S							VF		S								
42	320/90R42												S	VF	VF														
42	480/80R42										S	S		VF	VF														
42	580/85R42																		VF										
42	620/70R42								S													S							
42	650/60R42						VF																						
42	650/65R42		S	VF				S	S																				
42	650/85R42			VF																									
42	710/60R42			VF			VF																						
42	710/70R42	VF	S	VF	IF	S														VF	IF								
42	710/75R42		S	VF	IF	S																							
42	800/70R42																			IF									

Information IF = Improved Flexion | VF = Very High Flexion | S = Standard

TIRES BY SIZE

SEAT	SIZES	EVOBIB	ROADBIB	AXIOBIB 2	AXIOBIB	MACHXBIB	XEOBIB	MULTIBIB	MULTIBIB PLUS	OMNIBIB	YELDBIB	AGRIBIB 2	AGRIBIB	AGRIBIB RC	SPRAYBIB CFO	SPRAYBIB	FLOATXBIB	CEREXBIB 2	CEREXBIB	MEGAXBIB 2	MEGAXBIB	TRAILXBIB	CARGOXBIB HIGH FLOTATION	CARGOXBIB HEAVY DUTY	CARGOXBIB 2	CARGOXBIB	XP27	XS	CROSSGRIP
42	900/50R42					S																							
42	900/60R42			VF	IF																								
44	750/70R44			VF																									
46	320/90R46														VF	VF													
46	340/85R46													S															
46	380/90R46													S/IF	VF	VF													
46	420/80R46										S	S																	
46	480/80R46									VF	S	S			VF	VF													
46	520/85R46										S	S																	
46	620/70R46					S																							
46	710/60R46															VF													
46	750/75R46				IF																								
46	900/65R46				IF																								
50	320/90R50													S/IF	VF	VF													
50	380/90R50													S/IF		VF													
50	420/95R50														VF	VF													
50	480/80R50									VF	S				VF	VF													
50	480/95R50									VF		S																	
54	320/105R54															VF													
54	320/90R54													S/IF	VF	VF													
54	380/90R54										S				VF	VF													

Information IF = Improved Flexion | VF = Very High Flexion | S = Standard

ROLLING CIRCUMFERENCE CHART

TIRE SIZE AND RANGE	CAI	MSPN	Minimum Dual Spacing		Tire Diameter		Rolling Circumference		RCI	SRI
			mm	inches	mm	inches	mm	inches		
270/65 R16 134A8/122A8 TL XP27	184332	04629	381	15	755	30	2300	91		360
280/70R16 112D TL OMNIBIB	747196		389	15	805	32	2400	94		390
270/65 R18 136A8/124A8 TL XP27	133069	98595	381	15	810	32	2472	97		390
320/65R16 107D TL MULTIBIB	494658	39517	434	17	827	33	2452	97		390
11LR16 122A8 TL X M27	123207	13902	386	15	850	33	2515	99		0
320/65 R18 109A8/106B TL XM108	123898	78520	434	17	875	34	2594	102		410
340/65R18 149A8/137A8 TL X P27	415969	08185	462	18	891	35	2720	107	32	425
280/70R20 116D TL OMNIBIB	263806		389	15	904	36	2690	106	32	450
340/65 R18 113D TL MULTIBIB	659984	20099	462	18	908	36	2684	106	32	425
340/65R18 113A8/110B TL XM108	123888	79647	462	18	911	36	2719	107	32	425
9.5 R24 112A8/109B TL AGRIBIB	200987	07126	340	13	1045	41	3117	123	35	500
420/65 R20 125A8/125B TL XM108	122702	86582	552	22	1064	42	3135	123	35	500
405/70R20 136G TL X M47	123708	43043	539	21	1076	42	3194	126		0
560/45R22.5 152D TL CARGOXBIB HEAVY DUTY	743789	27334	702	28	1080	43	3191	126		525
440/65R20 128D TL MULTIBIB	675464	15810	580	23	1090	43	3260	128		525
11.2R24 119A8/116B TL AGRIBIB	317247	92311	392	15	1095	43	3269	129	36	525
320/70R24 116D TL OMNIBIB	415039	25416	434	17	1101	43	3274	129		525
445/70R19.5 173A8/180A2 TL XF	489102	81617	585	23	1110	44	3331	131		0
425/75R20 148G TL X M47	123706	75328	556	22	1147	45	3398	134		0
12.4 R24 119A8/116B TL AGRIBIB	123788	78449	429	16	1149	45	3420	135	37	550
360/70 R24 122D TL OMNIBIB	198698	45416	479	19	1153	45	3418	135	37	550
420/65 R24 126D TL MULTIBIB	171560	11709	552	22	1156	45	3416	135	37	550
420/65R24 126A8/126B TL XM108	122712	77842	552	22	1160	46	3425	135		550
VF 600/50 R22.5 164D IMP TL TRAILXBIB	414979	04220	760	30	1172	46	3419	135		550
500/60R22.5 155D TL CARGOXBIB HEAVY DUTY	441880	36343	654	26	1172	46	3454	136		550
VF 500/60 R22.5 160D IMP TL TRAILXBIB	229116	02997	654	26	1173	46	3433	135		550
600/50R22.5 159D TL CARGOXBIB	048429	94336	760	30	1181	46	3478	137		550
440/65R24 128D TL MULTIBIB	426389	04039	580	23	1187	47	3519	139		575
380/70R24 125D TL OMNIBIB	085816	64778	507	20	1188	47	3520	139	38	575
280/85R28 123A8/120D TL AGRIBIB 2	392931	40217	389	15	1192	47	3563	140		575
445/70R22.5 175A8/182A2 TL XF	073522	33819	585	23	1192	47	3582	141		0
13.6R24 124A8/121B TL AGRIBIB	262831	06247	465	18	1200	47	3583	141	38	575
525/65R20.5 173F TL XS	109421	71848	687	27	1200	47	3640	143		575
340/85 R24 130A8/130B TL AGRIBIB 2	694878	43288	462	18	1202	47	3580	141		575
710/45R22.5 165D TL CARGOXBIB HIGH FLOTATION	723051	06153	910	36	1208	48	3545	140		575
VF 710/45 R22.5 170D IMP TL TRAILXBIB	520302	64711	910	36	1214	48	3562	140		575

ROLLING CIRCUMFERENCE CHART

TIRE SIZE AND RANGE	CAI	MSPN	Minimum Dual Spacing		Tire Diameter		Rolling Circumference		RCI	SRI
			mm	inches	mm	inches	mm	inches		
420/65R28 135D TL MULTIBIB	778211	62700	552	22	1238	49	3680	145		600
445/70R24 151G TL X M47	123642	45627	585	23	1239	49	3689	145		0
480/65R24 133D TL MULTIBIB	531721	03176	626	25	1240	49	3667	144	38	600
VF 560/60 R22.5 166D IMP TL TRAILXBIB	103824	41626	728	29	1242	49	3612	142		600
560/60R22.5 161D TL CARGOXBIB HEAVY DUTY	102433	20379	728	29	1242	49	3650	144		600
420/70R24 130D TL OMNIBIB	829095	28067	552	22	1251	49	3702	146	39	600
14.9R24 130A8/127B TL AGRIBIB	601563	92158	504	20	1265	50	3769	148		600
12.4R28 126A8/123B TL AGRIBIB	738964	20895	429	17	1265	50	3778	149		600
440/65R28 131D TL MULTIBIB	386212	96372	580	23	1291	51	3833	151	39	625
380/70 R28 127D TL OMNIBIB	118587	24723	507	20	1294	51	3842	151	39	625
VF 480/60R28 134D TL XEOBIB	312875	80140	639	25	1298	51	3831	151	39	625
13.6 R28 123A8/120B TL AGRIBIB	123782	87976	465	18	1308	51	3893	153	39	625
495/70R24 155G TL X M47	123620	88892	650	26	1311	52	3883	153		0
540/65R24 140D TL MULTIBIB	097057	08801	711	28	1312	52	3873	152		625
480/70R24 138D TL OMNIBIB	375821	02475	626	25	1327	52	3916	154		625
16.9 R24 134A8/131B TL AGRIBIB	123854	97341	566	22	1330	52	3935	155		625
VF 520/60R28 138D TL XEOBIB	510495	80236	670	26	1338	53	3942	155	40	650
480/65R28 136D TL MULTIBIB	897574	14369	626	25	1339	53	3970	156		650
VF 600/55R26.5 IMP 170D TL CARGOXBIB HIGH FLOTATION	377726		760	30	1341	53	3923	154		625
600/55R26.5 165D TL CARGOXBIB HIGH FLOTATION	550621	32505	760	30	1341	53	3954	156		625
VF 600/55 R26.5 170D IMP TL TRAILXBIB	112743	41893	760	30	1353	53	3960	156		625
420/70R28 133D TL OMNIBIB	532215	25705	552	22	1354	53	4012	158	40	650
380/85 R28 139A8/139B TL AGRIBIB 2	184281	12989	507	20	1362	54	4053	160	40	650
14.9 R28 134A8/131B TL AGRIBIB	112235	25543	504	19	1365	54	4072	160	40	650
24 R 20.5 XS TL 176F MI	109174	44650	778	31	1374	54	4148	163		650
VF 710/50 R26.5 176D IMP TL TRAILXBIB	723409	39765	910	36	1380	54	4022	158		650
VF 710/50R26.5 IMP 176D TL CARGOXBIB HIGH FLOTATION	343405		910	36	1380	54	4022	158		650
710/50R26.5 170D TL CARGOXBIB HIGH FLOTATION	892516	29880	910	36	1380	54	4061	160		650
800/45R26.5 174D TL CARGOXBIB	248959	81371	1008	40	1395	55	4097	161		675
VF 650/55R26.5 IMP 174D TL TRAILXBIB	054878	37535	825	32	1402	55	4082	161		725
VF 650/55R26.5 IMP 174D TL CARGOXBIB HIGH FLOTATION	776393		825	32	1402	55	4084	161		725
650/55R26.5 169D TL CARGOXBIB HIGH FLOTATION	693431	15666	825	32	1402	55	4158	164		725
750/50R26 160A8/154D TL MEGAXBIB	478428	67149	956	38	1404	55	4162	164	41	675
VF 750/50R26 CFO 174D/170E TL FLOATXBIB	982905	10112			1405	55	4155	164		675
750/50R26 160A8/154D TL MEGAXBIB 2	236906	81321	956	38	1406	55	4171	164		675
380/85 R30 140A8/140B TL AGRIBIB 2	151572	72163	507	20	1416	56	4219	166	41	675

ROLLING CIRCUMFERENCE CHART

TIRE SIZE AND RANGE	CAI	MSPN	Minimum Dual Spacing		Tire Diameter		Rolling Circumference		RCI	SRI
			mm	inches	mm	inches	mm	inches		
			380/85R30 135A8/135B TL AGRIBIB	836509	18784	507	20	1416		
420/85 R28 144A8/144B TL AGRIBIB 2	135905	43824	552	22	1419	56	4226	166	41	675
320/85R34 133A8/130B TL AGRIBIB	122760	73532	434	17	1420	56	4239	167	41	675
320/85R34 133A8/133B TL AGRIBIB 2	908266		434	17	1421	56	4243	167	41	675
480/70R28 140D TL OMNIBIB	570026	27084	626	25	1427	56	4217	166	41	675
540/65R28 142D TL MULTIBIB	792274	36062	711	28	1427	56	4223	166	41	675
VF 600/60R28 146D TL XEOBIB	665184	80297	767	30	1429	56	4198	165	41	675
16.9R28 141A8/138B TL AGRIBIB	984997	13991	566	22	1435	56	4278	168		675
12.4 R36 124A8/121B TL AGRIBIB	123952	03338	429	17	1460	57	4363	172	41	700
VF 540/65R30 158D/155E TL AXIOBIB 2	296638	06869	710	28	1460	57	4316	170		700
540/65R30 150D/146E TL ROADBIB	274757	92680	711	28	1464	58	4382	173		700
VF 600/60R30 162D/159E TL AXIOBIB 2	371968	06116	767	30	1468	58	4336	171		700
540/65 R30 143D TL MULTIBIB	223153	28553	711	28	1472	58	4353	171		700
16.9 R30 137A8/134B TL AGRIBIB	123870	41545	566	22	1480	58	4395	173	42	700
480/70R30 141D TL OMNIBIB	599351	27236	626	25	1482	58	4388	173	42	700
600/65R28 154A8/154B TL MACHXBIB	135288	86350	760	30	1485	58	4415	174	42	700
420/85 R30 145A8/139D TL AGRIBIB 2	184330	72159	552	22	1487	59	4416	174	42	700
VF 710/50 R30.5 178D IMP TL TRAILXBIB	562163	22998	910	36	1489	58	4397	173		700
VF 600/60 R30.5 175D IMP TL TRAILXBIB	286219	30202	772	30	1491	58	4357	172		725
VF 520/80R26 CFO 168A8 TL CEREXBIB	972024	61911	670	26	1491	59	4397	173		700
VF 520/80R26 CFO+ 168A8 TL CEREXBIB 2	850494	24394	670	26	1491	59	4400	173		700
VF 600/60R30 147D TL XEOBIB	065253	03690	767	30	1493	59	4379	172	42	700
600/65R28 154D/150E TL MACHXBIB	429970	44562	760	30	1494	59	4465	176	42	700
710/50R30.5 173D TL CARGOXBIB	002786	92209	910	36	1495	59	4408	174		700
800/45R30.5 176D TL CARGOXBIB	932951	53255	1008	40	1495	59	4408	174		725
600/60R30.5 169D TL CARGOXBIB	236518	51915	767	30	1496	59	4417	174		700
12.4R38 131A8/128B TL AGRIBIB	258138	15336	429	17	1500	59	4484	177	42	725
380/85R34 137A8/137B TL AGRIBIB	122781	59412	507	20	1503	59	4461	176	42	725
IF 320/85 R38 151A8/151B TL AGRIBIB RC	351097	20864	438	17	1506	59	4496	177	42	725
320/85R38 143A8/143B TL AGRIBIB RC	758001	50528	434	17	1508	59	4514	178	42	725
VF 380/85R34 149A8/149B TL YIELDBIB	305457	91239	510	20	1510	59	4471	176	43	725
VF 620/70R26 CFO 173A8 TL CEREXBIB	656967	64298	790	31	1513	60	4458	176	42	725
VF 620/70R26 CFO+ 173A8 TL CEREXBIB 2	228272	98039	790	31	1513	60	4461	176	42	725
380/85R34 142A8/142B TL AGRIBIB 2	009860	84143	507	20	1516	60	4519	178	42	725
710/55R30 153D TL MACHXBIB	992342	03784	910	36	1518	60	4489	177		725
420/90R30 147A8/147B TL AGRIBIB 2	508522	71308	552	22	1518	60	4513	178	42	725

ROLLING CIRCUMFERENCE CHART

TIRE SIZE AND RANGE	CAI	MSPN	Minimum Dual Spacing		Tire Diameter		Rolling Circumference		RCI	SRI
			mm	inches	mm	inches	mm	inches		
VF 650/65 R26.5 179D IMP TL TRAILXBIB	059338	86356	825	33	1523	60	4496	177		725
420/90R30 147A8/147B TL AGRIBIB	953332	68713	552	22	1533	60	4556	179	42	725
18.4 R30 142A8/139B TL AGRIBIB	123844	42060	611	24	1550	61	4602	181		725
13.6 R38 128A8/125B TL AGRIBIB	123992	66666	465	18	1565	61	4705	185	43	750
600/70R30 158D/155E TL ROADBIB	217911	15131	774	30	1569	62	4630	182		750
600/70 R28 157D/154E TL MACHXBIB	211033	29237	760	30	1571	62	4652	183		725
540/65R34 145D TL MULTIBIB	712064	22243	711	28	1574	62	4655	183	43	750
VF 380/80R38 167D TL SPRAYBIB	352109	93213	510	20	1577	62	4712	186		750
VF 710/65 R26 184D IMP TL TRAILXBIB	885998		898	35	1578	62	4584	181		750
VF 600/70R30 168D/165E TL AXIOBIB 2	426719	32376	774	30	1579	62	4659	183	43	750
28LR26 175D TL CARGOXBIB HIGH FLOTATION	224829		907	36	1581	62	4685	184		0
VF 420/85R34 154A8/154B TL YELDBIB	012445	58965	554	22	1582	62	4682	184	43	750
IF 600/70R30 159D TL AXIOBIB	280086	96393	774	30	1585	62	4683	184	43	750
600/70R28 157A8/157B TL MACHXBIB	395016	46139	760	30	1586	62	4694	185		725
420/85 R34 147A8/147B TL AGRIBIB 2	183733	16801	552	22	1589	62	4730	186	43	750
540/65 R34 152D TL MULTIBIB	214036	99445	711	28	1590	62	4716	186	43	750
VF 380/80R38 149A8/149B TL YELDBIB	870363	35470	510	20	1592	63	4851	191	43	750
480/70R34 143D TL OMNIBIB	280033	25021	626	25	1593	63	4728	186	43	750
380/80 R38 142A8/139D TL AGRIBIB 2	187095	59112	507	20	1595	63	4755	187	43	750
VF 600/60R34 149D TL XEOBIB	664777	78329	767	30	1595	63	4699	185	43	750
420/85R34 147A8/147B TL AGRIBIB	788910	30127	552	22	1595	63	4751	187	43	750
620/75R26 166A8/166B TL MEGAXBIB	614320	89936	801	32	1602	63	4748	187	43	750
VF 420/90 R34 CFO 174D/170E TL SPRAYBIB	343695	29015	554	22	1603	63	4762	188		775
600/70R30 158D TL MACHXBIB	566557	68124	774	30	1604	63	4760	187	43	750
VF 620/70R30 CFO 172A8 TL CEREXBIB	886789	92780	790	31	1615	64	4760	187		775
VF 620/70R30 CFO+ 175A8 TL CEREXBIB 2	049288	53106	790	31	1615	64	4765	188		775
600/70 R30 158D/154E TL ROADBIB	264539	73799	774	31	1617	63	4800	189	43	750
750/65R26 171A8/171B TL MEGAXBIB	983217	36798	956	38	1621	64	4818	190		750
650/65R30.5 176D TL CARGOXBIB HIGH FLOTATION	139310	28171	825	32	1622	64	4776	188		775
VF 750/65 R26 CFO+ 180A8 TL CEREXBIB 2	132266	33777	956	38	1623	64	4786	188		750
VF 750/65R26 CFO 177A8 TL CEREXBIB	811382	02320	956	38	1623	64	4780	188		750
VF 520/85 R30 CFO+ 172A8 TL CEREXBIB 2	188276	86907	682	27	1624	64	4797	189	46	775
VF 520/85R30 CFO 172A8 TL CEREXBIB	795916	66188	682	27	1624	64	4794	189	46	775
VF 850/50 R30.5 188D IMP TL TRAILXBIB	659949	79539	1073	42	1626	64	4758	187		775
850/50R30.5 182D TL CARGOXBIB	938016	69986	1073	42	1628	64	4778	188		775
VF 650/65 R30.5 181D IMP TL TRAILXBIB	120737	02919	825	33	1632	64	4806	189		775

ROLLING CIRCUMFERENCE CHART

TIRE SIZE AND RANGE	CAI	MSPN	Minimum Dual Spacing		Tire Diameter		Rolling Circumference		RCI	SRI
			mm	inches	mm	inches	mm	inches		
VF 320/90R42 163D TL SPRAYBIB	920383	44635	438	17	1635	64	4890	193		800
VF 1000/50R25 CFO 190D/186E TL FLOATXBIB	713716	20271	1258	50	1636	64	4845	191		775
320/90R42 147A8/147B TL AGRIBIB RC	425361	64720	434	17	1638	64	4908	193	44	800
460/85 R34 152A8/152B TL AGRIBIB 2	817711	32288	597	24	1650	65	4908	193		775
520/70R34 148D TL OMNIBIB	939411	29601	676	27	1651	65	4887	192	44	775
650/60R34 159D/155E TL ROADBIB	556249	90034	825	32	1651	65	4935	194		775
VF 650/60 R34 168D/165E TL AXIOBIB 2	202185	39440	831	33	1653	65	4882	192		775
600/65R34 151D TL MULTIBIB	557189	16291	760	30	1654	65	4897	193	44	775
1000/50R25 172A8/166D TL MEGAXBIB 2	852423	76362	1233	49	1654	65	4907	193		750
IF 650/60R34 165D TL AXIOBIB	100511	94599	831	33	1661	65	4933	194		775
18.4R34 149A8/146B TL AGRIBIB	679786	71754	611	24	1662	65	4940	194	44	775
650/60R34 159D/155E TL MACHXBIB	549996	96892	825	32	1664	66	4950	195		775
VF 620/75R30 172D/169E TL AXIOBIB 2	702894	20861	814	32	1670	66	4919	194	44	800
IF 620/75R30 164D TL AXIOBIB	668406	96772	790	31	1670	66	4927	194	44	800
VF 750/60R30.5 IMP 187D TL CARGOXBIB HIGH FLOTATION	139588		956	38	1674	66	4875	192		800
540/65 R38 147D TL MULTIBIB	114518	28857	711	28	1675	66	4965	196	44	800
750/60R30.5 181D TL CARGOXBIB HIGH FLOTATION	101332	77049	956	38	1675	66	4936	194		800
VF 710/65R30 CFO+ 179A8 TL CEREXBIB 2	608814	22560	876	34	1676	66	4952	195	44	800
VF 500/85R34 CFO+ 172A8 TL CEREXBIB 2	038009	29877	642	25	1676	66	4961	195		825
420/85R38 144A8/144B TL AGRIBIB	607820	84239	552	22	1676	66	4975	196	44	800
VF 750/60 R30.5 187D IMP TL TRAILXBIB	223428	20302	956	38	1678	66	4873	192		800
380/95R38 147A8/147B TL AGRIBIB	836033	65207	507	20	1689	66	5034	198		800
420/85R38 149A8/149B TL AGRIBIB 2	048439		552	22	1690	67	5035	198	44	800
480/70R38 145D TL OMNIBIB	936570	28503	626	25	1694	67	5030	198	44	800
IF 710/60R34 164D TL AXIOBIB	712503	67777	900	35	1696	67	5030	198		825
VF 600/60R38 151D TL XEOBIB	349257	80626	767	30	1698	67	5023	198	44	800
VF 380/95R38 154A8/154B TL YIELDBIB	873023	47225	510	20	1703	67	5044	199	44	800
650/65R34 161D/157E TL ROADBIB	330378	35720	825	32	1707	67	5098	201		825
VF 650/65 R34 170D/167E TL AXIOBIB 2	101906	79000	831	33	1710	67	5047	199		825
620/75R30 168A8/168B TL MEGAXBIB	753673	63928	801	32	1710	67	5083	200	44	800
IF 650/75R30 166D TL AXIOBIB	828322	96826	838	33	1721	68	5071	200	45	825
IF 650/65R34 161D TL AXIOBIB	711975	26241	831	33	1721	68	5099	201		825
650/65R34 161D/157E TL MACHXBIB	817386	93805	825	32	1726	68	5133	202		825
VF 710/60R34 173D/169E TL AXIOBIB 2	757609	99540	900	35	1727	68	5093	201		825
VF 650/60R38 155D TL XEOBIB	454365	80851	831	33	1735	68	5108	201	45	825
VF 320/90R46 165D TL SPRAYBIB	684579	18963	438	17	1736	68	5350	211		825

ROLLING CIRCUMFERENCE CHART

TIRE SIZE AND RANGE	CAI	MSPN	Minimum Dual Spacing		Tire Diameter		Rolling Circumference		RCI	SRI
			mm	inches	mm	inches	mm	inches		
			VF 650/60R38 170D/167E TL AXIOBIB 2	908973		831	33	1742		
340/85R46 150A8/150B TL AGRIBIB RC	846786	94547	462	18	1747	69	5227	206	45	825
520/70R38 150D TL OMNIBIB	833744	28089	670	26	1766	70	5229	206	45	825
600/65R38 153D TL MULTIBIB	228045	29767	760	30	1768	70	5229	206	45	825
18.4 R38 151A8/148B TL AGRIBIB	100097	63603	611	24	1770	69	5267	207	45	825
800/60R32 IMP 185D TL CARGOXBIB HIGH FLOTATION	322432		1032	41	1800	71	5300	209		875
VF 710/60R38 160D TL XEOBIB	324138	81759	900	35	1814	71	5356	211	46	875
620/75R34 170A8/170B TL MEGAXBIB	325025	83734	801	32	1814	71	5398	213		825
650/75R32 172A8/172B TL MEGAXBIB 2	642277	38157	875	34	1817	72	5400	213		875
650/65R38 157D TL MULTIBIB	292904	12871	825	32	1819	72	5380	212	46	875
650/75R32 172A8/172B TL MEGAXBIB	468227	46686	875	34	1825	72	5423	214	45	875
IF 650/65R38 169D TL AXIOBIB	508421	87017	831	33	1826	72	5446	214		875
650/75R32 167A8/167B TL AGRIBIB 2	533727		875	34	1827	72	5395	212	45	875
650/65 R38 163D TL MULTIBIB PLUS	476461	41949	825	33	1829	72	5425	214	46	875
580/70R38 155D TL OMNIBIB	001240	31198	743	29	1836	72	5440	214	46	875
VF 480/80R42 176D TL SPRAYBIB	929553	13814	626	25	1838	72	5471	215	46	875
800/65 R32 178A8/178B TL MEGAXBIB 2	135425	87985	1008	40	1839	72	5471	215	46	875
VF 650/60 R42 157D TL XEOBIB	220583	10918	831	33	1840	72	5441	214	46	875
800/65R32 178A8/178B TL MEGAXBIB	521809	49342	1008	40	1840	72	5459	215	46	875
480/80R42 156A8/156B TL AGRIBIB 2	539386	05745	626	25	1840	72	5470	215	46	875
IF 380/90 R46 165A8/165B TL AGRIBIB RC	120462	84037	510	20	1841	72	5513	217	46	925
VF 380/90 R46 173D TL SPRAYBIB	198604	27358	510	20	1842	72	5530	218	46	925
VF 380/90 R46 CFO 173D/169E TL SPRAYBIB	007760	20857	510	20	1843	72	5504	217	46	925
IF 710/60 R38 172D TL AXIOBIB	220975	69189	900	35	1844	72	5486	216		875
VF 320/90R50 166D TL SPRAYBIB	946508	99896	438	17	1844	73	5531	218		925
320/90R50 150A8/150B TL AGRIBIB RC	130813	95098	434	17	1847	73	5539	218	46	925
520/85R38 160A8/160B TL AGRIBIB 2	882358	05183	670	26	1849	73	5493	216	46	875
20.8R38 159A8/156B TL AGRIBIB	813266	17548	684	27	1850	73	5506	217	46	875
420/80R46 151A8/151B TL AGRIBIB 2	885138		552	22	1854	73	5524	217	46	925
IF 800/65R32 CFO 178A8/178B TL CEREXBIB	651074	39571	1006	40	1855	73	5493	216	46	875
IF 800/65R32 CFO+ 181A8 TL CEREXBIB 2	987406	25367	1006	40	1855	73	5501	217		875
520/85R38 155A8/155B TL AGRIBIB	303668	43308	670	26	1855	73	5529	218	46	875
IF 320/90 R50 158A8/158B TL AGRIBIB RC	125798	00912	438	17	1856	73	5544	218	46	925
1050/50R32 184A8/184B TL MEGAXBIB	829536	28613	1310	52	1856	73	5510	217	46	875
620/70R38 170A8/170B TL MEGAXBIB 2	126128		801	32	1857	73	5548	218		875
480/80R42 156A8/156B TL AGRIBIB	404096	03395	626	25	1858	73	5538	218	46	875

ROLLING CIRCUMFERENCE CHART

TIRE SIZE AND RANGE	CAI	MSPN	Minimum Dual Spacing		Tire Diameter		Rolling Circumference		RCI	SRI
			mm	inches	mm	inches	mm	inches		
620/70R38 170A8/170B TL MEGAXBIB	476088	99512	801	32	1864	73	5557	219	46	875
380/90R46 157A8/157B TL AGRIBIB RC	799905	38865	507	20	1864	73	5583	220	46	925
680/75R32 164A8/161B TL MACHXBIB	123582	80305	862	34	1865	73	5512	217	46	875
1050/50R32 178A8/172D TL MEGAXBIB 2	424273	12011	1310	52	1866	73	5537	218		875
420/80R46 151A8/148B TL AGRIBIB	122770	58733	552	22	1872	74	5555	219	46	925
VF 1000/55R32 CFO 197D/193E TL FLOATXBIB	946690	22389	1258	50	1877	74	5520	217		925
IF 1000/55R32 CFO 191D/188E TL FLOATXBIB	564739		1258	50	1877	74	5540	218		925
VF 710/60R42 176D/173E TL AXIOBIB 2	941770	78256	900	35	1885	74	5574	219		925
900/60R32 181A8/181B TL MEGAXBIB	824122	40581	1114	44	1894	75	5626	221	46	925
900/60 R32 181A8/181B TL MEGAXBIB 2	166896	04361	1114	44	1899	74	5635	222	46	925
710/75R34 178A8/178B TL MEGAXBIB	543107	13589	910	36	1900	75	5637	222	47	925
1050/50R32 178A8 TL MEGAXBIB	236234	94737	1310	52	1902	75	5649	222	46	875
VF 900/60R32 CFO+ 191A8 TL CEREXBIB 2	430737	73624	1120	44	1903	75	5618	221		925
IF 900/60R32 CFO 185A8 TL CEREXBIB	752825	03456	1120	44	1906	75	5643	222		925
710/75R34 178A8/178B TL MEGAXBIB 2	312036	47924	910	36	1909	75	5671	223	47	925
VF 710/60 R42 161D TL XEOBIB	144294	94391	900	35	1920	75	5675	223	47	925
VF 650/65R42 174D/171E TL AXIOBIB 2	387916	43835	831	33	1920	76	5680	224	47	925
800/70R32 181A8/181B TL MEGAXBIB 2	366785		1008	40	1927	76	5737	226		925
IF 1000/55 R32 CFO 188A8 TL CEREXBIB	131720	22858	1258	50	1931	76	5758	227		925
650/65 R42 158D TL MULTIBIB	167733	38881	825	33	1931	76	5722	225	47	925
650/65R42 165D/161E TL ROADBIB	075643	37067	825	32	1932	76	5693	224		925
VF 480/80R46 164A8/164B TL YELDBIB	842300	10807	626	25	1933	76	5732	226	47	925
IF 680/85R32 CFO 179A8/179B TL CEREXBIB	932041	18128	869	34	1935	76	5711	225	47	925
380/90R50 151A8/151B TL AGRIBIB RC	036849	15852	507	20	1935	76	5813	229	47	975
650/65 R42 165D TL MULTIBIB PLUS	512785	37632	825	33	1936	76	5752	227	47	925
800/70R32 181A8/181B TL MEGAXBIB	695992	68880	1008	40	1936	76	5725	225		925
520/85R42 162A8/162B TL MEGAXBIB	645194	15488	670	26	1937	76	5783	228	47	925
VF 480/80R46 177D TL SPRAYBIB	159186	21151	626	25	1943	76	5790	228	47	925
520/85R42 157A8/157B TL AGRIBIB	122791	63687	670	26	1945	77	5771	227	47	925
480/80R46 158A8/158B TL AGRIBIB 2	622709	00639	626	25	1945	77	5804	229	47	925
650/75 R38 169D/165E TL MACHXBIB	311026	70375	825	33	1948	76	5786	228	47	925
480/80R46 158A8/158B TL AGRIBIB	637231	94069	626	25	1948	77	5874	231	47	925
IF 320/90 R54 159A8/159B TL AGRIBIB RC	467712	59155	438	17	1949	76	5848	230	47	975
IF 800/70R32 CFO+ 185A8 TL CEREXBIB 2	789156	71535	1004	40	1950	77	5800	228		925
VF 320/90R54 168D TL SPRAYBIB	044008	45449	438	17	1950	77	5843	230	47	975
320/90R54 151A8/151B TL AGRIBIB RC	272304	96185	434	17	1950	77	5852	230	47	975

ROLLING CIRCUMFERENCE CHART

TIRE SIZE AND RANGE	CAI	MSPN	Minimum Dual Spacing		Tire Diameter		Rolling Circumference		RCI	SRI
			mm	inches	mm	inches	mm	inches		
			VF 380/90 R50 CFO 175D/171E TL SPRAYBIB	340728	16655	510	20	1951		
VF 380/90R50 175D TL SPRAYBIB	722276	28608	510	20	1951	77	5836	230	47	975
IF 380/90 R50 167A8/167B TL AGRIBIB RC	212359	88459	510	20	1953	77	5841	230	47	975
620/70R42 160D TL OMNIBIB	989457	31015	801	32	1953	77	5781	228	47	925
VF 520/85R42 CFO 177A8 TL CEREXBIB	934265	78620	682	27	1953	77	5807	229	47	925
VF 520/85R42 CFO+ 177A8 TL CEREXBIB 2	270459	15337	682	27	1953	77	5807	229		925
IF 800/70R32 CFO 182A8/182B TL CEREXBIB	525718	18258	1004	40	1958	77	5788	228		925
520/85R42 162A8/162B TL AGRIBIB 2	405859	13435	670	26	1958	77	5810	229	47	925
620/70 R42 166A8/166B TL MEGAXBIB	100268	15145	801	32	1961	77	5857	231	47	925
IF 680/75R38 180A8 TL CEREXBIB	833220	02720	830	33	1965	77	5823	229		975
900/50R42 168D TL MACHXBIB	832458	03779	1114	44	1970	78	5826	229	47	975
710/70R38 171D TL MACHXBIB	708197	30751	910	36	1973	78	5804	229	47	925
IF 680/80R38 CFO+ 182A8 TL CEREXBIB 2	953912	20691	870	34	2020	80	6030	237		975
VF 900/60 R38 CFO+ 193A8 TL CEREXBIB 2	853285	68766	1144	45	2027	79	5987	236		975
VF 320/105 R 54 172D TL SPRAYBIB	624140	48439	439	17	2028	80	6066	239	48	1000
710/70R42 173D/170E TL ROADBIB	885975	27650	910	36	2028	80	6025	237		975
VF 900/60R38 CFO+ 193A8 TL CEREXBIB 2	439024	31193	1144	45	2029	80	5993	236		975
IF 900/60R38 CFO 188A8 TL CEREXBIB	853436	03936	1144	45	2029	80	6017	237	48	975
IF 900/60R38 CFO 184A8 TL CEREXBIB	296920	14429	1144	45	2033	80	6017	237	48	975
VF 900/60R38 CFO 196D/192E TL FLOATXBIB	098689	02123	1144	45	2033	80	6041	238		975
620/70 R46 162D TL MACHXBIB	131721	01175	801	32	2038	80	6041	238	48	975
VF 480/80R50 166A8/166B TL YELDBIB	309830	02098	626	25	2039	80	6034	238	48	975
VF 580/85R42 CFO+ 183A8 TL CEREXBIB 2	844076	45547	754	30	2040	80	6040	238		975
VF 480/80R50 179D TL SPRAYBIB	431251	50045	626	25	2045	81	6101	240	48	975
IF 800/70R38 CFO 184A8/184B TL CEREXBIB	646846	39234	1004	40	2048	81	6072	239	48	975
650/85R38 173A8/173B TL MEGAXBIB	173491	19212	825	32	2048	81	6100	240	48	975
VF 380/90R54 176D TL SPRAYBIB	816598	47923	510	20	2049	81	6131	241	48	1025
IF 650/85R38 179D TL AXIOBIB	084900	97250	821	32	2050	81	6078	239	48	975
520/85R46 158A8/155B TL AGRIBIB	122780	57479	670	26	2050	81	6088	240	48	975
480/80R50 159A8/159B TL AGRIBIB 2	263049	41183	626	25	2050	81	6116	241	48	975
IF 800/70R38 CFO 187A8 TL CEREXBIB	445898	24897	1004	40	2051	81	6079	239	48	975
IF 800/70R38 CFO+ 187A8 TL CEREXBIB 2	610997	25474	1004	40	2051	81	6079	239	48	975
VF 420/95R50 177D TL SPRAYBIB	085405	82545	554	22	2052	81	6118	241	48	1025
380/90R54 152A8/152B TL AGRIBIB 2	075615	28485	507	20	2054	81	6129	241	48	1025
480/80R50 159A8/159B TL AGRIBIB	471947	94576	626	25	2056	81	6135	242	48	975
520/85 R46 164A8/164B TL AGRIBIB 2	120922	17697	670	26	2059	81	6110	241	48	975

ROLLING CIRCUMFERENCE CHART

TIRE SIZE AND RANGE	CAI	MSPN	Minimum Dual Spacing		Tire Diameter		Rolling Circumference		RCI	SRI
			mm	inches	mm	inches	mm	inches		
VF 420/95 R50 CFO 179D/175E TL SPRAYBIB	358639	53951	554	22	2059	81	6140	242	48	1025
IF 710/70R42 179D TL AXIOBIB	771752	99783	910	36	2062	81	6115	241	48	975
650/85 R38 173A8/173B TL MACHXBIB	118628	89462	825	33	2063	81	6092	240	48	975
VF 710/70 R42 179D/175E TL EVOBIB	707510	34208	910	36	2063	81	6069	239		975
VF 650/85R38 182D/179E TL AXIOBIB 2	655949		845	33	2063	81	6088	240		975
800/70R38 173D TL MACHXBIB	887730	29390	1008	40	2066	81	6093	240	48	975
VF 710/70R42 182D/179E TL AXIOBIB 2	523668		910	36	2066	81	6104	240	48	975
IF 800/70R38 179D TL AXIOBIB	528166	99142	1004	40	2067	81	6089	240	48	975
VF 800/70 R38 187D/184E TL AXIOBIB 2	136377	86394	1004	40	2072	81	6078	239		975
710/70 R42 173D/169E TL ROADBIB	749845	03331	910	36	2076	81	6177	243	48	975
710/70R42 173D TL MACHXBIB	790388	31962	910	36	2088	82	6195	244	48	975
VF 710/70R42 CFO+ 188A8 TL CEREXBIB 2	499992	60118	910	36	2097	83	6207	244		975
IF 710/70R42 CFO 182A8 TL CEREXBIB	003912	61530	910	36	2097	83	6230	245		975
VF 900/60R42 CFO+ 195A8 TL CEREXBIB 2	856296	03717	1108	44	2118	83	6281	247	0	1025
IF 900/60R42 186D TL AXIOBIB	111950	82481	1144	45	2123	84	6304	248	49	1025
710/75R42 175D/171E TL ROADBIB	378080	14014	910	36	2143	84	6368	251		1025
IF 800/70R42 CFO+ 189A8 TL CEREXBIB 2	818789	91180	1004	40	2151	85	6387	251	49	1025
VF 710/75R42 184D/180E TL AXIOBIB 2	259635	01608	910	36	2153	85	6370	251	49	1025
VF 900/60R42 189D/185E TL AXIOBIB 2	428922	17679	1108	44	2158	85	6357	250	49	1025
710/75R42 175D/171E TL MACHXBIB	015540	13444	910	36	2158	85	6408	252		1025
IF 710/85R38 178D TL AXIOBIB	992951	99013	918	36	2159	85	6365	251	49	1025
IF 710/75R42 176D TL AXIOBIB	037489	25479	910	36	2161	85	6395	252	49	1025
VF 650/85R42 183D/180E TL AXIOBIB 2	530764	06000	845	33	2164	85	6393	252	49	1025
480/95R50 164A8/164B TL AGRIBIB	491183	54736	626	25	2175	86	6484	255		1075
VF 750/70R44 186D/183E TL AXIOBIB 2	681569		941	37	2180	86	6438	253		1025
VF 480/95R50 170A8/170B TL YIELDBIB	252129	65206	626	25	2186	86	6464	254	49	1075
IF 750/75R46 186D TL AXIOBIB	487001	07217	941	37	2287	90	6819	268	50	1125
IF 900/65 R46 190D TL AXIOBIB	162365	36973	1108	44	2322	91	6888	271	50	1125

LOAD / PRESSURE CHART FOR MUT TIRES

LOAD/PRESSURE TABLES AT 10 AND 30 KM/H FOR MICHELIN ULTRAFLEX TECHNOLOGY (MUT) TRACTOR TIRES

The remote inflation breakthrough for the agricultural market required changes to the Improved Flexion (IF) and Very high Flexion (VF) standards, something that was achieved in February 2019 (ETRTO). Some tire casings are PFO (Pressure Field Operation), a standard that allows tire manufacturers to increase the load capacity of their tires for field use.



The new load/pressure curves at 10 and 30 km/h for MUT tractor tires help to adapt tire pressures to the intended use and context. Combined with a remote inflation system that optimizes these variations in real-time, MICHELIN ULTRAFLEX tires can now offer their very best performance!

- At low pressure in the field, the soil is protected and productivity is optimal.
- At higher pressures on-road, speed is the objective while controlling fuel consumption and ensuring safety and driving comfort.



THE PROOF IN FIGURES

(Example of a calculation based on MACHXBIB (standard), AXIOBIB (IF) and AXIOBIB 2 (VF) – Size 710/70 R42)

PRESSURE DECREASE POSSIBLE WITH A LOAD OF 5500 KG

(bar)	10 km/h	30 km/h	65 km/h
Standard	1	1.3	1.6
IF	 1	 1.1	 1.2
VF	0.8	0.9	1



LOAD INCREASE POSSIBLE WITH A PRESSURE OF 1.2 BAR

(kg)	10 km/h	30 km/h	65 km/h
Standard	6200	5200	4500
IF	 6200	 5700	 5500
VF	7000	6400	6300

PFO = PRESSURE FIELD OPERATION

MICHELIN has always been an active promoter of standards that enable its customers to benefit from the latest technological revolutions! PFO is a new ETRTO standard to provide additional load for IF/VF tractor tires when speed is reduced. PFO is an option. It does not change the initial LI/SI or the CAI.

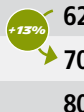
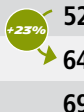
LOAD INCREASE POSSIBLE WITH A PRESSURE OF 1.2 BAR

Max PFO	10 km/h	30 km/h	65 km/h
Standard	6200	5200	4500
VF	 7000	 6400	 6300
VF PFO	8000	6900	6300



CENTRAL TIRE INFLATION SYSTEM

THE RIGHT PRESSURE AT THE RIGHT TIME



INCREASED SOIL PROTECTION

+4% YIELD ⁽¹⁾



INCREASED PRODUCTIVITY

+30% TRACTION ⁽²⁾



INCREASED PROFITABILITY

+33% FUEL SAVINGS
IN THE FIELD ⁽³⁾



CONTROLLABLE
FROM THE ISOBUS DISPLAY + **IN MOTION**
INFLATION & DEFLATION

THE ADVANTAGES OF PTG SYSTEMS

THE SAFEST SYSTEM ON THE MARKET

- No risk of deflation if the hoses are torn off thanks to the valves equipped with non-return flaps



EASY PRESSURE CONTROL

- Only 2 clicks on the vehicles ISOBUS display, thanks to the 18 storable profiles

COMPATIBLE WITH ALL BRANDS

- PTG's CTIS systems are suitable for all types and brands of vehicles, and are compatible with all tire brands



LIMITED MAINTENANCE

- Longevity of the elements, from the design the solution has been thought to limit the need for maintenance: The rotative joints lifespan is above 10 000 hours

(1) 4% increase in yield proven by the Harper Adams University study since 2014 for Ultraflex technology. (2) Internal study on MICHELIN EVOBIB vs MICHELIN AXIOBIB tires. (3) Based on a field study with a Fendt 939 tractor equipped with MICHELIN AXIOBIB IF650/65R34 and MICHELIN AXIOBIB IF710/75R42 tires and a three-axle Stewart trailer equipped with MICHELIN CARGOXBIB HF 600/55R26.5 tires also based on a study with a Fendt 724 Vario tractor equipped with MICHELIN MACHXBIB 710/55 R30 and MICHELIN MACHXBIB 900/50 R42 tires and a GYRAX BMXL 240 trailer equipped with MICHELIN CARGOXBIB HF 710/50 R26.5 tires.



**SEE HOW MUCH
YOU CAN GAIN**

[HTTPS://APP-AGRO.COM/](https://app-agro.com/)

HOW TO CHOOSE AN AGRICULTURAL TIRE?

1

CHOOSE THE TIRE DIAMETER ACCORDING TO THE POWER AND TO THE MECHANICAL LEAD

- The tire overall diameter is key to transmit power to the ground.
- To optimize traction performance, it is important to choose the biggest diameter approved by the constructor.
- Agricultural tires are classified by equivalent diameter or Speed Radius Index (SRI)
- Possible to change some specifications like tire width, load capacity, rim diameter but it is important to keep the same overall diameter, to keep at least the same tire overall diameter
- The diameter must be approved by the machine's manufacturer

Concerning the Mechanical Lead, refer to Michelin Agriculture User Guide

2

CHOOSE THE TIRE WIDTH

- The tire width depends on the use and the customer's needs
- Narrow > To pass between rows of crops (270 to 480mm)
- Intermediate > More versatile (from 520 to 650)
- Wide > Soil protection (from 710 to 900)
- With the same overall diameter and section width, different tire size or technology could be proposed depending on the tractors power and the load capacity targeted

3

CHOOSE THE LOAD CAPACITY & TECHNOLOGY

- Select the load index according to the customer's needs and uses
- Choose the technology
- IF=+20% load capacity vs standard or pressure reduction for the same load
- VF=+40% load capacity vs standard or pressure reduction for the same load
- For the same diameter and width, the tire could be adapted to the tractor's power

4

CHOOSE THE PATTERN & THE BRAND

- Some tire sizes come with different tread patterns
- Tires dedicated for intensive road or municipality uses
- Brand choice is important for warranty programs, local support, to add value to your machine

1

CHOOSE THE TIRE DIAMETER ACCORDING TO THE POWER

2

CHOOSE THE TIRE WIDTH

3

CHOOSE THE LOAD CAPACITY AND TECHNOLOGY

4

CHOOSE THE PATTERN AND THE BRAND

1

1.95M

4**2****4****2****4****2****4****2****3**

520/85R42 MICHELIN AGRIBIB2
162A8/B
Load @40kph & 2.4b
4750kg

620/70R42 MICHELIN OMNIBIB
160D
Load @40kph & 1.6b
4930kg

650/65R42 MICHELIN MULTIBIB
158D
Load @40kph & 1.6b
4650kg

VF710/60R42 MICHELIN XEOBIB
161D
Load @40kph & 1b
4625kg

1

1.95M

4**2****4****2****4****2****4****2****3**

650/65R42 MICHELIN ROADBIB
165D/161E
Load @40kph & 2.4b
5640kg

710/70R38 MICHELIN MACHXBIB
171D
Load @40kph & 2.4b
6735kg

VF650/65R42 MICHELIN AXIOBIB2
174D/171E
Load @40kph & 2b
6700kg

VF710/60R42 MICHELIN AXIOBIB2
173D/173E
Load @40kph & 2b
7100kg

TIRE DIMENSIONS

SW Tire section width
R* Static Loaded Radius
OD Overall diameter = 2 R
ø Rim diameter

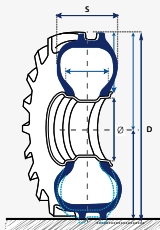

SPECIFIC MARKINGS FOR VERY HIGH TECHNOLOGY TIRES

IF = Improved Flexion

Tires designed to operate at 20% higher rated load than standard metric tires at the same inflation pressure

VF = Very High Flexion

Tires designed to operate at 40% higher rated load than standard metric tires at the same inflation pressure

MICHELIN ULTRAFLEX TECHNOLOGIES



DESIGNED FOR A SOIL PROTECTION

MICHELIN Ultraflex technologies produce a larger footprint, which protects the soil from compaction and rutting. Air and water penetrate more freely. Conditions are therefore improved for maximum crop response.

MORE SAVINGS ON FUEL

The larger footprint considerably increases traction, resulting in a clear reduction in tractor wheel slip, enabling to work faster and save on fuel!

DESIGNED FOR A ENDURANCE AND LONGER SERVICE LIFE

Reinforced sidewalls and special rubber compounds make agricultural tires with MICHELIN Ultraflex technologies extremely strong, even at lower pressure.

Tire cross-section

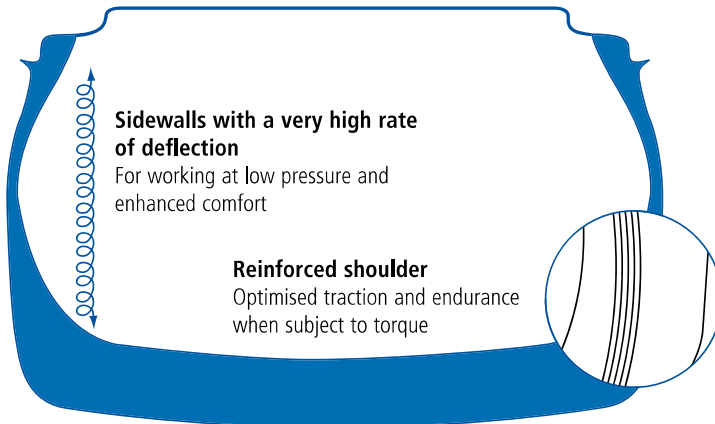

Sidewalls with a very high rate of deflection

For working at low pressure and enhanced comfort

Reinforced shoulder

Optimised traction and endurance when subject to torque

Flat crown

Enlarged footprint to protect soil and deliver maximum traction



MICHELIN EVOBIB

THE 2-IN-1 TIRE

NEW



FOR HIGH-POWERED TRACTOR
Works best with CTIS (Central Tire Inflation System)



«2 IN 1» TIRES TECHNOLOGY
adaptive design on the road or in the fields
VF Very High Flexion⁽²⁾
Designed to be used with **CTIS** (Central Tire Inflation System)



SOIL PROTECTION
• **A maximized footprint**
+47% of contact patch area variation⁽¹⁾ from road pressure to field pressure. It's twice more than a VF tire with a lug tread pattern.



TRACTION
• **Same traction as lug profile**
+15% more traction⁽³⁾ than a VF hybrid competitor tire. And same traction capacity as a VF lug profile in normal field conditions.



ENERGY SAVING
• **Cost reduction**
Up to -7% of fuel savings⁽⁴⁾ vs a hybrid VF competitor tire. It means 2 litres saved by hour⁽⁴⁾.

(1) Comparison carried out in Ladoux - France in September 2021, between MICHELIN EVOBIB tire and MICHELIN AXIOBIB 2 tire; Dimension: VF 710/70 R42; Load per tire: 5,300 kg; Road speed: 65 km/h; Field speed: 30 km/h. (2) The Very High Flexion (VF) standard allows the tire to carry 40% more load than a standard tire at the same pressure. (3) Comparison carried out in Pagnant - France in November 2021, between MICHELIN EVOBIB tire and VF hybrid tread pattern competitor tire and MICHELIN AXIOBIB 2 tire; Dimension: VF 710/70 R42; Load per tire: 4,300 kg; pressure recommended by manufacturers; Soil: wet corn stubble. (4) Comparison carried out in Ladoux - France in November 2021, between MICHELIN EVOBIB tire and VF hybrid tread pattern competitor tire. Vehicle: tractor; Dimension: VF 710/70 R42; Load per tire: 4,300 kg; Pressure recommended by manufacturers; Average of fuel consumption calculated after 10 laps of 8km.

SIZES

VF 600/70R30 165D/161E TL **NEW**

VF 710/70R42 179D/175E TL **NEW**

MICHELIN EVOBIB

Tire specifications and pressure table (bar & psi). Load per tire in kg*

Ø inches	Description	CAI	e mm	D mm	R' mm	RC mm	Recommended Rim		Acceptable Rim	Tube (Code)	75% internal volume (litres)	Tread depth (mm)
30	VF 600/70R30 165D/161E TL NEW	147406	597	1598	684	4696	DW21B(A)		DW20B(A)	737	468	53
Bar	0.6	0.8	1	1.2	1.4	1.6	1.8	2	2.2	2.3	2.4	
Psi	9	12	15	17	20	23	26	29	32	33	35	
Road		2015	2335	2655	3000	3280	3515	3750	3985	4215	5150	
Field		2855	3315	3825	4335	4795	5255					

Ø inches	Description	CAI	e mm	D mm	R' mm	RC mm	Recommended Rim		Acceptable Rim	Tube (Code)	75% internal volume (litres)	Tread depth (mm)
42	VF 710/70R42 179D/175E TL NEW	707510	716	2063	887	6069	DW25B(A)		DW23B(A) MW25B(A)	802	867	54
Bar	0.6	0.8	1	1.2	1.4	1.6	1.8	2	2.2	2.3	2.4	
Psi	9	12	15	17	20	23	26	29	32	33	35	
Road		2850	3315	3780	4245	4730	5200	5655	6010	6195	7750	
Field		4335	5100	5765	6425	7165	7905					

***IMPORTANT:**

The inflation pressure must always be appropriate for the load per tire, the speed of travel and the work to be done. Our recommendations above are provided subject to changes made after the date of publication of these tables. Technical data is subject to change without prior notice.

- When using single tire configuration, add 0.4 bar for use on slopes of more than 20%
- (R) Road Pressure
- (C) Field Pressure



MICHELIN ROADBIB

**THE SOLUTION
FOR HEAVY ROAD USE**



+5% FUEL SAVINGS⁽¹⁾

- A wide footprint combined with an optimized tread depth provides
- Low rolling resistance and thus reduced fuel consumption



LONG LIFE

- Extraordinary performance in terms of longevity:
+20% more rubber to the ground vs. MICHELIN MACHXBIB
- Exclusive design: new tread pattern
- Directional tires



GREAT COMFORT

- Smooth central rib improves comfort on roads
- Reduced space between patterns limits cabin vibrations (compared to traditional sculptures)
- Quiet running tire - outdoors and indoors



HANDLING & SAFETY

- Improved ride quality thanks to a new sculpture similar to that of a truck tire
- Good tire adhesion on wet roads thanks to vertical evacuation paths

(1) versus Premium competitive tire with classic lugs (650/65 R42 & 540/65 R30). Fuel consumption test carried out in June 2020 - Ladoux/France Based on tests performed at Michelin Test Facility (Ladoux, France) on the 4th of August 2020 following Michelin Cor1501.1 test protocol, using a Fendt 724 + Joskin TransCAP BC150 6500/22 loaded to have a 40-ton convoy fitted with MICHELIN CARGOXBIB 650/55R26.5 comparing a Trelleborg TM800 High Speed same size.

SIZES

540/65R30 150D/146E TL

600/70R30 158D/154E TL **NEW**

600/70R30 158D/155E TL

650/60R34 159D/155E TL

650/65R34 161D/157E TL

650/65R42 165D/161E TL

710/70R42 173D/169E TL **NEW**

710/70R42 173D/170E TL

710/75R42 175D/171E TL

MICHELIN ROADBIB

Tire specifications and pressure table (bar & psi). Load per tire in kg*

Ø inches	Description	CAI	e mm	D mm	R' mm	RC mm	Recommended Rim		Acceptable Rim		Tube (Code)	75% internal volume (litres)	Tread depth (mm)
30	540/65R30 150D/146E TL	274757	547	1464	655	4365	DW16L		W18L		754	332	32
Bar	0.4	0.6	0.8	1	1.2	1.4	1.6	1.8	2	2.2	2.4	2.6	2.8
Psi	6	9	12	15	17	20	23	26	29	32	35	38	41
10 km/h	1930	2185	2445	2700	3000	3300	3600	3900	4200	4405	4615	4820	5025
30 km/h	1480	1755	2030	2310	2585	2860	3135	3315	3495	3675	3855		
40 km/h		1695	1955	2210	2470	2725	2985	3155	3330	3500	3670		
50 km/h		1630	1875	2120	2370	2615	2860	3025	3190	3355	3520		
65 km/h		1800	2030	2265	2495	2725	2880	3040	3195	3350			
70 km/h		1640	1850	2060	2270	2480	2610	2740	2870	3000			

Ø inches	Description	CAI	e mm	D mm	R' mm	RC mm	Recommended Rim		Acceptable Rim		Tube (Code)	75% internal volume (litres)	Tread depth (mm)		
30	600/70R30 158D/154E TL NEW	264539	592	1617	726	4800	DW20B(A)		DW18L DW21B (A)		737	468	42		
Bar	0.4	0.5	0.6	0.7	0.8	1	1.2	1.4	1.6	1.8	2	2.2	2.4	2.6	2.8
Psi	6	8	9	11	12	15	17	20	23	26	29	32	35	38	41
10 km/h	2290	2760	2705	3265	3125	3540	3955	4375	4790	5210	5625	5815	6000	6190	6375
30 km/h	1925	2125	2325	2525	2725	3125	3525	3925	4325	4480	4640	4795	4950		
40 km/h			2200	2385	2565	2935	3300	3670	4035	4205	4375	4545	4715		
50 km/h			2110	2285	2460	2815	3165	3515	3865	4030	4195	4355	4520		
65 km/h				2360	2680	3000	3325	3650	3800	3950	4100	4250			
70 km/h				2150	2440	2730	3025	3320	3430	3535	3645	3750			

Ø inches	Description	CAI	e mm	D mm	R' mm	RC mm	Recommended Rim		Acceptable Rim		Tube (Code)	75% internal volume (litres)	Tread depth (mm)
30	600/70R30 158D/155E TL	217911	610	1569	684	4630	DW20B (A)		DW18L DW21B (A)		737	468	40
Bar	0.4	0.6	0.8	1	1.2	1.4	1.6	1.8	2	2.2	2.4	2.6	2.8
Psi	6	9	12	15	17	20	23	26	29	32	35	38	41
10 km/h	1930	2185	2445	2700	3000	3300	3600	3900	4200	4405	4615	4820	5025
30 km/h	1480	1755	2030	2310	2585	2860	3135	3315	3495	3675	3855		
40 km/h		1695	1955	2210	2470	2725	2985	3155	3330	3500	3670		
50 km/h		1630	1875	2120	2370	2615	2860	3025	3190	3355	3520		
65 km/h		1800	2030	2265	2495	2725	2880	3040	3195	3350			
70 km/h		1640	1850	2060	2270	2480	2610	2740	2870	3000			

* Refer to the notes at the end of the tables of this range

MICHELIN ROADBIB

Tire specifications and pressure table (bar & psi). Load per tire in kg*

Ø inches	Description	CAI	e mm	D mm	R' mm	RC mm	Recommended Rim		Acceptable Rim		Tube (Code)	75% internal volume (litres)	Tread depth (mm)
34	650/60R34 159D/155E TL	556249	649.6	1651	749	4915	DW20B (A)		DW21B (A) DW23B (A)		823	500	39
Bar	0.4 0.6 0.8	1	1.2	1.4	1.6	1.8	2	2.2	2.4	2.6	2.8		
Psi	6 9 12	15	17	20	23	26	29	32	35	38	41		
10 km/h	1930 2185 2445	2700	3000	3300	3600	3900	4200	4405	4615	4820	5025		
30 km/h	1480 1755 2030	2310	2585	2860	3135	3315	3495	3675	3855				
40 km/h	1695 1955 2210	2470	2725	2985	3155	3330	3500	3670					
50 km/h	1630 1875 2120	2370	2615	2860	3025	3190	3355	3520					
65 km/h	1800 2030 2265	2495	2725	2880	3040	3195	3350						
70 km/h	1640 1850 2060	2270	2480	2610	2740	2870	3000						

Ø inches	Description	CAI	e mm	D mm	R' mm	RC mm	Recommended Rim		Acceptable Rim		Tube (Code)	75% internal volume (litres)	Tread depth (mm)
34	650/65R34 161D/157E TL	330378	678.8	1701	769	5060	DW20B (A)		DW21B (A) DW23B (A)		823	555	39
Bar	0.4 0.6 0.8	1	1.2	1.4	1.6	1.8	2	2.2	2.4	2.6	2.8		
Psi	6 9 12	15	17	20	23	26	29	32	35	38	41		
10 km/h	2700 3090 3475	3865	4290	4720	5145	5575	6000	6235	6470	6705	6940		
30 km/h	2070 2470 2865	3265	3660	4055	4455	4670	4890	5105	5320				
40 km/h	2385 2755 3130	3500	3875	4245	4450	4655	4860	5065					
50 km/h	2290 2645 3000	3360	3715	4070	4265	4465	4660	4855					
65 km/h	2575 2900 3225	3550	3875	4065	4250	4440	4625						
70 km/h	2345 2640 2935	3230	3525	3675	3825	3975	4125						

Ø inches	Description	CAI	e mm	D mm	R' mm	RC mm	Recommended Rim		Acceptable Rim		Tube (Code)	75% internal volume (litres)	Tread depth (mm)
42	650/65R42 165D/161E TL	075643	633	1932	870	5733	DW20B (A)		DW21B(A) DW23B (A)		802	643	43
Bar	0.4 0.6 0.8	1	1.2	1.4	1.6	1.8	2	2.2	2.4	2.6	2.8		
Psi	6 9 12	15	17	20	23	26	29	32	35	38	41		
10 km/h	3000 3400 3800	4200	4675	5145	5620	6090	6565	6855	7145	7435	7725		
30 km/h	2300 2730 3165	3595	4025	4460	4890	5150	5410	5665	5925				
40 km/h	2660 3060 3460	3855	4255	4655	4900	5150	5395	5640					
50 km/h	2550 2935 3315	3700	4080	4465	4700	4940	5175	5410					
65 km/h	2800 3165 3525	3890	4250	4475	4700	4925	5150						
70 km/h	2550 2880 3210	3540	3870	4060	4250	4435	4625						

* Refer to the notes at the end of the tables of this range

MICHELIN ROADBIB

Tire specifications and pressure table (bar & psi). Load per tire in kg*

Ø inches	Description	CAI	e mm	D mm	R' mm	RC mm	Recommended Rim		Acceptable Rim		Tube (Code)	75% internal volume (litres)	Tread depth (mm)
42	710/70R42 173D/169E TL NEW	749845	720	2076	938	6177	DW23B (A)		DW25B (A)		802	867	38
Bar	0.4 0.5 0.6	0.7	0.8	1	1.2	1.4	1.6	1.8	2	2.2	2.4	2.6	2.8
Psi	6 8 9	11	12	15	17	20	23	26	29	32	35	38	41
10 km/h	3750 4015 4275	4540	4800	5325	6000	6675	7350	8025	8700	8965	9225	9490	9750
30 km/h	2875 3175 3470	3770	4065	4660	5255	5845	6440	6700	6960	7215	7475		
40 km/h		3285 3570	3855	4425	4995	5560	6130	6380	6625	6875	7120		
50 km/h		3150 3425	3695	4240	4785	5335	5880	6120	6355	6590	6825		
65 km/h			3550 4065	4575	5090	5600	5825	6050	6275	6500			
70 km/h			3230 3700	4165	4630	5095	5270	5450	5625	5800			

Ø inches	Description	CAI	e mm	D mm	R' mm	RC mm	Recommended Rim		Acceptable Rim		Tube (Code)	75% internal volume (litres)	Tread depth (mm)
42	710/70R42 173D/170E TL	885975	710	2028	915	6025	DW23B (A)		DW25B (A)		802	867	37
Bar	0.4 0.6 0.8	1	1.2	1.4	1.6	1.8	2	2.2	2.4	2.6	2.8		
Psi	6 9 12	15	17	20	23	26	29	32	35	38	41		
10 km/h	3750 4275 4800	5325	6000	6675	7350	8025	8700	8965	9225	9490	9750		
30 km/h	2875 3470 4065	4660	5250	5845	6440	6700	6960	7215	7475				
40 km/h		3285 3855	4425	4990	5560	6130	6380	6625	6875	7120			
50 km/h		3150 3695	4240	4790	5335	5880	6115	6355	6590	6825			
65 km/h			3550 4065	4575	5090	5600	5825	6050	6275	6500			
70 km/h			3230 3695	4165	4630	5095	5320	5550	5775	6000			

Ø inches	Description	CAI	e mm	D mm	R' mm	RC mm	Recommended Rim		Acceptable Rim		Tube (Code)	75% internal volume (litres)	Tread depth (mm)
42	710/75R42 175D/171E TL	378080	743.8	2140	957	6350	DW23B (A)		DW21B(A) DW25B (A)		802	949	42
Bar	0.4 0.6 0.8	1	1.2	1.4	1.6	1.8	2	2.2	2.4	2.6	2.8		
Psi	6 9 12	15	17	20	23	26	29	32	35	38	41		
10 km/h	3975 4525 5075	5625	6300	6975	7650	8325	9000	9340	9675	10015	10350		
30 km/h	3050 3690 4335	4975	5615	6260	6900	7160	7420	7675	7935				
40 km/h		3560 4160	4765	5365	5970	6570	6815	7065	7310	7555			
50 km/h		3415 3990	4570	5145	5725	6300	6535	6775	7010	7245			
65 km/h			3750 4315	4875	5440	6000	6225	6450	6675	6900			
70 km/h			3415 3925	4440	4950	5460	5635	5805	5980	6150			

***IMPORTANT:**

The inflation pressure must always be appropriate for the load per tire, the speed of travel and the work to be done. Our recommendations above are provided subject to changes made after the date of publication of these tables. Technical data is subject to change without prior notice.

- For plowing and other field applications subject to high torque, use the 30 km/h line.
- When using single tire configuration:
 - add 0.4 bar for use on slopes of more than 20%
 - add 0.4 bar for intensive road use exceeding 50%
- 10 km/h: low torque application only



MICHELIN AXIOBIB 2

HIGH TRACTION CAPACITY FOR HEAVY LOADS



FOR HIGH POWER TRACTORS



VF Very High Flexion



SOIL PROTECTION THE LOWEST PRESSURE ON THE MARKET

thanks to the PFO standard : +14% load at 10km/h versus classic VF competitor tires ⁽¹⁾



MORE TRACTION ⁽¹⁾ : +8% ⁽²⁾ VS Premium Competitor



Potential increase in yields of **up to 4% year ⁽³⁾**

(1) According to the competitor databooks even if your tires do not have the PFO marking on the sidewall. Refer to Load / Pressure chart for MUT tires page

(2) Michelin tests carried out in November 2021 – Pagnant- France, John Deere 7310R, on wet corn stubbles.

(3) Study led by Harper Adams University, Newport, United Kingdom - from 2014 to 2016

SIZES

VF 540/65R30 158D/155E TL PFO

VF 600/60R30 162D/159E TL PFO

VF 600/70R30 168D/165E TL PFO

VF 620/75R30 172D/169E TL PFO

VF 650/60R34 168D/165E TL PFO

VF 650/65R34 170D/167E TL PFO

VF 710/60R34 173D/169E TL PFO

VF 650/60R38 170D/167E TL PFO

VF 650/85R38 182D/179E TL PFO

VF 800/70R38 187D/184E TL PFO

VF 650/65R42 174D/171E TL PFO

VF 650/85R42 183D/180E TL PFO

VF 710/60R42 176D/173E TL PFO

VF 710/70R42 182D/179E TL PFO

VF 710/75R42 184D/180E TL PFO

VF 900/60R42 189D/185E TL PFO

VF 750/70R44 186D/183E TL PFO

MICHELIN AXIOBIB 2

Tire specifications and pressure table (bar & psi). Load per tire in kg*

Ø inches	Description	CAI	e mm	D mm	R' mm	RC mm	Recommended Rim		Acceptable Rim		Tube (Code)	75% internal volume (litres)	Tread depth (mm)		
30	VF 540/65 R30 158D/155E TL PFO	296638	536	1460	635	4307	W18L		W16L (NRO)		754	332	48		
Bar	0.4	0.6	0.8	0.9	1	1.1	1.2	1.3	1.4	1.5	1.6	1.7	1.8	1.9	2
Psi	6	9	12	13	15	16	17	19	20	22	23	25	26	28	29
10 km/h	2715	3170	3395	3620	3820	4025	4225	4425	4630	4830	4950	5075	5195	5315	
30 km/h	2345	2735	2930	3125	3300	3475	3650	3820	3995	4170	4275	4380	4485	4590	
65 km/h	2170	2535	2715	2895	3055	3220	3380	3540	3705	3865	3960	4060	4155	4250	
70 km/h	1975	2305	2470	2635	2780	2930	3075	3220	3370	3515	3605	3695	3785	3875	
65 km/h Dual	1550	1885	2215	2385	2550	2690	2835	2975	3115	3260	3400	3485	3570	3655	3740

Ø inches	Description	CAI	e mm	D mm	R' mm	RC mm	Recommended Rim		Acceptable Rim		Tube (Code)	75% internal volume (litres)	Tread depth (mm)		
30	VF 600/60R30 162D/159E TL PFO	371968	597	1468	634	4323	DW20B (A)		DW18L (NRO)		757	381	49		
Bar	0.4	0.6	0.8	0.9	1	1.1	1.2	1.3	1.4	1.5	1.6	1.7	1.8	1.9	2
Psi	6	9	12	13	15	16	17	19	20	22	23	25	26	28	29
10 km/h	2530	2965	3180	3395	3605	3820	4035	4250	4460	4675	4815	4950	5090	5225	
30 km/h	2345	2750	2950	3145	3345	3545	3740	3940	4135	4335	4465	4590	4720	4845	
65 km/h	2300	2695	2890	3085	3280	3475	3665	3860	4055	4250	4375	4500	4625	4750	
70 km/h	2095	2445	2620	2790	2965	3140	3325	3505	3690	3870	3985	4100	4210	4325	
65 km/h Dual	1715	2035	2390	2550	2710	2875	3035	3210	3390	3565	3740	3850	3960	4070	4180

Ø inches	Description	CAI	e mm	D mm	R' mm	RC mm	Recommended Rim		Acceptable Rim		Tube (Code)	75% internal volume (litres)	Tread depth (mm)		
30	VF 600/70R30 168D/165E TL PFO	426719	624	1579	682	4649	DW21B (A)		DW20B (A)		737	468	58		
Bar	0.4	0.6	0.8	0.9	1	1.1	1.2	1.3	1.4	1.5	1.6	1.7	1.8	1.9	2
Psi	6	9	12	13	15	16	17	19	20	22	23	25	26	28	29
10 km/h	3515	4105	4395	4690	4985	5275	5570	5860	6155	6445	6585	6725	6860	7000	
30 km/h	3040	3545	3800	4050	4305	4555	4810	5065	5315	5570	5690	5810	5930	6050	
65 km/h	2815	3285	3515	3750	3985	4220	4455	4685	4920	5155	5265	5380	5490	5600	
70 km/h	2560	2990	3200	3415	3630	3840	4055	4270	4480	4695	4810	4925	5035	5150	
65 km/h Dual	2025	2450	2875	3090	3300	3505	3715	3920	4125	4335	4540	4640	4735	4835	4930

* Refer to the notes at the end of the tables of this range

MICHELIN AXIOBIB 2

Tire specifications and pressure table (bar & psi). Load per tire in kg*

Ø inches	Description	CAI	e mm	D mm	R' mm	RC mm	Recommended Rim		Acceptable Rim		Tube (Code)	75% internal volume (litres)		Tread depth (mm)	
30	VF 620/75R30 172D/169E TL PFO	702894	662	1670	714	4907	DW23B (A)		DW20B (A) DW21B (A)		737	556		58	
Bar	0.4	0.6	0.8	0.9	1	1.1	1.2	1.3	1.4	1.5	1.6	1.7	1.8	1.9	2
Psi	6	9	12	13	15	16	17	19	20	22	23	25	26	28	29
10 km/h	3945	4605	4930	5260	5590	5915	6245	6575	6900	7230	7390	7555	7715	7875	
30 km/h	3405	3975	4255	4540	4825	5110	5395	5675	5960	6245	6385	6525	6665	6805	
65 km/h	3155	3680	3945	4205	4470	4730	4995	5260	5520	5785	5915	6045	6170	6300	
70 km/h	2870	3350	3585	3825	4065	4305	4545	4785	5025	5265	5400	5535	5665	5800	
65 km/h Dual	2315	2775	3240	3470	3700	3930	4165	4395	4625	4860	5090	5320	5430	5545	

Ø inches	Description	CAI	e mm	D mm	R' mm	RC mm	Recommended Rim		Acceptable Rim		Tube (Code)	75% internal volume (litres)		Tread depth (mm)	
34	VF 650/60R34 168D/165E TL PFO	202185	677	1653	724	4882	DW23B (A)		DW21B (A) DW24B (A)		823	500		58	
Bar	0.4	0.6	0.8	0.9	1	1.1	1.2	1.3	1.4	1.5	1.6	1.7	1.8	1.9	2
Psi	6	9	12	13	15	16	17	19	20	22	23	25	26	28	29
10 km/h	3515	4105	4395	4690	4985	5275	5570	5860	6155	6445	6585	6725	6860	7000	
30 km/h	3040	3545	3800	4050	4305	4555	4810	5065	5315	5570	5690	5810	5930	6050	
65 km/h	2815	3285	3515	3750	3985	4220	4455	4685	4920	5155	5265	5380	5490	5600	
70 km/h	2560	2990	3200	3415	3630	3840	4055	4270	4480	4695	4810	4925	5035	5150	
65 km/h Dual	2025	2450	2875	3090	3300	3505	3715	3920	4125	4335	4540	4640	4735	4835	4930

Ø inches	Description	CAI	e mm	D mm	R' mm	RC mm	Recommended Rim		Acceptable Rim		Tube (Code)	75% internal volume (litres)		Tread depth (mm)	
34	VF 650/65R34 170D/167E TL PFO	101906	679	1710	747	5047	DW23B (A)		DW21B (A) MW23B (A)		823	600		58	
Bar	0.4	0.6	0.8	0.9	1	1.1	1.2	1.3	1.4	1.5	1.6	1.7	1.8	1.9	2
Psi	6	9	12	13	15	16	17	19	20	22	23	25	26	28	29
10 km/h	3830	4470	4790	5110	5395	5680	5965	6250	6535	6820	6990	7160	7330	7500	
30 km/h	3310	3865	4140	4415	4660	4905	5155	5400	5645	5890	6040	6185	6335	6480	
65 km/h	3065	3575	3830	4085	4315	4540	4770	5000	5225	5455	5590	5730	5865	6000	
70 km/h	2790	3255	3490	3720	3930	4135	4345	4550	4760	4965	5085	5210	5330	5450	
65 km/h Dual	2265	2710	3150	3375	3595	3795	3995	4200	4400	4600	4800	4920	5040	5160	5280

* Refer to the notes at the end of the tables of this range

MICHELIN AXIOBIB 2

Tire specifications and pressure table (bar & psi). Load per tire in kg*

Ø inches	Description	CAI	e mm	D mm	R' mm	RC mm	Recommended Rim		Acceptable Rim	Tube (Code)	75% internal volume (litres)	Tread depth (mm)			
34	VF 710/60R34 173D/169E TL PFO	757609	729	1727	764	5112	DW25B (A)		DW23B (A) (NRO) MW25B (A)		613	58			
Bar	0.4	0.6	0.8	0.9	1	1.1	1.2	1.3	1.4	1.5	1.6	1.7	1.8	1.9	2
Psi	6	9	12	13	15	16	17	19	20	22	23	25	26	28	29
10 km/h	3970	4630	4960	5290	5620	5950	6285	6615	6945	7275	7490	7700	7915	8125	
30 km/h	3430	4000	4285	4570	4855	5140	5430	5715	6000	6285	6470	6655	6835	7020	
65 km/h	3175	3705	3970	4235	4500	4765	5030	5290	5555	5820	5990	6160	6330	6500	
70 km/h	2890	3370	3610	3850	4090	4330	4575	4815	5055	5295	5420	5550	5675	5800	
65 km/h Dual	2330	2795	3260	3495	3725	3960	4190	4425	4655	4890	5120	5270	5420	5570	5720

Ø inches	Description	CAI	e mm	D mm	R' mm	RC mm	Recommended Rim		Acceptable Rim	Tube (Code)	75% internal volume (litres)	Tread depth (mm)			
38	VF 650/60R38 170D/167E TL PFO	908973	668	1742	758	5138	DW23B (A)		DW20B (A) (NRO) MW23B (A)	825	540	58			
Bar	0.4	0.6	0.8	0.9	1	1.1	1.2	1.3	1.4	1.5	1.6	1.7	1.8	1.9	2
Psi	6	9	12	13	15	16	17	19	20	22	23	25	26	28	29
10 km/h	3645	4255	4555	4860	5165	5470	5775	6075	6380	6685	6890	7095	7295	7500	
30 km/h	3150	3675	3940	4200	4465	4725	4990	5250	5515	5775	5950	6130	6305	6480	
65 km/h	2915	3405	3645	3890	4135	4375	4620	4860	5105	5345	5510	5675	5835	6000	
70 km/h	2655	3100	3320	3540	3760	3980	4205	4425	4645	4865	5010	5160	5305	5450	
65 km/h Dual	2140	2565	2995	3205	3420	3635	3850	4065	4275	4490	4705	4850	4995	5135	5280

Ø inches	Description	CAI	e mm	D mm	R' mm	RC mm	Recommended Rim		Acceptable Rim	Tube (Code)	75% internal volume (litres)	Tread depth (mm)			
38	VF 650/85R38 182D/179E TL PFO	655949	680	2063	889	6072	DW23B (A)		DW20B (A) DW21B	804	857	60			
Bar	0.4	0.6	0.8	0.9	1	1.1	1.2	1.3	1.4	1.5	1.6	1.7	1.8	1.9	2
Psi	6	9	12	13	15	16	17	19	20	22	23	25	26	28	29
10 km/h	5265	6145	6580	7020	7460	7895	8335	8775	9210	9650	9895	10140	10380	10625	
30 km/h	4550	5310	5685	6065	6445	6825	7205	7580	7960	8340	8550	8760	8970	9180	
65 km/h	4210	4915	5265	5615	5965	6315	6670	7020	7370	7720	7915	8110	8305	8500	
70 km/h	3830	4470	4790	5110	5430	5750	6070	6385	6705	7025	7205	7390	7570	7750	
65 km/h Dual	3125	3730	4335	4640	4940	5250	5560	5870	6175	6485	6795	6965	7140	7310	7480

* Refer to the notes at the end of the tables of this range

MICHELIN AXIOBIB 2

Tire specifications and pressure table (bar & psi). Load per tire in kg*

Ø inches	Description	CAI	e mm	D mm	R' mm	RC mm	Recommended Rim		Acceptable Rim		Tube (Code)	75% internal volume (litres)	Tread depth (mm)		
38	VF 800/70R38 187D/184E TL PFO	136377	821	2072	879	6078	DW27B (A)		DW25B (A)		804	1073	63		
Bar	0.4	0.6	0.8	0.9	1	1.1	1.2	1.3	1.4	1.5	1.6	1.7	1.8	1.9	2
Psi	6	9	12	13	15	16	17	19	20	22	23	25	26	28	29
10 km/h	6115	7135	7645	8155	8665	9175	9685	10190	10700	11210	11455	11700	11945	12190	
30 km/h	5285	6165	6605	7045	7485	7925	8365	8805	9245	9685	9895	10110	10320	10530	
65 km/h	4890	5710	6115	6525	6935	7340	7750	8155	8565	8970	9165	9360	9555	9750	
70 km/h	4450	5195	5565	5935	6305	6675	7050	7420	7790	8160	8370	8580	8790	9000	
65 km/h Dual	3630	4335	5035	5390	5740	6100	6460	6820	7175	7535	7895	8065	8240	8410	8580

Ø inches	Description	CAI	e mm	D mm	R' mm	RC mm	Recommended Rim		Acceptable Rim		Tube (Code)	75% internal volume (litres)	Tread depth (mm)		
42	VF 650/65R42 174D/171E TL PFO	387916	666	1920	839	5668	DW23B (A)		DW20B (A) (NRO) DW21B(A)		802	643	58		
Bar	0.4	0.6	0.8	0.9	1	1.1	1.2	1.3	1.4	1.5	1.6	1.7	1.8	1.9	2
Psi	6	9	12	13	15	16	17	19	20	22	23	25	26	28	29
10 km/h	4225	4930	5285	5635	5950	6260	6575	6890	7200	7515	7730	7945	8160	8375	
30 km/h	3650	4260	4560	4865	5135	5410	5680	5950	6225	6495	6680	6865	7050	7235	
65 km/h	3380	3945	4225	4505	4755	5010	5260	5510	5765	6015	6185	6360	6530	6700	
70 km/h	3075	3590	3845	4100	4330	4555	4785	5015	5240	5470	5640	5810	5980	6150	
65 km/h Dual	2465	2965	3465	3715	3965	4185	4405	4630	4850	5070	5290	5440	5595	5745	5895

Ø inches	Description	CAI	e mm	D mm	R' mm	RC mm	Recommended Rim		Acceptable Rim		Tube (Code)	75% internal volume (litres)	Tread depth (mm)		
42	VF 650/85R42 183D/180E TL PFO	530764	670	2164	939	6379	DW23B (A)		DW21B(A)		802	914	61		
Bar	0.4	0.6	0.8	0.9	1	1.1	1.2	1.3	1.4	1.5	1.6	1.7	1.8	1.9	2
Psi	6	9	12	13	15	16	17	19	20	22	23	25	26	28	29
10 km/h	5500	6415	6875	7330	7790	8245	8705	9165	9620	10080	10295	10510	10725	10940	
30 km/h	4750	5540	5935	6330	6725	7120	7520	7915	8310	8705	8890	9080	9265	9450	
65 km/h	4400	5135	5500	5865	6230	6595	6965	7330	7695	8060	8235	8405	8580	8750	
70 km/h	4000	4670	5000	5335	5670	6000	6335	6670	7000	7335	7500	7670	7835	8000	
65 km/h Dual	3210	3860	4510	4835	5160	5485	5805	6130	6450	6775	7095	7245	7400	7550	7700

* Refer to the notes at the end of the tables of this range

MICHELIN AXIOBIB 2

Tire specifications and pressure table (bar & psi). Load per tire in kg*

Ø inches	Description	CAI	e mm	D mm	R' mm	RC mm	Recommended Rim	Acceptable Rim	Tube (Code)	75% internal volume (litres)	Tread depth (mm)				
42	VF 710/60R42 176D/173E TL PFO	941770	730	1885,3	821	5560	DW25B (A)	DW23B (A) (NRO) MW25B (A)	802	710	58				
Bar	0.4	0.6	0.8	0.9	1	1.1	1.2	1.3	1.4	1.5	1.6	1.7	1.8	1.9	2
Psi	6	9	12	13	15	16	17	19	20	22	23	25	26	28	29
10 km/h	4375	5105	5470	5835	6200	6565	6930	7290	7655	8020	8235	8450	8660	8875	
30 km/h	3780	4410	4725	5040	5355	5670	5985	6300	6615	6930	7115	7300	7485	7670	
65 km/h	3500	4085	4375	4665	4955	5250	5540	5830	6125	6415	6585	6760	6930	7100	
70 km/h	3185	3715	3980	4245	4510	4775	5045	5310	5575	5840	6005	6170	6335	6500	
65 km/h Dual	2550	3070	3585	3845	4105	4360	4620	4875	5130	5390	5645	5795	5950	6100	6250

Ø inches	Description	CAI	e mm	D mm	R' mm	RC mm	Recommended Rim	Acceptable Rim	Tube (Code)	75% internal volume (litres)	Tread depth (mm)				
42	VF 710/70R42 182D/179E TL PFO	523668	731	2066	903	6100	DW25B (A)	DW23B (A) MW25B (A)	802	867	63				
Bar	0.4	0.6	0.8	0.9	1	1.1	1.2	1.3	1.4	1.5	1.6	1.7	1.8	1.9	2
Psi	6	9	12	13	15	16	17	19	20	22	23	25	26	28	29
10 km/h	5305	6190	6630	7070	7515	7955	8400	8840	9285	9725	9950	10175	10400	10625	
30 km/h	4580	5345	5730	6110	6490	6875	7255	7635	8020	8400	8595	8790	8985	9180	
65 km/h	4245	4950	5305	5655	6010	6365	6720	7070	7425	7780	7960	8140	8320	8500	
70 km/h	3860	4505	4830	5150	5470	5795	6115	6435	6760	7080	7250	7415	7585	7750	
65 km/h Dual	3125	3745	4360	4670	4980	5290	5600	5915	6225	6535	6845	7005	7165	7320	7480

Ø inches	Description	CAI	e mm	D mm	R' mm	RC mm	Recommended Rim	Acceptable Rim	Tube (Code)	75% internal volume (litres)	Tread depth (mm)				
42	VF 710/75R42 184D/180E TL PFO	259635	737	2153	939	6353	DW25B (A)	DW23B (A)	802	945	65				
Bar	0.4	0.6	0.8	0.9	1	1.1	1.2	1.3	1.4	1.5	1.6	1.7	1.8	1.9	2
Psi	6	9	12	13	15	16	17	19	20	22	23	25	26	28	29
10 km/h	5645	6585	7055	7525	7995	8465	8935	9405	9875	10345	10570	10800	11025	11250	
30 km/h	4875	5690	6095	6500	6905	7310	7720	8125	8530	8935	9130	9330	9525	9720	
65 km/h	4515	5270	5645	6020	6395	6770	7150	7525	7900	8275	8455	8640	8820	9000	
70 km/h	4110	4795	5135	5475	5820	6160	6505	6845	7190	7530	7650	7765	7885	8000	
65 km/h Dual	3300	3965	4630	4965	5295	5625	5955	6290	6620	6950	7280	7440	7600	7760	7920

* Refer to the notes at the end of the tables of this range

MICHELIN AXIOBIB 2

Tire specifications and pressure table (bar & psi). Load per tire in kg*

Ø inches	Description	CAI	e mm	D mm	R' mm	RC mm	Recommended Rim		Acceptable Rim	Tube (Code)	75% internal volume (litres)	Tread depth (mm)			
42	VF 900/60R42 189D/185E TL PFO	428922	881	2158	930	6352	DW30B (A)		DW28B (A) (NRO)		1230	64			
Bar	0.4	0.6	0.8	0.9	1	1.1	1.2	1.3	1.4	1.5	1.6	1.7	1.8	1.9	2
Psi	6	9	12	13	15	16	17	19	20	22	23	25	26	28	29
10 km/h	6305	7355	7880	8405	8930	9455	9980	10505	11030	11555	11885	12215	12545	12875	
30 km/h	5445	6355	6805	7260	7715	8170	8625	9075	9530	9985	10270	10555	10840	11125	
65 km/h	5045	5885	6305	6725	7145	7565	7985	8405	8825	9245	9510	9775	10035	10300	
70 km/h	4590	5355	5740	6120	6505	6885	7270	7650	8035	8415	8625	8835	9040	9250	
65 km/h Dual	3665	4415	5165	5540	5915	6285	6655	7025	7395	7765	8135	8370	8600	8835	9065

Ø inches	Description	CAI	e mm	D mm	R' mm	RC mm	Recommended Rim		Acceptable Rim	Tube (Code)	75% internal volume (litres)	Tread depth (mm)			
44	VF 750/70R44 186D/183E TL PFO	681569	763	2180	946	6426	DW25B (A)		MW24B (A) MW25B (A) DW24B (A)		1016	64			
Bar	0.4	0.6	0.8	0.9	1	1.1	1.2	1.3	1.4	1.5	1.6	1.7	1.8	1.9	2
Psi	6	9	12	13	15	16	17	19	20	22	23	25	26	28	29
10 km/h	5895	6880	7375	7865	8355	8845	9340	9830	10320	10810	11075	11345	11610	11875	
30 km/h	5095	5945	6370	6795	7220	7645	8070	8490	8915	9340	9570	9800	10030	10260	
65 km/h	4715	5505	5895	6290	6685	7075	7470	7865	8255	8650	8865	9075	9290	9500	
70 km/h	4290	5010	5365	5725	6085	6440	6800	7155	7515	7870	8090	8310	8530	8750	
65 km/h Dual	3410	4120	4825	5180	5535	5880	6225	6575	6920	7265	7610	7800	7985	8175	8360

***IMPORTANT:**

The inflation pressure must always be appropriate for the load per tire, the speed of travel and the work to be done. Our recommendations above are provided subject to changes made after the date of publication of these tables. Technical data is subject to change without prior notice.

- For plowing and other field applications subject to high torque, use the 30 km/h line.
- When using single tire configuration:
 - add 0.4 bar for use on slopes of more than 20%
 - add 0.4 bar for intensive road use exceeding 50%
- (NRO) - Narrow rim option - when using NRO add 0.2 bar.
- 10 km/h: low torque application only



MICHELIN AXIOBIB

IMPROVED TRACTION & SOIL PROTECTION FOR VERY HIGH-POWERED TRACTORS



FOR HIGH POWER TRACTORS



IMPROVED FLEXION STANDARD (IF)

Tire designed to operate at 20% higher rated load than standard tires at the same inflation pressure.



BETTER YIELDS +4% /Year⁽¹⁾



FUEL SAVINGS

up to **15%** when working in the field⁽²⁾



+11% TRACTION

with AXIOBIB IF 710/70R42 vs standard 710/70R42



SOIL PROTECTION

thanks to low pressure capability.

(1) Study led by Harper Adams University, Newport, United Kingdom - from 2014 to 2016

(2) In average, observed versus standard equipment during field demonstrations.

SIZES

IF 600/70 R30 159D TL

IF 620/75 R30 164D TL

IF 650/75 R30 166D TL

IF 650/60 R34 165D TL

IF 650/65 R34 161D TL

IF 710/60 R34 164D TL

IF 650/65 R38 169D TL

IF 650/85 R38 179D TL

IF 710/60 R38 172D TL

IF 710/85 R38 178D TL

IF 800/70 R38 179D TL

IF 710/70 R42 179D TL

IF 710/75 R42 176D TL

IF 900/60 R42 186D TL

IF 750/75 R46 186D TL

IF 900/65 R46 190D TL

MICHELIN AXIOBIB

Tire specifications and pressure table (bar & psi). Load per tire in kg*

Ø inches	Description	CAI	e mm	D mm	R' mm	RC mm	Recommended Rim	Acceptable Rim	Tube (Code)	75% internal volume (litres)	Tread depth (mm)
30	IF 600/70R30 159D TL	280086	613	1585	695	4683	DW21B (A)	DW20B (A)	737	450	56
Bar	0.4	0.6	0.8	1	1.2	1.4	1.6				
Psi	6	9	12	15	17	20	23				
10 km/h		3220	3710	4200	4615	5030					
30 km/h		2910	3355	3795	4175	4550					
65 km/h		2800	3225	3650	4015	4375					
65 km/h Dual	1760	2110	2460	2835	3210	3530	3850				

Ø inches	Description	CAI	e mm	D mm	R' mm	RC mm	Recommended Rim	Acceptable Rim	Tube (Code)	75% internal volume (litres)	Tread depth (mm)
30	IF 620/75R30 164D TL	668406	659	1670	728	4927	DW23B (A)	DW20B (A) DW21B (A) MW23B(A)	737	570	58
Bar	0.4	0.6	0.8	1	1.2	1.4	1.6				
Psi	6	9	12	15	17	20	23				
10 km/h		3620	4110	4600	5175	5750					
30 km/h		3275	3720	4160	4680	5200					
65 km/h		3150	3575	4000	4500	5000					
65 km/h Dual	1970	2370	2770	3145	3520	3960	4400				

Ø inches	Description	CAI	e mm	D mm	R' mm	RC mm	Recommended Rim	Acceptable Rim	Tube (Code)	75% internal volume (litres)	Tread depth (mm)
30	IF 650/75R30 166D TL	828322	679	1721	745	5071	DW23B (A)	MW23B(A)		638	57
Bar	0.4	0.6	0.8	1	1.2	1.4	1.6				
Psi	6	9	12	15	17	20	23				
10 km/h		3965	4500	5030	5565	6095					
30 km/h		3590	4070	4550	5030	5510					
65 km/h		3450	3915	4375	4840	5300					
65 km/h Dual	2140	2590	3040	3445	3850	4255	4660				

Ø inches	Description	CAI	e mm	D mm	R' mm	RC mm	Recommended Rim	Acceptable Rim	Tube (Code)	75% internal volume (litres)	Tread depth (mm)				
34	IF 650/60R34 165D TL	100511	633	1661	745	4933	DW23B (A)	DW21B (A) DW24B (A)	823	500	58				
Bar	0.4	0.6	0.8	1	1.2	1.4	1.6	1.7	1.8	1.9	2	2.1	2.2	2.3	2.4
Psi	6	9	12	15	17	20	23	25	26	28	29	30	32	33	35
10 km/h		3220	3675	4130	4580	5030	5145	5255	5370	5480	5590	5700	5810	5920	
30 km/h		2910	3325	3735	4145	4550	4650	4755	4855	4955	5055	5155	5255	5355	
65 km/h		2800	3195	3590	3985	4375	4475	4570	4670	4765	4860	4960	5055	5150	
65 km/h Dual	1760	2115	2465	2815	3160	3505	3850	3935	4020	4105	4190	4275	4360	4445	4530

* Refer to the notes at the end of the tables of this range

MICHELIN AXIOBIB

Tire specifications and pressure table (bar & psi). Load per tire in kg*

Ø inches	Description	CAI	e mm	D mm	R' mm	RC mm	Recommended Rim	Acceptable Rim	Tube (Code)	75% internal volume (litres)	Tread depth (mm)
34	IF 710/60R34 164D TL	712503	708	1696	756	5030	DW25B (A)			615	58
Bar	0.4	0.6	0.8	1	1.2	1.4	1.6				
Psi	6	9	12	15	17	20	23				
10 km/h		3620	4185	4745	5250	5750					
30 km/h		3275	3785	4290	4745	5200					
65 km/h		3150	3640	4125	4565	5000					
65 km/h Dual	1970	2370	2770	3200	3630	4015	4400				

Ø inches	Description	CAI	e mm	D mm	R' mm	RC mm	Recommended Rim	Acceptable Rim	Tube (Code)	75% internal volume (litres)	Tread depth (mm)
34	IF 650/65R34 161D TL	711975	653	1721	764	5099	DW23B (A)	MW23B (A)	823	555	58
Bar	0.4	0.6	0.8	1	1.2	1.4	1.6				
Psi	6	9	12	15	17	20	23				
10 km/h		3535	4070	4600	4960	5320					
30 km/h		3200	3680	4160	4485	4810					
65 km/h		3075	3540	4000	4315	4625					
65 km/h Dual	1920	2315	2710	3115	3520	3795	4070				

Ø inches	Description	CAI	e mm	D mm	R' mm	RC mm	Recommended Rim	Acceptable Rim	Tube (Code)	75% internal volume (litres)	Tread depth (mm)				
38	IF 650/65R38 169D TL	508421	649	1826	833	5446	DW23B (A)	DW21B (A) MW21B(A)	825	599	58				
Bar	0.4	0.6	0.8	1	1.2	1.4	1.6	1.7	1.8	1.9	2	2.1	2.2	2.3	2.4
Psi	6	9	12	15	17	20	23	25	26	28	29	30	32	33	35
10 km/h		3735	4240	4745	5175	5605	5740	5875	6005	6140	6275	6405	6540	6670	
30 km/h		3380	3835	4290	4680	5070	5190	5315	5435	5555	5675	5795	5910	6030	
65 km/h		3250	3690	4125	4500	4875	4990	5110	5225	5340	5455	5570	5685	5800	
65 km/h Dual	2025	2445	2860	3245	3630	3960	4290	4390	4495	4595	4695	4795	4900	5000	5100

Ø inches	Description	CAI	e mm	D mm	R' mm	RC mm	Recommended Rim	Acceptable Rim	Tube (Code)	75% internal volume (litres)	Tread depth (mm)				
38	IF 710/60R38 172D TL	220975	710	1844	834	5486	DW25B (A)		825	661	58				
Bar	0.4	0.6	0.8	1	1.2	1.4	1.6	1.7	1.8	1.9	2	2.1	2.2	2.3	2.4
Psi	6	9	12	15	17	20	23	25	26	28	29	30	32	33	35
10 km/h		3850	4415	4975	5535	6095	6240	6385	6525	6670	6815	6960	7100	7245	
30 km/h		3485	3995	4500	5005	5510	5640	5770	5900	6030	6160	6290	6420	6550	
65 km/h		3350	3840	4325	4815	5300	5425	5550	5675	5800	5925	6050	6175	6300	
65 km/h Dual	2360	2680	3000	3410	3815	4220	4625	4740	4855	4970	5085	5200	5315	5430	5545

* Refer to the notes at the end of the tables of this range

MICHELIN AXIOBIB

Tire specifications and pressure table (bar & psi). Load per tire in kg*

Ø inches	Description	CAI	e mm	D mm	R' mm	RC mm	Recommended Rim		Acceptable Rim		Tube (Code)	75% internal volume (litres)	Tread depth (mm)		
38	IF 650/85R38 179D TL	084900	692	2050	913	6078	DW23B (A)		MW23B (A)		804	900	63		
Bar	0.4	0.6	0.8	1	1.2	1.4	1.6	1.7	1.8	1.9	2	2.1	2.2	2.3	2.4
Psi	6	9	12	15	17	20	23	25	26	28	29	30	32	33	35
10 km/h			4890	5580	6265	6985	7705	7880	8050	8225	8395	8525	8655	8785	8915
30 km/h			4420	5045	5670	6320	6970	7125	7280	7435	7590	7710	7825	7945	8060
65 km/h			4250	4850	5450	6075	6700	6850	7000	7150	7300	7415	7525	7640	7750
65 km/h Dual	2640	3190	3740	4270	4800	5350	5900	6030	6160	6290	6420	6520	6620	6720	6820

Ø inches	Description	CAI	e mm	D mm	R' mm	RC mm	Recommended Rim		Acceptable Rim		Tube (Code)	75% internal volume (litres)	Tread depth (mm)
38	IF 800/70R38 179D TL	528166	810	2067	894	6089	DW27B (A)				804	1088	63
Bar	0.4	0.6	0.8	1	1.2	1.4	1.6						
Psi	6	9	12	15	17	20	23						
10 km/h			5605	6425	7245	8080	8915						
30 km/h			5070	5810	6550	7305	8060						
65 km/h			4875	5590	6300	7025	7750						
65 km/h Dual	3040	3665	4290	4915	5540	6180	6820						

Ø inches	Description	CAI	e mm	D mm	R' mm	RC mm	Recommended Rim		Acceptable Rim		Tube (Code)	75% internal volume (litres)	Tread depth (mm)
38	IF 710/85R38 178D TL	992951	734	2159	937	6365	DW25B (A)		MW25B (A)		804	1088	65
Bar	0.4	0.6	0.8	1	1.2	1.4	1.6						
Psi	6	9	12	15	17	20	23						
10 km/h			5605	6340	7070	7850	8625						
30 km/h			5070	5735	6395	7100	7800						
65 km/h			4875	5515	6150	6825	7500						
65 km/h Dual	3040	3665	4290	4850	5410	6005	6600						

Ø inches	Description	CAI	e mm	D mm	R' mm	RC mm	Recommended Rim		Acceptable Rim		Tube (Code)	75% internal volume (litres)	Tread depth (mm)		
42	IF 710/70R42 179D TL	771752	742	2062	919	6115	DW25B (A)		DW23B MW25B (A)		802	870	63		
Bar	0.4	0.6	0.8	1	1.2	1.4	1.6	1.7	1.8	1.9	2	2.1	2.2	2.3	2.4
Psi	6	9	12	15	17	20	23	25	26	28	29	30	32	33	35
10 km/h			4890	5580	6265	6985	7705	7880	8050	8225	8395	8525	8655	8785	8915
30 km/h			4420	5045	5670	6320	6970	7125	7280	7435	7590	7710	7825	7945	8060
65 km/h			4250	4850	5450	6075	6700	6850	7000	7150	7300	7415	7525	7640	7750
65 km/h Dual	2640	3190	3740	4270	4800	5350	5900	6030	6160	6290	6420	6520	6620	6720	6820

* Refer to the notes at the end of the tables of this range

MICHELIN AXIOBIB

Tire specifications and pressure table (bar & psi). Load per tire in kg*

Ø inches	Description	CAI	e mm	D mm	R' mm	RC mm	Recommended Rim	Acceptable Rim	Tube (Code)	75% internal volume (litres)	Tread depth (mm)			
42	IF 900/60R42 186D TL	111950	881	2123	952	6304	DW30B (A)			1230	65			
Bar	0.4 0.6 0.8	1	1.2	1.4	1.6	1.7	1.8	1.9	2	2.1	2.2	2.3	2.4	
Psi	6 9 12	15	17	20	23	25	26	28	29	30	32	33	35	
10 km/h		5750	6615	7475	8340	9200	9415	9635	9850	10065	10280	10495	10710	10925
30 km/h		5200	5980	6760	7540	8320	8515	8710	8905	9100	9295	9490	9685	9880
65 km/h		5000	5750	6500	7250	8000	8190	8375	8565	8750	8940	9125	9315	9500
65 km/h Dual	3210 3805	4400	5060	5720	6380	7040	7205	7370	7535	7700	7865	8030	8195	8360

Ø inches	Description	CAI	e mm	D mm	R' mm	RC mm	Recommended Rim	Acceptable Rim	Tube (Code)	75% internal volume (litres)	Tread depth (mm)		
42	IF 710/75R42 176D TL	037489	715	2161	954	6395	DW25B (A)	DW23B (A)	802	953	66		
Bar	0.4 0.6 0.8	1	1.2	1.4	1.6								
Psi	6 9 12	15	17	20	23								
10 km/h		5190	5935	6680	7425	8165							
30 km/h		4695	5370	6040	6715	7385							
65 km/h		4515	5165	5810	6455	7100							
65 km/h Dual	2845 3415	3980	4550	5115	5685	6250							

Ø inches	Description	CAI	e mm	D mm	R' mm	RC mm	Recommended Rim	Acceptable Rim	Tube (Code)	75% internal volume (litres)	Tread depth (mm)			
46	IF 750/75R46 186D TL	487001	761	2287	1043	6819	DW25B (A)			1147	71			
Bar	0.4 0.6 0.8	1	1.2	1.4	1.6	1.7	1.8	1.9	2	2.1	2.2	2.3	2.4	
Psi	6 9 12	15	17	20	23	25	26	28	29	30	32	33	35	
10 km/h		5920	6700	7475	8340	9200	9415	9635	9850	10065	10280	10495	10710	10925
30 km/h		5355	6060	6760	7540	8320	8515	8710	8905	9100	9295	9490	9685	9880
65 km/h		5150	5825	6500	7250	8000	8190	8375	8565	8750	8940	9125	9315	9500
65 km/h Dual	3210 3870	4530	5125	5720	6380	7040	7205	7370	7535	7700	7865	8030	8195	8360

Ø inches	Description	CAI	e mm	D mm	R' mm	RC mm	Recommended Rim	Acceptable Rim	Tube (Code)	75% internal volume (litres)	Tread depth (mm)			
46	IF 900/65R46 190D TL	162365	915	2322	1038	6888	DW30B (A)	MW30B (A) TW30B		1450	71			
Bar	0.4 0.6 0.8	1	1.2	1.4	1.6	1.7	1.8	1.9	2	2.1	2.2	2.3	2.4	
Psi	6 9 12	15	17	20	23	25	26	28	29	30	32	33	35	
10 km/h		6670	7650	8625	9345	10065	10330	10595	10860	11125	11390	11660	11925	12190
30 km/h		6030	6915	7800	8450	9100	9340	9580	9820	10060	10300	10545	10785	11025
65 km/h		5800	6650	7500	8125	8750	8980	9215	9445	9675	9905	10140	10370	10600
65 km/h Dual	3630 4370	5105	5855	6600	7150	7700	7905	8110	8310	8515	8720	8925	9125	9330

* Refer to the notes at the end of the tables of this range



MICHELIN MACHXBIB

**EXCEPTIONAL VALUE
& VERSALITY FOR
HIGH-POWERED TRACTORS**



FOR HIGH POWER TRACTORS



VERSATILE, ideal for road transport & efficient in the field:

- speed of up to 65 km/h⁽¹⁾
- load capacity in the field
- damage resistance
- excellent tractive performance



4% FUEL SAVINGS, 1 litre/hr compared to the main market competitor⁽²⁾
(for a consumption on the road of 25 l/hr)



PROVEN **CASING ROBUSTNESS**

(1) When authorized by the laws in force in the country - depending on the size

(2) Analytic Test at MICHELIN Ladoux Centre, in June 2014 comparing Fuel Consumption of 710/70R42 MICHELIN MACHXBIB and 710/70R42 Competitor

SIZES

600/65R28 154A8/154B TL
600/65R28 154D/150E TL
600/70R28 157D/154E TL
600/70R28 157A8/157B TL
710/55R30 153D TL
600/70R30 158D TL
650/60R34 159D/155E TL

650/65R34 161D/157E TL
650/75R38 169D/165E TL
650/85R38 173D/169E **NEW**
710/70R38 171D TL
650/85R38 173A8/173B TL
800/70R38 173D TL
900/50R42 168D TL

710/70R42 173D TL
710/75R42 175D/171E TL
620/70R46 162D TL

MICHELIN MACHXBIB

Tire specifications and pressure table (bar & psi). Load per tire in kg*

Ø inches	Description	CAI	e mm	D mm	R' mm	RC mm	Recommended Rim		Acceptable Rim	Tube (Code)	75% internal volume (litres)	Tread depth (mm)	
28	600/65R28 154A8/1548 TL	135288	615	1485	669	4415	1.7	1.8	DW20B (A)	DW18L W18L	717	425	51
Bar	0.4	0.6	0.8	1	1.2	1.4	1.6	1.7	1.8	1.9	2	2.2	2.4
Psi	6	9	12	15	17	20	23	25	26	28	29	32	35
10 km/h				3150	3505	3855	4210	4390	4565	4745	4920	5275	5630
25 km/h				2610	2925	3245	3560	3635	3710	3785	3860	4010	4160
30 km/h	1610	1915	2215	2520	2825	3125	3430	3505	3575	3650	3720	3865	4010
40 km/h				2490	2710	2930	3150	3225	3300	3375	3450	3600	3750
40 km/h Dual	1320	1610	1900	2190	2385	2575	2770	2835	2905	2970	3035	3170	3300
50 km/h				2710	2930	3150	3225	3300	3375	3450	3600	3750	

Ø inches	Description	CAI	e mm	D mm	R' mm	RC mm	Recommended Rim		Acceptable Rim	Tube (Code)	75% internal volume (litres)	Tread depth (mm)			
28	600/65R28 154D/150E TL	429970	626	1494	671	4465	1.7	1.8	DW20B (A)	DW18L DW21B(A) W18L	717	405	54		
Bar	0.4	0.6	0.8	1	1.2	1.4	1.6	1.7	1.8	1.9	2	2.2	2.4	2.6	2.8
Psi	6	9	12	15	17	20	23	25	26	28	29	32	35	38	41
10 km/h	2250	2530	2810	3090	3445	3805	4160	4340	4520	4695	4875	5065	5250	5440	5625
30 km/h	1725	2040	2360	2675	2990	3310	3625	3710	3800	3885	3970	4145	4315		
40 km/h		1915	2220	2530	2835	3145	3450	3530	3615	3695	3780	3940	4105		
40 km/h Dual	1445	1710	1975	2240	2505	2770	3035	3110	3180	3255	3325	3470	3615		
50 km/h		1840	2135	2430	2720	3015	3310	3390	3470	3545	3625	3785	3940		
65 km/h			2060	2335	2605	2880	3150	3225	3300	3375	3450	3600	3750		
70 km/h				1875	2125	2375	2620	2870	2930	2990	3050	3110	3230	3350	

Ø inches	Description	CAI	e mm	D mm	R' mm	RC mm	Recommended Rim		Acceptable Rim	Tube (Code)	75% internal volume (litres)	Tread depth (mm)			
28	600/70R28 157D/154E TL	211033	629	1571	703	4652	1.7	1.8	DW20B (A)	DW18L DW21B(A)	717	448	54		
Bar	0.4	0.6	0.8	1	1.2	1.4	1.6	1.7	1.8	1.9	2	2.2	2.4	2.6	2.8
Psi	6	9	12	15	17	20	23	25	26	28	29	32	35	38	41
10 km/h	2475	2800	3125	3450	3855	4260	4665	4870	5070	5275	5475	5655	5835	6010	6190
30 km/h	1900	2265	2630	2995	3355	3720	4085	4170	4250	4335	4415	4580	4745		
40 km/h		2135	2485	2835	3185	3535	3885	3965	4045	4120	4200	4360	4515		
40 km/h Dual	1590	1895	2200	2505	2810	3115	3420	3490	3560	3630	3700	3835	3975		
50 km/h		2300	2615	2925	3240	3550	3620	3695	3765	3840	3980	4125	4330		
65 km/h		2095	2380	2665	2945	3230	3295	3360	3425	3490	3620	3750	4125		
70 km/h			2095	2380	2665	2945	3230	3295	3360	3425	3490	3620	3750		

* Refer to the notes at the end of the tables of this range

MICHELIN MACHXBIB

Tire specifications and pressure table (bar & psi). Load per tire in kg*

Ø inches	Description	CAI	e mm	D mm	R' mm	RC mm	Recommended Rim		Acceptable Rim		Tube (Code)	75% internal volume (litres)	Tread depth (mm)
28	600/70R28 157A8/157B TL	395016	623	1586	701	4694	DW20B (A)		DW18L		717	495	53
Bar	0.4 0.6 0.8	1	1.2	1.4	1.6	1.7	1.8	1.9	2	2.2	2.4		
Psi	6 9 12	15	17	20	23	25	26	28	29	32	35		
10 km/h		3470	3855	4245	4630	4825	5020	5215	5410	5800	6190		
30 km/h	1770 2160 2560	2955	3355	3750	4150	4185	4215	4250	4280	4345	4410		
40 km/h		2850	3200	3550	3900	3930	3960	3985	4015	4075	4130		
40 km/h Dual	1435 1795 2150	2510	2815	3125	3430	3455	3480	3505	3535	3585	3635		
50 km/h		3200	3550	3900	3930	3960	3985	4015	4075	4130			

Ø inches	Description	CAI	e mm	D mm	R' mm	RC mm	Recommended Rim		Acceptable Rim		Tube (Code)	75% internal volume (litres)	Tread depth (mm)
30	710/55R30 153D TL	992342	678	1518	668	4489	DW23B (A)					506	50
Bar	0.4 0.6 0.8	1	1.2	1.4	1.6	1.7	1.8	1.9					
Psi	6 9 12	15	17	20	23	25	26	28					
10 km/h	2475 2960 3370	3775	4185	4590	5000	5160	5320	5480					
30 km/h	1900 2270 2655	3040	3430	3815	4200								
40 km/h		2165	2530	2900	3265	3635	4000						
40 km/h Dual	1590 1905 2225	2550	2870	3195	3515								
50 km/h		2075	2425	2775	3130	3480	3830						
65 km/h		2300	2650	2985	3315	3650							

Ø inches	Description	CAI	e mm	D mm	R' mm	RC mm	Recommended Rim		Acceptable Rim		Tube (Code)	75% internal volume (litres)	Tread depth (mm)
30	600/70R30 158D TL	566557	638	1604	717	4760	DW20B (A)		DW18L DW21B (A)		737	468	56
Bar	0.4 0.6 0.8	1	1.2	1.4	1.6	1.7	1.8	1.9	2	2.2	2.4	2.6	2.8
Psi	6 9 12	15	17	20	23	25	26	28	29	32	35	38	41
10 km/h	2475 2830 3185	3540	3955	4375	4790	5000	5210	5415	5625	5815	6000	6190	6375
30 km/h	1900 2285 2665	3050	3435	3815	4200	4285	4375	4460	4545	4720	4890		
40 km/h		2190	2550	2910	3275	3635	3995	4080	4160	4245	4325	4490	4655
40 km/h Dual	1590 1910 2230	2555	2875	3195	3515	3590	3660	3735	3805	3950	4095		
50 km/h		2100	2445	2795	3140	3490	3835	3915	3995	4070	4150	4310	4465
65 km/h		2360	2685	3005	3325	3650	3725	3800	3875	3950	4100	4250	

* Refer to the notes at the end of the tables of this range

MICHELIN MACHXBIB

Tire specifications and pressure table (bar & psi). Load per tire in kg*

Ø inches	Description	CAI	e mm	D mm	R' mm	RC mm	Recommended Rim		Acceptable Rim		Tube (Code)	75% internal volume (litres)	Tread depth (mm)		
34	650/60R34 159D/155E TL	549996	659	1664	752	4950	DW21B (A)		DW20B (A) DW23B (A)		823	500	58		
Bar	0.4	0.6	0.8	1	1.2	1.4	1.6	1.7	1.8	1.9	2	2.2	2.4	2.6	2.8
Psi	6	9	12	15	17	20	23	25	26	28	29	32	35	38	41
10 km/h	2475	2800	3125	3450	3885	4320	4755	4975	5190	5410	5625	5860	6095	6330	6565
30 km/h	1900	2285	2665	3050	3435	3815	4200	4305	4410	4510	4615	4825	5030		
40 km/h		2190	2550	2910	3275	3635	3995	4095	4195	4295	4395	4590	4790		
40 km/h Dual	1590	1910	2230	2555	2875	3195	3515	3605	3690	3780	3865	4040	4215		
50 km/h		2100	2445	2795	3140	3490	3835	3930	4025	4120	4215	4405	4595		
65 km/h		2300	2640	2975	3310	3650	3740	3830	3920	4015	4195	4375			
70 km/h		2095	2400	2710	3015	3320	3390	3460	3530	3600	3735	3875			

Ø inches	Description	CAI	e mm	D mm	R' mm	RC mm	Recommended Rim		Acceptable Rim		Tube (Code)	75% internal volume (litres)	Tread depth (mm)		
34	650/65R34 161D/157E TL	817386	666	1726	779	5133	DW21B (A)		DW20B (A) DW23B (A)		823	555	58		
Bar	0.4	0.6	0.8	1	1.2	1.4	1.6	1.7	1.8	1.9	2	2.2	2.4	2.6	2.8
Psi	6	9	12	15	17	20	23	25	26	28	29	32	35	38	41
10 km/h	2700	3090	3475	3865	4290	4720	5145	5360	5575	5785	6000	6235	6470	6705	6940
30 km/h	2070	2470	2865	3265	3660	4055	4455	4600	4745	4885	5030	5175	5320		
40 km/h		2385	2755	3130	3500	3875	4245	4380	4520	4655	4790	4930	5065		
40 km/h Dual	1735	2070	2400	2735	3070	3400	3735	3855	3975	4095	4215	4335	4455		
50 km/h		2290	2645	3000	3360	3715	4070	4200	4335	4465	4595	4725	4855		
65 km/h		2575	2900	3225	3550	3875	4000	4125	4250	4375	4500	4625			
70 km/h		2345	2640	2935	3230	3525	3640	3755	3865	3980	4055	4125			

Ø inches	Description	CAI	e mm	D mm	R' mm	RC mm	Recommended Rim		Acceptable Rim		Tube (Code)	75% internal volume (litres)	Tread depth (mm)		
38	650/75R38 169D/165E TL	311026	709	1948	871	5786	DW23B (A)		MW23B (A)		804	731	64		
Bar	0.4	0.5	0.6	0.7	0.8	1	1.2	1.4	1.8	2	1.6	2.2	2.4	2.6	2.8
Psi	6	8	9	11	12	15	17	20	26	29	23	32	35	38	41
10 km/h	3360	3755	4150	4545	4940	5730	6145	6560	7375	7775	6975	8110	8400	8700	9000
30 km/h	2575	2835	3090	3350	3605	4120	4635	5150	5945	6220	5665	6440	6670		
40 km/h			2945	3190	3435	3925	4415	4905	5660	5920	5395	6130	6350		
40 km/h Dual			2590	2805	3025	3455	3885	4320	4980	5210	4750	5395	5590		
50 km/h			2820	3055	3295	3765	4235	4705	5425	5675	5175	5880	6090		
65 km/h			2690	2915	3140	3585	4030	4480	5165	5405	4925	5600	5800		
70 km/h			2445	2650	2855	3260	3670	4075	4705	4920	4485	5095	5150		

* Refer to the notes at the end of the tables of this range

MICHELIN MACHXBIB

Tire specifications and pressure table (bar & psi). Load per tire in kg*

Ø inches	Description	CAI	e mm	D mm	R' mm	RC mm	Recommended Rim		Acceptable Rim	Tube (Code)	75% internal volume (litres)	Tread depth (mm)			
38	650/85R38 173D/169E TL NEW	656640	673	673	925	6169	DW23B(A)		DW20B(A) MW23B(A)	804	856	66			
Bar	0.4	0.5	0.6	0.7	0.8	1	1.2	1.4	1.8	2	1.6	2.2	2.4	2.6	2.8
Psi	6	8	9	11	12	15	17	20	26	29	23	32	35	38	41
10 km/h	3750	4160	4575	4985	5395	6220	6865	7300	8400	9000	7800	9415	9825	10240	10650
30 km/h	2875	3160	3440	3725	4005	4573	5035	5495	6415	6873	5955	7175	7475		
40 km/h			3285	3555	3820	4359	4795	5235	6110	6545	5670	6835	7120		
40 km/h Dual			2890	3125	3360	3834	4220	4605	5375	5758	4990	6010	6265		
50 km/h			3150	3410	3665	4180	4600	5020	5855	6275	5435	6550	6825		
65 km/h				3550	4025	4415	4805	5585	5975	5195	6240	6500			
70 km/h				3168	3592	3940	4290	4985	5332	4635	5565	5800			

Ø inches	Description	CAI	e mm	D mm	R' mm	RC mm	Recommended Rim		Acceptable Rim	Tube (Code)	75% internal volume (litres)	Tread depth (mm)			
38	710/70R38 171D TL	708197	713	1973	871	5804	DW23B (A)		DW25B (A) MW23B (A) MW25B (A)	804	811	62			
Bar	0.4	0.6	0.8	1	1.2	1.4	1.6	1.7	1.8	1.9	2	2.2	2.4	2.6	2.8
Psi	6	9	12	15	17	20	23	25	26	28	29	32	35	38	41
10 km/h	3640	4250	4860	5470	6010	6550	7095	7365	7635	7905	8175	8440	8700	8965	9225
30 km/h	2790	3340	3890	4445	4995	5545	6095	6215	6340	6460	6585	6825	7070		
40 km/h		3190	3725	4255	4770	5290	5805	5920	6040	6155	6270	6505	6735		
40 km/h Dual	2340	2800	3260	3725	4185	4645	5105	5210	5310	5415	5515	5720	5925		
50 km/h		3060	3570	4080	4575	5070	5565	5675	5790	5900	6010	6235	6455		
65 km/h			3350	3840	4325	4815	5300	5405	5515	5620	5725	5940	6150		

Ø inches	Description	CAI	e mm	D mm	R' mm	RC mm	Recommended Rim		Acceptable Rim	Tube (Code)	75% internal volume (litres)	Tread depth (mm)			
38	650/85R38 173A8/173B TL	118628	686	2063	924	6092	DW23B (A)		DW20B (A) MW23B (A)	804	860	64			
Bar	0.4	0.6	0.8	1	1.2	1.4	1.6	1.7	1.8	1.9	2	2.2	2.4	2.6	2.8
Psi	6	9	12	15	17	20	23	25	26	28	29	32	35	38	41
10 km/h Cyc Dual				6400	6760	7120	7480	7665	7855	8040	8230	8605	8975	9350	9725
10 km/h	3750	4640	5530	6420	6780	7140	7500	7690	7875	8065	8250	8625	9000	9375	9750
30 km/h	2700	3445	4195	4940	5245	5545	5850	5990	6125	6265	6405	6680	6955		
40 km/h		3000	3820	4640	4910	5180	5450	5580	5715	5845	5975	6240	6500		
40 km/h Dual	2200	2830	3455	4085	4320	4560	4795	4910	5025	5140	5260	5490	5720		
50 km/h		3000	3820	4640	4910	5180	5450	5580	5715	5845	5975	6240	6500		

* Refer to the notes at the end of the tables of this range

MICHELIN MACHXBIB

Tire specifications and pressure table (bar & psi). Load per tire in kg*

Ø inches	Description	CAI	e mm	D mm	R' mm	RC mm	Recommended Rim	Acceptable Rim	Tube (Code)	75% internal volume (litres)	Tread depth (mm)
38	800/70R38 173D TL	887730	809	2066	899	6093	DW25B (A)	DW27B (A) MW25B (A)		1071	61
Bar	0.4	0.6	0.8	1	1.2	1.4	1.6	1.7	1.8	1.9	2
Psi	6	9	12	15	17	20	23	25	26	28	29
10 km/h Cyc Dual				5260	6155	7045	7940	8390	8835	9280	9725
10 km/h	4400	5115	5825	6540	7255	7965	8680	9035	9395	9750	
30 km/h	3375	4060	4740	5425	6110	6790	7475				
40 km/h		3860	4510	5165	5815	6470	7120				
40 km/h Dual	2825	3400	3970	4545	5115	5690	6260				
50 km/h		3700	4325	4950	5575	6200	6825				
65 km/h			4115	4710	5305	5905	6500				

Ø inches	Description	CAI	e mm	D mm	R' mm	RC mm	Recommended Rim	Acceptable Rim	Tube (Code)	75% internal volume (litres)	Tread depth (mm)
42	900/50R42 168D TL	832458	853	1970	870	5826	DW27B (A)	DW28B (A) DW30B (A)		923	55
Bar	0.4	0.6	0.8	1	1.2	1.4	1.6	1.7	1.8	1.9	
Psi	6	9	12	15	17	20	23	25	26	28	
10 km/h	3825	4575	5195	5810	6430	7045	7665	7910	8155	8400	
30 km/h	2930	3510	4095	4680	5270	5855	6440				
40 km/h		3340	3900	4455	5015	5570	6130				
40 km/h Dual	2455	2940	3430	3925	4415	4910	5400				
50 km/h		3200	3735	4270	4810	5345	5880				
65 km/h			3550	4090	4595	5095	5600				

Ø inches	Description	CAI	e mm	D mm	R' mm	RC mm	Recommended Rim	Acceptable Rim	Tube (Code)	75% internal volume (litres)	Tread depth (mm)				
42	710/70R42 173D TL	790388	721	2088	932	6195	DW23B (A)	DW25B (A) MW23B (A) MW25B (A)	802	872	64				
Bar	0.4	0.6	0.8	1	1.2	1.4	1.6	1.7	1.8	1.9	2	2.2	2.4	2.6	2.8
Psi	6	9	12	15	17	20	23	25	26	28	29	32	35	38	41
10 km/h Cyc Dual				4390	5190	5985	6785	7185	7580	7980	8380	8715	9050	9390	9725
10 km/h	3750	4375	5000	5625	6210	6795	7380	7675	7965	8260	8550	8850	9150	9450	9750
30 km/h	2875	3470	4065	4660	5250	5845	6440	6570	6700	6830	6960	7215	7475		
40 km/h		3285	3835	4380	4965	5545	6130	6255	6380	6500	6625	6875	7120		
40 km/h Dual	2410	2910	3405	3905	4405	4900	5400	5510	5615	5725	5835	6050	6265		
50 km/h		3150	3675	4200	4760	5320	5880	6000	6115	6235	6355	6590	6825		
65 km/h			4000	4535	5065	5600	6140	6275	6415	6555	6700	6850	7000		

* Refer to the notes at the end of the tables of this range

MICHELIN MACHXBIB

Tire specifications and pressure table (bar & psi). Load per tire in kg*

Ø inches	Description	CAI	e mm	D mm	R' mm	RC mm	Recommended Rim	Acceptable Rim	Tube (Code)	75% internal volume (litres)	Tread depth (mm)					
42	710/75R42 175D/171E TL	015540	693	2158	968	6408	DW23B (A)	DW25B (A)	802	867	61					
Bar	0.4	0.6	0.8	1	1.2	1.4	1.6	1.7	1.8	1.9	2	2.2	2.4	2.6	2.8	
Psi	6	9	12	15	17	20	23	25	26	28	29	32	35	38	41	
10 km/h	3975	4775	5575	6375	7050	7725	8400	8740	9075	9415	9750	10125	10500	10875	11250	
30 km/h	3050	3690	4335	4975	5615	6260	6900	7030	7160	7290	7420	7675	7935			
40 km/h		3560	4160	4765	5365	5970	6570	6695	6815	6940	7065	7310	7555			
40 km/h Dual	2555	3095	3630	4170	4705	5245	5780	5890	6000	6105	6215	6435	6650			
50 km/h		3415	3990	4570	5145	5725	6300	6420	6535	6655	6775	7010	7245			
65 km/h			3750	4315	4875	5440	6000	6115	6225	6340	6450	6675	6900			
70 km/h				3415	3925	4440	4950	5460	5545	5635	5720	5805	5980	6150		

Ø inches	Description	CAI	e mm	D mm	R' mm	RC mm	Recommended Rim	Acceptable Rim	Tube (Code)	75% internal volume (litres)	Tread depth (mm)
46	620/70R46 162D TL	131721	647	2038	907	6041	DW20B (A)	DW18L MW20B (A) TW20B	834	677	58
Bar	0.4	0.6	0.8	1	1.2	1.4	1.6	1.7	1.8	1.9	
Psi	6	9	12	15	17	20	23	25	26	28	
10 km/h	3180	3705	4235	4760	5285	5815	6340	6600	6865	7125	
30 km/h	2440	2945	3450	3955	4460	4960	5465				
40 km/h		2820	3300	3775	4250	4725	5200				
40 km/h Dual	2045	2465	2890	3310	3730	4155	4575				
50 km/h		2705	3165	3620	4075	4535	4990				
65 km/h			3000	3440	3875	4315	4750				

***IMPORTANT:**

The inflation pressure must always be appropriate for the load per tire, the speed of travel and the work to be done. Our recommendations above are provided subject to changes made after the date of publication of these tables. Technical data is subject to change without prior notice.

- For plowing and other field applications subject to high torque, use the 30 km/h line.
- When using single tire configuration:
 - add 0.4 bar for use on slopes of more than 20%
 - add 0.4 bar for intensive road use exceeding 50%
- 10 km/h: low torque application only

* Refer to the notes at the end of the tables of this range



MICHELIN XEOBIB

**EVERY DAY
ON ALL SURFACES
AT LESS THAN 1 BAR**



FOR LOW & MEDIUM TRACTORS

For special fitting on other vehicles, please contact your local sales representative.



VERY HIGH FLEXION STANDARD (VF)



YIELDS

- Potential increase in yields of **up to 4% year⁽¹⁾**
- Excellent **SERVICE LIFE**



FUEL SAVINGS

- Supports fuel saving in field operations



COMFORT

- Absorbs shocks & surface irregularities

(1) Study led by Harper Adams University, Newport, United Kingdom - from 2014 to 2016

SIZES

VF 480/60 28 134D TL

VF 520/60R28 138D TL

VF 600/60R28 146D TL

VF 600/60R30 147D TL

VF 600/60R34 149D TL

VF 600/60R38 151D TL

VF 650/60R38 155D TL

VF 710/60R38 160D TL

VF 650/60R42 157D TL

VF 710/60R42 161D TL

MICHELIN XEOBIB

Tire specifications and pressure table (bar & psi). Load per tire in kg*

Ø inches	Description	CAI	e mm	D mm	R' mm	RC mm	Recommended Rim	Acceptable Rim	Tube (Code)	75% internal volume (litres)	Tread depth (mm)
28	VF 480/60R28 134D TL	312875	488	1298	567	3831	DW16L	W16L	821	218	45
Bar	0.4	0.5	0.6	0.7	0.8	0.9	1	1.8			
Psi	6	7	9	10	12	13	15	26			
10 km/h	1450	1605	1760	1900	2035	2185	2330				
10 km/h Load Fr								3000			
30 km/h	1345	1490	1630	1760	1885	2025	2160				
65 km/h	1320	1460	1600	1725	1850	1985	2120				
65 km/h Dual	1160	1285	1410	1520	1630	1750	1865				

Ø inches	Description	CAI	e mm	D mm	R' mm	RC mm	Recommended Rim	Acceptable Rim	Tube (Code)	75% internal volume (litres)	Tread depth (mm)
28	VF 520/60R28 138D TL	510495	534	1338	579	3942	DW18L	W18L	822	260	46
Bar	0.4	0.5	0.6	0.7	0.8	0.9	1	1.8			
Psi	6	7	9	10	12	13	15	26			
10 km/h	1650	1815	1980	2125	2265	2430	2595				
10 km/h Load Fr								3350			
30 km/h	1530	1685	1835	1970	2100	2255	2405				
65 km/h	1500	1650	1800	1930	2060	2210	2360				
65 km/h Dual	1320	1455	1585	1700	1815	1945	2075				

Ø inches	Description	CAI	e mm	D mm	R' mm	RC mm	Recommended Rim	Acceptable Rim	Tube (Code)	75% internal volume (litres)	Tread depth (mm)
28	VF 600/60R28 146D TL	665184	597	1429	610	4198	DW20B (A)		822	365	48
Bar	0.4	0.5	0.6	0.7	0.8	0.9	1	1.8			
Psi	6	7	9	10	12	13	15	26			
10 km/h	2035	2250	2465	2690	2915	3110	3300				
10 km/h Load Fr								4250			
30 km/h	1885	2085	2285	2495	2705	2885	3060				
65 km/h	1850	2045	2240	2445	2650	2825	3000				
65 km/h Dual	1630	1800	1970	2150	2330	2485	2640				

* Refer to the notes at the end of the tables of this range

MICHELIN XEOBIB

Tire specifications and pressure table (bar & psi). Load per tire in kg*

Ø inches	Description	CAI	e mm	D mm	R' mm	RC mm	Recommended Rim	Acceptable Rim	Tube (Code)	75% internal volume (litres)	Tread depth (mm)
30	VF 600/60R30 147D TL	065253	603	1493	633	4379	DW20B (A)		757	383	50
Bar	0.4	0.5	0.6	0.7	0.8	0.9	1	1.8			
Psi	6	7	9	10	12	13	15	26			
10 km/h	2145	2340	2530	2765	3000	3195	3385				
10 km/h Load Fr								4375			
30 km/h	1990	2170	2345	2565	2780	2960	3135				
65 km/h	1950	2125	2300	2515	2725	2900	3075				
65 km/h Dual	1715	1870	2025	2215	2400	2555	2705				

Ø inches	Description	CAI	e mm	D mm	R' mm	RC mm	Recommended Rim	Acceptable Rim	Tube (Code)	75% internal volume (litres)	Tread depth (mm)
34	VF 600/60R34 149D TL	664777	595	1595	690	4699	DW20B (A)		823	416	48
Bar	0.4	0.5	0.6	0.7	0.8	0.9	1	1.8			
Psi	6	7	9	10	12	13	15	26			
10 km/h	2265	2470	2675	2935	3190	3385	3575				
10 km/h Load Fr								4550			
30 km/h	2100	2290	2480	2720	2960	3140	3315				
65 km/h	2060	2245	2430	2665	2900	3075	3250				
65 km/h Dual	1815	1980	2140	2345	2550	2705	2860				

Ø inches	Description	CAI	e mm	D mm	R' mm	RC mm	Recommended Rim	Acceptable Rim	Tube (Code)	75% internal volume (litres)	Tread depth (mm)
38	VF 600/60R38 151D TL	349257	549	1698	749	5023	DW20B (A)	MW20B (A)	824	452	52
Bar	0.4	0.5	0.6	0.7	0.8	0.9	1				
Psi	6	7	9	10	12	13	15				
10 km/h	2400	2620	2835	3070	3300	3550	3795				
30 km/h	2225	2425	2625	2845	3060	3290	3520				
65 km/h	2180	2380	2575	2790	3000	3225	3450				
65 km/h Dual	1920	2095	2265	2455	2640	2840	3035				

Ø inches	Description	CAI	e mm	D mm	R' mm	RC mm	Recommended Rim	Acceptable Rim	Tube (Code)	75% internal volume (litres)	Tread depth (mm)
38	VF 600/60R38 155D TL	454365	677	1735	749	5108	DW23B (A)	MW23B (A)	825	539	52
Bar	0.4	0.5	0.6	0.7	0.8	0.9	1				
Psi	6	7	9	10	12	13	15				
10 km/h	2675	2935	3190	3495	3795	4030	4265				
30 km/h	2480	2720	2960	3240	3520	3740	3955				
65 km/h	2430	2665	2900	3175	3450	3665	3875				
65 km/h Dual	2140	2345	2550	2795	3035	3225	3410				

* Refer to the notes at the end of the tables of this range

MICHELIN XEOBIB

Tire specifications and pressure table (bar & psi). Load per tire in kg*

Ø inches	Description	CAI	e mm	D mm	R' mm	RC mm	Recommended Rim	Acceptable Rim	Tube (Code)	75% internal volume (litres)	Tread depth (mm)
38	VF 710/60R38 160D TL	324138	712	1814	794	5356	DW25B (A)	MW25B (A)	825	665	54
Bar	0.4	0.5	0.6	0.7	0.8	0.9	1				
Psi	6	7	9	10	12	13	15				
10 km/h	3080	3385	3685	3975	4265	4610	4950				
30 km/h	2855	3135	3415	3685	3955	4275	4590				
65 km/h	2800	3075	3350	3615	3875	4190	4500				
65 km/h Dual	2465	2710	2950	3180	3410	3685	3960				

Ø inches	Description	CAI	e mm	D mm	R' mm	RC mm	Recommended Rim	Acceptable Rim	Tube (Code)	75% internal volume (litres)	Tread depth (mm)
42	VF 650/60R42 157D TL	220583	660	1840	810	5441	DW23B (A)	DW20B (A)	802	645	58
Bar	0.4	0.5	0.6	0.7	0.8	0.9	1				
Psi	6	7	9	10	12	13	15				
10 km/h	2835	3110	3385	3645	3905	4225	4540				
30 km/h	2625	2880	3135	3380	3620	3915	4210				
65 km/h	2575	2825	3075	3315	3550	3840	4125				
65 km/h Dual	2265	2485	2705	2915	3125	3380	3630				

Ø inches	Description	CAI	e mm	D mm	R' mm	RC mm	Recommended Rim	Acceptable Rim	Tube (Code)	75% internal volume (litres)	Tread depth (mm)
42	VF 710/60R42 161D TL	144294	716	1920	843	5675	DW25B (A)	MW25B (A)	802	713	57
Bar	0.4	0.5	0.6	0.7	0.8	0.9	1				
Psi	6	7	9	10	12	13	15				
10 km/h	3190	3495	3795	4170	4540	4815	5090				
30 km/h	2960	3240	3520	3865	4210	4465	4720				
65 km/h	2900	3175	3450	3790	4125	4375	4625				
65 km/h Dual	2550	2795	3035	3335	3630	3850	4070				

***IMPORTANT:**

The inflation pressure must always be appropriate for the load per tire, the speed of travel and the work to be done. Our recommendations above are provided subject to changes made after the date of publication of these tables (October 2020). Technical data is subject to change without prior notice.

- For plowing and other field applications subject to high torque, use the 30 km/h line.
- When using single tire configuration:
 - add 0.4 bar for use on slopes of more than 20%
 - add 0.4 bar for intensive road use exceeding 50%
- 10 km/h Fr Loader: application with front-end loader at max. speed of 10 km/h.
- 10 km/h: low torque application only.



MICHELIN MULTIBIB / MULTIBIB PLUS

EXCELLENT LONGEVITY
FOR INCREASED MILEAGE



FOR LOW & MEDIUM TRACTORS

For special fitting on other vehicles, please contact your local sales representative.



VERSATILITY

- Great performance in the field & on the road



PRODUCTIVITY

- High traction to save time & fuel
- Soil protection
- Capable of speeds of up to 65 km/h⁽¹⁾



SERVICE LIFE OPTIMIZE

- Thanks to flatter and wider crown, regular wear and up to 57 mm depth



COMFORT

- Excellent road handling
- Increased ride comfort



FOCUS ON THE NEW NEW MICHELIN MULTIBIB PLUS

- New architecture to reduce noise in the cab at high speed!
- Higher load capacity

(1) When authorised by the laws in force in the country

SIZES

320/65R16 107D TL

320/65R18 109A8/106B TL

340/65R18 113A8/110B TL

420/65R20 125A8/125B TL

440/65R20 128D TL

420/65R24 126D TL

440/65R24 128D TL

480/65R24 133D TL

540/65R24 140D TL

420/65R28 135D TL

440/65R28 131D TL

480/65R28 136D TL

540/65R28 142D TL

540/65R30 143D TL

540/65R34 145D TL

540/65R34 152D TL

600/65R34 151D TL

540/65R38 147D TL

600/65R38 153D TL

650/65R38 157D TL

650/65R42 158D TL

650/65 R38 163D TL NEW MULTIBIB PLUS

650/65 R42 165D TL NEW MULTIBIB PLUS

MICHELIN MULTIBIB/ MULTIBIB PLUS

Tire specifications and pressure table (bar & psi). Load per tire in kg*

Ø inches	Description	CAI	e mm	D mm	R' mm	RC mm	Recommended Rim	Acceptable Rim	Tube (Code)	75% internal volume (litres)	Tread depth (mm)
16	320/65R16 107D TL	494658	300	827	368	2452	W10L	W9		65	29
Bar	0.4	0.5	0.6	0.8	1	1.2	1.4	1.6	1.8	1.9	
Psi	6	7	9	12	15	17	20	23	26	28	
10 km/h	520	575	630	760	890	1015	1145	1270	1395	1460	
30 km/h	520	570	620	720	820	920	1025	1125			
40 km/h		530	580	680	780	875	975	1070			
50 km/h		510	555	650	745	840	935	1025			
65 km/h		490	535	625	715	800	890	975			

Ø inches	Description	CAI	e mm	D mm	R' mm	RC mm	Recommended Rim	Acceptable Rim	Tube (Code)	75% internal volume (litres)	Tread depth (mm)
18	320/65R18 109A8/106B TL <i>XM108</i>	123898	309	875	389	2594	W9	W10	444	64	28
Bar	0.4	0.5	0.6	0.8	1	1.2	1.4	1.6	1.7	1.8	1.9
Psi	6	7	9	12	15	17	20	23	25	26	28
10 km/h	400	535	670	805	940	1075	1210	1345	1415	1480	1550
30 km/h	390	500	610	710	805	905	1000	1100			
40 km/h		460	570	665	755	850	940	1030			
50 km/h		430	520	605	690	780	865	950			

Ø inches	Description	CAI	e mm	D mm	R' mm	RC mm	Recommended Rim	Acceptable Rim	Tube (Code)	75% internal volume (litres)	Tread depth (mm)
18	340/65R18 113A8/110B TL <i>XM108</i>	123888	337	908	399	2684	W9	W10 W11	444	80	28
Bar	0.4	0.5	0.6	0.8	1	1.2	1.4	1.6	1.7	1.8	1.9
Psi	6	7	9	12	15	17	20	23	25	26	28
10 km/h	450	600	750	900	1050	1200	1355	1505	1580	1655	1730
30 km/h	440	560	680	790	900	1010	1120	1230			
40 km/h		520	630	735	840	945	1050	1150			
50 km/h		480	580	675	770	870	965	1060			

Ø inches	Description	CAI	e mm	D mm	R' mm	RC mm	Recommended Rim	Acceptable Rim	Tube (Code)	75% internal volume (litres)	Tread depth (mm)
20	420/65R20 125A8/125B TL <i>XM108</i>	122702	396	1064	461	3135	W11	W10 W12	664	140	36
Bar	0.4	0.5	0.6	0.8	1	1.2	1.4	1.6	1.7	1.8	
Psi	6	7	9	12	15	17	20	23	25	26	
10 km/h	990	1170	1350	1570	1785	2005	2225	2440	2550		
30 km/h	790	950	1110	1290	1465	1645	1820				
40 km/h		850	1040	1205	1370	1535	1700				
50 km/h		850	1040	1150	1260	1370	1480	1590	1645	1700	

* Refer to the notes at the end of the tables of this range

MICHELIN MULTIBIB/ MULTIBIB PLUS

Tire specifications and pressure table (bar & psi). Load per tire in kg*

Ø inches	Description	CAI	e mm	D mm	R' mm	RC mm	Recommended Rim		Acceptable Rim	Tube (Code)	75% internal volume (litres)	Tread depth (mm)
20	440/65R20 128D TL	675464	445	1090	475	3260	W14L		W13 W15L	664	157	44
Bar	0.4	0.5	0.6	0.8	1	1.2	1.4	1.6	1.8	1.9	2	
Psi	6	7	9	12	15	17	20	23	26	28	29	
10 km/h	1200	1295	1390	1570	1750	1930	2125	2315	2510	2605	2700	
30 km/h	920	1020	1120	1305	1485	1670	1870		2070			
40 km/h			1070	1245	1415	1590	1780		1970			
40 km/h Dual	770	855	940	1095	1245	1400	1570		1735			
50 km/h			1025	1165	1310	1450	1670		1890			
65 km/h			975	1135	1290	1450	1625		1800			

Ø inches	Description	CAI	e mm	D mm	R' mm	RC mm	Recommended Rim		Acceptable Rim	Tube (Code)	75% internal volume (litres)	Tread depth (mm)
24	420/65R24 126D TL	171560	392	1156	508	3416	W12		11 DW12 W11	700	159	38
Bar	0.4	0.5	0.6	0.8	1	1.2	1.4	1.6	1.8	1.9	2	
Psi	6	7	9	12	15	17	20	23	26	28	29	
10 km/h	1200	1315	1425	1575	1725	1875	2025	2175	2365	2455	2550	
30 km/h	920	1010	1095	1290	1480	1670	1815		1955			
40 km/h			1040	1225	1410	1590	1725		1860			
50 km/h			1000	1175	1350	1525	1655		1785			
65 km/h			950	1120	1285	1450	1575		1700			

Ø inches	Description	CAI	e mm	D mm	R' mm	RC mm	Recommended Rim		Acceptable Rim	Tube (Code)	75% internal volume (litres)	Tread depth (mm)
24	440/65R24 128D TL	426389	439	1187	529	3519	DW14L		DW13 DW15L W13 W14L W15L	703	178	44
Bar	0.4	0.5	0.6	0.8	1	1.2	1.4	1.6	1.8	1.9	2	
Psi	6	7	9	12	15	17	20	23	26	28	29	
10 km/h	1285	1370	1450	1655	1855	2060	2225	2395	2560	2640	2725	
30 km/h	980	1080	1180	1380	1580	1780	1925		2070			
40 km/h			1130	1320	1510	1700	1835		1970			
40 km/h Dual	820	910	995	1160	1330	1495	1615		1735			
50 km/h			1080	1265	1445	1630	1760		1890			
65 km/h			1030	1205	1375	1550	1675		1800			

* Refer to the notes at the end of the tables of this range

MICHELIN MULTIBIB/ MULTIBIB PLUS

Tire specifications and pressure table (bar & psi). Load per tire in kg*

Ø inches	Description	CAI	e mm	D mm	R' mm	RC mm	Recommended Rim		Acceptable Rim	Tube (Code)	75% internal volume (litres)	Tread depth (mm)
24	480/65R24 133D TL	531721	483	1240	546	3667	DW15L		DW14L W14L W15L	710	219	46
Bar	0.4	0.5	0.6	0.8	1	1.2	1.4	1.6	1.8	1.9	2	
Psi	6	7	9	12	15	17	20	23	26	28	29	
10 km/h	1450	1575	1700	1920	2140	2360	2560	2755	2955	3050	3150	
30 km/h	1120	1240	1360	1575	1795	2010	2190	2370				
40 km/h			1290	1500	1710	1920	2090	2260				
40 km/h Dual	940	1040	1135	1320	1505	1690	1840	1990				
50 km/h			1240	1440	1640	1840	2000	2160				
65 km/h			1180	1370	1560	1750	1905	2060				

Ø inches	Description	CAI	e mm	D mm	R' mm	RC mm	Recommended Rim		Acceptable Rim	Tube (Code)	75% internal volume (litres)	Tread depth (mm)
24	540/65R24 140D TL	097057	532	1312	573	3873	DW16L		DW18L W16L W18L	710	288	48
Bar	0.4	0.5	0.6	0.8	1	1.2	1.4	1.6	1.8	1.9	2	
Psi	6	7	9	12	15	17	20	23	26	28	29	
10 km/h	1750	1875	2000	2265	2535	2800	3040	3275	3515	3630	3750	
30 km/h	1360	1485	1610	1885	2165	2440	2660	2880				
40 km/h			1530	1795	2055	2320	2530	2740				
40 km/h Dual	1140	1245	1345	1575	1810	2040	2225	2410				
50 km/h			1470	1725	1975	2230	2430	2630				
65 km/h			1400	1640	1880	2120	2310	2500				

Ø inches	Description	CAI	e mm	D mm	R' mm	RC mm	Recommended Rim		Acceptable Rim	Tube (Code)	75% internal volume (litres)	Tread depth (mm)			
28	420/65R28 135D TL	778211	390	1238	558	3680	W11		W12	732	177	44			
Bar	0.4	0.5	0.6	0.8	1	1.2	1.4	1.6	1.8	1.9	2	2.2	2.4	2.7	2.8
Psi	6	7	9	12	15	17	20	23	26	28	29	32	35	39	41
10 km/h	1275	1410	1545	1710	1875	2040	2185	2325	2495	2580	2665	2830	3000	3205	3270
30 km/h	980	1085	1185	1355	1535	1715	1890	2070	2180	2235	2290	2395	2505		
40 km/h			1130	1290	1460	1630	1800	1970	2075	2125	2180	2280	2385		
40 km/h Dual	820	910	995	1160	1330	1495	1615	1735	1825	1870	1920	2010	2100	2230	2275
50 km/h			1030	1240	1405	1565	1725	1890	1990	2040	2090	2190	2290		
65 km/h			1030	1180	1335	1490	1645	1800	1895	1945	1990	2085	2180		

* Refer to the notes at the end of the tables of this range

MICHELIN MULTIBIB/ MULTIBIB PLUS

Tire specifications and pressure table (bar & psi). Load per tire in kg*

Ø inches	Description	CAI	e mm	D mm	R' mm	RC mm	Recommended Rim		Acceptable Rim	Tube (Code)	75% internal volume (litres)	Tread depth (mm)
28	440/65R28 131D TL	386212	437	1291	579	3833	DW14L		DW15L W13 W14L W15L	821	198	43
Bar	0.4	0.5	0.6	0.8	1	1.2	1.4	1.6	1.8	1.9	2	
Psi	6	7	9	12	15	17	20	23	26	28	29	
10 km/h	1360	1480	1600	1795	1985	2180	2360	2540	2720	2810	2900	
30 km/h	1060	1155	1250	1465	1685	1900	2070	2240				
40 km/h			1190	1395	1605	1810	1975	2140				
40 km/h Dual	890	970	1045	1230	1410	1595	1740	1885				
50 km/h			1140	1335	1535	1730	1890	2050				
65 km/h			1090	1275	1465	1650	1800	1950				

Ø inches	Description	CAI	e mm	D mm	R' mm	RC mm	Recommended Rim		Acceptable Rim	Tube (Code)	75% internal volume (litres)	Tread depth (mm)
28	480/65R28 136D TL	897574	476	1339	596	3970	DW15L		DW14L W14L W15L	822	241	45
Bar	0.4	0.5	0.6	0.8	1	1.2	1.4	1.6	1.8	1.9	2	
Psi	6	7	9	12	15	17	20	23	26	28	29	
10 km/h	1550	1675	1800	2035	2265	2500	2715	2925	3140	3245	3350	
30 km/h	1180	1310	1440	1690	1940	2190	2385	2580				
40 km/h			1370	1605	1845	2080	2265	2450				
40 km/h Dual	990	1100	1205	1415	1620	1830	1995	2155				
50 km/h			1310	1540	1770	2000	2175	2350				
65 km/h			1250	1465	1685	1900	2070	2240				

Ø inches	Description	CAI	e mm	D mm	R' mm	RC mm	Recommended Rim		Acceptable Rim	Tube (Code)	75% internal volume (litres)	Tread depth (mm)
28	540/65R28 142D TL	792274	529	1427	630	4223	DW16L		DW18L W16L W18L	822	318	48
Bar	0.4	0.5	0.6	0.8	1	1.2	1.4	1.6	1.8	1.9	2	
Psi	6	7	9	12	15	17	20	23	26	28	29	
10 km/h	1900	2040	2180	2455	2725	3000	3250	3500	3750	3875	4000	
30 km/h	1440	1585	1730	2015	2295	2580	2815	3050				
40 km/h			1640	1910	2180	2450	2675	2900				
40 km/h Dual	1205	1325	1445	1680	1920	2155	2355	2550				
50 km/h			1580	1835	2095	2350	2565	2780				
65 km/h			1500	1745	1995	2240	2445	2650				

* Refer to the notes at the end of the tables of this range

MICHELIN MULTIBIB/ MULTIBIB PLUS

Tire specifications and pressure table (bar & psi). Load per tire in kg*

Ø inches	Description	CAI	e mm	D mm	R' mm	RC mm	Recommended Rim		Acceptable Rim	Tube (Code)	75% internal volume (litres)	Tread depth (mm)
30	540/65R30 143D TL	223153	527	1472	648	4353	DW16L		DW18L W16L W18L	754	333	48
Bar	0.4	0.5	0.6	0.8	1	1.2	1.4	1.6	1.8	1.9	2	
Psi	6	7	9	12	15	17	20	23	26	28	29	
10 km/h	1950	2095	2240	2520	2795	3075	3340	3600	3865	3995	4125	
30 km/h	1480	1630	1780	2070	2360	2650	2890		3130			
40 km/h			1700	1975	2245	2520	2750		2980			
40 km/h Dual	1240	1370	1495	1735	1980	2220	2420		2620			
50 km/h			1630	1895	2155	2420	2640		2860			
65 km/h			1550	1800	2050	2300	2515		2725			

Ø inches	Description	CAI	e mm	D mm	R' mm	RC mm	Recommended Rim		Acceptable Rim	Tube (Code)	75% internal volume (litres)	Tread depth (mm)
34	540/65R34 145D TL	712064	530	1574	693	4655	DW16L		DW18L W16L W18L	704	364	48
Bar	0.4	0.5	0.6	0.8	1	1.2	1.4	1.6	1.8	1.9	2	
Psi	6	7	9	12	15	17	20	23	26	28	29	
10 km/h	2060	2210	2360	2655	2955	3250	3530	3815	4095	4235	4375	
30 km/h	1560	1730	1900	2225	2555	2880	3110		3340			
40 km/h			1810	2120	2430	2740	2960		3180			
40 km/h Dual	1310	1455	1595	1865	2140	2410	2605		2800			
50 km/h			1730	2030	2330	2630	2840		3050			
65 km/h			1650	1935	2215	2500	2700		2900			

Ø inches	Description	CAI	e mm	D mm	R' mm	RC mm	Recommended Rim		Acceptable Rim	Tube (Code)	75% internal volume (litres)	Tread depth (mm)			
34	540/65R34 152D TL	214036	530	1590	709	4716	DW16L		DW18L W16L W18L	704	364	48			
Bar	0.4	0.5	0.6	0.8	1	1.2	1.4	1.6	1.8	1.9	2	2.2	2.4	2.7	2.8
Psi	6	7	9	12	15	17	20	23	26	28	29	32	35	39	41
10 km/h	2060	2210	2360	2655	2955	3250	3530	3815	4095	4235	4375	4625	4875	5215	5325
30 km/h	1560	1730	1900	2225	2555	2880	3110	3340	3525	3620	3710	3895	4080		
40 km/h			1810	2120	2430	2740	2960	3180	3360	3445	3535	3715		3890	
40 km/h Dual	1310	1455	1595	1865	2140	2410	2605	2800	2955	3035	3110	3265	3420		
50 km/h			1730	2030	2330	2630	2840	3050	3220	3305	3390	3560	3730		
65 km/h			1650	1935	2215	2500	2700	2900	3065	3145	3225	3390	3550		

* Refer to the notes at the end of the tables of this range

MICHELIN MULTIBIB/ MULTIBIB PLUS

Tire specifications and pressure table (bar & psi). Load per tire in kg*

Ø inches	Description	CAI	e mm	D mm	R' mm	RC mm	Recommended Rim	Acceptable Rim	Tube (Code)	75% internal volume (litres)	Tread depth (mm)
34	600/65R34 151D TL	557189	594	1654	732	4897	DW20B (A)	DW18L W18L	823	464	54
Bar	0.4	0.5	0.6	0.8	1	1.2	1.4	1.6	1.8	1.9	2
Psi	6	7	9	12	15	17	20	23	26	28	29
10 km/h	2430	2615	2800	3160	3515	3875	4195	4515	4830	4990	5150
30 km/h	1840	2040	2240	2605	2975	3340	3655	3970			
40 km/h			2140	2485	2835	3180	3480	3780			
40 km/h Dual	1540	1715	1885	2190	2495	2800	3065	3325			
50 km/h			2050	2385	2715	3050	3335	3620			
65 km/h			1950	2265	2585	2900	3175	3450			

Ø inches	Description	CAI	e mm	D mm	R' mm	RC mm	Recommended Rim	Acceptable Rim	Tube (Code)	75% internal volume (litres)	Tread depth (mm)
38	540/65R38 147D TL	114518	529	1675	745	4965	DW16L	DW18L W16L W18L	824	394	48
Bar	0.4	0.5	0.6	0.8	1	1.2	1.4	1.6	1.8	1.9	2
Psi	6	7	9	12	15	17	20	23	26	28	29
10 km/h	2180	2340	2500	2815	3135	3450	3745	4040	4330	4480	4625
30 km/h	1670	1840	2010	2325	2645	2960	3250	3540			
40 km/h			1920	2220	2520	2820	3095	3370			
40 km/h Dual	1400	1545	1690	1955	2215	2480	2725	2965			
50 km/h			1840	2125	2415	2700	2965	3230			
65 km/h			1750	2025	2300	2575	2825	3075			

Ø inches	Description	CAI	e mm	D mm	R' mm	RC mm	Recommended Rim	Acceptable Rim	Tube (Code)	75% internal volume (litres)	Tread depth (mm)
38	600/65R38 153D TL	228045	595	1768	779	5229	DW20B (A)	DW18L W18L	825	500	53
Bar	0.4	0.5	0.6	0.8	1	1.2	1.4	1.6	1.8	1.9	2
Psi	6	7	9	12	15	17	20	23	26	28	29
10 km/h	2575	2775	2970	3355	3740	4125	4455	4790	5120	5285	5450
30 km/h	1960	2165	2370	2760	3150	3540	3870	4200			
40 km/h			2260	2630	3000	3370	3685	4000			
40 km/h Dual	1645	1820	1990	2315	2640	2965	3245	3520			
50 km/h			2160	2515	2875	3230	3530	3830			
65 km/h			2060	2400	2735	3075	3365	3650			

* Refer to the notes at the end of the tables of this range

MICHELIN MULTIBIB/ MULTIBIB PLUS

Tire specifications and pressure table (bar & psi). Load per tire in kg*

Ø inches	Description	CAI	e mm	D mm	R' mm	RC mm	Recommended Rim	Acceptable Rim	Tube (Code)	75% internal volume (litres)	Tread depth (mm)
38	650/65R38 157D TL	292904	646	1819	801	5380	DW20B (A)		825	602	56
Bar	0.4	0.5	0.6	0.8	1	1.2	1.4	1.6	1.8	1.9	2
Psi	6	7	9	12	15	17	20	23	26	28	29
10 km/h	2900	3125	3350	3775	4200	4625	5005	5390	5770	5960	6150
30 km/h	2190	2420	2650	3090	3530	3970	4355	4740			
40 km/h			2520	2940	3360	3780	4150	4520			
40 km/h Dual	1835	2030	2220	2590	2955	3325	3655	3980			
50 km/h			2420	2820	3220	3620	3975	4330			
65 km/h			2300	2685	3065	3450	3790	4125			

Ø inches	Description	CAI	e mm	D mm	R' mm	RC mm	Recommended Rim	Acceptable Rim	Tube (Code)	75% internal volume (litres)	Tread depth (mm)
42	650/65R42 158D TL	167733	638	1931	858	5722	DW20B (A)		802	647	57
Bar	0.4	0.5	0.6	0.8	1	1.2	1.4	1.6	1.8	1.9	2
Psi	6	7	9	12	15	17	20	23	26	28	29
10 km/h	3000	3225	3450	3885	4315	4750	5155	5565	5970	6170	6375
30 km/h	2300	2545	2790	3260	3730	4200	4545	4890			
40 km/h			2660	3105	3555	4000	4325	4650			
40 km/h Dual	1930	2135	2340	2735	3125	3520	3805	4090			
50 km/h			2550	2975	3405	3830	4145	4460			
65 km/h			2430	2835	3245	3650	3950	4250			

MICHELIN MULTIBIB/ MULTIBIB PLUS

Tire specifications and pressure table (bar & psi). Load per tire in kg*

Ø inches	Description	CAI	e mm	D mm	R' mm	RC mm	Recommended Rim		Acceptable Rim		Tube (Code)	75% internal volume (litres)	Tread depth (mm)		
38	650/65R38 163D TL NEW	476461	664	1829	817	5425	DW20B (A)				825	604	58		
Bar	0.4	0.5	0.6	0.7	0.8	0.9	1	1.1	1.2	1.4	1.6	1.8	2	2.2	2.4
Psi	6	8	9	11	12	13	15	16	17	20	23	26	29	32	35
10 km/h	2900	3120	3340	3555	3775	3990	4200	4415	4625	5010	5390	5770	6150	6340	6530
30 km/h	2190	2415	2640	2865	3090	3310	3530	3750	3970	4355	4740	4990	5235	5425	5610
40 km/h					2940	3150	3360	3570	3780	4150	4520	4755	4985	5165	5340
40 km/h Dual	1835		2215	2400	2590	2775	2960	3140	3325	3655	3980	4185	4385	4545	4700
50 km/h					2820	3020	3220	3420	3620	3975	4330	4555	4780	4950	5120
65 km/h					2690	2880	3070	3260	3450	3790	4125	4340	4550	4715	4875

Ø inches	Description	CAI	e mm	D mm	R' mm	RC mm	Recommended Rim		Acceptable Rim		Tube (Code)	75% internal volume (litres)	Tread depth (mm)		
42	650/65R42 165D TL NEW	512785	638	1936	868.5	5752	DW20B (A)				802	643	57		
Bar	0.4	0.5	0.6	0.7	0.8	0.9	1	1.1	1.2	1.4	1.6	1.8	2	2.2	2.4
Psi	6	8	9	11	12	13	15	16	17	20	23	26	29	32	35
10 km/h	3000	3220	3445	3665	3885	4100	4320	4535	4750	5160	5565	5970	6375	6750	7125
30 km/h	2320	2555	2790	3025	3260	3495	3730	3965	4200	4570	4940	5205	5465	5695	5925
40 km/h					3105	3330	3555	3775	4000	4355	4705	4955	5200	5420	5640
40 km/h Dual	1930	2130	2335	2535	2735	2930	3130	3325	3520	3805	4090	4310	4530	4740	4950
50 km/h					2975	3190	3405	3615	3830	4170	4510	4750	4990	5200	5410
65 km/h					2835	3040	3245	3445	3650	3975	4295	4525	4750	4950	5150

***IMPORTANT:**

The inflation pressure must always be appropriate for the load per tire, the speed of travel and the work to be done. Our recommendations above are provided subject to changes made after the date of publication of these tables. Technical data is subject to change without prior notice.

- For plowing and other field applications subject to high torque, use the 30 km/h line.
- When using single tire configuration:
 - add 0.4 bar for use on slopes of more than 20%
 - add 0.4 bar for intensive road use exceeding 50%
- 10 km/h: low torque application only

* Refer to the notes at the end of the tables of this range



MICHELIN OMNIBIB

**GREATER VERSATILITY
TO OPTIMIZE YOUR COSTS**



FOR LOW & MEDIUM TRACTORS

For special fitting on other vehicles, please contact your local sales representative.



VERSATILITY

- Specially designed to withstand the stresses of work with front loaders
- Up to 14%⁽¹⁾ more **load capacity** versus equivalent standard radial sizes
- Excellent **stability & maneuverability** for work with livestock
- Super **traction** capacity



SERVICE LIFE

- Proven casing endurance
- Damage resistance

(1) Depending on tire sizes & compared with the equivalent size in MICHELIN AGRIBIB

SIZES

280/70R16 112D TL

280/70R20 116D TL

320/70R24 116D TL

360/70R24 122D TL

380/70R24 125D TL

420/70R24 130D TL

480/70R24 138D TL

380/70R28 127D TL

420/70R28 133D TL

480/70R28 140D TL

480/70R30 141D TL

480/70R34 143D TL

520/70R34 148D TL

480/70R38 145D TL

520/70R38 150D TL

580/70R38 155D TL

620/70R42 160D TL

MICHELIN OMNIBIB

Tire specifications and pressure table (bar & psi). Load per tire in kg*

Ø inches	Description	CAI	e mm	D mm	R' mm	RC mm	Recommended Rim		Acceptable Rim	Tube (Code)	75% internal volume (litres)	Tread depth (mm)			
16	280/70R16 112D TL	747196	276	805	360	2400	W9		W10L W8 WBL	184	45	29			
Bar	0.4	0.5	0.6	0.8	1	1.2	1.4	1.6	1.8	1.9	2	2.2	2.4	2.7	2.8
Psi	6	7	9	12	15	17	20	23	26	28	29	32	35	39	41
10 km/h	580	625	665	755	840	930	1015	1100	1190	1230	1275	1375	1480	1630	1680
30 km/h	445	490	535	625	715	800	890	980	1060	1095	1135	1215			
40 km/h			505	590	675	760	845	930	1005	1040	1080	1150			
40 km/h Dual	375	410	445	520	595	670	745	820	885	920	950	1015			
50 km/h			485	565	650	730	815	895	965	1000	1035	1105			
65 km/h			460	540	615	695	770	850	920	950	985	1055			

Ø inches	Description	CAI	e mm	D mm	R' mm	RC mm	Recommended Rim		Acceptable Rim	Tube (Code)	75% internal volume (litres)	Tread depth (mm)			
20	280/70R20 116D TL	263806	268	904	409	2690	W9		W10 W8	533	61	29			
Bar	0.4	0.5	0.6	0.8	1	1.2	1.4	1.6	1.8	1.9	2	2.2	2.4	2.7	2.8
Psi	6	7	9	12	15	17	20	23	26	28	29	32	35	39	41
10 km/h	640	690	740	835	935	1035	1130	1230	1325	1375	1425	1540	1650	1820	1875
30 km/h	490	540	590	690	795	895	995	1095	1180	1225	1270	1355			
40 km/h			565	660	755	850	945	1040	1125	1165	1205	1290			
50 km/h			540	630	725	815	910	1000	1080	1120	1160	1235			
65 km/h			515	600	690	775	865	950	1025	1065	1100	1175			

Ø inches	Description	CAI	e mm	D mm	R' mm	RC mm	Recommended Rim		Acceptable Rim	Tube (Code)	75% internal volume (litres)	Tread depth (mm)			
24	320/70R24 116D TL	415039	323	1101	497	3274	W10		W11 W9	692	94	40			
Bar	0.4	0.5	0.6	0.8	1	1.2	1.4	1.6	1.8	1.9	2				
Psi	6	7	9	12	15	17	20	23	26	28	29				
10 km/h	870	935	995	1125	1250	1375	1500	1630	1755	1815	1880				
30 km/h	670	735	800	925	1055	1185	1310								
40 km/h			760	880	1005	1125	1250								
40 km/h Dual	560	615	670	775	885	990	1100								
50 km/h			720	840	955	1075	1190								
65 km/h			690	800	915	1025	1140								

* Refer to the notes at the end of the tables of this range

MICHELIN OMNIBIB

Tire specifications and pressure table (bar & psi). Load per tire in kg*

Ø inches	Description	CAI	e mm	D mm	R' mm	RC mm	Recommended Rim		Acceptable Rim	Tube (Code)	75% internal volume (litres)	Tread depth (mm)
24	360/70R24 122D TL	198698	373	1153	513	3418	W11		W10 W12L	692	137	43
Bar	0.4	0.5	0.6	0.8	1	1.2	1.4	1.6	1.8	1.9	2	
Psi	6	7	9	12	15	17	20	23	26	28	29	
10 km/h	1040	1115	1190	1345	1495	1645	1795	1950	2100	2175	2250	
30 km/h	790	870	945	1105	1260	1415	1575	1730				
40 km/h			900	1050	1195	1345	1490	1640				
40 km/h Dual	665	730	795	925	1055	1185	1315	1445				
50 km/h			870	1010	1155	1295	1440	1580				
65 km/h			825	960	1095	1230	1365	1500				

Ø inches	Description	CAI	e mm	D mm	R' mm	RC mm	Recommended Rim		Acceptable Rim	Tube (Code)	75% internal volume (litres)	Tread depth (mm)
24	380/70R24 125D TL	085816	399	1188	528	3520	W12		W11 W13	700	161	45
Bar	0.4	0.5	0.6	0.8	1	1.2	1.4	1.6	1.8	1.9	2	
Psi	6	7	9	12	15	17	20	23	26	28	29	
10 km/h	1130	1215	1300	1470	1635	1805	1975	2145	2310	2395	2480	
30 km/h	860	945	1035	1205	1380	1555	1725	1900				
40 km/h			990	1155	1320	1480	1645	1810				
40 km/h Dual	725	795	865	1010	1155	1300	1445	1590				
50 km/h			950	1105	1260	1420	1575	1730				
65 km/h			900	1050	1200	1350	1500	1650				

Ø inches	Description	CAI	e mm	D mm	R' mm	RC mm	Recommended Rim		Acceptable Rim	Tube (Code)	75% internal volume (litres)	Tread depth (mm)
24	420/70R24 130D TL	829095	436	1251	553	3702	W13		DW14L W12L W14L	703	203	46
Bar	0.4	0.5	0.6	0.8	1	1.2	1.4	1.6	1.8	1.9	2	
Psi	6	7	9	12	15	17	20	23	26	28	29	
10 km/h	1310	1405	1505	1695	1890	2080	2275	2465	2660	2755	2850	
30 km/h	1010	1110	1205	1405	1600	1795	1995	2190				
40 km/h			1130	1320	1510	1700	1890	2080				
40 km/h Dual	845	920	995	1160	1330	1495	1665	1830				
50 km/h			1080	1265	1450	1630	1815	2000				
65 km/h			1030	1205	1380	1550	1725	1900				

* Refer to the notes at the end of the tables of this range

MICHELIN OMNIBIB

Tire specifications and pressure table (bar & psi). Load per tire in kg*

Ø inches	Description	CAI	e mm	D mm	R' mm	RC mm	Recommended Rim		Acceptable Rim		Tube (Code)	75% internal volume (litres)	Tread depth (mm)
24	480/70R24 138D TL	375821	494	1327	578	3916	DW15L		DW14L DW16L W14L W15L W16L		710	276	48
Bar	0.4	0.5	0.6	0.8	1	1.2	1.4	1.6	1.8	1.9	2		
Psi	6	7	9	12	15	17	20	23	26	28	29		
10 km/h	1590	1710	1835	2080	2320	2565	2810	3055	3295	3420	3540		
30 km/h	1220	1345	1470	1715	1965	2215	2460	2710					
40 km/h			1410	1645	1880	2110	2345	2580					
40 km/h Dual	1020	1130	1240	1445	1655	1860	2070	2275					
50 km/h			1350	1575	1800	2030	2255	2480					
65 km/h			1285	1500	1715	1930	2145	2360					

Ø inches	Description	CAI	e mm	D mm	R' mm	RC mm	Recommended Rim		Acceptable Rim		Tube (Code)	75% internal volume (litres)	Tread depth (mm)
28	380/70R28 127D TL	118587	390	1294	580	3842	W12		W11 W13		732	179	45
Bar	0.4	0.5	0.6	0.8	1	1.2	1.4	1.6	1.8	1.9	2		
Psi	6	7	9	12	15	17	20	23	26	28	29		
10 km/h	1200	1290	1380	1560	1735	1915	2095	2275	2450	2540	2630		
30 km/h	920	1010	1100	1285	1465	1645	1830	2010					
40 km/h			1040	1215	1390	1570	1745	1920					
40 km/h Dual	770	845	915	1070	1225	1375	1530	1685					
50 km/h			1000	1170	1335	1505	1670	1840					
65 km/h			950	1110	1270	1430	1590	1750					

Ø inches	Description	CAI	e mm	D mm	R' mm	RC mm	Recommended Rim		Acceptable Rim		Tube (Code)	75% internal volume (litres)	Tread depth (mm)
28	420/70R28 133D TL	532215	436	1354	602	4012	W13		DW14L W12 W14L		821	231	46
Bar	0.4	0.5	0.6	0.8	1	1.2	1.4	1.6	1.8	1.9	2		
Psi	6	7	9	12	15	17	20	23	26	28	29		
10 km/h	1390	1495	1605	1815	2030	2240	2455	2665	2880	2985	3090		
30 km/h	1060	1170	1280	1495	1715	1935	2150	2370					
40 km/h			1230	1435	1640	1850	2055	2260					
40 km/h Dual	890	985	1080	1260	1440	1625	1805	1985					
50 km/h			1180	1375	1570	1770	1965	2160					
65 km/h			1120	1310	1495	1685	1870	2060					

* Refer to the notes at the end of the tables of this range

MICHELIN OMNIBIB

Tire specifications and pressure table (bar & psi). Load per tire in kg*

Ø inches	Description	CAI	e mm	D mm	R' mm	RC mm	Recommended Rim		Acceptable Rim		Tube (Code)	75% internal volume (litres)	Tread depth (mm)
28	480/70R28 140D TL	570026	500	1427	632	4217	DW15L		DW14L DW16L W14L W15L W16L		822	302	48
Bar	0.4	0.5	0.6	0.8	1	1.2	1.4	1.6	1.8	1.9	2		
Psi	6	7	9	12	15	17	20	23	26	28	29		
10 km/h	1730	1855	1985	2235	2490	2740	2995	3245	3500	3625	3750		
30 km/h	1320	1450	1580	1840	2100	2360	2620	2880					
40 km/h			1490	1740	1990	2240	2490	2740					
40 km/h Dual	1110	1210	1310	1530	1750	1970	2190	2410					
50 km/h			1430	1670	1910	2150	2390	2630					
65 km/h			1360	1590	1815	2045	2270	2500					

Ø inches	Description	CAI	e mm	D mm	R' mm	RC mm	Recommended Rim		Acceptable Rim		Tube (Code)	75% internal volume (litres)	Tread depth (mm)
30	480/70R30 141D TL	599351	498	1482	656	4388	DW15L		DW14L DW16L W14L W15L W16L		754	317	48
Bar	0.4	0.5	0.6	0.8	1	1.2	1.4	1.6	1.8	1.9	2		
Psi	6	7	9	12	15	17	20	23	26	28	29		
10 km/h	1770	1900	2030	2295	2555	2815	3075	3340	3600	3730	3860		
30 km/h	1360	1495	1625	1895	2160	2425	2695	2960					
40 km/h			1530	1790	2045	2305	2560	2820					
40 km/h Dual	1135	1245	1350	1575	1800	2030	2255	2480					
50 km/h			1470	1715	1960	2210	2455	2700					
65 km/h			1400	1635	1870	2105	2340	2575					

Ø inches	Description	CAI	e mm	D mm	R' mm	RC mm	Recommended Rim		Acceptable Rim		Tube (Code)	75% internal volume (litres)	Tread depth (mm)
34	480/70R34 143D TL	280033	497	1593	713	4728	DW15L		DW14L DW16L W14L W15L W16L		704	345	50
Bar	0.4	0.5	0.6	0.8	1	1.2	1.4	1.6	1.8	1.9	2		
Psi	6	7	9	12	15	17	20	23	26	28	29		
10 km/h	1880	2020	2155	2435	2710	2985	3260	3540	3815	3950	4090		
30 km/h	1440	1580	1720	2005	2285	2565	2850	3130					
40 km/h			1640	1910	2175	2445	2710	2980					
40 km/h Dual	1205	1325	1445	1680	1915	2155	2390	2625					
50 km/h			1580	1835	2090	2350	2605	2860					
65 km/h			1500	1745	1990	2235	2480	2725					

* Refer to the notes at the end of the tables of this range

MICHELIN OMNIBIB

Tire specifications and pressure table (bar & psi). Load per tire in kg*

Ø inches	Description	CAI	e mm	D mm	R' mm	RC mm	Recommended Rim		Acceptable Rim		Tube (Code)	75% internal volume (litres)	Tread depth (mm)
34	520/70R34 148D TL	939411	535	1651	730	4887	DW16L		DW15L DW18L W15L W16L W18L		823	422	53
Bar	0.4	0.5	0.6	0.8	1	1.2	1.4	1.6	1.8	1.9	2		
Psi	6	7	9	12	15	17	20	23	26	28	29		
10 km/h	2100	2265	2430	2760	3085	3415	3745	4075	4400	4565	4730		
30 km/h	1610	1780	1945	2280	2615	2950	3285	3620					
40 km/h			1860	2180	2495	2815	3130	3450					
40 km/h Dual	1350	1495	1640	1920	2200	2475	2755	3035					
50 km/h			1790	2095	2400	2700	3005	3310					
65 km/h			1700	1990	2280	2570	2860	3150					

Ø inches	Description	CAI	e mm	D mm	R' mm	RC mm	Recommended Rim		Acceptable Rim		Tube (Code)	75% internal volume (litres)	Tread depth (mm)
38	480/70R38 145D TL	936570	498	1694	759	5030	DW15L		DW14L DW16L W14L W15L W16L		786	377	52
Bar	0.4	0.5	0.6	0.8	1	1.2	1.4	1.6	1.8	1.9	2		
Psi	6	7	9	12	15	17	20	23	26	28	29		
10 km/h	1980	2130	2275	2575	2870	3165	3460	3760	4055	4200	4350		
30 km/h	1520	1670	1825	2125	2430	2735	3035	3340					
40 km/h			1750	2035	2320	2610	2895	3180					
40 km/h Dual	1270	1405	1540	1790	2040	2295	2545	2795					
50 km/h			1680	1955	2230	2500	2775	3050					
65 km/h			1600	1860	2120	2380	2640	2900					

Ø inches	Description	CAI	e mm	D mm	R' mm	RC mm	Recommended Rim		Acceptable Rim		Tube (Code)	75% internal volume (litres)	Tread depth (mm)
38	520/70R38 150D TL	833744	539	1766	782	5229	DW16L		DW15L DW18L W15L W16L W18L		824	464	53
Bar	0.4	0.5	0.6	0.8	1	1.2	1.4	1.6	1.8	1.9	2		
Psi	6	7	9	12	15	17	20	23	26	28	29		
10 km/h	2250	2425	2600	2945	3295	3640	3990	4335	4685	4855	5030		
30 km/h	1730	1905	2085	2435	2790	3145	3495	3850					
40 km/h			1970	2310	2650	2990	3330	3670					
40 km/h Dual	1445	1590	1735	2035	2335	2630	2930	3230					
50 km/h			1890	2215	2540	2870	3195	3520					
65 km/h			1800	2110	2420	2730	3040	3350					

* Refer to the notes at the end of the tables of this range

MICHELIN OMNIBIB

Tire specifications and pressure table (bar & psi). Load per tire in kg*

Ø inches	Description	CAI	e mm	D mm	R' mm	RC mm	Recommended Rim		Acceptable Rim	Tube (Code)	75% internal volume (litres)	Tread depth (mm)
38	580/70R38 155D TL	001240	601	1836	815	5440	DW18L		W18L	825	590	56
Bar	0.4	0.5	0.6	0.8	1	1.2	1.4	1.6	1.8	1.9	2	
Psi	6	7	9	12	15	17	20	23	26	28	29	
10 km/h	2630	2830	3030	3425	3825	4220	4620	5015	5415	5610	5810	
30 km/h	2010	2215	2420	2825	3235	3645	4050	4460				
40 km/h			2320	2705	3090	3470	3855	4240				
40 km/h Dual	1685	1865	2045	2385	2720	3060	3395	3735				
50 km/h			2230	2600	2965	3335	3700	4070				
65 km/h			2120	2470	2820	3175	3525	3875				

Ø inches	Description	CAI	e mm	D mm	R' mm	RC mm	Recommended Rim		Acceptable Rim	Tube (Code)	75% internal volume (litres)	Tread depth (mm)
42	620/70R42 160D TL	989457	639	1953	863	5781	DW20B (A)		DW18L	802	658	58
Bar	0.4	0.5	0.6	0.8	1	1.2	1.4	1.6	1.8	1.9	2	
Psi	6	7	9	12	15	17	20	23	26	28	29	
10 km/h	3090	3320	3550	4005	4465	4920	5380	5835	6295	6520	6750	
30 km/h	2370	2605	2840	3305	3775	4245	4710	5180				
40 km/h			2660	3115	3570	4020	4475	4930				
40 km/h Dual	1985	2165	2340	2740	3140	3535	3935	4335				
50 km/h			2550	2985	3420	3860	4295	4730				
65 km/h			2430	2845	3260	3670	4085	4500				

***IMPORTANT:**

The inflation pressure must always be appropriate for the load per tire, the speed of travel and the work to be done. Our recommendations above are provided subject to changes made after the date of publication of these tables. Technical data is subject to change without prior notice.

- For plowing and other field applications subject to high torque, use the 30 km/h line.
- When using single tire configuration:
 - add 0.4 bar for use on slopes of more than 20%
 - add 0.4 bar for intensive road use exceeding 50%
- 10 km/h: low torque application only



MICHELIN YIELDBIB

**THE LOW-PRESSURE TIRE
FOR HIGH-POWERED
ROW-CROP APPLICATIONS**



FOR HIGH POWER TRACTORS



VF VERY HIGH FLEXION



SOIL PROTECTION

+27% **larger footprint** to protect soil from compaction and improve yields ⁽¹⁾



MORE TRACTION

More traction from 2 additional 45 degree lugs



PRODUCTIVITY

carry **up to 40% more load** at the same pressure versus non-VF radial tire in the same size

(1) Michelin test 2016, VF 480/80 R50 MICHELIN YIELDBIB vs 480/80 R50 MICHELIN AGRIBIB.

SIZES

VF 380/85R34 149A8/149B TL
VF 420/85R34 154A8/154B TL
VF 380/80R38 149A8/149B TL
VF 380/95R38 154A8/154B TL
VF 480/80R46 164A8/164B TL
VF 480/80R50 166A8/166B TL
VF 480/95R50 170A8/170B TL

MICHELIN YIELDBIB

Tire specifications and pressure table (bar & psi). Load per tire in kg*

Ø inches	Description	CAI	e mm	D mm	R' mm	RC mm	Recommended Rim		Acceptable Rim		Tube (Code)	75% internal volume (litres)	Tread depth (mm)
34	VF 380/85R34 149A8/149B TL	305457	372	1510	668	4471	W13	W12	704	230	44		
Bar	0.4 0.5 0.6 0.7 0.8 0.9 1 1.1 1.2 1.3 1.4 1.5 1.6												
Psi	6 7 9 10 12 13 15 16 17 19 20 22 23												
10 km/h	1595	1760	1925	2090	2255	2420	2585	2750	2915	3080	3245	3410	3575
30 km/h	1480	1635	1785	1940	2090	2245	2400	2550	2705	2860	3010	3165	3315
30 km/h Dual	1300	1435	1570	1705	1840	1975	2110	2245	2380	2515	2650	2780	2915
30 km/h Triple	1215	1340	1465	1590	1715	1840	1970	2095	2220	2345	2470	2595	2720
50 km/h	1450	1600	1750	1900	2050	2200	2350	2500	2650	2800	2950	3100	3250
50 km/h Dual	1280	1410	1545	1675	1805	1940	2070	2205	2335	2465	2600	2730	2860
50 km/h Triple	1190	1315	1435	1560	1680	1805	1930	2050	2175	2300	2420	2545	2665

Ø inches	Description	CAI	e mm	D mm	R' mm	RC mm	Recommended Rim		Acceptable Rim		Tube (Code)	75% internal volume (litres)	Tread depth (mm)
34	VF 420/85R34 154A8/154B TL	012445	432	1582	699	4682	DW15L	DW14A (L) W13 W14L W15A (L)	704	287	48		
Bar	0.4 0.5 0.6 0.7 0.8 0.9 1 1.1 1.2 1.3 1.4 1.5 1.6												
Psi	6 7 9 10 12 13 15 16 17 19 20 22 23												
10 km/h	1870	2060	2250	2440	2630	2820	3010	3195	3385	3570	3755	3940	4125
30 km/h	1735	1910	2090	2265	2440	2615	2790	2960	3135	3310	3480	3655	3825
30 km/h Dual	1525	1680	1835	1990	2145	2300	2455	2605	2760	2910	3065	3215	3365
30 km/h Triple	1425	1570	1715	1855	2000	2145	2285	2430	2570	2710	2855	2995	3135
50 km/h	1700	1875	2045	2220	2390	2560	2735	2905	3075	3245	3415	3580	3750
50 km/h Dual	1500	1650	1805	1955	2105	2255	2405	2555	2705	2855	3005	3150	3300
50 km/h Triple	1395	1535	1680	1820	1960	2100	2240	2380	2520	2660	2800	2935	3075

Ø inches	Description	CAI	e mm	D mm	R' mm	RC mm	Recommended Rim		Acceptable Rim		Tube (Code)	75% internal volume (litres)	Tread depth (mm)
38	VF 380/80R38 149A8/149B TL	870363	366	1592	711	4851	DW12A	W12 W13	796 795	230	45		
Bar	0.4 0.5 0.6 0.7 0.8 0.9 1 1.1 1.2 1.3 1.4 1.5 1.6												
Psi	6 7 9 10 12 13 15 16 17 19 20 22 23												
10 km/h	1595	1760	1930	2095	2260	2425	2590	2755	2920	3085	3250	3410	3575
30 km/h	1480	1635	1790	1940	2095	2250	2405	2555	2710	2860	3015	3165	3315
30 km/h Dual	1300	1435	1575	1710	1845	1980	2115	2250	2385	2520	2650	2785	2915
30 km/h Triple	1215	1340	1470	1595	1720	1845	1970	2095	2220	2345	2470	2595	2720
50 km/h	1450	1600	1755	1905	2055	2205	2355	2505	2655	2805	2955	3100	3250
50 km/h Dual	1280	1415	1550	1680	1815	1945	2080	2210	2340	2470	2600	2730	2860
50 km/h Triple	1190	1315	1440	1560	1685	1810	1935	2055	2180	2300	2425	2545	2665

* Refer to the notes at the end of the tables of this range

MICHELIN YIELDBIB

Tire specifications and pressure table (bar & psi). Load per tire in kg*

Ø inches	Description	CAI	e mm	D mm	R' mm	RC mm	Recommended Rim		Acceptable Rim		Tube (Code)	75% internal volume (litres)	Tread depth (mm)
38	VF 380/95R38 154A8/154B TL	873023	377	1703	755	5044	DW12A	W12	795 796	286	47		
Bar	0.4	0.5	0.6	0.7	0.8	0.9	1	1.1	1.2	1.3	1.4	1.5	1.6
Psi	6	7	9	10	12	13	15	16	17	19	20	22	23
10 km/h	1870	2060	2250	2435	2625	2810	3000	3185	3370	3560	3750	3935	4125
30 km/h	1735	1910	2085	2260	2435	2610	2780	2955	3125	3300	3475	3650	3825
30 km/h Dual	1525	1680	1835	1990	2145	2295	2450	2600	2750	2905	3060	3210	3365
30 km/h Triple	1425	1570	1710	1855	1995	2140	2280	2425	2565	2710	2850	2995	3135
50 km/h	1700	1870	2045	2215	2385	2555	2725	2895	3065	3235	3410	3580	3750
50 km/h Dual	1500	1650	1800	1950	2100	2250	2400	2550	2700	2850	3000	3150	3300
50 km/h Triple	1400	1540	1680	1815	1955	2095	2235	2375	2515	2655	2795	2935	3075

Ø inches	Description	CAI	e mm	D mm	R' mm	RC mm	Recommended Rim		Acceptable Rim		Tube (Code)	75% internal volume (litres)	Tread depth (mm)
46	VF 480/80R46 164A8/164B TL	842300	480	1933	861	5732	DW16A	DW15L DW16B DW16L W16A	834	449	52		
Bar	0.4	0.5	0.6	0.7	0.8	0.9	1	1.1	1.2	1.3	1.4	1.5	1.6
Psi	6	7	9	10	12	13	15	16	17	19	20	22	23
10 km/h	2530	2780	3025	3275	3520	3770	4015	4265	4510	4760	5005	5255	5500
30 km/h	2345	2575	2805	3035	3265	3495	3725	3950	4180	4410	4640	4870	5100
30 km/h Dual	2065	2270	2470	2675	2875	3075	3280	3480	3680	3885	4085	4290	4490
30 km/h Triple	1925	2115	2300	2490	2675	2865	3055	3240	3430	3620	3805	3995	4180
50 km/h	2300	2525	2750	2975	3200	3425	3650	3875	4100	4325	4550	4775	5000
50 km/h Dual	2025	2225	2420	2620	2815	3015	3215	3410	3610	3810	4005	4205	4400
50 km/h Triple	1885	2070	2255	2440	2625	2810	2995	3175	3360	3545	3730	3915	4100

Ø inches	Description	CAI	e mm	D mm	R' mm	RC mm	Recommended Rim		Acceptable Rim		Tube (Code)	75% internal volume (litres)	Tread depth (mm)
50	VF 480/80R50 166A8/166B TL	309830	468	2039	901	6034	DW16A(L)	DW15B (A) DW15L DW16B W15B (A) W16B		479	49		
Bar	0.4	0.5	0.6	0.7	0.8	0.9	1	1.1	1.2	1.3	1.4	1.5	1.6
Psi	6	7	9	10	12	13	15	16	17	19	20	22	23
10 km/h	2595	2855	3115	3375	3635	3895	4155	4415	4675	4935	5255	5540	5830
30 km/h	2405	2645	2890	3130	3370	3610	3855	4095	4335	4605	4870	5140	5405
30 km/h Dual	2115	2330	2540	2755	2965	3180	3390	3605	3815	4050	4285	4520	4755
30 km/h Triple	1970	2170	2370	2565	2765	2965	3160	3360	3555	3775	3995	4210	4430
50 km/h	2360	2595	2835	3070	3305	3540	3780	4015	4250	4515	4775	5040	5300
50 km/h Dual	2075	2285	2495	2700	2910	3120	3325	3535	3740	3970	4200	4430	4660
50 km/h Triple	1930	2125	2320	2515	2710	2905	3100	3295	3490	3705	3920	4135	4350

* Refer to the notes at the end of the tables of this range

MICHELIN YIELDBIB

Tire specifications and pressure table (bar & psi). Load per tire in kg*

Ø inches	Description	CAI	e mm	D mm	R' mm	RC mm	Recommended Rim			Acceptable Rim		Tube (Code)	75% internal volume (litres)	Tread depth (mm)
50	VF 480/95R50 170A8/170B TL	252129	477	2186	962	6464	DW16L			DW15L (NRO) W15L (NRO) W16L			593	51
Bar	0.4 0.5 0.6 0.7 0.8 0.9 1 1.1 1.2 1.3 1.4 1.5 1.6													
Psi	6 7 9 10 12 13 15 16 17 19 20 22 23													
10 km/h	3000 3315 3625 3940 4250 4565 4875 5190 5500 5775 6050 6325 6600													
30 km/h	2780 3070 3360 3650 3940 4230 4520 4810 5100 5355 5610 5865 6120													
30 km/h Dual	2445 2700 2955 3210 3465 3720 3980 4235 4490 4715 4940 5160 5385													
30 km/h Triple	2280 2520 2755 2995 3230 3470 3705 3945 4180 4390 4600 4810 5020													
50 km/h	2725 3010 3295 3580 3865 4150 4435 4715 5000 5250 5500 5750 6000													
50 km/h Dual	2400 2650 2900 3150 3400 3650 3900 4150 4400 4620 4840 5060 5280													
50 km/h Triple	2235 2470 2705 2935 3170 3405 3635 3870 4100 4305 4510 4715 4920													

***IMPORTANT:**

The inflation pressure must always be appropriate for the load per tire, the speed of travel and the work to be done. Our recommendations above are provided subject to changes made after the date of publication of these tables. Technical data is subject to change without prior notice.

- For plowing and other field applications subject to high torque, use the 30 km/h line.
- When using single tire configuration:
 - add 0.4 bar for use on slopes of more than 20%
 - add 0.4 bar for intensive road use exceeding 50%
- 10 km/h: low torque application only



MICHELIN AGRIBIB 2

**HIGH LEVELS
OF PERFORMANCE
THROUGHOUT ITS LIFE**



FOR ALL TRACTORS FROM LOW TO HIGH POWER

For special fitting on other vehicles, please contact your local sales representative.



OPTIMAL TRACTION

with 45° lug angle



SERVICE LIFE thanks to deep tread lugs

up to 8% deeper tread than leading competitors R1W Radial type tire offer⁽¹⁾



ROBUSTNESS

up to 18% higher load index⁽²⁾

(1) MICHELIN AGRIBIB 2 480/80R50 vs leading competitors published depths

(2) Depending on size & for size 520/85 R46 164A8/164B

SIZES

New sizes of MICHELIN AGRIBIB 2 will be available between August and December 2022, depending on the sizes

280/85R24 120A8/120B TL	NEW
320/85R24 127A8/127B TL	NEW
340/85R24 130A8/130B TL	NEW
380/85R24 137A8/137B TL	NEW
420/85R24 142A8/142B TL	NEW
480/80R26 149A8/149B TL	
280/85R28 123A8/120D TL	
340/85R28 133A8/133B TL	NEW
380/85R28 139A8/139B TL	NEW
420/85R28 144A8/144B TL	NEW
380/85R30 140A8/140B TL	

420/85R30 145A8/139D TL	NEW
420/90R30 147A8/147B TL	
460/85R30 150A8/150B TL	NEW
650/75R32 167A8/167B TL	
320/85R34 133A8/133B TL	
380/85R34 142A8/142B TL	
420/85R34 147A8/147B TL	
460/85R34 152A8/152B TL	NEW
340/85R38 138A8/138B TL	NEW
380/80R38 142A8/139D TL	
420/85R38 149A8/149B TL	

460/85R38 154A8/154B TL	NEW
520/85R38 160A8/160B TL	
480/80R42 156A8/156B TL	
520/85R42 162A8/162B TL	
420/80R46 151A8/151B TL	
480/80R46 158A8/158B TL	
520/85R46 164A8/164B TL	
480/80R50 159A8/159B TL	
380/90R54 152A8/152B TL	

MICHELIN AGRIBIB 2

Tire specifications and pressure table (bar & psi). Load per tire in kg*

Ø inches	Description	CAI	e mm	D mm	R' mm	RC mm	Recommended Rim		Acceptable Rim	Tube (Code)	75% internal volume (litres)	Tread depth (mm)			
24	280/85R24 120A8/120B TL NEW	990406	289	1086	503	3261	W10		W9	692	88	41			
Bar	0.4	0.5	0.6	0.7	0.8	1	1.2	1.4	1.8	2	1.6	2.2	2.4	2.6	2.8
Psi	6	8	9	11	12	15	17	20	26	29	23	32	35	38	41
10 km/h	840	925	1005	1090	1170	1335	1480	1590	1780	1875	1685	1930	1988	2045	2100
30 km/h	600	660	715	775	835	950	1040	1130	1310	1400	1220	1450			
40 km/h			670	725	780	888	970	1055	1225	1308	1140	1355			
40 km/h Dual			590	725	685	780	855	930	1075	1150	1000	1190			
50 km/h			670	640	780	888	970	1055	1225	1308	1140	1355			

Ø inches	Description	CAI	e mm	D mm	R' mm	RC mm	Recommended Rim		Acceptable Rim	Tube (Code)	75% internal volume (litres)	Tread depth (mm)			
24	320/85R24 127A8/127B TL NEW	812603	330	1149	521	3422	W11		W10	692	121	42			
Bar	0.4	0.5	0.6	0.7	0.8	1	1.2	1.4	1.8	2	1.6	2.2	2.4	2.6	2.8
Psi	6	8	9	11	12	15	17	20	26	29	23	32	35	38	41
10 km/h	1005	1110	1210	1315	1415	1620	1800	1925	2180	2325	2040	2400	2475	2550	2625
30 km/h	715	790	865	935	1010	1158	1275	1390	1625	1740	1505	1810			
40 km/h			825	890	955	1083	1190	1300	1515	1625	1410	1690			
40 km/h Dual			725	890	840	953	1050	1145	1335	1430	1240	1485			
50 km/h			825	780	955	1083	1190	1300	1515	1625	1410	1690			

Ø inches	Description	CAI	e mm	D mm	R' mm	RC mm	Recommended Rim		Acceptable Rim	Tube (Code)	75% internal volume (litres)	Tread depth (mm)			
24	340/85R24 130A8/130B TL NEW	694878	363	1202	547	3580	W12		W11	700	139	43			
Bar	0.4	0.5	0.6	0.7	0.8	1	1.2	1.4	1.8	2	1.6	2.2	2.4	2.6	2.8
Psi	6	8	9	11	12	15	17	20	26	29	23	32	35	38	41
10 km/h	1125	1240	1355	1470	1585	1810	2040	2145	2250	2400	2550	2625	2700	2775	2850
30 km/h	805	885	965	1035	1100	1280	1455	1610	1765	1835	1900	1970			
40 km/h			900	965	1030	1195	1360	1505	1650	1715	1775	1840			
40 km/h Dual			790	850	905	1050	1195	1325	1450	1505	1560	1615			
50 km/h			900	965	1030	1195	1360	1505	1650	1715	1775	1840			

* Refer to the notes at the end of the tables of this range

MICHELIN AGRIBIB 2

Tire specifications and pressure table (bar & psi). Load per tire in kg*

Ø inches	Description	CAI	e mm	D mm	R' mm	RC mm	Recommended Rim		Acceptable Rim		Tube (Code)	75% internal volume (litres)	Tread depth (mm)		
24	380/85R24 137A8/137B TL NEW	281463	392	1252	562	3718	W13		W11 W12		703	180	47		
Bar	0.4	0.5	0.6	0.7	0.8	1	1.2	1.4	1.8	2	1.6	2.2	2.4	2.6	2.8
Psi	6	8	9	11	12	15	17	20	26	29	23	32	35	38	41
10 km/h	1315	1450	1585	1720	1860	2130	2400	2515	2625	2815	3000	3115	3225	3340	3450
30 km/h	935	1035	1135	1240	1340	1525	1710	1900	2085	2180	2275	2365	2460		
40 km/h			1060	1155	1250	1425	1600	1775	1950	2040	2125	2215	2300		
40 km/h Dual			935	1020	1100	1255	1410	1565	1715	1795	1870	1950	2025		
50 km/h			1060	1155	1250	1425	1600	1775	1950	2040	2125	2215	2300		

Ø inches	Description	CAI	e mm	D mm	R' mm	RC mm	Recommended Rim		Acceptable Rim		Tube (Code)	75% internal volume (litres)	Tread depth (mm)		
24	420/85R24 142A8/142B TL NEW	136458	444	1342	598	3987	DW15		W14L W15L DW14L		710	228	55		
Bar	0.4	0.5	0.6	0.7	0.8	1	1.2	1.4	1.8	2	1.6	2.2	2.4	2.6	2.8
Psi	6	8	9	11	12	15	17	20	26	29	23	32	35	38	41
10 km/h	1545	1700	1855	2005	2160	2470	2775	2935	3315	3540	3090	3650	3760	3865	3975
30 km/h	1100	1220	1340	1445	1550	1765	1980	2220	2555	2650	2460	2740	2835		
40 km/h			1250	1350	1450	1650	1850	2075	2390	2475	2300	2565	2650		
40 km/h Dual			1100	1350	1275	1455	1630	1830	2100	2180	2025	2255	2330		
50 km/h			1250	1190	1450	1650	1850	2075	2390	2475	2300	2565	2650		

Ø inches	Description	CAI	e mm	D mm	R' mm	RC mm	Recommended Rim		Acceptable Rim		Tube (Code)	75% internal volume (litres)	Tread depth (mm)		
26	480/80R26 149A8/149B TL <i>South America</i>	466081	500	1416	633	4202	DW16B(A)		DW15B(A)			297	51		
Bar	0.4	0.6	0.8	1	1.2	1.4	1.6	1.8	2	2.2	2.4	2.6	2.8		
Psi	6	9	12	15	17	20	23	26	29	32	35	38	41		
10 km/h	1875	2245	2620	2990	3360	3555	3750	3975	4200	4370	4540	4705	4875		
30 km/h	1340	1605	1875	2135	2395	2655	2915	3055	3200	3340	3480				
40 km/h			1500	1750	1995	2240	2485	2725	2855	2990	3120	3250			
40 km/h Dual			1320	1540	1755	1970	2185	2400	2515	2630	2745	2860			
50 km/h			1500	1750	1995	2240	2485	2725	2855	2990	3120	3250			

* Refer to the notes at the end of the tables of this range

MICHELIN AGRIBIB 2

Tire specifications and pressure table (bar & psi). Load per tire in kg*

Ø inches	Description	CAI	e mm	D mm	R' mm	RC mm	Recommended Rim	Acceptable Rim	Tube (Code)	75% internal volume (litres)	Tread depth (mm)		
28	280/85R28 123A8/120D TL	392931	299	1192	545	3563	W10	W9	725	98	40		
Bar	0.4	0.6	0.8	1	1.2	1.4	1.6	1.8	2	2.2	2.4	2.6	2.8
Psi	6	9	12	15	17	20	23	26	29	32	35	38	41
10 km/h	900	1075	1245	1420	1590	1680	1770	1905	2040	2110	2185	2255	2325
30 km/h	640	760	885	1010	1135	1275	1410	1475	1535	1600	1660		
40 km/h		710	825	945	1060	1190	1320	1380	1435	1495	1550		
40 km/h Dual		625	725	830	935	1050	1160	1210	1265	1315	1365		
50 km/h		645	750	860	965	1085	1200	1255	1305	1360	1410		
65 km/h		645	750	860	965	1085	1200	1255	1305	1360	1410		

Ø inches	Description	CAI	e mm	D mm	R' mm	RC mm	Recommended Rim	Acceptable Rim	Tube (Code)	75% internal volume (litres)	Tread depth (mm)				
28	340/85R28 133A8/133B TL NEW	587209	364	1308	593	3893	W12	W11	732	154	43				
Bar	0.4	0.5	0.6	0.7	0.8	1	1.2	1.4	1.8	2	1.6	2.2	2.4	2.6	2.8
Psi	6	8	9	11	12	15	17	20	26	29	23	32	35	38	41
10 km/h	1200	1320	1445	1565	1690	1930	2175	2290	2550	2700	2400	2800	2895	2995	3090
30 km/h	855	935	1015	1110	1200	1375	1550	1715	1960	2040	1875	2125	2205		
40 km/h			950	1035	1120	1285	1450	1600	1830	1905	1750	1985	2060		
40 km/h Dual			835	1035	985	1130	1275	1410	1610	1680	1540	1745	1815		
50 km/h			950	910	1120	1285	1450	1600	1830	1905	1750	1985	2060		

Ø inches	Description	CAI	e mm	D mm	R' mm	RC mm	Recommended Rim	Acceptable Rim	Tube (Code)	75% internal volume (litres)	Tread depth (mm)				
28	380/85R28 139A8/139B TL NEW	184281	400	1362	616	4053	W13	w12	821	199	46				
Bar	0.4	0.5	0.6	0.7	0.8	1	1.2	1.4	1.8	2	1.6	2.2	2.4	2.6	2.8
Psi	6	8	9	11	12	15	17	20	26	29	23	32	35	38	41
10 km/h	1425	1565	1705	1845	1990	2270	2550	2700	2850	3015	3180	3295	3415	3530	3645
30 km/h	1015	1125	1230	1320	1410	1615	1820	2015	2205	2305	2405	2500	2600		
40 km/h			1150	1235	1320	1510	1700	1880	2060	2155	2245	2340	2430		
40 km/h Dual			1010	1085	1160	1330	1495	1655	1815	1895	1980	2060	2140		
50 km/h			1150	1235	1320	1510	1700	1880	2060	2155	2245	2340	2430		

* Refer to the notes at the end of the tables of this range

MICHELIN AGRIBIB 2

Tire specifications and pressure table (bar & psi). Load per tire in kg*

Ø inches	Description	CAI	e mm	D mm	R' mm	RC mm	Recommended Rim		Acceptable Rim	Tube (Code)	75% internal volume (litres)	Tread depth (mm)			
28	420/85R28 144A8/144B TL 16.9R28	NEW	135905	449	1419	645	4226	DW15	DW14L IW14L W15L	822	248	49			
Bar	0.4	0.5	0.6	0.7	0.8	1	1.2	1.4	1.8	2	1.6	2.2	2.4	2.6	2.8
Psi	6	8	9	11	12	15	17	20	26	29	23	32	35	38	41
10 km/h	1680	1845	2010	2175	2340	2670	3000	3180	3360	3555	3750	3865	3975	4090	4200
30 km/h	1200	1305	1410	1535	1660	1900	2140	2370	2600	2700	2800	2895	2995		
40 km/h			1320	1435	1550	1775	2000	2215	2430	2525	2615	2710	2800		
40 km/h Dual			1160	1265	1365	1565	1760	1950	2140	2220	2305	2385	2465		
50 km/h			1320	1435	1550	1775	2000	2215	2430	2525	2615	2710	2800		

Ø inches	Description	CAI	e mm	D mm	R' mm	RC mm	Recommended Rim		Acceptable Rim	Tube (Code)	75% internal volume (litres)	Tread depth (mm)	
30	380/85R30 140A8/140B TL 14.9R30		151572	394	1416	644	4219	W12	W13	734	229	46	
Bar	0.4	0.6	0.8	1	1.2	1.4	1.6	1.8	2	2.2	2.4	2.8	
Psi	6	9	12	15	17	20	23	26	29	32	35	41	
10 km/h	1465	1755	2045	2335	2625	2775	2925	3145	3360	3460	3555	3655	3750
30 km/h	1045	1265	1455	1665	1875	2105	2335	2420	2505	2590	2675		
40 km/h		1180	1360	1555	1750	1965	2180	2260	2340	2420	2500		
40 km/h Dual		1040	1195	1370	1540	1730	1920	1990	2060	2130	2200		
50 km/h		1180	1360	1555	1750	1965	2180	2260	2340	2420	2500		

Ø inches	Description	CAI	e mm	D mm	R' mm	RC mm	Recommended Rim		Acceptable Rim	Tube (Code)	75% internal volume (litres)	Tread depth (mm)			
30	420/85R30 145A8/139D TL 16.9R30	NEW	184330	446	1487	667	4416	DW15	DW14L IW14L W15L	754	270	50			
Bar	0.4	0.5	0.6	0.7	0.8	1	1.2	1.4	1.8	2	1.6	2.2	2.4	2.6	2.8
Psi	6	8	9	11	12	15	17	20	26	29	23	32	35	38	41
10 km/h	1725	1895	2065	2235	2410	2750	3090	3280	3470	3660	3865	3984	4105	4230	4350
30 km/h	1230	1350	1470	1595	1715	1955	2200	2440	2675	2785	2890	3000	3105		
40 km/h			1360	1475	1590	1820	2050	2280	2500	2600	2700	2800	2900		
40 km/h Dual			1195	1295	1400	1605	1805	2010	2200	2290	2375	2465	2550		
50 km/h			1475	1360	1590	1815	2045	2270	2500	2650	2750	2850			

* Refer to the notes at the end of the tables of this range

MICHELIN AGRIBIB 2

Tire specifications and pressure table (bar & psi). Load per tire in kg*

Ø inches	Description	CAI	e mm	D mm	R' mm	RC mm	Recommended Rim		Acceptable Rim	Tube (Code)	75% internal volume (litres)	Tread depth (mm)	
30	420/90R30 147A8/147B TL <i>16.9 R30</i>	508522	418	1518	684	4513	DW13		DW14L W13 W14L	754	284	50	
Bar	0.4 0.6 0.8	1	1.2	1.4	1.6	1.8	2	2.2	2.4	2.6	2.8		
Psi	6 9 12	15	17	20	23	26	29	32	35	38	41		
10 km/h	1825	2120	2420	2715	3015	3310	3605	3905	4200	4305	4410	4510	4615
30 km/h	1300	1550	1810	2075	2335	2585	2835	2970	3105	3200	3290		
40 km/h		1450	1700	1940	2180	2415	2650	2775	2900	2990	3075		
40 km/h Dual	1070	1275	1495	1710	1920	2125	2330	2425	2520	2610	2705		
50 km/h		1450	1700	1940	2180	2415	2650	2775	2900	2990	3075		

Ø inches	Description	CAI	e mm	D mm	R' mm	RC mm	Recommended Rim		Acceptable Rim	Tube (Code)	75% internal volume (litres)	Tread depth (mm)			
30	460/85R30 150A8/150B TL NEW <i>17.7 R30</i>	822467	494	1556	701	4611	DW16L		W16L W15 DW15L	757	326	54			
Bar	0.4 0.5 0.6 0.7	0.8	1	1.2	1.4	1.8	2	2.2	2.4	2.6	2.8				
Psi	6 8 9 11	12	15	17	20	26	29	32	35	38	41				
10 km/h	1980	2175	2370	2565	2760	3150	3540	3760	4240	4500	3975	4630	4765	4895	5025
30 km/h	1410	1560	1710	1845	1980	2255	2525	2815	3225	3345	3105	3465	3585		
40 km/h		1600	1725	1850	2105	2360	2630	3015	3125	2900	3240	3350			
40 km/h Dual		1410	1725	1630	1855	2075	2315	2650	2750	2550	2850	2950			
50 km/h		1600	1520	1850	2105	2360	2630	3015	3125	2900	3240	3350			

Ø inches	Description	CAI	e mm	D mm	R' mm	RC mm	Recommended Rim		Acceptable Rim	Tube (Code)	75% internal volume (litres)	Tread depth (mm)	
32	650/75R32 167A8/167B TL <i>South America</i>	533727	667	1827	811	5395	DW20B (A)		DW21B (A)	831	647	49	
Bar	0.4 0.6 0.8	1	1.2	1.4	1.6	1.8	2	2.2	2.4	2.6	2.8		
Psi	6 9 12	15	17	20	23	26	29	32	35	38	41		
10 km/h	3180	3840	4500	5155	5815	6095	6375	6750	7125	7390	7650	7915	8175
30 km/h	2270	2755	3210	3680	4145	4550	4950	5170	5390	5610	5830		
40 km/h		2575	3000	3440	3875	4250	4625	4830	5040	5245	5450		
40 km/h Dual		2265	2640	3025	3410	3740	4070	4250	4435	4615	4795		
50 km/h		2575	3000	3440	3875	4250	4625	4830	5040	5245	5450		

* Refer to the notes at the end of the tables of this range

MICHELIN AGRIBIB 2

Tire specifications and pressure table (bar & psi). Load per tire in kg*

Ø inches	Description	CAI	e mm	D mm	R' mm	RC mm	Recommended Rim		Acceptable Rim	Tube (Code)	75% internal volume (litres)	Tread depth (mm)	
34	320/85R34 133A8/133B TL <i>12.4 R34</i>	908266	312	1421	653	4243	W10				155	44	
Bar	0.4	0.6	0.8	1	1.2	1.4	1.6	1.8	2	2.2	2.4	2.6	2.8
Psi	6	9	12	15	17	20	23	26	29	32	35	38	41
10 km/h	1200	1445	1690	1930	2175	2290	2400	2550	2700	2800	2895	2995	3090
30 km/h	855	1045	1200	1375	1550	1715	1875	1960	2040	2125	2205		
40 km/h		975	1120	1285	1450	1600	1750	1830	1905	1985	2060		
40 km/h Dual	705	860	985	1130	1275	1410	1540	1610	1680	1745	1815		
50 km/h		975	1120	1285	1450	1600	1750	1830	1905	1985	2060		

Ø inches	Description	CAI	e mm	D mm	R' mm	RC mm	Recommended Rim		Acceptable Rim	Tube (Code)	75% internal volume (litres)	Tread depth (mm)	
34	380/85R34 142A8/142B TL <i>14.9 R34</i>	009860	377.5	1516.4	691	4519	W12		W13	704	286	46	
Bar	0.4	0.6	0.8	1	1.2	1.4	1.6	1.8	2	2.2	2.4	2.6	2.8
Psi	6	9	12	15	17	20	23	26	29	32	35	38	41
10 km/h	1545	1855	2160	2470	2775	2935	3090	3315	3540	3650	3760	3865	3975
30 km/h	1100	1340	1550	1765	1980	2220	2460	2555	2650	2740	2835		
40 km/h		1250	1450	1650	1850	2075	2300	2390	2475	2565	2650		
40 km/h Dual		1100	1275	1455	1630	1830	2025	2100	2180	2255	2330		
50 km/h		1250	1450	1650	1850	2075	2300	2390	2475	2565	2650		

Ø inches	Description	CAI	e mm	D mm	R' mm	RC mm	Recommended Rim		Acceptable Rim	Tube (Code)	75% internal volume (litres)	Tread depth (mm)	
34	420/85R34 147A8/147B TL <i>16.9 R34</i>	183733	449	1589	720	4730	DW15L		DW14L W13 W14L W15L	704	287	48	
Bar	0.4	0.6	0.8	1	1.2	1.4	1.6	1.8	2	2.2	2.4	2.6	2.8
Psi	6	9	12	15	17	20	23	26	29	32	35	38	41
10 km/h	1825	2185	2550	2910	3270	3460	3645	3870	4090	4220	4355	4485	4615
30 km/h	1300	1550	1820	2080	2335	2585	2835	2950	3065	3175	3290		
40 km/h		1450	1700	1940	2180	2415	2650	2755	2865	2970	3075		
40 km/h Dual	1070	1275	1495	1710	1920	2125	2330	2425	2520	2610	2705		
50 km/h		1450	1700	1940	2180	2415	2650	2755	2865	2970	3075		

MICHELIN AGRIBIB 2

Tire specifications and pressure table (bar & psi). Load per tire in kg*

Ø inches	Description	CAI	e mm	D mm	R' mm	RC mm	Recommended Rim		Acceptable Rim		Tube (Code)	75% internal volume (litres)	Tread depth (mm)		
34	460/85R34 152A8/152B TL NEW	817711	494	1650	742	4908	DW16L		DW15L W15L W16L			355	53		
Bar	0.4	0.5	0.6	0.7	0.8	1	1.2	1.4	1.8	2	1.6	2.2	2.4	2.6	2.8
Psi	6	8	9	11	12	15	17	20	26	29	23	32	35	38	41
10 km/h	2100	2305	2515	2720	2925	3340	3750	3975	4200	4465	4725	4875	5025	5175	5325
30 km/h	1500	1635	1765	1925	2085	2380	2675	2985	3290	3420	3545	3675	3800		
40 km/h			1650	1800	1950	2225	2500	2790	3075	3195	3315	3430	3550		
40 km/h Dual			1450	1585	1715	1960	2200	2455	2705	2810	2915	3020	3125		
50 km/h			1650	1800	1950	2225	2500	2790	3075	3195	3315	3430	3550		

Ø inches	Description	CAI	e mm	D mm	R' mm	RC mm	Recommended Rim		Acceptable Rim		Tube (Code)	75% internal volume (litres)	Tread depth (mm)		
38	340/85R38 138A8/138B TL NEW	439359	357	1558	719	4658	DW12L		W12L W11L		795	193	43		
Bar	0.4	0.5	0.6	0.7	0.8	1	1.2	1.4	1.8	2	1.6	2.2	2.4	2.6	2.8
Psi	6	8	9	11	12	15	17	20	26	29	23	32	35	38	41
10 km/h	1390	1525	1660	1795	1935	2205	2475	2625	2980	3180	2775	3270	3360	3450	3540
30 km/h	990	1095	1200	1290	1375	1570	1765	1985	2285	2365	2205	2445	2525		
40 km/h			1120	1205	1285	1470	1650	1855	2135	2210	2060	2285	2360		
40 km/h Dual			985	1205	1130	1290	1450	1635	1880	1945	1815	2010	2075		
50 km/h			1120	1060	1285	1470	1650	1855	2135	2210	2060	2285	2360		

Ø inches	Description	CAI	e mm	D mm	R' mm	RC mm	Recommended Rim		Acceptable Rim		Tube (Code)	75% internal volume (litres)	Tread depth (mm)		
38	380/80R38 142A8/139D TL <i>14.9 R38</i>	187095	380	1595	729	4755	DW12A		DW11 DW12 DW13 W11 W12 W13		796 795	230	46		
Bar	0.4	0.6	0.8	1	1.2	1.4	1.6	1.8	2	2.2	2.4	2.6	2.8		
Psi	6	9	12	15	17	20	23	26	29	32	35	38	41		
10 km/h	1545	1870	2200	2525	2850	2970	3090	3315	3540	3650	3760	3865	3975		
30 km/h	1100	1340	1550	1795	2035	2250	2460	2555	2650	2740	2835				
40 km/h			1250	1450	1675	1900	2100	2300	2390	2475	2565	2650			
40 km/h Dual			1100	1275	1475	1670	1850	2025	2100	2180	2255	2330			
50 km/h			1250	1450	1675	1900	2100	2300	2390	2475	2565	2650			
65 km/h			1140	1320	1525	1730	1915	2095	2175	2255	2330	2410			

* Refer to the notes at the end of the tables of this range

MICHELIN AGRIBIB 2

Tire specifications and pressure table (bar & psi). Load per tire in kg*

Ø inches	Description	CAI	e mm	D mm	R' mm	RC mm	Recommended Rim		Acceptable Rim		Tube (Code)	75% internal volume (litres)	Tread depth (mm)
38	420/85R38 149A8/149B TL 16.9 R38	048439	450	1690	769	5035	DW15L		DW14L W14L W15L		786	293	49
Bar	0.4	0.6	0.8	1	1.2	1.4	1.6	2	2.2	2.4	2.6	2.8	
Psi	6	9	12	15	17	20	23	26	29	32	35	38	41
10 km/h	1930	2250	2575	2895	3215	3535	3860	4180	4500	4595	4690	4780	4875
30 km/h	1375	1660	1925	2195	2460	2730	2995	3145	3290	3385	3480		
40 km/h		1550	1800	2050	2300	2550	2800	2940	3075	3165	3250		
40 km/h Dual	1130	1365	1585	1805	2025	2245	2465	2565	2665	2760	2860		
50 km/h		1550	1800	2050	2300	2550	2800	2940	3075	3165	3250		

Ø inches	Description	CAI	e mm	D mm	R' mm	RC mm	Recommended Rim		Acceptable Rim		Tube (Code)	75% internal volume (litres)	Tread depth (mm)		
38	460/85R38 154A8/154B TL NEW 18.5 R38	346098	498	1769	796	5258	DW16L		DW15L W15L W16L		824	383	56		
Bar	0.4	0.5	0.6	0.7	0.8	1	1.2	1.4	1.8	2	2.2	2.4	2.6	2.8	
Psi	6	8	9	11	12	15	17	20	26	29	32	35	38	41	
10 km/h	2175	2400	2625	2850	3075	3525	3975	4165	4350	4690	5025	5410	5795	6180	6565
30 km/h	1550	1715	1875	2040	2205	2520	2835	3160	3480	3615	3750	3880	4015		
40 km/h			1750	1905	2060	2355	2650	2950	3250	3375	3500	3625	3750		
40 km/h Dual			1540	1680	1815	2075	2330	2595	2860	2970	3080	3190	3300		
50 km/h			1750	1905	2060	2355	2650	2950	3250	3375	3500	3625	3750		

Ø inches	Description	CAI	e mm	D mm	R' mm	RC mm	Recommended Rim		Acceptable Rim		Tube (Code)	75% internal volume (litres)	Tread depth (mm)
38	520/85R38 160A8/160B TL 20.8 R38	882358	528	1849	829	5490	DW16L		DD16 DD18 DW18L W16A W18A		825	508	55
Bar	0.4	0.6	0.8	1	1.2	1.4	1.6	1.8	2	2.2	2.4	2.6	2.8
Psi	6	9	12	15	17	20	23	26	29	32	35	38	41
10 km/h	2625	3070	3515	3960	4410	4855	5300	5745	6190	6330	6470	6610	6750
30 km/h	1875	2270	2635	3005	3370	3760	4145	4350	4550	4685	4815		
40 km/h		2120	2500	2825	3150	3515	3875	4065	4250	4375	4500		
40 km/h Dual	1540	1865	2200	2485	2770	3090	3410	3550	3685	3825	3960		
50 km/h		2120	2500	2825	3150	3515	3875	4065	4250	4375	4500		

* Refer to the notes at the end of the tables of this range

MICHELIN AGRIBIB 2

Tire specifications and pressure table (bar & psi). Load per tire in kg*

Ø inches	Description	CAI	e mm	D mm	R' mm	RC mm	Recommended Rim		Acceptable Rim	Tube (Code)	75% internal volume (litres)	Tread depth (mm)	
42	480/80R42 156A8/156B TL <i>18.4 R42</i>	539386	489	1840	837	5470	DW16A		DD16 W16A	801	412	52	
Bar	0.4	0.6	0.8	1	1.2	1.4	1.6	2	2.2	2.4	2.6	2.8	
Psi	6	9	12	15	17	20	23	26	29	32	35	38	41
10 km/h	2325	2720	3115	3505	3900	4295	4690	5080	5475	5605	5740	5870	6000
30 km/h	1660	1980	2320	2655	2995	3345	3690	3855	4015	4150	4280		
40 km/h		1850	2180	2490	2800	3125	3450	3600	3750	3875	4000		
40 km/h Dual	1365	1630	1920	2195	2465	2750	3035	3155	3280	3400	3520		
50 km/h		1850	2180	2490	2800	3125	3450	3600	3750	3875	4000		

Ø inches	Description	CAI	e mm	D mm	R' mm	RC mm	Recommended Rim		Acceptable Rim	Tube (Code)	75% internal volume (litres)	Tread depth (mm)	
42	520/85R42 162A8/162B TL <i>20.8 R42</i>	405859	542	1958	886	5810	DW18A		DD18 DW16A DW16L TW16L W16A W16L W18A	802	545	55	
Bar	0.4	0.6	0.8	1	1.2	1.4	1.6	1.8	2	2.2	2.4	2.6	2.8
Psi	6	9	12	15	17	20	23	26	29	32	35	38	41
10 km/h	2775	3250	3725	4195	4670	5145	5620	6090	6565	6705	6845	6985	7125
30 km/h	1980	2395	2790	3190	3585	4000	4415	4615	4815	4950	5085		
40 km/h		2240	2575	2965	3350	3740	4125	4315	4500	4625	4750		
40 km/h Dual	1630	1970	2265	2610	2950	3290	3630	3770	3905	4045	4180		
50 km/h		2240	2575	2965	3350	3740	4125	4315	4500	4625	4750		

Ø inches	Description	CAI	e mm	D mm	R' mm	RC mm	Recommended Rim		Acceptable Rim	Tube (Code)	75% internal volume (litres)	Tread depth (mm)	
46	420/80R46 151A8/151B TL	885138	410	1854	844	5524	DW13		DW12	835	334	50	
Bar	0.4	0.6	0.8	1	1.2	1.4	1.6	1.8	2	2.2	2.4	2.6	2.8
Psi	6	9	12	15	17	20	23	26	29	32	35	38	41
10 km/h	1980	2395	2815	3230	3645	3810	3975	4240	4500	4670	4840	5005	5175
30 km/h	1410	1710	1980	2290	2600	2855	3105	3250	3400	3545	3690		
40 km/h		1600	1850	2140	2430	2665	2900	3040	3175	3315	3450		
40 km/h Dual	1160	1410	1630	1885	2140	2345	2550	2670	2795	2915	3035		
50 km/h		1600	1850	2140	2430	2665	2900	3040	3175	3315	3450		

* Refer to the notes at the end of the tables of this range

MICHELIN AGRIBIB 2

Tire specifications and pressure table (bar & psi). Load per tire in kg*

Ø inches	Description	CAI	e mm	D mm	R' mm	RC mm	Recommended Rim		Acceptable Rim		Tube (Code)	75% internal volume (litres)	Tread depth (mm)
46	480/80R46 158A8/158B TL 18.4 R46	622709	486	1945	891	5804	DW16A		DD16 DW16L W16A	834	449	52	
Bar	0.4 0.6 0.8	1	1.2	1.4	1.6	1.8	2	2.2	2.4	2.6	2.8		
Psi	6 9 12	15	17	20	23	26	29	32	35	38	41		
10 km/h	2475	2945	3415	3880	4350	4615	4875	5175	5475	5700	5925	6150	6375
30 km/h	1765	2085	2460	2785	3105	3455	3800	3990	4175	4365	4550		
40 km/h		1950	2300	2600	2900	3225	3550	3725	3900	4075	4250		
40 km/h Dual		1715	2025	2290	2550	2840	3125	3280	3435	3585	3740		
50 km/h		1950	2300	2600	2900	3225	3550	3725	3900	4075	4250		

Ø inches	Description	CAI	e mm	D mm	R' mm	RC mm	Recommended Rim		Acceptable Rim		Tube (Code)	75% internal volume (litres)	Tread depth (mm)
46	520/85R46 164A8/164B TL 20.8 R46	120922	518	2059	931	6110	DW16A		DW16L DW18A DW18L TW16L W16A W16L W18A W18L	834	560	55	
Bar	0.4 0.6 0.8	1	1.2	1.4	1.6	1.8	2	2.2	2.4	2.6	2.8		
Psi	6 9 12	15	17	20	23	26	29	32	35	38	41		
10 km/h	2925	3425	3930	4430	4935	5435	5935	6440	6940	7035	7130	7220	7315
30 km/h	2085	2460	2870	3280	3690	4120	4550	4750	4950	5150	5350		
40 km/h		2300	2725	3090	3450	3850	4250	4440	4625	4815	5000		
40 km/h Dual		1715	2025	2400	2720	3035	3390	3740	3905	4070	4235	4400	
50 km/h		2300	2725	3090	3450	3850	4250	4440	4625	4815	5000		

Ø inches	Description	CAI	e mm	D mm	R' mm	RC mm	Recommended Rim		Acceptable Rim		Tube (Code)	75% internal volume (litres)	Tread depth (mm)
50	480/80R50 159A8/159B TL	263049	465	2050	938	6116	DW15A		DW16A		483	52	
Bar	0.4 0.6 0.8	1	1.2	1.4	1.6	1.8	2	2.2	2.4	2.6	2.8		
Psi	6 9 12	15	17	20	23	26	29	32	35	38	41		
10 km/h	2550	3065	3585	4100	4615	4895	5175	5495	5815	6005	6190	6380	6565
30 km/h	1820	2205	2525	2910	3290	3655	4015	4180	4350	4515	4680		
40 km/h		2060	2360	2720	3075	3415	3750	3905	4065	4220	4375		
40 km/h Dual		1815	2075	2390	2705	3005	3300	3440	3575	3715	3850		
50 km/h		2060	2360	2720	3075	3415	3750	3905	4065	4220	4375		

* Refer to the notes at the end of the tables of this range

MICHELIN AGRIBIB 2

Tire specifications and pressure table (bar & psi). Load per tire in kg*

Ø inches	Description			CAI	e mm	D mm	R' mm	RC mm	Recommended Rim		Acceptable Rim		Tube (Code)	75% internal volume (litres)	Tread depth (mm)
54	380/90R54 152A8/152B TL			075615	386	2054	949	6129	W12A		DW13B			334	50
Bar	0.4	0.6	0.8	1	1.2	1.4	1.6	1.8	2	2.2	2.4	2.6	2.8		
Psi	6	9	12	15	17	20	23	26	29	32	35	38	41		
10 km/h	2040	2470	2895	3325	3750	3920	4090	4410	4725	4875	5025	5175	5325		
30 km/h	1455	1765	2085	2380	2675	2945	3210	3360	3505	3655	3800				
40 km/h		1650	1950	2225	2500	2750	3000	3140	3275	3415	3550				
40 km/h Dual		1450	1715	1960	2200	2420	2640	2760	2885	3005	3125				
50 km/h		1650	1950	2225	2500	2750	3000	3140	3275	3415	3550				

*IMPORTANT:

The inflation pressure must always be appropriate for the load per tire, the speed of travel and the work to be done. Our recommendations above are provided subject to changes made after the date of publication of these tables. Technical data is subject to change without prior notice.

- For plowing and other field applications subject to high torque, use the 30 km/h line.
- When using single tire configuration:
 - add 0.4 bar for use on slopes of more than 20%
 - add 0.4 bar for intensive road use exceeding 50%
- 10 km/h: low torque application only

* Refer to the notes at the end of the tables of this range



MICHELIN AGRIBIB

**HIGH PERFORMANCE
WITH EXCELLENT TRACTION**



FOR LOW & MEDIUM TRACTORS

For special fitting on other vehicles, please contact your local sales representative.



EXCELLENT TRACTION

- Maintains traction throughout its life, even when worn



EXCELLENT SERVICE LIFE thanks to deep tread lugs



ROBUSTNESS

- Proven radial casing endurance
- Damage-resistant rubber

SIZES

11.2R24 119A8/116B TL	16.9R28 141A8/138B TL	12.4R36 124A8/121B TL	520/85R42 157A8/157B TL
12.4R24 119A8/116B TL	16.9R30 137A8/134B TL	12.4R38 131A8/128B TL	420/80R46 151A8/148B TL
13.6R24 124A8/121B TL	18.4R30 142A8/139B TL	13.6R38 128A8/125B TL	480/80R46 158A8/158B TL
14.9R24 130A8/127B TL	380/85R30 135A8/135B TL	18.4R38 151A8/148B TL	520/85R46 158A8/155B TL
16.9R24 134A8/131B TL	420/90R30 147A8/147B TL	20.8R38 159A8/156B TL	480/80R50 159A8/159B TL
9.5R24 112A8/109B TL	18.4R34 149A8/146B TL	380/95R38 147A8/147B TL	480/95R50 164A8/164B TL
12.4R28 126A8/123B TL	320/85R34 133A8/130B TL	420/85R38 144A8/144B TL	
13.6R28 123A8/120B TL	380/85R34 137A8/137B TL	520/85R38 155A8/155B TL	
14.9R28 134A8/131B TL	420/85R34 147A8/147B TL	480/80R42 156A8/156B TL	

MICHELIN AGRIBIB

Tire specifications and pressure table (bar & psi). Load per tire in kg*

Ø inches	Description	CAI	e mm	D mm	R' mm	RC mm	Recommended Rim		Acceptable Rim		Tube (Code)	75% internal volume (litres)	Tread depth (mm)
24	9.5R24 112A8/109B TL	200987	253	1045	481	3117	W8		W7		686	65	32
Bar	0.4	0.5	0.6	0.8	1	1.2	1.4	1.6	1.8	2	2.1	2.3	2.4
Psi	6	7	9	12	15	17	20	23	26	29	30	33	35
10 km/h	675	745	815	960	1100	1240	1280	1315	1395	1475	1515	1595	1635
30 km/h	535	605	675	745	815	885	965	1045	1105	1170	1200		
40 km/h			630	695	760	825	900	975	1035	1090	1120		
40 km/h Dual	385	470	555	615	675	740	800	860	910	960	985		
50 km/h			575	640	710	775	830	885	940	995	1020		

Ø inches	Description	CAI	e mm	D mm	R' mm	RC mm	Recommended Rim		Acceptable Rim		Tube (Code)	75% internal volume (litres)	Tread depth (mm)
24	11.2R24 119A8/116B TL	317247	288	1095	503	3269	W10		W9		692	92	37
Bar	0.4	0.5	0.6	0.8	1	1.2	1.4	1.6	1.8	2	2.1	2.3	2.4
Psi	6	7	9	12	15	17	20	23	26	29	30	33	35
10 km/h	840	925	1005	1170	1335	1500	1570	1635	1720	1810	1850	1935	1980
30 km/h	660	745	830	910	990	1070	1170	1265	1340	1415	1455		
40 km/h			775	850	925	1000	1090	1180	1250	1325	1360		
40 km/h Dual	480	580	680	750	825	895	970	1040	1100	1165	1195		
50 km/h			705	780	860	935	1005	1075	1140	1205	1240		

Ø inches	Description	CAI	e mm	D mm	R' mm	RC mm	Recommended Rim		Acceptable Rim		Tube (Code)	75% internal volume (litres)	Tread depth (mm)
24	12.4R24 119A8/116B TL	123788	324	1149	520	3420	W11		W10		692	116	41
Bar	0.5	0.6	0.8	1	1.2	1.4	1.6	1.8					
Psi	7	9	12	15	17	20	23	26					
10 km/h	1040	1200	1330	1460	1590	1715	1845	1975					
30 km/h	810	950	1050	1155	1255	1360	1460						
40 km/h		880	975	1070	1170	1265	1360						
50 km/h		830	915	1000	1080	1165	1250						

* Refer to the notes at the end of the tables of this range

MICHELIN AGRIBIB

Tire specifications and pressure table (bar & psi). Load per tire in kg*

Ø inches	Description	CAI	e mm	D mm	R' mm	RC mm	Recommended Rim		Acceptable Rim		Tube (Code)	75% internal volume (litres)	Tread depth (mm)	
24	13.6R24 124A8/121B TL	262831	370	1200	551	3583	W12	W11	W11	W11	700	144	43	
Bar	0.4	0.5	0.6	0.8	1	1.2	1.4	1.6	1.8	2	2.1	2.3	2.4	2.6
Psi	6	7	9	12	15	17	20	23	26	29	30	33	35	38
10 km/h	975	1075	1175	1375	1570	1770	1850	1930	2030	2130	2175	2275	2325	
30 km/h	760	865	965	1065	1165	1265	1385	1500	1585	1670	1710			
40 km/h			900	995	1085	1180	1290	1400	1480	1560	1600			
40 km/h Dual	555	675	790	880	965	1055	1140	1230	1300	1375	1410			
40 km/h FRT								1550	1680	1775	1825	1920	1960	2040
50 km/h			820	915	1010	1105	1190	1275	1345	1420	1455			

Ø inches	Description	CAI	e mm	D mm	R' mm	RC mm	Recommended Rim		Acceptable Rim		Tube (Code)	75% internal volume (litres)	Tread depth (mm)	
24	14.9R24 130A8/127B TL	601563	397	1265	575	3769	W13	W11 W12	W11 W12	W11 W12	703	188	48	
Bar	0.4	0.5	0.6	0.8	1	1.2	1.4	1.6	1.8	2	2.1	2.3	2.4	
Psi	6	7	9	12	15	17	20	23	26	29	30	33	35	
10 km/h	1165	1280	1400	1635	1865	2100	2175	2250	2380	2515	2580	2710	2775	
30 km/h	910	1040	1165	1275	1390	1500	1635	1765	1875	1980	2035			
40 km/h			1090	1195	1295	1400	1525	1650	1750	1850	1900			
40 km/h Dual	660	810	960	1060	1155	1255	1350	1450	1540	1625	1670			
50 km/h			990	1100	1210	1320	1410	1500	1590	1685	1730			

Ø inches	Description	CAI	e mm	D mm	R' mm	RC mm	Recommended Rim		Acceptable Rim		Tube (Code)	75% internal volume (litres)	Tread depth (mm)	
24	16.9R24 134A8/131B TL	123854	460	1330	586	3935	DW15L	DW14L W14L W15L	DW14L W14L W15L	DW14L W14L W15L	710	244	55	
Bar	0.4	0.5	0.6	0.8	1	1.2	1.4	1.6	1.8					
Psi	6	7	9	12	15	17	20	23	26					
10 km/h		1620	1880	2080	2280	2480	2680	2880	3080					
30 km/h		1270	1470	1630	1790	1950	2110	2270						
40 km/h			1380	1530	1675	1825	1970	2120						
40 km/h Dual	790	1005	1215	1345	1475	1605	1735	1865						
50 km/h			1290	1420	1555	1685	1820	1950						

* Refer to the notes at the end of the tables of this range

MICHELIN AGRIBIB

Tire specifications and pressure table (bar & psi). Load per tire in kg*

Ø inches	Description	CAI	e mm	D mm	R' mm	RC mm	Recommended Rim		Acceptable Rim		Tube (Code)	75% internal volume (litres)	Tread depth (mm)
28	12.4R28 126A8/123B TL	738964	322	1265	586	3778	W11		W10		726	134	40
Bar	0.4	0.5	0.6	0.8	1	1.2	1.4	1.6	1.8	2	2.1	2.3	2.4
Psi	6	7	9	12	15	17	20	23	26	29	30	33	35
10 km/h	1035	1140	1245	1455	1665	1875	1960	2040	2150	2260	2310	2420	2475
30 km/h	805	925	1045	1145	1240	1340	1475	1605	1690	1775	1820		
40 km/h			975	1065	1160	1250	1375	1500	1580	1660	1700		
40 km/h Dual	590	725	860	950	1045	1135	1230	1320	1390	1460	1495		
50 km/h			885	980	1075	1170	1270	1365	1435	1510	1545		

Ø inches	Description	CAI	e mm	D mm	R' mm	RC mm	Recommended Rim		Acceptable Rim		Tube (Code)	75% internal volume (litres)	Tread depth (mm)
28	13.6R28 123A8/120B TL	123782	372	1308	592	3893	W12		W11		732	173	46
Bar	0.4	0.5	0.6	0.8	1	1.2	1.4	1.6	1.8				
Psi	6	7	9	12	15	17	20	23	26				
10 km/h		1190	1370	1520	1665	1815	1960	2110	2255				
30 km/h		930	1080	1195	1310	1430	1545	1660					
40 km/h			1010	1120	1225	1335	1440	1550					
40 km/h Dual	590	740	890	985	1080	1175	1270	1365					
50 km/h			920	1015	1110	1210	1305	1400					

Ø inches	Description	CAI	e mm	D mm	R' mm	RC mm	Recommended Rim		Acceptable Rim		Tube (Code)	75% internal volume (litres)	Tread depth (mm)		
28	14.9R28 134A8/131B TL	112235	393	1365	624	4072	W13		W12		821	210	47		
Bar	0.4	0.5	0.6	0.8	1	1.2	1.4	1.6	1.8	2	2.1	2.3	2.4	2.6	2.8
Psi	6	7	9	12	15	17	20	23	26	29	30	33	35	38	41
10 km/h	1240	1365	1495	1745	2000	2250	2365	2475	2625	2775	2825	2925	2980	3080	3180
30 km/h	885	980	1070	1230	1420	1605	1765	1925	2010	2100	2140	2225	2270		
40 km/h			1000	1150	1325	1500	1650	1800	1880	1960	2000	2080	2120		
50 km/h			910	1045	1205	1365	1505	1640	1715	1785	1820	1895	1930		

Ø inches	Description	CAI	e mm	D mm	R' mm	RC mm	Recommended Rim		Acceptable Rim		Tube (Code)	75% internal volume (litres)	Tread depth (mm)		
28	16.9R28 141A8/138B TL	984997	454	1435	655	4278	DW15L		DW14L W14L W15L		822	272	51		
Bar	0.4	0.5	0.6	0.8	1	1.2	1.4	1.6	1.8	2	2.1	2.3	2.4	2.6	2.8
Psi	6	7	9	12	15	17	20	23	26	29	30	33	35	38	41
10 km/h	1500	1650	1800	2100	2400	2700	2850	3000	3180	3360	3425	3550	3615	3740	3865
30 km/h	1070	1185	1300	1500	1715	1925	2130	2335	2440	2545	2600	2705	2755		
40 km/h			1215	1400	1600	1800	1990	2180	2280	2380	2425	2525	2575		
50 km/h			1105	1275	1460	1640	1815	1985	2075	2165	2210	2300	2345		

* Refer to the notes at the end of the tables of this range

MICHELIN AGRIBIB

Tire specifications and pressure table (bar & psi). Load per tire in kg*

Ø inches	Description	CAI	e mm	D mm	R' mm	RC mm	Recommended Rim		Acceptable Rim	Tube (Code)	75% internal volume (litres)	Tread depth (mm)
30	380/85R30 135A8/135B TL	836509	386	1416	628	4194	W12		W13	734	209	46
Bar	0.4	0.5	0.6	0.8	1	1.2	1.4	1.6	1.8			
Psi	6	7	9	12	15	17	20	23	26			
10 km/h	1450	1565	1680	1905	2135	2360	2580	2800	3100			
30 km/h	1060	1155	1250	1450	1675	1900	2100	2300				
40 km/h			1180	1360	1555	1750	1965	2180				
40 km/h Dual	860	950	1040	1195	1370	1540	1730	1920				
50 km/h			1180	1360	1550	1750	1965	2180				

Ø inches	Description	CAI	e mm	D mm	R' mm	RC mm	Recommended Rim		Acceptable Rim	Tube (Code)	75% internal volume (litres)	Tread depth (mm)
30	16.9R30 137A8/134B TL	123870	447	1480	664	4395	DW15L		DW14L W14L W15L	754	285	49
Bar	0.4	0.5	0.6	0.8	1	1.2	1.4	1.6	1.8			
Psi	6	7	9	12	15	17	20	23	26			
10 km/h		1760	2040	2255	2475	2690	2910	3125	3340			
30 km/h		1380	1600	1770	1945	2115	2290	2460				
40 km/h			1500	1660	1820	1980	2140	2300				
40 km/h Dual	880	1100	1320	1460	1600	1745	1885	2025				
50 km/h			1400	1545	1690	1830	1975	2120				

Ø inches	Description	CAI	e mm	D mm	R' mm	RC mm	Recommended Rim		Acceptable Rim	Tube (Code)	75% internal volume (litres)	Tread depth (mm)			
30	420/90R30 147A8/147B TL	953332	443	1533	690	4556	DW13		DW14L W13 W14L	754	284	44			
Bar	0.4	0.5	0.6	0.8	1	1.2	1.4	1.6	1.8	2	2.1	2.3	2.4	2.6	2.8
Psi	6	7	9	12	15	17	20	23	26	29	30	33	35	38	41
10 km/h	1800	1955	2110	2415	2725	3035	3340	3650	3950	4250	4315	4440	4500	4565	4625
30 km/h	1285	1420	1550	1800	2050	2300	2550	2800	2940	3075	3145	3280	3350		
40 km/h			1450	1700	1940	2175	2415	2650	2775	2900	2945	3030	3075		
40 km/h Dual	1070	1175	1275	1495	1705	1915	2120	2330	2440	2550	2590	2665	2705		
50 km/h			1450	1700	1940	2175	2415	2650	2775	2900	2945	3030	3075		

* Refer to the notes at the end of the tables of this range

MICHELIN AGRIBIB

Tire specifications and pressure table (bar & psi). Load per tire in kg*

Ø inches	Description	CAI	e mm	D mm	R' mm	RC mm	Recommended Rim		Acceptable Rim	Tube (Code)	75% internal volume (litres)	Tread depth (mm)
30	18.4R30 142A8/139B TL	123844	504	1550	695	4602	DW16L		DW15L W15L W16L	757	353	54
Bar	0.4	0.5	0.6	0.8	1	1.2	1.4	1.6	1.8			
Psi	6	7	9	12	15	17	20	23	26			
10 km/h		2030	2350	2600	2850	3100	3355	3605	3855			
30 km/h		1590	1840	2040	2240	2440	2640	2840				
40 km/h			1720	1905	2090	2280	2465	2650				
40 km/h Dual	1040	1280	1515	1680	1840	2005	2165	2330				
50 km/h		1600	1765	1930	2100	2265	2430					

Ø inches	Description	CAI	e mm	D mm	R' mm	RC mm	Recommended Rim		Acceptable Rim	Tube (Code)	75% internal volume (litres)	Tread depth (mm)			
34	320/85R34 133A8/130B TL	122760	320	1420	651	4239	W10				155	39			
Bar	0.4	0.5	0.6	0.8	1	1.2	1.4	1.6	1.8	2	2.1	2.3	2.4	2.6	2.8
Psi	6	7	9	12	15	17	20	23	26	29	30	33	35	38	41
10 km/h	1215	1315	1410	1610	1805	2000	2215	2430	2615	2800	2835	2905	2940	3005	3075
30 km/h	850	940	1030	1215	1385	1550	1725	1900	1980	2060	2090	2150	2180		
40 km/h			975	1120	1285	1450	1600	1750	1850	1950	1980	2035	2060		
40 km/h Dual	705	785	860	985	1130	1275	1410	1540	1630	1715	1740	1790	1815		
50 km/h			900	1030	1180	1320	1460	1600	1700	1800	1825	1875	1900		

Ø inches	Description	CAI	e mm	D mm	R' mm	RC mm	Recommended Rim		Acceptable Rim	Tube (Code)	75% internal volume (litres)	Tread depth (mm)
34	380/85R34 137A8/137B TL	122781	394	1503	673	4461	W12		W13	704	230	44
Bar	0.4	0.5	0.6	0.8	1	1.2	1.4	1.6	1.8			
Psi	6	7	9	12	15	17	20	23	26			
10 km/h	1550	1670	1790	2025	2265	2500	2750	3000	3300			
30 km/h	1120	1220	1320	1550	1775	2000	2215	2430				
40 km/h			1250	1450	1650	1850	2075	2300				
40 km/h Dual	905	1005	1100	1275	1455	1630	1830	2025				
50 km/h			1250	1450	1650	1850	2075	2300				

* Refer to the notes at the end of the tables of this range

MICHELIN AGRIBIB

Tire specifications and pressure table (bar & psi). Load per tire in kg*

Ø inches	Description	CAI	e mm	D mm	R' mm	RC mm	Recommended Rim		Acceptable Rim		Tube (Code)	75% internal volume (litres)	Tread depth (mm)		
34	420/85R34 147A8/147B TL	788910	455	1595	725	4751	DW15L		DW14L W13 W14L W15L		704	287	51		
Bar	0.4	0.5	0.6	0.8	1	1.2	1.4	1.6	1.8	2	2.1	2.3	2.4	2.6	2.8
Psi	6	7	9	12	15	17	20	23	26	29	30	33	35	38	41
10 km/h	1800	1940	2075	2350	2625	2900	3175	3450	3800	4045	4115	4260	4330	4475	4615
30 km/h	1300	1430	1560	1815	2075	2330	2585	2835	2950	3065	3120	3235			
40 km/h			1450	1695	1935	2180	2415	2650	2755	2865	2915	3020	3075		
40 km/h Dual			1280	1495	1705	1920	2125	2330	2425	2520	2570	2665	2710		
50 km/h			1450	1695	1935	2180	2415	2650	2755	2865	2915	3020	3075		

Ø inches	Description	CAI	e mm	D mm	R' mm	RC mm	Recommended Rim		Acceptable Rim		Tube (Code)	75% internal volume (litres)	Tread depth (mm)		
34	18.4R34 149A8/146B TL	679786	491	1662	747	4940	DW16L		DW15L W15L W16L		823	395	54		
Bar	0.4	0.5	0.6	0.8	1	1.2	1.4	1.6	1.8	2	2.1	2.3	2.4		
Psi	6	7	9	12	15	17	20	23	26	29	30	33	35		
10 km/h	1980	2175	2370	2760	3150	3540	3705	3865	4080	4295	4405	4620	4725		
30 km/h	1550	1765	1980	2160	2345	2525	2760	2995	3190	3385	3480				
40 km/h			1850	2020	2190	2360	2580	2800	2980	3160	3250				
40 km/h Dual	1130	1380	1630	1795	1965	2130	2300	2465	2625	2780	2860				
50 km/h			1685	1860	2035	2210	2380	2550	2715	2880	2960				

Ø inches	Description	CAI	e mm	D mm	R' mm	RC mm	Recommended Rim		Acceptable Rim		Tube (Code)	75% internal volume (litres)	Tread depth (mm)	
36	12.4R36 124A8/121B TL	123952	318	1460	673	4363	W11		W10		779	165	33	
Bar	0.5	0.6	0.8	1	1.2	1.4	1.6	1.8						
Psi	7	9	12	15	17	20	23	26						
10 km/h	1220	1420	1570	1720	1870	2025	2175	2325						
30 km/h	960	1110	1230	1350	1470	1590	1710							
40 km/h			1040	1150	1265	1375	1490	1600						
50 km/h			960	1060	1155	1255	1350	1450						

* Refer to the notes at the end of the tables of this range

MICHELIN AGRIBIB

Tire specifications and pressure table (bar & psi). Load per tire in kg*

Ø inches	Description	CAI	e mm	D mm	R' mm	RC mm	Recommended Rim		Acceptable Rim	Tube (Code)	75% internal volume (litres)	Tread depth (mm)	
38	12.4R38 131A8/128B TL	258138	325	1500	697	4484	W11		DW10 W10	779	165	35	
Bar	0.4	0.5	0.6	0.8	1	1.2	1.4	1.6	1.8	2	2.1	2.3	2.4
Psi	6	7	9	12	15	17	20	23	26	29	30	33	35
10 km/h	1200	1315	1425	1650	1875	2100	2215	2325	2440	2550	2605	2720	2775
30 km/h	935	1070	1200	1300	1400	1500	1660	1820	1925	2030	2085		
40 km/h			1120	1215	1305	1400	1550	1700	1800	1900	1950		
40 km/h Dual	680	835	985	1085	1190	1290	1395	1495	1585	1670	1715		
50 km/h			1020	1120	1220	1320	1435	1545	1635	1730	1775		

Ø inches	Description	CAI	e mm	D mm	R' mm	RC mm	Recommended Rim		Acceptable Rim	Tube (Code)	75% internal volume (litres)	Tread depth (mm)
38	13.6R38 128A8/125B TL	123992	358	1565	722	4705	DW12		W11 W12	795	218	45
Bar	0.4	0.5	0.6	0.8	1	1.2	1.4	1.6	1.8			
Psi	6	7	9	12	15	17	20	23	26			
10 km/h		1380	1590	1760	1930	2100	2275	2445	2615			
30 km/h		1080	1250	1385	1520	1660	1795	1930				
40 km/h			1170	1140	1250	1365	1475	1800				
40 km/h Dual	685	860	1030	1140	1250	1365	1475	1585				
50 km/h			1090	1200	1315	1425	1540	1650				

Ø inches	Description	CAI	e mm	D mm	R' mm	RC mm	Recommended Rim		Acceptable Rim	Tube (Code)	75% internal volume (litres)	Tread depth (mm)
38	420/85R38 144A8/144B TL	607820	455	1676	750	4975	DW15L		DW14L W14L W15L	786	311	51
Bar	0.4	0.5	0.6	0.8	1	1.2	1.4	1.6	1.8			
Psi	6	7	9	12	15	17	20	23	26			
max 40 km/h FRT					2160	2460	2760	3060	3360			
10 km/h	1900	2045	2190	2485	2775	3065	3360	3650	4015			
30 km/h	1375	1510	1645	1915	2190	2460	2730	3000				
40 km/h			1550	1800	2050	2300	2550	2800				
40 km/h Dual	1130	1240	1355	1575	1800	2020	2245	2465				
50 km/h			1550	1800	2050	2300	2550	2800				

* Refer to the notes at the end of the tables of this range

MICHELIN AGRIBIB

Tire specifications and pressure table (bar & psi). Load per tire in kg*

Ø inches	Description	CAI	e mm	D mm	R' mm	RC mm	Recommended Rim		Acceptable Rim		Tube (Code)	75% internal volume (litres)	Tread depth (mm)		
38	380/95R38 147A8/147B TL	836033	392	1689	769	5034	W12	W13	W13	W13	795	286	47		
Bar	0.4	0.5	0.6	0.8	1	1.2	1.4	1.6	1.8	2	2.1	2.3	2.4	2.6	2.8
Psi	6	7	9	12	15	17	20	23	26	29	30	33	35	38	41
10 km/h	1825	1980	2130	2440	2745	3055	3360	3670	3975	4100	4165	4295	4355	4485	4610
30 km/h	1300	1430	1555	1810	2070	2325	2580	2835	2950	3065	3120	3235	3290		
40 km/h			1450	1690	1930	2170	2410	2650	2755	2865	2915	3020	3075		
40 km/h Dual	1070	1150	1235	1395	1560	1725	1890	2050	2215	2380	2460	2625	2705		
50 km/h			1450	1690	1930	2170	2410	2650	2755	2865	2915	3020	3075		

Ø inches	Description	CAI	e mm	D mm	R' mm	RC mm	Recommended Rim		Acceptable Rim		Tube (Code)	75% internal volume (litres)	Tread depth (mm)		
38	18.4R38 151A8/148B TL	100097	494	1770	800	5267	DW16L	DW15L W16L	DW15L W15L	DW15L W15L	824	431	54		
Bar	0.4	0.5	0.6	0.8	1	1.2	1.4	1.6	1.8	2	2.1	2.3	2.4		
Psi	6	7	9	12	15	17	20	23	26	29	30	33	35		
10 km/h	2100	2305	2515	2925	3340	3750	3920	4090	4325	4560	4675	4910	5025		
30 km/h	1660	1875	2085	2280	2480	2675	2945	3210	3400	3595	3690				
40 km/h			1950	2135	2315	2500	2750	3000	3180	3360	3450				
40 km/h Dual	1195	1455	1715	1900	2085	2270	2455	2640	2800	2955	3035				
50 km/h			1775	1965	2155	2345	2540	2730	2895	3060	3140				

Ø inches	Description	CAI	e mm	D mm	R' mm	RC mm	Recommended Rim		Acceptable Rim		Tube (Code)	75% internal volume (litres)	Tread depth (mm)		
38	20.8R38 159A8/156B TL	813266	541	1850	837	5506	DW18L	DW16L W16L	DW18A W18L	DW16L W16L	825	524	57		
Bar	0.4	0.5	0.6	0.8	1	1.2	1.4	1.6	1.8	2	2.1	2.3	2.4	2.6	2.8
Psi	6	7	9	12	15	17	20	23	26	29	30	33	35	38	41
10 km/h	2550	2810	3065	3585	4100	4615	4895	5175	5495	5815	5910	6095	6190	6380	6565
30 km/h	1820	2015	2205	2525	2910	3290	3655	4015	4180	4350	4430	4595	4680		
40 km/h			2060	2360	2720	3075	3415	3750	3905	4065	4140	4295	4375		
40 km/h Dual			1810	2075	2390	2705	3005	3300	3440	3575	3645	3780	3850		
50 km/h			1875	2150	2475	2800	3110	3415	3555	3700	3770	3910	3980		

* Refer to the notes at the end of the tables of this range

MICHELIN AGRIBIB

Tire specifications and pressure table (bar & psi). Load per tire in kg*

Ø inches	Description	CAI	e mm	D mm	R' mm	RC mm	Recommended Rim	Acceptable Rim	Tube (Code)	75% internal volume (litres)	Tread depth (mm)
38	520/85R38 155A8/155B TL	303668	530	1855	821	5529	DW16L	DD16 DD18 DW16A W16A W18A	825	509	51
Bar	0.4	0.5	0.6	0.8	1	1.2	1.4	1.6	1.8		
Psi	6	7	9	12	15	17	20	23	26		
max 40 km/h FRT					3000	3415	3825	4240	4650		
10 km/h	2650	2850	3050	3450	3850	4250	4625	5000	5535		
30 km/h	1900	2100	2300	2650	3050	3450	3790	4125			
40 km/h			2120	2500	2825	3150	3515	3875			
40 km/h Dual	1540	1705	1865	2200	2485	2770	3090	3410			
50 km/h			2120	2500	2800	3160	3515	3875			

Ø inches	Description	CAI	e mm	D mm	R' mm	RC mm	Recommended Rim	Acceptable Rim	Tube (Code)	75% internal volume (litres)	Tread depth (mm)				
42	480/80R42 156A8/156B TL	404096	494	1858	847	5538	DW16A	DD16 W16A	801	420	55				
Bar	0.4	0.5	0.6	0.8	1	1.2	1.4	1.6	1.8	2	2.1	2.3	2.4	2.6	2.8
Psi	6	7	9	12	15	17	20	23	26	29	30	33	35	38	41
max 40 km/h FRT					2600	2955	3315	3670	4030	4385	4455	4595	4660	4800	
10 km/h	2325	2505	2690	3050	3415	3775	4140	4500	4750	5000	5125	5375	5500	5750	6000
30 km/h	1660	1830	2000	2335	2675	3015	3350	3690	3840	3985	4060	4205	4280		
40 km/h			1850	2170	2490	2810	3130	3450	3590	3725	3795	3930	4000		
40 km/h Dual	1320	1465	1605	1890	2180	2465	2750	3035	3155	3280	3340	3460	3520		
50 km/h			1850	2170	2490	2810	3130	3450	3590	3725	3795	3930	4000		

Ø inches	Description	CAI	e mm	D mm	R' mm	RC mm	Recommended Rim	Acceptable Rim	Tube (Code)	75% internal volume (litres)	Tread depth (mm)
42	520/85R42 157A8/157B TL	122791	539	1945	869	5771	DW18A	DD18 W18A	802	545	59
Bar	0.4	0.5	0.6	0.8	1	1.2	1.4	1.6	1.8		
Psi	6	7	9	12	15	17	20	23	26		
max 40 km/h FRT					3090	3555	4020	4485	4950		
10 km/h	2800	3015	3225	3650	4075	4500	4900	5300	5865		
30 km/h	2000	2180	2360	2800	3175	3550	3965	4375			
40 km/h			2240	2575	2965	3350	3740	4125			
40 km/h Dual	1630	1800	1970	2265	2610	2950	3290	3630			
50 km/h			2240	2575	3000	3350	3740	4125			

* Refer to the notes at the end of the tables of this range

MICHELIN AGRIBIB

Tire specifications and pressure table (bar & psi). Load per tire in kg*

Ø inches	Description	CAI	e mm	D mm	R' mm	RC mm	Recommended Rim		Acceptable Rim		Tube (Code)	75% internal volume (litres)	Tread depth (mm)		
46	420/80R46 151A8/1488 TL	122770	410	1872	861	5555	DW13		DW12		835	334	51		
Bar	0.4	0.5	0.6	0.8	1	1.2	1.4	1.6	1.8	2	2.1	2.3	2.4	2.6	2.8
Psi	6	7	9	12	15	17	20	23	26	29	30	33	35	38	41
10 km/h	2000	2170	2340	2675	3015	3350	3675	4000	4315	4625	4720	4905	5000	5075	5150
30 km/h	1450	1575	1700	2000	2290	2575	2865	3150	3300	3450	3500	3600	3650		
40 km/h				1600	1850	2140	2430	2665	2900	3075	3250	3300	3400	3450	
40 km/h Dual	1160	1285	1410	1630	1885	2140	2345	2550	2705	2860	2905	2990	3035		
50 km/h				1450	1700	1950	2240	2445	2650	2800	3000	3040	3115	3150	

Ø inches	Description	CAI	e mm	D mm	R' mm	RC mm	Recommended Rim		Acceptable Rim		Tube (Code)	75% internal volume (litres)	Tread depth (mm)		
46	480/80R46 158A8/1588 TL	637231	499	1948	889	5874	DW16A		DD16 DW16L W16A		834	449	54		
Bar	0.4	0.5	0.6	0.8	1	1.2	1.4	1.6	1.8	2	2.1	2.3	2.4	2.6	2.8
Psi	6	7	9	12	15	17	20	23	26	29	30	33	35	38	41
max 40 km/h FRT				2725	3095	3465	3830	4200	4570	4660	4835	4925	5100		
10 km/h	2475	2675	2875	3275	3675	4075	4475	4875	5125	5375	5500	5755	5880	6130	6380
30 km/h	1770	1940	2110	2445	2785	3125	3460	3800	3990	4175	4270	4455	4550		
40 km/h				1950	2270	2590	2910	3230	3550	3725	3900	3990	4165	4250	
40 km/h Dual	1450	1585	1715	1940	2165	2390	2615	2840	3065	3290	3405	3630	3740		
50 km/h				1950	2270	2590	2910	3230	3550	3725	3900	3990	4165	4250	

Ø inches	Description	CAI	e mm	D mm	R' mm	RC mm	Recommended Rim		Acceptable Rim		Tube (Code)	75% internal volume (litres)	Tread depth (mm)		
46	520/85R46 158A8/1558 TL	122780	515	2050	920	6088	DW16A		DW16L DW18A DW18L W16A W16L W18A W18L		834	581	58		
Bar	0.4	0.5	0.6	0.8	1	1.2	1.4	1.6	1.8						
Psi	6	7	9	12	15	17	20	23	26						
max 40 km/h FRT				3230	3700	4165	4635	5100							
10 km/h	2900	3115	3325	3750	4175	4600	5025	5450	6070						
30 km/h	2090	2295	2500	2910	3320	3730	4140	4550							
40 km/h				2300	2690	3080	3470	3860	4250						
40 km/h Dual	1715	1885	2055	2390	2730	3065	3400	3740							
50 km/h				2120	2470	2820	3175	3875							

* Refer to the notes at the end of the tables of this range

MICHELIN AGRIBIB

Tire specifications and pressure table (bar & psi). Load per tire in kg*

Ø inches	Description	CAI	e mm	D mm	R' mm	RC mm	Recommended Rim		Acceptable Rim		Tube (Code)	75% internal volume (litres)	Tread depth (mm)		
50	480/80R50 159A8/159B TL	471947	474	2056	942	6135	DW15A		DW16A			479	56		
Bar	0.4	0.5	0.6	0.8	1	1.2	1.4	1.6	1.8	2	2.1	2.3	2.4	2.6	2.8
Psi	6	7	9	12	15	17	20	23	26	29	30	33	35	38	41
max 40 km/h FRT				2830	3230	3635	4035	4440	4840	4910	5045	5115	5250		
10 km/h	2575	2785	2995	3415	3830	4250	4700	5150	5575	6000	6075	6225	6300	6400	6500
30 km/h	1800	1990	2180	2575	2915	3250	3625	4000	4190	4375	4440	4565	4625		
40 km/h			2060	2360	2720	3075	3415	3750	3940	4125	4190	4315	4375		
40 km/h Dual	1495	1655	1815	2075	2390	2705	3005	3300	3465	3630	3685	3795	3850		
50 km/h			2060	2360	2725	3075	3415	3750	3875	4125	4190	4315	4375		

Ø inches	Description	CAI	e mm	D mm	R' mm	RC mm	Recommended Rim		Acceptable Rim		Tube (Code)	75% internal volume (litres)	Tread depth (mm)		
50	480/95R50 164A8/164B TL	491183	515	2175	992	6484	DW16B (A)		DW15B (A)			593	53		
Bar	0.4	0.5	0.6	0.8	1	1.2	1.4	1.6	1.8	2	2.1	2.3	2.4	2.6	2.8
Psi	6	7	9	12	15	17	20	23	26	29	30	33	35	38	41
max 40 km/h FRT				3320	3760	4205	4645	5090	5530	5610	5765	5845	6000		
10 km/h	2925	3100	3270	3780	4285	4795	5300	5810	6185	6560	6750	7125	7310	7405	7500
30 km/h	2085	2305	2525	2955	3385	3820	4250	4680	4850	5015	5100	5265	5350		
40 km/h			2360	2765	3165	3570	3970	4375	4530	4690	4765	4920	5000		
40 km/h Dual	1720	1900	2080	2435	2790	3140	3495	3850	3990	4125	4195	4330	4400		
50 km/h			2360	2765	3165	3570	3970	4375	4530	4690	4765	4920	5000		

***IMPORTANT:**

The inflation pressure must always be appropriate for the load per tire, the speed of travel and the work to be done. Our recommendations above are provided subject to changes made after the date of publication of these tables. Technical data is subject to change without prior notice.

- For plowing and other field applications subject to high torque, use the 30 km/h line.
- When using single tire configuration:
 - add 0.4 bar for use on slopes of more than 20%
 - add 0.4 bar for intensive road use exceeding 50%
- FRT: Free Rolling Tire
- 10 km/h: low torque application only.



MICHELIN AGRIBIB ROW CROP

**EVEN MORE BENEFITS
FOR ROW CROP WORK**



FOR ROW CROP TRACTORS AND IMPLEMENTS



INCREASED LOAD CAPACITY

- New reinforced casing
- Improved load capacity thanks to a nominal pressure rating of 4 bars (vs. 2.4 or 3.6 depending on the size)



LESS COMPACTION

- Reduced soil compaction throughout the life of the tire thanks to "Improved Flexion" (IF) as part of MICHELIN Ultraflex.
- Less pressure for carrying the load leads to less compaction .



EXCELLENT TRACTION

- Excellent traction thanks to deep lug design and increased contact patch area.

SIZES

320/85R38 143A8/143B TL

IF 320/85R38 151A8/151B TL

320/90R42 147A8/147B TL

340/85R46 150A8/150B TL

380/90R46 157A8/157B TL

IF 380/90R46 165A8/165B TL

320/90R50 150A8/150B TL

380/90R50 151A8/151B TL

IF 320/90R50 158A8/158B TL

IF 380/90R50 167A8/167B TL

320/90R54 151A8/151B TL

IF 320/90R54 159A8/159B TL

MICHELIN AGRIBIB ROW CROP

Tire specifications and pressure table (bar & psi). Load per tire in kg*

Ø inches	Description	CAI	e mm	D mm	R' mm	RC mm	Recommended Rim		Acceptable Rim	Tube (Code)	75% internal volume (litres)		Tread depth (mm)
38	IF 320/85R38 151A8/151B TL	351097	330	1506	697	4496	DW11A		DW10A W10 W11	779	170		41
Bar	1.2 1.4 1.6	1.8	2	2.2	2.4	2.6	2.8	3	3.2	3.4	3.6	3.8	4
Psi	17 20 23	26	29	32	35	38	41	44	46	49	52	55	58
10 km/h	2025 2250 2475	2590	2700	2790	2875	3015	3150	3275	3400	3515	3625	3715	3800
20 km/h	1975 2200 2425	2540	2650	2740	2825	2965	3100	3225	3350	3465	3575	3650	3725
30 km/h	1900 2115 2325	2440	2550	2640	2725	2850	2975	3100	3225	3325	3425	3515	3600
50 km/h	1825 2040 2250	2350	2450	2540	2625	2750	2875	2990	3100	3200	3300	3375	3450

Ø inches	Description	CAI	e mm	D mm	R' mm	RC mm	Recommended Rim		Acceptable Rim	Tube (Code)	75% internal volume (litres)		Tread depth (mm)	
38	320/85R38 143A8/143B TL	758001	315	1508	699	4514	W10		DW10A DW11A W11	779	170		42	
Bar	1.2 1.4 1.6	1.8	2	2.2	2.4	2.6	2.8	3	3.2	3.4	3.6	3.8	4	
Psi	17 20 23	26	29	32	35	38	41	44	46	49	52	55	58	
10 km/h Cyc		2330	2520	2710	2900	3090	3205	3315	3430	3540	3700	3860	3975	4090
25 km/h Cyc	1890 2075 2260	2360	2460	2560	2660	2780	2900	3020	3140	3230	3320			
30 km/h Cyc	1770 1940 2110	2205	2300	2395	2490	2605	2715	2830	2940	3025	3110			
25 km/h	1720 1885 2050	2145	2235	2330	2420	2530	2640	2750	2860	2940	3020			
30 km/h	1660 1820 1980	2070	2155	2245	2330	2440	2545	2655	2760	2840	2920			
50 km/h	1550 1700 1850	1935	2015	2100	2180	2280	2380	2475	2575	2650	2725			

Ø inches	Description	CAI	e mm	D mm	R' mm	RC mm	Recommended Rim		Acceptable Rim	Tube (Code)	75% internal volume (litres)		Tread depth (mm)	
42	320/90R42 147A8/147B TL	425361	312	1638	764	4908	DW10L		W10L W9L		197		42	
Bar	1.2 1.4 1.6	1.8	2	2.2	2.4	2.6	2.8	3	3.2	3.4	3.6	3.8	4	
Psi	17 20 23	26	29	32	35	38	41	44	46	49	52	55	58	
10 km/h Cyc		2850	3025	3195	3370	3540	3650	3760	3865	3975	4165	4350	4480	4610
25 km/h Cyc	2075 2295 2510	2625	2740	2850	2965	3110	3255	3395	3540	3645	3750			
30 km/h Cyc	1940 2225 2510	2575	2640	2705	2770	2905	3040	3170	3305	3405	3505			
25 km/h	1890 2090 2290	2395	2495	2600	2700	2830	2960	3090	3220	3320	3415			
30 km/h	1820 2010 2200	2300	2400	2500	2600	2725	2850	2975	3100	3195	3290			
50 km/h	1700 1880 2060	2155	2245	2340	2430	2550	2665	2785	2900	2990	3075			

* Refer to the notes at the end of the tables of this range

MICHELIN AGRIBIB ROW CROP

Tire specifications and pressure table (bar & psi). Load per tire in kg*

Ø inches	Description	CAI	e mm	D mm	R' mm	RC mm	Recommended Rim		Acceptable Rim	Tube (Code)	75% internal volume (litres)	Tread depth (mm)			
46	340/85R46 150A8/150B TL	846786	338	1747	810	5227	W12		DW10A W10 W12A	835	225	41			
Bar	1.2	1.4	1.6	1.8	2	2.2	2.4	2.6	2.8	3	3.2	3.4	3.6	3.8	4
Psi	17	20	23	26	29	32	35	38	41	44	46	49	52	55	58
10 km/h Cyc			2780	3025	3265	3510	3750	3900	4050	4200	4350	4540	4730	4880	5030
25 km/h Cyc	2260	2495	2730	2855	2980	3105	3230	3385	3535	3690	3840	3965	4090		
30 km/h Cyc	2110	2330	2550	2670	2785	2905	3020	3165	3305	3450	3590	3705	3820		
25 km/h	2050	2270	2490	2605	2715	2830	2940	3080	3220	3360	3500	3610	3720		
30 km/h	1980	2190	2400	2510	2620	2730	2840	2975	3105	3240	3370	3475	3580		
50 km/h	1850	2045	2240	2345	2445	2550	2650	2775	2900	3025	3150	3250	3350		

Ø inches	Description	CAI	e mm	D mm	R' mm	RC mm	Recommended Rim		Acceptable Rim	Tube (Code)	75% internal volume (litres)	Tread depth (mm)			
46	IF 380/90R46 165A8/165B TL	120462	385	1841	852	5513	DW13A		DW11 DW12A DW13 W12 W12A W13 W13A	816	308	46			
Bar	1.2	1.4	1.6	1.8	2	2.2	2.4	2.6	2.8	3	3.2	3.4	3.6	3.8	4
Psi	17	20	23	26	29	32	35	38	41	44	46	49	52	55	58
10 km/h	3000	3340	3675	3850	4025	4150	4275	4475	4675	4890	5100	5240	5375	5525	5675
20 km/h	2950	3290	3625	3790	3950	4065	4175	4390	4600	4800	5000	5140	5275	5415	5550
30 km/h	2825	3150	3475	3640	3800	3915	4025	4225	4425	4615	4800	4940	5075	5215	5350
50 km/h	2725	3040	3350	3500	3650	3765	3875	4065	4250	4440	4625	4750	4875	5015	5150

Ø inches	Description	CAI	e mm	D mm	R' mm	RC mm	Recommended Rim		Acceptable Rim	Tube (Code)	75% internal volume (litres)	Tread depth (mm)			
46	380/90R46 157A8/157B TL	799905	401	1864	867	5583	W13A		DW13 DW13A W12 W12A W13	835	308	46			
Bar	1.2	1.4	1.6	1.8	2	2.2	2.4	2.6	2.8	3	3.2	3.4	3.6	3.8	4
Psi	17	20	23	26	29	32	35	38	41	44	46	49	52	55	58
10 km/h Cyc			3450	3740	4030	4320	4610	4790	4970	5150	5330	5570	5810	6000	6190
25 km/h Cyc	2810	3115	3420	3560	3695	3835	3970	4160	4350	4540	4730	4880	5030		
30 km/h Cyc	2620	2905	3190	3320	3450	3580	3710	3890	4065	4245	4420	4560	4700		
25 km/h	2550	2830	3110	3235	3360	3485	3610	3785	3955	4130	4300	4440	4580		
30 km/h	2460	2730	3000	3120	3240	3360	3480	3650	3815	3985	4150	4280	4410		
50 km/h	2300	2550	2800	2915	3025	3140	3250	3405	3565	3720	3875	4000	4125		

* Refer to the notes at the end of the tables of this range

MICHELIN AGRIBIB ROW CROP

Tire specifications and pressure table (bar & psi). Load per tire in kg*

Ø inches	Description	CAI	e mm	D mm	R' mm	RC mm	Recommended Rim		Acceptable Rim	Tube (Code)	75% internal volume (litres)	Tread depth (mm)		
50	320/90R50 150A8/150B TL	130813	314	1847	862	5539	W10		DW10A W10A	816	226	39		
Bar	1.2 1.4 1.6	1.8	2	2.2	2.4	2.6	2.8	3	3.2	3.4	3.6	3.8	4	
Psi	17 20 23	26	29	32	35	38	41	44	46	49	52	55	58	
10 km/h Cyc		2780	3025	3265	3510	3750	3900	4050	4200	4350	4540	4730	4880	5030
25 km/h Cyc	2260	2495	2730	2855	2980	3105	3230	3385	3535	3690	3840	3965	4090	
30 km/h Cyc	2110	2330	2550	2670	2785	2905	3020	3165	3305	3450	3590	3705	3820	
25 km/h	2050	2270	2490	2605	2715	2830	2940	3080	3220	3360	3500	3610	3720	
30 km/h	1980	2190	2400	2510	2620	2730	2840	2975	3105	3240	3370	3475	3580	
50 km/h	1850	2045	2240	2345	2445	2550	2650	2775	2900	3025	3150	3250	3350	

Ø inches	Description	CAI	e mm	D mm	R' mm	RC mm	Recommended Rim		Acceptable Rim	Tube (Code)	75% internal volume (litres)	Tread depth (mm)			
50	IF 320/90R50 158A8/158B TL	125798	329	1856	865	5544	DW11		DW10A DW11 W10 W10A W11	816	226	39			
Bar	1.2 1.4 1.6	1.8	2	2.2	2.4	2.6	2.8	3	3.2	3.4	3.6	3.8	4		
Psi	17 20 23	26	29	32	35	38	41	44	46	49	52	55	58		
10 km/h	2450	2725	3000	3140	3275	3390	3500	3665	3825	3975	4125	4265	4400	4540	4675
20 km/h	2400	2665	2925	3075	3225	3325	3425	3590	3750	3900	4050	4190	4325	4465	4600
30 km/h	2300	2565	2825	2965	3100	3200	3300	3465	3625	3765	3900	4025	4150	4290	4425
50 km/h	2225	2475	2725	2850	2975	3075	3175	3325	3475	3615	3750	3875	4000	4125	4250

Ø inches	Description	CAI	e mm	D mm	R' mm	RC mm	Recommended Rim		Acceptable Rim	Tube (Code)	75% internal volume (litres)	Tread depth (mm)
50	380/90R50 151A8/151B TL	036849	393	1935	912	5813	DW13A		DW12A W12A W13A		329	47
Bar	1.2 1.4 1.6	1.8	2	2.2	2.4	2.6	2.8					
Psi	17 20 23	26	29	32	35	38	41					
10 km/h Cyc		3540	3945	4350	4555	4765	4970	5175				
25 km/h Cyc	2880	3210	3540	3710	3875	4045	4210					
30 km/h Cyc	2690	3000	3305	3465	3620	3780	3935					
25 km/h	2620	2920	3220	3375	3525	3680	3830					
30 km/h	2525	2815	3100	3250	3395	3545	3690					
50 km/h	2360	2630	2900	3040	3175	3315	3450					

MICHELIN AGRIBIB ROW CROP

Tire specifications and pressure table (bar & psi). Load per tire in kg*

Ø inches	Description	CAI	e mm	D mm	R' mm	RC mm	Recommended Rim		Acceptable Rim		Tube (Code)	75% internal volume (litres)		Tread depth (mm)
50	IF 380/90R50 167A8/167B TL	212359	395	1953	903	5841	DW13A		DW12A W12A W13A			329		47
Bar	1.2 1.4 1.6	1.8	2	2.2	2.4	2.6	2.8	3	3.2	3.4	3.6	3.8	4	
Psi	17 20 23	26	29	32	35	38	41	44	46	49	52	55	58	
10 km/h	3200 3500 3800	4040	4275	4415	4550	4750	4950	5165	5375	5525	5675	5840	6000	
20 km/h	3125 3425 3725	3950	4175	4315	4450	4650	4850	5065	5275	5415	5550	5715	5875	
30 km/h	3025 3315 3600	3815	4025	4165	4300	4490	4675	4875	5075	5215	5350	5515	5675	
50 km/h	2900 3175 3450	3665	3875	4000	4125	4315	4500	4690	4875	5015	5150	5300	5450	

Ø inches	Description	CAI	e mm	D mm	R' mm	RC mm	Recommended Rim		Acceptable Rim		Tube (Code)	75% internal volume (litres)		Tread depth (mm)
54	IF 320/90R54 159A8/159B TL	467712	322	1949	915	5848	DW11		DW10 W10 W11		816	240		39
Bar	1.2 1.4 1.6	1.8	2	2.2	2.4	2.6	2.8	3	3.2	3.4	3.6	3.8	4	
Psi	17 20 23	26	29	32	35	38	41	44	46	49	52	55	58	
10 km/h	2550 2840 3125	3275	3425	3540	3650	3825	4000	4150	4300	4450	4600	4715	4825	
20 km/h	2500 2775 3050	3200	3350	3465	3575	3750	3925	4075	4225	4365	4500	4615	4725	
30 km/h	2400 2675 2950	3090	3225	3340	3450	3615	3775	3925	4075	4215	4350	4450	4550	
50 km/h	2325 2575 2825	2965	3100	3215	3325	3475	3625	3775	3925	4050	4175	4275	4375	

Ø inches	Description	CAI	e mm	D mm	R' mm	RC mm	Recommended Rim		Acceptable Rim		Tube (Code)	75% internal volume (litres)		Tread depth (mm)
54	320/90R54 151A8/151B TL	272304	315	1950	915	5852	W10		DW11 W11		816	240		39
Bar	1.2 1.4 1.6	1.8	2	2.2	2.4	2.6	2.8	3	3.2	3.4	3.6	3.8	4	
Psi	17 20 23	26	29	32	35	38	41	44	46	49	52	55	58	
10 km/h Cyc		2930	3165	3395	3630	3860	4020	4180	4340	4500	4690	4880	5030	5180
25 km/h Cyc	2380 2630 2880	2990	3100	3210	3320	3485	3645	3810	3970	4090	4210			
30 km/h Cyc	2220 2455 2690	2795	2900	3005	3110	3260	3410	3560	3710	3820	3930			
25 km/h	2160 2390 2620	2720	2820	2920	3020	3170	3315	3465	3610	3720	3830			
30 km/h	2090 2310 2530	2630	2725	2825	2920	3060	3200	3340	3480	3585	3690			
50 km/h	1950 2155 2360	2450	2545	2635	2725	2855	2990	3120	3250	3350	3450			

***IMPORTANT:**

The inflation pressure must always be appropriate for the load per tire, the speed of travel and the work to be done. Our recommendations above are provided subject to changes made after the date of publication of these tables. Technical data is subject to change without prior notice.

- For use on side slopes >20%: add 0.4 bar without exceeding the max tire pressure.
- For heavy road use >50%, add 0.4 bar.
- 10, 15 or 30 km/h cyclic load, for field use only, travel with full load not to exceed 1,5 km.

* Refer to the notes at the end of the tables of this range



MICHELIN SPRAYBIB^{CFO}

THE VERY LOW-PRESSURE SOLUTION FOR SELF-PROPELLED SPRAYERS

NEW



FOR **SPRAYERS** AND **ROW CROP APPLICATIONS**



VERY HIGH FLEXION (VF)



PRODUCTIVITY ⁽¹⁾

- 1st VF CFO tire E speed index for sprayers use.
The Cyclic Field Operation (CFO) standard enables a VF tire, to increase the load by +14% at field speeds



SOIL PROTECTION

- More shallow lugs combined with VF CFO pressure reduction for better soil protection



COMFORT

- Combination of MICHELIN SPRAYBIB tread design and the «Very high Flexion» (VF) within MICHELIN Ultraflex

(1) Compared to MICHELIN MEGAXBIB. Tests conducted on Michelin Tracks Ladoux Centre, in 2016, 2017 & 2018 and Fleet Survey tests with end users from 2015 to 2018.

SIZES

New sizes of MICHELIN SPRAYBIB CFO will be available by end 2022

VF 420/90R34 CFO 174D/170E TL **NEW**
 VF 380/80 R38 CFO 167D/163E **NEW**
 VF 320/90 R42 CFO 163D/159E **NEW**
 VF 480/80 R42 CFO 176D/172E **NEW**
 VF 320/90 R46 CFO 165D/161D **NEW**

VF 380/90R46 CFO 173D/169E TL **NEW**
 VF 480/80 R46 CFO 177D/173E **NEW**
 VF 320/90 R50 CFO 166D/162E **NEW**
 VF 380/90 R50 CFO 175D/171E **NEW**
 VF 420/95 R50 CFO 179D/175E **NEW**

VF 480/80 R50 CFO 179D/175E **NEW**
 VF 320/90 R54 CFO 168D/164E **NEW**
 VF 380/90 R54 CFO 176D/172E **NEW**

MICHELIN SPRAYBIB CFO

Tire specifications and pressure table (bar & psi). Load per tire in kg*

Ø inches	Description	CAI	e mm	D mm	R' mm	RC mm	Recommended Rim		Acceptable Rim		Tube (Code)	75% internal volume (litres)	Tread depth (mm)
34	VF 420/90R34 174D/170E TL NEW	343695	427	1603	720	4762	DW15L		DW14L W14L		704	310	40
Bar	0.8	1.1	1.4	1.7	2	2.3	2.6	2.9	3.2	3.5	3.8	4.1	4.4
Psi	12	16	20	25	29	33	38	42	46	51	55	59	64
15 km/h Cyclic	2285	2885	3485	4085	4685	5130	5470	5810	6115	6425	6730	7055	7505
30 km/h Cyclic	2285	2885	3485	4085	4685	5130	5470	5810	6115	6425	6730	7055	7505
10 km/h	2215	2800	3380	3965	4545	4970	5300	5630	5930	6225	6525	6840	7275
20 km/h	2095	2645	3195	3745	4295	4700	5015	5325	5605	5890	6170	6465	6875
50 km/h	2015	2545	3075	3600	4130	4520	4820	5120	5390	5660	5930	6215	6700
65 km/h	2015	2545	3075	3600	4130	4520	4820	5120	5390	5660	5930	6215	6700
70 km/h	1830	2315	2795	3280	3760	4110	4385	4660	4905	5150	5395	5655	6000

Ø inches	Description	CAI	e mm	D mm	R' mm	RC mm	Recommended Rim		Acceptable Rim		Tube (Code)	75% internal volume (litres)	Tread depth (mm)		
38	VF 380/80R38 167D/163E NEW	523910	380	1586	722	4727	DW13		DW12		795	230	38		
Bar	0.8	0.9	1	1.1	1.4	1.7	2	2.3	2.6	2.9	3.2	3.5	3.8	4.1	4.4
Psi	12	13	15	16	20	25	29	33	38	42	46	51	55	59	64
15 km/h Cyclic	2095	2240	2390	2535	2975	3415	3850	4205	4440	4705	4965	5230	5490	5790	6160
30 km/h Cyclic	2095	2240	2390	2535	2975	3415	3850	4205	4440	4705	4965	5230	5490	5790	6160
50 km/h	1845	1975	2105	2235	2620	3010	3395	3705	3910	4145	4375	4610	4840	5110	5450
65 km/h	1845	1975	2105	2235	2620	3010	3395	3705	3910	4145	4375	4610	4840	5110	5450
70 km/h	1680	1800	1915	2035	2385	2740	3090	3375	3560	3770	3985	4195	4405	4630	4875

Ø inches	Description	CAI	e mm	D mm	R' mm	RC mm	Recommended Rim		Acceptable Rim		Tube (Code)	75% internal volume (litres)	Tread depth (mm)		
42	VF 320/90R42 163D/159E NEW	028790	325	1640	761	4908	DW10		DW11			196	36		
Bar	0.8	0.9	1	1.1	1.4	1.7	2	2.3	2.6	2.9	3.2	3.5	3.8	4.1	4.4
Psi	12	13	15	16	20	25	29	33	38	42	46	51	55	59	64
15 km/h Cyclic	1810	1945	2085	2220	2630	3040	3450	3780	3990	4225	4460	4695	4935	5200	5535
30 km/h Cyclic	1810	1945	2085	2220	2630	3040	3450	3780	3990	4225	4460	4695	4935	5200	5535
50 km/h	1595	1715	1835	1955	2315	2680	3040	3330	3515	3720	3930	4140	4345	4585	4875
65 km/h	1595	1715	1835	1955	2315	2680	3040	3330	3515	3720	3930	4140	4345	4585	4875
70 km/h	1450	1560	1670	1780	2110	2435	2765	3030	3195	3385	3580	3770	3960	4160	4375

* Refer to the notes at the end of the tables of this range

MICHELIN SPRAYBIB CFO

Tire specifications and pressure table (bar & psi). Load per tire in kg*

Ø inches	Description			CAI	e mm	D mm	R' mm	RC mm	Recommended Rim		Acceptable Rim		Tube (Code)	75% internal volume (litres)	Tread depth (mm)
42	VF 480/80R42 176D/172E NEW			579330	482	1843	834	5484	DW16A		DD16 I W16		801	420	38
Bar	0.8	1	1.2	1.4	1.6	1.8	2	2.2	2.4	2.6	2.8	3	3.2	3.4	3.6
Psi	12	15	17	20	23	26	29	32	35	38	41	44	46	49	52
15 km/h Cyclic	3005	3580	4120	4660	5195	5730	5940	6155	6365	6665	6960	7260	7515	7765	8020
30 km/h Cyclic	3005	3580	4120	4660	5195	5730	5940	6155	6365	6665	6960	7260	7515	7765	8020
50 km/h	2650	3155	3630	4105	4580	5050	5235	5425	5610	5870	6135	6395	6630	6865	7100
65 km/h	2650	3155	3630	4105	4580	5050	5235	5425	5610	5870	6135	6395	6630	6865	7100
70 km/h	2410	2870	3305	3735	4165	4595	4765	4935	5105	5345	5580	5820	5980	6140	6300

Ø inches	Description			CAI	e mm	D mm	R' mm	RC mm	Recommended Rim		Acceptable Rim		Tube (Code)	75% internal volume (litres)	Tread depth (mm)
46	VF 320/90R46 165D/161E TL NEW			443039	311	1741	807	5209	DW10				835	211	37
Bar	0.8	0.9	1	1.1	1.4	1.7	2	2.3	2.6	2.9	3.2	3.5	3.8	4.1	4.4
Psi	12	13	15	16	20	25	29	33	38	42	46	51	55	59	64
15 km/h Cyclic	1945	2085	2225	2365	2785	3210	3630	3965	4195	4455	4715	4980	5250	5525	5805
30 km/h Cyclic	1945	2085	2225	2365	2785	3210	3630	3965	4195	4455	4715	4980	5250	5525	5805
50 km/h	1715	1840	1960	2085	2455	2825	3200	3495	3695	3925	4155	4390	4635	4895	5150
65 km/h	1715	1840	1960	2085	2455	2825	3200	3495	3695	3925	4155	4390	4635	4895	5150
70 km/h	1560	1675	1785	1900	2235	2575	2910	3180	3365	3575	3780	3990	4200	4415	4625

Ø inches	Description			CAI	e mm	D mm	R' mm	RC mm	Recommended Rim		Acceptable Rim		Tube (Code)	75% internal volume (litres)	Tread depth (mm)
46	VF 380/90R46 173D/169E TL NEW			007760	385	1843	847	5504	DW13A		DW12A W12 W12A W13 W13A		835	308	38
Bar	0.8	0.9	1	1.1	1.4	1.7	2	2.3	2.6	2.9	3.2	3.5	3.8	4.1	4.4
Psi	12	13	15	16	20	25	29	33	38	42	46	51	55	59	64
15 km/h Cyclic	2250	2450	2650	2850	3450	4050	4650	5125	5425	5765	6100	6440	6725	7025	7400
30 km/h Cyclic	2250	2450	2650	2850	3450	4050	4650	5125	5425	5765	6100	6440	6725	7025	7400
50 km/h	1975	2145	2320	2490	3005	3520	4030	4500	4815	5115	5450	5715	5900	6125	6500
65 km/h	1800	1960	2120	2280	2765	3245	3730	4100	4350	4640	4900	5165	5375	5575	5800
70 km/h	1975	2145	2320	2490	3005	3520	4030	4500	4815	5115	5450	5715	5900	6125	6500

* Refer to the notes at the end of the tables of this range

MICHELIN SPRAYBIB CFO

Tire specifications and pressure table (bar & psi). Load per tire in kg*

Ø inches	Description	CAI	e mm	D mm	R' mm	RC mm	Recommended Rim	Acceptable Rim	Tube (Code)	75% internal volume (litres)	Tread depth (mm)				
46	VF 480/80R46 177D/173E TL NEW	325824	485	1943	884	5788	DW16A(L)	DW15L DW16B W16A	834	449	38				
Bar	0.8	1	1.4	1.8	1.9	2	2.1	2.2	2.4	2.6	2.8	3	3.2	3.4	3.6
Psi	12	15	20	26	28	29	30	32	35	38	41	44	46	49	52
15 km/h Cyclic	3225	3830	4960	5995	6105	6215	6330	6440	6660	6970	7280	7590	7820	8055	8285
30 km/h Cyclic	3225	3830	4960	5995	6105	6215	6330	6440	6660	6970	7280	7590	7820	8055	8285
50 km/h	2845	3375	4370	5280	5380	5475	5575	5670	5865	6140	6415	6690	6895	7095	7300
65 km/h	2845	3375	4370	5280	5380	5475	5575	5670	5865	6140	6415	6690	6895	7095	7300
70 km/h	2585	3070	3975	4805	4895	4985	5075	5160	5340	5590	5835	6085	6225	6360	6500

Ø inches	Description	CAI	e mm	D mm	R' mm	RC mm	Recommended Rim	Acceptable Rim	Tube (Code)	75% internal volume (litres)	Tread depth (mm)				
50	VF 320/90R50 166D/162E TL NEW	840040	323	1849	865	5545	DW11	DW10 W10 W11	816	226	37				
Bar	0.8	0.9	1	1.1	1.4	1.7	2	2.3	2.6	2.9	3.2	3.5	3.8	4.1	4.4
Psi	12	13	15	16	20	25	29	33	38	42	46	51	55	59	64
15 km/h Cyclic	2095	2240	2380	2525	2950	3375	3805	4175	4435	4700	4970	5220	5495	5785	6075
30 km/h Cyclic	2095	2240	2380	2525	2950	3375	3805	4175	4435	4700	4970	5220	5495	5785	6075
50 km/h	1845	1970	2095	2220	2600	2975	3355	3680	3910	4140	4380	4600	4830	5065	5300
65 km/h	1845	1970	2095	2220	2600	2975	3355	3680	3910	4140	4380	4600	4830	5065	5300
70 km/h	1680	1795	1910	2025	2365	2710	3050	3350	3555	3770	3985	4185	4375	4565	4750

Ø inches	Description	CAI	e mm	D mm	R' mm	RC mm	Recommended Rim	Acceptable Rim	Tube (Code)	75% internal volume (litres)	Tread depth (mm)				
50	VF 380/90R50 175D/171E TL NEW	340728	384	1951	901	5834	DW13B	DW12A W12A W12B W13A W13B		329	38				
Bar	0.8	1	1.4	1.8	2.2	2.4	2.6	2.8	3	3.2	3.4	3.6	3.8	4	4.4
Psi	12	15	20	26	32	35	38	41	44	46	49	52	55	58	64
15 km/h Cyclic	2405	2860	3710	4505	5260	5410	5655	5905	6150	6395	6635	6875	7110	7350	7830
30 km/h Cyclic	2405	2860	3710	4505	5260	5410	5655	5905	6150	6395	6635	6875	7110	7350	7830
50 km/h	2120	2520	3265	3970	4635	4765	4985	5200	5420	5635	5845	6055	6270	6480	6900
65 km/h	2120	2520	3265	3970	4635	4765	4985	5200	5420	5635	5845	6055	6270	6480	6900
70 km/h	1925	2290	2975	3610	4215	4340	4540	4735	4935	5130	5300	5470	5640	5810	6150

MICHELIN SPRAYBIB CFO

Tire specifications and pressure table (bar & psi). Load per tire in kg*

Ø inches	Description	CAI	e mm	D mm	R' mm	RC mm	Recommended Rim		Acceptable Rim		Tube (Code)	75% internal volume (litres)		Tread depth (mm)	
50	VF 420/95R50 179D/175E TL NEW	358639	418	2059	941	6140	DW14B(A)		DW13B(A) W13B(A) W14B(A)			439		38	
Bar	0.8	1	1.2	1.4	1.6	1.8	2	2.2	2.4	2.6	2.8	3	3.2	3.6	4
Psi	12	15	17	20	23	26	29	32	35	38	41	44	46	52	58
15 km/h Cyclic	3065	3660	4225	4785	5345	5905	6125	6340	6560	6865	7175	7480	7750	8285	8715
30 km/h Cyclic	3065	3660	4225	4785	5345	5905	6125	6340	6560	6865	7175	7480	7750	8285	8715
50 km/h	2700	3225	3720	4215	4710	5200	5395	5585	5780	6050	6320	6590	6825	7300	7750
65 km/h	2700	3225	3720	4215	4710	5200	5395	5585	5780	6050	6320	6590	6820	7280	7750
70 km/h	2460	2935	3385	3835	4285	4735	4910	5085	5260	5505	5750	5995	6205	6625	6900

Ø inches	Description	CAI	e mm	D mm	R' mm	RC mm	Recommended Rim		Acceptable Rim		Tube (Code)	75% internal volume (litres)		Tread depth (mm)	
50	VF 480/80R50 179D/175E TL NEW	162735	485	2045	934	6098	DW16A(L)		DW15B(A) W15B(A) DW15L			479		38	
Bar	0.8	1	1.4	1.8	1.9	2	2.1	2.2	2.4	2.6	2.8	3	3.2	3.4	3.6
Psi	12	15	20	26	28	29	30	32	35	38	41	44	46	49	52
15 km/h Cyclic	3325	3955	5140	6255	6370	6485	6605	6720	6950	7275	7595	7920	8210	8505	8795
30 km/h Cyclic	3325	3955	5140	6255	6370	6485	6605	6720	6950	7275	7595	7920	8210	8505	8795
50 km/h	2930	3485	4530	5510	5610	5715	5815	5915	6120	6405	6695	6980	7235	7495	7750
65 km/h	2930	3485	4530	5510	5610	5715	5815	5915	6120	6405	6695	6980	7235	7495	7750
70 km/h	2665	3170	4120	5015	5110	5200	5295	5385	5570	5830	6090	6350	6535	6715	6900

Ø inches	Description	CAI	e mm	D mm	R' mm	RC mm	Recommended Rim		Acceptable Rim		Tube (Code)	75% internal volume (litres)		Tread depth (mm)	
54	VF 320/90R54 168D/164E TL NEW	666915	322	1955	910	5855	DW11		DW10 W10 W11		816	240		36	
Bar	0.8	0.9	1	1.1	1.4	1.7	2	2.3	2.6	2.9	3.2	3.5	3.8	4.1	4.4
Psi	12	13	15	16	20	25	29	33	38	42	46	51	55	59	64
15 km/h Cyclic	2075	2230	2390	2545	3015	3485	3950	4325	4575	4860	5150	5435	5730	6035	6335
30 km/h Cyclic	2075	2230	2390	2545	3015	3485	3950	4325	4575	4860	5150	5435	5730	6035	6335
50 km/h	1830	1970	2105	2245	2655	3070	3485	3815	4035	4285	4535	4785	5055	5325	5600
65 km/h	1830	1970	2105	2245	2655	3070	3485	3815	4035	4285	4535	4785	5055	5325	5600
70 km/h	1665	1790	1915	2040	2415	2795	3170	3470	3670	3900	4125	4355	4575	4785	5000

* Refer to the notes at the end of the tables of this range

MICHELIN SPRAYBIB CFO

Tire specifications and pressure table (bar & psi). Load per tire in kg*

Ø inches	Description	CAI	e mm	D mm	R' mm	RC mm	Recommended Rim		Acceptable Rim		Tube (Code)	75% internal volume (litres)	Tread depth (mm)		
54	VF 380/90R54 176D/172E TL NEW	019737	384	2049	948	6129	DW13A		W12A			349	37		
Bar	0.8 1 1.4 1.8 2.2 2.4 2.6 2.8 3 3.2 3.4 3.6 3.8 4 4.4														
Psi	12 15 20 26 32 35 38 41 44 46 49 52 55 58 64														
15 km/h Cyclic	2570	3045	3930	4750	5480	5635	5895	6150	6410	6665	6900	7130	7360	7595	8060
30 km/h Cyclic	2570	3045	3930	4750	5480	5635	5895	6150	6410	6665	6900	7130	7360	7595	8060
50 km/h	2265	2680	3460	4185	4830	4965	5190	5420	5645	5870	6075	6280	6485	6690	7100
65 km/h	2265	2680	3460	4185	4830	4965	5190	5420	5645	5870	6075	6280	6485	6690	7100
70 km/h	2060	2440	3150	3810	4395	4520	4725	4930	5135	5340	5500	5660	5820	5980	6300

***IMPORTANT:**

The inflation pressure must always be appropriate for the load per tire, the speed of travel and the work to be done. Our recommendations above are provided subject to changes made after the date of publication of these tables. Technical data is subject to change without prior notice.

- For machines working cyclically on slopes of more than 20% (11°), increase the operating pressure by 0.4 bar.
- For intensive road use exceeding 50% of road time, add 0.4 bar.
- 15 km/h Cyc & 30 km/h Cyc: work with cyclic loads at 15 km/h & 30 km/h
- CFO: Cyclic Field Operation generating a bonus for cyclic field loads (maximum distance of 1.5 km at full load)

* Refer to the notes at the end of the tables of this range



MICHELIN SPRAYBIB

A CHALLENGE FOR
YOUR AGRICULTURAL
YIELD



FOR **SPRAYERS** AND **ROW CROP APPLICATIONS**



VERY HIGH FLEXION (VF)



PRODUCTIVITY

- Robustness of tread lugs to reduce stubble



SOIL PROTECTION

- Wide and shallow tread lugs



COMFORT

- Low pressure with Very high Flexion (VF)
- **MICHELIN ULTRAFLEX Technology*** tire casing

(1) Internal test 2015 (Ladoux – France)

SIZES

VF 380/80R38 167D TL
 VF 320/90R42 163D TL
 VF 480/80R42 176D TL
 VF 320/90R46 165D TL
 VF 380/90R46 173D TL

VF 480/80R46 177D TL
 VF 320/90R50 166D TL
 VF 380/90R50 175D TL
 VF 420/95R50 177D TL
 VF 480/80R50 179D TL

VF 320/90R54 168D TL
 VF 320/105R54 172D **NEW**
 VF 380/90R54 176D TL

MICHELIN SPRAYBIB

Tire specifications and pressure table (bar & psi). Load per tire in kg*

Ø inches	Description	CAI	e mm	D mm	R' mm	RC mm	Recommended Rim		Acceptable Rim		Tube (Code)	75% internal volume (litres)	Tread depth (mm)	
38	VF 380/80R38 167D TL	352109	382	1577	726	4712	DW13		DW12		795	231	38	
Bar	1.8	2	2.2	2.4	2.6	2.8	3	3.2	3.4	3.6	3.8	4	4.2	4.4
Psi	26	29	32	35	38	41	44	46	49	52	55	58	61	64
65 km/h	3100	3375	3650	3750	3940	4125	4315	4500	4625	4750	4875	5000	5225	5450

Ø inches	Description	CAI	e mm	D mm	R' mm	RC mm	Recommended Rim		Acceptable Rim		Tube (Code)	75% internal volume (litres)	Tread depth (mm)	
42	VF 320/90R42 163D TL	920383	332	1635	758	4890	DW11		DW10			195	36	
Bar	1.8	2	2.2	2.4	2.6	2.8	3	3.2	3.4	3.6	3.8	4	4.2	4.4
Psi	26	29	32	35	38	41	44	46	49	52	55	58	61	64
65 km/h	2815	3025	3250	3350	3500	3650	3825	4000	4125	4250	4405	4565	4720	4875

Ø inches	Description	CAI	e mm	D mm	R' mm	RC mm	Recommended Rim		Acceptable Rim		Tube (Code)	75% internal volume (litres)	Tread depth (mm)	
42	VF 480/80R42 176D TL	929553	489	1838	833	5471	DW16A		DD16 W16A		801	420	38	
Bar	1.8	2	2.2	2.4	2.6	2.8	3	3.2	3.4	3.6				
Psi	26	29	32	35	38	41	44	46	49	52				
65 km/h	5000	5200	5400	5600	5875	6150	6425	6700	6900	7100				

Ø inches	Description	CAI	e mm	D mm	R' mm	RC mm	Recommended Rim		Acceptable Rim		Tube (Code)	75% internal volume (litres)	Tread depth (mm)	
46	VF 320/90R46 165D TL	684579	318	1736	810	5350	DW10				835	211	37	
Bar	1.80	2.00	2.20	2.40	2.60	2.80	3.00	3.20	3.40	3.60	3.80	4.00	4.20	4.40
Psi	26	29	32	35	38	41	44	46	49	52	55	58	61	64
65 km/h	3000	3230	3450	3550	3715	3875	4000	4125	4315	4500	4665	4825	4990	5150

Ø inches	Description	CAI	e mm	D mm	R' mm	RC mm	Recommended Rim		Acceptable Rim		Tube (Code)	75% internal volume (litres)	Tread depth (mm)	
46	VF 380/90R46 173D TL	198604	383	1842	848	5530	DW13A		DW12A W12 W12A W13 W13A		835	308	38	
Bar	1.8	2	2.2	2.4	2.6	2.8	3	3.2	3.4	3.6	3.8	4	4.2	4.4
Psi	26	29	32	35	38	41	44	46	49	52	55	58	61	64
65 km/h	3725	4050	4375	4625	4815	5000	5225	5450	5625	5800	5900	6000	6250	6500

* Refer to the notes at the end of the tables of this range

MICHELIN SPRAYBIB

Tire specifications and pressure table (bar & psi). Load per tire in kg*

Ø inches	Description	CAI	e mm	D mm	R' mm	RC mm	Recommended Rim		Acceptable Rim	Tube (Code)	75% internal volume (litres)	Tread depth (mm)
46	VF 480/80R46 177D TL	159186	485	1943	884	5788	DW16A (L)		DW15L DW16B W16A	834	449	38
Bar	1.8 2 2.2	2.4	2.6	2.8	3	3.2 3.4	3.6					
Psi	26 29 32	35	38	41	44	46 49	52					
65 km/h	5300 5465 5635	5800	6075	6350	6625	6900 7100	7300					

Ø inches	Description	CAI	e mm	D mm	R' mm	RC mm	Recommended Rim		Acceptable Rim	Tube (Code)	75% internal volume (litres)	Tread depth (mm)
50	VF 320/90R50 166D TL	946508	330	1844	864	5531	DW11		DW10 W10 W11	816	240	37
Bar	1.8 2 2.2	2.4	2.6	2.8	3	3.2 3.4	3.6 3.8		4	4.2	4.4	
Psi	26 29 32	35	38	41	44	46 49	52 55		58	61	64	
65 km/h	3040 3300 3650	3750	3875	4000	4190	4375 4500	4625 4795		4965	5130	5300	

Ø inches	Description	CAI	e mm	D mm	R' mm	RC mm	Recommended Rim		Acceptable Rim	Tube (Code)	75% internal volume (litres)	Tread depth (mm)
50	VF 380/90R50 175D TL	722276	384	1951	903	5836	DW13B		DW12A W12A W12B W13A W13B		329	38
Bar	1.8 2 2.2	2.4	2.6	2.8	3	3.2 3.4	3.6 3.8		4	4.2	4.4	
Psi	26 29 32	35	38	41	44	46 49	52 55		58	61	64	
65 km/h	3950 4300 4625	4750	4950	5150	5375	5600 5800	6000 6150		6300	6600	6900	

Ø inches	Description	CAI	e mm	D mm	R' mm	RC mm	Recommended Rim		Acceptable Rim	Tube (Code)	75% internal volume (litres)	Tread depth (mm)
50	VF 420/95R50 177D TL	085405	418	2059	941	6140	DW14B (A)		DW13B (A) W13B (A) W14B (A)		440	38
Bar	1.8 2 2.2	2.4	2.6	2.8	3	3.2 3.4	3.6					
Psi	26 29 32	35	38	41	44	46 49	52					
65 km/h	5150 5365 5585	5800	6075	6350	6625	6900 7100	7300					

Ø inches	Description	CAI	e mm	D mm	R' mm	RC mm	Recommended Rim		Acceptable Rim	Tube (Code)	75% internal volume (litres)	Tread depth (mm)
50	VF 480/80R50 179D TL	431251	485	2045	934	6098	DW16A(L)		DW15B (A) DW15L DW16B W15B (A) W16B		479	38
Bar	1.8 2 2.2	2.4	2.6	2.8	3	3.2 3.4	3.6					
Psi	26 29 32	35	38	41	44	46 49	52					
65 km/h	5450 5685 5915	6150	6440	6725	7015	7300 7525	7750					

* Refer to the notes at the end of the tables of this range

MICHELIN SPRAYBIB

Tire specifications and pressure table (bar & psi). Load per tire in kg*

Ø inches	Description	CAI	e mm	D mm	R' mm	RC mm	Recommended Rim		Acceptable Rim		Tube (Code)	75% internal volume (litres)	Tread depth (mm)	
54	VF 320/90R54 168D TL	044008	327	1950	909	5843	DW11		DW10 W10 W11		816	240	36	
Bar	1.8	2	2.2	2.4	2.6	2.8	3	3.2	3.4	3.6	3.8	4	4.2	4.4
Psi	26	29	32	35	38	41	44	46	49	52	55	58	61	64
65 km/h	3225	3500	3750	3875	4065	4250	4440	4625	4750	4875	5055	5240	5420	5600

Ø inches	Description	CAI	e mm	D mm	R' mm	RC mm	Recommended Rim		Acceptable Rim		Tube (Code)	75% internal volume (litres)	Tread depth (mm)		
54	VF 320/105R 54 172D TL NEW	624140	339	2028	938	6066	DW11		DW11		816	289	38		
Bar	0.8	0.9	1	1.1	1.4	1.7	2	2.3	2.6	2.9	3.2	3.5	3.8	4.1	4.4
Psi	12	13	15	16	20	25	29	33	38	42	46	51	55	59	64
65 km/h	2025	2200	2375	2550	3050	3525	3975	4315	4565	4850	5150	5375	5625	5925	6300

Ø inches	Description	CAI	e mm	D mm	R' mm	RC mm	Recommended Rim		Acceptable Rim		Tube (Code)	75% internal volume (litres)	Tread depth (mm)	
54	VF 380/90R54 176D TL	816598	384	2049	950	6131	DW13A		W12A			350	37	
Bar	1.8	2	2.2	2.4	2.6	2.8	3	3.2	3.4	3.6	3.8	4	4.2	4.4
Psi	26	29	32	35	38	41	44	46	49	52	55	58	61	64
65 km/h	4175	4525	4875	5000	5190	5375	5565	5750	5940	6125	6315	6500	6800	7100

***IMPORTANT:**

The inflation pressure must always be appropriate for the load per tire, the speed of travel and the work to be done. Our recommendations above are provided subject to changes made after the date of publication of these tables. Technical data is subject to change without prior notice.

- For use on side slopes: add 0.4 bar.
- For heavy road use: add 0.4 bar.



MICHELIN FLOATXBIB

**THE HIGHEST LOAD
CAPACITY IN THE FIELD
AND HIGHEST SPEED INDEX
ON ROADS**



FOR FLOATERS AND APPLICATORS



INCREASED PRODUCTIVITY⁽¹⁾

- Even pressure distribution across the contact patch
- Improved stubble resistance & wear
- New Innovative tread pattern and new rubber compound providing ULTRAFLEX benefits: low pressure, high load and speed capacity
- 1st VF CFO index E for floater usage
(CFO allows an increased load capacity of 55% when operating under 15 km/h)



IMPROVED YIELDS

- Rounded shoulders enable vegetation protection
- Doubled & reinforced shoulder lugs improve contact patch



IMPROVED COMFORT

- Reinforced central area with special lug design

(1) Compared to MICHELIN MEGAXBIB. Tests conducted on Michelin Tracks Ladoux Centre, in 2016, 2017 & 2018 and Fleet Survey tests with end users from 2015 to 2018.

SIZES

VF 1000/50R25 CFO 190D/186E TL

VF 750/50R26 CFO 174D/170E TL

IF 1000/55R32 CFO 191D/188E TL

VF 1000/55R32 CFO 197D/193E TL

VF 900/60R38 CFO 196D/192E TL

MICHELIN FLOATXBIB

Tire specifications and pressure table (bar & psi). Load per tire in kg*

Ø inches	Description	CAI	e mm	D mm	R' mm	RC mm	Recommended Rim	Acceptable Rim	Tube (Code)	75% internal volume (litres)	Tread depth (mm)
25	VF 1000/50R25 CFO 190D/186E TL	713716	1025	1643	712	4841	36.0TH		Joint R1438	893	40
Bar	1.2 1.4 1.6 1.8 2 2.2 2.4 2.6 2.8 3 3.2										
Psi	17 20 23 26 29 32 35 38 41 44 46										
15 km/h Cyc	8215 9145 10075	10540	11005	11510	12013	12595	13175	13565	13950		
30 km/h Cyc	6890 7670 8450	8840	9230	9655	10075	10565	11050	11375	11700		
65 km/h	6150 6825 7500	7875	8250	8625	9000	9375	9750	10175	10600		
70 km/h	5597 6210 6825	7165	7508	7850	8190	8530	8873	9185	9500		

Ø inches	Description	CAI	e mm	D mm	R' mm	RC mm	Recommended Rim	Acceptable Rim	Tube (Code)	75% internal volume (litres)	Tread depth (mm)
26	VF 750/50R26 CFO 174D/170E TL	982905	750	1405	619	4155	DW25B (A)			458	39
Bar	1.2 1.4 1.6 1.8 2 2.2 2.4 2.6 2.8 3 3.2										
Psi	17 20 23 26 29 32 35 38 41 44 46										
15 km/h Cyc	5193 5795 6394	6685	6975	7265	7556	8000	8448	8720	8990		
30 km/h Cyc	4355 4860 5363	5605	5850	6095	6338	6710	7085	7315	7540		
65 km/h	3875 4315 4750	5025	5300	5550	5800	6050	6300	6500	6700		
70 km/h	3526 3925 4323	4575	4823	5050	5278	5505	5733	5865	6000		

Ø inches	Description	CAI	e mm	D mm	R' mm	RC mm	Recommended Rim	Acceptable Rim	Tube (Code)	75% internal volume (litres)	Tread depth (mm)
32	VF 1000/55R32 CFO 197D/193E TL	946690	1042	1877	808	5523	36.00VA		Joint OR2052	1178	39
Bar	1.2 1.4 1.6 1.8 2 2.2 2.4 2.6 2.8 3 3.2										
Psi	17 20 23 26 29 32 35 38 41 44 46										
15 km/h Cyc	9765 10890 12015	12595	13175	13760	14340	14920	15500	16200	16895		
30 km/h Cyc	8190 9135 10075	10565	11050	11540	12025	12515	13000	13585	14170		
65 km/h	7300 7775 8250	9125	10000	10450	10900	11350	11800	12325	12850		
70 km/h	6650 7075 7500	8300	9100	9500	9900	10325	10750	11225	11700		

Ø inches	Description	CAI	e mm	D mm	R' mm	RC mm	Recommended Rim	Acceptable Rim	Tube (Code)	75% internal volume (litres)	Tread depth (mm)
32	IF 1000/55R32 CFO 191D/188E TL	564739	1042	1877	820	5540	36.00VA		Joint OR2052	1178	38
Bar	1.2 1.4 1.6 1.8 2 2.2 2.4 2.6 2.8 3 3.2										
Psi	17 20 23 26 29 32 35 38 41 44 46										
15 km/h Cyc	9765 10890 12013	12595	13175	13755	14338	14920	15500	16200	16895		
30 km/h Cyc	8190 9135 10075	10565	11050	11540	12025	12515	13000	13585	14170		
65 km/h	6300 7025 7750	8125	8500	8875	9250	9625	10000	10450	10900		
70 km/h	5800 6450 7100	7425	7750	8125	8500	8875	9250	9625	10000		

* Refer to the notes at the end of the tables of this range

MICHELIN FLOATXBIB

Tire specifications and pressure table (bar & psi). Load per tire in kg*

Ø inches	Description	CAI	e mm	D mm	R' mm	RC mm	Recommended Rim		Acceptable Rim	Tube (Code)	75% internal volume (litres)	Tread depth (mm)
38	VF 900/60R38 CFO 196D/192E TL	098689	873	2039	914	6041	DW30B (A)		DW27B (A) (NRO)		1149	39
Bar	1.2 1.4 1.6 1.8	1.8	2	2.2	2.4	2.6	2.8	3	3.2			
Psi	17 20 23 26	26	29	32	35	38	41	44	46			
15 km/h Cyc	9533 10580 11625	12400	13175	13565	13950	14725	15500	15965	16430			
30 km/h Cyc	7995 8875 9750	10400	11050	11375	11700	12350	13000	13390	13780			
65 km/h	7300 8025 8750	9250	9750	10175	10600	11050	11500	12000	12500			
70 km/h	6643 7305 7963	8420	8873	9260	9646	10055	10465	10835	11200			

***IMPORTANT:**

The inflation pressure must always be appropriate for the load per tire, the speed of travel and the work to be done. Our recommendations above are provided subject to changes made after the date of publication of these tables. Technical data is subject to change without prior notice.

- For machines working cyclically on slopes of more than 20% (11°), increase the operating pressure by 0.4 bar.
- For intensive road use exceeding 50% of road time, add 0.4 bar.
- 15 km/h Cyc & 30 km/h Cyc: work with cyclic loads at 15 km/h & 30 km/h
- CFO: Cyclic Field Operation generating a bonus for cyclic field loads (maximum distance of 1.5 km at full load)



MICHELIN CEREXBIB 2

**HIGH PRODUCTIVITY
& OUTSTANDING SOIL
PROTECTION**



FOR HARVESTING MACHINES



CFO+ rated tire

- Carry more load at 10 km/h cyclic in the field
- -45% pressure vs non CFO+ radial tire in the same size⁽¹⁾



BETTER YIELDS

- Potential increase in yields of up to 4% year⁽²⁾



SOIL PROTECTION

- Low pressure in the fields



TRACTION & FLOTATION



STEEL REINFORCED TREAD

- Great stability
- Excellent puncture resistance and better load distribution.

(1) For 12 000 kg, compared to a 900/60R32 MICHELIN MEGAXBIB standard radial tire

(2) Study led by Harper Adams University, Newport, United Kingdom - from 2014 to 2016/2014/2016

SIZES

VF 520/80R26 CFO+ 168A8 TL

VF 620/70R26 CFO+ 173A8 TL

VF 750/65R26 CFO+ 180A8 TL

VF 520/85R30 CFO+ 172A8 TL

VF 620/70R30 CFO+ 175A8 TL

VF 710/65R30 CFO+ 179A8 TL

IF 800/65R32 CFO+ 181A8 TL

IF 800/70R32 CFO+ 185A8 TL

VF 900/60R32 CFO+ 191A8 TL

VF 500/85R34 CFO+ 172A8 TL

IF 680/80R38 CFO+ 182A8 TL

IF 800/70R38 CFO+ 187A8 TL

VF 900/60R38 CFO+ 193A8 TL **NEW**

IF 800/70R42 CFO+ 189A8 TL

VF 520/85R42 CFO+ 177A8 TL

VF 580/85R42 CFO+ 183A8 TL

VF 710/70R42 CFO+ 188A8 TL

VF 900/60R42 CFO+ 195A8 TL

MICHELIN CEREXBIB 2

Tire specifications and pressure table (bar & psi). Load per tire in kg*

Ø inches	Description	CAI	e mm	D mm	R' mm	RC mm	Recommended Rim		Acceptable Rim		Tube (Code)	75% internal volume (litres)	Tread depth (mm)		
26	VF 520/80R26 CFO+ 168A8 TL	850494	503	1491	649	4400	DW16L	DW18L W16L	716	366	44				
Bar	1.2	1.4	1.6	1.7	1.8	1.9	2	2.1	2.2	2.3	2.4	2.5	2.6	2.7	2.8
Psi	17	20	23	25	26	28	29	30	32	33	35	36	38	39	41
10 km/h Cyc	5230	5805	6375	6510	6645	6775	6910	7045	7175	7310	7440	7600	7760	7915	8075
15 km/h Cyc	4765	5290	5815	5935	6060	6180	6300	6420	6540	6660	6780	6925	7075	7220	7365
40 km/h	3550	3965	4375	4470	4570	4665	4760	4860	4955	5055	5150	5265	5375	5490	5600

Ø inches	Description	CAI	e mm	D mm	R' mm	RC mm	Recommended Rim		Acceptable Rim		Tube (Code)	75% internal volume (litres)	Tread depth (mm)		
26	VF 620/70R26 CFO+ 173A8 TL	228272	606	1513	655	4461	DW20B (A)			716	463	45			
Bar	1.2	1.4	1.6	1.7	1.8	1.9	2	2.1	2.2	2.3	2.4	2.5	2.6	2.7	2.8
Psi	17	20	23	25	26	28	29	30	32	33	35	36	38	39	41
10 km/h Cyc	6035	6740	7440	7605	7770	7935	8100	8265	8430	8590	8755	8945	9140	9330	9520
15 km/h Cyc	5505	6145	6780	6930	7080	7230	7380	7530	7685	7835	7985	8160	8335	8505	8680
40 km/h	4125	4640	5150	5255	5365	5470	5575	5680	5790	5895	6000	6125	6250	6375	6500

Ø inches	Description	CAI	e mm	D mm	R' mm	RC mm	Recommended Rim		Acceptable Rim		Tube (Code)	75% internal volume (litres)	Tread depth (mm)		
26	VF 750/65R26 CFO+ 180A8 TL	132266	748	1623	701	4786	DW25B (A)			833	659	48			
Bar	1.2	1.4	1.6	1.7	1.8	1.9	2	2.1	2.2	2.3	2.4	2.5	2.6	2.7	2.8
Psi	17	20	23	25	26	28	29	30	32	33	35	36	38	39	41
10 km/h Cyc	7440	8225	9010	9225	9435	9650	9860	10075	10285	10500	10710	10965	11220	11475	11730
15 km/h Cyc	6780	7500	8215	8410	8605	8795	8990	9185	9380	9570	9765	10000	10230	10465	10695
40 km/h	5150	5650	6150	6295	6440	6580	6725	6870	7015	7155	7300	7475	7650	7825	8000

Ø inches	Description	CAI	e mm	D mm	R' mm	RC mm	Recommended Rim		Acceptable Rim		Tube (Code)	75% internal volume (litres)	Tread depth (mm)		
30	VF 620/70R30 CFO+ 175A8 TL	049288	608	1615	700	4765	DW20B (A)			737	506	43			
Bar	1.2	1.4	1.6	1.7	1.8	1.9	2	2.1	2.2	2.3	2.4	2.5	2.6	2.7	2.8
Psi	17	20	23	25	26	28	29	30	32	33	35	36	38	39	41
10 km/h Cyc	6375	7120	7865	8040	8215	8390	8565	8740	8915	9090	9265	9500	9735	9965	10200
15 km/h Cyc	5815	6495	7170	7330	7490	7650	7810	7970	8130	8290	8450	8665	8875	9090	9300
40 km/h	4500	4975	5450	5555	5665	5770	5875	5980	6090	6195	6300	6450	6600	6750	6900

* Refer to the notes at the end of the tables of this range

MICHELIN CEREXBIB 2

Tire specifications and pressure table (bar & psi). Load per tire in kg*

Ø inches	Description	CAI	e mm	D mm	R' mm	RC mm	Recommended Rim		Acceptable Rim		Tube (Code)	75% internal volume (litres)	Tread depth (mm)		
30	VF 520/85R30 CFO+ 172A8 TL	188276	522	1624	709	4797	W16L				737	435	46		
Bar	1.2	1.4	1.6	1.7	1.8	1.9	2	2.1	2.2	2.3	2.4	2.5	2.6	2.7	2.8
Psi	17	20	23	25	26	28	29	30	32	33	35	36	38	39	41
10 km/h Cyc	5865	6545	7225	7360	7495	7625	7760	7895	8025	8160	8290	8535	8780	9020	9265
15 km/h Cyc	5350	5970	6590	6710	6830	6950	7070	7190	7315	7435	7555	7780	8005	8225	8450
40 km/h	4000	4440	4875	4990	5110	5225	5340	5455	5570	5685	5800	5925	6050	6175	6300

Ø inches	Description	CAI	e mm	D mm	R' mm	RC mm	Recommended Rim		Acceptable Rim		Tube (Code)	75% internal volume (litres)	Tread depth (mm)		
30	VF 710/65R30 CFO+ 179A8 TL	608814	693.9	1676	735	4952	DW25B (A)		DW23B (A)			630	46		
Bar	1.2	1.4	1.6	1.7	1.8	1.9	2	2.1	2.2	2.3	2.4	2.5	2.6	2.7	2.8
Psi	17	20	23	25	26	28	29	30	32	33	35	36	38	39	41
10 km/h Cyc	7225	7990	8755	8970	9180	9395	9605	9820	10030	10245	10455	10690	10925	11155	11390
15 km/h Cyc	6590	7290	7985	8180	8375	8565	8760	8955	9150	9340	9535	9750	9960	10175	10385
40 km/h	5000	5500	6000	6140	6275	6415	6550	6690	6825	6965	7100	7265	7425	7590	7750

Ø inches	Description	CAI	e mm	D mm	R' mm	RC mm	Recommended Rim		Acceptable Rim		Tube (Code)	75% internal volume (litres)	Tread depth (mm)		
32	IF 800/65R32 CFO+ 181A8 TL	987406	772	1855	826	5501	DW27B (A)				831	903	57		
Bar	1.2	1.4	1.6	1.7	1.8	1.9	2	2.1	2.2	2.3	2.4	2.5	2.6	2.7	2.8
Psi	17	20	23	25	26	28	29	30	32	33	35	36	38	39	41
10 km/h Cyc	9010	9860	10710	10965	11220	11475	11730	11985	12240	12495	12750	13070	13390	13705	14025
15 km/h Cyc	8215	8990	9765	10000	10230	10465	10695	10930	11160	11395	11625	11915	12210	12500	12790
40 km/h	5300	5800	6300	6450	6600	6750	6900	7050	7200	7350	7500	7690	7875	8065	8250

Ø inches	Description	CAI	e mm	D mm	R' mm	RC mm	Recommended Rim		Acceptable Rim		Tube (Code)	75% internal volume (litres)	Tread depth (mm)		
32	VF 900/60R32 CFO+ 191A8 TL	430737	893	1903	827	5618	DW30B (A)		DW27B (A) (NRO)			1033	58		
Bar	1.2	1.4	1.6	1.7	1.8	1.9	2	2.1	2.2	2.3	2.4	2.5	2.6	2.7	2.8
Psi	17	20	23	25	26	28	29	30	32	33	35	36	38	39	41
10 km/h Cyc	9860	10965	12070	12370	12665	12965	13260	13560	13855	14155	14450	14770	15090	15405	15725
15 km/h Cyc	8990	10000	11005	11275	11550	11820	12090	12360	12635	12905	13175	13465	13760	14050	14340
40 km/h	6700	7475	8250	8470	8690	8905	9125	9345	9565	9780	10000	10225	10450	10675	10900

* Refer to the notes at the end of the tables of this range

MICHELIN CEREXBIB 2

Tire specifications and pressure table (bar & psi). Load per tire in kg*

Ø inches	Description	CAI	e mm	D mm	R' mm	RC mm	Recommended Rim		Acceptable Rim		Tube (Code)	75% internal volume (litres)	Tread depth (mm)		
32	IF 800/70R32 CFO+ 185A8 TL	789156	796	1950	864	5800	DW27B (A)				831	966	55		
Bar	1.2	1.4	1.6	1.7	1.8	1.9	2	2.1	2.2	2.3	2.4	2.5	2.6	2.7	2.8
Psi	17	20	23	25	26	28	29	30	32	33	35	36	38	39	41
10 km/h Cyc	9860	10965	12070	12370	12665	12965	13260	13560	13855	14155	14450	14770	15090	15405	15725
15 km/h Cyc	8990	10000	11005	11275	11550	11820	12090	12360	12635	12905	13175	13465	13760	14050	14340
40 km/h	5800	6450	7100	7275	7450	7625	7800	7975	8150	8325	8500	8690	8875	9065	9250

Ø inches	Description	CAI	e mm	D mm	R' mm	RC mm	Recommended Rim		Acceptable Rim		Tube (Code)	75% internal volume (litres)	Tread depth (mm)		
34	VF 500/85R34 CFO+ 172A8 TL	038009	497	1676	741	4961	DW16L		DW18L			431	46		
Bar	1.2	1.4	1.6	1.7	1.8	1.9	2	2.1	2.2	2.3	2.4	2.5	2.6	2.7	2.8
Psi	17	20	23	25	26	28	29	30	32	33	35	36	38	39	41
10 km/h Cyc	5870	6445	7020	7180	7340	7495	7655	7815	7975	8130	8290	8470	8650	8830	9010
15 km/h Cyc	5350	5875	6400	6545	6690	6835	6980	7125	7270	7415	7560	7725	7890	8055	8220
40 km/h	4000	4440	4875	4965	5060	5150	5240	5330	5420	5510	5600	5775	5950	6125	6300

Ø inches	Description	CAI	e mm	D mm	R' mm	RC mm	Recommended Rim		Acceptable Rim		Tube (Code)	75% internal volume (litres)	Tread depth (mm)		
38	IF 800/80R38 CFO+ 182A8 TL	953912	646	2020	904	6030	DW21B		DW23B (A)		804	877	59		
Bar	1.2	1.4	1.6	1.7	1.8	1.9	2	2.1	2.2	2.3	2.4	2.5	2.6	2.7	2.8
Psi	17	20	23	25	26	28	29	30	32	33	35	36	38	39	41
10 km/h Cyc	9265	10330	11390	11615	11835	12060	12285	12505	12730	12950	13175	13495	13815	14130	14450
15 km/h Cyc	8450	9420	10385	10590	10795	10995	11200	11405	11610	11810	12015	12305	12595	12885	13175
30 km/h Cyc	7085	7900	8710	8880	9050	9220	9395	9565	9735	9905	10075	10320	10565	10805	11050
40 km/h	5450	6075	6700	6830	6965	7095	7225	7355	7490	7620	7750	7940	8125	8315	8500

Ø inches	Description	CAI	e mm	D mm	R' mm	RC mm	Recommended Rim		Acceptable Rim		Tube (Code)	75% internal volume (litres)	Tread depth (mm)		
38	IF 800/70R38 CFO+ 187A8 TL	610997	790	2051	912	6079	DW27B (A)				804	1088	57		
Bar	1.2	1.4	1.6	1.7	1.8	1.9	2	2.1	2.2	2.3	2.4	2.5	2.6	2.7	2.8
Psi	17	20	23	25	26	28	29	30	32	33	35	36	38	39	41
10 km/h Cyc	10710	11945	13175	13440	13705	13970	14240	14505	14770	15035	15300	15620	15940	16255	16575
15 km/h Cyc	9765	10885	12000	12245	12490	12730	12975	13220	13465	13705	13950	14240	14530	14820	15110
40 km/h	6300	7025	7750	7905	8065	8220	8375	8530	8690	8845	9000	9190	9375	9565	9750

* Refer to the notes at the end of the tables of this range

MICHELIN CEREXBIB 2

Tire specifications and pressure table (bar & psi). Load per tire in kg*

Ø inches	Description	CAI	e mm	D mm	R' mm	RC mm	Recommended Rim		Acceptable Rim	Tube (Code)	75% internal volume (litres)	Tread depth (mm)			
38	VF 900/60R38 CFO+ 193A8 TL NEW	853285	880	2027	888	5987	DW30B(A)		DW27B (A) (NRO)		1147	58			
Bar	1.2	1.3	1.4	1.5	1.6	1.7	1.8	1.9	2	2.1	2.2	2.3	2.4	2.6	2.8
Psi	17	19	20	22	23	24	26	27	29	30	32	33	35	38	41
10 km/h Cyc	10455	11030	11605	12175	12750	13070	13390	13705	14025	14345	14665	14980	15300	16150	17000
15 km/h Cyc	9765	10325	10885	11440	12000	12245	12490	12730	12975	13220	13465	13705	13950	14750	15550
40 km/h	7300	7665	8025	8390	8750	8980	9215	9445	9675	9905	10140	10370	10600	11050	11500

Ø inches	Description	CAI	e mm	D mm	R' mm	RC mm	Recommended Rim		Acceptable Rim	Tube (Code)	75% internal volume (litres)	Tread depth (mm)			
42	VF 580/85R42 CFO+ 177A8 TL	270459	541	1953	881	5807	DW18B(A)		DD18 W18L	802	545	55			
Bar	1.2	1.4	1.6	1.7	1.8	1.9	2	2.1	2.2	2.3	2.4	2.5	2.6	2.7	2.8
Psi	17	20	23	25	26	28	29	30	32	33	35	36	38	39	41
10 km/h Cyc	6800	7545	8285	8465	8650	8830	9010	9225	9435	9650	9860	10075	10285	10500	10710
10 km/h Cyc Dual	5985	6640	7295	7470	7640	7815	7985	8160	8330	8505	8675	8865	9050	9240	9425
15 km/h Cyc	6200	6880	7555	7720	7885	8050	8215	8410	8605	8795	8990	9185	9380	9570	9765
15 km/h Cyc Dual	5455	6055	6650	6810	6965	7125	7280	7440	7595	7755	7910	8080	8255	8425	8595
40 km/h	4625	5215	5800	5915	6025	6140	6250	6365	6475	6590	6700	6850	7000	7150	7300

Ø inches	Description	CAI	e mm	D mm	R' mm	RC mm	Recommended Rim		Acceptable Rim	Tube (Code)	75% internal volume (litres)	Tread depth (mm)			
42	VF 580/85R42 CFO+ 183A8 TL	844076	580	2040	903	6040	DW18B(A)			802	701	58			
Bar	1.2	1.4	1.6	1.7	1.8	1.9	2	2.1	2.2	2.3	2.4	2.5	2.6	2.7	2.8
Psi	17	20	23	25	26	28	29	30	32	33	35	36	38	39	41
10 km/h Cyc	8075	8970	9860	10050	10245	10435	10625	10815	11010	11200	11390	11730	12070	12410	12750
10 km/h Cyc Dual	7110	7895	8680	8850	9015	9185	9350	9520	9685	9855	10020	10320	10620	10920	11220
15 km/h Cyc	7365	8180	8990	9165	9340	9515	9690	9860	10035	10210	10385	10695	11005	11315	11625
15 km/h Cyc Dual	6480	7195	7910	8065	8220	8370	8525	8680	8835	8985	9140	9415	9685	9960	10230
40 km/h	5450	6075	6700	6865	7025	7190	7350	7515	7675	7840	8000	8190	8375	8565	8750

Ø inches	Description	CAI	e mm	D mm	R' mm	RC mm	Recommended Rim		Acceptable Rim	Tube (Code)	75% internal volume (litres)	Tread depth (mm)			
42	VF 710/70R42 CFO+ 188A8 TL	499992	705	2097	927	6207	DW23B (A)		DW25B (A)	802	867	64			
Bar	1.2	1.4	1.6	1.7	1.8	1.9	2	2.1	2.2	2.3	2.4	2.5	2.6	2.7	2.8
Psi	17	20	23	25	26	28	29	30	32	33	35	36	38	39	41
10 km/h Cyc	9265	10330	11390	11615	11835	12060	12280	12505	12730	12950	13175	13495	13815	14130	14450
15 km/h Cyc	8450	9420	10385	10590	10795	10995	11200	11405	11610	11810	12015	12305	12595	12885	13175
40 km/h			7750	7905	8065	8220	8375	8530	8690	8845	9000	9250	9500	9750	10000

* Refer to the notes at the end of the tables of this range

MICHELIN CEREXBIB 2

Tire specifications and pressure table (bar & psi). Load per tire in kg*

Ø inches	Description	CAI	e mm	D mm	R' mm	RC mm	Recommended Rim		Acceptable Rim		Tube (Code)	75% internal volume (litres)	Tread depth (mm)		
42	VF 900/60R42 CFO+ 195A8 TL	856296	843	2118	930	6281	DW30B (A)		TW30B			1227	59		
Bar	1.2	1.4	1.6	1.7	1.8	1.9	2	2.1	2.2	2.3	2.4	2.5	2.6	2.7	2.8
Psi	17	20	23	25	26	28	29	30	32	33	35	36	38	39	41
10 km/h Cyc	11050	12325	13600	13920	14240	14555	14875	15195	15515	15830	16150	16490	16830	17170	17510
15 km/h Cyc	10075	11240	12400	12690	12985	13275	13565	13855	14145	14435	14725	15035	15345	15655	15965
30 km/h Cyc	8450	9425	10400	10645	10890	11130	11375	11620	11865	12105	12350	12610	12870	13130	13390
40 km/h	7500	8375	9250	9515	9775	10040	10300	10525	10750	10975	11200	11440	11675	11915	12150

Ø inches	Description	CAI	e mm	D mm	R' mm	RC mm	Recommended Rim		Acceptable Rim		Tube (Code)	75% internal volume (litres)	Tread depth (mm)		
42	IF 800/70R42 CFO+ 189A8 TL	818789	770	2151	964	6387	DW27B (A)		DW25B (A) DW28B (A)			1144	58		
Bar	1.2	1.4	1.6	1.7	1.8	1.9	2	2.1	2.2	2.3	2.4	2.5	2.6	2.7	2.8
Psi	17	20	23	25	26	28	29	30	32	33	35	36	38	39	41
10 km/h Cyc	11050	12325	13600	13920	14240	14555	14875	15195	15515	15830	16150	16490	16830	17170	17510
15 km/h Cyc	10075	11240	12400	12690	12980	13270	13565	13855	14145	14435	14725	15035	15345	15655	15965
30 km/h Cyc	8450	9425	10400	10645	10890	11130	11375	11620	11865	12105	12350	12610	12870	13130	13390
40 km/h	6500	7250	8000	8190	8375	8565	8750	8940	9125	9315	9500	9700	9900	10100	10300

***IMPORTANT:**

The inflation pressure must always be appropriate for the load per tire, the speed of travel and the work to be done. Our recommendations above are provided subject to changes made after the date of publication of these tables. Technical data is subject to change without prior notice.

- For standard or slope correction machines working on slopes of over 20% (11°), increase the usage pressure by 0.4 bar without exceeding the maximum load.
- For intensive road use (>50%) add 0.4 bar.
- 10 km/h Cyc: Harvesting work with cyclic loads at 10 km/h.
- 15 km/h Cyc: Harvesting work with cyclic loads at 15 km/h.
- CFO+: Cyclic Field Operation generating a bonus for cyclic loads in the field (1,5 km maximum distance fully loaded).



MICHELIN CEREXBIB

**HIGH LOAD CAPACITY
AT LOW PRESSURE
FOR LARGE HARVESTING
MACHINERY**



FOR HARVESTING MACHINES



BETTER YIELDS

- Potential increase in yields of up to 4% year⁽¹⁾



Greater **LOAD CAPACITY** up to 40%⁽²⁾



MORE TRACTION

- Improved traction on slopes
- Ability to work on wet ground



LOWER PRESSURE

- Operates at up to 1 bar lower pressure⁽³⁾ compared to the previous generation



STEEL REINFORCED TREAD

- Great stability
- Excellent puncture resistance and better load distribution.

(1) Study led by Harper Adams University, Newport, United Kingdom - from 2014 to 2016

(2) VF / IF versus NF thanks to ETRTO norms

SIZES

VF 520/80R26 CFO 168A8 TL

VF 620/70R26 CFO 173A8 TL

VF 750/65R26 CFO 177A8 TL

VF 520/85R30 CFO 172A8 TL

VF 620/70R30 CFO 172A8 TL

IF 1000/55R32 CFO 188A8 TL

IF 680/85R32 CFO 179A8 TL

IF 800/65R32 CFO 178A8 TL

IF 800/70R32 CFO 182A8 TL

IF 900/60R32 CFO 185A8 TL

IF 680/75R38 CFO 180A8 TL

IF 800/70R38 CFO 184A8 TL

IF 900/60R38 CFO 184A8 TL

IF 710/70R42 CFO 182A8 TL

VF 520/85R42 CFO 177A8 TL

MICHELIN CEREXBIB

Tire specifications and pressure table (bar & psi). Load per tire in kg*

Ø inches	Description	CAI	e mm	D mm	R' mm	RC mm	Recommended Rim	Acceptable Rim	Tube (Code)	75% internal volume (litres)	Tread depth (mm)				
26	VF 520/80R26 CFO 168A8 TL	972024	503	1491	649	4397	DW16L	DW18L W16L	716	366	44				
Bar	1.2	1.4	1.6	1.7	1.8	1.9	2	2.1	2.2	2.3	2.4	2.5	2.6	2.7	2.8
Psi	17	20	23	25	26	28	29	30	32	33	35	36	38	39	41
15 km/h Cyc	4720	5270	5820	5950	6080	6205	6335	6465	6595	6720	6850	7000	7150	7300	7450
40 km/h	3550	3965	4375	4470	4570	4665	4765	4860	4955	5055	5150	5265	5375	5490	5600

Ø inches	Description	CAI	e mm	D mm	R' mm	RC mm	Recommended Rim	Acceptable Rim	Tube (Code)	75% internal volume (litres)	Tread depth (mm)				
26	VF 620/70R26 CFO 173A8 TL	656967	606	1513	655	4458	DW20B (A)		716	463	45				
Bar	1.2	1.4	1.6	1.7	1.8	1.9	2	2.1	2.2	2.3	2.4	2.5	2.6	2.7	2.8
Psi	17	20	23	25	26	28	29	30	32	33	35	36	38	39	41
15 km/h Cyc	5485	6170	6850	6990	7135	7275	7415	7555	7700	7840	7980	8150	8315	8485	8650
40 km/h	4125	4640	5150	5255	5365	5470	5575	5680	5790	5895	6000	6125	6250	6375	6500

Ø inches	Description	CAI	e mm	D mm	R' mm	RC mm	Recommended Rim	Acceptable Rim	Tube (Code)	75% internal volume (litres)	Tread depth (mm)
26	VF 750/65R26 CFO 177A8 TL	811382	743	1623	701	4780	DW25B (A)		833	659	48
Bar	1.2	1.4	1.6	1.7	1.8	1.9	2	2.1	2.2	2.3	2.4
Psi	17	20	23	25	26	28	29	30	32	33	35
15 km/h Cyc	6850	7515	8180	8370	8565	8755	8945	9135	9330	9520	9710
40 km/h	5150	5650	6150	6295	6440	6580	6725	6870	7015	7155	7300

Ø inches	Description	CAI	e mm	D mm	R' mm	RC mm	Recommended Rim	Acceptable Rim	Tube (Code)	75% internal volume (litres)	Tread depth (mm)
30	VF 620/70R30 CFO 172A8 TL	886789	598	1615	700	4760	DW20B (A)		737	506	43
Bar	1.2	1.4	1.6	1.7	1.8	1.9	2	2.1	2.2	2.3	2.4
Psi	17	20	23	25	26	28	29	30	32	33	35
15 km/h Cyc	5985	6620	7250	7390	7535	7675	7815	7955	8100	8240	8380
40 km/h	4500	4975	5450	5555	5665	5770	5875	5980	6090	6195	6300

* Refer to the notes at the end of the tables of this range

MICHELIN CEREXBIB

Tire specifications and pressure table (bar & psi). Load per tire in kg*

Ø inches	Description	CAI	e mm	D mm	R' mm	RC mm	Recommended Rim		Acceptable Rim		Tube (Code)	75% internal volume (litres)	Tread depth (mm)		
30	VF 520/85R30 CFO 172A8 TL	795916	522	1624	709	4794	W16L				737	435	46		
Bar	1.2	1.4	1.6	1.7	1.8	1.9	2	2.1	2.2	2.3	2.4	2.5	2.6	2.7	2.8
Psi	17	20	23	25	26	28	29	30	32	33	35	36	38	39	41
15 km/h Cyc	5320	5905	6485	6640	6795	6945	7100	7255	7410	7560	7715	7880	8050	8215	8380
40 km/h	4000	4440	4875	4990	5105	5220	5340	5455	5570	5685	5800	5925	6050	6175	6300

Ø inches	Description	CAI	e mm	D mm	R' mm	RC mm	Recommended Rim		Acceptable Rim		Tube (Code)	75% internal volume (litres)	Tread depth (mm)		
32	IF 800/65R32 CFO 178A8/178B TL	651074	768	1855	818	5493	DW27B (A)		DW30B (A)		831	903	57		
Bar	1.2	1.4	1.6	1.7	1.8	1.9	2	2.1	2.2	2.3	2.4				
Psi	17	20	23	25	26	28	29	30	32	33	35				
15 km/h Cyc	8215	8990	9765	10000	10230	10465	10695	10930	11160	11395	11625				
40 km/h	5300	5800	6300	6450	6600	6750	6900	7050	7200	7350	7500				

Ø inches	Description	CAI	e mm	D mm	R' mm	RC mm	Recommended Rim		Acceptable Rim		Tube (Code)	75% internal volume (litres)	Tread depth (mm)		
32	IF 900/60R32 CFO 185A8 TL	752825	856	1906	844	5643	DW27B (A)		DW30B (A)		831	1033	58		
Bar	1.2	1.4	1.6	1.7	1.8	1.9	2	2.1	2.2	2.3	2.4	2.5	2.6	2.7	2.8
Psi	17	20	23	25	26	28	29	30	32	33	35	36	38	39	41
15 km/h Cyc	8990	9995	11000	11270	11545	11815	12090	12360	12630	12905	13175	13465	13760	14050	14340
40 km/h	5800	6450	7100	7275	7450	7625	7800	7975	8150	8325	8500	8690	8875	9065	9250

Ø inches	Description	CAI	e mm	D mm	R' mm	RC mm	Recommended Rim		Acceptable Rim		Tube (Code)	75% internal volume (litres)	Tread depth (mm)		
32	IF 1000/55R32 CFO 188A8 TL	131720	1,040	1931	882	5758	36.00VA				Joint OR2052	1178	59		
Bar	1.2	1.4	1.6	1.7	1.8	1.9	2	2.1	2.2	2.3	2.4	2.5	2.6	2.7	2.8
Psi	17	20	23	25	26	28	29	30	32	33	35	36	38	39	41
15 km/h Cyc	9765	10890	12015	12305	12595	12885	13180	13470	13760	14050	14340	14630	14920	15210	15500
40 km/h	6300	7025	7750	7940	8125	8315	8500	8690	8875	9065	9250	9440	9625	9815	10000

* Refer to the notes at the end of the tables of this range

MICHELIN CEREXBIB

Tire specifications and pressure table (bar & psi). Load per tire in kg*

Ø inches	Description	CAI	e mm	D mm	R' mm	RC mm	Recommended Rim	Acceptable Rim	Tube (Code)	75% internal volume (litres)	Tread depth (mm)
32	IF 680/85R32 CFO 179A8/179B TL	932041	682	1935	844	5711	DW23B (A)	DW21B (A)	831	859	46
Bar	1.2 1.4 1.6	1.7 1.8 1.9	2 2.1 2.2	2.3 2.4							
Psi	17 20 23	25 26 28	29 30 32	33 35							
15 km/h Cyc	8450 9420 10385	10590 10795 10995	11200 11405 11610	11810 12015							
40 km/h	5450 6075 6700	6830 6965 7095	7225 7355 7490	7620 7750							

Ø inches	Description	CAI	e mm	D mm	R' mm	RC mm	Recommended Rim	Acceptable Rim	Tube (Code)	75% internal volume (litres)	Tread depth (mm)
32	IF 800/70R32 CFO 182A8/182B TL	525718	784	1958	864	5788	DW27B (A)		831	966	55
Bar	1.2 1.4 1.6	1.7 1.8 1.9	2 2.1 2.2	2.3 2.4							
Psi	17 20 23	25 26 28	29 30 32	33 35							
15 km/h Cyc	8990 10000 11005	11275 11550 11820	12090 12360 12635	12905 13175							
40 km/h	5800 6450 7100	7275 7450 7625	7800 7975 8150	8325 8500							

Ø inches	Description	CAI	e mm	D mm	R' mm	RC mm	Recommended Rim	Acceptable Rim	Tube (Code)	75% internal volume (litres)	Tread depth (mm)
38	IF 800/75R38 CFO 180A8 TL	833220	663	1965	874	5823	DW23B (A)	DW21B (A)	804	803	59
Bar	1.2 1.4 1.6	1.7 1.8 1.9	2 2.1 2.2	2.3 2.4	2.5 2.6 2.7 2.8						
Psi	17 20 23	25 26 28	29 30 32	33 35	36 38 39 41						
15 km/h Cyc	7980 8875 9765	10000 10230 10465	10695 10930 11160	11395 11625 11820	12015 12205 12400						
15 km/h Cyc > slope 20%		7980 8425 8875	9320 9765 10000	10230 10465 10695	10930 11160 11395						
40 km/h	5150 5725 6300	6450 6600 6750	6900 7050 7200	7350 7500 7625	7750 7875 8000						

Ø inches	Description	CAI	e mm	D mm	R' mm	RC mm	Recommended Rim	Acceptable Rim	Tube (Code)	75% internal volume (litres)	Tread depth (mm)
38	IF 900/60R38 CFO 184A8 TL	296920	874	2033	904	6017	DW30B (A)			1149	58
Bar	1.2 1.4 1.6	1.7 1.8 1.9	2 2.1 2.2	2.3 2.4							
Psi	17 20 23	25 26 28	29 30 32	33 35							
15 km/h Cyc	9765 10885 12000	12245 12490 12730	12975 13220 13465	13705 13950							
40 km/h	6300 7025 7750	7905 8065 8220	8375 8530 8690	8845 9000							

* Refer to the notes at the end of the tables of this range

MICHELIN CEREXBIB

Tire specifications and pressure table (bar & psi). Load per tire in kg*

Ø inches	Description	CAI	e mm	D mm	R' mm	RC mm	Recommended Rim	Acceptable Rim	Tube (Code)	75% internal volume (litres)	Tread depth (mm)
38	IF 800/70R38 CFO 184A8/184B TL	646846	781	2048	908	6072	DW27B (A)		804	1088	57
Bar	1.2 1.4 1.6	1.7 1.8 1.9	2 2.1 2.2	2.3 2.4							
Psi	17 20 23	25 26 28	29 30 32	33 35							
15 km/h Cyc	9765	10885	12000	12245	12490	12730	12975	13220	13465	13705	13950
40 km/h	6300	7025	7750	7905	8065	8220	8375	8530	8690	8845	9000

Ø inches	Description	CAI	e mm	D mm	R' mm	RC mm	Recommended Rim	Acceptable Rim	Tube (Code)	75% internal volume (litres)	Tread depth (mm)				
42	VF 520/85R42 CFO 177A8 TL	934265	541	1953	881	5807	DW18B(A)	DD18 DW18L	802	545	55				
Bar	1.2 1.4 1.6	1.7 1.8 1.9	2 2.1 2.2	2.3 2.4 2.5	2.6 2.7 2.8										
Psi	17 20 23	25 26 28	29 30 32	33 35 36	38 39 41										
15 km/h Cyc Dual	5455	5865	6275	6480	6685	6885	7090	7295	7500	7705	7910	8080	8255	8425	8595
40 km/h	4625	4970	5315	5490	5665	5835	6010	6180	6355	6525	6700	6850	7000	7150	7300

Ø inches	Description	CAI	e mm	D mm	R' mm	RC mm	Recommended Rim	Acceptable Rim	Tube (Code)	75% internal volume (litres)	Tread depth (mm)			
42	IF 710/70R42 CFO 182A8 TL	003912	705	2097	942	6230	DW23B (A)		802	872	64			
Bar	1.4 1.6 1.7	1.8 1.9 1.9	2 2.1 2.1	2.2 2.3 2.4	2.5 2.6 2.7	2.8								
Psi	20 23 25	26 28 29	30 32 33	35 36 38	39 41									
15 km/h Cyc	9300	10385	10590	10790	10995	11200	11400	11605	11805	12010	12300	12595	12885	13175
40 km/h	6000	6700	6830	6965	7095	7225	7355	7490	7620	7750	7940	8125	8315	8500

***IMPORTANT:**

The inflation pressure must always be appropriate for the load per tire, the speed of travel and the work to be done. Our recommendations above are provided subject to changes made after the date of publication of these tables. Technical data is subject to change without prior notice.

- For standard or slope correction machines working on slopes of over 20° (11°), increase the usage pressure by 0.4 bar without exceeding the maximum load.
- For intensive road use (>50%) add 0.4 bar.
- 15 km/h Cyc: Harvesting work with cyclic loads at 15 km/h.
- CFO: Cyclic Field Operation generating a bonus for cyclic loads in the field (1,5 km maximum distance fully loaded).



MICHELIN MEGAXBIB 2

EXCELLENT VALUE
FOR HARVESTERS



FOR FLOATERS OR HARVESTERS



ROBUST AND RESISTANT TO STUBBLE

- Reinforced casing
- Long tire life



MEGAXBIB RANGE BENEFITS

- Excellent road handling
- High load/speed capacities



NEW MARKING

- Stubble Shield



STEEL REINFORCED TREAD

- Great stability
- Excellent puncture resistance and improved load distribution.

SIZES

1000/50R25 172A8/166D TL

750/50R26 160A8/154D TL

1050/50R32 178A8/172D TL

650/75R32 172A8/172B TL

800/65R32 178A8/178B TL

800/70R32 181A8/181B TL

900/60R32 181A8/181B TL

710/75R34 178A8/178B TL

620/70R38 170A8/170B TL

MICHELIN MEGAXBIB 2

Tire specifications and pressure table (bar & psi). Load per tire in kg*

Ø inches	Description	CAI	e mm	D mm	R' mm	RC mm	Recommended Rim	Acceptable Rim	Tube (Code)	75% internal volume (litres)	Tread depth (mm)
25	1000/50R25 172A8/166D TL <i>For spreaders/floaters</i>	852423	1033	1654	732	4907	36.0TH		Joint R1438	892	46
Bar	1 1.3 1.6 1.9 2.2 2.3 2.4 2.5 2.6 2.7 2.8										
Psi	15 19 23 28 32 33 35 36 38 39 41										
10 km/h Cyc		8290	9005	9725	9960	10200	10330	10455	10585	10710	
30 km/h Cyc		6565	7480	8390	8695	9000	9115	9225	9340	9450	
10 km/h	5815 6940	7740	8385	9025	9235	9450					
30 km/h	4145 4950	5670	6070	6475	6605	6740					
40 km/h	3875 4625	5300	5675	6050	6175	6300					
65 km/h	3255 3885	4450	4765	5080	5185	5290					

Ø inches	Description	CAI	e mm	D mm	R' mm	RC mm	Recommended Rim	Acceptable Rim	Tube (Code)	75% internal volume (litres)	Tread depth (mm)	
26	750/50R26 160A8/154D TL <i>For spreaders/floaters</i>	236906	742	1406	629	4171	DW25B (A)			466	39	
Bar	1 1.3 1.6 1.9 2.2 2.3 2.4 2.5 2.6 2.7 2.8 2.9 3.2											
Psi	15 19 23 28 32 33 35 36 38 39 41 42 46											
10 km/h Cyc		5230	5660	6090	6230	6375	6535	6695	6855	7015	7170	7650
30 km/h Cyc		4200	4735	5270	5445	5625	5765	5910	6050	6190	6330	6750
10 km/h	3750 4400	5175	5555	5935	6065	6190	6330	6470	6610	6750		
30 km/h	2675 3135	3690	3960	4235	4325	4415	4515	4615	4715	4815		
40 km/h	2500 2930	3450	3705	3955	4040	4125	4220	4310	4405	4500		
65 km/h	2100 2465	2900	3110	3325	3395	3465	3545	3620	3700	3780		

Ø inches	Description	CAI	e mm	D mm	R' mm	RC mm	Recommended Rim	Acceptable Rim	Tube (Code)	75% internal volume (litres)	Tread depth (mm)			
32	650/75R32 172A8/172B TL	642277	638	1817	817	5397	DW21B (A)	DW20B (A) DW23B (A)	831	647	56			
Bar	1 1.3 1.6 1.9 2.2 2.3 2.4 2.5 2.6 2.7 2.8 2.9 3.2 3.5 3.8													
Psi	15 19 23 28 32 33 35 36 38 39 41 42 46 51 55													
10 km/h Cyc	4900 5710	6520	7090	7665	7855	8045	8235	8425	8615	8805	8995	9565	10140	10710
10 km/h	4500 5220	5940	6420	6895	7055	7215	7375	7535	7695	7855	8015	8495	8970	9450
25 km/h	3630 4235	4840	5245	5645	5780	5915	6050	6185	6320	6455	6590	6990		
30 km/h	3500 4085	4670	5060	5445	5575	5705	5835	5965	6095	6225	6355	6740		
40 km/h	3280 3820	4360	4725	5090	5210	5330	5450	5575	5695	5815	5935	6300		
50 km/h	3280 3820	4360	4725	5090	5210	5330	5450	5575	5695	5815	5935	6300		

* Refer to the notes at the end of the tables of this range

MICHELIN MEGAXBIB 2

Tire specifications and pressure table (bar & psi). Load per tire in kg*

Ø inches	Description	CAI	e mm	D mm	R' mm	RC mm	Recommended Rim		Acceptable Rim	Tube (Code)	75% internal volume (litres)			Tread depth (mm)
32	800/65R32 178A8/178B TL	135425	786	1839	832	5471	DW27B (A)		DH27(B) DW25B (A)	831	871	56		
Bar	1 1.3 1.6	1.9 2.2 2.3	2.4 2.5 2.6	2.7 2.8	2.9 3.2 3.5	3.8					3.8			
Psi	15 19 23	28 32 33	35 36 38	39 41 42	46 51 55	56								
10 km/h Cyc	5865 7080 8290	8880 9470 9665	9860 10075 10285	10500 10710 10915	11525 12140 12750									
10 km/h	5175 6060 6940	7600 8260 8480	8700 8890 9075	9265 9450 9630	10170 10710 11250									
25 km/h	4440 5165 5885	6300 6720 6855	6995 7160 7330	7495 7660 7825	8325									
30 km/h	4280 4975 5670	6070 6475 6605	6740 6900 7065	7225 7385 7545	8025									
40 km/h	4000 4650 5300	5675 6050 6175	6300 6450 6600	6750 6900 7050	7500									
50 km/h	4000 4650 5300	5675 6050 6175	6300 6450 6600	6750 6900 7050	7500									

Ø inches	Description	CAI	e mm	D mm	R' mm	RC mm	Recommended Rim		Acceptable Rim	Tube (Code)	75% internal volume (litres)			Tread depth (mm)
32	1050/50R32 178A8/172D TL <i>For spreaders/floater</i>	424273	1037	1866	828	5537	36.00VA			Joint OR2052	1233	42		
Bar	1 1.3 1.6	1.9 2.2 2.3	2.4 2.5 2.6	2.7 2.8	2.9 3.2 3.5	3.8								
Psi	15 19 23	28 32 33	35 36 38	39 41 42	46 51 55	56								
10 km/h Cyc		9860 10690 11520	11795 12070 12240	12410 12580 12750										
30 km/h Cyc		7725 8820 9920	10285 10650 10800	10950 11100 11250										
10 km/h	6940 8260 9450	10125 10800 11025	11250											
30 km/h	4950 5890 6740	7220 7705 7865	8025											
40 km/h	4625 5505 6300	6750 7200 7350	7500											
65 km/h	3885 4625 5290	5670 6050 6175	6300											

Ø inches	Description	CAI	e mm	D mm	R' mm	RC mm	Recommended Rim		Acceptable Rim	Tube (Code)	75% internal volume (litres)			Tread depth (mm)
32	900/60R32 181A8/181B TL	166896	862	1899	848	5635	DW27B (A)		DW30B (A)	831	1033	57		
Bar	1 1.3 1.6	1.9 2.2 2.3	2.4 2.5 2.6	2.7 2.8	2.9 3.2 3.5	3.8								
Psi	15 19 23	28 32 33	35 36 38	39 41 42	46 51 55	56								
10 km/h Cyc	6375 7695 9010	9775 10540 10795	11050 11305 11560	11815 12070 12265	12850 13440 14025									
10 km/h	5625 6675 7725	8485 9245 9495	9750 9975 10200	10425 10650 10825	11340 11860 12375									
25 km/h	4720 5580 6440	6980 7520 7700	7880 8060 8245	8425 8605 8745	9160									
30 km/h	4550 5380 6205	6725 7250 7420	7595 7770 7945	8120 8295 8430	8830									
40 km/h	4250 5025 5800	6290 6775 6940	7100 7265 7425	7590 7750 7875	8250									
50 km/h	4250 5025 5800	6290 6775 6940	7100 7265 7425	7590 7750 7875	8250									

* Refer to the notes at the end of the tables of this range

MICHELIN MEGAXBIB 2

Tire specifications and pressure table (bar & psi). Load per tire in kg*

Ø inches	Description	CAI	e mm	D mm	R' mm	RC mm	Recommended Rim		Acceptable Rim	Tube (Code)	75% internal volume (litres)	Tread depth (mm)
32	800/70R32 181A8/181B TL	366785	805	1938	893	5760	DW27B (A)		DW25B (A)	831	966	56
Bar	1 1.3 1.6	1.9 2.2 2.3	2.4 2.5 2.6	2.7 2.8	2.9 3.2 3.5	3.8						3.8
Psi	15 19 23	28 32 33	35 36 38	39 41 42	46 51 55							55
10 km/h Cyc	6375 7820 9265	9965 10625 10840	11050 11220 11390	11560 11730 11960	12650 13335 14025							
10 km/h	5625 6675 7725	8830 9475 9615	9750 9900 10050	10200 10350 10555	11160 11770 12375							
20 km/h	5335 6360 7380	7795 8210 8345	8485 8695 8900	9110 9320 9525	10150							
25 km/h	4815 5740 6660	7035 7410 7535	7660 7850 8035	8225 8410 8600	9160							
30 km/h	4680 5550 6420	6780 7140 7260	7380 7560 7745	7925 8105 8285	8830							
40 km/h	4375 5190 6000	6340 6675 6790	6900 7070 7240	7405 7575 7745	8250							
50 km/h	4375 5190 6000	6340 6675 6790	6900 7070 7240	7405 7575 7745	8250							

Ø inches	Description	CAI	e mm	D mm	R' mm	RC mm	Recommended Rim		Acceptable Rim	Tube (Code)	75% internal volume (litres)	Tread depth (mm)
34	710/75R34 178A8/178B TL	312036	697	1909	857	5671	DW23B (A)		DW21B (A) MW23B (A)	765	863	56
Bar	1 1.3 1.6	1.9 2.2 2.3	2.4 2.5 2.6	2.7 2.8	2.9 3.2 3.5	3.8						3.8
Psi	15 19 23	28 32 33	35 36 38	39 41 42	46 51 55							55
10 km/h Cyc	6260 6955 7650	8345 9040 9275	9505 9735 9970	10200 10430 10665	11360 12055 12750							
10 km/h	5700 6295 6890	7485 8080 8275	8475 8675 8870	9070 9270 9465	10060 10655 11250							
25 km/h	4650 5150 5655	6155 6655 6825	6990 7160 7325	7495 7660 7830	8330							
30 km/h	4480 4965 5450	5930 6415 6580	6740 6900 7060	7225 7385 7545	8030							
40 km/h	4190 4640 5095	5545 5995 6145	6295 6445 6595	6750 6900 7050	7500							
50 km/h	4190 4640 5095	5545 5995 6145	6295 6445 6595	6750 6900 7050	7500							

Ø inches	Description	CAI	e mm	D mm	R' mm	RC mm	Recommended Rim		Acceptable Rim	Tube (Code)	75% internal volume (litres)	Tread depth (mm)
38	620/70R38 170A8/170B TL	126128	605	1866	853	5565	DW20B (A)		DW18L	825	592	56
Bar	1 1.3 1.6	1.9 2.2 2.3	2.4 2.5 2.6	2.7 2.8	2.9 3.2 3.5	3.8						3.8
Psi	15 19 23	28 32 33	35 36 38	39 41 42	46 51 55							55
10 km/h Cyc	5010 5565 6120	6680 7235 7420	7605 7790 7975	8160 8345 8530	9090 9645 10200							
10 km/h	4560 5035 5510	5985 6465 6620	6780 6940 7095	7255 7415 7575	8050 8525 9000							
25 km/h	3710 4110 4515	4915 5320 5455	5585 5720 5855	5990 6125 6260	6660							
30 km/h	3580 3965 4355	4740 5130 5260	5385 5515 5645	5775 5905 6035	6420							
40 km/h	3350 3710 4075	4435 4795 4915	5035 5155 5275	5400 5520 5640	6000							
50 km/h	3350 3710 4075	4435 4795 4915	5035 5155 5275	5400 5520 5640	6000							

***IMPORTANT:**

The inflation pressure must always be appropriate for the load per tire, the speed of travel and the work to be done. Our recommendations above are provided subject to changes made after the date of publication of these tables. Technical data is subject to change without prior notice.

- For machines working cyclically on slopes of over 20% (11°), use the non-cyclic table.
- For machines non-cyclically working on slopes of over 20% (11°), add 0.4 bars.
- For intense road use exceeding 50% of time on road, add 0.4 bars.
- Maximum load may not be carried for more than 1.5 km before unloading operations begins.



MICHELIN MEGAXBIB

**EXCELLENT VALUE
FOR HARVESTERS
& HEAVY EQUIPMENT**



FOR HARVESTING MACHINES



LOAD CAPACITY

- Up to 30 600 kg⁽¹⁾ per axle



ENDURANCE

- Up to +46%⁽²⁾ vs main competitor



COMFORT



STEEL REINFORCED TREAD

- Great stability
- Excellent puncture resistance and better load distribution.

(1) 1050/50 R32 184A8/184B - 10 km/h Cyc (2) Internal test (Ladoux - France) study on 800/65R32 178A8/178B

SIZES

620/75R26 166A8/166B TL

750/50R26 160A8/154D TL

750/65R26 171A8/171B TL

620/75R30 168A8/168B TL

1050/50R32 178A8 TL

1050/50R32 184A8/184B TL

650/75R32 172A8/172B TL

800/65R32 178A8/178B TL

800/70R32 181A8/181B TL

900/60R32 181A8/181B TL

620/75R34 170A8/170B TL

710/75R34 178A8/178B TL

620/70R38 170A8/170B TL

650/85R38 173A8/173B TL

520/85R42 162A8/162B TL

620/70R42 166A8/166B TL

MICHELIN MEGAXBIB

Tire specifications and pressure table (bar & psi). Load per tire in kg*

Ø inches	Description	CAI	e mm	D mm	R' mm	RC mm	Recommended Rim		Acceptable Rim		Tube (Code)	75% internal volume (litres)	Tread depth (mm)
26	750/50R26 160A8/154D TL	478428	738	1404	625	4162	DW25B (A)					458	37
Bar	1	1.3	1.6	1.9	2.2	2.3	2.4	2.5	2.6	2.7	2.8	2.9	3.2
Psi	15	19	23	28	32	33	35	36	38	39	41	42	46
10 km/h Cyc		5230	5660	6090	6230	6375	6535	6695	6855	7015	7170	7650	
30 km/h Cyc		4200	4735	5270	5445	5625	5765	5910	6050	6190	6330	6750	
10 km/h	3750	4395	5175	5555	5935	6065	6190	6330	6470	6610	6750		
30 km/h	2675	3135	3690	3960	4235	4325	4415	4515	4615	4715	4815		
40 km/h	2500	2930	3450	3705	3955	4040	4125	4220	4315	4405	4500		
65 km/h	2100	2465	2900	3110	3325	3395	3465	3545	3625	3700	3780		

Ø inches	Description	CAI	e mm	D mm	R' mm	RC mm	Recommended Rim		Acceptable Rim		Tube (Code)	75% internal volume (litres)	Tread depth (mm)		
26	620/75R26 166A8/166B TL	614320	588	1602	712	4748	DW20B (A)		DW18L		830	516	46		
Bar	1	1.3	1.6	1.9	2.2	2.3	2.4	2.5	2.6	2.7	2.8	2.9	3.2	3.5	3.8
Psi	15	19	23	28	32	33	35	36	38	39	41	42	46	51	55
10 km/h Cyc	4410	4820	5230	5745	6260	6435	6605	6775	6950	7120	7290	7465	7980	8495	9010
10 km/h	3910	4405	4900	5315	5730	5870	6010	6150	6285	6425	6565	6700	7120	7535	7950
25 km/h	3170	3610	4050	4395	4735	4850	4965	5080	5195	5310	5425	5535	5880		
30 km/h	3060	3480	3900	4230	4565	4675	4785	4895	5005	5115	5230	5340	5670		
40 km/h	2860	3250	3640	3950	4265	4365	4470	4575	4680	4780	4885	4990	5300		
50 km/h	2860	3250	3640	3950	4265	4365	4470	4575	4680	4780	4885	4990	5300		

Ø inches	Description	CAI	e mm	D mm	R' mm	RC mm	Recommended Rim		Acceptable Rim		Tube (Code)	75% internal volume (litres)	Tread depth (mm)		
26	750/65R26 171A8/171B TL	983217	732	1621	730	4818	DW25B (A)				833	677	46		
Bar	1	1.3	1.6	1.9	2.2	2.3	2.4	2.5	2.6	2.7	2.8	2.9	3.2	3.5	3.8
Psi	15	19	23	28	32	33	35	36	38	39	41	42	46	51	55
10 km/h Cyc	4930	5865	6675	7360	7920	8100	8285	8470	8650	8815	8975	9140	9590	10020	10455
10 km/h	4350	5080	5760	6380	6940	7110	7285	7460	7630	7775	7920	8060	8460	8845	9225
25 km/h	3610	4175	4735	5240	5630	5765	5895	6030	6160	6270	6380	6495	6825		
30 km/h	3480	4025	4570	5055	5420	5550	5680	5810	5940	6045	6155	6260	6580		
40 km/h	3250	3760	4265	4720	5070	5190	5310	5430	5550	5650	5750	5850	6150		
50 km/h	3250	3760	4265	4720	5070	5190	5310	5430	5550	5650	5750	5850	6150		

* Refer to the notes at the end of the tables of this range

MICHELIN MEGAXBIB

Tire specifications and pressure table (bar & psi). Load per tire in kg*

Ø inches	Description	CAI	e mm	D mm	R' mm	RC mm	Recommended Rim		Acceptable Rim		Tube (Code)	75% internal volume (litres)	Tread depth (mm)
30	620/75R30 168A8/1688 TL	753673	604	1710	770	5083	DW20B (A)		DW18L		737	559	46
Bar	1 1.3 1.6	1.9 2.2 2.3	2.4 2.5 2.6	2.7 2.8	2.9 3.2 3.5	3.8							3.8
Psi	15 19 23	28 32 33	35 36 38	39 41	42 46 51	55							
10 km/h Cyc	4660 5090 5520	6065 6610 6795	6975 7155 7340	7520 7700	7885 8430 8975	9520							
10 km/h	4130 4650 5170	5610 6050 6200	6345 6490 6640	6785 6930	7080 7520 7960	8400							
25 km/h	3360 3815 4270	4635 5000 5120	5240 5360 5485	5605 5725	5845 6210								
30 km/h	3240 3680 4120	4470 4820 4940	5055 5170 5290	5405 5525	5640 5990								
40 km/h	3030 3440 3850	4180 4505 4615	4725 4835 4945	5055 5165	5270 5600								
50 km/h	3030 3440 3850	4180 4505 4615	4725 4835 4945	5055 5165	5270 5600								

Ø inches	Description	CAI	e mm	D mm	R' mm	RC mm	Recommended Rim		Acceptable Rim		Tube (Code)	75% internal volume (litres)	Tread depth (mm)
32	650/75R32 172A8/1728 TL	468227	657	1825	821	5423	DW21B (A)		DW20B (A) DW23B (A)		831	698	59
Bar	1 1.3 1.6	1.9 2.2 2.3	2.4 2.5 2.6	2.7 2.8	2.9 3.2 3.5	3.8							3.8
Psi	15 19 23	28 32 33	35 36 38	39 41	42 46 51	55							
10 km/h Cyc	4900 5710 6520	7090 7665 7855	8045 8235 8425	8615 8805	8995 9565 10140	10710							
10 km/h	4500 5220 5940	6420 6895 7055	7215 7375 7535	7695 7855	8015 8495 8970	9450							
25 km/h	3630 4235 4840	5245 5645 5780	5915 6050 6185	6320 6455	6585 6990								
30 km/h	3500 4085 4670	5060 5445 5575	5705 5835 5965	6095 6225	6350 6740								
40 km/h	3280 3820 4360	4725 5090 5210	5330 5450 5575	5695 5815	5935 6300								
50 km/h	3280 3820 4360	4725 5090 5210	5330 5450 5575	5695 5815	5935 6300								

Ø inches	Description	CAI	e mm	D mm	R' mm	RC mm	Recommended Rim		Acceptable Rim		Tube (Code)	75% internal volume (litres)	Tread depth (mm)
32	800/65R32 178A8/1788 TL	521809	793	1840	822	5459	DW27B (A)		DHB27 DW25B (A)		831	903	56
Bar	1 1.3 1.6	1.9 2.2 2.3	2.4 2.5 2.6	2.7 2.8	2.9 3.2 3.5	3.8							3.8
Psi	15 19 23	28 32 33	35 36 38	39 41	42 46 51	55							
10 km/h Cyc	5865 7080 8290	8880 9470 9665	9860 10075 10285	10500 10710	10915 11525 12140	12750							
10 km/h	5175 6060 6940	7600 8260 8480	8700 8890 9075	9265 9450	9630 10170 10710	11250							
25 km/h	4440 5165 5885	6300 6720 6855	6995 7160 7330	7495 7660	7825 8325								
30 km/h	4280 4975 5670	6070 6475 6605	6740 6900 7065	7225 7385	7545 8025								
40 km/h	4000 4650 5300	5675 6050 6175	6300 6450 6600	6750 6900	7050 7500								
50 km/h	4000 4650 5300	5675 6050 6175	6300 6450 6600	6750 6900	7050 7500								

* Refer to the notes at the end of the tables of this range

MICHELIN MEGAXBIB

Tire specifications and pressure table (bar & psi). Load per tire in kg*

Ø inches	Description	CAI	e mm	D mm	R' mm	RC mm	Recommended Rim		Acceptable Rim		Tube (Code)	75% internal volume (litres)	Tread depth (mm)
32	1050/50R32 184A8/184B TL <i>Tire for spreaders/floater</i>	829536	1040	1856	831	5510	36.00VA				Joint OR2052	1159	41
Bar	1 1.3 1.6 1.9 2.2 2.3 2.4 2.5 2.6 2.7 2.8 2.9 3.2 3.5 3.8												
Psi	15 19 23 28 32 33 35 36 38 39 41 42 46 51 55												
10 km/h Cyc	6800 8330 9860 10710 11475 11730 11985 12240 12495 12750 13005 13260 14025 14665 15300												
30 km/h Cyc	6240 7370 8500 9045 9695 9910 10125 10380 10630 10885 11140 11390 12150 12825 13500												
25 km/h	5135 6065 6995 7495 7995 8160 8325 8535 8745 8950 9160 9370 9990												
30 km/h	4950 5845 6740 7220 7705 7865 8025 8225 8430 8630 8830 9030 9630												
40 km/h	4625 5465 6300 6750 7200 7350 7500 7690 7875 8065 8250 8440 9000												
50 km/h	4625 5465 6300 6750 7200 7350 7500 7690 7875 8065 8250 8440 9000												

Ø inches	Description	CAI	e mm	D mm	R' mm	RC mm	Recommended Rim		Acceptable Rim		Tube (Code)	75% internal volume (litres)	Tread depth (mm)
32	900/60R32 181A8/181B TL	824122	868	1894	850	5626	DW27B (A)		DW30B (A)		831	1033	56
Bar	1 1.3 1.6 1.9 2.2 2.3 2.4 2.5 2.6 2.7 2.8 2.9 3.2 3.5 3.8												
Psi	15 19 23 28 32 33 35 36 38 39 41 42 46 51 55												
10 km/h Cyc	6375 7695 9010 9775 10540 10795 11050 11305 11560 11815 12070 12265 12850 13440 14025												
10 km/h	5625 6675 7725 8485 9245 9495 9750 9975 10200 10425 10650 10825 11340 11860 12375												
25 km/h	4720 5580 6440 6980 7520 7700 7880 8060 8245 8425 8605 8745 9160												
30 km/h	4550 5380 6205 6725 7250 7420 7595 7770 7945 8120 8295 8430 8830												
50 km/h	4250 5025 5800 6290 6775 6940 7100 7265 7425 7590 7750 7875 8250												

Ø inches	Description	CAI	e mm	D mm	R' mm	RC mm	Recommended Rim		Acceptable Rim		Tube (Code)	75% internal volume (litres)	Tread depth (mm)
32	1050/50R32 178A8 TL <i>M28</i>	236234	1038	1902	854	5649	36.00VA				Joint OR2052	1250	60
Bar	1 1.3 1.6 1.9 2.2 2.3 2.4 2.5 2.6 2.7 2.8												
Psi	15 19 23 28 32 33 35 36 38 39 41												
10 km/h Cyc	7420 8630 9840 10635 11425 11690 11955 12220 12485 12750												
15 km/h Cyc	5350 6675 8000 9330 10390 10700 11010 11165 11320 11475 11630												
10 km/h	6860 7925 8990 9605 10225 10430 10635 10840 11045 11250												
25 km/h	5570 6505 7440 7775 8110 8220 8330												
30 km/h	5370 6270 7170 7495 7815 7925 8030												
40 km/h	5020 5860 6700 7000 7300 7400 7500												

* Refer to the notes at the end of the tables of this range

MICHELIN MEGAXBIB

Tire specifications and pressure table (bar & psi). Load per tire in kg*

Ø inches	Description	CAI	e mm	D mm	R' mm	RC mm	Recommended Rim		Acceptable Rim		Tube (Code)	75% internal volume (litres)	Tread depth (mm)		
32	800/70R32 181A8/181B TL	695992	793	1936	871	5725	DW27B (A)		DW25B (A)		831	966	58		
Bar	1	1.3	1.6	1.9	2.2	2.3	2.4	2.5	2.6	2.7	2.8	2.9	3.2	3.5	3.8
Psi	15	19	23	28	32	33	35	36	38	39	41	42	46	51	55
10 km/h Cyc	6375	7820	9265	9965	10625	10840	11050	11220	11390	11560	11730	11960	12650	13335	14025
10 km/h	5625	6675	7725	8830	9475	9615	9750	9900	10050	10200	10350	10555	11160	11770	12375
20 km/h	5335	6360	7380	7795	8210	8345	8485	8695	8900	9110	9320	9525	10150		
25 km/h	4815	5740	6660	7035	7410	7535	7660	7850	8035	8225	8410	8600	9160		
30 km/h	4680	5550	6420	6780	7140	7260	7380	7560	7745	7925	8105	8285	8830		
40 km/h	4375	5190	6000	6340	6675	6790	6900	7070	7240	7405	7575	7745	8250		
50 km/h	4375	5190	6000	6340	6675	6790	6900	7070	7240	7405	7575	7745	8250		

Ø inches	Description	CAI	e mm	D mm	R' mm	RC mm	Recommended Rim		Acceptable Rim		Tube (Code)	75% internal volume (litres)	Tread depth (mm)		
34	620/75R34 170A8/170B TL	325025	590	1814	821	5398	DW20B (A)		DW18L			612	46		
Bar	1	1.3	1.6	1.9	2.2	2.3	2.4	2.5	2.6	2.7	2.8	2.9	3.2	3.5	3.8
Psi	15	19	23	28	32	33	35	36	38	39	41	42	46	51	55
10 km/h Cyc	5010	5565	6120	6680	7235	7420	7605	7790	7975	8160	8345	8530	9090	9645	10200
10 km/h	4560	5035	5510	5985	6465	6620	6780	6940	7095	7255	7415	7575	8050	8525	9000
25 km/h	3710	4110	4515	4915	5320	5455	5585	5720	5855	5990	6125	6260	6660		
30 km/h	3580	3965	4355	4740	5130	5260	5385	5515	5645	5775	5905	6035	6420		
40 km/h	3350	3710	4075	4435	4795	4915	5035	5155	5275	5400	5520	5640	6000		
50 km/h	3350	3710	4075	4435	4795	4915	5035	5155	5275	5400	5520	5640	6000		

Ø inches	Description	CAI	e mm	D mm	R' mm	RC mm	Recommended Rim		Acceptable Rim		Tube (Code)	75% internal volume (litres)	Tread depth (mm)		
34	710/75R34 178A8/178B TL	543107	690	1900	848	5637	DW23B (A)		DW21B (A) MW23B (A)		765	863	58		
Bar	1	1.3	1.6	1.9	2.2	2.3	2.4	2.5	2.6	2.7	2.8	2.9	3.2	3.5	3.8
Psi	15	19	23	28	32	33	35	36	38	39	41	42	46	51	55
10 km/h Cyc	6260	6955	7650	8345	9040	9275	9505	9735	9970	10200	10430	10665	11360	12055	12750
10 km/h	5700	6295	6890	7485	8080	8275	8475	8675	8870	9070	9270	9465	10060	10655	11250
25 km/h	4650	5150	5655	6155	6655	6825	6990	7160	7325	7495	7660	7830	8330		
30 km/h	4480	4965	5450	5930	6415	6580	6740	6900	7060	7225	7385	7545	8030		
40 km/h	4190	4640	5095	5545	5995	6145	6295	6445	6595	6750	6900	7050	7500		
50 km/h	4190	4640	5095	5545	5995	6145	6295	6445	6595	6750	6900	7050	7500		

* Refer to the notes at the end of the tables of this range

MICHELIN MEGAXBIB

Tire specifications and pressure table (bar & psi). Load per tire in kg*

Ø inches	Description	CAI	e mm	D mm	R' mm	RC mm	Recommended Rim		Acceptable Rim	Tube (Code)	75% internal volume (litres)	Tread depth (mm)	
38	620/70R38 170A8/170B TL	476088	608	1864	850	5557	DW20B (A)		DW18L	825	587	55	
Bar	1 1.3 1.6	1.9	2.2	2.3	2.4	2.5	2.6	2.7	2.8	2.9	3.2	3.5	3.8
Psi	15 19 23	28	32	33	35	36	38	39	41	42	46	51	55
10 km/h Cyc	5010 5565 6120		7235	7420	7605	7790	7975	8160	8345	8530	9090	9645	10200
10 km/h	4560 5035 5510	5985	6465	6620	6780	6940	7095	7255	7415	7575	8050	8525	9000
25 km/h	3710 4110 4515	4915	5320	5455	5585	5720	5855	5990	6125	6260	6660		
30 km/h	3580 3965 4355	4740	5130	5260	5385	5515	5645	5775	5905	6035	6420		
40 km/h	3350 3710 4075	4435	4795	4915	5035	5155	5275	5400	5520	5640	6000		
50 km/h	3350 3710 4075	4435	4795	4915	5035	5155	5275	5400	5520	5640	6000		

Ø inches	Description	CAI	e mm	D mm	R' mm	RC mm	Recommended Rim		Acceptable Rim	Tube (Code)	75% internal volume (litres)	Tread depth (mm)
38	650/85R38 173A8/173B TL <i>Textile belted</i>	173491	699	2048	931	6100	DW23B (A)		DW20B (A)	804	857	63
Bar	1 1.3 1.6	1.9	2.2	2.3	2.4	2.5	2.6	2.7	2.8			
Psi	15 19 23	28	32	33	35	36	38	39	41			
10 km/h Cyc Dual	5610 6545 7480	8040	8600	8790	8975	9165	9350	9535	9724			
10 km/h	5815 6660 7500	8065	8625	8815	9000	9190	9375	9565	9750			
25 km/h	4440 5245 6050	6485	6925	7070	7215							
30 km/h	4280 5055 5830	6250	6675	6815	6955							
40 km/h	4000 4725 5450	5845	6240	6370	6500							
50 km/h	4000 4725 5450	5845	6240	6370	6500							

Ø inches	Description	CAI	e mm	D mm	R' mm	RC mm	Recommended Rim		Acceptable Rim	Tube (Code)	75% internal volume (litres)	Tread depth (mm)
42	520/85R42 162A8/162B TL <i>Textile belted</i>	645194	537	1937	889	5783	DW18L		DD18 W18L	802	545	56
Bar	1 1.3 1.6	1.9	2.2	2.3	2.4	2.5	2.6	2.7				
Psi	15 19 23	28	32	33	35	36	38	39				
10 km/h Cyc Dual	3850 4575 5300	6170	6500	6620	6740	6865	6985	7105				
30 km/h Dual	2825 3355 3885	4150	4355	4415	4475							
10 km/h	3990 4900 5810	6395	6830	6975	7070	7170	7265	7360				
25 km/h	3330 3955 4580	4890	5135	5205	5275							
30 km/h	3210 3815 4415	4715	4950	5020	5085							
50 km/h	3000 3565 4125	4405	4625	4690	4750							

* Refer to the notes at the end of the tables of this range

MICHELIN MEGAXBIB

Tire specifications and pressure table (bar & psi). Load per tire in kg*

Ø inches	Description	CAI	e mm	D mm	R' mm	RC mm	Recommended Rim		Acceptable Rim	Tube (Code)	75% internal volume (litres)	Tread depth (mm)
42	620/70R42 166A8/166B TL <i>Textile belted</i>	100268	639	1961	885	5857	DW20B (A)		DW18L MW20B (A)	802	658	56
Bar	1 1.3 1.6	1.9	2.2	2.3	2.4	2.5	2.6	2.7	2.8			
Psi	15 19 23	28	32	33	35	36	38	39	41			
10 km/h Cyc Dual	4080	4875	5670	6465	7030	7180	7330	7480	7630	7780	7930	
10 km/h	4090	4890	5685	6485	7050	7200	7350	7500	7650	7800	7950	
30 km/h Dual	3060	3650	4240	4520	4805	4895	4990					
40 km/h	3250	3875	4500	4800	5100	5200	5300					
50 km/h	3250	3875	4500	4800	5100	5200	5300					

***IMPORTANT:**

The inflation pressure must always be appropriate for the load per tire, the speed of travel and the work to be done. Our recommendations above are provided subject to changes made after the date of publication of these tables. Technical data is subject to change without prior notice.

- For machines working cyclically on slopes of over 20% (11°), use the non-cyclic table.
- For machines non-cyclically working on slopes of over 20% (11°), add 0.4 bars.
- For intense road use exceeding 50% of time on road, add 0.4 bars.
- Maximum load may not be carried for more than 1.5 km before unloading operations begins.



MICHELIN TRAILXBIB

UNCOMPROMISING
LONGEVITY FOR YOUR
TRAILER TIRES



VF MICHELIN ULTRAFLEX TECHNOLOGY

- Low soil compaction
- Optimized yields



OUTSTANDING ENDURANCE

- New VF casing designed for robustness and low pressure impact
- Steel reinforced tread



SELF-CLEANING

- Specific tread pattern design
- Wide and divergent inter-lugs



DESIGNED FOR A LONG TIRE LIFE

- Limited scrub thanks to innovative tread design
- More rubber to be worn



EXCELLENT ROAD HANDLING

- Central RIB for robustness
- CTIS compatibility for optimized pressure on the road and in the field

SIZES

New sizes of MICHELIN TRAILXBIB will be available by end 2022

VF 500/60R22.5 IMP 160D TL
VF 560/60R22.5 IMP 166D TL
VF 600/50R22.5 IMP 164D TL
VF 710/45R22.5 IMP 170D TL
VF 710/65R26 IMP 184D TL NEW
VF 600/55R26.5 IMP 170D TL

VF 650/55R26.5 IMP 174D TL
VF 650/65 R26.5 179D IMP TL NEW
VF 710/50R26.5 IMP 176D TL
VF 600/60R30.5 IMP 175D TL NEW
VF 650/65R30.5 IMP 181D TL
VF 710/50 R30.5 178D IMP TL NEW

VF 750/60R30.5 IMP 187D TL
VF 850/50 R30.5 188D IMP TL NEW
VF 800/60 R32 191D IMP TL NEW

MICHELIN TRAILXBIB

Tire specifications and pressure table (bar & psi). Load per tire in kg*

Ø inches	Description	CAI	e mm	D mm	R' mm	RC mm	Recommended Rim	Acceptable Rim	Tube (Code)	75% internal volume (litres)	Tread depth (mm)
22.5	VF 500/60R22.5 160D IMP TL	229116	501	1173	493	3433	AG16.00 (H2)	15.00 16.00 17.00		206	19
Bar	0.8	0.9	1	1.2	1.5	1.8	2.1	2.4	2.7	3	3.2
Psi	12	13	15	17	22	26	30	35	39	44	46
10 km/h	3125	3335	3545	3970	4600	5090	5580	6070	6560	7050	7375
25 km/h	2775	2965	3155	3530	4100	4535	4975	5410	5845	6285	6575
40 km/h	2450	2615	2780	3105	3600	3990	4375	4765	5155	5540	5800
50 km/h	2225	2375	2525	2825	3275	3630	3980	4335	4685	5040	5275
65 km/h	1900	2030	2155	2415	2800	3100	3400	3700	4000	4300	4500

Ø inches	Description	CAI	e mm	D mm	R' mm	RC mm	Recommended Rim	Acceptable Rim	Tube (Code)	75% internal volume (litres)	Tread depth (mm)
22.5	VF 560/60R22.5 166D IMP TL	103824	542	1242	507	3612	AG16.00 (H2)	16.00 17.00 AG18.00 AG20.00 (H2)		263	19
Bar	0.8	0.9	1	1.2	1.5	1.8	2.1	2.4	2.7	3	3.2
Psi	12	13	15	17	22	26	30	35	39	44	46
10 km/h	3725	3975	4250	4775	5575	6375	6950	7050	7750	8400	8700
25 km/h	3300	3550	3775	4250	4950	5675	6200	6275	6900	7475	7750
40 km/h	2925	3125	3350	3750	4375	5000	5475	5550	6100	6600	6825
50 km/h	2650	2850	3025	3400	3975	4550	4975	5025	5525	6000	6200
65 km/h	2275	2440	2600	2925	3400	3825	4250	4300	4725	5125	5300

Ø inches	Description	CAI	e mm	D mm	R' mm	RC mm	Recommended Rim	Acceptable Rim	Tube (Code)	75% internal volume (litres)	Tread depth (mm)
22.5	VF 600/50R22.5 164D IMP TL	414979	617	1172	485	3419	AG20.00 (H2)			247	18
Bar	0.8	0.9	1	1.2	1.5	1.8	2.1	2.4	2.7	3	3.2
Psi	12	13	15	17	22	26	30	35	39	44	46
10 km/h	3475	3740	4005	4530	5325	5830	6340	6845	7355	7860	8200
25 km/h	3100	3335	3570	4045	4750	5200	5650	6100	6550	7000	7300
40 km/h	2725	2935	3145	3570	4200	4595	4995	5390	5790	6185	6450
50 km/h	2475	2665	2855	3230	3800	4160	4525	4885	5245	5610	5850
65 km/h	2125	2285	2445	2770	3250	3560	3870	4175	4485	4795	5000

MICHELIN TRAILXBIB

Tire specifications and pressure table (bar & psi). Load per tire in kg*

Ø inches	Description	CAI	e mm	D mm	R' mm	RC mm	Recommended Rim		Acceptable Rim		Tube (Code)	75% internal volume (litres)	Tread depth (mm)
22.5	VF 710/45R22.5 170D IMP TL	520302	717	1214	519	3562	AG24.00 (H2)					317	20
Bar	0.8	0.9	1	1.2	1.5	1.8	2.1	2.4	2.7	3	3.2		
Psi	12	13	15	17	22	26	30	35	39	44	46		
10 km/h	4225	4500	4775	5325	6250	7175	7590	8000	8695	9390	9850		
25 km/h	3750	4000	4250	4750	5575	6400	6765	7125	7735	8345	8750		
40 km/h	3325	3545	3765	4200	4925	5650	5975	6300	6845	7390	7750		
50 km/h	3025	3220	3415	3800	4465	5125	5415	5700	6195	6695	7025		
65 km/h	2575	2745	2915	3250	3815	4375	4625	4875	5295	5720	6000		

Ø inches	Description	CAI	e mm	D mm	R' mm	RC mm	Recommended Rim		Acceptable Rim		Tube (Code)	75% internal volume (litres)	Tread depth (mm)		
26	VF 710/65R26 IMP 184D TL NEW	885998	733	1578	640	4584	DW25B(A)		DW23B(A)			577	25		
Bar	0.8	0.9	1	1.1	1.2	1.4	1.6	1.8	2	2.2	2.4	2.6	2.8	3	3.2
Psi	12	13	15	16	17	20	23	26	29	32	35	38	41	44	46
10 km/h	5975	6400	6825	7250	7675	8525	9290	9975	10655	11340	12020	12705	13385	14070	14750
25 km/h	5325	5700	6075	6450	6825	7575	8255	8870	9480	10090	10705	11315	11925	12540	13150
40 km/h	4700	5030	5365	5695	6030	6695	7295	7830	8370	8910	9445	9985	10525	11060	11600
50 km/h	4275	4575	4875	5175	5475	6075	6620	7105	7595	8085	8570	9060	9550	10035	10525
65 km/h	3650	3905	4165	4420	4680	5195	5660	6075	6495	6910	7330	7745	8165	8580	9000

Ø inches	Description	CAI	e mm	D mm	R' mm	RC mm	Recommended Rim		Acceptable Rim		Tube (Code)	75% internal volume (litres)	Tread depth (mm)
26.5	VF 600/55R26.5 170D IMP TL	112743	624	1352.5	568	3960	AG20.00 (H2)					312	22
Bar	0.8	0.9	1	1.2	1.5	1.8	2.1	2.4	2.7	3	3.2		
Psi	12	13	15	17	22	26	30	35	39	44	46		
10 km/h	3875	4155	4430	4990	5825	6535	7245	7955	8665	9375	9850		
25 km/h	3450	3695	3945	4435	5175	5805	6435	7070	7700	8330	8750		
40 km/h	3050	3270	3485	3920	4575	5135	5695	6255	6815	7375	7750		
50 km/h	2750	2950	3150	3550	4150	4655	5165	5670	6180	6685	7025		
65 km/h	2350	2520	2695	3035	3550	3980	4415	4845	5280	5710	6000		

* Refer to the notes at the end of the tables of this range

MICHELIN TRAILXBIB

Tire specifications and pressure table (bar & psi). Load per tire in kg*

Ø inches	Description	CAI	e mm	D mm	R' mm	RC mm	Recommended Rim		Acceptable Rim	Tube (Code)	75% internal volume (litres)	Tread depth (mm)
26.5	VF 650/55R26.5 174D IMP TL	054878	649	1402	575	4082	AG20.00 (H2)				377	23
Bar	0.8	0.9	1	1.2	1.5	1.8	2.1	2.4	2.7	3	3.2	
Psi	12	13	15	17	22	26	30	35	39	44	46	
10 km/h	4223	4572	4920	5494	6355	7175	8021	8938	9799	10660	10988	
25 km/h	3760	4070	4380	4891	5658	6388	7140	7957	8724	9490	9782	
40 km/h	3322	3596	3870	4322	4999	5644	6309	7031	7708	8385	8643	
50 km/h	3013	3261	3510	3919	4534	5119	5722	6377	6991	7605	7839	
65 km/h	2575	2770	2965	3350	3875	4325	4830	5450	5975	6500	6700	

Ø inches	Description	CAI	e mm	D mm	R' mm	RC mm	Recommended Rim		Acceptable Rim	Tube (Code)	75% internal volume (litres)	Tread depth (mm)			
26.5	VF 650/55R26.5 179D IMP TL NEW	059338	671	1523	665	4496	AG20.00 (H2)				472	23			
Bar	0.8	0.9	1	1.1	1.2	1.4	1.6	1.8	2.2	2.4	2	2.6	2.8	3	3.2
Psi	12	13	15	16	17	20	23	26	32	35	29	38	41	44	46
10 km/h	5275	5625	5975	6325	6675	7375	8010	8585	9730	10300	9155	10930	11565	12195	12825
25 km/h	4700	5010	5320	5630	5945	6565	7130	7640	8665	9175	8155	9740	10300	10865	11425
40 km/h	4150	4425	4700	4975	5250	5800	6300	6750	7650	8100	7200	8600	9100	9600	10100
50 km/h	3750	4005	4255	4510	4765	5270	5730	6135	6945	7350	6540	7800	8250	8700	9150
65 km/h	3250	3465	3680	3895	4105	4535	4920	5265	5955	6300	5610	6665	7025	7390	7750

Ø inches	Description	CAI	e mm	D mm	R' mm	RC mm	Recommended Rim		Acceptable Rim	Tube (Code)	75% internal volume (litres)	Tread depth (mm)
26.5	VF 710/50R26.5 176D IMP TL	723409	740	1380	568	4022	AG24.00 (H2)				407	22
Bar	0.8	0.9	1	1.2	1.5	1.8	2.1	2.4	2.7	3	3.2	
Psi	12	13	15	17	22	26	30	35	39	44	46	
10 km/h	4600	4940	5280	5955	6975	7800	8625	9450	10275	11100	11650	
25 km/h	4100	4400	4700	5300	6200	6935	7675	8410	9145	9885	10375	
40 km/h	3600	3870	4135	4670	5475	6125	6770	7420	8070	8720	9150	
50 km/h	3275	3520	3760	4245	4975	5560	6150	6735	7320	7910	8300	
65 km/h	2800	3005	3215	3630	4250	4755	5255	5760	6260	6765	7100	

* Refer to the notes at the end of the tables of this range

MICHELIN TRAILXBIB

Tire specifications and pressure table (bar & psi). Load per tire in kg*

Ø inches	Description	CAI	e mm	D mm	R' mm	RC mm	Recommended Rim		Acceptable Rim		Tube (Code)	75% internal volume (litres)	Tread depth (mm)		
30.5	VF 600/60R30.5 IMP 175D TL NEW	286219	618	1491	622	4357	AG20.00 (H2)					385	22		
Bar	0.8	0.9	1	1.1	1.2	1.4	1.6	1.8	2	2.2	2.4	2.6	2.8	3	3.2
Psi	12	13	15	16	17	20	23	26	29	32	35	38	41	44	46
10 km/h	4475	4805	5130	5460	5790	6445	7045	7580	8115	8650	9185	9720	10255	10790	11325
25 km/h	3975	4270	4560	4855	5145	5730	6265	6740	7215	7695	8170	8645	9120	9600	10075
40 km/h	3525	3780	4040	4295	4555	5070	5535	5955	6375	6795	7220	7640	8060	8480	8900
50 km/h	3200	3430	3665	3895	4130	4595	5015	5400	5780	6165	6545	6930	7310	7695	8075
65 km/h	2725	2925	3125	3325	3525	3925	4290	4615	4940	5270	5595	5920	6245	6575	6900

Ø inches	Description	CAI	e mm	D mm	R' mm	RC mm	Recommended Rim		Acceptable Rim		Tube (Code)	75% internal volume (litres)	Tread depth (mm)
30.5	VF 650/65R30.5 181D IMP TL	120737	650	1632	705	4806	AG20.00 (H2)					518	27
Bar	0.8	0.9	1	1.2	1.5	1.8	2.1	2.4	2.7	3	3.2		
Psi	12	13	15	17	22	26	30	35	39	44	46		
10 km/h	5650	6030	6415	7175	8065	8950	9975	11000	11945	12895	13525		
25 km/h	5025	5370	5715	6400	7175	7950	8865	9775	10630	11480	12050		
40 km/h	4450	4750	5050	5650	6340	7025	7840	8650	9400	10150	10650		
50 km/h	4025	4300	4575	5125	5750	6375	7115	7850	8525	9200	9650		
65 km/h	3450	3680	3915	4375	4915	5450	6075	6700	7280	7865	8250		

Ø inches	Description	CAI	e mm	D mm	R' mm	RC mm	Recommended Rim		Acceptable Rim		Tube (Code)	75% internal volume (litres)	Tread depth (mm)		
30.5	VF 710/50R30.5 IMP 178D TL NEW	562163	726	1489	652	4397			AG24.00 (H2)			447	25		
Bar	0.8	0.9	1	1.1	1.2	1.4	1.6	1.8	2	2.2	2.4	2.6	2.8	3	3.2
Psi	12	13	15	16	17	20	23	26	29	32	35	38	41	44	46
10 km/h	4925	5275	5625	5975	6325	7025	7660	8225	8790	9360	9925	10530	11140	11745	12350
25 km/h	4375	4690	5005	5320	5630	6260	6825	7325	7825	8325	8825	9370	9915	10455	11000
40 km/h	3875	4150	4425	4700	4975	5525	6020	6465	6910	7355	7800	8280	8765	9245	9725
50 km/h	3525	3775	4025	4275	4525	5025	5475	5875	6275	6675	7075	7515	7950	8390	8825
65 km/h	3000	3215	3430	3645	3855	4285	4665	5000	5335	5665	6000	6375	6750	7125	7500

* Refer to the notes at the end of the tables of this range

MICHELIN TRAILXBIB

Tire specifications and pressure table (bar & psi). Load per tire in kg*

Ø inches	Description	CAI	e mm	D mm	R' mm	RC mm	Recommended Rim		Acceptable Rim	Tube (Code)	75% internal volume (litres)	Tread depth (mm)
30.5	VF 750/60R30.5 18D IMP TL	223428	782	1678	695	4873	AG24.00	(H2)	AG24.00		650	27
Bar	0.8	0.9	1	1.2	1.5	1.8	2.1	2.4	2.7	3	3.2	
Psi	12	13	15	17	22	26	30	35	39	44	46	
10 km/h	6350	6815	7275	8200	9265	10325	11515	12700	13940	15175	16000	
25 km/h	5650	6065	6475	7300	8250	9200	10265	11325	12415	13500	14225	
40 km/h	5000	5365	5725	6450	7290	8125	9065	10000	10965	11930	12575	
50 km/h	4525	4855	5190	5850	6615	7375	8225	9075	9945		11400	
65 km/h	3875	4155	4440	5000	5650	6300	7025	7750	8500	9250	9750	

Ø inches	Description	CAI	e mm	D mm	R' mm	RC mm	Recommended Rim		Acceptable Rim	Tube (Code)	75% internal volume (litres)	Tread depth (mm)			
30.5	VF 850/50R30.5 IMP 18BD TL NEW	659949	855	1626	682	4758	AG28.00	(H2)			681	25			
Bar	0.8	0.9	1	1.1	1.2	1.4	1.6	1.8	2	2.2	2.4	2.6	2.8	3	3.2
Psi	12	13	15	16	17	20	23	26	29	32	35	38	41	44	46
10 km/h	6525	6990	7455	7920	8380	9310	10145	10890	11635	12380	13125	13930	14740	15545	16350
25 km/h	5800	6215	6630	7045	7455	8285	9030	9690	10355	11015	11675	12395	13115	13830	14550
40 km/h	5125	5495	5860	6230	6595	7330	7990	8575	9160	9740	10325	10955	11590	12220	12850
50 km/h	4650	4980	5315	5645	5980	6645	7240	7765	8295	8820	9350	9930	10515	11095	11675
65 km/h	4000	4285	4570	4855	5145	5715	6220	6665	7110	7555	8000	8500	9000	9500	10000

Ø inches	Description	CAI	e mm	D mm	R' mm	RC mm	Recommended Rim		Acceptable Rim	Tube (Code)	75% internal volume (litres)	Tread depth (mm)			
32	VF 800/60R32 IMP 191D TL NEW	044770	828	1777	771	5291	DW27B(A)				780	27			
Bar	0.8	0.9	1	1.1	1.2	1.4	1.6	1.8	2	2.2	2.4	2.6	2.8	3	3.2
Psi	12	13	15	16	17	20	23	26	29	32	35	38	41	44	46
10 km/h	7125	7635	8145	8655	9170	10190	11105	11915	12730	13540	14350	15240	16125	17015	17900
25 km/h	6350	6805	7255	7710	8165	9070	9885	10610	11330	12055	12775	13565	14350	15140	15925
40 km/h	5600	6005	6405	6810	7215	8020	8745	9385	10020	10660	11300	11995	12690	13380	14075
50 km/h	5100	5460	5820	6180	6545	7265	7915	8500	9085	9665	10250	10880	11515	12145	12775
65 km/h	4375	4680	4980	5285	5590	6195	6750	7250	7750	8250	8750	9290	9825	10365	10900

***IMPORTANT:**

The inflation pressure must always be appropriate for the load per tire, the speed of travel and the work to be done. Our recommendations above are provided subject to changes made after the date of publication of these tables. Technical data is subject to change without prior notice.

- Add 0.4 bar for use on slopes of more than 20%
- Add 0.4 bar for intense road use exceeding 50% of time on road

* Refer to the notes at the end of the tables of this range



MICHELIN CARGOXBIB HIGH FLOTATION

**THE LOW-PRESSURE
TRAILER TIRE WITH
LESS IMPACT ON THE SOIL**



The best performance **FROM ROAD TO FIELD**



SOIL PROTECTION

thanks to low pressure from 0,8 bar and +37% footprint⁽¹⁾



Up to 3 times more **SELF-CLEANING ABILITY**



Excellent **ROAD HANDLING**



STEEL REINFORCED TREAD

- Great stability
- Excellent puncture resistance and better load distribution.

(1) Internal studies at Michelin's Technology Centre April 2012 / June 2013

SIZES

710/45R22.5 165D TL

28 LR26 175D TL

600/55R26.5 165D TL

650/55R26.5 169D TL

710/50R26.5 170D TL

VF600/55R26.5 170D IMP TL

VF650/55R26.5 174D IMP TL

VF710/50R26.5 176D IMP TL

650/65R30.5 176D TL

750/60R30.5 181D TL

VF750/60R30.5 187D IMP TL

800/60R32 185D IMP TL

MICHELIN CARGOXBIB HIGH FLOTATION

Tire specifications and pressure table (bar & psi). Load per tire in kg*

Ø inches	Description	CAI	e mm	D mm	R' mm	RC mm	Recommended Rim		Acceptable Rim		Tube (Code)	75% internal volume (litres)	Tread depth (mm)		
22.5	710/45R22.5 16SD TL	723051	723	1208	514	3545	AG24.00 (H2)		AG20.00 (H2)			317	16		
Bar	0.8	0.9	1	1.2	1.5	1.8	2.1	2.4	2.7	3	3.2	3.4	3.6	3.8	4
Psi	12	13	15	17	22	26	30	35	39	44	46	49	52	55	58
10 km/h	2970	3430	3890	4325	4970	5620	6270	6920	7360	7800	8095	8390	8685	8975	9270
25 km/h	2610	2930	3250	3650	4255	4855	5460	6060	6450	6840	7100	7360	7620	7880	8140
40 km/h	2250	2525	2800	3145	3665	4185	4700	5220	5555	5890	6110	6335	6555	6780	7000
50 km/h	2000	2245	2490	2795	3260	3720	4180	4640	4940	5235	5435	5635	5835	6030	6230
65 km/h	1650	1855	2060	2315	2695	3075	3460	3840	4085	4330	4495	4660	4825	4985	5150

Ø inches	Description	CAI	e mm	D mm	R' mm	RC mm	Recommended Rim		Acceptable Rim		Tube (Code)	75% internal volume (litres)	Tread depth (mm)		
26	28LR26 17SD TL	224829	740	1581	705	4685	DW25B (A)		DW23B(A)			578	26		
Bar	0.8	0.9	1	1.2	1.5	1.8	2.1	2.4	2.7	3	3.2	3.4	3.6	3.8	4
Psi	12	13	15	17	22	26	30	35	39	44	46	49	52	55	58
15 km/h	3750	3935	4120	4615	5360	5905	6460	7035	7605	7905	8140	8375	8710	8980	9245
25 km/h	3320	3485	3645	4085	4740	5220	5710	6220	6725	6990	7200	7405	7705	7940	8175
40 km/h	3065	3215	3365	3770	4380	4825	5280	5750	6215	6460	6655	6845	7120	7340	7555
50 km/h	2940	3085	3230	3620	4200	4625	5060	5515	5960	6195	6380	6565	6825	7035	7245
65 km/h	2800	2940	3075	3445	4000	4405	4820	5250	5675	5900	6075	6250	6500	6700	6900

Ø inches	Description	CAI	e mm	D mm	R' mm	RC mm	Recommended Rim		Acceptable Rim		Tube (Code)	75% internal volume (litres)	Tread depth (mm)		
26.5	600/55R26.5 16SD TL	550621	626	1341	581	3954	AG20.00 (H2)				716	312	17		
Bar	0.8	0.9	1	1.2	1.5	1.8	2.1	2.4	2.7	3	3.2	3.4	3.6	3.8	4
Psi	12	13	15	17	22	26	30	35	39	44	46	49	52	55	58
10 km/h	2970	3585	4200	4675	5380	6090	6800	7510	7840	8170	8390	8610	8830	9050	9270
25 km/h	2610	3085	3560	3995	4640	5290	5940	6590	6880	7170	7365	7560	7755	7945	8140
40 km/h	2250	2675	3100	3465	4020	4570	5120	5670	5920	6170	6335	6500	6670	6835	7000
50 km/h	2000	2375	2750	3080	3570	4065	4555	5050	5270	5495	5640	5790	5935	6085	6230
65 km/h	1650	1975	2300	2565	2970	3370	3770	4170	4355	4540	4660	4785	4905	5030	5150

* Refer to the notes at the end of the tables of this range

MICHELIN CARGOXBIB HIGH FLOTATION

Tire specifications and pressure table (bar & psi). Load per tire in kg*

Ø inches	Description	CAI	e mm	D mm	R' mm	RC mm	Recommended Rim		Acceptable Rim		Tube (Code)	75% internal volume (litres)	Tread depth (mm)
26.5	VF 600/55R26.5 IMP 170D TL	377726	626	1341	562	3923	AG20.00 (H2)					312	17
Bar	0.8	0.9	1	1.2	1.5	1.8	2.1	2.4	2.7	3	3.2		
Psi	12	13	15	17	22	26	30	35	39	44	46		
10 km/h	3772	4025	4264	4756	5658	6322	7081	7790	8549	9184	9840		
25 km/h	3358	3583	3796	4234	5037	5628	6304	6935	7610	8176	8760		
40 km/h	2967	3166	3354	3741	4451	4973	5570	6128	6724	7224	7740		
50 km/h	2691	2871	3042	3393	4036	4510	5051	5558	6099	6552	7020		
65 km/h	2300	2450	2600	2900	3450	3855	4280	4750	5275	5600	6000		

Ø inches	Description	CAI	e mm	D mm	R' mm	RC mm	Recommended Rim		Acceptable Rim		Tube (Code)	75% internal volume (litres)	Tread depth (mm)		
26.5	710/50R26.5 170D TL	892516	729	1380	594	4061	AG24.00 (H2)		AG20.00 (H2)			407	18		
Bar	0.8	0.9	1	1.2	1.5	1.8	2.1	2.4	2.7	3	3.2	3.4	3.6	3.8	4
Psi	12	13	15	17	22	26	30	35	39	44	46	49	52	55	58
10 km/h	3510	4205	4900	5450	6275	7100	7925	8750	9135	9520	9775	10030	10290	10545	10800
25 km/h	3080	3610	4140	4645	5400	6155	6915	7670	8010	8350	8575	8800	9030	9255	9480
40 km/h	2650	3130	3610	4040	4680	5325	5965	6610	6900	7190	7385	7580	7775	7965	8160
50 km/h	2360	2780	3200	3585	4155	4730	5305	5880	6140	6400	6570	6745	6915	7090	7260
65 km/h	1950	2315	2680	2990	3460	3925	4395	4860	5075	5290	5430	5575	5715	5860	6000

Ø inches	Description	CAI	e mm	D mm	R' mm	RC mm	Recommended Rim		Acceptable Rim		Tube (Code)	75% internal volume (litres)	Tread depth (mm)	
26.5	VF 710/50R26.5 IMP 176D TL	343405	729	1380	568	4022	AG24.00 (H2)		AG20.00 (H2)			407	18	
Bar	0.8	0.9	1	1.2	1.5	1.8	2.1	2.4	2.7	3	3.2			
Psi	12	13	15	17	22	26	30	35	39	44	46			
10 km/h	4469	4768	5150	5822	6765	7503	8400	9184	10081	10988	11644			
25 km/h	3979	4245	4584	5183	6023	6680	7478	8176	8974	9782	10366			
40 km/h	3515	3750	4051	4580	5321	5902	6607	7224	7929	8643	9159			
50 km/h	3188	3402	3674	4154	4826	5353	5993	6552	7192	7839	8307			
65 km/h	2725	2930	3140	3550	4125	4575	5055	5600	6275	6700	7100			

* Refer to the notes at the end of the tables of this range

MICHELIN CARGOXBIB HIGH FLOTATION

Tire specifications and pressure table (bar & psi). Load per tire in kg*

Ø inches	Description	CAI	e mm	D mm	R' mm	RC mm	Recommended Rim		Acceptable Rim		Tube (Code)	75% internal volume (litres)	Tread depth (mm)		
26.5	650/55R26.5 169D TL	693431	657	1402	617	4158	AG20.00 (H2)				716	437	18		
Bar	0.8	0.9	1	1.2	1.5	1.8	2.1	2.4	2.7	3	3.2	3.4	3.6	3.8	4
Psi	12	13	15	17	22	26	30	35	39	44	46	49	52	55	58
10 km/h	3330	3985	4635	5220	6100	6875	7600	8325	8780	9235	9540	9765	9990	10215	10440
25 km/h	2925	3500	4070	4585	5355	6035	6675	7310	7710	8110	8375	8575	8770	8970	9165
40 km/h	2515	3010	3500	3945	4610	5195	5745	6290	6635	6980	7210	7380	7550	7720	7890
50 km/h	2240	2680	3115	3510	4100	4620	5110	5595	5905	6210	6415	6565	6720	6870	7020
65 km/h	1850	2215	2575	2900	3390	3820	4220	4625	4880	5130	5300	5425	5550	5675	5800

Ø inches	Description	CAI	e mm	D mm	R' mm	RC mm	Recommended Rim		Acceptable Rim		Tube (Code)	75% internal volume (litres)	Tread depth (mm)
26.5	VF 650/55R26.5 IMP 174D TL	776393	663	1402	578	4084	AG20.00		AG20.00 (H2)			437	18
Bar	0.8	0.9	1	1.2	1.5	1.8	2.1	2.4	2.7	3	3.2		
Psi	12	13	15	17	22	26	30	35	39	44	46		
10 km/h	4223	4572	4920	5494	6355	7175	8021	8938	9799	10660	10988		
25 km/h	3760	4070	4380	4891	5658	6388	7140	7957	8724	9490	9782		
40 km/h	3322	3596	3870	4322	4999	5644	6309	7031	7708	8385	8643		
50 km/h	3013	3261	3510	3919	4534	5119	5722	6377	6991	7605	7839		
65 km/h	2575	2770	2965	3350	3875	4325	4830	5450	5975	6500	6700		

Ø inches	Description	CAI	e mm	D mm	R' mm	RC mm	Recommended Rim		Acceptable Rim		Tube (Code)	75% internal volume (litres)	Tread depth (mm)		
30.5	650/65R30.5 176D TL	139310	674	1622	699	4776	AG20.00 (H2)					600	21		
Bar	0.8	0.9	1	1.2	1.5	1.8	2.1	2.4	2.7	3	3.2	3.4	3.6	3.8	4
Psi	12	13	15	17	22	26	30	35	39	44	46	49	52	55	58
10 km/h	4140	4970	5800	6450	7430	8405	9385	10360	10815	11270	11570	11875	12175	12480	12780
25 km/h	3640	4270	4900	5495	6395	7290	8185	9080	9480	9885	10150	10420	10685	10955	11220
40 km/h	3130	3705	4280	4785	5545	6305	7060	7820	8165	8510	8740	8970	9200	9430	9660
50 km/h	2780	3285	3790	4245	4920	5600	6280	6960	7265	7570	7775	7980	8185	8385	8590
65 km/h	2300	2735	3170	3540	4090	4645	5195	5750	6005	6255	6425	6595	6765	6930	7100

* Refer to the notes at the end of the tables of this range

MICHELIN CARGOXBIB HIGH FLOTATION

Tire specifications and pressure table (bar & psi). Load per tire in kg*

Ø inches	Description	CAI	e mm	D mm	R' mm	RC mm	Recommended Rim		Acceptable Rim		Tube (Code)	75% internal volume (litres)	Tread depth (mm)
30.5	VF 750/60R30.5 IMP 187D TL	139588	780	1674	687	4875	AG24.00 (H2)					750	21
Bar	0.8	0.9	1	1.2	1.5	1.8	2.1	2.4	2.7	3	3.2		
Psi	12	13	15	17	22	26	30	35	39	44	46		
10 km/h	6150	6560	6970	7790	9020	10250	11480	12710	13940	15170	15990		
25 km/h	5475	5840	6205	6935	8030	9125	10220	11315	12410	13505	14235		
40 km/h	4838	5160	5483	6130	7095	8065	9030	9998	10965	11935	12578		
50 km/h	4388	4680	4973	5560	6435	7315	8190	9068	9945	10825	11408		
65 km/h	3750	4000	4250	4750	5500	6250	7000	7750	8500	9250	9750		

Ø inches	Description	CAI	e mm	D mm	R' mm	RC mm	Recommended Rim		Acceptable Rim		Tube (Code)	75% internal volume (litres)	Tread depth (mm)
30.5	750/60R30.5 181D TL	101332	786	1675	716	4936	AG24.00 (H2)					750	22
Bar	0.8	0.9	1	1.2	1.5	1.8	2.1	2.4	2.7	3	3.2	3.4	3.6
Psi	12	13	15	17	22	26	30	35	39	44	46	49	52
10 km/h	4770	5750	6730	7490	8625	9765	10900	12040	12565	13095	13445	13795	14150
25 km/h	4185	4945	5700	6395	7430	8470	9510	10550	11015	11485	11795	12105	12420
40 km/h	3605	4290	4970	5560	6440	7325	8205	9090	9490	9890	10155	10420	10690
50 km/h	3205	3810	4410	4935	5720	6505	7295	8080	8435	8795	9030	9270	9505
65 km/h	2650	3165	3680	4110	4750	5395	6035	6680	6975	7270	7465	7660	7860

Ø inches	Description	CAI	e mm	D mm	R' mm	RC mm	Recommended Rim		Acceptable Rim		Tube (Code)	75% internal volume (litres)	Tread depth (mm)
32	800/60R32 IMP 185D TL	322432	818	1800	777	5300	DW27B (A)			DW25B (A)	831	900	23
Bar	0.8	0.9	1	1.2	1.5	1.8	2.1	2.4	2.7	3	3.2	3.4	3.6
Psi	12	13	15	17	22	26	30	35	39	44	46	49	52
10 km/h	5400	6525	7650	8580	9975	11205	12355	13500	14345	15190	15750	15975	16200
25 km/h	4740	5730	6715	7530	8755	9835	10845	11850	12590	13330	13825	14025	14220
40 km/h	4080	4930	5780	6485	7540	8470	9335	10200	10840	11475	11900	12070	12240
50 km/h	3630	4390	5145	5770	6710	7535	8305	9075	9645	10210	10590	10740	10895
65 km/h	3000	3625	4250	4765	5540	6225	6865	7500	7970	8440	8750	8875	9000

***IMPORTANT:**

The inflation pressure must always be appropriate for the load per tire, the speed of travel and the work to be done. Our recommendations above are provided subject to changes made after the date of publication of these tables. Technical data is subject to change without prior notice.

- For use on side slopes: add 0.4 bar.
- For heavy road use: add 0.4 bar.



MICHELIN CARGOXBIB HEAVY DUTY

**EXCELLENT VALUE
FOR TRANSPORTING
YOUR HARVESTS**



Up to 3 times more **SELF-CLEANING ABILITY**



STABILITY

- Excellent road handling



SERVICE LIFE

- Proven casing endurance



STEEL REINFORCED TREAD

- Great stability
- Excellent puncture resistance and better load distribution.

SIZES

500/60R22.5 155D TL

560/45R22.5 152D TL

560/60R22.5 161D TL

MICHELIN CARGOXBIB HEAVY DUTY

Tire specifications and pressure table (bar & psi). Load per tire in kg*

Ø inches	Description	CAI	e mm	D mm	R' mm	RC mm	Recommended Rim		Acceptable Rim		Tube (Code)	75% internal volume (litres)	Tread depth (mm)		
22.5	560/45R22.5 152D TL	743789	535	1080	474	3191	AG16.00 (H2)					182	16		
Bar	0.8	0.9	1	1.2	1.5	1.8	2.1	2.4	2.7	3	3.2	3.4	3.6	3.8	4
Psi	12	13	15	17	22	26	30	35	39	44	46	49	52	55	58
10 km/h	2070	2225	2375	2665	3095	3475	3845	4245	4650	5050	5320	5585	5855	6120	6390
25 km/h	1820	1955	2085	2340	2720	3050	3375	3725	4080	4435	4670	4905	5140	5375	5610
40 km/h	1565	1680	1795	2015	2340	2625	2900	3205	3510	3815	4020	4220	4425	4625	4830
50 km/h	1390	1495	1600	1795	2085	2340	2585	2855	3125	3400	3580	3760	3940	4120	4300
65 km/h	1150	1235	1320	1480	1720	1930	2135	2360	2580	2805	2955	3105	3250	3400	3550

Ø inches	Description	CAI	e mm	D mm	R' mm	RC mm	Recommended Rim		Acceptable Rim		Tube (Code)	75% internal volume (litres)	Tread depth (mm)		
22.5	500/60R22.5 155D TL	441880	505	1172	508	3454	AG16.00 (H2)		14.00 15.00 16.00 17.00			206	16		
Bar	0.8	0.9	1	1.2	1.5	1.8	2.1	2.4	2.7	3	3.2	3.4	3.6	3.8	4
Psi	12	13	15	17	22	26	30	35	39	44	46	49	52	55	58
10 km/h	2250	2705	3160	3515	4050	4585	5115	5650	5900	6150	6315	6480	6650	6815	6980
25 km/h	1975	2330	2680	3005	3495	3985	4470	4960	5180	5395	5540	5685	5830	5975	6120
40 km/h	1700	2015	2330	2605	3025	3440	3855	4270	4460	4645	4770	4895	5020	5145	5270
50 km/h	1510	1790	2070	2315	2690	3060	3430	3800	3965	4135	4245	4355	4470	4580	4690
65 km/h	1250	1490	1730	1930	2235	2535	2840	3140	3280	3420	3510	3605	3695	3790	3880

Ø inches	Description	CAI	e mm	D mm	R' mm	RC mm	Recommended Rim		Acceptable Rim		Tube (Code)	75% internal volume (litres)	Tread depth (mm)		
22.5	560/60R22.5 161D TL	102433	543	1242	532	3650	AG16.00 (H2)		16.00 17.00 AG18.00 AG20.00 (H2)			269	16		
Bar	0.8	0.9	1	1.2	1.5	1.8	2.1	2.4	2.7	3	3.2	3.4	3.6	3.8	4
Psi	12	13	15	17	22	26	30	35	39	44	46	49	52	55	58
10 km/h	2700	3240	3780	4205	4840	5475	6115	6750	7045	7345	7540	7740	7935	8135	8330
25 km/h	2370	2780	3190	3580	4160	4745	5325	5910	6175	6435	6610	6785	6960	7135	7310
40 km/h	2040	2415	2790	3120	3610	4105	4595	5090	5315	5540	5690	5840	5990	6140	6290
50 km/h	1810	2140	2470	2765	3205	3645	4090	4530	4730	4930	5065	5200	5335	5465	5600
65 km/h	1500	1785	2070	2310	2670	3030	3390	3750	3915	4080	4190	4300	4410	4520	4630

***IMPORTANT:**

The inflation pressure must always be appropriate for the load per tire, the speed of travel and the work to be done. Our recommendations above are provided subject to changes made after the date of publication of these tables. Technical data is subject to change without prior notice.

- For use on side slopes: add 0.4 bar.
- For heavy road use: add 0.4 bar.



MICHELIN CARGO X BIB

**ENHANCED ENDURANCE
FOR HEAVY LOADS
AT LOW PRESSURES**



ENDURANCE



PRODUCTIVITY



PROFITABILITY



STEEL REINFORCED TREAD

- Great stability
- Excellent puncture resistance and better load distribution.

SIZES

600/50R22.5 159D TL

800/45R26.5 174D TL

600/60R30.5 169D TL

710/50R30.5 173D TL

800/45R30.5 176D TL

850/50R30.5 182D TL

MICHELIN CARGOXBIB

Tire specifications and pressure table (bar & psi). Load per tire in kg*

Ø inches	Description	CAI	e mm	D mm	R' mm	RC mm	Recommended Rim		Acceptable Rim	Tube (Code)	75% internal volume (litres)	Tread depth (mm)
22.5	600/50R22.5 159D TL	048429	616	1181	510	3478	AG20.00 (H2)				298	17
Bar	1	1.3	1.5	1.9	2.2	2.5	2.8	3.1	3.4	3.7	4	
Psi	15	19	22	28	32	36	41	45	49	54	58	
10 km/h	3570	4170	4575	5375	5980	6475	6755	7035	7320	7600	7880	
25 km/h	3020	3570	3940	4670	5225	5675	5920	6170	6415	6665	6910	
40 km/h	2640	3105	3420	4040	4510	4890	5105	5315	5525	5740	5950	
50 km/h	2340	2760	3035	3595	4010	4355	4540	4730	4915	5105	5290	
65 km/h	1950	2290	2520	2970	3315	3595	3750	3910	4065	4225	4380	

Ø inches	Description	CAI	e mm	D mm	R' mm	RC mm	Recommended Rim		Acceptable Rim	Tube (Code)	75% internal volume (litres)	Tread depth (mm)
26.5	800/45R26.5 174D TL	248959	815	1395	595	4097	AG28.00 (H2)		AG24.00 (H2)		561	19
Bar	1	1.3	1.5	1.9	2.2	2.5	2.8	3.1	3.4	3.7	4	
Psi	15	19	22	28	32	36	41	45	49	54	58	
10 km/h	5070	5910	6475	7595	8440	9190	9765	10340	10915	11485	12060	
25 km/h	4230	5015	5535	6585	7365	8060	8565	9070	9580	10085	10590	
40 km/h	3640	4315	4765	5665	6340	6935	7370	7805	8240	8675	9110	
50 km/h	3240	3840	4240	5040	5640	6170	6560	6945	7335	7720	8110	
65 km/h	2680	3175	3505	4165	4660	5095	5420	5740	6060	6380	6700	

Ø inches	Description	CAI	e mm	D mm	R' mm	RC mm	Recommended Rim		Acceptable Rim	Tube (Code)	75% internal volume (litres)	Tread depth (mm)
30.5	710/50R30.5 173D TL	002786	728	1495	649	4408	AG24.00 (H2)				537	21
Bar	1	1.3	1.5	1.9	2.2	2.5	2.8	3.1	3.4	3.7	4	
Psi	15	19	22	28	32	36	41	45	49	54	58	
10 km/h	5310	6205	6800	7990	8885	9620	10035	10450	10870	11285	11700	
25 km/h	4490	5310	5855	6945	7765	8435	8800	9170	9535	9905	10270	
40 km/h	3910	4605	5070	6000	6695	7265	7580	7895	8210	8525	8840	
50 km/h	3470	4090	4505	5335	5955	6465	6745	7025	7310	7590	7870	
65 km/h	2900	3410	3745	4425	4930	5345	5580	5810	6040	6270	6500	

* Refer to the notes at the end of the tables of this range

MICHELIN CARGOXBIB

Tire specifications and pressure table (bar & psi). Load per tire in kg*

Ø inches	Description	CAI	e mm	D mm	R' mm	RC mm	Recommended Rim	Acceptable Rim	Tube (Code)	75% internal volume (litres)	Tread depth (mm)
30.5	800/45R30.5 176D TL	932951	820	1495	650	4408	AG28.00 (H2)			616	21
Bar	1	1.3	1.5	1.9	2.2	2.5	2.8	3.1	3.4	3.7	4
Psi	15	19	22	28	32	36	41	45	49	54	58
10 km/h	5370	6265	6860	8050	8945	9745	10350	10960	11565	12175	12780
25 km/h	4490	5320	5870	6980	7805	8540	9075	9610	10150	10685	11220
40 km/h	3860	4575	5055	6005	6725	7355	7815	8275	8740	9200	9660
50 km/h	3440	4075	4495	5345	5975	6535	6950	7360	7770	8180	8590
65 km/h	2840	3365	3715	4415	4940	5405	5745	6080	6420	6760	7100

Ø inches	Description	CAI	e mm	D mm	R' mm	RC mm	Recommended Rim	Acceptable Rim	Tube (Code)	75% internal volume (litres)	Tread depth (mm)
30.5	600/60R30.5 169D TL	236518	639	1496	654	4417	AG20.00 (H2)			469	21
Bar	1	1.3	1.5	1.9	2.2	2.5	2.8	3.1	3.4	3.7	4
Psi	15	19	22	28	32	36	41	45	49	54	58
10 km/h	4730	5530	6060	7130	7925	8585	8955	9325	9700	10070	10440
25 km/h	4000	4735	5220	6200	6930	7530	7855	8180	8510	8835	9160
40 km/h	3490	4110	4525	5355	5975	6485	6765	7045	7330	7610	7890
50 km/h	3100	3655	4020	4760	5310	5765	6015	6265	6520	6770	7020
65 km/h	2590	3040	3345	3945	4400	4770	4975	5180	5390	5595	5800

Ø inches	Description	CAI	e mm	D mm	R' mm	RC mm	Recommended Rim	Acceptable Rim	Tube (Code)	75% internal volume (litres)	Tread depth (mm)
30.5	850/50R30.5 182D TL	938016	861	1628	692	4778	AG28.00 (H2)			817	23
Bar	1	1.3	1.5	1.9	2.2	2.5	2.8	3.1	3.4	3.7	4
Psi	15	19	22	28	32	36	41	45	49	54	58
10 km/h	6430	7500	8210	9640	10705	11665	12390	13120	13845	14575	15300
25 km/h	5370	6365	7025	8355	9345	10225	10865	11505	12150	12790	13430
40 km/h	4620	5475	6050	7190	8050	8805	9355	9905	10460	11010	11560
50 km/h	4110	4875	5380	6400	7160	7835	8325	8815	9310	9800	10290
65 km/h	3400	4030	4450	5290	5920	6475	6880	7285	7690	8095	8500

***IMPORTANT:**

The inflation pressure must always be appropriate for the load per tire, the speed of travel and the work to be done. Our recommendations above are provided subject to changes made after the date of publication of these tables. Technical data is subject to change without prior notice.

- For use on side slopes: add 0.4 bar.
- For heavy road use: add 0.4 bar.



MICHELIN XP 27

**ENHANCED ENDURANCE
FOR HEAVY LOADS
AT LOW PRESSURES**



PRODUCTIVITY



PROFITABILITY

SIZES

270/65R16 134A8/122A8 TL

270/65R18 136A8/124A8 TL

340/65R18 149A8/137A8 TL

MICHELIN XP 27

Tire specifications and pressure table (bar & psi). Load per tire in kg*

Ø inches	Description	CAI	e mm	D mm	R' mm	RC mm	Recommended Rim		Acceptable Rim		Tube (Code)	75% internal volume (litres)	Tread depth (mm)		
16	270/65R16 IMP 134A8/122A8 TL	184332	265	755	333	2300	W8		W7 W9		827	45	9		
Bar	1 1.3 1.5	1.9 2.2 2.5	2.8 3.1 3.4	3.7 4 4.1	4.4 4.7 5										
Psi	15 19 22	28 32 36	41 45 49	54 58 59	64 68 73										
10 km/h	1060	1235	1350	1580	1755	1930	2105	2280	2450	2625	2800	2815	2870	2920	2970
25 km/h	895	1045	1145	1340	1490	1640	1785	1935	2085	2230	2380	2395	2440	2480	2525
30 km/h	840	980	1070	1255	1395	1535	1675	1815	1950	2090	2230	2245	2285	2330	2370
40 km/h	750	875	960	1125	1250	1375	1500	1625	1750	1875	2000	2010	2050	2085	2120
50 km/h	690	805	880	1035	1150	1265	1380	1495	1610	1725	1840	1850	1885	1915	1950

Ø inches	Description	CAI	e mm	D mm	R' mm	RC mm	Recommended Rim		Acceptable Rim		Tube (Code)	75% internal volume (litres)	Tread depth (mm)		
18	270/65R18 IMP 136A8/124A8 TL	133069	265	810	361	2472	W8		9 W9		438	51	9		
Bar	1 1.3 1.5	1.9 2.2 2.5	2.8 3.1 3.4	3.7 4 4.1	4.4 4.7 5										
Psi	15 19 22	28 32 36	41 45 49	54 58 59	64 68 73										
10 km/h	1120	1305	1425	1670	1855	2040	2225	2410	2590	2775	2960	2980	3030	3085	3140
25 km/h	950	1105	1210	1420	1575	1730	1885	2040	2200	2355	2510	2525	2570	2620	2665
30 km/h	890	1035	1135	1330	1480	1625	1770	1920	2065	2215	2360	2375	2420	2465	2510
40 km/h	800	930	1020	1195	1325	1455	1585	1715	1850	1980	2110	2125	2160	2200	2240
50 km/h	730	850	930	1095	1215	1335	1455	1575	1700	1820	1940	1950	1990	2025	2060

Ø inches	Description	CAI	e mm	D mm	R' mm	RC mm	Recommended Rim		Acceptable Rim		Tube (Code)	75% internal volume (litres)	Tread depth (mm)		
18	340/65R18 149A8/137A8 TL	415969	343	891	393	2720	11		9 W9		828	80	8		
Bar	1 1.3 1.5	1.9 2.2 2.5	2.8 3.1 3.4	3.7 4 4.1	4.4 4.7 5										
Psi	15 19 22	28 32 36	41 45 49	54 58 59	64 68 73										
10 km/h	1620	1885	2065	2420	2685	2950	3215	3480	3750	4015	4280	4305	4390	4470	4550
25 km/h	1380	1605	1755	2060	2285	2510	2735	2960	3190	3415	3640	3665	3730	3800	3870
30 km/h	1290	1505	1645	1930	2145	2360	2575	2790	3000	3215	3430	3450	3515	3575	3640
40 km/h	1160	1350	1475	1730	1920	2110	2300	2490	2680	2870	3060	3080	3135	3195	3250
50 km/h	1160	1350	1475	1730	1920	2110	2300	2490	2680	2870	3060	3080	3135	3195	3250

***IMPORTANT:**

The inflation pressure must always be appropriate for the load per tire, the speed of travel and the work to be done. Our recommendations above are provided subject to changes made after the date of publication of these tables. Technical data is subject to change without prior notice.

- For use on side slopes: add 0.4 bar.
- For heavy road use: add 0.4 bar.



MICHELIN XS

**THE ALL-TERRAIN,
ALL POSITION RADIAL TIRE
FOR CONSTRUCTION,
INDUSTRY AND PUBLIC
WORKS**



ENDURANCE

- Casing made of steel for increased resistance to impacts with high load capacity
- Damage resistant tread pattern using Earthmover technology



MOBILITY

- Wide and flat tread for maximum flotation
- Made for long distance transport up to 80 km/h

SAFETY

- Flexible casing and tread pattern for being driven at low pressures



100% STEEL CONSTRUCTION

- Great stability
- Excellent puncture resistance and better load distribution.

SIZES

24R20.5 XS TL 176F

525/65R20.5 XS TL 173F

MICHELIN XS

Tire specifications and pressure table (bar & psi). Load per tire in kg*

Ø inches	Description	CAI	e mm	D mm	R' mm	RC mm	Recommended Rim		Acceptable Rim		Tube (Code)	75% internal volume (litres)	Tread depth (mm)
20.5	525/65R20.5 173F TL	109421	521	1200	549	3640	16.00				19.5/20.5 UD	253	17
Bar	1.5	1.8	2	2.2	2.4	2.6	2.8	3	3.2	3.4	3.6	3.8	4
Psi	22	26	29	32	35	38	41	44	46	49	52	55	58
30 km/h	2430	2860	3145	3430	3715	4050	4435	4815	4970	5130	5285	5445	5600
40 km/h	2370	2770	3035	3300	3565	3875	4230	4580	4750	4920	5090	5260	5430
50 km/h	2315	2680	2925	3165	3410	3695	4020	4350	4530	4715	4895	5080	5260
65 km/h				3000	3195	3390	3585	3780	3970	4165	4360	4555	4750
80 km/h					2325	2470	2620	2765	2915	3060	3205	3355	3500







Ø inches	Description	CAI	e mm	D mm	R' mm	RC mm	Recommended Rim		Acceptable Rim		Tube (Code)	75% internal volume (litres)	Tread depth (mm)
20.5	24R20.5 176F TL	109174	602	1374	584	4148	18.00				20.5 WAMD	404	17
Bar	1.5	1.8	2	2.2	2.4	2.6	2.8	3	3.2	3.4	3.6	3.8	4
Psi	22	26	29	32	35	38	41	44	46	49	52	55	58
30 km/h	3800	4400	4800	5200	5600	6100	6705	7310	7550	7785	8025	8260	8500
40 km/h	3650	4230	4615	5000	5385	5860	6415	6970	7215	7460	7705	7950	8195
50 km/h	3505	4060	4435	4805	5175	5615	6120	6625	6880	7130	7385	7635	7890
65 km/h				4350	4645	4940	5235	5530	5820	6115	6410	6705	7000
80 km/h					3325	3535	3745	3955	4165	4370	4580	4790	5000

***IMPORTANT:**

The inflation pressure must always be appropriate for the load per tire, the speed of travel and the work to be done. Our recommendations above are provided subject to changes made after the date of publication of these tables. Technical data is subject to change without prior notice.

- For use on side slopes: add 0.4 bar.
- For heavy road use: add 0.4 bar.

RANGES BY USES

MACHINES / TIRES	TECHNOLOGY								
	RADIAL								BIAS
	XMCL / XM27	BIBLOAD HS	CROSSGRIP	BIBSTEEL HS	BIBSTEEL AT	TWEEL HS	TWEEL AT	XF	POWER CL
 Backhoe loaders	X	X	X						X
 Compact wheeled loaders	X	X	X						X
 Telehandlers	X	X	X	X	X			X	X
 Wheeled excavators								X	
 Skid steers				X	X	X	X		
 Tractors	X	X	X						X

EQUIVALENT SIZES

EQUIVALENT SIZES				MICHELIN COMPACT LINE									
Rims	Pouces	Metric 1	Metric 2	XMCL XM27	BIBLOAD Hard Surface	CROSSGRIP	XM47	POWER CL	BIBSTEEL Hard Surface	BIBSTEEL All Terrain	TWEEL Hard Surface	TWEEL All Terrain	XF
15	27x8.5 R 15	210/70 R 15	215/70 R 15							X			
	7.5 R 16	250/80 R 16				X							
16	11 LR 16			X									
16,5	10 R 16.5	260/70 R 16.5	265/70 R 16.5						X	X	X		
	12 R 16.5	300/70 R 16.5	305/70 R 16.5						X	X	X	X	
17,5	14 R 17.5	360/70 R 17.5								X			
18	10.5/80 R 18	280/80 R 18		X				X					
	12.5/80 R 18	340/80 R 18	335/80 R 18	X	X	X		X					
		400/70 R 18	405/70 R 18	X	X								
19,5	18 R 19.5	445/70 R 19.5											X
20	10.5/80 R 20	280/80 R 20	335/80 R 20	X				X					
	12.5/80 R 20	340/80 R 20		X	X			X					
	14.5 R 20	380/75 R 20	375/75 R 20	X									
	16.0/70 R 20	400/70 R 20	405/70 R 20	X	X		X	X					
	16.5/75 R 20	420/75 R 20	425/75 R 20	X			X						
22,5	18 R 22.5	445/70 R 22.5											X
24		360/80 R 24				X							
	16.0/70 R 24	400/70 R 24		X				X					
	15.5/80 R 24	400/80 R 24				X		X					
	16.9 R 24	440/80 R 24		X	X	X		X					
	17.5 LR 24	460/70 R 24	445/70 R 24	X	X	X	X	X					
	19.5 LR 24	500/70 R 24	495/70 R 24	X	X	X	X	X					
	21 LR 24	540/70 R 24		X	X								
26	18.4 R 26	480/80 R 26		X	X			X					
28		400/80 R 28				X							
	16.9 R 28	440/80 R 28		X	X	X		X					
30	16.9 R 30	420/80 R 30						X					
34		440/80 R 34				X							
		480/80 R 34				X							
38		480/80 R 38				X							

EQUIVALENT SIZES

DIMENSIONAL EQUIVALENCES FOR COMPACT LINE RANGE TIRES

Any change in tire size must be approved by the vehicle manufacturer. For 4-wheel drive vehicles, the «axle ratio» and the preponderance calculation must be taken into account. Always make sure that the selected tire will be able to carry the maximum load of the vehicle at its maximum speed.

Check that the tire you have chosen is compatible with the rim width and seat diameter. The information given in this table is purely indicative, any modification of a vehicle is carried out under the responsibility of the customer. In no case, the equivalence of a tire corresponds exactly to a given profile or size.



MICHELIN XMCL

**EXCEPTIONALLY RESISTANT
TO CUTS & EXCELLENT
TRACTION EVEN IN WET
& DIFFICULT CONDITIONS**



RADIAL Tire

- up to 46% more service life vs MICHELIN Bias tire



TRACTION

- Effectiveness on soft ground



PRODUCTIVITY

- Reinforced sidewall & metal top plies for puncture resistance



COMFORT

- Smoother ride



STABILITY

- Safety guaranteed



Backhoe loaders



Compact Wheel Loaders



Telehandlers

SIZES

11LR16 122A8 TL

280/80R18 IND 132A8/132B TL

340/80R18 IND 143A8/143B TL

400/70R18 IND 147A8/147B TL

280/80R20 IND 133A8/133B TL

340/80R20 IND 144A8/144B TL

400/70R20 IND 149A8/149B TL

380/75R20 IND 148A8/148B TL

420/75R20 IND 154A8/154B TL

400/70R24 IND 152A8/152B TL

460/70R24 IND 159A8/159B TL

500/70R24 IND 164A8/164B TL

440/80R24 IND 161A8/161B TL

540/70R24 IND 168A8/168B TL

480/80R26 IND 167A8/167B TL

440/80R28 IND 156A8/156B TL

MICHELIN XMCL

Tire specifications and pressure table (bar & psi). Load per tire in kg*

Ø inches	Description	CAI	e mm	D mm	R' mm	RC mm	Recommended Rim	Acceptable Rim	Tube (Code)	75% internal volume (litres)	Tread depth (mm)
16	11LR16 122A8 TL <i>XM27</i>	123207	291	850	375	2515	W8	W10L	184	60	23
Bar	1.2	1.6	2	2.2	2.4	2.6					
Psi	17	23	29	32	35	38					
10 km/h	1265	1530	1790	1920	2055	2185					
30 km/h	940	1165	1385	1500	1610						
40 km/h	880	1085	1295	1395	1500						

Ø inches	Description	CAI	e mm	D mm	R' mm	RC mm	Recommended Rim	Acceptable Rim	Tube (Code)	75% internal volume (litres)	Tread depth (mm)			
18	280/80R18 IND 132A8/132B TL <i>10.5 R18 (Equiv 10PR)</i>	779803	290	908	415	2708	W9	W10 W8	438	68	28			
Bar	1.6	2	2.2	2.4	2.6	2.8	3	3.2	3.4	3.6	3.8	4	4.2	4.4
Psi	23	29	32	35	38	41	44	46	49	52	55	58	61	64
Stat	1800	2200	2400	2600	2800	3000	3200	3400	3600	3800	4000	4200	4400	4600
10 km/h Cyc	1170	1430	1565	1695	1825	1955	2085	2220	2350	2480	2610	2740	2870	3000
25 km/h	1060	1255	1350	1445	1540	1635	1735	1830	1930	2025	2125	2220		
30 km/h	1020	1210	1300	1395	1490	1585	1675	1770	1865	1955	2050	2140		
40 km/h	950	1125	1215	1300	1390	1475	1565	1650	1740	1825	1915	2000		
50 km/h	950	1125	1215	1300	1390	1475	1565	1650	1740	1825	1915	2000		

Ø inches	Description	CAI	e mm	D mm	R' mm	RC mm	Recommended Rim	Acceptable Rim	Tube (Code)	75% internal volume (litres)	Tread depth (mm)			
18	340/80R18 IND 143A8/143B TL <i>12.5 R18 (Equiv 12PR)</i>	100054	351	996	448	2959	11	W10 W11 12 11SDC 12SDC	444 828	107	31			
Bar	1.6	2	2.2	2.4	2.6	2.8	3	3.2	3.4	3.6	3.8	4	4.2	4.4
Psi	23	29	32	35	38	41	44	46	49	52	55	58	61	64
Stat	2450	2995	3270	3540	3815	4090	4360	4635	4905	5180	5455	5725	6000	6270
10 km/h Cyc	1600	1955	2135	2310	2490	2670	2845	3025	3200	3380	3555	3735	3915	4090
25 km/h	1450	1715	1845	1975	2105	2240	2370	2500	2630	2760	2890	3020		
30 km/h	1390	1645	1775	1900	2030	2155	2285	2410	2540	2665	2795	2920		
40 km/h	1320	1550	1665	1780	1895	2010	2125	2240	2360	2485	2605	2725		
50 km/h	1320	1550	1665	1780	1895	2010	2125	2240	2360	2485	2605	2725		

* Refer to the notes at the end of the tables of this range

MICHELIN XMCL

Tire specifications and pressure table (bar & psi). Load per tire in kg*

Ø inches	Description	CAI	e mm	D mm	R' mm	RC mm	Recommended Rim		Acceptable Rim	Tube (Code)	75% internal volume (litres)	Tread depth (mm)			
18	400/70R18 IND 147A8/147B TL <i>405/70 R18</i>	133035	404	1013	454	3008	13		12 13.00 12SDC W13		129	31			
	Bar	1.6	2	2.2	2.4	2.6	2.8	3	3.2	3.4	3.6	3.8	4	4.2	4.4
	Psi	23	29	32	35	38	41	44	46	49	52	55	58	61	64
	Stat	2800	3400	3700	4000	4300	4600	4930	5265	5595	5925	6215	6500	6790	7075
	10 km/h Cyc	1825	2215	2415	2610	2805	3000	3215	3435	3650	3865	4050	4240	4430	4615
	25 km/h	1670	1945	2085	2220	2380	2540	2700	2860	3000	3140	3275	3415		
	30 km/h	1605	1875	2005	2140	2295	2450	2600	2755	2890	3025	3155	3290		
	40 km/h	1500	1750	1875	2000	2145	2290	2430	2575	2700	2825	2950	3075		
	50 km/h	1500	1750	1875	2000	2145	2290	2430	2575	2700	2825	2950	3075		

Ø inches	Description	CAI	e mm	D mm	R' mm	RC mm	Recommended Rim		Acceptable Rim	Tube (Code)	75% internal volume (litres)	Tread depth (mm)			
20	280/80R20 IND 133A8/133B TL <i>10.5 R20 (Equiv 10PR)</i>	747442	292	958	439	2860	W9		W8 W10	542	73	31			
	Bar	1.6	2	2.2	2.4	2.6	2.8	3	3.2	3.4	3.6	3.8	4	4.2	4.4
	Psi	23	29	32	35	38	41	44	46	49	52	55	58	61	64
	Stat	1850	2260	2470	2675	2880	3085	3290	3500	3705	3910	4120	4325	4535	4740
	10 km/h Cyc	1210	1480	1610	1745	1880	2015	2150	2280	2415	2550	2685	2820	2955	3090
	25 km/h	1090	1290	1390	1490	1590	1690	1790	1890	1990	2090	2190	2290		
	30 km/h	1050	1245	1340	1435	1530	1625	1725	1820	1915	2010	2105	2200		
	40 km/h	975	1155	1245	1340	1430	1520	1610	1700	1790	1880	1970	2060		
	50 km/h	975	1155	1245	1340	1430	1520	1610	1700	1790	1880	1970	2060		

Ø inches	Description	CAI	e mm	D mm	R' mm	RC mm	Recommended Rim		Acceptable Rim	Tube (Code)	75% internal volume (litres)	Tread depth (mm)			
20	340/80R20 IND 144A8/144B TL <i>12.5 R20 (Equiv 12PR)</i>	948730	353	1047	476	3119	11		W10 W11 12 11SDC 12SDC	664 444	114	31			
	Bar	1.6	2	2.2	2.4	2.6	2.8	3	3.2	3.4	3.6	3.8	4	4.2	4.4
	Psi	23	29	32	35	38	41	44	46	49	52	55	58	61	64
	Stat	2520	3080	3360	3640	3920	4200	4480	4760	5040	5320	5600	5880	6160	6440
	10 km/h Cyc	1640	2005	2190	2370	2555	2740	2920	3105	3285	3470	3650	3835	4020	4200
	25 km/h	1490	1760	1895	2030	2165	2300	2435	2570	2705	2840	2975	3110		
	30 km/h	1430	1690	1820	1950	2080	2210	2340	2470	2605	2735	2870	3000		
	40 km/h	1360	1595	1715	1830	1950	2065	2185	2300	2425	2550	2675	2800		
	50 km/h	1360	1595	1715	1830	1950	2065	2185	2300	2425	2550	2675	2800		

* Refer to the notes at the end of the tables of this range

MICHELIN XMCL

Tire specifications and pressure table (bar & psi). Load per tire in kg*

Ø inches	Description	CAI	e mm	D mm	R' mm	RC mm	Recommended Rim		Acceptable Rim	Tube (Code)	75% internal volume (litres)	Tread depth (mm)				
20	400/70R20 IND 149A8/149B TL <i>16.0/70 R20 (Equiv 16PR)</i>	474495	412	1069	481	3177	W13		13 14 12 12SDC 13SDC DW13	664	140	33				
		Bar	1.6	2	2.2	2.4	2.6	2.8	3	3.2	3.4	3.6	3.8	4	4.2	4.4
		Psi	23	29	32	35	38	41	44	46	49	52	55	58	61	64
		Stat	2930	3580	3905	4230	4555	4880	5205	5530	5855	6180	6505	6830	7155	7480
		10 km/h Cyc	1910	2335	2545	2760	2970	3180	3395	3605	3820	4030	4245	4455	4670	4880
		25 km/h	1730	2045	2200	2355	2510	2670	2825	2980	3140	3295	3455	3610		
		30 km/h	1660	1965	2115	2265	2415	2570	2720	2870	3025	3175	3330	3480		
		40 km/h	1550	1825	1965	2100	2240	2375	2515	2650	2800	2950	3100	3250		
		50 km/h	1550	1825	1965	2100	2240	2375	2515	2650	2800	2950	3100	3250		

Ø inches	Description	CAI	e mm	D mm	R' mm	RC mm	Recommended Rim		Acceptable Rim	Tube (Code)	75% internal volume (litres)	Tread depth (mm)				
20	380/75R20 IND 148A8/148B TL <i>14.5 R20 (Equiv 12PR)</i>	187752	384	1070	481	3180	W12		11 W11 12	664	136	33				
		Bar	1.6	2	2.2	2.4	2.6	2.8	3	3.2	3.4	3.6	3.8	4	4.2	4.4
		Psi	23	29	32	35	38	41	44	46	49	52	55	58	61	64
		Stat	2840	3470	3785	4100	4415	4730	5045	5360	5675	5990	6305	6620	6935	7250
		10 km/h Cyc	1850	2260	2465	2670	2875	3080	3285	3490	3695	3900	4110	4315	4525	4730
		25 km/h	1670	1975	2130	2280	2435	2585	2740	2890	3045	3195	3350	3500		
		30 km/h	1610	1905	2050	2195	2340	2490	2635	2780	2930	3075	3225	3370		
		40 km/h	1500	1770	1905	2040	2170	2305	2440	2575	2720	2865	3005	3150		
		50 km/h	1500	1770	1905	2040	2170	2305	2440	2575	2720	2865	3005	3150		

Ø inches	Description	CAI	e mm	D mm	R' mm	RC mm	Recommended Rim		Acceptable Rim	Tube (Code)	75% internal volume (litres)	Tread depth (mm)				
20	420/75R20 IND 154A8/154B TL <i>16.5/75 R20 (Equiv 18PR)</i>	967201	428	1138	509	3378	13		14 12 12SDC 13SDC	664	172	33				
		Bar	1.6	2	2.2	2.4	2.6	2.8	3	3.2	3.4	3.6	3.8	4	4.2	4.4
		Psi	23	29	32	35	38	41	44	46	49	52	55	58	61	64
		Stat	3380	4130	4505	4880	5255	5630	6005	6380	6755	7130	7505	7880	8255	8630
		10 km/h Cyc	2200	2690	2935	3180	3425	3670	3915	4160	4405	4650	4895	5140	5385	5630
		25 km/h	1990	2355	2535	2715	2895	3080	3260	3440	3620	3800	3980	4160		
		30 km/h	1920	2270	2440	2615	2790	2965	3135	3310	3485	3660	3835	4010		
		40 km/h	1800	2120	2280	2440	2595	2755	2915	3075	3245	3415	3580	3750		
		50 km/h	1800	2120	2280	2440	2595	2755	2915	3075	3245	3415	3580	3750		

* Refer to the notes at the end of the tables of this range

MICHELIN XMCL

Tire specifications and pressure table (bar & psi). Load per tire in kg*

Ø inches	Description	CAI	e mm	D mm	R' mm	RC mm	Recommended Rim		Acceptable Rim		Tube (Code)	75% internal volume (litres)	Tread depth (mm)														
24	400/70R24 IND 152A8/152B TL <i>16.0/70 R24 (Equiv 16PR)</i>	178690	401	1170	531	3485	3	3.2	3.4	13 DW13 DW14L 13SDC DW12	703	157	33														
	Bar													1.6	2	2.2	2.4	2.6	2.8	3	3.2	3.4	3.6	3.8	4	4.2	4.4
	Psi													23	29	32	35	38	41	44	46	49	52	55	58	61	64
	Stat													3130	3840	4190	4545	4900	5255	5610	5960	6315	6670	7045	7420	7790	8165
	10 km/h Cyc													2040	2500	2735	2965	3195	3425	3655	3890	4120	4350	4595	4840	5080	5325
	25 km/h													1830	2180	2350	2525	2700	2875	3045	3220	3400	3580	3760	3940		
	30 km/h													1765	2100	2270	2435	2605	2770	2940	3105	3280	3455	3625	3800		
	40 km/h													1650	1965	2120	2275	2430	2590	2745	2900	3065	3225	3390	3550		
	50 km/h													1650	1965	2120	2275	2430	2590	2745	2900	3065	3225	3390	3550		

Ø inches	Description	CAI	e mm	D mm	R' mm	RC mm	Recommended Rim		Acceptable Rim		Tube (Code)	75% internal volume (litres)	Tread depth (mm)														
24	460/70R24 IND 159A8/159B TL <i>17.5 LR24 (Equiv 18PR)</i>	244268	467	1248	562	3709	3	3.2	3.4	14 DW14L TW14L DW16L 16	710	218	36														
	Bar													1.6	2	2.2	2.4	2.6	2.8	3	3.2	3.4	3.6	3.8	4	4.2	4.4
	Psi													23	29	32	35	38	41	44	46	49	52	55	58	61	64
	Stat													3940	4815	5250	5690	6125	6560	7000	7435	7875	8310	8750	9185	9625	10060
	10 km/h Cyc													2570	3140	3425	3710	3995	4280	4565	4850	5135	5420	5705	5990	6275	6560
	25 km/h													2320	2745	2955	3165	3375	3585	3800	4010	4225	4435	4650	4860		
	30 km/h													2240	2650	2850	3055	3260	3460	3665	3870	4075	4275	4480	4680		
	40 km/h													2120	2505	2695	2885	3075	3270	3460	3650	3830	4015	4195	4375		
	50 km/h													2120	2505	2695	2885	3075	3270	3460	3650	3830	4015	4195	4375		

Ø inches	Description	CAI	e mm	D mm	R' mm	RC mm	Recommended Rim		Acceptable Rim		Tube (Code)	75% internal volume (litres)	Tread depth (mm)															
24	500/70R24 IND 164A8/164B TL <i>19.5 LR24 (Equiv 20PR)</i>	542794	511	1302	583	3866	3	3.2	3.4	DW16L	DW15L 16	710	266	36														
	Bar														1.6	2	2.2	2.4	2.6	2.8	3	3.2	3.4	3.6	3.8	4	4.2	4.4
	Psi														23	29	32	35	38	41	44	46	49	52	55	58	61	64
	Stat														4500	5500	6000	6500	7000	7500	8000	8500	9000	9500	10000	10500	11000	11500
	10 km/h Cyc														2930	3585	3910	4240	4565	4890	5220	5545	5875	6200	6525	6850	7175	7500
	25 km/h														2650	3135	3375	3615	3855	4100	4340	4580	4825	5065	5310	5550		
	30 km/h														2560	3025	3260	3490	3725	3955	4190	4420	4655	4885	5120	5350		
	40 km/h														2360	2800	3020	3245	3465	3685	3905	4125	4345	4565	4780	5000		
	50 km/h														2360	2800	3020	3245	3465	3685	3905	4125	4345	4565	4780	5000		

* Refer to the notes at the end of the tables of this range

MICHELIN XMCL

Tire specifications and pressure table (bar & psi). Load per tire in kg*

Ø inches	Description	CAI	e mm	D mm	R' mm	RC mm	Recommended Rim	Acceptable Rim	Tube (Code)	75% internal volume (litres)	Tread depth (mm)
24	440/80R24 IND 161A8/161B TL 16.9 R24 (Equiv 18PR)	954749	441	1314	592	3907	DW14L	14 TW14L DW15L	710	236	36
Bar	1.6 2 2.2 2.4 2.6 2.8 3 3.2 3.4 3.6 3.8 4 4.2 4.4										
Psi	23 29 32 35 38 41 44 46 49 52 55 58 61 64										
Stat	4160 5085 5550 6010 6475 6940 7400 7865 8325 8790 9255 9715 10180 10640										
10 km/h Cyc	2710 3315 3615 3920 4240 4520 4825 5125 5430 5730 6030 6335 6640 6940										
25 km/h	2460 2905 3130 3350 3575 3795 4020 4240 4465 4685 4910 5130										
30 km/h	2370 2800 3015 3230 3445 3660 3875 4090 4305 4520 4735 4950										
40 km/h	2240 2650 2855 3060 3260 3465 3670 3875 4065 4250 4440 4625										
50 km/h	2240 2650 2855 3060 3260 3465 3670 3875 4065 4250 4440 4625										

Ø inches	Description	CAI	e mm	D mm	R' mm	RC mm	Recommended Rim	Acceptable Rim	Tube (Code)	75% internal volume (litres)	Tread depth (mm)
24	540/70R24 IND 168A8/168B TL 21 LR24 (Equiv 20PR)	959128	562	1356	608	4026	DW18L	DW16L	710	317	36
Bar	1.6 2 2.2 2.4 2.6 2.8 3 3.2 3.4 3.6 3.8 4 4.2 4.4										
Psi	23 29 32 35 38 41 44 46 49 52 55 58 61 64										
Stat	5015 5910 6360 6805 7255 7700 8150 8595 9045 9490 10335 11185 12035 12880										
10 km/h Cyc	3270 3855 4145 4440 4730 5020 5315 5605 5900 6190 6740 7295 7850 8400										
25 km/h	2940 3490 3765 4040 4310 4585 4860 5135 5405 5680 5950 6220										
30 km/h	2840 3370 3630 3895 4160 4425 4685 4950 5215 5475 5740 6000										
40 km/h	2650 3145 3390 3640 3885 4130 4380 4625 4870 5115 5355 5600										
50 km/h	2650 3145 3390 3640 3885 4130 4380 4625 4870 5115 5355 5600										

Ø inches	Description	CAI	e mm	D mm	R' mm	RC mm	Recommended Rim	Acceptable Rim	Tube (Code)	75% internal volume (litres)	Tread depth (mm)
26	480/80R26 IND 167A8/167B TL 18.4 R26 (Equiv 20PR)	425979	495	1422	636	4218	DW15L	DW16L	716	302	36
Bar	1.6 2 2.2 2.4 2.6 2.8 3 3.2 3.4 3.6 3.8 4 4.2 4.4										
Psi	23 29 32 35 38 41 44 46 49 52 55 58 61 64										
Stat	4900 5990 6535 7080 7625 8170 8715 9260 9805 10350 10895 11445 11990 12535										
10 km/h Cyc	3200 3910 4265 4620 4975 5330 5685 6040 6395 6750 7460 8175										
25 km/h	2890 3420 3680 3945 4210 4475 4735 5000 5265 5525 5790 6050										
30 km/h	2790 3300 3550 3805 4060 4315 4565 4820 5075 5330 5580 5835										
40 km/h	2575 3055 3295 3540 3780 4020 4260 4500 4740 4975 5215 5450										
50 km/h	2575 3055 3295 3540 3780 4020 4260 4500 4740 4975 5215 5450										

* Refer to the notes at the end of the tables of this range

MICHELIN XMCL

Tire specifications and pressure table (bar & psi). Load per tire in kg*

Ø inches	Description	CAI	e mm	D mm	R' mm	RC mm	Recommended Rim		Acceptable Rim	Tube (Code)	75% internal volume (litres)	Tread depth (mm)
28	440/80R28 IND 156A8/156B TL <i>16.9 R28 (Equiv 18PR)</i>	316223	459	1410	641	4200	DW14L		DW15L	822	260	36
Bar	1.6	2	2.2	2.4	2.6	2.8	3	3.2	3.4	3.6		
Psi	23	29	32	35	38	41	44	46	49	52		
Stat	4360	5330	5810	6295	6780	7265	7750	8230	8715	9200		
10 km/h Cyc	2840	3470	3790	4105	4420	4735	5050	5370	5685	6000		
25 km/h	2570	3040	3270	3505	3740	3970	4205	4440				
30 km/h	2480	2930	3155	3380	3605	3830	4055	4280				
40 km/h	2300	2725	2940	3150	3365	3575	3790	4000				
50 km/h	2300	2725	2940	3150	3365	3575	3790	4000				

***IMPORTANT:**

The inflation pressure must always be appropriate for the load per tire, the speed of travel and the work to be done. Our recommendations above are provided subject to changes made after the date of publication of these tables. Technical data is subject to change without prior notice.

- For use on side slopes: add 0.4 bar.
- For intense road use, add 0.4 bar.
- Stat: static load.
- 10 km/h Cyc: max. speed 10 km/h with cyclic load.



MICHELIN BIBLOAD HARD SURFACE

BETTER DURABILITY
& RIDE QUALITY



RADIAL Tire



HARD SURFACE TRACTION

- +30% footprint vs XMCL



PRODUCTIVITY

- Metal top plies for puncture resistance



STABILITY

- Excellent stability on slopes
& same quality comfort as XMCL
- Great ride quality



Backhoe loaders



Compact Wheel Loaders



Telehandlers

SIZES

340/80R18 IND 143A8/143B TL	500/70R24 IND 164A8/164B TL
400/70R18 IND 147A8/147B TL	540/70R24 IND 168A8/168B TL
340/80R20 IND 144A8/144B TL	480/80R26 IND 167A8/167B TL
400/70R20 IND 149A8/149B TL	440/80R28 IND 163A8/163B TL
460/70R24 IND 159A8/159B TL	
440/80R24 IND 161A8/161B TL	

MICHELIN BIBLOAD HARD SURFACE

Tire specifications and pressure table (bar & psi). Load per tire in kg*

Ø inches	Description	CAI	e mm	D mm	R' mm	RC mm	Recommended Rim		Acceptable Rim		Tube (Code)	75% internal volume (litres)	Tread depth (mm)				
18	340/80R18 IND 143A8/143B TL <i>12.5 R18 (Equiv 12PR)</i>	415829	342	990	448	2946	W11		W10 11 12 11SDC 12SDC		828 444	107	28				
		Bar	1.6	1.8	2	2.2	2.4	2.6	2.8	3	3.2	3.4	3.6	3.8	4	4.2	4.4
		Psi	23	26	29	32	35	38	41	44	46	49	52	55	58	61	64
		Stat	2450	2725	2995	3270	3540	3815	4090	4360	4635	4905	5180	5455	5725	6000	6270
		10 km/h Cyc	1600	1780	1955	2135	2310	2490	2670	2845	3025	3200	3380	3555	3735	3915	4090
		25 km/h	1450	1580	1715	1845	1975	2105	2240	2370	2500	2630	2760	2890	3020		
		30 km/h	1390	1520	1645	1775	1900	2030	2155	2285	2410	2540	2665	2795	2920		
		40 km/h	1320	1435	1550	1665	1780	1895	2010	2125	2240	2360	2485	2605	2725		
		50 km/h	1320	1435	1550	1665	1780	1895	2010	2125	2240	2360	2485	2605	2725		

Ø inches	Description	CAI	e mm	D mm	R' mm	RC mm	Recommended Rim		Acceptable Rim		Tube (Code)	75% internal volume (litres)	Tread depth (mm)				
18	400/70R18 IND 147A8/147B TL <i>405/70 R18 (Equiv 14PR)</i>	239365	397	1006	448	2983	13		12 13.00 12SDC			129	29				
		Bar	1.6	1.8	2	2.2	2.4	2.6	2.8	3	3.2	3.4	3.6	3.8	4	4.2	4.4
		Psi	23	26	29	32	35	38	41	44	46	49	52	55	58	61	64
		Stat	2800	3100	3400	3700	4000	4300	4600	4930	5265	5595	5925	6215	6500	6790	7075
		10 km/h Cyc	1825	2020	2215	2415	2610	2805	3000	3215	3435	3650	3865	4050	4240	4430	4615
		25 km/h	1670	1810	1945	2085	2220	2380	2540	2700	2860	3000	3140	3275	3415		
		30 km/h	1605	1740	1875	2005	2140	2295	2450	2600	2755	2890	3025	3155	3290		
		40 km/h	1500	1625	1750	1875	2000	2145	2290	2430	2575	2700	2825	2950	3075		
		50 km/h	1500	1625	1750	1875	2000	2145	2290	2430	2575	2700	2825	2950	3075		

Ø inches	Description	CAI	e mm	D mm	R' mm	RC mm	Recommended Rim		Acceptable Rim		Tube (Code)	75% internal volume (litres)	Tread depth (mm)				
20	340/80R20 IND 144A8/144B TL <i>12.5 R20 (Equiv 12PR)</i>	991253	346	1041	473	3100	11		W10 W11 12 11SDC 12SDC		664 444	114	28				
		Bar	1.6	1.8	2	2.2	2.4	2.6	2.8	3	3.2	3.4	3.6	3.8	4	4.2	4.4
		Psi	23	26	29	32	35	38	41	44	46	49	52	55	58	61	64
		Stat	2520	2800	3080	3360	3640	3920	4200	4480	4760	5040	5320	5600	5880	6160	6440
		10 km/h Cyc	1640	1825	2005	2190	2370	2555	2740	2920	3105	3285	3470	3650	3835	4020	4200
		25 km/h	1490	1625	1760	1895	2030	2165	2300	2435	2570	2705	2840	2975	3110		
		30 km/h	1430	1560	1690	1820	1950	2080	2210	2340	2470	2605	2735	2870	3000		
		40 km/h	1360	1480	1595	1715	1830	1950	2065	2185	2300	2425	2550	2675	2800		
		50 km/h	1360	1480	1595	1715	1830	1950	2065	2185	2300	2425	2550	2675	2800		

* Refer to the notes at the end of the tables of this range

MICHELIN BIBLOAD HARD SURFACE

Tire specifications and pressure table (bar & psi). Load per tire in kg*

Ø inches	Description	CAI	e mm	D mm	R' mm	RC mm	Recommended Rim	Acceptable Rim	Tube (Code)	75% internal volume (litres)	Tread depth (mm)				
20	400/70R20 IND 149A8/149B TL 16.0/70 R20 (Equiv 16PR)	793611	403	1068	480	3174	W13	13 14 12 12SDC 13SDC DW13	664	140	29				
Bar	1.6	1.8	2	2.2	2.4	2.6	2.8	3	3.2	3.4	3.6	3.8	4	4.2	4.4
Psi	23	26	29	32	35	38	41	44	46	49	52	55	58	61	64
Stat	2930	3255	3580	3905	4230	4555	4880	5205	5530	5855	6180	6505	6830	7155	7480
10 km/h Cyc	1910	2120	2335	2545	2760	2970	3180	3395	3605	3820	4030	4245	4455	4670	4880
25 km/h	1730	1885	2045	2200	2355	2510	2670	2825	2980	3140	3295	3455	3610		
30 km/h	1660	1810	1965	2115	2265	2415	2570	2720	2870	3025	3175	3330	3480		
40 km/h	1550	1690	1825	1965	2100	2240	2375	2515	2650	2800	2950	3100	3250		
50 km/h	1550	1690	1825	1965	2100	2240	2375	2515	2650	2800	2950	3100	3250		

Ø inches	Description	CAI	e mm	D mm	R' mm	RC mm	Recommended Rim	Acceptable Rim	Tube (Code)	75% internal volume (litres)	Tread depth (mm)				
24	460/70R24 IND 159A8/159B TL 17.5 LR24 (Equiv 18PR)	372690	467	1241	558	3688	DW15L	14 DW14L DW16L 16	710	218	33				
Bar	1.6	1.8	2	2.2	2.4	2.6	2.8	3	3.2	3.4	3.6	3.8	4	4.2	4.4
Psi	23	26	29	32	35	38	41	44	46	49	52	55	58	61	64
Stat	3940	4375	4815	5250	5690	6125	6560	7000	7435	7875	8310	8750	9185	9625	10060
10 km/h Cyc	2570	2855	3140	3425	3710	3995	4280	4565	4850	5135	5420	5705	5990	6275	6560
25 km/h	2320	2530	2745	2955	3165	3375	3585	3800	4010	4225	4435	4650	4860		
30 km/h	2240	2445	2650	2850	3055	3260	3460	3665	3870	4075	4275	4480	4680		
40 km/h	2120	2310	2505	2695	2885	3075	3270	3460	3650	3830	4015	4195	4375		
50 km/h	2120	2310	2505	2695	2885	3075	3270	3460	3650	3830	4015	4195	4375		

Ø inches	Description	CAI	e mm	D mm	R' mm	RC mm	Recommended Rim	Acceptable Rim	Tube (Code)	75% internal volume (litres)	Tread depth (mm)				
24	440/80R24 IND 161A8/161B TL 16.9 R24 (Equiv 18PR)	814805	448	1299	584	3860	DW14L	14 DW15L	710	234	32				
Bar	1.6	1.8	2	2.2	2.4	2.6	2.8	3	3.2	3.4	3.6	3.8	4	4.2	4.4
Psi	23	26	29	32	35	38	41	44	46	49	52	55	58	61	64
Stat	4255	4720	5185	5650	6115	6585	7050	7515	7980	8445	8910	9345	9775	10210	10640
10 km/h Cyc	2775	3080	3380	3685	3990	4295	4595	4900	5205	5505	5810	6095	6375	6660	6940
25 km/h	2500	2720	2935	3155	3370	3590	3805	4025	4240	4475	4705	4940	5170		
30 km/h	2390	2630	2865	3105	3340	3580	3815	4055	4290	4485	4680	4875	5070		
40 km/h	2180	2375	2575	2770	2965	3160	3355	3555	3750	3970	4190	4405	4625		
50 km/h	2180	2375	2575	2770	2965	3160	3355	3555	3750	3970	4190	4405	4625		

* Refer to the notes at the end of the tables of this range

MICHELIN BIBLOAD HARD SURFACE

Tire specifications and pressure table (bar & psi). Load per tire in kg*

Ø inches	Description	CAI	e mm	D mm	R' mm	RC mm	Recommended Rim	Acceptable Rim	Tube (Code)	75% internal volume (litres)	Tread depth (mm)		
24	500/70R24 IND 164A8/1648 TL <i>19.4 LR24 (Equip 20PR)</i>	346709	499	1299	594	3874	DW16L	DW15L 16	710	266	32		
Bar	1.6 1.8 2	2.2	2.4	2.6	2.8	3	3.2	3.4	3.6	3.8	4	4.2	4.4
Psi	23 26 29	32	35	38	41	44	46	49	52	55	58	61	64
Stat	4500 5000 5500	6000	6500	7000	7500	8000	8500	9000	9500	10000	10500	11000	11500
10 km/h Cyc	2930 3255 3585	3910	4240	4565	4890	5220	5545	5875	6200	6525	6850	7175	7500
25 km/h	2650 2890 3135	3375	3615	3855	4100	4340	4580	4825	5065	5310	5550		
30 km/h	2560 2795 3025	3260	3490	3725	3955	4190	4420	4655	4885	5120	5350		
40 km/h	2360 2580 2800	3020	3245	3465	3685	3905	4125	4345	4565	4780	5000		
50 km/h	2360 2580 2800	3020	3245	3465	3685	3905	4125	4345	4565	4780	5000		

Ø inches	Description	CAI	e mm	D mm	R' mm	RC mm	Recommended Rim	Acceptable Rim	Tube (Code)	75% internal volume (litres)	Tread depth (mm)		
24	540/70R24 IND 168A8/1688 TL <i>21 LR24 (Equip 20PR)</i>	005412	567	1341	600	3981	DW18L	DW16L	710	317	33		
Bar	1.6 1.8 2	2.2	2.4	2.6	2.8	3	3.2	3.4	3.6	3.8	4	4.2	4.4
Psi	23 26 29	32	35	38	41	44	46	49	52	55	58	61	64
Stat	5015 5465 5910	6360	6805	7255	7700	8150	8595	9045	9490	10335	11185	12035	12880
10 km/h Cyc	3270 3560 3855	4145	4440	4730	5020	5315	5605	5900	6190	6740	7295	7850	8400
25 km/h	2940 3215 3490	3765	4040	4310	4585	4860	5135	5405	5680	5950	6220		
30 km/h	2840 3105 3370	3630	3895	4160	4425	4685	4950	5215	5475	5740	6000		
40 km/h	2650 2895 3145	3390	3640	3885	4130	4380	4625	4870	5115	5355	5600		
50 km/h	2650 2895 3145	3390	3640	3885	4130	4380	4625	4870	5115	5355	5600		

Ø inches	Description	CAI	e mm	D mm	R' mm	RC mm	Recommended Rim	Acceptable Rim	Tube (Code)	75% internal volume (litres)	Tread depth (mm)		
26	480/80R26 IND 167A8/1678 TL <i>18.4 R26 (Equip 20PR)</i>	886709	509	1419	637	4215	DW15L	DW16L	716	304	33		
Bar	1.6 1.8 2	2.2	2.4	2.6	2.8	3	3.2	3.4	3.6	3.8	4	4.2	4.4
Psi	23 26 29	32	35	38	41	44	46	49	52	55	58	61	64
Stat	4900 5445 5990	6535	7080	7625	8170	8715	9260	9805	10350	10895	11445	11990	12535
10 km/h Cyc	3200 3555 3910	4265	4620	4975	5330	5685	6040	6395	6750	7460	8175		
25 km/h	2890 3155 3420	3680	3945	4210	4475	4735	5000	5265	5525	5790	6050		
30 km/h	2790 3045 3300	3550	3805	4060	4315	4565	4820	5075	5330	5580	5835		
40 km/h	2575 2815 3055	3295	3540	3780	4020	4260	4500	4740	4975	5215	5450		
50 km/h	2575 2815 3055	3295	3540	3780	4020	4260	4500	4740	4975	5215	5450		

* Refer to the notes at the end of the tables of this range

MICHELIN BIBLOAD HARD SURFACE

Tire specifications and pressure table (bar & psi). Load per tire in kg*

Ø inches	Description	CAI	e mm	D mm	R' mm	RC mm	Recommended Rim		Acceptable Rim		Tube (Code)	75% internal volume (litres)	Tread depth (mm)		
28	440/80R28 IND 163A8/163B TL <i>16.9 R28 (Equiv 18PR)</i>	195802	446	1407	637	4188	DW14L	DW15L	822	259	33				
Bar	1.6	1.8	2	2.2	2.4	2.6	2.8	3	3.2	3.4	3.6	3.8	4	4.2	4.4
Psi	23	26	29	32	35	38	41	44	46	49	52	55	58	61	64
Stat	4370	4930	5485	6045	6605	7165	7720	8280	8840	9395	9955	10515	11075	11630	12190
10 km/h Cyc	2850	3275	3700	4125	4550	4975	5400	5825	6250	6675	7100	7525	7950		
25 km/h	2620	2855	3085	3320	3550	3785	4015	4250	4480	4715	4945	5180	5410		
30 km/h	2525	2750	2975	3200	3420	3645	3870	4095	4320	4545	4765	4990	5215		
40 km/h	2360	2570	2780	2990	3200	3410	3620	3825	4035	4245	4455	4665	4875		
50 km/h	2360	2570	2780	2990	3200	3410	3620	3825	4035	4245	4455	4665	4875		

***IMPORTANT:**

The inflation pressure must always be appropriate for the load per tire, the speed of travel and the work to be done. Our recommendations above are provided subject to changes made after the date of publication of these tables. Technical data is subject to change without prior notice.

- For use on side slopes: add 0.4 bar.
- For intense road use, add 0.4 bar.
- Stat: static load.
- 10 km/h Cyc: max. speed 10 km/h with cyclic load.



MICHELIN CROSSGRIP

**A MULTI-PURPOSE TIRE
FOR USE ON THE ROAD,
GRASS AND SNOW**



VERSATILITY

- A special rubber formula designed for multi-purposes, 4-season use
- Non-directional pattern
(no need to dismantle tire from rim when rotating the tires)



PRODUCTIVITY

- Greater load at 65 kph⁽¹⁾
- Non-directional tread for excellent precision in forward and reverse gear



TRACTION

- Very long edge with optimized tread pattern for good traction on snow and hard surfaces



Backhoe loaders



Compact Wheel Loaders



Tractor



Telehandlers

(1) For the 440/80 R28 163A8/158D IND TL size, the MICHELIN 158D tire can carry 4,250 kg at 65 km/h while competitor 151D tires carry 3,450 Kg at 65 km/h. Source: ETRTO standard.

SIZES

250/80R16 124A8/120D IND TL

340/80R18 143A8/138D IND TL

360/80R24 150A8/145D IND TL

400/80R24 156A8/151D IND TL

460/70R24 159A8/154D IND TL

440/80R24 161A8/156D IND TL

500/70R24 164A8/159D IND TL

400/80R28 158A8/153D IND TL

440/80R28 163A8/158D IND TL

440/80R34 159A8/155D IND TL

480/80R34 164A8/159D IND TL

480/80R38 166A8/161D IND TL

540/80R38 172A8/167D IND TL

MICHELIN CROSSGRIP

Tire specifications and pressure table (bar & psi). Load per tire in kg*

Ø inches	Description	CAI	e mm	D mm	R' mm	RC mm	Recommended Rim		Acceptable Rim		Tube (Code)	75% internal volume (litres)	Tread depth (mm)	
16	250/80R16 IND 124A8/120D TL <i>7.5 R16</i>	564847	259	804	364	2393	W8		W7 W9		184	48	17	
Bar	0,80 1,20 1,60 2,00 2,40 2,60 2,80 3,00 3,20 3,40 3,60 3,80	12 17 23 29 35 38 41 44 46 49 52 55	1,60 2,00 2,40 2,60 2,80 3,00 3,20 3,40 3,60 3,80 4,00 4,20 4,40	23 29 35 38 41 44 46 49 52 55 58 61 64	23 29 35 38 41 44 46 49 52 55 58 61 64	23 29 35 38 41 44 46 49 52 55 58 61 64	23 29 35 38 41 44 46 49 52 55 58 61 64	23 29 35 38 41 44 46 49 52 55 58 61 64	23 29 35 38 41 44 46 49 52 55 58 61 64	23 29 35 38 41 44 46 49 52 55 58 61 64	23 29 35 38 41 44 46 49 52 55 58 61 64	23 29 35 38 41 44 46 49 52 55 58 61 64	23 29 35 38 41 44 46 49 52 55 58 61 64	
Stat		1440	1760	2080	2240	2400	2560	2720	2880	3040	3200	3360	3520	3680
10 km/h Cyc		940	1150	1355	1460	1565	1670	1770	1875	1980	2085	2190	2295	2400
25 km/h	625	740	850	1005	1160	1235	1315	1390	1465	1545	1620	1700	1775	
30 km/h	615	720	820	965	1115	1185	1260	1335	1405	1480	1555	1625	1700	
40 km/h	585	680	775	915	1050	1120	1190	1255	1325	1395	1465	1530	1600	
50 km/h		680	775	915	1050	1120	1190	1255	1325	1395	1465	1530	1600	
65 km/h		545	665	790	910	970	1035	1095	1155	1215	1280	1340	1400	

Ø inches	Description	CAI	e mm	D mm	R' mm	RC mm	Recommended Rim		Acceptable Rim		Tube (Code)	75% internal volume (litres)	Tread depth (mm)	
18	340/80R18 IND 143A8/138D TL <i>12.5/80 R18</i>	698283	352	1000	452	2975	11		11SDC 12 12SDC W10 W11		828 444	106	21	
Bar	0,80 1,20 1,60 2,00 2,40 2,60 2,80 3,00 3,20 3,40 3,60 3,80	12 17 23 29 35 38 41 44 46 49 52 55	1,60 2,00 2,40 2,60 2,80 3,00 3,20 3,40 3,60 3,80 4,00 4,20 4,40	23 29 35 38 41 44 46 49 52 55 58 61 64	23 29 35 38 41 44 46 49 52 55 58 61 64	23 29 35 38 41 44 46 49 52 55 58 61 64	23 29 35 38 41 44 46 49 52 55 58 61 64	23 29 35 38 41 44 46 49 52 55 58 61 64	23 29 35 38 41 44 46 49 52 55 58 61 64	23 29 35 38 41 44 46 49 52 55 58 61 64	23 29 35 38 41 44 46 49 52 55 58 61 64	23 29 35 38 41 44 46 49 52 55 58 61 64	23 29 35 38 41 44 46 49 52 55 58 61 64	
Stat		2450	2995	3540	3815	4090	4360	4635	4905	5180	5455	5725	6000	6270
10 km/h Cyc		1600	1955	2310	2490	2670	2845	3025	3200	3380	3555	3735	3915	4090
25 km/h	1060	1255	1450	1715	1975	2105	2240	2370	2500	2630	2765	2895	3025	
30 km/h	1045	1220	1390	1645	1900	2030	2155	2285	2410	2535	2665	2790	2915	
40 km/h	1000	1160	1320	1550	1780	1895	2010	2125	2240	2360	2485	2605	2725	
50 km/h		1160	1320	1555	1790	1905	2025	2140	2255	2375	2490	2610	2725	
65 km/h		930	1135	1335	1535	1635	1735	1835	1935	2035	2135	2235	2335	

Ø inches	Description	CAI	e mm	D mm	R' mm	RC mm	Recommended Rim		Acceptable Rim		Tube (Code)	75% internal volume (litres)	Tread depth (mm)	
24	360/80R24 IND 150A8/145D TL <i>13.6 R24</i>	514449	365	1192	545	3556	DW12		W11		700	150	26	
Bar	0,80 1,20 1,60 2,00 2,40 2,60 2,80 3,00 3,20 3,40 3,60 3,80	12 17 23 29 35 38 41 44 46 49 52 55	1,60 2,00 2,40 2,60 2,80 3,00 3,20 3,40 3,60 3,80 4,00 4,20 4,40	23 29 35 38 41 44 46 49 52 55 58 61 64	23 29 35 38 41 44 46 49 52 55 58 61 64	23 29 35 38 41 44 46 49 52 55 58 61 64	23 29 35 38 41 44 46 49 52 55 58 61 64	23 29 35 38 41 44 46 49 52 55 58 61 64	23 29 35 38 41 44 46 49 52 55 58 61 64	23 29 35 38 41 44 46 49 52 55 58 61 64	23 29 35 38 41 44 46 49 52 55 58 61 64	23 29 35 38 41 44 46 49 52 55 58 61 64	23 29 35 38 41 44 46 49 52 55 58 61 64	
Stat		3020	3690	4360	4695	5025	5360	5695	6030	6365	6700	7035	7370	7705
10 km/h Cyc		1970	2405	2840	3060	3280	3495	3715	3930	4150	4370	4590	4805	5025
25 km/h	1315	1545	1775	2100	2425	2585	2745	2910	3070	3235	3395	3560	3720	
30 km/h	1295	1505	1715	2030	2340	2495	2655	2810	2965	3120	3275	3430	3585	
40 km/h	1240	1435	1625	1915	2200	2345	2490	2630	2775	2920	3065	3205	3350	
50 km/h		1435	1625	1915	2200	2345	2490	2630	2775	2920	3065	3205	3350	
65 km/h		1150	1395	1645	1895	2020	2145	2270	2395	2520	2650	2775	2900	

* Refer to the notes at the end of the tables of this range

MICHELIN CROSSGRIP

Tire specifications and pressure table (bar & psi). Load per tire in kg*

Ø inches	Description	CAI	e mm	D mm	R' mm	RC mm	Recommended Rim		Acceptable Rim		Tube (Code)	75% internal volume (litres)	Tread depth (mm)	
24	400/80R24 IND 156A8/151D TL <i>15.5/80 R24 (Equiv 20PR)</i>	920345	413	1240	561	3689	DW13L		DW12 DW14L		703	187	26	
Bar	0,80 1,20 1,60 2,00 2,40 2,60 2,80 3,00 3,20 3,40 3,60 3,80 4,00 4,20 4,40													
Psi	12 17 23 29 35 38 41 44 46 49 52 55 58 61 64													
Stat		3600	4400	5200	5600	6000	6400	6800	7200	7600	8000	8400	8800	9200
10 km/h Cyc		2340	2860	3385	3645	3905	4165	4430	4690	4950	5215	5475	5740	6000
25 km/h	1550	1835	2120	2450	2775	2940	3100	3265	3430	3665	3905	4140	4375	
30 km/h	1525	1795	2060	2385	2710	2875	3035	3200	3360	3590	3825	4055	4290	
40 km/h	1460	1705	1950	2290	2635	2805	2975	3145	3315	3490	3660	3830	4000	
50 km/h		1705	1950	2290	2635	2805	2975	3145	3315	3490	3660	3830	4000	
65 km/h		1355	1640	1930	2225	2370	2515	2660	2805	2965	3130	3290	3450	

Ø inches	Description	CAI	e mm	D mm	R' mm	RC mm	Recommended Rim		Acceptable Rim		Tube (Code)	75% internal volume (litres)	Tread depth (mm)	
24	460/70R24 IND 159A8/154D TL <i>17.5 LR24 (Equiv 18PR)</i>	304047	475	1246	564	3708	DW15L		14 16 DW14L DW16A TW14L		710	218	26	
Bar	0,80 1,20 1,60 2,00 2,40 2,60 2,80 3,00 3,20 3,40 3,60 3,80 4,00 4,20 4,40													
Psi	12 17 23 29 35 38 41 44 46 49 52 55 58 61 64													
Stat		3940	4815	5690	6125	6560	7000	7435	7875	8310	8750	9185	9625	10060
10 km/h Cyc		2570	3140	3710	3995	4280	4565	4850	5135	5420	5705	5990	6275	6560
25 km/h	1715	2020	2320	2745	3165	3375	3585	3800	4010	4225	4435	4650	4860	
30 km/h	1685	1965	2240	2650	3055	3260	3460	3665	3870	4075	4275	4480	4680	
40 km/h	1615	1870	2120	2495	2870	3060	3250	3435	3625	3810	4000	4185	4375	
50 km/h		1870	2120	2495	2870	3060	3250	3435	3625	3810	4000	4185	4375	
65 km/h		1500	1820	2140	2465	2625	2785	2945	3105	3270	3430	3590	3750	

Ø inches	Description	CAI	e mm	D mm	R' mm	RC mm	Recommended Rim		Acceptable Rim		Tube (Code)	75% internal volume (litres)	Tread depth (mm)	
24	440/80R24 IND 161A8/156D TL <i>16.9 R24 (Equiv 18PR)</i>	131846	447	1314	592	3906	DW14L		14 DW15L		710	234	26	
Bar	0,80 1,20 1,60 2,00 2,40 2,60 2,80 3,00 3,20 3,40 3,60 3,80 4,00 4,20 4,40													
Psi	12 17 23 29 35 38 41 44 46 49 52 55 58 61 64													
Stat		4160	5085	6010	6475	6940	7400	7865	8325	8790	9255	9715	10180	10640
10 km/h Cyc		2710	3315	3920	4220	4525	4825	5125	5430	5730	6035	6335	6640	6940
25 km/h	1800	2130	2460	2905	3350	3575	3795	4020	4240	4465	4685	4910	5130	
30 km/h	1770	2070	2370	2800	3230	3445	3660	3875	4090	4305	4520	4735	4950	
40 km/h	1700	1970	2240	2640	3035	3235	3435	3630	3830	4030	4230	4425	4625	
50 km/h		1970	2240	2640	3035	3235	3435	3630	3830	4030	4230	4425	4625	
65 km/h		1575	1880	2235	2585	2765	2940	3115	3295	3470	3645	3825	4000	

* Refer to the notes at the end of the tables of this range

MICHELIN CROSSGRIP

Tire specifications and pressure table (bar & psi). Load per tire in kg*

Ø inches	Description	CAI	e mm	D mm	R' mm	RC mm	Recommended Rim	Acceptable Rim	Tube (Code)	75% internal volume (litres)	Tread depth (mm)			
24	500/70R24 IND 164A8/159D TL <i>19.5 LR24</i>	875270	513	1292	579	3836	DW16A	DW15L DW16L TW16L	710	264	26			
Bar	0,80 1,20 1,60 2,00 2,40 2,60 2,80 3,00 3,20 3,40 3,60 3,80 4,00 4,20 4,40													
Psi	12 17 23 29 35 38 41 44 46 49 52 55 58 61 64													
Stat		4505	5505	6500	7000	7500	8000	8495	8995	9495	9995	10495	10995	11495
10 km/h Cyc		2935	3585	4240	4565	4890	5215	5545	5870	6195	6520	6845	7170	7495
25 km/h	1950 2300	2650	3135	3620	3860	4100	4345	4585	4830	5070	5315	5555		
30 km/h	1920 2240	2560	3025	3495	3725	3960	4190	4425	4655	4890	5120	5350		
40 km/h	1840 2135	2425	2855	3285	3500	3715	3925	4140	4355	4570	4785	5000		
50 km/h	2135 2425	2855	3285	3500	3715	3925	4140	4355	4570	4785	5000			
65 km/h	1710 2080	2450	2815	3000	3185	3365	3550	3735	3920	4100	4285			

Ø inches	Description	CAI	e mm	D mm	R' mm	RC mm	Recommended Rim	Acceptable Rim	Tube (Code)	75% internal volume (litres)	Tread depth (mm)			
28	400/80R28 IND 158A8/153D TL <i>14.9 R28</i>	219659	412	1354	616	4034	DW13	DW11 W12 W13	821	159	26			
Bar	0,80 1,20 1,60 2,00 2,40 2,60 2,80 3,00 3,20 3,40 3,60 3,80 4,00 4,20 4,40													
Psi	12 17 23 29 35 38 41 44 46 49 52 55 58 61 64													
Stat		3830	4680	5530	5955	6375	6800	7225	7650	8075	8500	8925	9350	9775
10 km/h Cyc		2500	3055	3605	3885	4160	4435	4710	4990	5265	5545	5820	6100	6375
25 km/h	1660 1960	2255	2665	3075	3280	3485	3690	3895	4100	4310	4515	4720		
30 km/h	1635 1905	2175	2570	2970	3165	3365	3560	3760	3955	4155	4350	4545		
40 km/h	1565 1815	2060	2425	2790	2975	3155	3340	3520	3705	3885	4070	4250		
50 km/h	1815 2060	2425	2790	2975	3155	3340	3520	3705	3885	4070	4250			
65 km/h	1455 1770	2085	2395	2550	2710	2865	3020	3175	3335	3490	3645			

Ø inches	Description	CAI	e mm	D mm	R' mm	RC mm	Recommended Rim	Acceptable Rim	Tube (Code)	75% internal volume (litres)	Tread depth (mm)			
28	440/80R28 IND 163A8/158D TL <i>16.9 R28 (Equiv 18PR)</i>	439765	450	1410	635	4197	DW14L	DW15L	822	259	26			
Bar	0,80 1,20 1,60 2,00 2,40 2,60 2,80 3,00 3,20 3,40 3,60 3,80 4,00 4,20 4,40													
Psi	12 17 23 29 35 38 41 44 46 49 52 55 58 61 64													
Stat		4370	5485	6605	7165	7720	8280	8840	9395	9955	10515	11075	11630	12190
10 km/h Cyc		2850	3700	4550	4975	5400	5825	6250	6675	7100	7525	7950		
25 km/h	1925 2275	2620	3090	3565	3800	4035	4270	4505	4730	4960	5185	5410		
30 km/h	1895 2210	2525	2975	3425	3645	3870	4095	4320	4545	4770	4990	5215		
40 km/h	1815 2090	2360	2780	3200	3410	3620	3825	4035	4245	4455	4665	4875		
50 km/h	2090 2360	2780	3200	3410	3620	3825	4035	4245	4455	4665	4875			
65 km/h	1685 2035	2405	2775	2960	3145	3325	3510	3695	3880	4065	4250			

* Refer to the notes at the end of the tables of this range

MICHELIN CROSSGRIP

Tire specifications and pressure table (bar & psi). Load per tire in kg*

Ø inches	Description	CAI	e mm	D mm	R' mm	RC mm	Recommended Rim		Acceptable Rim		Tube (Code)	75% internal volume (litres)	Tread depth (mm)
34	440/80R34 IND 159A8/155D TL <i>16,9 R34</i>	967528	431	1580	718	4706	DW14L		DW15L DW16L	704	296	28	
Bar	0,80 1,20 1,60 2,00 2,40 2,60 2,80 3,00 3,20 3,40 3,60 3,80 4,00 4,20 4,40												
Psi	12 17 23 29 35 38 41 44 46 49 52 55 58 61 64												
10 km/h Cyc		3270	3945	4615	4940	5265	5590	5915	6240	6565			
25 km/h	2105	2420	2730	3195	3655	3905	4150	4395	4640				
30 km/h	2070	2375	2680	3135	3590	3830	4070	4310	4550				
40 km/h	1985	2280	2575	3015	3450	3685	3915	4145	4375				
50 km/h		2280	2575	3015	3450	3680	3910	4145	4375				
65 km/h		1845	2255	2650	3045	3255	3460	3670	3875				

Ø inches	Description	CAI	e mm	D mm	R' mm	RC mm	Recommended Rim		Acceptable Rim		Tube (Code)	75% internal volume (litres)	Tread depth (mm)
34	480/80R34 IND 164A8/159D TL <i>18,4 R34</i>	333253	477	1648	743	4900	DW15L		DW16L DW18L	823	362	28	
Bar	0,80 1,20 1,60 2,00 2,40 2,60 2,80 3,00 3,20 3,40 3,60 3,80 4,00 4,20 4,40												
Psi	12 17 23 29 35 38 41 44 46 49 52 55 58 61 64												
10 km/h Cyc		3645	4485	5325	5690	6050	6415	6775	7140	7500			
25 km/h	2405	2740	3075	3660	4240	4505	4770	5035	5300				
30 km/h	2370	2695	3015	3590	4160	4420	4680	4940	5200				
40 km/h	2270	2585	2900	3450	4000	4250	4500	4750	5000				
50 km/h		2585	2900	3450	4000	4250	4500	4750	5000				
65 km/h		2105	2540	3020	3500	3720	3940	4155	4375				

Ø inches	Description	CAI	e mm	D mm	R' mm	RC mm	Recommended Rim		Acceptable Rim		Tube (Code)	75% internal volume (litres)	Tread depth (mm)
38	480/80R38 IND 166A8/161D TL <i>18,4 R38</i>	846732	478	1757	791	5293	DW15L		DW16L DW18L	786	416	29	
Bar	0,80 1,20 1,60 2,00 2,40 2,60 2,80 3,00 3,20 3,40 3,60 3,80 4,00 4,20 4,40												
Psi	12 17 23 29 35 38 41 44 46 49 52 55 58 61 64												
Stat		5925	7275	8625	9220	9815	10410	11000	11595	12190			
10 km/h Cyc		3865	4745	5625	6015	6400	6790	7175	7565	7950			
25 km/h	2535	2900	3260	3885	4505	4785	5065	5340	5620				
30 km/h	2495	2850	3200	3810	4420	4695	4965	5240	5510				
40 km/h	2390	2735	3075	3630	4190	4465	4745	5020	5300				
50 km/h		2735	3075	3630	4190	4465	4745	5020	5300				
65 km/h		2220	2690	3175	3660	3900	4140	4385	4625				

MICHELIN CROSSGRIP

Tire specifications and pressure table (bar & psi). Load per tire in kg*

Ø inches	Description	CAI	e mm	D mm	R' mm	RC mm	Recommended Rim		Acceptable Rim	Tube (Code)	75% internal volume (litres)	Tread depth (mm)
38	540/80 R38 172A8/167D IND TL	567367	561	1856	832.5	5511	DW18L		DW16L	825	523	28
Bar	0,80 1,20 1,60 2,00 2,40 2,60 2,80 3,00 3,20 3,40 3,60											
Psi	12 17 23 29 35 38 41 44 46 49 52											
Stat		10345	11220	12090	12690	13290	13890	14490	15370	16250		
10 km/h Cyc		6765	7340	7910	8290	8670	9050	9430	10030	10630		
25 km/h	3035 3905	4770	5175	5575	5845	6115	6380	6650				
30 km/h	2985 3840	4695	5090	5485	5750	6015	6275	6540				
40 km/h	2860 3680	4500	4950	5400	5625	5850	6075	6300				
50 km/h	3455 4225	4640	5055	5265	5470	5680	5885					
65 km/h	3200 3910	4295	4680	4875	5065	5260	5450					

***IMPORTANT:**

The inflation pressure must always be appropriate for the load per tire, the speed of travel and the work to be done. Our recommendations above are provided subject to changes made after the date of publication of these tables. Technical data is subject to change without prior notice.

* Refer to the notes at the end of the tables of this range

- For use on side slopes: add 0.4 bar.
- For intense road use, add 0.4 bar.
- Stat: static load.
- 10 km/h Cyc: max. speed 10 km/h with cyclic load.



MICHELIN XF

**RADIAL STEEL CASING
TO INCREASE TIRE LIFE
& TRACTION**



RADIAL Tire



COMFORT

- Protection of vehicle & operator



SERVICE LIFE

- Proven casing endurance



VERSATILITY

- Efficient on all surfaces



100% STEEL CONSTRUCTION

- Great stability
- Excellent puncture resistance and better load distribution.



Wheeled
Excavators

* Vs main competitor Bias tire

SIZES

445/70R19.5 173A8/180A2 TL

445/70R22.5 175A8/182A2 TL

MICHELIN XF

Tire specifications and pressure table (bar & psi). Load per tire in kg*

Ø inches	Description	CAI	e mm	D mm	R' mm	RC mm	Recommended Rim		Acceptable Rim		Tube (Code)	75% internal volume (litres)	Tread depth (mm)		
19.5	445/70R19.5 173A8/180A2 TL <i>18 R19.5</i>	489102	452	1110	499	3331	6	6.2	6.4	6.6	6.8	165	18		
Bar	3.5	3.8	4	4.4	4.8	5.2	5.6	6	6.2	6.4	6.6	6.8	7	7.2	7.5
Psi	51	55	58	64	70	75	81	87	90	93	96	99	102	104	109
Stat	6580	7060	7385	8025	8665	9310	9950	10595	10915	11235	11555	11875	12200	12520	13000
10 km/h	4050	4345	4545	4940	5335	5730	6125	6520	6715	6915	7110	7310	7505	7705	8000
20 km/h	3585	3850	4025	4375	4725	5075	5425	5775	5950	6125	6300	6475	6650	6825	7085
30 km/h	3420	3670	3840	4170	4505	4840	5175	5510	5675	5840	6010	6175	6345	6510	6760
35 km/h	3355	3600	3765	4090	4420	4745	5075	5400	5565	5730	5895	6055	6220	6385	6630
40 km/h	3290	3530	3690	4010	4335	4655	4975	5295	5455	5615	5780	5940	6100	6260	6500

Ø inches	Description	CAI	e mm	D mm	R' mm	RC mm	Recommended Rim		Acceptable Rim		Tube (Code)	75% internal volume (litres)	Tread depth (mm)		
22.5	445/70R22.5 175A8/182A2 TL <i>18 R22.5</i>	073522	452	1192	539	3582	6	6.2	6.4	6.6	6.8	191	20		
Bar	3.5	3.8	4	4.4	4.8	5.2	5.6	6	6.2	6.4	6.6	6.8	7	7.2	7.5
Psi	51	55	58	64	70	75	81	87	90	93	96	99	102	104	109
Stat	6980	7490	7835	8515	9195	9880	10560	11245	11585	11925	12265	12605	12950	13290	13800
10 km/h	4300	4615	4825	5245	5665	6085	6505	6925	7135	7345	7555	7765	7975	8185	8500
20 km/h	3805	4085	4270	4640	5010	5385	5755	6125	6315	6500	6685	6870	7055	7240	7520
30 km/h	3635	3900	4080	4435	4785	5140	5495	5850	6030	6205	6380	6560	6735	6915	7180
35 km/h	3560	3820	3995	4345	4690	5040	5385	5735	5910	6085	6255	6430	6605	6780	7040
40 km/h	3490	3745	3915	4255	4600	4940	5280	5620	5790	5960	6135	6305	6475	6645	6900

***IMPORTANT:**

The inflation pressure must always be appropriate for the load per tire, the speed of travel and the work to be done. Our recommendations above are provided subject to changes made after the date of publication of these tables. Technical data is subject to change without prior notice.

- For use on side slopes: add 0.4 bar.
- For intense road use: add 0.4 bar.
- Stat: static load.



MICHELIN XM 47

**GREAT ON-ROAD COMFORT
& GOOD GRIP
IN OFF-ROAD CONDITIONS**

For multi-purpose off-road trucks
RADIAL Tire up to 90 km/h



SPEED

- Can reach 90 km/h at high safety level



ROBUSTNESS

- Reinforced structure



SERVICE LIFE

- Proven casing endurance

SIZES

405/70R20 136G TL

425/75R20 148G TL

445/70R24 151G TL

495/70R24 155G TL

MICHELIN XM 47

Tire specifications and pressure table (bar & psi). Load per tire in kg*

Ø inches	Description	CAI	e mm	D mm	R' mm	RC mm	Recommended Rim		Acceptable Rim	Tube (Code)	75% internal volume (litres)	Tread depth (mm)			
20	405/70R20 136G TL	123708	395	1076	482	3194	11		W10 11SDC	664	137	28			
Bar	1	1.2	1.6	1.8	2	2.2	2.4	2.6	2.8	3	3.2	3.4	3.6	3.8	4.1
Psi	15	17	23	26	29	32	35	38	41	44	46	49	52	55	59
Stat	1950	2185	2655	2890	3125	3365	3600	3835	4070	4305	4540	4775	5010	5245	5600
10 km/h	1400	1570	1910	2080	2250	2420	2590	2755	2925	3095	3265	3435	3605	3775	4030
30 km/h	970	1090	1325	1440	1560	1680	1795	1915	2035	2150	2270	2385	2505	2625	2800
40 km/h	900	1010	1225	1335	1440	1550	1660	1765	1875	1985	2090	2200	2310	2415	2580
65 km/h	850	950	1155	1260	1360	1460	1565	1665	1765	1870	1970	2075	2175	2275	2430
90 km/h	780	875	1065	1155	1250	1345	1440	1535	1630	1720	1815	1910	2005	2100	2240

Ø inches	Description	CAI	e mm	D mm	R' mm	RC mm	Recommended Rim		Acceptable Rim	Tube (Code)	75% internal volume (litres)	Tread depth (mm)			
20	425/75R20 148G TL	123706	450	1147	509	3398	13		11 11SDC 13SDC	664	185	30			
Bar	1	1.2	1.6	1.8	2	2.2	2.4	2.6	2.8	3	3.2	3.4	3.6	3.8	4.1
Psi	15	17	23	26	29	32	35	38	41	44	46	49	52	55	59
Stat	2750	3080	3740	4075	4405	4735	5065	5395	5725	6055	6385	6720	7050	7380	7875
10 km/h	1970	2210	2685	2925	3165	3400	3640	3880	4120	4355	4595	4835	5075	5310	5670
30 km/h	1370	1535	1865	2035	2200	2365	2530	2695	2860	3030	3195	3360	3525	3690	3940
40 km/h	1260	1410	1715	1870	2020	2175	2325	2480	2630	2785	2935	3085	3240	3390	3620
65 km/h	1190	1335	1620	1765	1910	2055	2195	2340	2485	2630	2775	2915	3060	3205	3420
90 km/h	1100	1230	1495	1630	1760	1895	2025	2160	2290	2425	2555	2685	2820	2950	3150

Ø inches	Description	CAI	e mm	D mm	R' mm	RC mm	Recommended Rim		Acceptable Rim	Tube (Code)	75% internal volume (litres)	Tread depth (mm)			
24	445/70R24 151G TL	123642	462	1239	562	3689	DW15L		DW14L W14L W15L	710	210	34			
Bar	1	1.2	1.6	1.8	2	2.2	2.4	2.6	2.8	3	3.2	3.4	3.6	3.8	4.1
Psi	15	17	23	26	29	32	35	38	41	44	46	49	52	55	59
Stat	3000	3365	4090	4450	4815	5175	5540	5905	6265	6630	6990	7355	7720	8080	8625
10 km/h	2160	2420	2945	3205	3465	3730	3990	4250	4510	4775	5035	5295	5555	5820	6210
30 km/h	1500	1680	2045	2225	2405	2590	2770	2950	3130	3315	3495	3675	3855	4040	4310
40 km/h	1380	1545	1880	2050	2215	2385	2550	2715	2885	3050	3220	3385	3550	3720	3970
65 km/h	1300	1455	1770	1930	2085	2245	2400	2560	2715	2875	3030	3190	3345	3505	3740
90 km/h	1200	1345	1635	1780	1925	2070	2215	2360	2505	2650	2795	2940	3085	3230	3450

* Refer to the notes at the end of the tables of this range

MICHELIN XM 47

Tire specifications and pressure table (bar & psi). Load per tire in kg*

Ø inches	Description	CAI	e mm	D mm	R' mm	RC mm	Recommended Rim		Acceptable Rim		Tube (Code)	75% internal volume (litres)	Tread depth (mm)		
24	495/70R24 155G TL	123620	508	1311	581	3883	DW16L		W16L		710	248	35		
Bar	1	1.2	1.6	1.8	2	2.2	2.4	2.6	2.8	3	3.2	3.4	3.6	3.8	4.1
Psi	15	17	23	26	29	32	35	38	41	44	46	49	52	55	59
Stat	3375	3785	4600	5005	5415	5825	6230	6640	7050	7455	7865	8270	8680	9090	9700
10 km/h	2430	2725	3310	3605	3900	4190	4485	4780	5070	5365	5660	5955	6245	6540	6980
30 km/h	1690	1895	2300	2505	2705	2910	3115	3315	3520	3720	3925	4130	4330	4535	4840
40 km/h	1550	1740	2115	2300	2490	2675	2865	3050	3240	3425	3615	3805	3990	4180	4460
65 km/h	1460	1635	1990	2165	2345	2520	2695	2875	3050	3230	3405	3580	3760	3935	4200
90 km/h	1350	1515	1840	2005	2165	2330	2495	2655	2820	2980	3145	3310	3470	3635	3880

***IMPORTANT:**

The inflation pressure must always be appropriate for the load per tire, the speed of travel and the work to be done. Our recommendations above are provided subject to changes made after the date of publication of these tables. Technical data is subject to change without prior notice.

- For use on side slopes: add 0.4 bar.
- For intense road use: add 0.4 bar.
- Stat: static load.



MICHELIN BIBSTEEL ALL TERRAIN

**REINFORCED RADIAL
CONSTRUCTION / BETTER
TRACTION / NO DOWNTIME**



COMFORT

- Protection of vehicle & operator



TRACTION

- Radial construction & open tread pattern



ROBUSTNESS

- 100% steel construction for extreme duties



SERVICE LIFE

- Proven casing endurance



100% STEEL CONSTRUCTION

- Great stability
- Excellent puncture resistance and better load distribution



Skid Steer



Telehandlers

SIZES

210/70R15 IND 117A8/117B TL

260/70R16.5 IND 129A8/129B TL

300/70R16.5 IND 137A8/137B TL

360/70R17.5 IND 148A8/148B TL

MICHELIN BIBSTEEL ALL TERRAIN

Tire specifications and pressure table (bar & psi). Load per tire in kg*

Ø inches	Description	CAI	e mm	D mm	R' mm	RC mm	Recommended Rim		Acceptable Rim		Tube (Code)	75% internal volume (litres)	Tread depth (mm)			
15	210/70R15 IND 117A8/117B TL <i>27 x 8.50 R15 (Equiv 8PR) Replaces size 215/70 R15</i>	085459	209	680	314	2033	7.00					26	15			
	Bar	1.5	1.8	2.2	2.6	3	3.2	3.4	3.6	3.8	4	4.2	4.4	4.6	4.8	5
	Psi	22	26	32	38	44	46	49	52	55	58	61	64	67	70	73
	Stat	1100	1270	1485	1695	1905	2010	2115	2220	2325	2430	2535	2640	2745	2850	2955
	25 km/h	530	615	720	820	920	970	1020	1070	1125	1175	1225	1275	1330	1380	1430
	40 km/h	475	550	645	740	830	875	920	965	1010	1055	1105	1150	1195	1240	1285
	50 km/h	475	550	645	740	830	875	920	965	1010	1055	1105	1150	1195	1240	1285

Ø inches	Description	CAI	e mm	D mm	R' mm	RC mm	Recommended Rim		Acceptable Rim		Tube (Code)	75% internal volume (litres)	Tread depth (mm)			
16.5	260/70R16.5 IND 129A8/129B TL <i>10 R16.5 (Equiv 12PR) Replaces size 265/70 R16.5</i>	176281	263	774	355	2310	8.25				184	47	20			
	Bar	1.5	1.8	2.2	2.6	3	3.2	3.4	3.6	3.8	4	4.2	4.4	4.6	4.8	5
	Psi	22	26	32	38	44	46	49	52	55	58	61	64	67	70	73
	Stat	1590	1810	2110	2415	2720	2870	3025	3180	3330	3485	3640	3795	3945	4100	4255
	25 km/h	760	870	1015	1165	1315	1390	1465	1540	1610	1685	1760	1835	1905	1980	2055
	40 km/h	690	785	915	1050	1185	1250	1315	1385	1450	1515	1585	1650	1715	1785	1850
	50 km/h	690	785	915	1050	1185	1250	1315	1385	1450	1515	1585	1650	1715	1785	1850

Ø inches	Description	CAI	e mm	D mm	R' mm	RC mm	Recommended Rim		Acceptable Rim		Tube (Code)	75% internal volume (litres)	Tread depth (mm)			
16.5	300/70R16.5 IND 137A8/137B TL <i>12 R16.5 (Equiv 14PR)</i>	625787	311	832	380	2481	9.75				184	65	23			
	Bar	1.5	1.8	2.2	2.6	3	3.2	3.4	3.6	3.8	4	4.2	4.4	4.6	4.8	5
	Psi	22	26	32	38	44	46	49	52	55	58	61	64	67	70	73
	Stat	2010	2270	2630	3005	3380	3565	3755	3950	4140	4330	4525	4715	4905	5100	5290
	25 km/h	970	1095	1270	1450	1630	1720	1810	1905	1995	2090	2180	2275	2365	2460	2550
	40 km/h	875	985	1140	1305	1470	1550	1635	1715	1800	1885	1965	2050	2135	2215	2300
	50 km/h	875	985	1140	1305	1470	1550	1635	1715	1800	1885	1965	2050	2135	2215	2300

* Refer to the notes at the end of the tables of this range

MICHELIN BIBSTEEL ALL TERRAIN

Tire specifications and pressure table (bar & psi). Load per tire in kg*

Ø inches	Description			CAI	e mm	D mm	R' mm	RC mm	Recommended Rim		Acceptable Rim		Tube (Code)	75% internal volume (litres)	Tread depth (mm)
17.5	360/70R17.5 IND 148A8/148B TL <i>14 R17.5 (Equiv 14PR)</i>			360353	351	949	429	2823	10.5					99	26
Bar	1.5	1.8	2.2	2.6	3	3.2	3.4	3.6	3.8	4	4.2	4.4	4.6	4.8	5
Psi	22	26	32	38	44	46	49	52	55	58	61	64	67	70	73
Stat	2715	3105	3620	4140	4660	4920	5175	5435	5695	5955	6215	6475	6730	6990	7250
25 km/h	1300	1490	1740	1990	2245	2370	2495	2620	2745	2870	2995	3125	3250	3375	3500
40 km/h	1180	1350	1575	1800	2025	2135	2250	2360	2475	2585	2700	2810	2925	3035	3150
50 km/h	1180	1350	1575	1800	2025	2135	2250	2360	2475	2585	2700	2810	2925	3035	3150

***IMPORTANT:**

The inflation pressure must always be appropriate for the load per tire, the speed of travel and the work to be done. Our recommendations above are provided subject to changes made after the date of publication of these tables. Technical data is subject to change without prior notice.

- For use on side slopes: add 0.4 bar.
- For intense road use: add 0.4 bar.
- Stat: static load.



MICHELIN BIBSTEEL HARD SURFACE

**REINFORCED RADIAL
CONSTRUCTION / BETTER
TRACTION / NO DOWNTIME**



RADIAL Tire



COMFORT

- Protection of véhicule & operator



ROBUSTNESS

- 100% steel construction for extreme duties



SERVICE LIFE

- Proven casing endurance



100% STEEL CONSTRUCTION

- Great stability
- Excellent puncture resistance and better load distribution



Skid Steer



Telehandlers

SIZES

260/70R16.5 IND 129A8/129B TL

300/70R16.5 IND 137A8/137B TL

MICHELIN BIBSTEEL HARD SURFACE

Tire specifications and pressure table (bar & psi). Load per tire in kg*

Ø inches	Description	CAI	e mm	D mm	R' mm	RC mm	Recommended Rim		Acceptable Rim		Tube (Code)	75% internal volume (litres)	Tread depth (mm)		
16.5	260/70R16.5 IND 129A8/129B TL <i>10 R16.5 (Equiv 12PR)</i>	275538	266	773	355	2307	8.25				184	45	18		
Bar	1.5	1.8	2.2	2.6	3	3.2	3.4	3.6	3.8	4	4.2	4.4	4.6	4.8	5
Psi	22	26	32	38	44	46	49	52	55	58	61	64	67	70	73
Stat	1590	1810	2110	2415	2720	2870	3025	3180	3330	3485	3640	3795	3945	4100	4255
25 km/h	760	870	1015	1165	1315	1390	1465	1540	1610	1685	1760	1835	1905	1980	2055
40 km/h	690	785	915	1050	1185	1250	1315	1385	1450	1515	1585	1650	1715	1785	1850
50 km/h	690	785	915	1050	1185	1250	1315	1385	1450	1515	1585	1650	1715	1785	1850

Ø inches	Description	CAI	e mm	D mm	R' mm	RC mm	Recommended Rim		Acceptable Rim		Tube (Code)	75% internal volume (litres)	Tread depth (mm)		
16.5	300/70R16.5 IND 137A8/137B TL <i>12 R16.5 (Equiv 14PR)</i>	241265	315	830	378	2477	9.75				184	65	21		
Bar	1.5	1.8	2.2	2.6	3	3.2	3.4	3.6	3.8	4	4.2	4.4	4.6	4.8	5
Psi	22	26	32	38	44	46	49	52	55	58	61	64	67	70	73
Stat	2010	2270	2630	3005	3380	3565	3755	3950	4140	4330	4525	4715	4905	5100	5290
25 km/h	970	1095	1270	1450	1630	1720	1810	1905	1995	2090	2180	2275	2365	2460	2550
40 km/h	875	985	1140	1305	1470	1550	1635	1715	1800	1885	1965	2050	2135	2215	2300
50 km/h	875	985	1140	1305	1470	1550	1635	1715	1800	1885	1965	2050	2135	2215	2300

***IMPORTANT:**

The inflation pressure must always be appropriate for the load per tire, the speed of travel and the work to be done. Our recommendations above are provided subject to changes made after the date of publication of these tables. Technical data is subject to change without prior notice.

- For use on side slopes: add 0.4 bar.
- For intense road use: add 0.4 bar.
- Stat: static load.



MICHELIN POWER CL

**CROSS PLY TIRE
RESISTANT TO CUTS
AND GREAT STABILITY**



ROBUSTNESS

- 6 to 8 plies casing



CROSS PLY Tire

- Vertical & lateral stability



SERVICE LIFE

- Massive lugs



Backhoe loaders



Compact Wheel Loaders



Telehandlers

SIZES

280/80-18 IND 132A8 TL

340/80-18 IND 143A8 TL

280/80-20 IND 133A8 TL

340/80-20 144A8 TL

400/70-20 IND 149A8 TL

400/70-24 IND 158A8 TL

460/70-24 IND 159A8 TL

400/80-24 IND 162A8 TL

500/70-24 IND 164A8 TL

440/80-24 IND 168A8 TL

480/80-26 IND 167A8 TL

440/80-28 163A8 TL

420/80-30 IND 155A8 TL

MICHELIN POWER CL

Tire specifications and pressure table (bar & psi). Load per tire in kg*

Ø inches	Description	CAI	e mm	D mm	R' mm	RC mm	Recommended Rim		Acceptable Rim	Tube (Code)	75% internal volume (litres)	Tread depth (mm)
18	280/80-18 IND 132A8 TL <i>10.5/80 - 18 (Equiv 10PR)</i>	281778	288	902	413	2691	9		W9 W10 10 W8	438	80	26
	Bar	1	1.2	1.6	2	2.4	2.8	3.2	3.6	3.8	4	
	Psi	15	17	23	29	35	41	46	52	55	58	
	Stat	1840	2025	2390	2760	3130	3495	3865	4230	4415	4600	
	10 km/h Cyc	1200	1320	1560	1800	2040	2280	2520	2760	2880	3000	
	10 km/h	1000	1100	1300	1500	1700	1900	2100	2300	2400	2500	
	25 km/h	850	935	1105	1275	1445	1610	1780	1950	2035	2120	
	30 km/h	830	915	1080	1245	1415	1580	1745	1915	1995	2080	
	40 km/h	800	880	1040	1200	1360	1520	1680	1840	1920	2000	

Ø inches	Description	CAI	e mm	D mm	R' mm	RC mm	Recommended Rim		Acceptable Rim	Tube (Code)	75% internal volume (litres)	Tread depth (mm)
18	340/80-18 IND 143A8 TL <i>12.5/80 - 18 (Equiv 12PR)</i>	610873	353	1006	452	2988	11		W10 W11 12 10 11SDC 12SDC	828 444	106	24
	Bar	1	1.2	1.6	2	2.4	2.8	3.2	3.6	3.8	4	
	Psi	15	17	23	29	35	41	46	52	55	58	
	Stat	2510	2760	3260	3765	4265	4765	5265	5770	6020	6270	
	10 km/h Cyc	1640	1805	2130	2455	2785	3110	3435	3765	3925	4090	
	10 km/h	1360	1495	1770	2045	2315	2590	2865	3135	3275	3410	
	25 km/h	1155	1270	1505	1735	1965	2200	2430	2665	2780	2895	
	30 km/h	1130	1245	1470	1695	1925	2150	2375	2605	2715	2830	
	40 km/h	1090	1200	1420	1635	1855	2075	2295	2510	2620	2730	

Ø inches	Description	CAI	e mm	D mm	R' mm	RC mm	Recommended Rim		Acceptable Rim	Tube (Code)	75% internal volume (litres)	Tread depth (mm)
20	280/80-20 IND 133A8 TL <i>10.5/80 - 20 (Equiv 10PR)</i>	694767	287	947	435	2828	9		W8 W9 W10 10	542	86	27
	Bar	1	1.2	1.6	2	2.4	2.8	3.2	3.6	3.8	4	
	Psi	15	17	23	29	35	41	46	52	55	58	
	Stat	1900	2090	2470	2845	3225	3605	3985	4360	4550	4740	
	10 km/h Cyc	1240	1365	1610	1855	2105	2350	2595	2845	2965	3090	
	10 km/h	1030	1135	1340	1545	1755	1960	2165	2375	2475	2580	
	25 km/h	870	960	1135	1310	1485	1660	1835	2010	2095	2185	
	30 km/h	860	945	1115	1285	1455	1630	1800	1970	2055	2140	
	40 km/h	820	905	1070	1235	1400	1565	1730	1895	1975	2060	

* Refer to the notes at the end of the tables of this range

MICHELIN POWER CL

Tire specifications and pressure table (bar & psi). Load per tire in kg*

Ø inches	Description	CAI	e mm	D mm	R' mm	RC mm	Recommended Rim		Acceptable Rim	Tube (Code)	75% internal volume (litres)	Tread depth (mm)
20	340/80-20 144A8 TL <i>12.5/80 - 20 (Equiv 12PR)</i>	495503	337	1045	474	3112	11		W10 W11 12 10 11SDC 12SDC	664 444	113	25
	Bar	1	1.2	1.6	2	2.4	2.8	3.2	3.6	3.8	4	
	Psi	15	17	23	29	35	41	46	52	55	58	
	Stat	2580	2835	3350	3865	4380	4895	5410	5925	6185	6440	
	10 km/h Cyc	1680	1850	2185	2520	2855	3190	3530	3865	4030	4200	
	10 km/h	1400	1540	1820	2100	2380	2660	2940	3220	3360	3500	
	25 km/h	1185	1305	1540	1780	2020	2255	2495	2730	2850	2970	
	30 km/h	1160	1275	1510	1745	1975	2210	2445	2675	2795	2910	
	40 km/h	1120	1230	1455	1680	1905	2130	2350	2575	2690	2800	

Ø inches	Description	CAI	e mm	D mm	R' mm	RC mm	Recommended Rim		Acceptable Rim	Tube (Code)	75% internal volume (litres)	Tread depth (mm)
20	400/70-20 IND 149A8 TL <i>16.0/70 - 20 / 405/70 - 20 (Equiv 16PR)</i>	346809	405	1065	480	3167	13		14 12 12SDC 13SDC	664	129	29
	Bar	1	1.2	1.6	2	2.4	2.8	3.2	3.6	3.8	4	
	Psi	15	17	23	29	35	41	46	52	55	58	
	Stat	2990	3290	3890	4485	5085	5685	6285	6880	7180	7480	
	10 km/h Cyc	1950	2145	2535	2925	3315	3710	4100	4490	4685	4880	
	10 km/h	1630	1790	2115	2440	2765	3090	3410	3735	3900	4060	
	25 km/h	1380	1520	1795	2070	2345	2620	2895	3170	3305	3445	
	30 km/h	1350	1485	1755	2025	2295	2570	2840	3110	3245	3380	
	40 km/h	1300	1430	1690	1950	2210	2470	2730	2990	3120	3250	

Ø inches	Description	CAI	e mm	D mm	R' mm	RC mm	Recommended Rim		Acceptable Rim	Tube (Code)	75% internal volume (litres)	Tread depth (mm)				
24	400/70-24 IND 158A8 TL <i>16.0/70 - 24 / 405/70 - 24 (Equiv 20PR)</i>	407878	418	1173	535	3497	DW13		13 14 DW14L	703	165	29				
	Bar	1	1.2	1.6	2	2.4	2.8	3.2	3.6	3.8	4	4.2	4.4	4.6	4.8	5
	Psi	15	17	23	29	35	41	46	52	55	58	61	64	67	70	73
	Stat	3290	3615	4265	4910	5560	6210	6855	7505	7830	8155	8480	8800	9125	9450	9775
	10 km/h Cyc	2145	2355	2780	3205	3625	4050	4470	4895	5105	5320	5530	5740	5950	6165	6375
	10 km/h	1790	1965	2320	2670	3025	3375	3730	4080	4260	4435	4610	4785	4965	5140	5315
	25 km/h	1515	1665	1965	2265	2560	2860	3160	3460	3610	3760	3905	4055	4205	4355	4505
	30 km/h	1485	1630	1925	2220	2510	2805	3100	3395	3540	3685	3835	3980	4125	4275	4420
	40 km/h	1430	1570	1855	2135	2415	2700	2980	3265	3405	3545	3685	3825	3970	4110	4250

* Refer to the notes at the end of the tables of this range

MICHELIN POWER CL

Tire specifications and pressure table (bar & psi). Load per tire in kg*

Ø inches	Description	CAI	e mm	D mm	R' mm	RC mm	Recommended Rim	Acceptable Rim	Tube (Code)	75% internal volume (litres)	Tread depth (mm)
24	460/70-24 IND 159A8 TL 17.5 L - 24 (Equiv 18PR)	474764	457	1241	558	3687	DW15L	14 DW14L DW16L 16	710	217	29
	Bar	1	1.2	1.6	2	2.4	2.8	3.2	3.6	3.8	4
	Psi	15	17	23	29	35	41	46	52	55	58
	Stat	3450	3890	4770	5655	6535	7415	8295	9180	9620	10060
	10 km/h Cyc	2250	2535	3110	3685	4260	4835	5410	5985	6275	6560
	10 km/h	1875	2115	2595	3075	3555	4030	4510	4990	5230	5470
	25 km/h	1590	1795	2200	2605	3015	3420	3825	4235	4435	4640
	30 km/h	1560	1760	2160	2555	2955	3355	3755	4150	4350	4550
	40 km/h	1500	1690	2075	2460	2840	3225	3610	3990	4185	4375

Ø inches	Description	CAI	e mm	D mm	R' mm	RC mm	Recommended Rim	Acceptable Rim	Tube (Code)	75% internal volume (litres)	Tread depth (mm)					
24	400/80-24 IND 162A8 TL 15.5/80 - 24 (Equiv 20PR)	050267	414	1257	571	3743	DW13	13 14 DW14L	703	187	29					
	Bar	1	1.2	1.6	2	2.4	2.8	3.2	3.6	3.8	4	4.2	4.4	4.6	4.8	5
	Psi	15	17	23	29	35	41	46	52	55	58	61	64	67	70	73
	Stat	3680	4045	4770	5495	6220	6945	7670	8395	8755	9120	9480	9845	10205	10570	10930
	10 km/h Cyc	2400	2635	3110	3585	4055	4530	5000	5475	5710	5950	6185	6420	6655	6895	7130
	10 km/h Cyc Dual	1500	1625	1875	2125	2375	2625	2875	3125	3250	3375	3500	3625	3750	3875	4000
	10 km/h	2000	2195	2590	2985	3380	3775	4165	4560	4760	4955	5150	5350	5545	5745	5940
	25 km/h	1695	1860	2195	2530	2865	3200	3530	3865	4035	4200	4365	4535	4700	4870	5035
	30 km/h	1660	1825	2150	2480	2810	3135	3465	3790	3955	4120	4285	4450	4610	4775	4940
	30 km/h FRT	3000	3050	3150	3250	3350	3450	3550	3650	3700	3750	3800	3850	3900	3950	4000
	40 km/h	1600	1760	2075	2390	2705	3020	3335	3650	3805	3965	4120	4280	4435	4595	4750

Ø inches	Description	CAI	e mm	D mm	R' mm	RC mm	Recommended Rim	Acceptable Rim	Tube (Code)	75% internal volume (litres)	Tread depth (mm)
24	500/70-24 IND 164A8 TL 19.5 L - 24 (Equiv 20PR)	196220	504	1315	588	3903	DW16L	DW15L 16	710	264	29
	Bar	1	1.2	1.6	2	2.4	2.8	3.2	3.6	3.8	4
	Psi	15	17	23	29	35	41	46	52	55	58
	Stat	3910	4415	5430	6440	7450	8465	9475	10490	10995	11500
	10 km/h Cyc	2550	2880	3540	4200	4860	5520	6180	6840	7170	7500
	10 km/h	2125	2400	2950	3500	4050	4600	5150	5700	5975	6250
	25 km/h	1800	2035	2500	2965	3435	3900	4365	4835	5065	5300
	30 km/h	1770	2000	2455	2915	3370	3830	4285	4745	4970	5200
	40 km/h	1700	1920	2360	2800	3240	3680	4120	4560	4780	5000

* Refer to the notes at the end of the tables of this range

MICHELIN POWER CL

Tire specifications and pressure table (bar & psi). Load per tire in kg*

Ø inches	Description	CAI	e mm	D mm	R' mm	RC mm	Recommended Rim		Acceptable Rim	Tube (Code)	75% internal volume (litres)	Tread depth (mm)				
24	440/80-24 IND 168A8 TL 16.9 - 24 / 16.5/85 - 24 (Equiv 22PR)	165629	460	1328	596	3944	DW15L		DW13 14 DW14L	710	236	29				
	Bar	1	1.2	1.6	2	2.4	2.8	3.2	3.6	3.8	4	4.2	4.4	4.6	4.8	5
	Psi	15	17	23	29	35	41	46	52	55	58	61	64	67	70	73
	Stat	4340	4765	5620	6475	7330	8185	9035	9890	10320	10745	11170	11600	12025	12455	12880
	10 km/h Cyc	2830	3110	3665	4225	4780	5335	5895	6450	6730	7010	7285	7565	7845	8120	8400
	10 km/h	2360	2590	3055	3520	3985	4450	4910	5375	5610	5840	6070	6305	6535	6770	7000
	25 km/h	2005	2200	2595	2990	3380	3775	4165	4560	4755	4955	5150	5345	5540	5740	5935
	30 km/h	1960	2155	2540	2925	3310	3695	4085	4470	4660	4855	5050	5240	5435	5625	5820
	40 km/h	1890	2075	2445	2820	3190	3560	3930	4300	4485	4675	4860	5045	5230	5415	5600

Ø inches	Description	CAI	e mm	D mm	R' mm	RC mm	Recommended Rim		Acceptable Rim	Tube (Code)	75% internal volume (litres)	Tread depth (mm)
26	480/80-26 IND 167A8 TL 18.4 - 26 (Equiv 20PR)	226486	504	1417	637	4211	DW16L		DW15L	716	302	28
	Bar	1	1.2	1.6	2	2.4	2.8	3.2	3.6	3.8	4	
	Psi	15	17	23	29	35	41	46	52	55	58	
	Stat	4920	5415	6400	7390	8375	9365	10350	11445	11990	12535	
	10 km/h Cyc	3210	3530	4175	4820	5465	6105	6750	7465	7820	8175	
	10 km/h	2670	2940	3475	4015	4555	5090	5630	6225	6520	6815	
	25 km/h	2270	2495	2950	3405	3860	4315	4770	5275	5530	5780	
	30 km/h	2220	2445	2890	3340	3785	4235	4680	5175	5425	5670	
	40 km/h	2140	2355	2785	3215	3640	4070	4500	4975	5215	5450	

Ø inches	Description	CAI	e mm	D mm	R' mm	RC mm	Recommended Rim		Acceptable Rim	Tube (Code)	75% internal volume (litres)	Tread depth (mm)
28	440/80-28 163A8 TL 16.9 - 28 / 16.5/85 - 28 (Equiv 18PR)	691578	449	1412	642	4201	DW15L		DW14L DW13	822	259	29
	Bar	1	1.2	1.6	2	2.4	2.8	3.2	3.6	3.8	4	
	Psi	15	17	23	29	35	41	46	52	55	58	
	Stat	4370	4810	5685	6565	7445	8320	9200	10210	10710	11215	
	10 km/h Cyc	2850	3135	3710	4280	4855	5425	6000	6660	6985	7315	
	10 km/h	2375	2615	3090	3570	4045	4525	5000	5550	5820	6095	
	25 km/h	2015	2215	2620	3025	3430	3835	4240	4705	4940	5170	
	30 km/h	1975	2175	2570	2970	3365	3765	4160	4615	4845	5070	
	40 km/h	1900	2090	2475	2855	3235	3620	4000	4440	4655	4875	

* Refer to the notes at the end of the tables of this range

MICHELIN POWER CL

Tire specifications and pressure table (bar & psi). Load per tire in kg*

Ø inches	Description	CAI	e mm	D mm	R' mm	RC mm	Recommended Rim	Acceptable Rim	Tube (Code)	75% internal volume (litres)	Tread depth (mm)
30	420/80-30 IND 155A8 TL <i>16,9 - 30 (Equiv 14PR)</i>	577845	432	1432	656	4296	DW15L	DW13 DW14L	754	245	36
Bar	1	1.2	1.6	2	2.4	2.8	3.2				
Psi	15	17	23	29	35	41	46				
10 km/h Cyc	2760	3040	3595	4150	4705	5260	5815				
10 km/h	2300	2530	2995	3455	3920	4380	4845				
25 km/h	1950	2145	2540	2930	3325	3715	4110				
30 km/h	1915	2105	2490	2875	3260	3645	4030				
40 km/h	1840	2025	2395	2765	3135	3505	3875				

***IMPORTANT:**

The inflation pressure must always be appropriate for the load per tire, the speed of travel and the work to be done. Our recommendations above are provided subject to changes made after the date of publication of these tables. Technical data is subject to change without prior notice.

- For use on side slopes: add 0.4 bar.
- For intense road use, add 0.4 bar.
- Stat: static load.
- 10 km/h Cyc: max. speed 10 km/h with cyclic load.

AGRICULTURE USER GUIDE

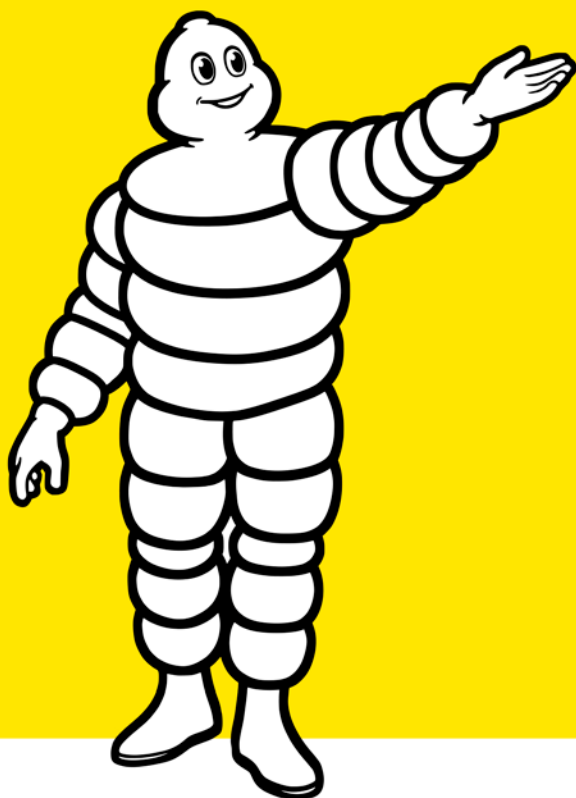

APRIL 2022

 [PROFESIONAL.MICHELIN.NO](https://www.profesional.michelin.no)

 [MICHELIN NORDIC](#)



CONTENTS

SELECT A TIRE, USE AND OPERATION	3
TIRE MARKINGS	4
LOAD INDICES AND SPEED RATINGS	5
OPERATING INSTRUCTIONS	6
CALCULATION OF MECHANICAL LEAD	7
FRONT WHEEL LEAD % MEASUREMENT	8
LOAD-BALANCING CALCULATION	9
RIM AND O-RING REFERENCES	11
INNER TUBE AND VALVE REFERENCES	12
VALVE CHARACTERISTICS	16
INSTRUCTIONS FOR REMOVING / FITTING TIRES	18

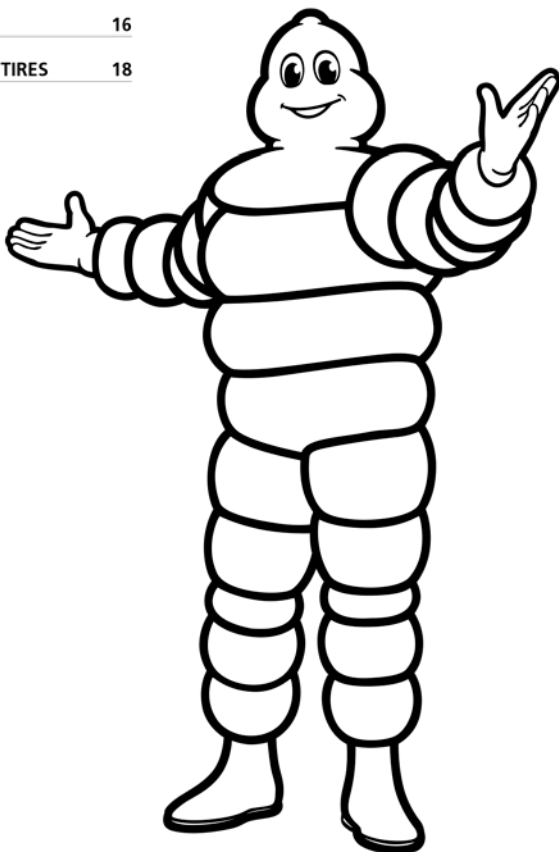

SELECT A TIRE, USE AND OPERATION

Tire selection must comply with regulations and the equipment recommended by the manufacturers of the vehicle and equipment, or an official organisation (size, load index and speed rating, structure - radial/bias, etc.).

Consideration must be given to the conditions under which the tire is to be used so that its performance meets users' requirements.

When changing a vehicle's original equipment, make sure the planned solution meets current regulations, check the vehicle's constraints and the manufacturer's recommendations (refer to local legislation).

In some countries, a vehicle modified in this way must receive authorisation from the relevant authorities.

MICHELIN tires are designed for a specific use. Any other use constitutes abnormal use.

However in some cases, Michelin can authorise a waiver which will specify the accepted usage limits and conditions under the waiver.

Michelin will not be held liable for abnormal use of its tires or use in the absence of any express, written waiver.

Prior to being fitted, all used or worn tires or tires involved in an accident must be thoroughly inspected by a professional to guarantee user safety and compliance with current regulations.

Incorrect use or choice of tire may also contribute to some mechanical parts experiencing premature wear.

TIRE MARKINGS

WHAT DO THE MARKINGS ON A TIRE MEAN?



XeoBib	Range
VF = Very High Flexion	Prefix designating a standardised category of tires
650	Nominal section width of the tire in mm
60	Aspect ratio (ratio between sidewall height/nominal tire section) as a %
R	Structure: «R» for radial «-» for bias Nominal rim
38	Rim diameter in inches
155	Standardized load index (see page 13)
D	Standardized speed rating (see page 13)
Radial	Structure
Tubeless	Tire with no inner tube
Michelin® X®	Trademark

TIRE DIMENSIONS

- SW Tire section width
- R' Static Loaded Radius
- OD Overall diameter = 2 R
- ø Rim diameter

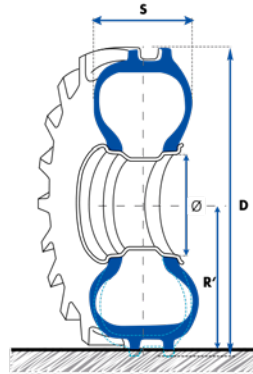

THE 42" SERIES... AND 38" EQUIVALENT

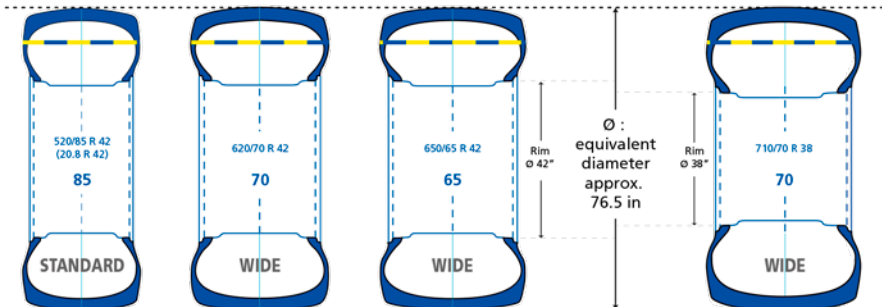

LOAD INDICES AND SPEED RATINGS

All tires come with operational references comprising the load capacity index (number) and speed rating (letter or letter and number).

The tables below show the tire load indexes and speed ratings with corresponding values

LOAD INDEXES

Index	Load in kg	Index	Load in kg	Index	Load in kg	Index	Load in kg	Index	Load in kg	Index	Load in kg
101	825	117	1285	133	2060	149	3250	165	5150	181	8250
102	850	118	1320	134	2120	150	3350	166	5300	182	8500
103	875	119	1360	135	2180	151	3450	167	5450	183	8750
104	900	120	1400	136	2240	152	3550	168	5600	184	9000
105	925	121	1450	137	2300	153	3650	169	5800	185	9250
106	950	122	1500	138	2360	154	3750	170	6000	186	9500
107	975	123	1550	139	2430	155	3875	171	6150	187	9750
108	1000	124	1600	140	2500	156	4000	172	6300	188	10000
109	1030	125	1650	141	2575	157	4125	173	6500	189	10300
110	1060	126	1700	142	2650	158	4250	174	6700	190	10600
111	1090	127	1750	143	2725	159	4375	175	6900	191	10900
112	1120	128	1800	144	2800	160	4500	176	7100	192	11200
113	1150	129	1850	145	2900	161	4625	177	7300	193	11500
114	1180	130	1900	146	3000	162	4750	178	7500	194	11800
115	1215	131	1950	147	3075	163	4875	179	7750	195	12150
116	1250	132	2000	148	3150	164	5000	180	8000	196	12500

SPEED RATINGS

Code	Speed in km/h	Speed in mph
A2	10	6
A5	25	15
A6	30	20
A8	40	25
B	50	30
D	65	40
E	70	44
F	80	50
G	90	55
J	100	60

UNITS OF MEASUREMENT

1 centimetre	cm	= 0.3937 inch	1 inch	in	= 2.54 cm
1 metre	m	= 3.281 feet	1 foot	ft	= 0.3048 m
1 kilometre	km	= 0.6214 mile	1 mile	mi	= 1.6093 km
1 litre	l	= 0.2199754 imp. gallons	1 imp. Gallon	imp. gall.	= 4.545963 litres
1 kilogram	kg	= 2.204622 pounds	1 pound	lb	= 0.4535924 kg
1 horsepower	hp	= 735.499 W	1 kilowatt	kw	= 1.3596216173 hp
1 bar	bar	= 14.5037738 psi	1 bar	bar	= 100 kPa (kilopascal)
1 pound per square inch	psi	= 6.89476 kPa	1 imp. acre		= 0.4046842 ha
1 hectare	ha	= 2.4711 imp. acres	1 square inch (imp.)	sq in	= 6.451578 cm ²
1 square centimetre	cm ²	= 0.1550 sq.in (imp.)	1 tonne	t	= 0.9842064 tn (imp)
1 ton (imp)	tn	= 1.016047 t	1 kilometre/hour	km/h	= 0.62137 mph
1 mile per hour	mph	= 1.609344 km/h			

OPERATING INSTRUCTIONS

■ DETERMINING TIRE PRESSURE

- Tire pressure is always determined in relation to load per tire, speed and work to be carried out.
- The load used is the highest: For tractors:
 - front axle: tractor with its weights / front equipment in the transport position and no rear axle load
 - rear axle: tractor with equipment in the transport position.

Note : for a tractor equipped with a front loader, assume max. load on the loader.

For harvesters: full load (full hopper) with cutting bar (or picker).

Note : for harvesters, determine the axle load:

- front axle with fully loaded bin and head attached, use cyclic loading speed schedule and pressure.
 - front axle with folding head, empty bin using road speed schedule and pressure.
 - rear axle without the cutter bar or picker
- Determine the pressure for «field use» and «road use» and select the higher of the two.
 - For intensive road use or on slopes and inclines, follow the instructions given in "Technical specifications of MICHELIN tires".

■ WHEN IN USE

- Distribute loads across axles evenly, and ensure adequate load / tire to enable safe operation.
- Adapt your driving to the conditions (load, speed, slope, incline, condition of road or other terrain).

■ INFORMATION

- Check tire pressure regularly.
- Periodically check the condition of your tires and have them checked by a trained and qualified professional
Reminder:
 - Damage caused by a puncture or an impact may only become apparent after some time
 - Tires age even when not in use
- Have any repairs carried out by a trained and qualified professional.

CALCULATION OF MECHANICAL LEAD

For the transmission unit of a 4-wheel drive tractor to operate correctly the correct mechanical lead must be used. This rule does not apply in the case of 4 wheels of the same size.

Most tractor manufacturers impose a mechanical lead of between 0% and 6%. This lead is specific, and may vary depending on the manufacturer and the vehicle.

An inappropriate mechanical lead ratio

- increases fuel consumption,
- results in more rapid front and rear tire wear,
- results in more rapid wear on the transmission unit,
- results in poor tractor performance when doing some jobs (e.g. ploughing)

and causes

- abrupt front axle engagement,
- a loss in power and performance,
- deterioration of the top soil.

Note: Over-loading or over-inflation of tires changes their dimensions.

Calculation of mechanical lead:

$$\frac{(RC_{\text{FRONT}} \times R) - RC_{\text{REAR}}}{RC_{\text{REAR}}} \times 100 = \text{mechanical lead in \%}$$

RC_{rear} : Rear tire rolling circumference (specified in the technical documentation)

RC_{front} : Front tire rolling circumference (specified in the technical documentation)

R: inter-axle ratio (This is fixed initially by the manufacturer)

FRONT WHEEL LEAD % MEASUREMENT



Put marks on the tires as picture above.

■ STEP 1 :

FRONT AXLE **NOT ENGAGED** (out of 4WD)

Do 10 turns of rear tires and count the number **N** of turns for front.

■ STEP 2 :

FRONT AXLE **ENGAGED** (in 4WD)

Do 10 turns of rear tires and count the number **N1** of turns for front.

$$\text{Calculation of measurement} = \frac{(N1 - N)}{N} \times 100$$

LOAD-BALANCING CALCULATION

SINGLE FITTING

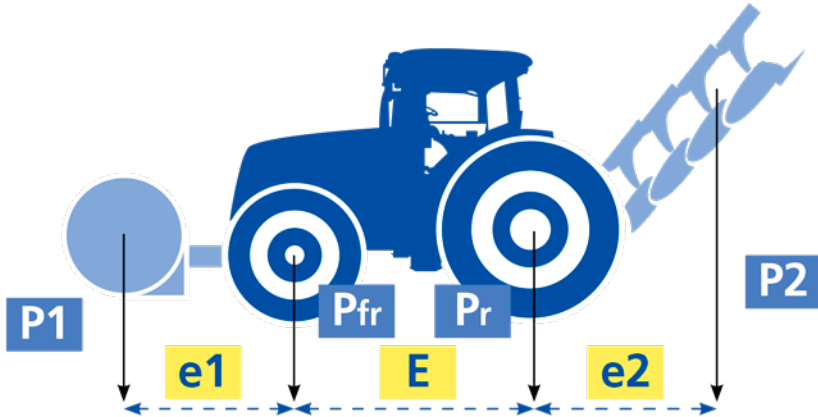

	Front axle (fr)	Rear axle (re)
Tractor (kg)	P fr	P re
Equipment or weights (kg)	P 1	P 2
Calculation for equipment or weights (kg)	$P 1 \times (e1/E)$	$P 2 \times (e2/E)$
Total for axle (kg)	$P fr + P 1 + [P 1 \times (e1/E)]$	$P re + P 2 + [P 2 \times (e2/E)]$
Number of tyres	N fr	N re
Load per tyre (kg)	Total axle fr / N fr	Total axle re / N re



QR code to
access pressure
calculator app

Examples :

Data	Front	Rear
Tractor (kg)	3 000	5 000
Equipment or weights (kg)	1 000	2 000
Distance (metres)	$E = 3 \text{ m} / e1 = 1,5 \text{ m} / e2 = 2,5 \text{ m}$	

Calculations	Front axle (fr)	Rear axle (re)
Tractor (kg)	3 000	5 000
Equipment or weights (kg)	1 000	2 000
Calculation for equipment or weights (kg)	$1\,000 \times (1,5 / 3) = 500$	$2\,000 \times (2,5 / 3) = 1\,666$
Total for axle (kg)	$3\,000 + 1\,000 + 500 = 4\,500$	$5\,000 + 2\,000 + 1\,666 = 8\,666$
Number of tyres	2	2
Load per tyre (kg)	$4\,500 / 2 = 2\,250$	$8\,666 / 2 = 4\,333$

LOAD-BALANCING CALCULATION

■ DUAL *OR TRIPLE* FITTING

- 1 - Divide the axle load by 4 if dual (or by 6 if triple)
- 2 - Then divide the result by 0.88 if dual (or by 0.82 if triple)

* For load calculation, see previous page.

Example of a calculation for a dual fitting:

- Tractor with 650/85R38 MICHELIN MACHXBIB 173A8/173B TL
- Established axle load = 14000 kg
- Use = stubble plowing

a) If the Dual line at the desired speed is in the load/pressure table:

- divide the total load by 4 (4 tires)
- use the Dual line to determine pressure

b) If the Dual line at the desired speed is not in the load/pressure table:

- divide the total load by 4
- divide the result by 0.88
- use the desired speed line on the load/pressure table

Example for a total load of 14000 kg on a dual fitted rear axle:





$$[30,800 / 4] / 0.88 = 3977 \text{ kg}$$

i.e. recommended pressure of 0.8 bar for a speed of 30 km/h

Note: for triple fitting, divide the load by 6, then divide by 0.82 to obtain the load in question.



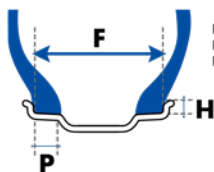

RIM AND O-RING REFERENCES

Ensure that the rim is compatible in terms of load and pressure with the use.

Type of rim	Sizes	Dimension F in mm	Dimension H in mm	Dimension P in mm
5° standard hollow rim 	2.50 C	63,5	16,5	
	3.00 D	76		
	3.50 D	89	18	
	4.00 E	101,5		18
	4.50 E	114,5	20	
	5.00 E	127		23,5
	5.375 I	136,5	16	23
	6.00 F	152,5	22,5	23,5
	6.50 F	165		
5° conical seat hollow rim 	9	228,5		27
	11	279,5		
	12	305	25,5	
	13	330		31,5
	14	355,5		
	16	406,4	25,4	
15° conical seat hollow rim 	10.50	266,7		
	11.75	298,5		
	12.25	311		
	13.00	330		
	14.00	355,5		
	15.00	381		
	16.00	406,5		
	AG 16.00	406,5	12,7	44
	17.00	432		
	18.00	457		
	20.00	508		
	AG 20.00	508		
	AG 24.00	609,5		
	AG 28.00	711		
3-PIECE RIM 	11	279,5		
	12	305	25,5	
	13	330		
	36.0 TH	914,4	38,1	
	36.00 VA	914,4	43,1	
W rim 	W 6	152,4		
	W 7	177,8	22,2	23,8
	W 8	203,2		
	W 8L	203,2		
	W 9	228,6	25,4	
	W 10	254		
	W 10L	254	22,2	27
	W 11	279,4		
	W 12	304,8		
	W 13	330,2		
	W 14L	355,6	25,4	
	W 15L	381		
	W 16L	406,4		33
	W 18L	457,2		



F = interior width
H = Flange height (+/- 1 mm)
P = Seat width

Type of rim	Sizes	Dimension F in mm	Dimension H in mm	Dimension P in mm	
DW rim 	DW 10	254			
	DW 11	279,4		27	
	DW 12	304,8			
	DW 13	330,2			
	DW 14L	355,6	25,4	36,5	
	DW 15L	381			
	DW 16L	406,4			
	DW 17L	431,8			
	DW 18L	457,2			
	DW 20B	508			
	DW 21B	533,4			
	DW 23B	584,2	28,6	50,8	
	DW 24B	609,5			
	DW 25B	635			
	DW 27B	686			
	DW 28B	711			
	DW 30B	762			
	TW rim 	TW 13	330		27
TW 14L		355,5			
TW 15L		381	25,5	36,5	
TW 16L		406,5			
TW 18L		457			
TW 20B		508			
TW 21B		533,5			
TW 23B		584	29	50,8	
TW 24B		609,5			
TW 25B		635			
DD rim 	DD 16L	406,5	41	50,5	
	DD 18L	457			
	MW rim 	MW 20	508		
		MW 23	584	29	50,8
		MW 25	635		
	DH27B rim 	DH 27B	686	29	54

If the DW rim is authorised then so is the corresponding TW rim (ETRTO)

O-RINGS FOR 3-PIECE RIMS

Reference	Designation	Note	IAC
R 1681	O-ring OR 6.6 - 20	For 20" rim in 3 pieces	553215
R 1438	O-ring OR 2 - 25	For 25" rim in 3 pieces	553201
R 2052	O-ring OR 2 - 32	For 32" rim in 3 pieces	553055

O-ring designations:

- OR: abbreviation of o-ring
- The first number is the section of the ring joint - a whole number expressing 8ths of an inch (e.g.: 2 = 2/8").
- The second number is the diameter of the seat - a whole number expressed in inches.

INNER TUBE AND VALVE REFERENCES

TIRE & RIM DESCRIPTION		VALVE		KLEBER TUBE		MICHELIN TUBE		TUBES / PACK
RIM Ø (INCHES)	TIRE SIZE	VALVE REF.	VALVE OFFSET	KLEBER REF.	KLEBER CAI	MICHELIN REF.	MICHELIN CAI	
6	3.50 - 4.00	10SC29	0	826	158611			8
8	4.00	10SCH40	0	360	125528			8
12	4.00	TR13	13			12C13	125674	40
	7.00	TR15	25	389	101397			4
15	4.00	TR13	15			15CB13	125682	40
	5.00 - 6.70	TR13	22			15F13	125622	24
15.3	10.0/75 - 11.5/80 - 12.5/80	TR15	80	463	170029			4
16	4.50	TR218A	19	420	101467	M420	834861	4
	5.50 - 6.00	TR15	60	182	170010	M182	884753	4
	6.00 - 6.50	TR218A	60	313	039318	M313	183634	1
	6.50 - 7.00	TR15	65	311	170014			4
	7.50	TR218A	70	431	170000	M431	509471	1
	7.50	TR13	25			16J13	125639	16
	7.50	TR15	70	317	170016	16J15	125669	16
	10.00 - 11.00	TR218A	90	485	170030	M485	410859	1
	11LR - 280/70	TR218A	65	184	171108	M184	764859	1
	10.50 - 270/65 - 275/65 - 320/65	TR218A	65	827	813635	M827	030552	1
16.5	260/70 - 300/70	TR218A	65	184	171108	M184	764859	1
18	7.50	TR218A	70	440	170001	M440	594387	1
	7.50	TR15	70	441	170023			4
	10.5/80 - 280/80 - 260/70 - 280/70 - 270/65	TR218A	70	438	171109	M438	582674	1
	12.0 - 12.5 - 335/80 - 340/80 - 320/65 - 340/65	TR218A	90	444	170025	M444	756917	1
	12.0 - 12.5 - 335/80 - 340/80 - 13.0/65 - 320/65 - 335/65 - 340/65	TR15	80	828	057866	M828	126008	1
19	4.00 - 4.50	TR13	15	446	101417			4
	6.00	TR13	50	449	320346			1
	6.00	TR15	50	452	170026			1
19.5	445/70 (18 R 19.5)	DR1964				19.5/20.5 UD	101280	3

INNER TUBE AND VALVE REFERENCES

TIRE & RIM DESCRIPTION		VALVE		KLEBER TUBE		MICHELIN TUBE		TUBES / PACK
RIM Ø (INCHES)	TIRE SIZE	VALVE REF.	VALVE OFFSET	KLEBER REF.	KLEBER CAI	MICHELIN REF.	MICHELIN CAI	
20	7.50	TR218A	65	655	170004	M655	575125	1
	7.50	TR15	60	660	170033			4
	9.5 - 260/70 - 280/70	TR218A	65	533	171110	M533	504653	1
	10.00 (Flap)					20x7.50 E	320222	5
	10.00 (Tube)	582				20N	101162	7
	10.5 - 11.2 - 280/80 - 300/70 - 320/70	TR218A	90	542	171111			1
	12.4 - 320/85 - 12.5/80 - 335/80 - 340/80 - 340/75	TR218A	90	444	170025	M444	756917	1
	12.5 - 14.5 - 14.9 - 335/80 - 340/80 - 340/75 - 375/75 - 380/75 - 420/75 - 425/75 - 360/70 - 400/70 - 405/70 - 420/65 - 440/65	TR218A	90	664	171112	M664	657648	1
	For 375/75 and 405/70 R 20 on flat rim	750				20RD	101394	5
	For 425/75 R 20 on flat rim	576				20V	511937	1
For 20" rims in 3 pieces	O-Ring 1681				OR 6.6 - 20	553215	20	
20.5	20.5 - 525/65	DR1964	75			19.5/20.5 UD	101280	3
	24	SC1837	100			20.5W AMD	101331	1
22.5	600/55	TR218A	90	716	170047	M716	346313	1
24	8.3 - 9.5 - 250/85	TR218A	70	686	170035	M686	820931	1
	11.2 - 12.4 - 280/85 - 320/85 - 320/70 - 360/70	TR218A	85	692	170037	M692	970338	1
	13.6 - 14.5 - 340/85 - 380/70 - 420/65	TR218A	85	700	170039	M700	519392	1
	14.9 - 380/85 - 400/80 - 400/70 - 420/70 - 440/65	TR218A	127	703	171114	M703	027015	1
	16.9 - 17.5LR - 19.5LR - 420/85 - 440/80 - 440/70 - 445/70 - 460/70 - 480/70 - 495/70 - 500/70 - 540/70 - 480/65 - 540/65	TR218A	100	710	170042	M710	460503	1
25	1000/50 - For 25" rims in 3 pieces	O-Ring R 1438				OR 2-25 HEUPO	553201	20
26	18.4 - 480/80 - VF520/80 - 480/70 - 520/70 - 580/70 - VF620/70	TR218A	90	716	170047	M716	346313	1
	23.1 - 620/75 - 580/70 - 620/70	TR218A	110	830	823746	M830	036738	1
	620/70	TR218A	110	717	101447	M717	438361	1
	750/65	TR218A	160	833	975074			1
26.5	600/55	TR218A	90	716	170047	M716	346313	1



INNER TUBE AND VALVE REFERENCES

TIRE & RIM DESCRIPTION		VALVE		KLEBER TUBE		MICHELIN TUBE		TUBES / PACK	
RIM Ø (IN-CHES)	TIRE SIZE	VALVE REF.	VALVE OFFSET	KLEBER REF.	KLEBER CAI	MICHELIN REF.	MICHELIN CAI		
28	9.5 - 11.2 - 280/85	TR218A	65	725	170050	M725	330841	1	
	12.4 - 320/85 - 360/70	TR218A	85	726	170051	M726	316215	1	
	13.6 - 340/85 - 380/70 - 420/65	TR218A	85	732	170053	M732	049533	1	
	14.9 - 380/85 - 420/70 - 440/65 - VF480/60	TR218A	85	821	170148	M821	483956	1	
	16.9 - 19.5LR - 420/85 - 440/80 - 480/70 - 480/65 - 540/65 - VF520/60 - VF600/60	TR218A	120	822	170149	M822	428511	1	
	600/70 - 600/65	TR218A	110	717	101447	M717	438361	1	
30	14.9 - 380/85 - 420/70	TR218A	90	734	170054	M734	626564	1	
	16.9 - 420/90 - 420/85 - 420/80 - 480/70 - 540/65 - VF540/65	TR218A	95	754	170058	M754	743325	1	
	18.4 - 460/85 - 520/70 - VF600/60	TR218A	95	757	170060	M757	579464	1	
	23.1 - 520/85 - 620/75 - IF620/75 - VF620/75 - 600/70 - IF600/70 - VF620/70	TR218A	92	737	192251	M737	589735	1	
32	8.3 - 9.5 - 210/95 - 230/95	TR218A	70	758	013109			1	
	11.2 - 270/95	TR218A	70	763	983325			1	
	12.4 - 320/85	TR218A	90	760	877890			1	
	24.5 - 30.5 - 680/85 - IF680/85 - 650/75 - 680/75 - 800/70 - IF800/70 - 800/65 - IF800/65 - 900/60 - IF900/60	TR218A	170	831	664520	M831	289134	1	
	1000/55 For 32" rims in 3 pieces	O-Ring R 2052					OR 2-32	553055	20
	16.9 - 380/85 - VF380/85 - 420/85 - VF420/85 - 480/70 - IF480/70 - 540/65	TR218A	95	704	171115	M704	862196	1	
34	18.4 - 460/85 - 500/70 - 520/70 - 540/70 - 600/65 - IF650/65 - VF600/60 - IF650/60	TR218A	100	823	170150	M823	164970	1	
	24.5 - 710/75	TR218A	180	765	101429			1	
	9.5 - 11.2 - 12.4 - 230/95 - 270/95 - 320/85	TR218A	65	779	170072	M779	404542	1	
36	13.6 - 340/85	TR218A	80	780	170073			1	

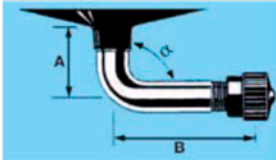
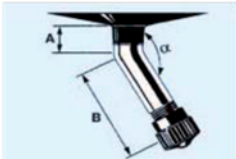
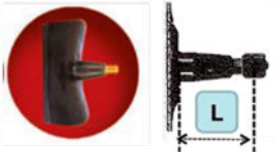

INNER TUBE AND VALVE REFERENCES

TIRE & RIM DESCRIPTION		VALVE		KLEBER TUBE		MICHELIN TUBE		TUBES / PACK
RIM Ø (INCHES)	TIRE SIZE	VALVE REF.	VALVE OFFSET	KLEBER REF.	KLEBER CAI	MICHELIN REF.	MICHELIN CAI	
38	11.2 - 12.4 - 270/95 - 320/85	TR218A	65	779	170072	M779	404542	1
	13.6 - 380/95 - VF380/95 - 340/85 - 380/80 - VF380/80	TR218A	90	795	170079	M795	456392	1
	14.9 - 16.9 - 380/85 - 420/85 - 480/70	TR218A	95	786	170076	M786	325321	1
	15.5 - 380/95 - VF380/95 - 380/80 - VF380/80 - 400/75	TR218A	90	796	118826	M796	044169	1
	18.4 - 460/85 - 520/70 - 540/65 - VF600/60	TR218A	100	824	170151	M824	156066	1
	20.8 - 520/85 - 580/70 - 620/70 - 600/65 - 650/65 - IF650/65 - VF650/60 - IF710/60 - VF710/60	TR218A	105	825	170152	M825	701676	1
	650/85 - IF650/85 - IF710/85 - 650/75 - IF650/75 - IF680/75 - 710/70 - IF800/70	TR218A	105	804	170088	M804	004503	1
42	16.9 - 18.4 - 480/80	TR218A	90	801	170084	M801	333630	1
	20.8 - 520/85 - VF520/85 - 580/85 - VF650/85 - IF710/75 - 620/70 - 710/70 - IF710/70 - 650/65 - VF650/65 - VF710/60	TR218A	140	802	170006	M802	158373	1
44	11.2 - 270/95	TR218A	80	813	440524			1
46	12.4 - 14.9 - 300/95 - 420/85 - 380/80 - VF380/80 - 420/80	TR218A	80	835	203376	M835	847882	1
	18.4 - 20.8 - 520/85 - 480/80 - VF480/80	TR218A	100	834	467962	M834	072291	1
48	9.5 - 11.2 - 230/95 - 270/95	TR218A	80	835	203376	M835	847882	1
50	320/90	TR218A	70	816	170007	M816	762800	1
52	12.4 - 300/95	TR218A	70	816	170007	M816	762800	1
54	11.2 - 270/95 - 320/90	TR218A	70	816	170007	M816	762800	1

VALVE CHARACTERISTICS

Sizes	Type of rim	Dimension F in mm
INNER TUBE VALVES		
10 SC29		A = 15 mm B = 29 mm $\alpha = 90^\circ$ \varnothing = valve hole = 10 mm
10 SCH40		A = 13 mm B = 27 mm $\alpha = 150^\circ$ \varnothing = valve hole = 10,2 mm
TR13 (ETRTO = V2-01-1)		L = 35 mm \varnothing = valve hole = 11,5 mm
TR15 (ETRTO = V2-01-2)		L = 35 mm \varnothing = valve hole = 16 mm
TR218A (ETRTO = V7-01-1) Air/water valve		L = 47,5 mm \varnothing = valve hole = 15,7 mm

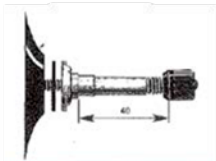
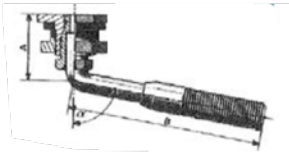
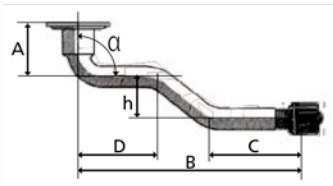
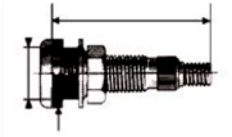
VALVE CHARACTERISTICS

Sizes	Type of rim	Dimension F in mm
INNER TUBE VALVES		
1964		L = 40 mm Ø = valve hole = 9,7 mm
1837 Equivalence : • TRA = TRJ650 • ETRTO = V5-04-1		A = 27 mm B = 79 mm $\alpha = 80^\circ$ Ø = valve hole = 20,5 mm
582 (ETRTO = V3.06.5)		A = 20,5 mm / B = 131 mm C = 49 mm / D = 62,5 mm $\alpha = 90^\circ$ / h = 17 mm
1123 (ETRTO = V3.06.8)		A = 24,5 mm / B = 126,5 mm C = 50,5 mm / D = 61,5 mm $\alpha = 94^\circ$ / h = 17 mm
TUBELESS VALVES		
TR618A (ETRO = V5-01-1) Air/water valve		L = 47,5 mm Ø = valve hole = 15,7 mm
AIR / WATER VALVE TIP		
		

INSTRUCTIONS FOR REMOVING / FITTING TIRES

There are risks in removing and fitting tires, so procedures must be carried out by trained and qualified staff, using appropriate tools and methods.

Never give this task to an unaccompanied apprentice; if several people are involved in the task eg when fitting large tires, ensure at least one experienced member of the team is present for all parts of the procedure.

The compressed air supply must be equipped with a pressure limit switch.

Failure to follow these instructions can lead to incorrect fitting of the tire on the rim, resulting in tire blow-outs and potentially serious or fatal injuries.

REMOVING A TIRE FROM THE RIM

1. Never try to unseal the rim and/or beads on an inflated tire.
2. The internal mechanism of the valve must be removed.
 - make sure that the tire is fully deflated before removing it,
 - do not use tools that may damage the sidewalls or the tire beads,
 - unseat the beads using the removal slots (if present),
 - to facilitate removal and protect the beads, particularly in case of a puncture, lubricate the rim seats and tire beads,
 - if the rim shows obvious signs of damage then the tire must be deflated before dismantling the assembly.

PREPARATION FOR FITTING

Ensure that the rim is compatible in terms of load and pressure with the use.

1. Before fitting, ensure that the rim, tire and inner tube are compatible, and check that:
 - the tire is compatible with the vehicle or machine
 - the diameter of the rim seat corresponds to the seat of the tire to be fitted (e.g.: 18.4 R 30 tire Rim: DW16L x 30),
 - the tire may be fitted to this rim (see characteristics in the Manufacturer's Documentation).

 Never fit 15" tires to rims with 15.3" seats.
Never fit 16" tires to rims with 16.1" or 16.5" seats.

2. Before fitting a tire to a rim that has already been used:
 - ensure the rim is clean and in perfect condition (showing no damage),
 - if not, then thoroughly clean the rim using a wire brush.

 Never fit a tire to a rim with cracks, distortion, signs of fracture, evidence of welded repairs, etc.

INSTRUCTIONS FOR REMOVING / FITTING TIRES

3. If the tyre has been used, carefully examine its interior and exterior for possible damage.
 - if it shows signs of damage or deterioration that are deemed irreparable by a specialist, discard the tyre.
4. For inner tube fittings, always use a new inner tube suitable for the tyre dimensions (inner tube markings showing compatible tyre sizes).

⚠ Do not fit the inner tube to a damaged or repaired rim, or to a rim with a finish incompatible with a tube.

Fit a new Tubeless valve whenever you replace a Tubeless tyre.

5. Always use tools that have no sharp edges, are in good condition and are suitable for the tyres and rims (bead unseating, levers, machines...).

For wide or large tyres, we recommend using a bead pusher or bead unseating tool (with appropriate mechanical assistance) to fit the second bead.

Before fitting, lubricate the rim seats and tyre beads. Apply a thin layer of lubricant to the surfaces shown on the diagram below; on the outside of the beads the lubricant should reach 5 cm above the rim flange.

Only use products designed for this purpose that will not degrade the tyre (do not for example use hydrocarbon, silicon or antifreeze-based products).

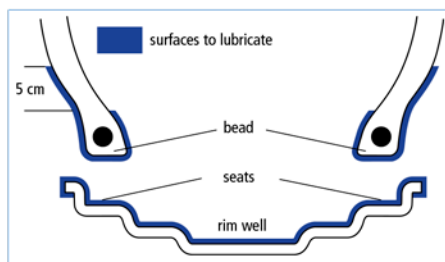

INSTRUCTIONS FOR REMOVING / FITTING TIRES

VERTICAL FITTING OF TIRE TO WHEEL

1. Position the valve or valve hole at the bottom.
2. If there is a diagram of the valve on the sidewall of the tire, position the diagram as close as possible to the rim valve hole or valve.
3. Slip the tire onto the rim so that the first tire bead is positioned against the rim flange. Remember to rotate in the direction indicated by the arrow on the tire (if present).
4. Using a suitable lever to apply pressure approximately every 10 cm:
 - push the first bead over the rim flange.

Once the first bead is over:

- position the lightly inflated inner tube inside the tire (for inner tube fittings),
- fix the valve by partially tightening the nut.

For the second bead:

- lever it over the rim flange,
- finishing at the valve.

5. Centring the tire, fitting the beads

- lower the jack slightly to optimise tire centring,
- always position the pry bar notch away from the valve
- pull out the valve's inner mechanism,
- slowly and partially inflate for optimal bead positioning,
- check the beads are not pinching the inner tube,
- inflate to 2.5 bar but no more, to ensure that the beads are properly positioned.

INFLATION AND BEAD POSITIONING

Apply safety rules:

- system to support the tire assembly (safety cage),
- safety goggles,
- safety footwear,
- ear defenders.

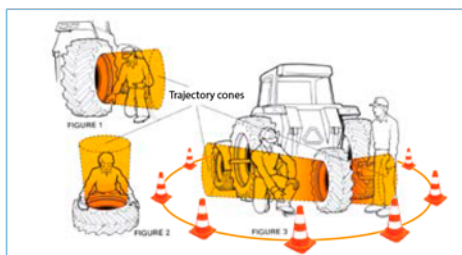

If there is no safety bar or cage, the operator should be as far as possible from the tire and the rim.

⚠ Never stand within the trajectory cones (Figures 1, 2 and 3), to avoid any risk of physical injury in the event of an incident.

For optimum safety conditions use a fully functional inflation gun connected to the valve by an air-hose extension of at least 3 meters, with a clip fitting to the valve and a calibrated pressure-gauge (never lock the trigger).

When positioning the beads take particular care to ensure they are correctly located and centred in relation to the rim flanges and inflate to 2.5 bar, but no more.

INSTRUCTIONS FOR REMOVING / FITTING TIRES

If the beads are not correctly positioned:

- deflate, re-lubricate and inflate to 2.5 bars
- repeat the operation as often as necessary until the beads are correctly positioned.

To fit and position the beads to the rim seats
INFLATE TO 2.5 BARS WITHOUT EXCEEDING THIS PRESSURE

The pictogram opposite shows the maximum inflation pressure which must not be exceeded when positioning the beads.

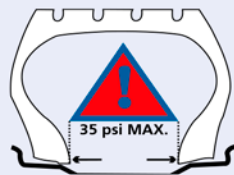

Once all the preceding operations have been properly executed,

- replace the valve's inner mechanism,
- tighten the nut on the valve by hand,
- inflate to the determined service pressure, according to the load levels stated in the manufacturer's documentation, or to storage pressure,
- tighten the valve cap after any inflation or pressure check, as this alone ensures that the valve remains clean and sealed.

If fitting the tire horizontally on the ground (not recommended because it is impossible to see if the lower bead is in place), take the following additional precautions:

- Initially, do not go above a maximum pressure of 0.7 bar (to establish the seal),
- Lift the tire-rim assembly, place it in a safety cage or position the upper part against a wall, never against a door or light partition wall,
- Follow the instructions for inflation and positioning the beads.

Note:

All radial tires to be used at low pressures must be fitted to high quality rims.

BEGINNING OPERATIONS / RECOMMENDATIONS

- When transporting machinery (by road, rail or ship), we recommend inflating tires to 1.8 bar (26 psi) to avoid damage due to certain stowage systems.
- When starting the machinery, pressures must be determined and adjusted according to the load on the tires and actual conditions of use.

USER INSTRUCTIONS

Correct pressure

=

- ✓ Comfort
- ✓ Grip
- ✓ Soil protection
- ✓ Type service life
- ✓ Optimal machine productivity

INSTRUCTIONS FOR REMOVING / FITTING TIRES

■ BALLASTING

• Ballasting tires with liquids

In specific cases, to increase adhesion weight or lower the machine's centre of gravity, both Tubeless and Tube Type tires can be ballasted with liquid.

Agricultural valves are "air and water". This means tires can be filled with liquid (water + anti-freeze) to a 75% maximum (diagram 1).

In winter, temperatures may fall below freezing and at 0°C the use of a Glycol based anti-freeze product is required. *As MICHELIN is not involved in the design of those products, MICHELIN's warranty specifically states that MICHELIN will not be held responsible for any associated damages to the tires.*

Fill the inner tube or tubeless tire with liquid up to the required level of water (max volume = 75% of tire capacity) and the valve at highest point, while releasing the air (diagram 2).

Inflation and pressure are adjusted using air.

As the volume of air providing pressure is low (around 25% volume), regular pressure checks are essential - we recommend monthly.

• Tubeless liquid ballasting

- Assemble and position the tire; see "Inflation and bead positioning",
- Deflate the tire to a low pressure (roughly 0.5 bar)
- Position the valve at the highest point,
- Start to fill the tire with liquid (water + anti-freeze), to a maximum of 75% while releasing the air (diagram 2),
- Finish inflating with air and adjust the pressure.

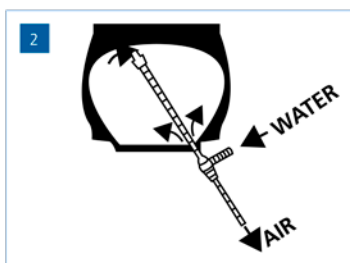
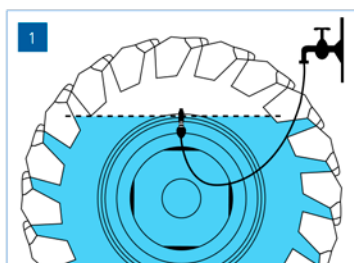

INSTRUCTIONS FOR REMOVING / FITTING TIRES

■ STORAGE

To be correctly stored, tires must be kept in clean conditions in dry and ventilated premises, away from direct sunlight. They must be kept away from:

- any source of ozone (electric motor, transformer, arc welding station etc..).
- any chemicals, solvents and hydrocarbons that may affect the nature of the rubber.
- any objects that could pierce the rubber (sharp or pointed metal objects etc.).

Keep away from flames or hot objects.

During storage periods, agricultural tires and inner tubes must be stored to avoid damage due to tension or compression, and so assembled and inflated if stacked; de-ballast vehicle-mounted tires as much as possible and over-inflate by 0.5 bar in relation to in-use pressures.

 **Never store bare tires or whole off-vehicle wheels in direct contact with the ground for long periods.**

The use of protective gloves is recommended when handling tires.

 **Never heat, weld or solder a rim or wheel with a tire fitted.**
Always remove the tire from the rim before any intervention.

 **Always use the Michelin inflation table to decide on the correct pressure for the intended use**

 **Under-inflation causes the carcass to become excessively misshapen and renders the tire unusable.**

 **Over-inflation reduces the surface area in contact with the ground, causing a loss of grip and making the tire more sensitive to impacts and cuts.**

 **If loads are lower than those shown in our load pressure tables, never go below the minimum tire pressure shown.**



AGRICULTURE TIRES TECHNICAL DATABOOK

2022

HEADQUARTERS

Manufacture Française des Pneumatiques MICHELIN
A partnership limited by shares with a capital of €504,000,004
Place des Carmes-Déchaux, 63040 Clermont-Ferrand Cedex 9, France
Tel.: +33(0)4 73 32 20 00

www.michelin.fr
Clermont Ferrand Trade and Companies Registry Number 855 200 507

MAY 2022

 PROFESIONAL.MICHELIN.NO

 [MICHELIN NORDIC](#)

