

TRACK EVENTS
TRAINING GUIDE FOR COMMISSAIRES
2019-2020

UPDATED MARCH 2019

CONTENTS

| | | |
|-------------------|--|-----------|
| CHAPTER 1. | STRUCTURES | 5 |
| | 1.1 THE STRUCTURE OF THE UCI | 6 |
| | 1.2 NATIONAL FEDERATIONS | 12 |
| | 1.3 CONTINENTAL CONFEDERATIONS | 13 |
| CHAPTER 2. | COMMISSAIRES | 14 |
| | 2.1 THE IMPORTANCE OF COMMISSAIRES | 15 |
| | 2.2 THE TRAINING OF COMMISSAIRES | 18 |
| | 2.3 THE SPECIALISATION OF COMMISSAIRES | 20 |
| | 2.4. THE CAREER OF AN INTERNATIONAL COMMISSAIRE | 22 |
| | 2.5. UCI TOOLS FOR COMMISSAIRES | 23 |
| | 2.6. CODE OF CONDUCT | 25 |
| | 2.7. CODE OF ETHICS | 26 |
| CHAPTER 3 | THE TRACK | 27 |
| | 3.1 DEFINITION OF THE TRACK | 28 |
| | 3.2 TRACK EQUIPMENT | 36 |
| | 3.3 PRACTICAL ORGANISATION OF THE TRACK | 44 |
| CHAPTER 4. | REGULATIONS | 53 |
| | 4.1 UCI REGULATIONS | 54 |
| | 4.2 NATIONAL FEDERATION REGULATIONS | 58 |
| | 4.3 SPECIAL REGULATIONS FOR A COMPETITION | 59 |
| | 4.4 KEY TRACK COMPETITIONS AND EVENTS | 60 |
| CHAPTER 5 | MANAGEMENT AND SUPERVISION OF COMPETITIONS | 62 |
| | 5.1. COMMISSAIRE ROLES | 64 |
| | 5.2. COMMISSAIRES' PANEL | 93 |
| | 5.3. ORGANISATION FUNCTIONS | 95 |
| | 5.4. INTERACTION BETWEEN THE COMMISSAIRES AND THE ORGANISATION | 98 |

| | | |
|-------------------|--|------------|
| CHAPTER 6 | PREPARATION FOR COMPETITION | 100 |
| | 6.1. THE PROGRAMME | 101 |
| | 6.2. PREPARATION AT HOME BEFORE THE COMPETITION | 106 |
| | 6.3. CHECKS AND VERIFICATIONS BEFORE THE COMPETITION | 107 |
| | 6.4. PREPARATION AT THE VELODROME BEFORE THE START | 109 |
| | 6.5. OFFICIAL TRAINING AND WARM UP SESSIONS | 119 |
| CHAPTER 7 | MEETINGS BEFORE THE RACE | 121 |
| | 7.1. MEETING WITH THE ORGANISER | 122 |
| | 7.2. COMMISSAIRES' MEETING | 123 |
| | 7.3. TEAM MANAGERS' MEETING | 124 |
| CHAPTER 8 | THE RUNNING OF THE TRACK | 127 |
| | 8.1. SAFETY OF TRACK ACTIVITIES | 128 |
| | 8.2. MEDIA ACTIVITIES | 130 |
| | 8.3. MEDICAL SERVICES | 133 |
| | 8.4. TECHNICAL SERVICES | 136 |
| CHAPTER 9 | THE TRACK DISCIPLINES | 142 |
| | 9.1. GENERAL CONDUCT | 143 |
| | 9.2. SPRINT EVENTS | 153 |
| | 9.3. PURSUIT EVENTS | 185 |
| | 9.4. ENDURANCE EVENTS | 198 |
| | 9.5. OTHER EVENTS | 220 |
| CHAPTER 10 | AFTER THE EVENTS AND COMPETITION | 228 |
| | 10.1. DEBRIEFING OF THE COMMISSAIRES' PANEL | 229 |
| | 10.2. DEBRIEFING WITH THE ORGANISER | 230 |
| | 10.3. UCI EVALUATION REPORT | 231 |
| | 10.4. SENDING THE RACE DOSSIER TO THE UCI | 232 |
| CHAPTER 11 | EQUIPMENT AND CLOTHING | 233 |
| | 11.1. EQUIPMENT | 234 |
| | 11.2. RACE NUMBERS | 243 |
| | 11.3. RIDERS' CLOTHING | 247 |
| | 11.4. CONDUCTING THE CHECK | 252 |

| | | |
|-------------------|---|------------|
| CHAPTER 12 | ANTI-DOPING | 255 |
| CHAPTER 13 | THE ENVIRONMENT | 259 |
| | 13.1. WHY IT MATTERS | 260 |
| | 13.2. PREPARATION FOR THE COMPETITION | 261 |
| | 13.3. DURING THE COMPETITION | 262 |
| CHAPTER 14 | MANAGEMENT AND RELATIONSHIP SKILLS | 264 |
| | 14.1. THE THREE CATEGORIES OF SKILLS | 265 |
| | 14.2. SPEAKING AND INTERVENTIONS BY THE COMMISSAIRE | 268 |
| | 14.3. RESPONDING TO AN INTERVIEW | 270 |
| | 14.4. MANAGEMENT OF THE COMMISSAIRES' TEAM | 270 |
| CHAPTER 15 | APPENDICES | 272 |
| | 15.1. GLOSSARY | 273 |
| | 15.2. RESOURCES | 278 |
| | 15.3. SUBMITTING DOCUMENT FEEDBACK | 283 |
| | DOCUMENT CHANGE CONTROL | 283 |

CHAPTER 1 STRUCTURES



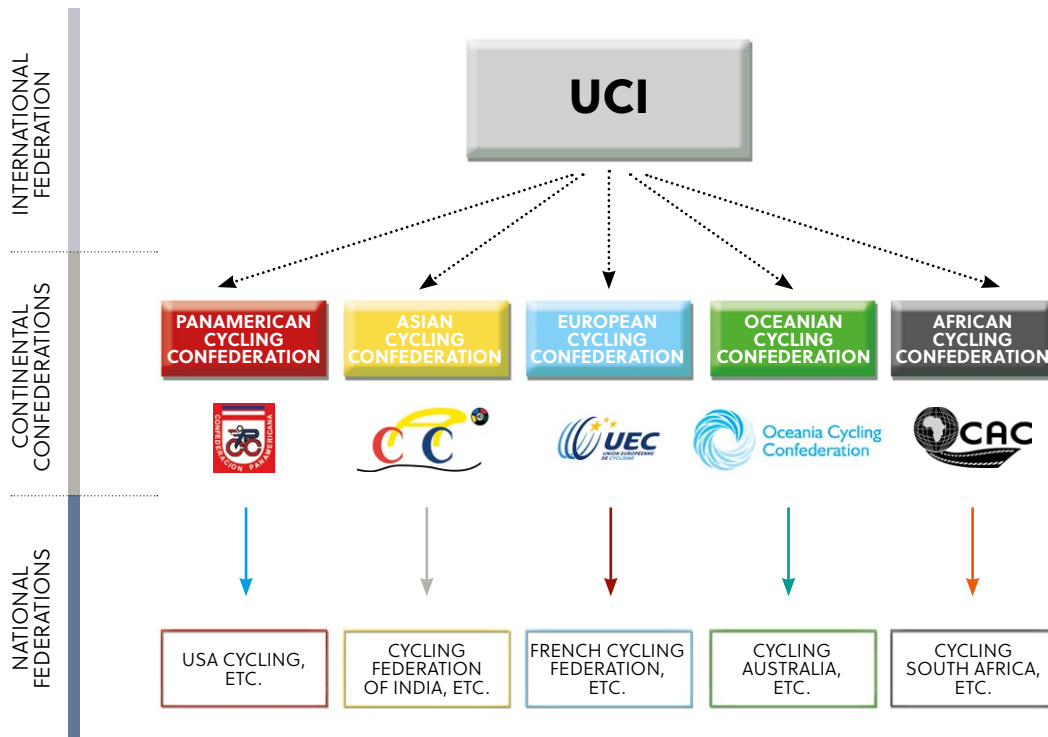

Diagram. Structures from international to national level

1.1. THE STRUCTURE OF THE UCI

1.1.1. GENERAL OPERATION



It is of primary importance for future Elite National and International Commissaires to have a good knowledge of the UCI and its missions. In fact, in the eyes of the athletes, organisers and authorities, Commissaires partially represent the UCI when carrying out their functions. Union Cycliste Internationale (International Cycling Union) is the international federation of cycling recognised by the International Olympic Committee. Established in Paris in 1900, the UCI now has its headquarters at the World Cycling Centre in Aigle, Switzerland.

The UCI coordinates and develops nine cycling disciplines (road, track, cyclo-cross, mountain bike, BMX - Racing and Freestyle, trials, indoor cycling and para-cycling) on all five continents.

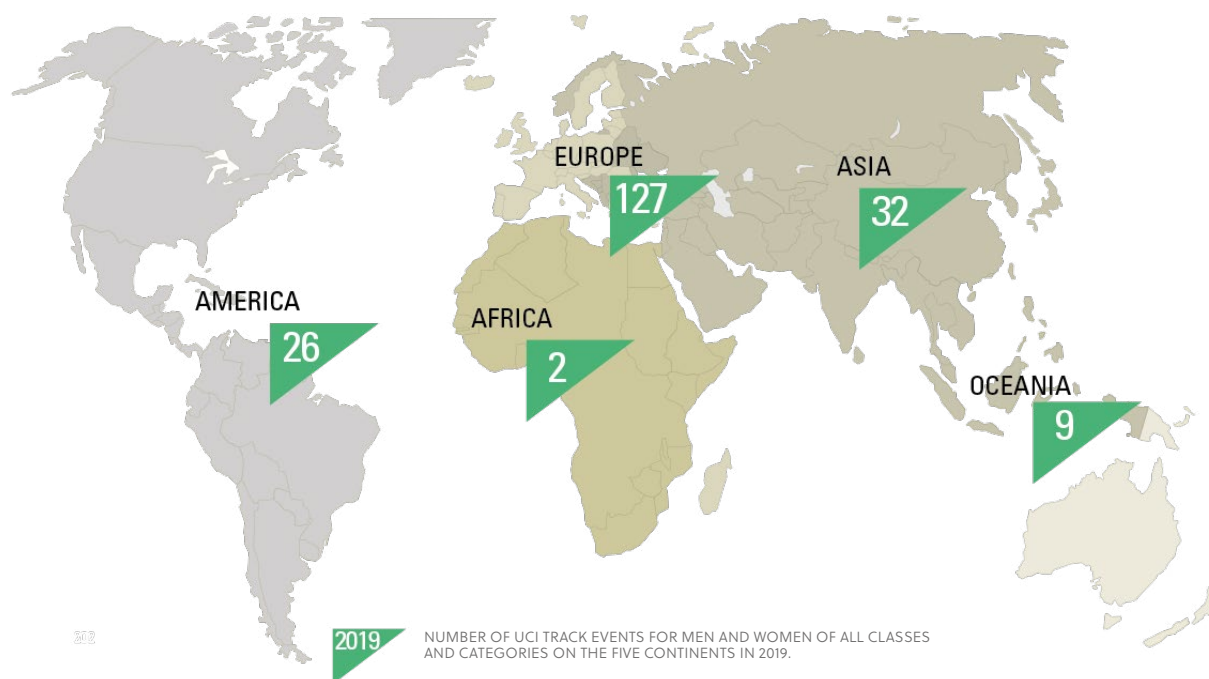

MAP. Number of UCI track events on the five continents in 2019.

The UCI's mission is to develop and promote cycling, in close collaboration with the National Federations (NF), as a competitive sport with its associated values (effort, achievement and fair play), as a recreational activity that is good for health, and also as an environmentally-friendly means of transport.

In order to carry out its mission, the UCI is supported by its administrative service, which, while respecting the values associated with the heritage of cycling:

- offers its skills and services to the NFs and other organisations in the cycling movement,
- supports education and development activities,
- responds to the needs of cyclists through innovative, concrete initiatives,
- represents cycling on sports and public bodies,
- regulates the sport of cycling,
- organises the World Championships, World Cups and cycling competitions of the Olympic and Paralympic Games.

IDENTITY



CONSTITUTION, CHAPTER I – ARTICLE 1

- The International Cycling Union (UCI) is the association of national cycling federations.
- The UCI is a non-governmental international association with a non-profit-making purpose of international interest.

MISSIONS



CONSTITUTION, CHAPTER I – ARTICLE 2

The objectives of the UCI are:

- to direct, develop, regulate, control and discipline cycling under all forms worldwide;
- to promote cycling in all the countries of the world and at all levels;
- to organize, for all cycling sport disciplines, world championships of which it is the sole holder and owner;
- to draw up regulations and provisions and ensure their enforcement;
- to encourage friendship between all members of the cycling world;
- to promote sportsmanship, integrity, ethics and fair play with a view to preventing all methods or practices such as corruption or doping, which might jeopardize the integrity of competitions, riders, officials and members or give rise to abuse of cycling;
- to promote gender-parity and equity in all aspects of cycling;
- to promote Para-cycling;
- to advocate for the safety and rights of cyclists ;
- to represent the sport of cycling and defend its interests before the International Olympic Committee, the International Paralympic Committee and all national and international authorities;
- to cooperate with the International Olympic Committee, the International Paralympic Committee in particular as regards the participation of cyclists in the Olympic Games.
- to direct, develop, regulate, control and discipline any and all virtual/electronic cycling activities and competitions under all forms worldwide and to organise world championships of which it is the sole holder and owner.



SPECIFICALLY, THE UCI:

- sets the dates of races on the international calendar,
- establishes the regulations for the disciplines of cycling,
- organises educational programmes,
- fights against doping.



THE PRINCIPLES OF RESPECT (CONSTITUTION, CHAPTER I – ARTICLE 3)

- equality between all the members and all the athletes, licence holders and officials, without racial, political, religious, gender related or other discrimination;
- non-interference in the internal affairs of affiliated federations;
- compliance with the Olympic Charter in everything to do with the participation of cyclists in the Olympic Games;
- the non-profit-making purpose: the financial resources shall be used only to pursue the purposes set forth in this Constitution. UCI members have no rights thereto.



MEMBERS (CONSTITUTION, CHAPTER II – ARTICLES 4 TO 22)

- The members of the UCI shall be the National Federations (NF) of cycling accepted by the Congress as being the representative organisation for cycling in general in the country of each NF.
- Only one federation per country is admitted.
- The UCI Regulations shall be incorporated in the corresponding regulations of the federations.
- The constitutions and regulations of the federations must not contradict those of the UCI. In the event of discrepancy, solely the Constitution and Regulations of the UCI shall apply. The constitutions and regulations of the federations must contain an express clause that, in the event of divergence with the UCI Constitution or Regulations, solely the latter shall apply.



OFFICIAL LANGUAGES (CONSTITUTION, CHAPTER XIV – ARTICLES 76 TO 78)



- The official languages of the UCI are French and English.
- The Constitution, Regulations and minutes, as well as all documents submitted to the Congress, shall be drawn up in French and English.
- All documents or letters sent to the UCI must be drafted in French or English.



SYMBOLS (CONSTITUTION, CHAPTER XV – ARTICLES 79 TO 81)



The flag, the colours arranged thereon, the logo and its reproduction, as well as the name "Union Cycliste Internationale" and the abbreviation "UCI" are the property of the International Cycling Union and may not be used without its consent.



COMPETENT COURTS (CONSTITUTION, CHAPTERS XIII AND XVI)



- The UCI Regulations established by the Management Committee, and in particular the anti-doping rules, may be subject to an appeal to the Court of Arbitration for Sport in Lausanne, Switzerland.
- The Court of Arbitration for Sport (CAS) is solely competent to hear and rule on appeals:
 - against sporting, disciplinary and administrative decisions taken in accordance with the UCI Regulations,
 - between UCI bodies, including Continental Federations, and disputes between federations.
- The Court of Arbitration for Sport is the court of last instance. Its rulings are final.
- Proceedings before the Court of Arbitration for Sport are governed by UCI Regulations and, for the rest, by the Code of Arbitration for Sport.

1.1.2.
GENERAL ORGANISATION OF THE UCI



Diagram. General organisation of the UCI

1.1.3.
MAIN BODIES

| | |
|---|--|
| <div style="background-color: #d3d3d3; padding: 10px; border: 1px solid #ccc; margin-bottom: 20px;"> <p style="text-align: center; margin: 0;">UCI CONGRESS</p> </div> | <ul style="list-style-type: none"> • This is the supreme body of control. • The representatives of accredited National Federations attend the Congress each year. • The Congress elects the Management Committee, to which it delegates responsibility for managing the UCI. |
| <div style="background-color: #c8e6c9; padding: 10px; border: 1px solid #ccc; margin-bottom: 20px;"> <p style="text-align: center; margin: 0;">MANAGEMENT COMMITTEE</p> </div> | <ul style="list-style-type: none"> • This is the decision-making body. Comprising 18 members, the Management Committee assumes a wide range of rights and responsibilities in order to undertake, without delay, any action required as a result of events or for the development of the UCI and the sporting disciplines. • The Management Committee sets up commissions, as it considers necessary, for the proper operation of the UCI. The Management Committee defines the areas in which the Commissions work, decides how they operate and appoints Commission members. |
| <div style="background-color: #e0f2f1; padding: 10px; border: 1px solid #ccc;"> <p style="text-align: center; margin: 0;">ADMINISTRATIVE SERVICE</p> </div> | <ul style="list-style-type: none"> • This is the operational body. It comprises individuals who are professionals in their sphere as well as former elite sportspeople. The Administrative Service is responsible for all operational tasks arising from Management Committee decisions. |

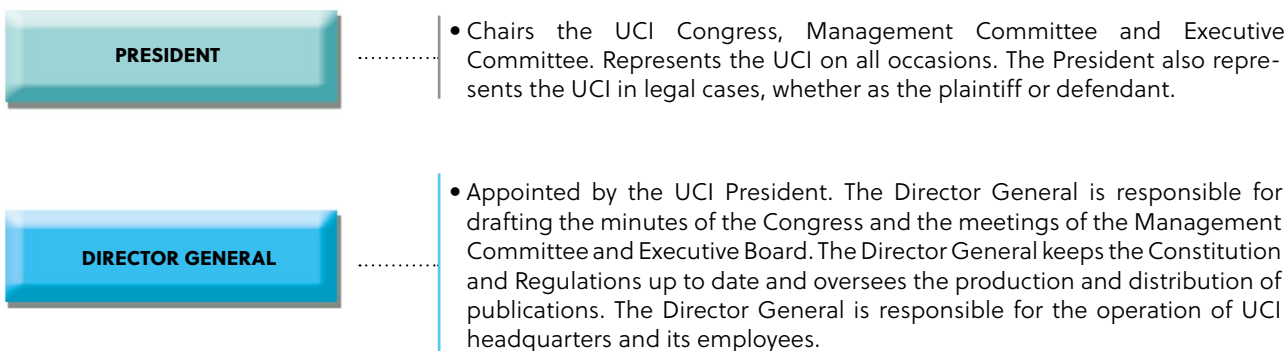

1.1.4.
SPORTS DEPARTMENT

The Sports Department is the UCI department that manages the **sporting organisation of cycling at a global level**. The department represents the direct link between:

- the organisers of cycling competitions and the UCI,
- the National Federations and the UCI,
- the teams/riders and the UCI.

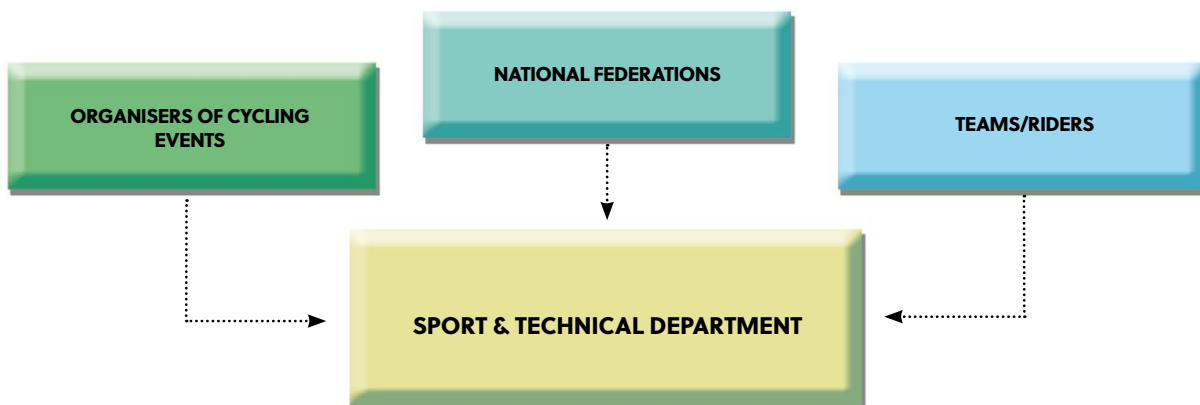

Diagram. The role of the UCI Sports Department

The Sports Department occupies a pivotal position at several levels:

- at an **administrative** level through the registration of teams and competitions on the UCI calendar,
- at a **sporting** level with the organisation of the World Championships for all disciplines,
- at an **economic** level with regards to financial obligations,
- at a **regulatory** level, with the reconciliation of the sporting regulations with the development of cycle sport,
- at the level of **refereeing** events, with the training of Elite National and International Commissaires as well as their appointment to competitions,
- at the level of **development**, concerning individuals involved on the ground, overseeing the development of the disciplines and competitions over a period of time and all around the world.



REQUIRED KNOWLEDGE

- The UCI's main missions and values.
- The UCI Regulations must be incorporated into National Federation regulations.
- The UCI has two official languages.
- The location of UCI headquarters.
- Responsibility for training and appointing Commissaires.
- The UCI logo and its ownership.

1.2. NATIONAL FEDERATIONS

STRUCTURES AND DUTIES

Commissaires must be aware of and understand their National Federation's structure.

There is no standard structure for a National Federation (NF). NFs are a product of each country's laws and arrangements and may thus be organised in different ways.

Nevertheless, NFs affiliated to the UCI **all have the duty to act in accordance with the UCI's Constitution, Regulations and values.**

This means that Commissaires play an important role as they are conversant with the UCI Regulations. They participate in the development of cycling in their country by means of regular cooperation with teams, organisers and Commissaires from other nations and/or cultures. Commissaires' observations and experiences are key elements in harmonising the practices and values of cycling around the world.

Federations must conduct their internal affairs independently and ensure that no third parties become involved in their functioning. They must preserve their autonomy and resist any political, religious or economic pressures that may undermine their commitment to conform to the UCI Constitution.

AFFILIATION OF A FEDERATION TO THE UCI

A request for affiliation is examined by the UCI Management Committee. Before being submitted to Congress, the Management Committee may request further information from the candidate federation or indicate amendments that should be made to its structures or rules to ensure compliance with the UCI's rules and principles.

THE OBLIGATIONS OF NATIONAL FEDERATIONS

Federations shall make every effort to allow individuals who are members of other federations to participate in international cycling activities organised in their country.

Any infringements of the obligations incumbent upon a federation by virtue of the UCI Constitution or Regulations shall be penalised by a fine of CHF 300 to 10,000, to be established by the Management Committee. Each federation pays an annual subscription. The amount of the annual subscription is set by the Congress upon the proposal of the Management Committee.



REQUIRED KNOWLEDGE

- Description of the organisation of the National Federation of the Commissaire's own country.
- Description of the operation of the National Federation of the Commissaire's own country.
- Explanation of how the Commissaires of their country are instructed and appointed.

1.3. CONTINENTAL CONFEDERATIONS



CONSTITUTION, CHAPTER III – ARTICLES 23 TO 26

Federations from the same continent are grouped together in a Continental Confederation, an administrative organisation that forms an integral part of the UCI. Each federation is a member of the Confederation of the continent in which its national capital is located. There are five Continental Confederations:



Diagram. Continental confederations

MISSION

The Continental Confederations are responsible for the development of cycling on their respective continents and keep the UCI informed of any problems relating to cycling in their region.

The Continental Confederations submit proposals to the UCI Management Committee for activities that could be organised at continental level, in particular with respect to:

- drawing up the continental calendar of cycling competitions,
- the organisation and planning of training courses for Commissaires and technicians,
- the organisation of Continental Championships and Regional Games.



REQUIRED KNOWLEDGE

- Familiarity with the Continental Confederations.
- Awareness of the issues concerning the continental calendar of competitions.



CHAPTER 2 COMMISSAIRES

2.1. THE IMPORTANCE OF COMMISSAIRES

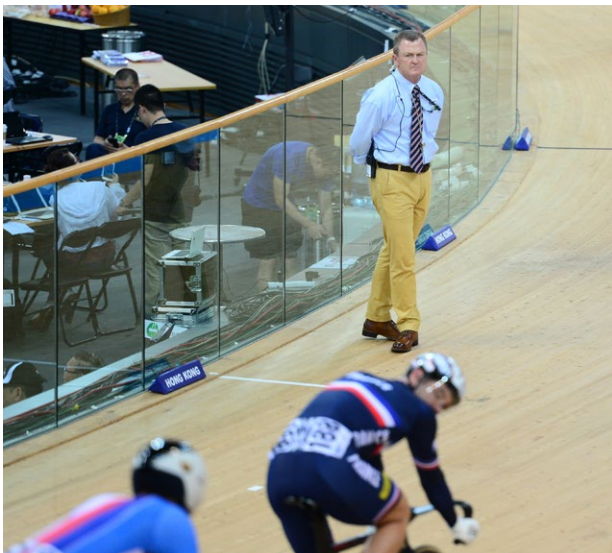

When a person decides to become a Commissaire, it is as a result of his or her passion for the sport, in a similar way to others actively involved in cycling. It is a way of making an active contribution to the promotion of competitions. International appointments take a Commissaire around the world and there are often opportunities to meet new people and discover other cultures, with cycling as the common reference point.

Commissaires need a wide range of qualities and skills if they are to successfully carry out all their functions during a competition. Called upon to officiate in an impartial manner in difficult situations, a Commissaire, as a representative of the UCI, must demonstrate **technical competence** and a sense of **responsibility** and **diplomacy** while communicating unambiguously to the numerous parties involved.

The [UCI Regulations](#) partially explain Commissaires' rights and obligations. However, this chapter, going beyond the regulations, will attempt to list a Commissaire's responsibilities before, during and after a competition to which he or she is appointed.

AN EXPERT REFEREE

Most Commissaires carry out their duties in parallel to pursuing careers in other professions. The work of a Commissaire is not a salaried professional activity. Despite this, everyone involved in cycling expects Commissaires to behave in a highly professional manner.

Commissaires are thus not only volunteers; they are experts, specifically appointed to competitions.

Commissaires referee and support the organisation of competitions, contribute to improving the quality of competitions and are participating in the development of the cycling regulations.

The time they dedicate to their work as a Commissaire depends on several factors:

- availability,
- specialisation (President of the Commissaires' Panel, Starter, Judge-Referee, Secretary, Finish Judge, etc.),
- the discipline or category of competition in which they officiate.

A Commissaire's role is often challenging because he or she has to work with a wide range of people (organisers, riders, sport directors, journalists, service providers). All of these individuals have different, sometimes diverging, interests.

THE PREREQUISITES: TECHNICAL COMPETENCE



The first important technical competence is a comprehensive knowledge of the UCI Regulations.

A Commissaire must be aware of what the Regulations, as well as the various good practice guides, impose and recommend for organisers and other key stakeholders. This allows checks to be conducted and feedback to be given through the evaluation report.

The [UCI Regulations](#) allow the Commissaire to react to the behaviour of the competitors and their team staff in order to guarantee that a competition is conducted properly in ethical and sporting terms.

Other technical knowledge, dealt with in the following chapters, is gained by observing a wide range of competitions, engaging in checks and taking advantage of teamwork among Commissaires.

THE PREREQUISITES: A SENSE OF RESPONSIBILITY

A sense of responsibility is a prerequisite even before an individual becomes involved in officiating: whether a Commissaire acts or does not act can change the sporting result of an event, affect the participants' perceptions and change the equilibrium between the various stakeholders.

The Commissaire must, among other things:

- check that the organiser has put in place all measures required to ensure the safety of everyone involved,
- guarantee the smooth running of the competition in sporting terms,
- ensure fair play,
- cooperate with other Commissaires in an optimum manner.

THE PREREQUISITES: DIPLOMACY AND COMMUNICATION



Commissaires are often called upon to act as mediators between the various parties in cycling and, using their personal skills, must make decisions firmly and tactfully.

Even though these decisions are often final, a Commissaire still has a duty of communication to the parties involved in order to explain and support a decision to the individuals concerned who sometimes lack knowledge of the regulations or are unaware of the latest amendments.

Encouraging the acceptance of a decision or sanction is not the objective, but it is essential to make sure that at least the minimum information has been communicated.

THE COMMISSAIRES' PANEL



The Commissaires' Panel for a track competition is made up of all the Commissaires appointed by the UCI and the National Federation of the country in which the event is taking place.

The Commissaires' Panel comprises the following members:

PRESIDENT OF THE COMMISSAIRES' PANEL (PCP)

- Responsible for the sporting management of the competition.
- Contact person during the competition for organisers, sports managers, and riders for all issues concerning the sporting results, regularity and respect of the UCI Regulations.
- Facilitator and coordinator of the other members of the Commissaires' team.

COMMISSAIRES

- Perform the specific role they have been assigned.
- Carry out checks on all issues that may influence the sporting result, before, during and after the competition.
- Assist the PCP in the sporting management of the competition on the ground and in reaching decisions on sanctions.

See [Chapter 5](#) for a detailed description of the various Commissaire roles required for track competition.

TEAM SPIRIT AND MANAGEMENT



The President of the Commissaires’ Panel (PCP), appointed by the UCI, cannot carry out his or her mission alone. The PCP relies on the work of the other members of the panel and must take decisions in a collegial manner.

Given these circumstances, the PCP acts as a manager. In this respect he or she must:

- check that the resources available to the members of the Commissaires’ Panel are appropriate to their missions,
- check, if necessary, that the work conducted by the Commissaires is of good quality,
- ensure that there is good co-operation within the Panel.

In the event of any problems, the PCP ensures that these three principles are applied.

The PCP makes use of professional management techniques (see Chapter 14). The PCP is the team leader and must demonstrate a strong sense of **team spirit**. The Panel must have a sense of solidarity, even if internal discussions are not only possible but necessary in the event of a divergence of opinions among members.

REPRESENTING THE UCI

The main Commissaires of a competition are appointed by the UCI and are the official representatives of the UCI during the race. A Commissaire must interpret and apply the regulations firmly and with common sense.

Commissaires represent the connection between the UCI and the sport on the ground.

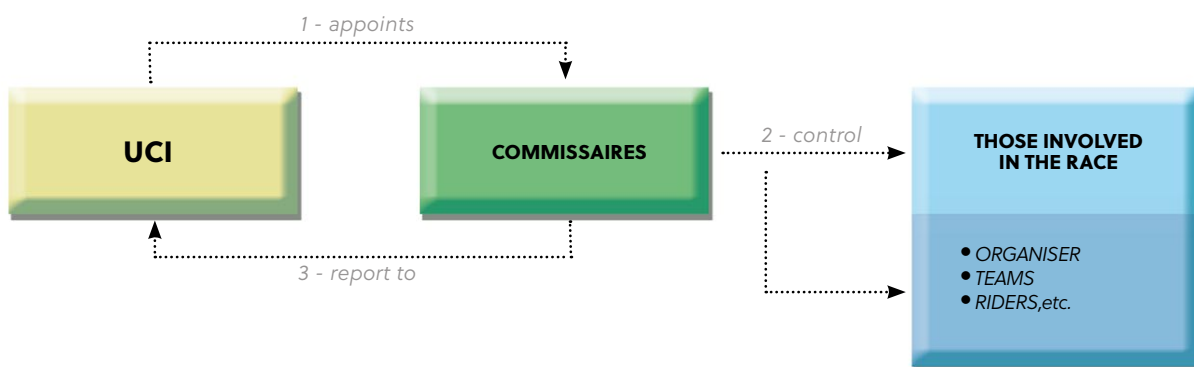

Diagram. The pivotal role of Commissaires between the UCI and those involved in the race

The above arrangement must apply in all circumstances, even if there are political conflicts between the stakeholders of cycling or different geographical entities. A UCI Commissaire must remain impartial to allow the UCI Regulations to be properly applied. A Commissaire must not advocate one party or another and must not deviate from the application of the UCI Regulations and standards.



REQUIRED KNOWLEDGE

- The ability to explain the importance of the role of a Commissaire to a third party.
- Knowledge of what those involved in cycling expect from a UCI Commissaire.
- The PCP’s role as a manager.
- What it means for a Commissaire to represent the UCI.

2.2. THE TRAINING OF COMMISSAIRES

The UCI wishes to improve the quality of officiating at competitions all around the world. To this end, the UCI emphasises the education and support of a pool of Commissaires for whom training is optimised and specialised.

The training of UCI Commissaires progresses regularly and observes the following principles:

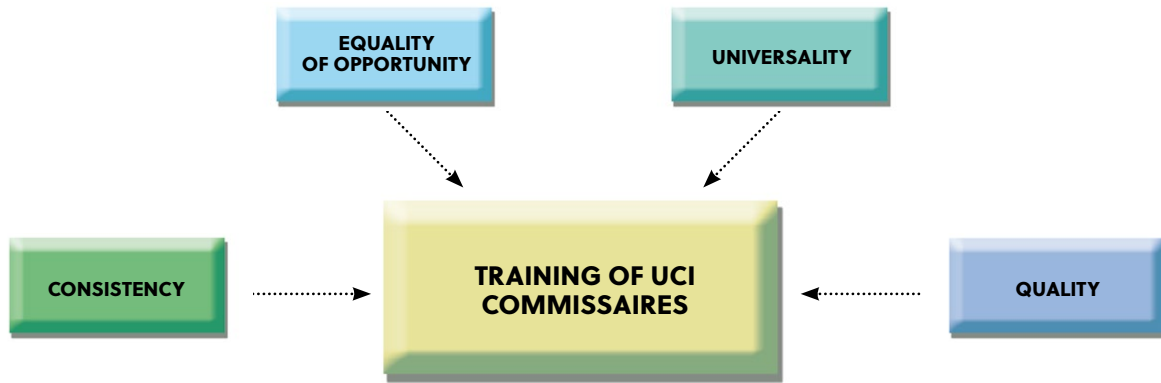

Diagrams. The principles of training Commissaires



- The training of Elite National Commissaires and International Commissaires is standardised under the control of the UCI.



- The UCI has established training for Elite National Commissaires and International Commissaires with the content corresponding to international standards.



- Standardised examinations all around the world.



- Continuous checks of Commissaires' skill levels by means of regular evaluations.



UCI INTERNATIONAL COMMISSAIRES

The training of UCI International Commissaires is of such importance that it is specified in the UCI Regulations (**ARTICLES 1.1.053 TO 1.1.061 BIS**).

These articles concern:

- conditions of access,
- the training programme,
- oral and written theory examination,
- practical examination,
- eligibility,
- continuing training and seminars.

ELITE NATIONAL COMMISSAIRES

Training courses for this status were introduced on 1 January 2012, with the following specifications:

- The Elite National Commissaire qualification has been established for Road, Mountain Bike, BMX and Track disciplines,
- The qualification of Elite National Commissaire is only awarded by the UCI,
- The relevant courses are run by UCI instructors,
- Elite National Commissaires are appointed by their National Federation (NF) to officiate in their own country,
- An Elite National Commissaire can be a member of the Commissaires' Panel in national and international competitions in his or her country. An Elite National Commissaire may also carry out the role of PCP at national competitions,
- Elite National Commissaires represent the elite within their country without necessarily aspiring to become International Commissaires,
- Elite National training forms part of the prerequisites for access to International Commissaire courses,
- If an Elite National Commissaire so desires, and after having officiated for at least two years in this position, the NF may propose him or her as a candidate for an International Commissaire course. This proposal may also come from the UCI if it considers that a Commissaire's skills are particularly suited to becoming an International Commissaire.



Diagram. The training of Commissaires at regional, national and international levels

2.3. THE SPECIALISATION OF COMMISSAIRES

The specialisation of Commissaires came into effect in **2014**. Involving the separation of the functions of International Commissaires (IC) from those of Doping Control Officers (DCO), this specialisation is the key component of the reform of the role of Commissaires approved by the Management Committee in January 2012.

At **national level**, federations can organise the management of Commissaires and Doping Control Officers in the manner that best suits them. No separation or specialisation is required. Furthermore, with regards to Elite National Commissaire status, National Commissaires can obtain this qualification in the disciplines of their choice. At national level, the UCI encourages a diversity of knowledge and wide range of skills among Commissaires.

Conversely, at **international level**, the UCI needs genuine specialists in order to support the development of cycling. Commissaires are becoming ever more professional and need an increasingly specialised framework as well as dedicated monitoring and supervision.

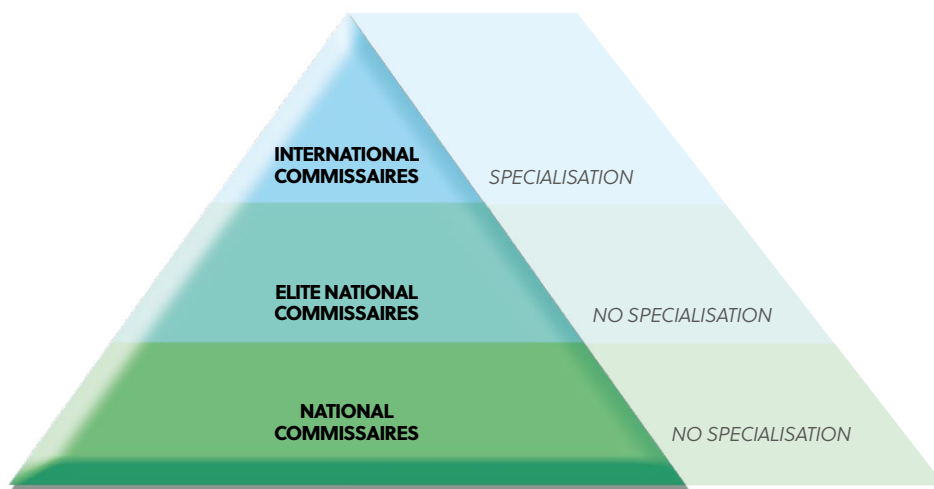

Diagram. Commissaires and specialisation

CHOICE OF SPECIALISATION

In order to become an International Commissaire, individuals must select one of the base disciplines shown in the “**Choice**” column of the diagram below. A Commissaire can then also choose an “**Option**”. With the exception of Trials and Indoor Cycling, International Commissaires must specialise in one of the base disciplines in all cases – **Road, Mountain Bike, BMX or Track**, the only disciplines for which Elite National Commissaire courses are organised.

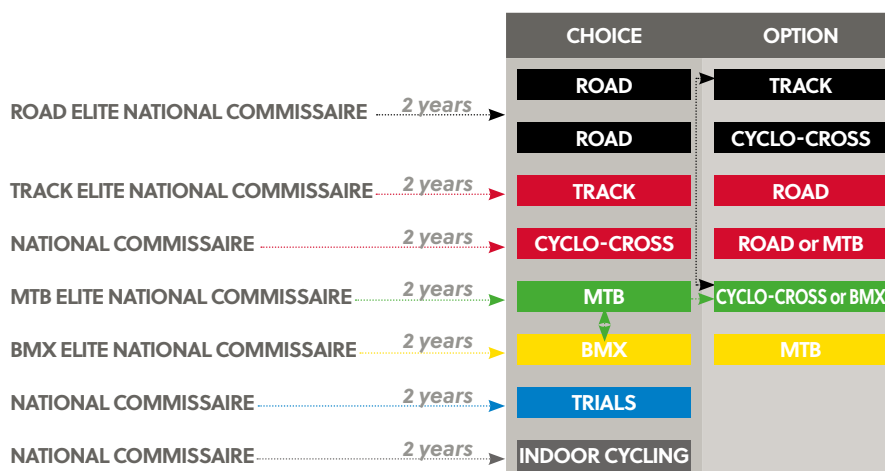

Diagram. Specialisation choices available to International Commissaires

In line with the requirements of the various disciplines, and also in order to ease the transition from the previous arrangements, certain additional provisions apply to this diagram:

- **Trials and Indoor Cycling IC:** there are no Elite National courses for these two disciplines. Consequently, after two years, a national federation may propose a National Commissaire for an International Commissaire course.
- The **choice between the IC and DCO** roles and the choice of IC discipline made in 2012 is not binding. Commissaires can put themselves forward for a re-evaluation examination if they wish to change direction.



REQUIRED KNOWLEDGE

- The definition of an Elite National Commissaire: training, responsibilities, appointment.
- Conditions of access to International Commissaire training.
- Specialisations and options for International Commissaires.

2.4. THE CAREER OF AN INTERNATIONAL COMMISSAIRE



A Commissaire's career does not stop progressing once he or she has achieved UCI International Commissaire status. An International Commissaire in fact has a wide range of opportunities:

- officiating at the Olympic Games, UCI World Championships and UCI World Cups,
- becoming a Commissaire Instructor within the UCI,
- becoming a Technical Delegate,
- taking part in working groups that oversee the development of cycling.

The experience of an International Commissaire can be utilised by a National Federation (NF) with the IC participating in:

- drawing up training plans for national and regional Commissaires,
- disciplinary bodies.



However, some activities are not compatible with the role of Commissaire, including (**ARTICLE 1.1.062 and 1.1.063**):

- competing as a rider in a UCI-registered team,
- carrying out a technical function (team assistant, mechanic, paramedical assistant, sports manager, etc.) for a NF or UCI-registered team,
- holding the post of President or Vice-President of an NF or Continental Confederation,
- being a member of the UCI Management Committee,
- being a member of the UCI staff.



The age limit for officiating as a UCI International Commissaire is 70 (**ARTICLE 1.1.064**).

2.5. UCI TOOLS FOR COMMISSAIRES

International Commissaires must familiarise themselves with the following UCI tools:

- the distribution of instructions by e-mail,
- the UCI website at www.uci.org,
- the Commissaires' extranet,
- the UCI DataRide system.

INFORMATION BY E-MAIL

The UCI Commissaires Coordinator, as well as the Coordinators of the various disciplines and activities, send information, travel instructions and other arrangements to International Commissaires by e-mail. If appropriate, this information can also be sent to Elite National Commissaires for training purposes and to ensure consistent application.

Generally speaking, this information should not be sent to third parties such as the media, teams and athletes. These groups are informed by other UCI departments if necessary.

International Commissaires must inform the UCI of any change of address and in particular any amendment of their e-mail address (a form is available on the Commissaires' extranet for this purpose).

UCI WEBSITE

The UCI website at www.uci.org, is published in French and English and represents a source of information for all. In addition to keeping up to date with international news and UCI press releases, Commissaires use the website for the following purposes:

- Calendar: checking the date and class of a competition, clicking on the link to the competition's website,
- Teams: referring to the list of officially-registered riders and team members authorised to participate in competitions; contact details,
- UCI Regulations: the latest version is always available on the [UCI website](#),
- Checking event **results** and **UCI rankings**,
- Referring to the webpages dedicated to riders' **equipment**: explanatory documents and training materials,
- Publications: training guides, organiser's guides and documents, financial obligations,
- Access to the **extranet** from the Web Services page.

COMMISSAIRES' EXTRANET

An extranet is an extension of an enterprise's communications network that allows authorised external individuals to access specific information. An extranet platform has been set up for International Commissaires. The UCI provides Commissaires with a username and password upon request. Among other things, the Commissaires' Extranet comprises:

- race report forms,
- report form for penalties,
- the minutes of seminars,
- sample technical documents,
- contact details of Commissaires listed by specialisation,
- expenses form,
- details of compensation and reimbursement of travel expenses.

THE UCI DATARIDE SYSTEM

The UCI is in the process of rolling out its own internal data management system for the sport, known as UCI DataRide. Increasing functionality will be added to the system over time through various modules.

All International Commissaires have been provided with a unique user ID and password for UCI DataRide.

The following modules are currently available to International Commissaires:



- When International Commissaires log in to UCI DataRide, they see the competitions they have been assigned to as PCP (they will also be able to see past competitions at which they acted as PCP – going back to 2016 only).
- By clicking on the name of the competition they will be able to see the events that make up that competition.
- The Timing Company also has access to the relevant specific competitions through the competition organiser.
- By agreement with the PCP, the Timing Company can upload the results for every event at the competition.
- If there is no Timing Company, or no agreement with it, or if the Timing Company does not have access to UCI DataRide, the PCP uploads the results for every event at the competition. This must be done without delay.
- Specific training guides have been provided on the Commissaires' Extranet to assist International Commissaires with fulfilling their responsibilities in this area.

| Discipline | Season | Date | Competition | Class | Category | Venue | Country |
|------------|--------|--------------------|--|-------|------------------------|---|---------|
| MTB | 2017 | 04 Mar 2017 | 18 Internazionali d'Italia Series 2017 | 2 | ME - WE - M8 - W8 | Verona - Rivoli Veronese | ITA |
| IND | 2017 | 25 Mar 2017 | 1 Junior Masters | CLB | ME - WE - XE | Frankfurt am Main | GER |
| ROA | 2017 | 19 Mar 2017 | 102° Popolarissima | 1.2 | ME | | ITA |
| PIS | 2017 | 19 Jan-24 Jan 2017 | 106. Berliner 6 Tage-Rennen 2017 | CL3 | ME - WE - MU - M8 - W8 | Berlin | GER |
| MTB | 2017 | 12 Mar 2017 | 24 Internazionali d'Italia Series 2017 - UCI Junior Series XCO | 1 | ME - WE - M8 - W8 | Milano | ITA |
| PIS | 2017 | 20 Mar-24 Mar 2017 | 2017 African Track Championships | CC | ME - WE - M8 - W8 | Cyril Georgehan Velodrome, 3 Srisso Nwanyana Rd, Durban, 4025 | RSA |
| ROA | 2017 | 21 Feb-23 Feb 2017 | 26me Tour Cycliste International La Provence | 2.1 | ME | | FRA |
| MTB | 2017 | 02 Apr 2017 | 38 Internazionali d'Italia Series 2017 | HC | ME - WE - M8 - W8 | Montichiari BS | ITA |
| ROA | 2017 | 23 Jan-29 Jan 2017 | 35 Vuelta Ciclista a la Provincia de San Juan | 2.1 | ME | | ARG |

- After the results of each event have been uploaded, the ranking is calculated by the UCI DataRide system and displayed on the UCI website according to the timelines established in the UCI Regulations.
- The results of all international competitions are displayed on the UCI website.
- The International Commissaire, after logging in to UCI DataRide can also search for individual license holders.
- This search can be performed using various filters:
 - Country
 - First Name
 - Family Name
 - Birth Date
 - UCI ID
- This is a valuable tool for verifying if someone is currently licensed, the UCI ID or the spelling of a name..

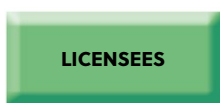

Commissaires can download the various rankings and lists of world and national champions, as well as world records, from the UCI website. These lists can be exported in a spreadsheet, allowing for sorting, filtering and carrying out research.



REQUIRED KNOWLEDGE

- The means of access, contents and use of the UCI's four tools:
 - E-mail for distributing instructions,
 - The UCI website at www.uci.org,
 - The International Commissaires' extranet,
 - The UCI DataRide system.

2.6. CODE OF CONDUCT

The Code of Conduct for International Commissaires is a public document that can be consulted on the Commissaires' Extranet. It states what is expected by the UCI and offers a certain amount of advice on behaviour.



Diagram. Human qualities and relationship skills required by International Commissaires

 Significant deviations from the Code of Conduct may lead the UCI to take measures against the Commissaire concerned, up to suspension of the right to act as a Commissaire. (**ARTICLE 1.1.066**).

OBLIGATION OF IMPARTIALITY

The UCI Regulations refer to ethics by requiring Commissaires to maintain impartiality (**ARTICLE 1.1.050**). This article is particularly important because it is sometimes difficult to apply in certain circumstances: Commissaires are often deeply involved with their federation, organisers or local clubs. They may be appointed to officiate at a competition where there is a conflict of interests with these bodies.

The UCI Regulations impart a duty on a Commissaire to withdraw as soon as he or she perceives a risk of an infringement of impartiality. This withdrawal is a protective measure for the Commissaire: in the event of a conflict, even if the Commissaire acted impartially, he or she may be suspected of not having done so and any decision made may be challenged.

IMAGE AND LANGUAGE

Other important points of the Code of Conduct concern dress, appearance and language used. Clearly an International Commissaire may be excused if he or she has not mastered all the subtleties of the official jargon used in exchanges with the stakeholders in cycling. However, to the contrary, it is not acceptable to use colloquialisms or irony or to jump to conclusions.

2.7. CODE OF ETHICS

The Code of Ethics is applicable to most parties engaged in the sport of Cycling, including all Commissaires. It is a public document that can be consulted on the UCI website. It states what is expected in terms of ethics by the UCI. It also outlines procedures to be followed when the code has alleged to have been violated.

RULES OF CONDUCT

The Code of Ethics places the responsibility of abiding by it on all parties that are bound by it. As such, all Commissaires are expected to act in an ethical manner, and not abuse their position in any way.

Central to the Code of Ethics is the requirement to act with integrity in all manners related to cycling.

 The Code of Ethics requires that all persons bound by it obey the rules laid out therein. Commissaires are bound to all the rules, with specific attention given to the following:

- **ARTICLE 6.1.** Non-discrimination: Not undertake any action that offends the human dignity of any person.
- **ARTICLE 6.2.** Neutrality: Always remain politically neutral when representing cycling.
- **ARTICLE 6.3.** Confidentiality: Do not release information provided in confidence to the public.
- **ARTICLE 6.4.** Physical and mental integrity: The personal rights of individuals must be respected.
- **ARTICLE 7.1.** Gifts: Gifts accepted should be appropriate, and not influence or bind one person to another.
- **ARTICLE 7.2.** Bribery and corruption: Decision making must not be conditional on any offer.
- **ARTICLE 7.4.** Conflicts of interest: Conflicts of interest are to be avoided.
- **ARTICLE 8.1.** Influencing and betting: Decisions may not be taken to deliberately influence a result contrary to sport ethics. Participating in any form of gambling in any way in an event in which the person is involved is forbidden.
- **ARTICLE 8.2.** Anti-doping: Facilitating doping in any way is forbidden.

CODE OF ETHICS AND CODE OF CONDUCT

There are many overlapping components between the Code of Ethics and the Code of Conduct. However, both can be considered complementary, and Commissaires are required to abide by them.

CHAPTER 3 THE TRACK



The technical regulations for the sport of track cycling make extensive reference to the design of the track. This includes all the features that make up the actual racing surface. Consequently, it is important to have a good knowledge of these so that proper sporting control can be implemented.

Having proper sporting control also requires technical equipment, supplied by both the organisation and the Commissaires, as well as additional facilities provided for the Commissaires' use. These facilities allow for the proper, efficient management of the sporting side of the event and also facilitate the correct positioning of the Commissaires.

The clear definition of this equipment and facilities ensures the uniform application of the sporting regulations from competition to competition and from velodrome to velodrome.

3.1. DEFINITION OF THE TRACK

In order for a velodrome to be used for racing it needs to be homologated (approved) by the UCI. A key factor is that this homologation is restricted to the external features of the velodrome. It does not represent approval of any of the velodrome's technical or structural characteristics. For example, it does not endorse the way in which the velodrome was built. The owner, together with the construction company and all related parties, must ensure that all relevant building standards and codes have been observed. The UCI's approval is related to those components that will impact on the way the sport of track cycling is run, ensuring that the regulations can be met. And even here, it is limited to what can be visually inspected.

The UCI will not normally grant approval for a competition to take place in a velodrome that has not been homologated. If there is any doubt, it is the PCP's role to verify that homologation has taken place by requesting to see the relevant certificate. There is no expectation for Commissaires to check any of the measurements or other items related to homologation.

As with anything else in the sport of cycling, if you witness something that is unsafe, or appears to contravene the regulations, you may intervene. This intervention may include asking for an item to be rectified, verifying the situation with the UCI, requesting that the competition be suspended or cancelled, or withdrawing from the competition. Before taking any severe action that cannot be undone, ensure that the approach is warranted.

3.1.1 TRACK GEOMETRY

FORM

A track is defined as being two curves connected by two parallel lines. Another way of describing this is two straights connected by four bends. It is possible to find older velodromes that do not meet this standard, however, these are not recognised for the purposes of competition.

SURFACE

Tracks can have a number of different surfaces. The most commonly-used surfaces are wood and concrete. Various synthetic materials are also sometimes used. Older tracks may also have a tarmac-type surface. Historically, tracks sometimes also used cinder or grass.

Nowadays, whichever surface is used needs to allow for a fair, safe competition. It needs to be non-slip and non-abrasive. The same surface needs to be applied uniformly over the entire track. This means that a specific surface cannot be applied to part of the track to enhance performance. The surface also needs to be completely flat. This is determined by looking at a cross-section of the track surface at any point on the track.

Advertising logos may be placed on the track surface subject to certain restrictions. This is often done in the form of a non-slip decal. While this represents a change in the surface, its purpose is not to enhance performance in one particular area. Whatever decal or paint is used, it must not alter the adhesion properties, consistency or homogeneity of the track.



Since this advertising is often placed in the middle of the bends, it is important to be vigilant that it does not make the track slippery in this area. Sometimes what may appear to be non-slip in dry conditions can become slippery in more humid or damp conditions. In this case, the advertising must be altered or removed to eliminate the danger.

LENGTH

Tracks are usually described by their length. Most tracks in use today, as well as any new tracks being built, meet the following two criteria in terms of their length:

- between 133 m and 500 m in length,
- a whole number of half laps gives a distance of 1 km.

These criteria ensure that the sporting conditions for track cycling in terms of distance can be easily met since most track events are a factor of 1 km. Some examples:

- 500 m Time Trial (half of 1 km),
- 4,000 m Pursuit (four times 1 km),
- 40 km Points Race (forty times 1 km).

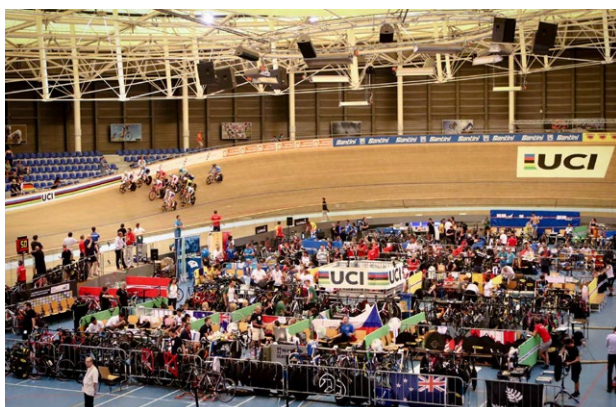

Some commonly-used track lengths are:

- 333.33 m – 3 laps make 1 km (Moscow),
- 250 m – 4 laps make 1 km (London),
- 200 m – 5 laps make 1 km (Aigle),
- 166.66 m – 6 laps make 1 km (Cleveland).

For the World Championships and the Olympic Games, it is a requirement that the track be 250 m in length. In some cases, the UCI may give approval for a different track length to be used if this will support the development of the sport of cycling. An example of this is the use of the velodrome in Aigle for the Junior World Championships due to its unusual width.

The UCI may also give approval for track lengths that are not a factor of 1 km. These tracks are often found in older velodromes that were built using imperial measurements. In this case, the length of the track was a factor of 1 mile. They must still be between 133 m and 500 m in length.



Some examples of tracks such as these are:

- 138 m – Forest City Velodrome (smallest track in use),
- 286 m – San Sebastian,
- 460 m – Johannesburg.

In all cases, the track must be approved by the UCI for competition.

WIDTH

When the width of the track is described, this refers to the competition surface, that is, the area of the track defined for racing. It does not include the safety zone or blue band. The width is measured from the upper edge of the blue band to the bottom edge of the track perimeter fence.

When designing a track, its width is determined as a function of its length. The longer the track, the wider it is. However, no track used for international competition may be narrower than 5 m. Furthermore, any tracks used in major international competitions need to be at least 7 m wide.

The track also needs to have the same width the whole way around.

BANKINGS

A key element in the design of any track is the banking. Both the turns and the straights have banking to some extent. The degree of banking in both cases is a function of the length of the track. The shorter the track, the steeper the banking.

The purpose of the banking is to allow riders to move through the turns at high speed. The track design also needs to take into account that riders are not always travelling at maximum speed through the turns. This means that the steepness of the banking is reduced.

The straights also have an element of banking to allow the riders to navigate the track at a range of speeds.

The bankings in the straights and turns and the transitions between the straights and turns must all be carefully designed. This allows a bicycle to naturally follow the track around the turns so that the rider does not need to focus on steering.

3.1.2. TRACK LINES

In order to facilitate the sporting considerations of track cycling, a number of lines are painted on the track surface using some form of non-slip paint. These lines are critical to the job of the Commissaire as they are used to define the various events as well as the permitted behaviour of the competitors.

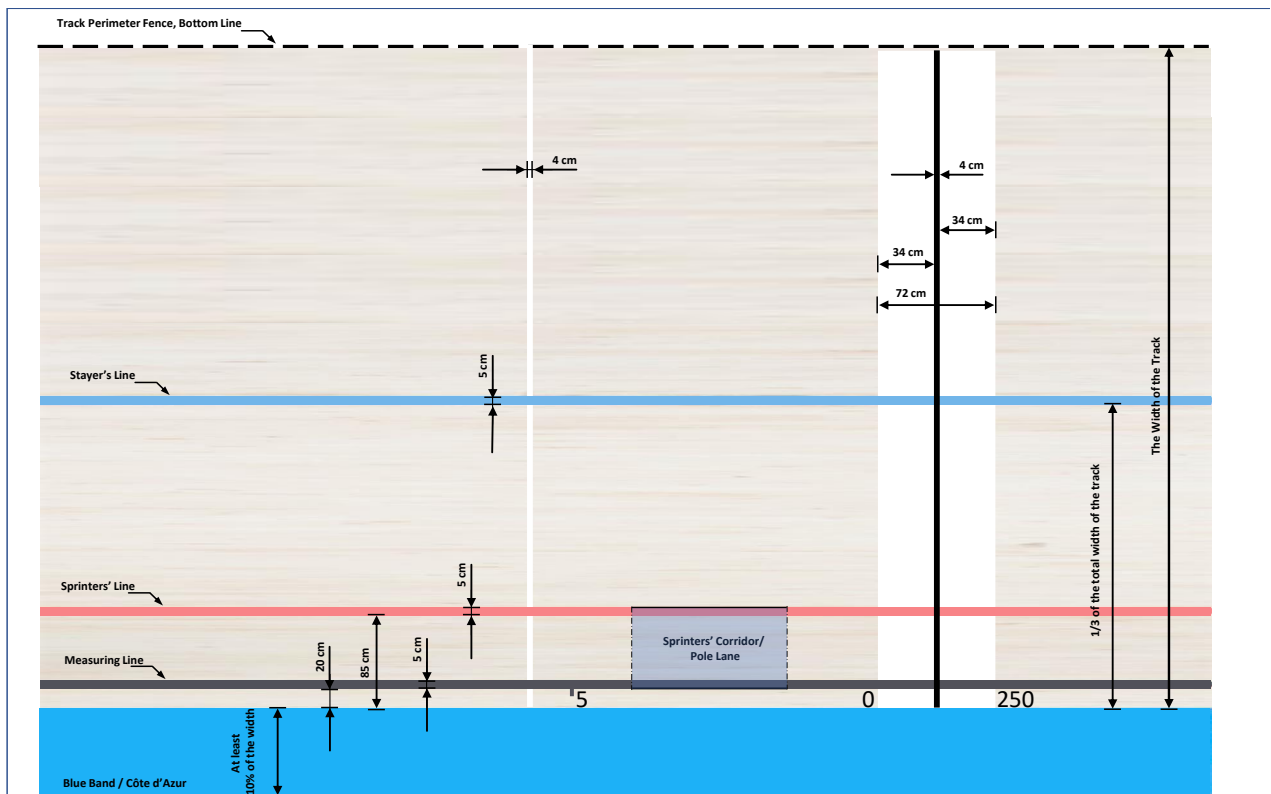

FORM OF LINES

All lines placed on the track are well defined in form.

They must be clearly visible. This means that the track surface cannot be a colour that obscures the visibility of these lines.

All lines that follow the direction of the track (longitudinal lines), other than the Blue Band, must have a constant width of 5 cm. All lines that go across the track (perpendicular lines), other than the Finish Line, must have a constant width of 4 cm.

LONGITUDINAL LINES

The first of the longitudinal lines is the **Blue Band**, often called the Côte d'Azur. This is painted on the inside area of the track and it must be rideable. This means the transition between the racing surface of the track and this area must be consistent and it must have the same surface as the track. The Blue Band must be at least 10% of the width of the track and be painted sky blue. No advertising of any form is permitted to be either painted or attached to this area.



EXAMPLE

In the case of a track that is 7 m wide, the Blue Band needs to be at least 70cm wide.

The next line is the **Measuring Line**. Depending on the colour of the track surface, it is either a black or white line. It is painted all the way around the track and its inside edge is 20 cm from the inside edge of the track, that is, from the outside edge of the Blue Band. It is this inside edge of the Measuring Line that defines the length of the track.

Starting at the Finish Line, small markings are placed on the Measuring Line every 5 m; these are numbered by the distance covered every 10 m.

The first marking appears 5 m from the Finish Line. The second marking is 10 m from the Finish Line and is numbered 10 m. In the case of a 250 m track, the perpendicular 200 m line coincides with an unnumbered marking between the 40 m and 60 m marks.

Moving up the track, the next line is the **Sprinters' Line**. This is a red line. Its inside edge is 85 cm from the inside edge of the track. This means that the space between the two edges is 85 cm, and the outside edge of the Sprinter's Line (the edge facing the railing) is 90 cm from the inside edge of the track.

This line creates a very important concept in track cycling known as the Sprinter's Lane. This may also be called the Sprinter's Corridor or Pole Lane. The Sprinter's Lane is the area between the Sprinter's Line and the Measuring Line and includes the lines themselves.

Continuing up the track, the next line is the **Stayer's Line**. This is a blue line. It is placed at one third of the total width of the track. The width of the track is measured from the outside edge of the Blue Band to the top edge of the track. The one third is measured from the outside edge of the Blue Band to the inside edge of the Stayer's Line (i.e. the two edges that face each other). On narrower tracks, the Stayer's Line must be a minimum of 2.45 m from the inside edge of the track (even if this is greater than one third of the track width).

PERPENDICULAR LINES

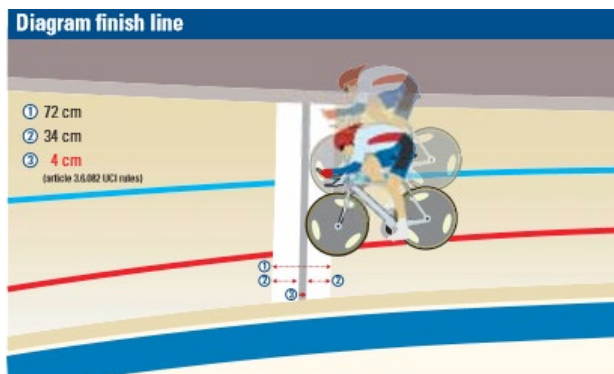

The first of the perpendicular lines is the **Finish Line**. Its actual markings are defined in the same way for Track cycling as for Road cycling. It is a black line, 4 cm wide, painted the full length of a white strip that is 72 cm wide. Thus there is a white strip 34 cm wide, then a black strip 4 cm wide, then a white strip 34 cm wide. The actual finish point is the leading, or inside edge of the black line. This is the edge of the black line facing the riders as they approach the finish.

The Finish Line has to be painted the full width of the track and up to the top of the vertical surface of any perimeter fencing. This makes it easier to judge the finish in terms of identifying when the line is crossed.

The Finish Line is placed near the end of one of the straights, but at least a few metres before the entrance to the bend. Ideally it should be in front of the main grandstand, although this is not an absolute requirement.

The next line is the **200 m Line**. This is a white line painted across the full width of the track 200 m before the Finish Line. This distance is measured from the leading edge of the 200 m Line to the finish.



EXAMPLE

On a 200 m track, the 200 m Line is the same line as the Finish Line. On a 250 m track, the 200 m Line is placed 50 m after the Finish Line. On a 167 m track the 200 m Line is placed 33 m before the Finish Line – in other words from the 200 m Line you would cross the Finish Line, continue until you cross the 200 m line a second time and then cross the Finish Line again in order to complete 200 m.

Related to the 200 m Line is the **100 m Line**. This is a white line painted across the full width of the track and is 100 m before the Finish Line. This distance is measured from the leading edge of the 100 m Line to the finish.

NOTE

Many older tracks do not have this line. The 100 m Line is used in the Sprint competition. If there are Sprint events taking place and there is no 100 m Line, then this should be carefully located using the markings on the Measuring Line and then non-slip tape used to mark the line perpendicularly across the track.

The final perpendicular lines are the two Pursuit Lines. These lines are red and painted across half the width of the track. The two lines must be at the precise midpoint of each straight AND exactly in line with each other. They are used to judge the finish points of Pursuit and Time Trial events.

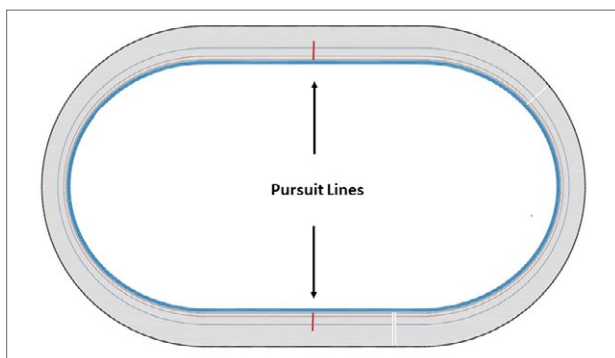

3.1.3. SAFETY ZONE AND SAFETY



Inside the Blue Band there must be a marked Safety Zone. The width of the Blue Band and the Safety Zone combined must be at least 4 m for tracks that are 250 m or longer and at least 2.5 m for tracks that are shorter than 250 m.

During racing, the Safety Zone must be clear of all equipment. This includes things such as starting gates, chairs, spare racing equipment, tools, photographic equipment, etc.

The only people permitted on the Safety Zone during racing are the racing riders, the Commissaires and any people authorised by the President of the Commissaires' Panel (PCP). This authorisation can be withdrawn at any time and in this case the relevant people must leave the Safety Zone immediately.

Usually the PCP will authorise a maximum of one team member on the Safety Zone per rider racing at that time. For bunch events these team members are normally located on the back straight. For sprint events the team members usually stand on the home straight. For time trial and pursuit events the team members normally stand on opposite sides of the track near the Pursuit Lines or bends.

NOTE

Other than for time trial and pursuit events, team managers standing on the Safety Zone may have nothing in their hands, or any objects on them that may fall on to the track.

In the case of an accident, the medical team may need to access the Safety Zone. The race doctor will make the decision as to whether they need to enter the zone and what equipment will be needed. This is the decision of the race doctor and does not require the authorisation of the PCP. However, the Commissaires on the Safety Zone should monitor the situation and if the medical team poses a risk to riders racing on the track, or if the riders racing on the track pose a significant risk to the medical team, the PCP asks the Starter to stop the race. See later in this guide on how to manage such situations.



A limited number of media representatives may also be authorised on the Safety Zone. This includes photographers and TV camera operators. The exact number allowed is normally agreed by the organisation and the PCP. Media personnel given access should be provided with a distinctive sign by the organisation such as a coloured bib. Any media representatives having access to the Safety Zone must carry all their equipment on them and are not permitted to use a tri or monopod. Nothing may be placed on the Safety Zone.



While the riders are racing, no-one is allowed on the Blue Band. Anyone on the Safety Zone, including the media, should keep well back from the Blue Band, and when applicable, within an arm reach distance of the inner fence. It is also forbidden to sit or lie on the Safety Zone. People on the Safety Zone must never turn their back on racing riders.



TIP

Keep the area between the Finish Line and the entry to the first bend (which includes the zone in front of the Secretariat) free of everyone except the working Commissaires. This ensures that the Commissaires and Timing Company have an effective working environment.



The Commissaires, especially those working on the Safety Zone, must always monitor the conduct of the people on the Safety Zone. Pay special attention to ensure that media personnel working on the Safety Zone do not get too close to the Blue Band, especially at the end of a race. When there are many media representatives they may congregate in a large group on the Finish Line.

TIP

Use tape to mark out an area on the Safety Zone in which people must stand. At the Finish Line mark out a zone in the form of a funnel towards the banking so that the media can do their job but not present a safety risk.



If there are any abrupt changes in height between the Safety Zone and the centre of the track, for example a sunken infield, or if there are any obstacles within 10 m of the Blue Band, for example installations for the officials such as a raised podium for judging, then there needs to be a transparent fence at least 1.2 m high on the inside edge of the Safety Zone.



There should be no items (for example, bicycles, racing equipment, media equipment) hung or attached to the inside or outside of the fence.

If there are gates in the fencing, usually to allow access to the track, then it must be possible to latch the gate closed in a reliable manner. The gates must be kept closed during racing and training. The organisation must provide marshals to control the gates; they open and close the gates to allow people who have the right to access the Safety Zone to enter and leave. Commissaires assigned to the straights should monitor the conduct of these marshals to ensure that they perform their role properly.

Gates should never be opened when racing riders are approaching the area of the gate.

For events in which starting gates are used, once the start is given, the starting gate must be removed from the Safety Zone and the gate in the fencing closed.

In the case of an accident during a bunch race where team or medical personnel need to access the Safety Zone, the safety of all must be the foremost consideration when opening the gate. The gate should be closed again as soon as individuals have either accessed or left the Safety Zone.

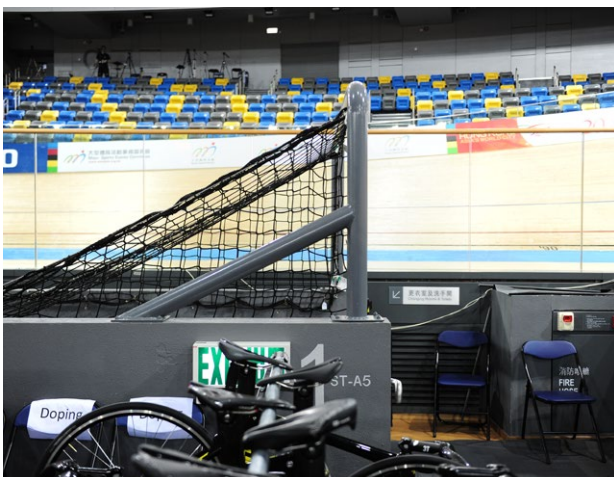

If there is a drop greater than 1.5 m between the level of the track (Safety Zone) and the infield, then additional protection devices need to be placed in these areas to prevent injury to riders. An example of this is where there are stairs near the fence leading down to the access tunnel. In this case netting could be placed over the stairs so that a rider going over the fence would land on the netting and not fall down the stairs.

NOTE

Other than start gates, Commissaires, and organisation staff required to manage the start gates and track access gates, no people and equipment, including team personnel and equipment are permitted to be on the access ramps to the track during races, including bunch races. This obstructs sight lines, and hampers medical access to the track.



REQUIRED KNOWLEDGE

- Definition of a track.
- Minimum and maximum lengths of a track.
- Minimum and maximum widths of a track.
- Name and location of each of the lines of a track.
- Location of the Sprinter's Lane.
- Definition and purpose of the Safety Zone.
- Use of the Safety Zone.



WHAT TO DO

- Monitor the conduct of people on the Safety Zone.
- Ensure the Safety Zone is kept free of equipment during racing.



WHAT NOT TO DO

- Measure the lines on the track.
- Allow people to stand on the Blue Band during a race.

3.2 TRACK EQUIPMENT

Track cycling competitions require a large amount of specialised equipment, some of which must be provided by the organisation and some by the Commissaires. In practice, it is not unusual to find that some of the equipment that the organisation should supply is not available.

Commissaires must ensure they bring all the equipment for which they are responsible. The PCP must also check in advance that the organiser will provide the minimum required equipment for the events being staged. Upon arrival at the venue, the PCP checks that all this equipment is available, functional and able to be used appropriately, bearing in mind the sporting and safety considerations.



TIP

Never assume equipment will be available on the day of the event. Until actually seen by the Commissaires, equipment must be assumed to be unavailable.

3.2.1. TIMEKEEPING



In timed events, the timing starts when the base of the wheel touches the line where the timed distance starts and stops when the base of the wheel touches the line where the timed distance ends.



All Commissaires should have at least one digital stopwatch able to record times to 1/100th of a second. Ideally they should have also a second stopwatch as a backup. These stopwatches should also be able to take lap times or split times. In other words, it should be possible to start the watch and record intermediate times without stopping the timing. It is highly recommended that a Commissaire working as a timekeeper has a stopwatch that is capable of printing. Nowadays, stopwatches are also available with a Bluetooth function to connect to an external recording device from which it is possible to print. The organisation may sometimes also provide stopwatches for Commissaires, but this should not be relied upon.

When timed events are being staged, the organisation must provide electronic timekeeping that is accurate to 1/1,000th of a second. In most cases this service is provided by an external service provider.

The three most common forms of electronic timekeeping are:

- a contact tape switch,
- a transponder,
- a photo-finish system.

In many large competitions, a combination of all three may be used.

CONTACT TAPE SWITCH

A contact tape switch is essentially two pieces of electronic cabling separated by some form of insulation. It is placed across the width of the track. When a wheel touches the switch it forces the two electronic cables into contact with each other, which either starts or stops the timing.

TRANSPONDERS

There are two types of transponder that can be used: active or passive.

A passive transponder does not have its own power source. A form of cabling system is placed across the width of the track at the point where the time is to be taken. This cabling emits an electromagnetic field. When the transponder crosses this field it absorbs the energy and transmits a signal back to a transponder reader, either starting or stopping the timing system. Passive transponders tend to be very cheap, but also less accurate.

An active transponder has its own power source and broadcasts its own signal. Once again, a cabling system is placed across the width of the track at the point where the time is to be taken. This cabling emits an electromagnetic field. When the transponder picks up the signal it sends back its own signal to the reader, either starting or stopping the timing system. This type of transponder is more expensive, but also extremely accurate. This is the system that major timing companies use.

PHOTO-FINISH

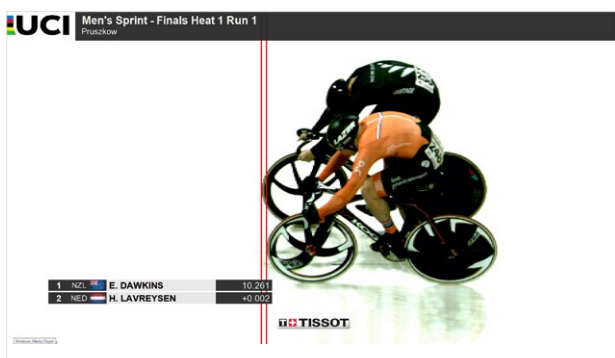

A photo-finish system simply uses the finish camera to record the moment a wheel crosses the line. This system is normally used in conjunction with another system to start the timing.

NOTE

Take care. A photo-finish system is normally used to record when the front of the wheel crosses a vertical line raised from the finish line, whereas time is usually taken when the base of the wheel touches the line. This is NOT the same point. Timing must be to the point where the wheel touches the line.

STARTS

There are two types of timed distance event:

- flying starts,
- standing starts.

During a flying start event, the timed distance commences when the rider is already moving, normally quite quickly. The most common form of electronic timekeeping used in these types of event to start the timing is a contact tape switch on the track.



In a standing start event the timed distance commences when the rider is stationary. In this case an additional piece of equipment is used, a starting gate.

The starting gate is placed on the track at the starting point for the timed distance, and the bicycle is locked into the gate so that the base of the front wheel is just behind the start line on the track (NOT touching the line). The bicycle is usually held by means of a pressure mechanism applying a brake to the back wheel. When the start is signalled, the brake opens and releases the bicycle allowing the rider to start. There are two types of electronic timekeeping commonly used to start the time. In the first, the timing starts the moment the starting gate releases the bicycle. In the second, the timing starts once the front wheel makes contact with the contact tape switch on the start line after the bicycle has been released by the starting gate.



When starting gates are used, an electronic starting system and countdown apparatus is also employed.

The electronic starting apparatus is linked to the timing system and starting gates. Once the bicycles are locked into the starting gates the Starter activates the starting system. This initiates a countdown to the start – usually 50 seconds. Once the start is reached (at 0 seconds), it sends a signal to the starting gates to release the bicycles, as well as a signal to the electronic timing system.

The system can be stopped and restarted by the Starter. It can also be reset back to 50 seconds by the Starter if necessary. Associated with this is the countdown apparatus. This is a digital display facing the starting gate. It is programmed to show a countdown to the start, normally 50 seconds. This display is often also used as a lap board.

When the Starter activates the starting system, the countdown display commences counting down from 50 seconds. At set intervals it also emits a tone and during the final 5 seconds emits a tone on each second. At 0 seconds the gate opens and the bicycle is released. If the same display is being used as a lap board, at this point it switches over to display the number of laps to be ridden.

In all cases where electronic timekeeping is used, Commissaires should also take manual backup times.

PADS



In most timed distance events, foam pads are used on the track to restrict where participants can ride. The pads are used to make the Blue Band unrideable. The pads are made of foam and must be 50 cm long. They are usually about 10 cm wide and 10 cm high. The pads should be heavy enough so that when a rider goes past they are not blown onto the track. Sometimes a rubber strip may be placed on the bottom of the pad to give it a bit more weight. However, the pad must not pose a safety hazard if hit by a rider.

The foam pads are placed up to the inside edge of the Blue Band every 5 m all the way around the track, from each pursuit line through to the end of the second bend after these pursuit lines. The reason that a space is left is to allow riders to safely exit the racing surface without hitting a pad. The 5 m measuring marks on the Measurement Line are used to position the pads.

For the Team Sprint event, pads are not placed all the way around the track. Eight pads in total are used. They are placed up to the inside edge of the Blue Band at the Pursuit Lines, and then at the 5 m, 10 m and 15 m marks from the respective Pursuit Lines. These are placed in this position to prevent the riders using the Blue Band at the start, as well as to mark the end of the transition zone.



TIP

For the Keirin, it can be useful to place a pad on the safety zone (below the Blue Band) in line with the Pursuit Line where the derny exits the track. This creates a visual reference point for the derny rider, riders and Commissaires. The pad is placed below the Blue Band so that it does not present an obstacle to the derny leaving the track or the riders.

3.2.2 JUDGING

PHOTO-FINISH



The organisation is required to make a form of electronic judging system available. This is usually a photo-finish system.

The most commonly used photo-finish systems are now digital. A service provider usually supplies the system. It is set up to record the front of the front wheel passing through a vertical line raised from the leading edge of the Finish Line.

Ideally there should be at least two cameras on the Finish Line, one on the inside of the track and another on the outside. This provides a backup and also prevents a situation arising where, in a close finish, the wheel of one rider may obscure the wheels of other riders.

It should be easy to interpret the images and it should also be easy to scroll through the images to find the back of the back rider in the Elimination event.

For major competitions, when there are Team Sprint and/or Team Pursuit and/or Keirin events, there also needs to be a photo-finish camera recording the Pursuit Lines.

Sometimes a form of transponder system may also be used, as discussed in the Timekeeping chapter (see 3.2.1).

In the case where there are both photo-finish and transponder systems, the photo-finish system prevails when making the final electronic determination of the order of riders across the line.

VIDEO RECORDING

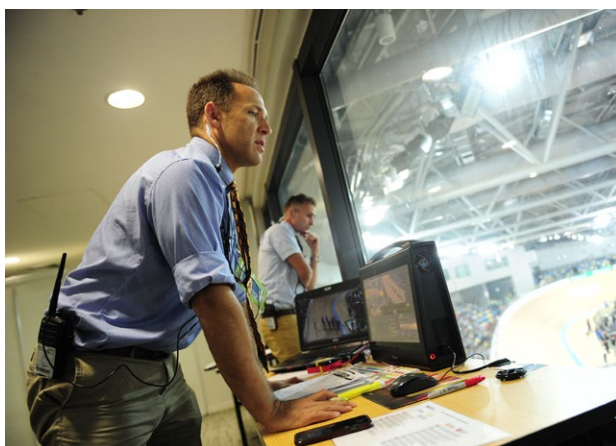

An important requirement for all major competitions where there are races necessitating a Judge-Referee is the provision of recording equipment for the Judge-Referee. (The actual positioning of the Judge-Referee is discussed in [3.3.2.1](#)). The organisation is responsible for providing this equipment and its operators.

As a minimum the Judge-Referee needs:

- a suitable video system to film the event (with sufficient resolution and the ability to zoom);
- a system to record footage, mark points in the footage and allow playback, including slow motion playback, while recording is ongoing;
- a display monitor large enough to allow proper viewing of the footage.

There also needs to be another display monitor in the Secretariat that is available to the PCP and linked to the Judge-Referee's display.

It is also becoming more common at major competitions to have a second, and even third Judge-Referee camera positioned to provide a different perspective. In this case the second camera is usually placed in turn 3, and the third camera is used to provide a full view of the racing surface at all times.

LAP BOARD



A lap board is required on the Finish Line. This needs to be able to display the total number of laps remaining to be ridden. For longer bunch races, this often means displaying three figures on the board.



The lap board is usually positioned just after the Finish Line, on the inside of the fence (i.e. not on the Safety Zone).

There must also be a bell that can be clearly heard around the track. This is used to indicate the start of any sprint laps or the final lap.

In addition to the lap board on the Finish Line, if there are Pursuit or Time Trial events, there needs to be a lap board and bell positioned just after each of the Pursuit Lines. These boards are often also linked to the starting system as part of the countdown apparatus (see 3.2.1).

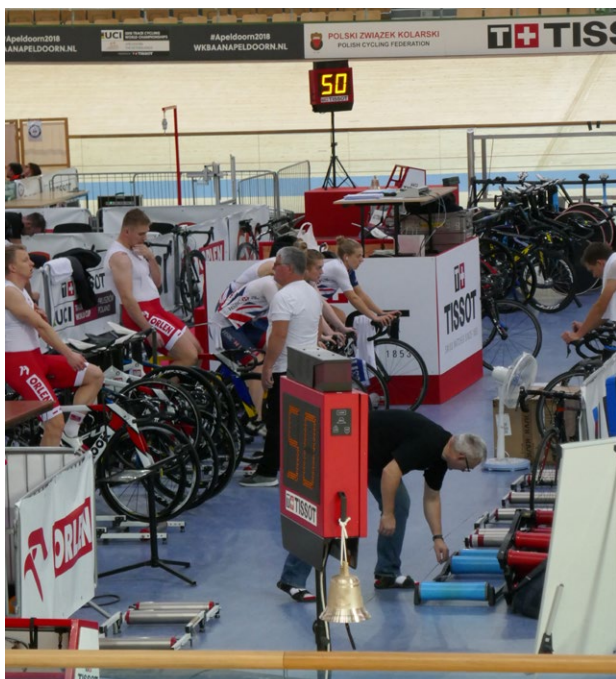

These lap boards also feature red and green lights to indicate the passage of a rider across the respective Pursuit Lines. When a rider crosses the Pursuit Line on the home straight, the red light illuminates; when a rider crosses the Pursuit Line on the back straight, the green light illuminates.

3.2.3. RECORDING

Commissaires should ensure they bring their own recording equipment such as notebooks, timing sheets and scoresheets to competitions. Some sample scoresheets are provided in Chapter 15. These should be adapted for the track length as well as any other special features of the events being run. Many people have their own versions of these sheets; those provided are examples of what can be used.

All completed timing and scoresheets must be delivered to the Secretary after the event as a means of verifying the results.

NOTE

Even though the organisation is required to provide electronic timing and judging systems, usually through service providers, the results of the race remain the responsibility of the Commissaires.

For major competitions, the organisation is required to provide an electronic scoreboard. When a scoreboard is being used, the organisation is responsible, normally through a service provider, for the information displayed on the board.



TIP

The Commissaires should continuously monitor the scoreboard to ensure that the information displayed is accurate, especially in events where points are scored. This task will often fall to the Secretary.

3.2.4. DERNY

The dernity is a form of moped used to replace human pacing. This means that its form and function should closely resemble that of a bicycle, except that it is powered by an external motor. It is now becoming common for the dernity to be powered by an electric motor.

The organisation must provide a dernity for those events for which it is required, together with an experienced driver. Ideally the organiser should also have a second dernity on stand-by in case the first breaks down.



There are strict requirements for the dernity (UCI Regulations Part 3, Chapter 6, Article 3), although it is not uncommon in lower-level competitions to see various forms of motorised cycles, including motorbikes, being used. Strictly speaking the regulations do not permit this.

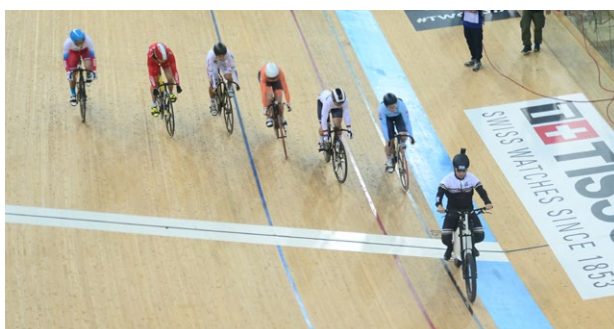

Since the dernity is supposed to replace human pacing, the dernity rider is required to dress as if riding a bicycle. The exact clothing is described in the UCI Regulations Part 3, Chapter 6, Article 5.

The PCP should verify that the dernitys are available and that the driver is fully aware of the relevant regulations of the events.

The PCP, or the Technical Delegate (TD) if present, monitors the conduct and speed of the dernity.

3.2.5. OTHER

In addition to the equipment mentioned earlier in this section, the organisation must also provide other equipment for use by the Commissaires.

The organiser must provide the Starter with at least one (but preferably two) starter pistols, together with enough ammunition. The Starter must verify that the starter pistol and ammunition is present and that it works.

The Starter must ensure that the pistol always has enough ammunition loaded in order to control the race. This includes both starting and stopping a race.

A second starter pistol is useful for a few reasons:

- it can be used as a backup if the first fails;
- it allows for a fully-loaded pistol to always be available;
- in cases where there are starts on both sides of the track, it allows the Assistant Starter to call a false start.

The organiser should provide a system that can be used by the riders to draw starting positions in the Sprint events. This can include electronic tablets, numbered golf balls, numbered cards, numbered sticks, etc.



TIP

It is useful for Commissaires to have their own equipment for drawing lots in case the organiser is not able to provide anything.

The organiser must make certain flags available to the Commissaires. As a minimum there should be two red flags, one green flag and one yellow flag.

The red flag is used by the Commissaires in the following way:

- on the home straight to indicate to the Starter when a bicycle has been properly loaded into the Starting Gate;
- to indicate to a Team Pursuit team that it is about to be passed and may not make any more changes of rider sequence;
- to indicate to a rider that he or she has been disqualified.

The green flag is used by the Commissaires in the following way:

- on the back straight to indicate to the Starter when a bicycle has been properly loaded into the Starting Gate.

The yellow flag is used by the Commissaires in the following way:

- to indicate to a rider that he or she has been issued a warning.
- to indicate to all that the race is neutralised (e.g. after a mishap in an elimination race)



The organisation is required to provide the PCP with a whiteboard, marker pen and eraser. This is used by the PCP, together with either a yellow or red flag, to indicate to a rider in a bunch race that he or she has been warned or disqualified. The PCP writes the number in large numerals on the board and then displays this board, together with the relevant flag, to the bunch, rider and team personnel standing on the back straight. The board must be large enough to write on, but not so large that it cannot be easily held up or that it poses a safety hazard.



TIP

It can be useful for the PCP to bring his or her own flags, whiteboard and marker pens to a competition.

The organisation is required to make radios, operating on a private channel, available to all the members of the Commissaires' Panel so that they can properly communicate with each other. The Speaker should also be provided with a radio on the same frequency in order to receive all official communications.

NOTE

The PCP should meet the Speaker in advance of the competition to ensure that the Speaker understands the role as well as the limits of what can be said based on the information provided by radio.



The organisation must provide equipment to measure bicycles. This includes at least one jig, weighing scales and any additional items required to facilitate their use. Ideally there should be two jigs available since there are often starts on both sides of the track. Also, for bunch races, there are often a large number of bicycles to be measured. There should also be a horizontality device for measuring the slope of the saddle, a tape measure and calipers.

This is discussed in more detail in Chapter 11.

TIP

It may be useful for Commissaires to have their own tape measure, calipers and horizontality/spirit level device.



In some cases, the organisation may also provide other specialised equipment related to the events being held at the competition. For example, a flashing light system may be provided: riders securely attach a box to their handlebars during the Elimination Race that flashes to indicate when they have been eliminated.

NOTE

Any equipment used on the track must not represent a safety hazard to the riders and must comply with the regulations.

All Commissaires must have a whistle. The Starter uses a whistle to start a number of events and it can also be used to gain a rider's attention.

EXAMPLE

A whistle can be used to inform a rider to withdraw from a race. A whistle can also be used to indicate a false start if the pistol fails.

REQUIRED KNOWLEDGE

- Equipment that is provided by the Commissaires.
- Required timing equipment.
- Required starting equipment.
- Equipment required by the Judge-Referee.
- Equipment required for carrying out bicycle checks.
- The form and function of the derny.
- Additional equipment required depending on the different events being run.

WHAT TO DO

- Check in advance that the organiser knows what equipment is required.
- Ensure all the required equipment is available.
- Ensure all the required equipment is functional.
- Bring any items that are the responsibility of the Commissaires.

WHAT NOT TO DO

- Assume the equipment is available.
- Assume the equipment will work.

3.3. PRACTICAL ORGANISATION OF THE TRACK

In addition to the essential equipment required for the sporting aspects of the competition, properly organised functional areas are necessary to ensure that the competition runs efficiently.

3.3.1. MEETING ROOMS

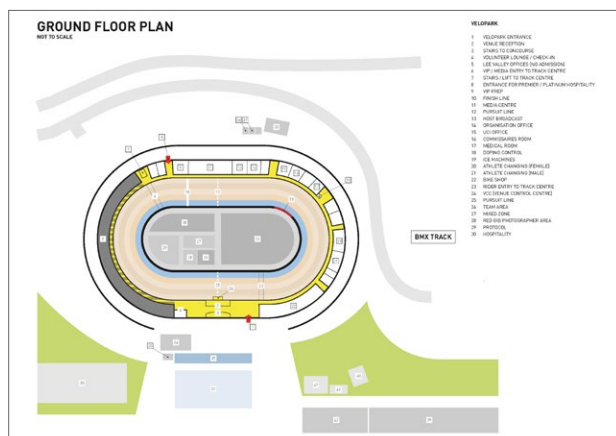

The organisation is obliged to make a number of offices and meeting rooms available for the competition. All of these rooms should be well signposted so that they are easy to find. They should be made available according to the schedule of the competition.

3.3.1.1. Permanence

The first of these offices is known as the Permanence. This is the organisation's race headquarters and organisational administration centre.

The opening hours need to be clearly identified in the competition's Technical Guide. The Permanence should be staffed with people who are knowledgeable about the administration and logistics of the competition. This may include things such as:

- accommodation,
- meals,
- transportation,
- team cabins,
- equipment,
- velodrome management,
- prize money,
- medical services.

This is the office where all groups associated with the competition will be received by the organisation and provided with official documentation. This includes:

- teams,
- organisational staff,
- Commissaires,
- medical personnel;
- volunteers.

NOTE

The Permanence staff do not check race licences or issue race numbers without the approval of the Commissaires' Panel.

The Permanence should be equipped with:

- telephone,
- fax (optional),
- computers,
- printers,
- copiers,
- Internet access.

3.3.1.2. Team Managers' Meeting Room

Since all international competitions require a Team Managers' or riders' meeting, depending on the level of the competition, the organisation must make a suitable space available for this meeting.

The following people are required to attend the Team Managers' meeting:

- PCP,
- Commissaires,
- Technical Delegate,
- Organiser,
- Other members of the organisation as needed by the organiser,
- Doping Control Officer,
- Team Managers.



The venue needs to be large enough to accommodate this number of people.

The room must have sufficient chairs for all attendees, as well as a table for those presenting at the meeting. Depending on the number of people attending, a public address system may be required.

The venue needs to be suitably private so that participation can be restricted to only those people who are permitted to attend.

A large room is usually reserved for this purpose. Often this room is allocated for other purposes after the Team Managers' meeting; for press conferences for example.

On arriving at the venue, the PCP must check the room and its suitability for the Team Managers' meeting. The PCP must ask the organiser to correct any shortcomings.

3.3.1.3. Commissaires' Meeting Room



The organiser must also make a Commissaires' Meeting Room available for the duration of the competition. This room should be available from the day the Commissaires arrive on site, often the day before the competition starts, until after the end of the competition.

As a minimum, this room needs to be equipped with tables and enough chairs for all the Commissaires. The room needs to be suitably private, and access must be restricted to the Commissaires and anyone authorised by the Commissaires.

The room must have Internet access and power sockets.

At higher-level competitions, snacks and drinks may also be made available to the Commissaires in this room. There may also be a computer and telephone, although these facilities are less common.

The Commissaires' Meeting Room serves two main purposes:

- It is where the Commissaires do their work when they are not officiating on the track, for example, before the start of the competition, between sessions and after the end of the competition,
- It is where the Commissaires can get some rest and refreshment before, between and after sessions.

The Commissaires' activities in the meeting room include:

- assignment of Commissaire tasks,
- preview of events,
- review of incidents from the session,
- licence control,
- number distribution,
- seeding of starters,
- preparation of initial start lists

On arriving at the venue, the PCP must check the room and its suitability as a Commissaires' Meeting room. The PCP must ask the organiser to correct any shortcomings.

3.3.1.4. Doping Control Station

While doping control activities are not the function of the Commissaires, the PCP and Commissaires should be aware of the location of the doping control station. This will enable them to direct people accordingly and locate any individuals who may be at this room, such as the Doping Control Officer or team staff, if they are needed elsewhere.

NOTE

The PCP does not inspect this room or pass judgement on its suitability. This is a function of the Doping Control Officer.

3.3.2. INFIELD FIXTURES

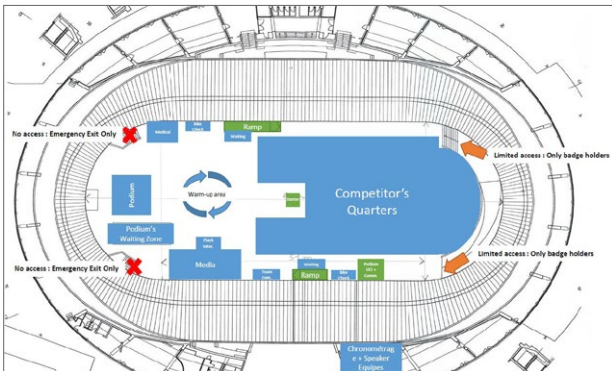

In addition to the Meeting Rooms, there are a number of other functional areas that the organiser must make available to the Commissaires on the infield of the velodrome. These support the functioning of the competition in sporting terms.

3.3.2.1. Judge-Referee Podium



A podium must be available for the Judge-Referee. This must be positioned on the outside of the track in corner 1, looking down the home straight. It should be high enough so that the Judge-Referee is able to get a good view of the entire track, but it should not be so high or far back from the railing that the official cannot see the Sprinter's Lane. The Judge-Referee podium must also be private. It must not be possible for anyone other than the Judge-Referee, Commissaires and Judge-Referee camera operator to access the podium, view the images or hear the conversation. The Judge-Referee or PCP may at their discretion give other people temporary permission to access this podium.

This particular position is in high demand by media and spectators since it offers a good sight line of the home straight and finish. Consequently, there is always the potential for conflict between the sporting requirements of the Commissaires and the needs of the media. The Commissaires should not compromise on the sporting aspect since a bad location will impact on the ability to perform the job correctly. Commissaires also need to keep conversations confidential, which means they need to ensure there are no audio recording devices in the vicinity.

When the PCP and Judge-Referee arrive at the venue they must check the location of the podium and make sure they are able to easily access it, including on competition days. They must also make sure that the podium is safe to access and use.



TIP

Ensure that appropriate accreditation is provided to the Commissaires to access this podium.

The organiser needs to make suitable video and replay equipment, as well as a camera/video operator, available (see 3.2.2). There should be a sufficient number of tables and chairs for the Judge-Referee and camera/video operator.

All the required equipment should be in place when the Commissaires arrive at the venue.

In addition to checking the actual podium, the Judge-Referee should also check that all the equipment is available and that the operator knows how to use the equipment and what is expected of him or her.



TIP

The Judge-Referee can work with the operator during a training session or one of the events that does not need recording to ensure that the operator understands the role and the Judge-Referee's method of working.

3.3.2.2 Starter's Podium



In competitions where there are Pursuits, Team Sprints or Time Trials, with riders starting on both sides of the track, a Starter's Podium must be located in the centre of the infield.

This podium needs to be positioned in such a way that when the Starter and Assistant Starter are standing on the podium they are directly in line with the two Pursuit Lines.

On arriving at the venue, the PCP and Starter need to check this podium to make sure they have an unobstructed view of the Pursuit Lines and are directly in line with them.



TIP

Consider how things will look on competition days when checking the sight lines. Ensure that the sight lines will remain unobstructed once there are riders, team staff and other competition personnel on the infield and track.

The Starter's Podium should have a table and two chairs on it, as well as any electronic starting apparatus (see 3.2.1).

Access to the Starter's Podium, including the steps of the podium, is restricted to Commissaires. Even when the podium is not being used by the Commissaires, people may not sit or stand on it.

3.3.2.3 Secretariat



The Secretariat is the area reserved for officials and is usually located in the track infield near the Finish Line.

It must be a secure area with access restricted to:

- Commissaires,
- assistants to the Secretary,
- Speaker,
- Timing Company,
- Organiser.

Anyone else requiring access should get permission from the Commissaires.



EXAMPLE

Team Managers are sometimes given access if they wish to announce changes to their starters or review incidents.

NOTE

In many cases when the Judge-Referee has made a decision team managers may approach the PCP asking to view the video or review the decision. The PCP may decide to invite the relevant team managers on to the Secretariat to view the video, but should do so only after first viewing the video and discussing it with the Judge-Referee. Team Managers do not have a right to view the video or enter the Secretariat.

The area must not be used by others such as the media, guests or general organisation as crowding will affect the Commissaires' ability to do their job properly. It can also compromise the confidentiality of any discussions taking place.

The organiser should equip this area with a sufficient number of tables and chairs. It should also have ample power points and Internet access. The Timing Company usually supplies most of its own equipment, but there should also be a computer and printer for use by the Secretary, as well as high-speed photocopiers, pigeonholes for distributing communiqués and the video feed for the Judge-Referee.

The PCP and Secretary must check this area on arriving at the venue. The Secretary must make sure that there is sufficient space to do his or her work properly.

NOTE

The various service providers often take up a lot of space. The Commissaires must make sure they are not pushed out of this area.

The Finish Judge and Lap Board Operator are often also located in the Secretariat area. The PCP must make sure there is space and an appropriate location for them. The Finish Judge should be able to see the Finish Line clearly, as well as work with the photo-finish operator. The Lap Board Operator must be able to see the entire track and be able to change the lap board and ring the bell.

The PCP should also make sure that the Judge-Referee video feed is suitably private in the Secretariat. This means that the monitor should be angled to restrict unauthorised viewing. There must also be no audio recording devices in this area.

3.3.2.4 Rider Equipment

A key element of track cycling is the continuous checks of bicycles throughout the competition.

The organiser needs to make at least one area available where bicycle checks can be securely performed. If there are starts on both sides of the track there should ideally be two areas and two sets of bicycle-checking equipment. There should also be bicycle racks and a table in each of these areas.

NOTE

In the case where two bike check stations and/or jigs are being used, one jig must be declared as the primary jig. All bikes are required to be measured on this jig and pass the bike check. This is to take into account any potential discrepancies that exists between the two jigs.

The bicycle check area should be situated to allow for a natural flow through the zone and then on to the track. This means that bicycle check areas are normally located near the track access point, such as the access ramp.



When this area is being considered it is important to take into account the number of bicycles that will need to be checked. If, for example, there are bunch races, there could be a large number of bicycles and spare bicycles to be checked. This means that it must be possible for bicycles to be brought into the check area and then taken out to the track without obstructing other bicycles coming in to be checked. There must also be enough space to leave bicycles within the area after they have been checked.

This area must also be set up in such a way that the Commissaires performing the checks are able to do their work, as well as maintain a view of the bicycles that have been checked until they are taken onto the track. While it is often not possible to completely secure the area being used for bicycle checks, it should be placed in such a way that it is

possible for the Commissaires working in the area to maintain control of the checked bicycles, as well as perform their work properly. This means it should not be among the team boxes, or out in an open area. Ideal locations are near the access ramps or at the Starter's Podium.

The PCP and Technical Commissaire must assess the bicycle check area on arriving at the venue. They need to make sure that all the required equipment is available (see 3.3.5 and Chapter 11). They must check that the area is large enough, secure enough and that there is a flow through the area that will not cause any delays to the start due to riders not being able to access the area.

It is important that this area is set up well in advance of the start of the competition so pre-checks of equipment can be carried out. For larger competitions, this means that the area must be set up and properly equipped by the day before the first event. For other competitions, it should be available from at least one hour prior to the start of the first event.

3.3.2.5 Team Zone

The Team Zone consists of a number of cabins or boxes and often takes up the largest area of the infield.



The organiser must plan the zone taking into account the number of riders who will be present during any one session, as well as the size of the various teams. The zone also needs to be set up in such a way that allows the riders to easily enter and leave the area.

Each team is usually given its own box separated by barriers. It is common practice for very small teams to share a box if there are a large number of teams and riders present.

Each box should be equipped with sufficient chairs, a table and bicycle racks.

NOTE

The organiser will take into account the competition programme to determine the number of riders present during a session when planning these boxes. The boxes are often not able to accommodate the entire team if all members are present at the same time. The organisation also usually provides storage outside the infield for each of the teams so that they can keep all their equipment at the velodrome without having to store it all in the infield.

The public address system must be directed to this area so the teams are able to hear any race announcements by the Speaker.

Depending on the level of competition, the organisation may install power points to the various boxes. There may also be some form of refreshments available in this area.

NOTE

The organiser is fully responsible for the organisation and control of the Team Zone. If a Technical Delegate is present, the organiser works with the TD to manage the area and deal with any complaints.

The PCP must review the area to make sure riders can easily enter and exit. The PCP checks that the Team Zone does not impact on the sporting control of the competition, for example, by obstructing sight lines or preventing Commissaires from doing their work. The organiser should provide the PCP with a map of the zone showing where each of the teams is located. The PCP should also listen to announcements during the competition to determine whether the teams are able to hear them in the infield.



TIP

The acoustics in an empty velodrome are different to those in a full velodrome. Ensure that the PA system is audible in the infield when the competition is taking place.

3.3.2.6 Other



Related to the Team Zone is a warm down area on the infield. The organiser needs to create a zone on the infield where riders can warm down after exiting the track. This area must be cordoned off and allow the riders to slowly ride around within the demarcated zone.

The PCP must check the location of this zone to make sure it will not impact on the work of the Commissaires and will not obstruct the proper running of the competition. It is important to take into account any areas where access is needed or people are required to walk.

NOTE

This arrangement is not meant to prioritise warming down; riders using this zone must always remain vigilant for people crossing the area.

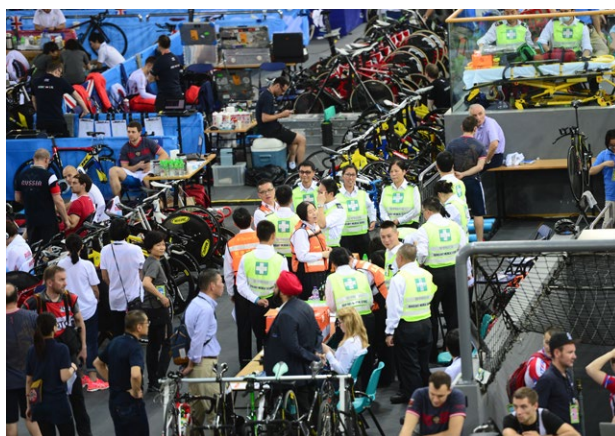

The organiser also needs to make a medical zone available on the infield. This is in addition to any First Aid Room within the velodrome. This zone is where the medical team monitors any incidents on the track, where the race doctor can be located and where medical equipment for immediate treatment is kept. The medical zone should be located such that it is easy to access and clearly visible. It must allow the medical team swift, unhindered access to the Safety Zone. The medical zone is often located near the access points to one of the ramps.

In addition to any required medical equipment, the organisation should also provide sufficient tables and chairs for the people within this area.

The PCP must know where the medical zone is located.

There also needs to be a track maintenance zone near one of the track access points. Often this will be near the medical zone. This is where the person responsible for maintaining and repairing the track is stationed during the racing. This zone needs to have all equipment necessary to ensure that the racing can stay on schedule if there are any issues with the track surface. Example equipment for the track maintenance zone:

- ladder,
- brooms,
- mops,
- vacuum cleaner,
- sandpaper,
- tape,
- wood putty.



The PCP must know where this area is located and must meet the individuals responsible for track maintenance. The PCP must also check that all the required equipment is available on the infield during racing.

The awards podium is usually located on the infield. Often a backdrop is used with the podium. This backdrop must not block any sight lines for the track. The backdrop is usually only raised for the ceremony itself and then immediately lowered afterwards. A waiting area for the protocol team and award winners also needs to be provided so that the ceremony can be conducted in a dignified manner. During racing, no-one may stand on the awards podium.



The PCP should check the podium to make sure it will not affect the work of the Commissaires, and that it is easy for riders to get on and off. It is also important to know where the waiting area is so that the conduct of the award winners can be monitored, as well as knowing where to find people involved with the ceremony if necessary.

Near the starting area, the organiser must provide a waiting area for the riders. For the Pursuit, Time Trial and Sprint events, this area should have enough chairs for the riders. In the case where starts are held on both sides of the track, there must be a waiting area on either side.



The waiting area must not obstruct the view of the Starter or Assistant Starter, and in the case of a sunken infield, should be below the ramp, not on the same level as the Safety Zone. All the riders' equipment and team personnel must stay off the ramp and stairs leading up to the track until the rider enters the track.

The PCP must check the rider waiting areas upon arrival at the venue to ensure they are suitably located and have enough chairs to accommodate the required number of riders. Always plan to have sufficient chairs to accommodate the largest of the event heats.



EXAMPLE

In the case of a Team Pursuit there should be four chairs in each of the waiting areas. In the case of the Keirin there should be seven chairs in the waiting area.

NOTE

During racing, unless authorised by the PCP, no-one may stand, and equipment must not be placed, on the ramps or stairs as this obstructs access to the track in the case of a medical emergency, blocks sight lines for the Commissaires and hinders media images. Team personnel and their equipment are not permitted to wait in this area during any races, including bunch races.

**REQUIRED KNOWLEDGE**

- The function of the Permanence.
- The requirements for the Team Managers' Meeting Room.
- The requirements for the Commissaires' Meeting Room.
- The requirements for the Judge-Referee's podium.
- The requirements for the Starter's podium.
- The requirements for the Secretariat.
- The requirements for the bicycle check area.
- The requirements for the Team Zone.
- The arrangement of the infield fixtures.

**WHAT TO DO**

- Check all the meeting rooms for suitability.
- Check all the infield sporting fixtures for functionality.
- Ensure appropriate accessibility for all infield fixtures.
- Introduce yourself to the medical team.
- Introduce yourself to the track maintenance team.
- Have a map of the infield showing the locations of all the teams.

**WHAT NOT TO DO**

- Assume the meeting rooms will be the appropriate size.
- Assume the team boxes will be well laid out.
- Assume the bicycle check area will be properly set up.
- Allow team personnel and equipment to be stationed on the track access ramps during bunch races.
- Continuously invite team managers into the Secretariat to review videos of incidents.

CHAPTER 4 REGULATIONS



4.1. UCI REGULATIONS

Cycling, like all sports, is subject to regulations. All of the rules are gathered together in a written document – the UCI Regulations – that govern the sport of cycling and its administration. As previously mentioned, this document represents an essential working tool for Commissaires while also being the universal reference material for all parties involved in cycling (organisers, teams, riders, the media, fans, etc.).

A REGULATORY FRAMEWORK FOR THE PRACTICE OF THE SPORT

Cycling is an international sport and as such the rules must be interpreted and applied uniformly. A regulatory framework is necessary to ensure that events run properly. When rigorously applied, this framework guarantees:

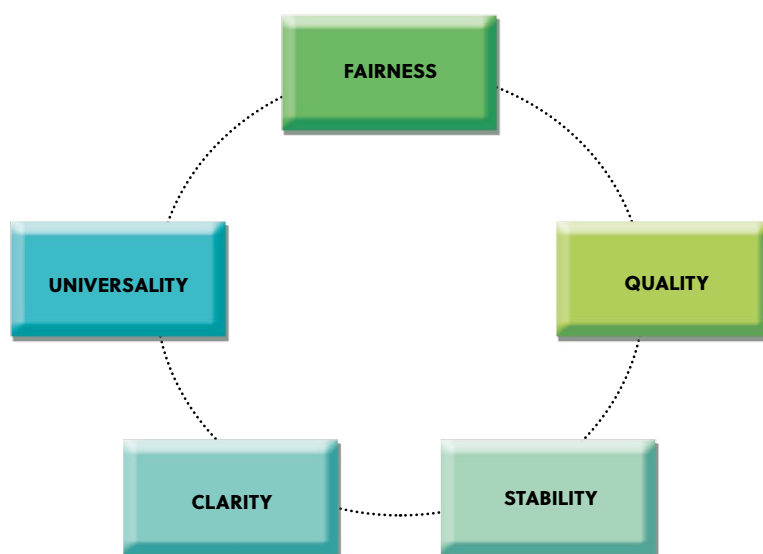

Diagram. The advantages of a regulatory framework

The UCI defines and oversees the implementation of the regulatory framework. The regulations govern the practices of cycling and the functioning of institutions, in both administrative and technical terms.

The regulatory framework encompasses the UCI’s technical decisions as well as sporting values. The regulations contribute to preserving the equilibrium between the members of the family of cycling.

SCOPE OF APPLICATION

- The UCI Regulations apply in all countries affiliated to the UCI.
- They serve as the basis for the regulations of national federations (NF) affiliated to the UCI.
- The UCI Regulations apply to male and female riders aged 17 and above. The rules for riders aged 16 and under are defined by NFs.



Diagram. Scope of application of the UCI Regulations

SUMMARY AND NOMENCLATURE

The UCI Regulations address the following subjects, organised into "Parts":

- Preliminary provisions
- Constitution
- Part I: General organisation of cycling as a sport
- Part II: Road Races
- Part III: Track Races
- Part IV: Mountain Bike Races
- Part V: Cyclo-cross Races
- Part VI: BMX Rule Book
- Part VII: Trials Regulations
- Part VIII: Indoor cycling:
- Part IX: World Championships
- Part X: Continental Championships
- Part XI: Olympic Games
- Part XII: Discipline and Procedures
- Part XIII: Sporting Safety and Conditions
- Part XIV: Antidoping Rules
- Part XV: Cycling For All
- Part XVI: Para-cycling
- UCI Code of Ethics
- UCI Rules of Good Governance

3.2.009

Part 3
Chapter 2
9th article

Riders' numbers

(N) riders shall bear two number panels, save in the following specialities where they shall bear just one: the Km Time Trial, the 500 m Time Trial, the Individual Pursuit, the Team Pursuit and the Team Sprint. Riders shall bear two number panels in all events in the Omnium competition.
(text modified on 1.01.02; 1.02.11)

The Regulations are further divided into Articles, numbered as shown by the example opposite.

This nomenclature allows a logical organisation of the rules. The reader is assisted in identifying the subject in question by chapter subtitles and article titles.

CONTENT

For each theme and discipline, the regulations list the various conceivable cases, as illustrated by the table below.

TABLE. Example provisions of the UCI Regulations

| Extracts from the UCI Regulations | |
|-----------------------------------|--|
| AUTHORISATIONS | <p>3.2.149 Teams shall be made up of riders entered for this event. The composition of a team may be modified from one heat to another. An incomplete team may not take the start. The team manager must notify the Commissaires of any changes at least 30 minutes before the relevant competition round start.</p> |
| PROHIBITIONS | <p>3.2.056 A caught rider may not take pace from his opponent, nor pass him, on pain of disqualification.</p> |
| MEASUREMENTS | <p>3.2.025 The rider shall build up speed over a distance depending on the length of the track:</p> <ul style="list-style-type: none"> - 250 metres track or smaller: 3.5 laps - 285,714 metre tracks: 3.0 laps - 333,33 metre track: 2.5 laps - 400 metres track and longer: 2.0 laps |
| EXHAUSTIVE LISTS | <p>3.1.009 The number of riders on track shall in no case exceed:</p> <ul style="list-style-type: none"> 20 (15 teams for Madison) on a 200 m track 24 (18 teams for Madison) on a 250 m track 36 (20 teams for Madison) on a 333.33 m track |
| NON-EXHAUSTIVE LISTS | <p>3.2.005 Riders may carry no object on them or on their bicycles that could drop onto the track. They may not bear or use on the track any music player or radio communication system. In addition, any electronic device with display (for instance speedometer or powermeter) must be hidden to that it cannot be read by the riders.</p> |

In the majority of cases, sources of confusion can be resolved by applying logic and considering the facts. Nevertheless, at the time of learning a regulation, during the first reading or training session, Commissaires must, above all, ask themselves whether they have understood the sense and logic of each point of the regulations.

Understanding the spirit, objective and intention of a point of the regulations will assist in both avoiding confusion and memorising the point in question.

AMENDMENTS OF THE UCI REGULATIONS

The UCI makes a major commitment to ensure that the regulations are adapted to comply with new situations, in particular with reference to reforms of the various disciplines and the requirements of the World Anti-Doping Code.

Amendments are made to the regulations every year by means of a process that involves:

- specific UCI Commissions (disciplines, Commissaires, athletes, etc.),
- the UCI's sport department,
- the UCI's legal department.

Commissaires are able to propose amendments or corrections of the regulations (e.g. to address inconsistencies between different articles, vague wording, etc.) in response to specific situations encountered during competitions.

The amendment is then presented to the UCI Management Committee which decides whether to accept or reject it.



Diagram. The process of amending a UCI regulation

Information to ensure the traceability of the document appears in two locations:

- at the foot of each page of the document, opposite the page number.
For example: E0417 indicates the April 2017 English version.

| | | |
|-------|-------------|---|
| E0417 | TRACK RACES | 5 |
|-------|-------------|---|

- the date of an amendment or removal of an article is given below the article in question.

| | |
|---------|--|
| 3.2.029 | The sprint is a race between 2 to 4 riders over 2 or 3 laps. <i>(text modified on 4.07.03).</i> |
|---------|--|

USE BY COMMISSAIRES

It is not enough for a Commissaire to simply read through all the regulations while preparing for the Commissaire examinations. It is rather a matter of regularly reading the regulations to dispense with any preconceptions and provide context for new features.

Furthermore, reading a specific chapter to prepare for a competition is recommended (e.g. sprint, 6-Days, etc.).

Commissaires must always have the latest version of the regulations in their possession. Although a hard copy of the regulations can be easily carried around and is particularly useful when Commissaires are engaged in their duties, it is recommended that work be conducted using an electronic version (on computer, tablet or mobile phone) as this is more economical and respects the environment.

Whatever the medium used, previous versions of the regulations should be clearly archived to avoid working from a version that is not up to date.



REQUIRED KNOWLEDGE

- How to access the UCI Regulations.
- Knowledge of the numbering of articles.
- The process of amending the UCI Regulations.
- Awareness of new versions and amendments of the UCI Regulations.



WHAT TO DO

- Regularly read the UCI Regulations, understand and memorise them.
- Implement a personal strategy depending on the medium used to access the regulations (paper or electronic version, archiving techniques).
- Identify pertinent articles and know how to access them quickly.
- Know how to interpret the regulations in specific situations.



WHAT NOT TO DO

- Learn the regulations by heart without understanding the logic behind them.
- Interpret the regulations in different ways at different times if they do not specifically refer to an issue.
- Treat the regulations as a "scientific", exhaustive list.
- Conclude that what is not prohibited by the regulations is automatically authorised.

And conversely

- Conclude that what is not authorised by the regulations is automatically prohibited.

4.2. NATIONAL FEDERATION REGULATIONS

COMPATIBILITY OF REGULATIONS

A national federation (NF) operates on the basis of its constitution and internal regulations, which specify that, in accordance with the delegation of powers, it draws up the **administrative and technical regulations** for national cycling for the various disciplines of cycle sport, while respecting the international regulations. These national regulations must always comply with the UCI Regulations.

CALENDAR

When publishing their national calendars of competitions, federations must include international calendar competitions taking place in their countries.

UCI Regulations prevail for international competitions (for example with regards to categories) rather than NF Regulations.

DRAFTING AND ADAPTATION

Federations must put in place procedures for drafting, publishing and updating their regulations. National regulations must incorporate amendments of the UCI Regulations without delay.



WHAT TO DO

- Examine and familiarize yourself with national federation regulations.

4.3. SPECIAL REGULATIONS FOR A COMPETITION

The organiser draws up the special regulations for the competition.

The special regulations must be included in the programme and/or organiser's technical guide such that all participants become aware of them.

 For track competitions, the special regulations for the competition must include, as a minimum, the information listed in **ARTICLE 3.1.002** and detailed in the checklist of section 6.3.1 of this guide.

For each technical point for which the UCI Regulations establishes a minimum, maximum or range of options, the organiser must clearly set out, in the special regulations, the situation that will apply to the event.



Examples of decisions to be made by the competition organiser:

- Events to be run
- Categories
- Programme structure
- Field size
- Prizes for all classifications,
- Podium ceremonies,

The special regulations of a competition complement the UCI Regulations. The organiser's margin for manoeuvre generally offers influence over the way in which the competition unfolds (e.g.: events being run, categories, field sizes, composition of series and heats, etc.). The specific features of the special regulations must be checked by the Commissaires to ensure they comply with the limits established by the UCI Regulations.



Check-list – Special regulations for a competition

- Check the compliance of the special regulations with the UCI Regulations.
- If necessary, suggest changes to the organiser, concerning the following points in particular:
 - participation,
 - programme structure,
 - event timing,
 - composition of heats,
 - composition of series,
 - podium ceremonies.



REQUIRED KNOWLEDGE

- Ability to compare the special regulations of an event with the UCI Regulations.
- Ability to assess the limits of the special features that an organiser or federation wants to include, beyond which they would contradict UCI Regulations.
- Ability to quickly identify a specific point in the regulations.



WHAT TO DO

- Comprehensively study the special regulations of a competition and check their compliance.
- Check that any disputes or specific situations arising from previous editions are covered and/or mentioned in the special regulations of the competition.



WHAT NOT TO DO

- Allow an organiser insufficient time to correct the special regulations.
- Accept differences between the special regulations of a competition and the UCI Regulations, or additions to the special regulations, that do not comply with the UCI Regulations.

4.4. KEY TRACK COMPETITIONS AND EVENTS

As with all the other cycling disciplines, the UCI is responsible for creating an international calendar for track cycling. The two principal competitions on this calendar are:

- Olympic Games,
- World Championships.

The main supporting competition is:

- World Cups.

The remaining international competitions are:

- Continental Championships,
- Regional Games,
- National Championships,
- Class 1 competitions,
- Class 2 competitions.

The events that make up the World Championships constitute the principal track cycling events and represent the core of the sport. Commissaires need to be completely familiar with these events and how they are run.

The events that make up the World Championships are:

- Sprint,
- Individual Pursuit,
- Team Pursuit,
- Kilometre and 500 m Time Trials,
- Points Race,
- Keirin,
- Team Sprint,
- Madison,
- Scratch Race,
- Omnium.

The Omnium event is made up of:

- Scratch Race,
- Tempo Race,
- Elimination Race,
- Points Race.

NOTE

The events of the Olympic Games are a subset of World Championship events.

NOTE

The lists of events in which Men and Women compete at the World Championships are identical.



These are not the only internationally recognised events. Other events are defined and are subject to the UCI Regulations. These are:

- Flying Lap,
- Tandem,
- Motor-pacing,
- 6 Days.

UCI competitions feature these UCI events, but it is not a requirement that all events are held in every competition. The classification on the calendar determines how many of the events are held, and in some cases, which events must be held.

In addition to these events, organisers may choose to run events that are not specifically defined in the regulations. Some of these are historical events that used to be defined, for example, the Italian Pursuit; others may be unique to a single velodrome, for example, the Marymoor Crawl. In nearly every case though, these events draw upon the UCI regulations to support their sporting component.

To score UCI points for the rankings, the competition events must be defined in the UCI Regulations and run according to these. If an organiser chooses to run a defined event, but not according to the regulations, then the ranking points may not be awarded to the riders.

For UCI competition events, the PCP must check that the events are being run according to the regulations. If this is not the case, the organiser must be advised to correct the situation. If the organiser does not wish to make the correction, the PCP informs the organiser that ranking points may not be issued by the UCI for non-conforming events.



Example

Some typical examples of cases where events do not follow the regulations are:

- distances run do not comply with the regulations,
- composition of heats is not according to the regulations.

See [chapter 9](#) for a fuller discussion of the various events.



REQUIRED KNOWLEDGE

- The categories of competitions that make up the International Track Calendar.
- The key track events.



CHAPTER 5 MANAGEMENT AND SUPERVISION OF COMPETITIONS

As with road cycling, the framework of the competition is a result of the interaction between two of the main parties involved, namely the organisation and the Commissaires.

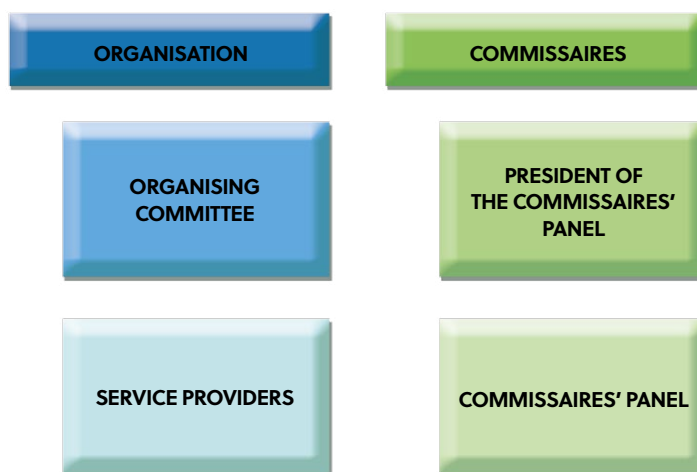



Diagram. The various players

 The Commissaires' Panel comprises all the officials appointed by the UCI and the NF of the competition's host country. The UCI Regulations (**ARTICLE 1.2.116**) establish the number and status of Commissaires for different competitions.

All members of the Commissaires' Panel are Commissaires, irrespective of the level at which they operate. As refereeing officials, they are empowered to:

- intervene and act,
- check and verify,
- report and provide evidence,
- apply or request a sanction, etc.

NOTE

The decision-making powers of the individual Commissaire on the track are not unlimited. They must work within the boundaries of the role they have been assigned and the responsibilities of the other Commissaire roles.

With track, the roles are much more clearly defined when it comes to the Commissaires' Panel. The structure is very clear and responsibilities are very specific.

Chapter 5.1 deals with the overall responsibilities associated with the various roles. The very specific responsibilities related to the different events are covered in [chapter 9](#).

5.1. COMMISSAIRE ROLES

Depending on the level of the competition, several of the Commissaire roles may be assigned in advance by the UCI. The remaining roles are then assigned by the PCP. It is not uncommon for Commissaires to be assigned more than one role depending on the events and the number of Commissaires at the competition.



TIP

The PCP should work with a Commissaire from the host National Federation to identify the NF- assigned Commissaires and then liaise to ascertain the most suitable role for each person.



TIP

The PCP should try to ensure that all Commissaires working at a competition know what their specific roles will be at the competition before they arrive. This will enable everyone to properly prepare for their role.

5.1.1.

PRESIDENT OF THE COMMISSAIRES' PANEL (PCP)

The PCP is appointed by the UCI and is the head of the Commissaires' Panel.

5.1.1.1. Role

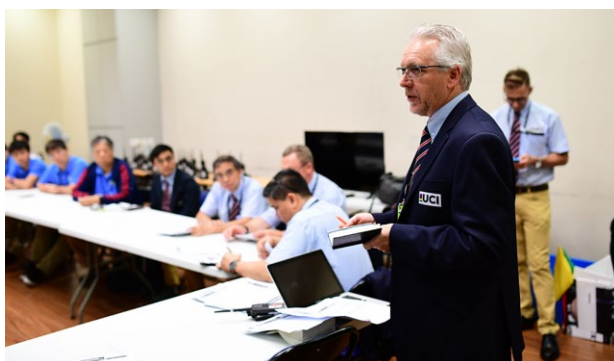

The PCP fulfils a role like a prime minister of a government – a first among equals. This means that he or she needs to provide leadership and guidance, but cannot, and must not, do all the work. While the PCP needs to accept responsibility for the conduct and actions of the panel, he or she is not necessarily the one making all the decisions. This makes the role a complex and demanding one.

Except in the case where the UCI has assigned specific roles to the Commissaires, the PCP allocates individual roles to all the Commissaires, defining their tasks. The PCP then needs to ensure that all Commissaires are in the correct position and performing their roles properly. This means that the PCP must have a good knowledge of the events being run and the tasks associated with each of the roles for each of the events.

The PCP needs to facilitate the work between the Commissaires' roles and intervene to resolve any conflict. The PCP also facilitates the work between the Commissaires and the stakeholders. He or she is the representative of the UCI and the leader of the team.

The PCP needs to manage the team. This means ensuring that team members are performing the roles that they have been assigned and intervening where there are problems. This intervention could be anything from providing a Commissaire with guidance, to issuing instructions for corrective behaviour, to removing a Commissaire from a role.



The PCP needs to communicate effectively with the team as well as all stakeholders in the competition. This means conveying messages so that everyone understands what is being communicated. It is important to then verify that the message has been understood.

TIP

To verify that an important message has been understood, the PCP should ask the person to confirm their understanding by explaining what was communicated.

Communication is not a one-way process. The PCP also needs to listen. This means actually listening to what is being said, reading all the non-verbal cues and reflecting on the message. To listen properly to what is being said is to pay attention to the message and not be thinking of a response while the message is still being communicated.

The PCP needs to enable the team to perform its work. This means working with all the stakeholders to ensure each of the Commissaires has what they need from the organisation to be able to perform their role; this is continuously monitored throughout the competition. If there is a TD at the competition, the PCP works with the TD to resolve any shortcomings as regards organisational support. This is further discussed in chapter 5.1.1.5. It also means the PCP supports each of the Commissaires in their role by allowing them to perform their work without micro-managing them.

TIP

A PCP who continuously intervenes in the work of another Commissaire will undermine confidence or relieve the Commissaire of his or her responsibility to perform the role properly.

The PCP needs to support the team. This means supporting their decisions as well as helping them in their development as Commissaires by providing guidance based on experience.

The PCP needs to influence the team. While the PCP is not responsible for all decisions, he or she must set the standard for the team and then ensure that this standard is met. Since many decisions that are made at a track cycling competition are not made by the PCP, if the standard the PCP has set is not being met, he or she needs to influence the team to bring them back to that standard. The regulations in many cases do not give the PCP the ability to demand compliance.

TIP

The PCP can influence the team by:

- discussing the desired standards with the team,
- paying attention during all events to check the standard is being met,
- being the knowledgeable expert,
- discussing decisions with colleagues,
- intervening when appropriate,
- being respectful (for example having one-to-one discussions).

The PCP needs to trust the team. It is not possible for one person to do everything, see everything and be everywhere. By trusting them, the PCP will be able to focus on all his or her other roles and tasks.

With the team in place, and properly functioning, the PCP constantly reviews the competition programme while it is running. This allows a proactive, rather than a reactive, response to any problems. If the PCP notices any potential issues, he or she can work with the team to address these before they arise. Working in this manner ensures that when something unexpected happens, the PCP can fully respond.

While the regulations make it clear that the organiser is solely responsible for the safety of the competition and for the installations associated with the competition (**ARTICLES 1.2.033** and **3.6.066**) and that licence holders are solely responsible for the safety of the equipment that they use (**ARTICLES 1.3.002** and **1.3.003**), the PCP does have a role in setting standards and providing advice and guidance as regards safety. Clearly, if the PCP, or any Commissaire, witnesses any unsafe condition, they have the duty and right to intervene immediately. This can be during the warm-up and training sessions (further discussed in chapter 6.5), as well as during the racing itself.

5.1.1.2. Collaboration with Secretary



The specific role of the Secretary is discussed in [chapter 5.1.2](#).

A key responsibility of the Secretary is keeping the programme of the competition on schedule. A good collaboration between the PCP and the Secretary is required; this allows the PCP to quickly respond to any issues that are caused by the programme, for example, the pace of the competition, number of heats, etc.

The Secretary is also the source and archivist of all sporting information documentation, called communiqués, for the competition. The PCP can thus quickly get any information that is required from the Secretary as well as provide the Secretary with any sporting information that needs to be documented (for example, penalties). The Secretary can also quickly alert the PCP to any issues, such as changes in entries, results, etc.

Finally, the Secretary can also assist the PCP with any competition administrative tasks related to the sporting component, thus allowing the PCP to focus on other activities. These tasks can include things such as keeping a spare set of communiqués, replacing race numbers, completing record application forms, etc.

5.1.1.3. Collaboration with Judge-Referee

The specific role of the Judge-Referee is discussed in [chapter 5.1.3](#).

Collaboration between the PCP and the Judge-Referee is critical since the Judge-Referee is solely responsible for making decisions on rider conduct during sprint and most bunch races. Since the PCP is responsible for setting and maintaining standards, there is a need for these two Commissaires to work closely together.

The Judge-Referee should collaborate with the PCP in making decisions. This does not mean the Judge-Referee must discuss every or any decision with the PCP, but it is a good practice on close decisions, or important decisions, to review the incident and discuss it with the PCP.

NOTE

It is normally the PCP who explains and defends the Judge-Referee's decision, so he or she needs to understand the reason for the decision. Even if disagreeing with the decision, the PCP should still understand why the Judge-Referee made it.

If a team manager wishes to review a decision taken during the event, it is the PCP who must review it with the manager. Only in exceptional circumstances should the PCP send the team manager to the Judge-Referee to discuss the incident.

NOTE

Team managers do not have a right to appeal a decision, or to review any videos. It can be good psychology to discuss the decision with them, but in all cases the PCP must decide on the approach he or she wants to take.

5.1.1.4. Collaboration with Technical Delegate (TD)

The specific role of the Technical Delegate is discussed in [chapter 5.1.10](#).

The UCI appoints a TD to major competitions. In this case, the TD will have been working with the organisation in advance of the arrival of the Commissaires at the velodrome. The TD should already be at the velodrome when the PCP arrives.

The TD is a useful point of contact for the PCP as the TD should have identified, and hopefully resolved, any organisational issues prior to the arrival of the Commissaires. On arriving, the PCP receives a briefing from the TD on any outstanding organisational issues, and their potential resolution, as well as any specific features of the competition.

The TD is a useful partner for the PCP during the event as he or she should be able to liaise with the various organisational contacts. This means that the TD is a valuable resource in resolving organisational issues during the competition. In many cases the TD should be the first point of contact for the PCP if there is an organisational problem. Problems could include things such as:

- equipment missing from the track,
- damage to the track surface,
- a lack of volunteers in vital areas.



Importantly, the TD is not a Commissaire, and is not there to make any sporting decisions. The TD must not be asked to get involved in this component of the competition. Equally, the TD should not try to influence any sporting decisions.

5.1.1.5. Session Preparation

The PCP's responsibilities begin upon acceptance of the appointment.

To prepare correctly for the competition, the PCP should first go to the Calendar section of the Track component of the UCI website. They should click on the competition and note the information, including the date and events that make up the competition. The PCP must then contact the organiser, or the UCI in the case of the World Cup or World Championships. During this initial contact they must verify the information that was on the UCI website. If there is a discrepancy then the PCP must inform the organiser, and contact the UCI.



TIP

Prior to contacting the organiser, an additional good strategy is to check the competition website, either for the current or past editions of the competition. For the World Cup and World Championships, the Track Events section of the UCI website provides a link to the competition website as well as any relevant details such as the programme, etc.

For other competitions, check the Calendar section for that competition's information. There will often be a link to its current website.



TIP

At the same time as checking the UCI website for the competition information, the PCP should also log in to DataRide and check that the competition appears in the Competitions section of their Results tab, and that the events that make up the competition are listed correctly. If there is any discrepancy, the PCP must contact the UCI.



TIP

The UCI assigned Commissaires are indicated for each of the competitions on the Calendar page of the Track section of the UCI website.

CALENDAR 2019

Time line view [List view](#)

Filter By Name: Venue: Country: Category: [Export more data](#)

Race Type: Class: Calendar:

2018-12-28 2019-05-03

10 Results

| Date | Competition | Country | Venue | Class |
|--------------------|---|---------|-----------------------|-------|
| 24 Jan-29 Jan 2019 | 108 Berliner 6 Tage-Rennen 2019 | GER | Berlin | CL1 |
| 01 Feb-03 Feb 2019 | International Belgian Trackmeeting | BEL | OENT | CL1 |
| 02 Feb-03 Feb 2019 | Campeonato Nacional de Pista | POR | Singaïhos-Anadia | CN |
| 02 Jan-05 Feb 2019 | Campeonato Nacional de Omnium | POR | Singaïhos-Anadia | CN |
| 31 Jan-05 Feb 2019 | Bilka 6 days Copenhagen | DEN | Ballerup / Copenhagen | CL2 |
| 07 Feb-09 Feb 2019 | Six Day Melbourne | AUS | Melbourne | CL1 |
| 07 Feb-10 Feb 2019 | Elite & U19 National Track Championships | NZL | Cambridge | CN |
| 14 Feb 2019 | Schweizermeisterschaften Omnium | SUI | Grächen | CN |
| 14 Feb-16 Feb 2019 | Ausside Bank Bundeberg Cycle Fest International | AUS | Bundeberg | CL2 |

This initial contact allows the PCP to start building a constructive relationship with the organiser. A good relationship ensures that the organiser will help resolve any difficulties or shortcomings. On occasion, the PCP will need to be firm in negotiations with the organiser, but by explaining the reason for the need, as well as the importance of the competition at this level, the organiser will often see the PCP's point of view.

NOTE

It is always better to work with an organiser to gain the result that is needed, rather than to impose demands.

As noted in [chapter 5.1.1.1](#), the PCP is the leader of the Commissaires' Panel and so plays an important role in ensuring that the team works optimally and that everyone is ready for the competition.

In advance of the competition, the PCP makes sure that all Commissaires will be on site at least one hour prior to the start of the session. In the case of licence checks, the PCP makes sure that there will be sufficient resources to assist with this duty. The PCP may need to contact the organisation to ask that they request some of the nationally-assigned Commissaires to arrive in time to assist with licence checks. The PCP should never assume there will be sufficient resources.

Once the Commissaires are on site an hour before the start of racing, usually in the Commissaires' Meeting Room, the PCP conducts a short briefing related to the events that are part of that session, reviewing the rules and special requirements in order to ensure everyone understand what is expected of them. The PCP then ensures that all the Commissaires are at their positions prior to the session start.

The track is closed ten minutes before the start of the session and riders must stop warming up. One of the Commissaires indicates this by showing a red flag to riders still on the track, as well as informing any managers on the Safety Zone. The Speaker can also be asked to make an announcement to this effect.

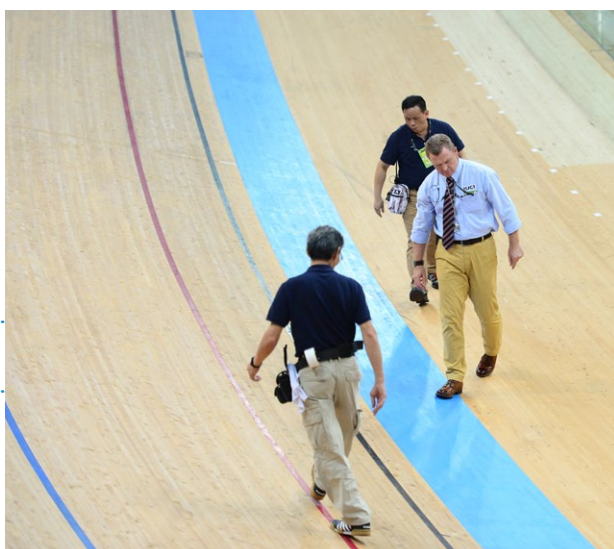

Once the riders have left the track, the PCP should walk a lap of the track to conduct a general review of the track surface to see if there is any need for repairs. The PCP pays particular attention to the area between the Stayer's Line and the Blue Band, as well as to any areas where there have been crashes during the competition.

NOTE

This review of the track surface does not determine whether it is safe to use the track.

TIP

It is a good idea for the Track Director (also known as Head of Track), as well as the TD, to walk the lap of the track with the PCP in case a need for any repairs to the track surface is identified. The Track Director should be informed of this requirement before the start of the competition.

At the same time, the PCP also checks that all installations are in place for that session, for example foam pads, lap boards, bells, etc.

At this point the Timing Company and Starter can make a final check of the electronic timekeeping, photo-finish equipment, countdown apparatus and starting gates.

Once the PCP has finished the walk around the track, he or she checks with the Starter and the Timing Company that everything is ready for the start of the session. The PCP then indicates to the Speaker that the session is ready to begin.

The Speaker then calls the riders to the line with enough time to ensure that the session starts on schedule.

5.1.2 SECRETARY



The Secretary is always a very experienced Commissaire and is a member of the Commissaires' Panel. The proper conduct of the competition depends on the Secretary's work.

5.1.2.1. Role

The Secretary's main responsibilities are:

- to ensure that all necessary documents and communiqués are produced,
- that the information in the documents and communiqués is accurate and complete,
- that the documents and communiqués produced reach those who need the information.

This job is critical as the information generated allows for the smooth running of the programme.

Many people rely on the information that the Secretary provides. These include:

- all Commissaires,
- Speaker,
- Teams,
- Media,
- Timing Company,
- UCI Technical Staff,
- Organisation functions, such as protocol ceremony staff.

NOTE

Once the competition is over, all this information becomes the historical record of the events and is used for rankings and at future competitions for seeding riders.

Doing this job well requires a special set of skills. Excellent organisational skills are essential to maintain proper control of all the documents and to instigate a paper trail to be able to quickly go back and recover data.



TIP

The Secretary should find a filing system that works best for him or her. Each person may have a different way of working.

The Secretary should also have PCP experience as not all the communiqués come from the Timing Company.

While it is possible for the Secretary to request administrative support from the organisation, this is not an optimal solution and can lead to delays and miscommunication. It also restricts the ability of the Secretary to properly prepare at home. It is highly recommended that the Secretary knows how to use a word processor and spreadsheet software. This facilitates quick, accurate work.

The Secretary's focus should be on producing accurate, timely start lists, results and other event information.

NOTE

It is essential for the Secretary to focus on his or her job and not be distracted by other peoples' work. Inevitably this means that the Secretary will not get to see a lot of the racing.

5.1.2.2. Preparation for the Competition

The work of the Secretary starts before arriving at the competition.



TIP

Make a checklist of all the materials that will be needed to perform the role so that you do not leave anything at home. This includes:

- the Regulations,
- Ethernet cable,
- file folders,
- sheet protectors,
- electrical plug adapter,
- pens and pencils,
- highlighter pens,
- marker pens,
- stapler,
- staple remover,
- glue,
- tape,
- type correction fluid,
- scissors,
- notebook.

The Secretary should check that he or she is in possession of the current regulations upon receiving the assignment. A further check should be made shortly before leaving for the competition.

The Secretary also needs up-to-date rankings and recent results, especially for competitions such as World Cups. These can be found on the UCI website. This information is required for the correct seeding of the riders in the various events.



TIP

Download the latest rankings from the UCI website into a spreadsheet such as Excel. These rankings are updated every Tuesday. This makes preparing the seedings much easier.

PRACTICAL INFORMATION

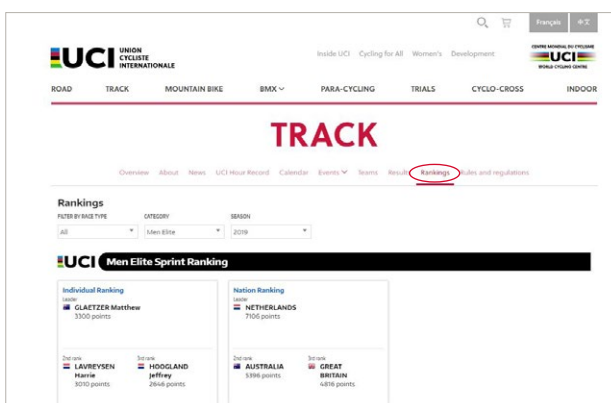

Download the latest rankings as follows:

On the UCI website select <TRACK>. Then select <Rankings>. From the drop-down boxes at the top of the page select the category and the race type for which the ranking is needed, so for example for the Men Elite UCI Sprint Ranking select <Men Elite> and <Sprint>. The page is automatically updated, then click on <Individual Ranking>. The ranking appears showing 40 riders per page.

To export the ranking:

Click on <Export Rankings> at the top of the page. In the box that opens, select <Excel file> and select the <Save> option and save it to the desired location. Go to the file in that location and click on it to open.

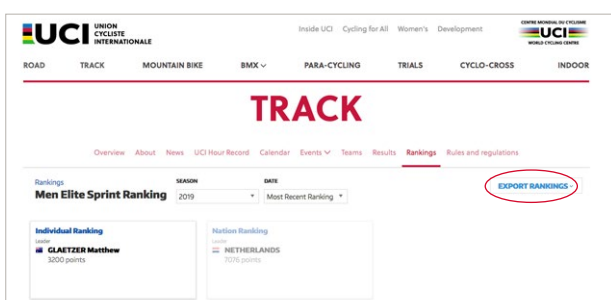

This process is carried out for each of the events of the competition.

| STARTERS | SYSTEM | EVENT | COMPOSITION | SEN | OTHERS |
|----------|----------------|-------|-----------------|-----------------|--------------------------------------|
| 28 | 24 best riders | 1 | N1 N2 N3 N4 | 1A 1B 1C | |
| | skip | 2 | N5 N6 N7 N8 | 2A 2B 2C | |
| | | 3 | N9 N10 N11 N12 | 3A 3B 3C | |
| | | 4 | N13 N14 N15 N16 | 4A 4B 4C | |
| 12 | 1/16 Finals | 5 | N17 N18 N19 N20 | 5A 5B 5C | |
| 13 | 12 x 2 | 6 | N21 N22 N23 N24 | 6A 6B 6C | |
| 14 | 1-1/2 | 7 | N25 N26 N27 N28 | 7A 7B 7C | Ranked 17 to 28 according to 200m TT |
| 15 | | 8 | N29 N30 N31 N32 | 8A 8B 8C | 235 REL. |
| 16 | | 9 | N33 N34 N35 N36 | 9A 9B 9C | Qualifying |
| 17 | | 10 | N37 N38 N39 N40 | 10A 10B 10C | |
| 18 | | 11 | N41 N42 N43 N44 | 11A 11B 11C | |
| 19 | | 12 | N45 N46 N47 N48 | 12A 12B 12C | |
| 20 | | 13 | N49 N50 N51 N52 | 13A 13B 13C | |
| 21 | | 14 | N53 N54 N55 N56 | 14A 14B 14C | |
| 22 | | 15 | N57 N58 N59 N60 | 15A 15B 15C | |
| 23 | | 16 | N61 N62 N63 N64 | 16A 16B 16C | |
| 24 | 1/8 Finals | 17 | 1A 1B 1C 1D | 1E 1F 1G 1H | Ranked 9 to 16 according to 200m TT |
| 25 | 1/4 Finals | 18 | 2A 2B 2C 2D | 2E 2F 2G 2H | 222 REL. |
| 26 | 1/2 Finals | 19 | 3A 3B 3C 3D | 3E 3F 3G 3H | |
| 27 | | 20 | 4A 4B 4C 4D | 4E 4F 4G 4H | |
| 28 | | 21 | 5A 5B 5C 5D | 5E 5F 5G 5H | |
| 29 | | 22 | 6A 6B 6C 6D | 6E 6F 6G 6H | |
| 30 | | 23 | 7A 7B 7C 7D | 7E 7F 7G 7H | |
| 31 | | 24 | 8A 8B 8C 8D | 8E 8F 8G 8H | |
| 32 | | 25 | 9A 9B 9C 9D | 9E 9F 9G 9H | |
| 33 | | 26 | 10A 10B 10C 10D | 10E 10F 10G 10H | |
| 34 | | 27 | 11A 11B 11C 11D | 11E 11F 11G 11H | |

It is good practice for the Secretary to prepare the tables of competition for all events. This makes it easy to verify the work of the Timing Company when checking who goes through to which round of the competition, who competes against who in each heat, as well as the results. Most of these tables can be prepared in a spreadsheet programme such as Excel, which can be set up to automatically populate the riders into different heats based on the results of the previous heat.

While it is easier to use a computer programme, this is not obligatory. If the Secretary wants to work on paper, that is also possible, but sufficient tables must be available for all the various events.



TIP

The more preparation work at home, the easier the job will be. This also makes the work more efficient.

An up-to-date copy of the Records and World Champions is also required. These are found on the UCI website.



TIP

To find the current world records, select <TRACK> then <About>. Scroll down towards the bottom of the page and click on the relevant links under Historical of the World Records. The current world records are highlighted in bold text. They can be downloaded as a PDF Document.



TIP

Take care. Records that have been newly established may not yet be recorded on the UCI website. Wikipedia can sometimes be a good secondary source of information. Remember though that Wikipedia is not a source of official documentation.

For World Cups and World Championships, it is necessary to check which riders have qualified and are eligible for the various events.

The Secretary must then download the last updated Penalties list from the Commissaires intranet (see Appendix for sample). This needs to be copied and distributed to all the Commissaires and the Speaker.

5.1.2.3. Work on Arrival

On arriving at the venue, the Secretary must meet the organiser to go over the things needed to facilitate the Secretary's work. A follow up on the availability of each of these items must be conducted before the start of the competition. Among the critical things to check are:



- Printer: the Secretary needs access to a printer and paper almost immediately. A check must be made that it is possible to print. It may be necessary to have someone install printer drivers on the computer.
- Secretarial support: it is a good idea to have the organiser provide a spare computer, as well as a volunteer who can assist the Secretary with any secretarial work on the computer.
- Volunteers: a sufficient number of volunteers need to be provided by the organisation to support the work of the Secretary. These volunteers carry out tasks such as photocopying, distributing communiqués, managing paper supplies, etc. The Secretary must schedule and run a meeting with these volunteers so that they understand their roles, specific tasks and workflows.

- Pigeonholes: the organiser must provide pigeonholes near the Secretariat to assist with the distribution of communiqués. There needs to be a pigeonhole for every Commissaire, and these must be labeled with their names. There is also usually pigeonholes for the various UCI departments who will be present at the competition. In addition, the information needs to be distributed to the teams. It is becoming more common these days to have pigeon holes for the various events rather than for the teams. The communiqués are then also posted on a noticeboard near the Secretariat. This needs to be verified with the organisation.
- Working area in Secretariat: the provision of space for Commissaires, especially the Secretary, in the Secretariat is often overlooked. The Secretary must check that Commissaires have enough space to do their work properly, and if there is not enough space, ensure that it is provided. This space must be near the Timing Company, as well as near to where the Judge and PCP work in order to facilitate their duties.

**TIP**

The Secretary's job can be made much easier by bringing his or her own computer to the competition.

The organiser ([see 3.3.2.5](#)) should provide a plan of the infield showing the location of all the Team Boxes. If this is not done the Secretary must draw up a plan and ensure it is distributed to all the Commissaires.

Since the work of the Timing Company can easily impact the smooth running of the competition, the Secretary must meet with the Timing Company staff to determine their capabilities. As good cooperation between the Timing Company and the Secretary is required, it is important for the Secretary to build a good relationship and explain his or her needs and workflows. These discussions should include how information will be passed between the different groups, for example, Timing Company, PCP, and Secretary, as well as what information will be provided, for example, results and decisions.

**TIP**

Advance information on which Timing Company has been appointed will help with preparation.

5.1.2.4. Work during Registration

For World Cups and World Championships, the UCI has drawn up an initial set of communiqués that are distributed prior to the start of the first event. These include the initial Anti-Doping Control communiqué. The Secretary should endeavour to obtain these communiqués from the UCI before arriving at the competition. Once received the communiqués must be reviewed with the PCP before being finalised. In the case of the Anti-Doping Control communiqué, this must be verified with the DCO before being distributed.

During Registration, members of the Commissaires' Panel check licences and entry information. Once confirmed, this information is then passed on to the Secretary so it can be documented and updated in the entry system. The Secretary must make sure that the members of the Panel verify the following information:

- spelling of name,
- UCI ID,
- riders to start in the first round of the Team Sprint and Team Pursuit, if applicable, and information on any potential substitutions.

NOTE

At World Cups and World Championships, the eligibility of riders to compete also needs to be verified.

NOTE

The Secretary must keep all the original entry forms that are approved at Registration and give these to the PCP at the end of the competition. Keeping the originals makes it possible to check what was approved in case of a dispute.

Once registration closes, the Secretary must check the number of riders entered for each event and identify any races that will require qualifying rounds (for example, the Points Race) as well as the number of heats required in the various competitions (for example, the Keirin). Depending on this information, the schedule may need to be updated. If there is a UCI Coordinator or TD at the competition, this information must be passed on to them so that they can update the schedule for the first day. If neither is present, the Secretary must update the schedule after discussion with the PCP and organiser.

NOTE

Only the following day's schedule is updated during multi-day competitions as things may happen subsequently that affect the schedule of the remaining days. The following day's schedule must always be published before the start of the last session of the day, unless there is another requirement.

The Secretary then prepares all the start lists for the first session.

A list of nations/teams entered is prepared for the PCP to use during the roll call at the Team Managers' meeting. The Secretary must attend this meeting and take notes in case an additional communiqué is needed.

The initial communiqués are usually distributed to the teams at the end of the Team Managers' meeting. These communiqués include:

- list of nations/teams entered,
- list of riders entered,
- initial information communiqués,
- initial technical communiqués,
- anti-doping communiqué,
- session 1 start lists,
- day 1 programme.

The Secretary must ensure these communiqués are ready to be distributed at this time. Race numbers and transponders are often distributed at the same time.



TIP

The Secretary should call upon colleagues to assist with the distribution process to make it efficient.

5.1.2.5. Communiqués

The administrative management of the sporting component of a track competition is achieved using communiqués. These documents provide the information needed to stage the competition.

Communiqués include:

- Information,
- Anti-Doping,
- Schedule,
- Composition of Heats,
- Entry Lists,
- Start Lists,
- Results,
- Event Analysis,
- Decisions.

The Secretary is solely responsible for ensuring that the information in communiqués is correct and that only approved communiqués are distributed.

Whenever a communiqué is produced, the Secretary must receive it and review it for accuracy. If it is correct, the Secretary then signs the bottom right corner of the document and files the original in a protective pocket in a binder that is kept safe. A copy is then sent to the copy centre for reproduction while a second copy is kept by the Secretary. In this way, if something happens to the first copy, the second copy can be sent as a replacement without the need to send the original.

NOTE

Always ensure that only signed communiqués are copied.

One or two volunteers then have the responsibility of ensuring that the communiqués are distributed to the Commissaires.



TIP

Check with the Commissaires which communiqués they want hand delivered to them. In most cases Commissaires will only need Start sheets. Other communiqués are then available in the event specific pigeon holes. Do not forget that there needs to be a plan to deliver communiqués to the Judge-Referee and the Speaker who are outside the track.

NOTE

Although there is a move away from paper-based systems to electronic systems, an original signed paper document should still be created. The Secretary must also ensure that whatever electronic system is used to distribute information, approval from the Secretary must still be required before transmission.

5.1.2.6. Work during the Competition

The Secretary must have a good system for working during the competition.

Some things that should be monitored are:

- that the communiqué distribution system is working,
- that the deadlines for changes to teams are flagged (for example, the deadline for the Team Pursuit, 30 minutes before the start),
- that the collaboration and communication with the Timing Company is working,
- that start sheets for the next session are produced once changes can no longer be made.

NOTE

Generally speaking, changes can be made up until the start of the first event of each day for any event, provided the riders being substituted in have been entered for that event.



TIP

Adjust the time setting of the computer being used to create the communiqués to local time.



TIP

Use a notebook to record all information received, and mark it off once it has been addressed. Information can include:

- changes,
- infringements,
- records,
- notes for the next day,
- etc.

The Secretary also keeps all the spare numbers, as well as any special numbers, for example, for the Madison. These would normally only be distributed at the start of the session when that event is being held.



TIP

Bring red and black marker pens to make up any replacement numbers if needed.

COMMUNIQUÉS

| Time | Event | Start List | Result |
|-------------|--------------------------------------|------------|--------------|
| 16:00-16:14 | Women's Team Sprint Qualifying | Start List | Result |
| 16:14-16:50 | Men's Sprint Qualifying | Start List | Result |
| 16:52-17:17 | Men's Team Pursuit First Round | Start List | Result 15h52 |
| 17:17-17:28 | Women's Team Sprint First Round | Start List | Result 16h47 |
| 17:30-17:58 | Men's Sprint 1/16 Finals | Start List | Result |
| 18:00-18:08 | Women's Team Sprint Finals | Start List | Result 17h30 |
| 18:08-18:18 | Men's Sprint 1/16 Final Repechages | Start List | Result |
| 18:20-18:30 | Men's Team Pursuit Finals | Start List | Result 17h50 |
| 18:30-19:00 | Women's Team Sprint Victory Ceremony | Start List | Result |
| 19:00-19:10 | Men's Team Pursuit Victory Ceremony | Start List | Result |

The key to being a successful Secretary is to be efficient and avoid errors. This means it is important to have a process that is clear and easy to understand.

Managing the replacement of riders can be confusing when people are not speaking their native tongue. It is important to be clear about which riders are IN and which are OUT.

The Secretary can use the schedule to track all the start lists and communiqués printed to ensure that no deadlines, events, or communiqués are missed.

Many of the communiqués to be distributed are produced by the Timing Company, which is a service provider, or volunteers. The Commissaires, and specifically the Secretary, are responsible for the information distributed. The Secretary must check all the communiqués being issued. Things to check are:

- title,
- name of race,
- distance,
- relegations,
- changes if any revisions,
- information on warnings.

The Secretary should make sure a communiqué makes sense. Once checked, the Secretary signs the communiqué before distribution.

NOTE

If a communiqué is revised, there must be a clear indication that it has been changed by marking it as REVISED in the heading.

PENALTIES

At the end of each day the Secretary prepares a communiqué listing all the penalties from that day. It is therefore important that the PCP and Judge-Referee provide complete information on all penalties. This includes:

- event,
- rider's number,
- team/nation,
- penalty reference,
- fine if appropriate (with reference to Part 12).

This is recorded in the notebook before the communiqué is created.

To complete the penalty process, the Secretary fills out the UCI Infringement Forms and sends these to the PCP at the end of the competition.

NOTE

When filling in the UCI Infringement form, the Secretary must record the detail of the infringement, and not any other form of abbreviation. It is not acceptable to use the code abbreviations from the Penalty Sheet.

BUNCH RACES

During all bunch races the Secretary must track and score the events. This means recording:

- laps gained and lost,
- points scored,
- places in intermediate sprints,
- places in the final sprint.

The PCP and Finish Judge need to provide the Secretary with the relevant information. The Secretary must ensure that they understand this. The Secretary must also stay alert to any potential changes to the information being provided, for example, a change in the order in a sprint or a rider being declared not to have gained a lap. The Secretary continuously monitors the scoreboard and confirms that the information on it is accurate. If any discrepancies are noted, the Secretary immediately consults the Timing Company to resolve the differences. Once the event is over, the Secretary then verifies that the result is accurate. This means that all places, and if applicable, points totals, are correct.

NOTE

During bunch races the accuracy of the scoreboard is critical for the teams' racing strategies.

RECORDS

In the case of a World Record being set, the Secretary must complete all the necessary record forms and ensure that they are signed by the relevant people. The form can be found in the Regulations. The Secretary also needs to collect the original timing tape and manual timing sheets. The completed dossier for each World Record is then given to the PCP at the end of the competition. The PCP must submit this to the UCI within one month. After his time the record will not be considered.

NOTE

In the case of national records being set, teams may sometimes request certain documentation from the Secretary. The Secretary should endeavour to accommodate these requests.

MEDICAL

In the case of a rider not starting due to a medical reason, the Secretary should collect the medical report from the official race doctor confirming that the rider cannot start the event.

PODIUM

In the case of a final, the Secretary must also quickly confirm the podium places so that the protocol ceremony can be staged promptly.

5.1.2.7. Work at the end of the Session/Competition

The Secretary must not leave the velodrome until all the work of the Commissaires has been completed and all communiqués have been signed, sent for copying and distributed to the necessary people.

If the Secretary has created any of his or her own communiqués, these should be sent to the Timing Company in PDF format at the end of each day.

At the end of the competition the Secretary needs to finalise all the paperwork. In the case of World Cups and World Championships, a representative from the UCI Track Department is normally present. The Secretary provides this representative with all the original communiqués, registration entries and records for ratification. If no-one from the UCI is present, then these documents must be given to the PCP.

Furthermore, the Secretary must provide the PCP with an additional complete set of communiqués upon the latter's request. The Secretary should also provide the PCP with all medical reports and UCI Infringement Forms.



TIP

On arriving at the competition, the Secretary must check what information the PCP will require from him or her at the end of the competition.

5.1.3.

JUDGE-REFEREE

The regulations require that a Judge-Referee be appointed when the following events are part of a competition:

- Sprint,
- Keirin,
- Omnium,
- Points Race,
- Madison.



The role is well defined for these events (**ARTICLE 3.2.011**).

The UCI appoints a Judge-Referee for World Cups and World Championships. For other competitions, the PCP must appoint one of the Commissaires to this role if one or more of the above events are taking place. The PCP is not permitted to perform this role.

NOTE

For events in which the Judge-Referee is not required, the Judge-Referee may be asked to assist in another role. The PCP should always take into account the programme when planning this so that the Judge-Referee can be back in position when required without delaying the programme.

5.1.3.1. Location



The Judge-Referee takes up a position on the outside of the track, in corner 1, looking down the home straight across the Finish Line. The Judge-Referee should be looking directly down the Sprinter's Lane in the home straight.

The Judge-Referee's position must be set high enough, and far enough back from the track, to afford an unobstructed view of the entire racing surface, and the Sprinter's Lane in particular.

The area reserved for the Judge-Referee needs to be large enough to accommodate three people – the Judge-Referee, camera operator and playback operator – as well as the equipment required for this area. It also needs to be private. The Judge-Referee must check the area when arriving at the velodrome to identify any possible shortcomings. The Judge-Referee must also check that all the required equipment is present and working and meet the personnel who will be assisting him or her.



TIP

The Judge-Referee must check that there is unimpeded access to the position from the infield, including on race days when access control may be more stringent.

5.1.3.2. Role

The very specific role of the Judge-Referee is to monitor the conduct of the riders and their adherence to the racing regulations in the following events:

- Sprint,
- Keirin,
- Points Race,
- Madison.

The Judge-Referee is solely responsible for making decisions in these matters.

The PCP may also request that the Judge-Referee performs a similar role in other bunch races.



Since this role requires decisions to be made immediately, the Judge-Referee must be a very experienced Commissaire. A very good understanding of the regulations and what they mean is required. The Judge-Referee needs to be fully aware of the consequences of the decisions made. The Judge-Referee must be prepared and able to explain a decision to a rider or manager.

NOTE

Although a Judge-Referee is not required to explain decisions to a rider or manager, it is good practice to do so. It is important that the Judge-Referee does not allow every decision to be questioned and does not let this interfere with the current work or flow of the programme.

The Judge-Referee needs to carefully observe a race to be able to make decisions. This requires both a wide view and narrow focus so that what is specifically happening at a certain point can be seen while an understanding of the overall race flow and situation is maintained. The Judge-Referee does this in three key ways:

- Firstly, by visually observing the race,
- Secondly, by using the video review system,
- Thirdly, by consulting other Commissaires, including the PCP and trackside Commissaires.

NOTE

Be aware that watching an incident in slow motion is not the same as watching it at normal speed. Slow motion is a useful tool, but don't forget that the incident happened at normal speed.

If the Judge-Referee decides that a regulation has been broken, he or she then needs to decide if a penalty will be applied. Even if a rider has broken a regulation, this does not mean that a penalty is necessarily imposed. The Judge-Referee must take into account the rider's intent and the impact of the action. Based on this information the Judge-Referee can then decide to:

- do nothing,
- issue a warning,
- issue a relegation,
- issue a disqualification.

NOTE

It is important to keep in mind the stage of the event when issuing a warning, as a warning is halfway to a disqualification. If a warning is issued too early for something relatively minor it leaves little room for the rider and Commissaires to take action in the future.



Example

If a rider is issued with a warning in the first event of the Omnium, this warning carries through to all the other Omnium events making it very difficult for the rider and Commissaires to respond to what happens in the race.

Any decision taken must be objective and unemotional and communicated in that way. The Judge-Referee informs the PCP of his or her decision. The Judge-Referee may be asked to explain the decision and this must always be done in a calm way. The PCP then communicates the decision to the relevant stakeholders:

- Secretary,
- Speaker,
- Team.

Often these decisions must be issued in a very noisy environment over radios. The Judge-Referee must bear this in mind when communicating. It is important to be calm and concise. It is also essential to use the Track Penalty Sheet (see appendix) for clear information to be relayed to the PCP, Secretary, Speaker and teams.

NOTE

Not all penalties are listed on the Track Penalty Sheet. It is possible to use a penalty that is not listed on this sheet. In this case the penalty must be clearly and concisely described.

**TIP**

In the case where a rider has committed an infringement that does not warrant a specific course of action, the Judge-Referee or PCP can speak informally to that rider or team to let them know that their actions could lead to a negative decision in the future.

5.1.3.3. Collaboration with Commissaires

The Judge-Referee should collaborate with the PCP when making decisions. Even though it is the responsibility of the Judge-Referee to make certain decisions, he or she should make a point of asking the PCP's opinion, and be prepared to review situations if the PCP so requests.

The Judge-Referee can also ask other Commissaires for their opinion of what happened in a specific situation.

**TIP**

The Judge-Referee should let the corner Commissaires and Commissaires working on the straights know what his or her preferred working method is:

- Commissaires should contact the Judge-Referee if they see something, or,
- only communicate if requested to do so by the Judge-Referee.

The Judge-Referee and Starter also need good collaboration. In the Sprint event, the Starter has control until the sprint starts; in the Keirin the Starter has control until the derny leaves the track. If the Judge-Referee sees something before either of these has occurred, the Starter can be informed who can then decide whether to stop the race.

5.1.3.4. Monitoring Bunch Races

The position from which the Judge-Referee officiates means that he or she is often the only Commissaire who has a good overview of the track. This means that the Judge-Referee can easily score a race.

NOTE

Scoring a race means taking note of:

- laps lost,
- laps gained,
- riders off the front,
- riders off the back,
- head of the race,
- points scored.

The Judge-Referee should always be prepared to perform this task. However, this is not the primary role of the Judge-Referee and so the PCP must not be dependent on the Judge-Referee for this information. For example, if the Judge-Referee has to review a sprint, he or she may have to stop observing the race. The PCP can always consult the Judge-Referee for information.

5.1.3.5. Working Method

The Judge-Referee needs to have a good working relationship with the video operator. This is why it is important for the Judge-Referee to meet the operator in advance and to explain the preferred working method. It also allows the Judge-Referee to understand the capabilities of the equipment, for example, if the video can be marked for playback, if the video can be played back while still recording, etc.

When an incident does occur, the Judge-Referee informs the operator as it happens, who must either note the video time or place a marker in the footage. The Judge-Referee should also keep a note of where the incident occurred, for example, "corner 2 after 2 to go". These methods make it possible to quickly go back, find and review an incident.

The schedule must never be held up to wait for a decision, which is why it is important for decisions to be made quickly.

NOTE

The Judge-Referee may be required to review an incident while also watching the next race.

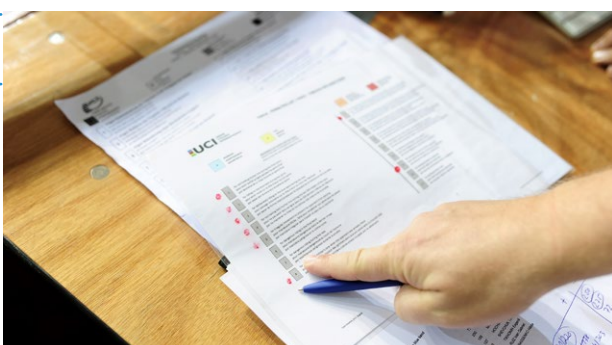

TIP

The Judge-Referee should keep notes on each event. Writing down thoughts and decisions as they happen can be useful when it becomes necessary to explain a decision.

5.1.4. STARTER

The role of Starter is one of the most demanding at a competition. The Starter has tasks in every race and has a very high-profile position. The Starter therefore needs to be 100% confident about his or her knowledge of the regulations for all the events of the competition and must be ready to make a decision without delay.



TIP

The Starter should make and keep a summary of the relevant regulations for quick reference (see example in Appendix).

The Starter must keep up to date with all the regulations.

5.1.4.1. Preparation



Upon arriving at the velodrome, the Starter inspects the positioning of the Starter's Podium. This will normally have been done by the TD in advance, but it is still important to conduct this review, as once the competition starts it will probably not be possible to change the podium position. The two most important things to check are:

- that the podium lines up with the Pursuit Lines;
- that nothing on the infield blocks the view of the Pursuit Lines.



The Starter must then check that the Starting Gate Mechanism is on the podium and that he or she knows how to operate it. This includes:

- stopping,
- starting,
- restarting,
- resetting.

This should be discussed with the Timing Company. The Starter should also be aware of who from the Timing Company is responsible for the equipment in case of a problem.

The Starter must check that there is a starter pistol and sufficient ammunition. It should never be assumed that these items will be provided on the day and the Starter should insist on seeing them upon arrival. Ideally there should also be a second starter pistol. The Starter must check how these pistols work and ensure that they are functional. The Starter must know who will be responsible for supplying the guns and ammunition and bringing them to the velodrome each day.

NOTE

If there is a limited amount of ammunition, the Starter must prioritise when the starter pistol will be fired. For example, it is not critical if the gun is not fired to end a Pursuit event.



TIP

The Starter should bring a good set of ear plugs for when firing the starter pistol.

The Starter must always ensure that the starter pistol is loaded with enough ammunition to start and stop a race. The Starter must also bring a whistle that can be used to start races, as well as to help draw attention to something.

In terms of communiques, the Starter only needs Start Lists. The Starter must find out how these will be delivered. They are normally delivered by a volunteer.



TIP

Ensure that the Start List is also placed in the pigeonholes so that if a Start List is missing it is easy to find a replacement copy.

5.1.4.2. Role

The role of the Starter is defined in various places in the Regulations. The Starter has some very specific tasks.

The Starter is solely responsible for signalling the start of all races. In some cases, such as Time Trials and Pursuits when there are riders on opposite sides of the track, the Starter is helped in the task by an Assistant Starter (see also [chapter 5.1.4.3](#)).

While the regulations define where a rider must take up a position for the start, the Starter makes the final decision on the specific location.



Example

In the final of the Pursuit, the rider with the best time starts on the straight that allows him or her to finish on the home straight. This must be respected by the Starter. However, the Starter can demand that the wheel of the rider be moved forward or back from the line until the rider is in the appropriate starting position.

As part of signalling the start, the Starter also makes a final quick visual check of the technical equipment being used by the rider and the placement of body numbers. If something is not correct, the Starter can request that the PCP applies a penalty or refuses the rider a start.

In all cases when the start is given with a pistol shot, it is with a single pistol shot.

The Starter can also make decisions when to stop a race. There are six main reasons for this:

- in the case of a false start,
- in the case of a mishap,
- in some competitions, such as the Sprint and Keirin, if there is a technical fault in the initial phases (the Starter can stop the race and request that a rider be eliminated),
- in bunch races if there is a crash involving several riders,
- if the track becomes obstructed or there is an unsafe condition, for example, medical personnel too close to the Blue Band,
- if the PCP requests that the race be stopped.

In all cases, the stoppage is indicated by a double pistol shot.

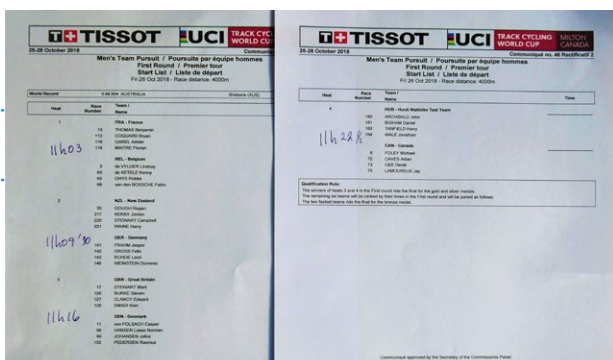

Critically, the Starter also works to keep the competition on schedule by either slowing down or speeding up bringing riders to the line.

TIP

The Starter should keep a very detailed schedule which shows the exact time for the start of each heat. This allows the Starter to assess whether the proceedings are on time. It is very difficult to bring a programme back on schedule if you are a long way ahead or far behind. It is much easier to manage heat by heat.

In some cases the Starter also signals the end of a race. In this case, it is signaled with a single pistol shot.

5.1.4.3. Collaboration with Commissaires

To be successful in the role, the Starter needs to collaborate with other members of the Commissaires' Panel.

In many cases an Assistant Starter is assigned to the competition. The Assistant Starter helps the Starter in a number of ways:



- When there are starts on both sides of the track (for example, Pursuits), the Assistant Starter normally monitors the back straight, while the Starter monitors the home straight. The Starter always bears the overall responsibility and so must make his or her preferred standards clear to the Assistant Starter. Ensure that there is a clear working method for declaring false starts, especially if there is only one starter gun.

If you have two Starter's guns, then one should be given to the Assistant Starter to indicate any issues for the start that he or she is monitoring.

TIP

When there are riders from a nation to which you have an affiliation, you can switch the sides you are monitoring to ensure there is no semblance of favouritism.

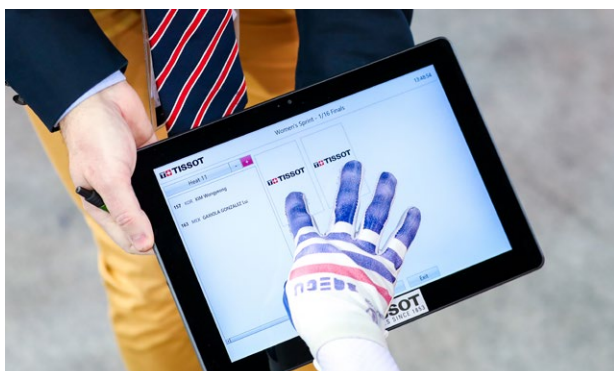

- When there is a draw required for the starting order, for example in the Sprint and Keirin events, the Assistant Starter conducts the draw and notes the order while the Starter manages the earlier heat. The Assistant then informs the Starter of the order. This ensures a smooth flow to the programme.
- When there is a bunch race, the Assistant Starter helps the Starter to verify that all the riders are present and assists in getting the riders into the correct positions when there is a specific starting order.

The Starter's collaboration with the Judge-Referee is discussed in [chapter 5.1.3](#).

When it comes to keeping the programme on schedule, the Starter works closely with the PCP and, if necessary, the TV director.

NOTE

There are limits to how fast or slow a programme can be run. This is still a sporting competition and the impact of delaying or speeding up starts on the riders and teams must be considered. It is the role of the PCP to resolve any issues here with the organiser and TV director.

During Time Trial and Pursuit events where the Starter is stationed in the middle of the track, he or she also has the support of assistants in the form of Flag Commissaires on each straight. The Flag Commissaires indicate if the countdown apparatus can be started or if there is a problem prior to the start. This is further discussed in [chapter 5.1.8.4](#).

NOTE

The Starter must meet the assistants before the start of the competition to discuss arrangements, for example, when the flags should be raised and lowered, how a rider should be positioned, what is considered a false start, etc.

NOTE

It is the exclusive right of the Starter to declare a false start.

5.1.5. FINISH JUDGE

The Finish Judge's role primarily concerns bunch races and non-timed events.

NOTE

For the purposes of the Finish Judge's role, even though the main part of the Sprint competition and Keirin are timed, they are not considered timed events.

5.1.5.1. Role

The core responsibility of the Finish Judge at a track competition is the same as in road cycling. The Finish Judge is the person solely responsible for judging the order of the riders across the Finish Line. This can be at the end of a race or during intermediate sprints.

To perform this role, the Finish Judge may have support from other Commissaires, a technical team such as a Timing Company or volunteers. However, it is the Finish Judge who bears the final responsibility.

When arriving at the velodrome, the Finish Judge checks that there is an appropriate position at the Finish Line with an unobstructed view. Even though the Finish Judge often has the support of the Timing Company, he or she must be able to see the Finish Line clearly. The Finish Judge must also introduce himself or herself to the Timing Company and identify and establish a working relationship with the person with whom checks of the photo-finish will be conducted.

NOTE

The Finish Judge will often work closely with the company providing photo-finish or transponder services but must not abdicate responsibility to this company.

Once the heat or event is over, the Finish Judge is responsible for establishing the ranking. To do this, the first consideration is the order across the Finish Line and then any changes based on decisions communicated by the PCP. Once the ranking has been established, it is sent to the Secretary who then draws up the results communiqué.

During bunch races the Finish Judge must know which of the Commissaires has been tasked by the PCP with indicating the head of the race. This allows the Finish Judge to correctly judge the order across the line. It is not normally the Finish Judge's role to indicate the head of the race. The Finish Judge also collaborates closely with the Secretary during races in which points are scored so that the Secretary can create a manual points table.

The Finish Judge must keep a written record of all the results over the course of the competition so that the information can be verified against the electronic results and any issues can be addressed.



TIP

At major competitions, often after a bunch race, there will be an event that does not require the Finish Judge role. This gives the Finish Judge an opportunity to work with the Secretary to ensure that the results produced by the Timing Company are correct. In many cases the Timing Company will have moved on to manage the next event and so this work by the Finish Judge is very important.

5.1.6. TIMEKEEPERS

Timekeepers perform their roles primarily during the timed events. This includes during the main part of the Sprint competition and the Keirin. While times are also associated with bunch events, this information is not critical.

5.1.6.1. Role

The core role of the Timekeeper is to record the times for all events.

In competitions that have timed events with starts on both sides of the track, there needs to be a minimum of two Timekeepers, one on each side of the track on the Pursuit Lines. Ideally there should be two Timekeepers recording each timing point, so in a Pursuit event with riders starting on both sides of the track this means that there would be four Timekeepers.

NOTE

If there is no electronic timekeeping, and two timekeepers are being used to record a time, the slower of the two times is used, unless a mistake was made in recording that time.

The official race times are recorded by the Timing Company. The role of the Timekeeper is to act as a backup to the Timing Company. This is achieved by:

- keeping good records,
- reviewing manual times against the recorded electronic times,
- informing the PCP of any timing discrepancies,
- signing the manual timing sheets and forms for World Records.

NOTE

In the case where the Timing Company does not record an electronic time for one or more riders or teams, the manual times will be used ONLY for the riders or teams whose times were not recorded electronically.

The Timekeepers must be aware of the times they need to record as laid down by the regulations. This is further explained in chapter 9.

In Pursuit events, the Timekeepers also act as a control for the lap board. Since they are recording the lap times, their documentation will indicate the number of laps remaining. This can then be verified against what is shown on the lap board and any errors quickly corrected.

5.1.7. TECHNICAL/EQUIPMENT

The role of the Technical Commissaire has evolved over the years. For major competitions, a Commissaire who has specialised in this area is appointed by the UCI as the Technical Commissaire. In many cases this Commissaire may only be responsible for checks against technical fraud. The PCP needs to verify this, and if necessary appoint another Commissaire for bike check. In the case where no Technical Commissaire is appointed, the PCP will designate one of the members of the Commissaires' Panel as the Technical Commissaire. Depending on the level of the competition, the PCP may also designate several other Commissaires as assistants to the Technical Commissaire.

5.1.7.1. Role



On arriving at the velodrome, the Technical Commissaire must assess the location for bicycle checks and verify that there is enough space to work. The Technical Commissaire then ascertains if a jig is present and assembles it if necessary. If already assembled, all the jig's measurements need to be verified.

The Technical Commissaire then ensures that all the other equipment and material needed for checking bicycles is present (see [chapter 3.3.2](#)). Due to the large number of bicycles to be checked and the fact that the infield is often very congested, the Technical Commissaire must make sure there is an efficient flow from the Team Boxes, through the bicycle control zone, to the track surface.

The Technical Commissaire meets the assistants, reminds them of the relevant regulations and informs them of the focus of the checks.

NOTE

In the case where there are several Commissaires checking equipment, one of them is designated as the Technical Commissaire and is in charge of the team. If there is a potential problem or dispute, it must be brought to the Technical Commissaire to be resolved. The Technical Commissaire may decide to consult the PCP.

The bicycle check area needs to be fully operational at least one hour before the start of the competition.

The Technical Commissaire, together with the assistants, starts bicycle checks one hour before the start of each session. This offers an early check to those riders wanting to have their equipment verified. It is important that the same Commissaires make the checks during this initial period as during the competition itself to ensure consistency.

During the competition, bicycles need to be checked every time before going onto the track. This means that the same bicycles may be checked many times during the course of the competition. It is important that once a bicycle has been checked for an event, it stays within sight of the Technical Commissaire team until it is taken up onto the track surface.

The Technical Commissaire must employ a system for marking off when riders' bicycles have been checked for an event.

For bunch races, it is also important to check spare bicycles.

If at any time the Technical Commissaire considers that something may be wrong with a bicycle, or another Commissaire indicates something about a bicycle, or that a bicycle may not have been measured, the Technical Commissaire can ask for the bicycle to be brought straight from the track surface to the bicycle check area. In this case, the bicycle must remain in the Technical Commissaire's sight the entire time.

If at any time the Technical Commissaire considers that the equipment being presented is not permitted and the rider is not able to make the equipment compliant, the PCP must be informed, who then has the responsibility of refusing the rider a start. If the non-compliance is discovered after the event, the rider may be disqualified.

5.1.8. ADDITIONAL COMMISSAIRES

In addition to the Commissaire roles described earlier in chapter 5.1., there are many other roles to be performed at a track competition. At large competitions Commissaires may be tasked with a specific role. However, at smaller competitions it may be that a Commissaire is required to fulfil several roles.

NOTE

No role is beneath any Commissaire. All Commissaires must be willing to perform any role and fill any gaps that may arise, no matter what their assigned role is, to ensure the best possible sporting conditions for the competition.

5.1.8.1. Lap Board Operator



The Commissaire assigned as the Lap Board Operator must have a good knowledge of racing, especially bunch racing. It can be a very challenging role. The key responsibility is to indicate the number of laps remaining in an event and to ring the bell to indicate the start of a sprint lap or the start of the final lap. To do this job properly the Lap Board Operator needs to follow the racing closely at all times and be sure of which rider the lap board is being changed for.

When arriving at the velodrome, the Lap Board Operator must make sure that he or she knows how to operate the lap board properly and that a bell is present. In the case where there are finishes at both the Finish Line and Pursuit Lines, the Lap Board Operator must make sure that there are lap boards and bells at both positions. Since this equipment is sometimes provided by the Timing Company, the Lap Board Operator may need to meet them to learn how to use their equipment.

For each event, the Lap Board Operator must be absolutely sure of the distance to be covered, and therefore the number of laps to be displayed. In races where there are sprints within the event, the Lap Board Operator needs to be completely certain when these sprints happen and on what laps to ring the bell. The Timekeeper should monitor the laps as well and can provide verification if needed.



TIP

In races with multiple sprint laps, the Lap Board Operator can write down the laps on which the bell will be rung on a piece of tape and stick this to the back of the lap board. This means that the Lap Board Operator can quickly refer to the relevant information and act appropriately.

In events where there is a start on both sides of the track, Pursuits for example, there are two Lap Board Operators who need to collaborate with each other to ensure accurate information is provided.

In this case, the lap board often initially provides the timed countdown to the start for the rider, and should be facing the rider. Once the start has been signalled, the board then changes to show the number of laps to be ridden. When the opposing rider approaches the Pursuit Line the lap board should be turned to the infield. In this way the rider does not see the board corresponding to their opponent, and the two Commissaires can verify information. The lap board is then briefly turned to the spectator area to show them the information and then turned back to face the track so that the rider approaching the Pursuit Line sees the number of laps remaining to be ridden.

NOTE

Ensure that the lap board on the Finish Line does not display any information when the Pursuit Line is being used as the finish.

During bunch races, it becomes critical to know who is at the head of the race so that the lap board is changed on this rider. This means the Lap Board Operator needs to follow the race closely, as well as pay attention to the Commissaire indicating the head of the race and to information related to when riders lap the field. Other than for when a rider gains a lap, in most cases, the lap board should only be changed when the head of the race exits corner 4.

NOTE

The bell is rung only once, loudly, to the riders who are the head of the race to indicate the start of a sprint lap. The bell must NOT be rung for every group that crosses the line.

NOTE

When a rider laps the field, the lap board must be changed immediately to ensure that the riders are on the correct lap and that any points earned are awarded on the correct lap. This is discussed in more detail in chapter 9.

5.1.8.2. Holders

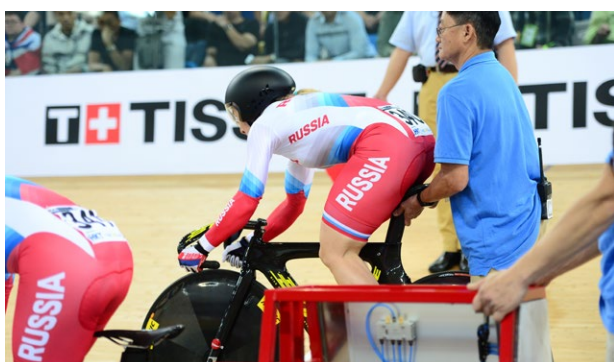

In most competitions where there is a standing start, a starting gate, operated by volunteers, is used. If there are additional riders on the line, for example in the Team Pursuit and Team Sprint, these additional riders must be held by Commissaires assigned for the task. In the case where a starting gate is not used, the rider usually held by the starting gate must instead be held by a Commissaire.

NOTE

Records cannot be set when a starting gate is not used.



As part of the track preparation for the Team Pursuit and Team Sprint events, the Commissaires should prepare the Pursuit Line with small marks set back 11cm from the Pursuit Line, either 1 m or 1.5 m apart, starting from the position of the front wheel of the bicycle to be held in the starting gate. These marks are used to guide the Holders where to position themselves. The base of the wheel is placed onto these marks.

NOTE

Ensure the correct marks are used, depending on whether it is a Team Pursuit (1 m) or Team Sprint (1.5 m).

**TIP**

Use different colour tape for the Team Sprint and the Team Pursuit, for example, white tape for Team Sprint and black tape for Team Pursuit. That way there is no mistake as to which marks must be used when placing the riders on the line.

As soon as the starting gate is brought onto the track, the Holders come out onto the track surface and take up their positions aligned with the various marks on the Pursuit Line. They must be far enough back so that when they are holding the rider, the front wheel is on the relevant marking on the track. If the wheel is closer than the mark to the Pursuit Line, it risks triggering the electronic false start mechanism. All the front wheels must line up and the riders must be the correct distance apart from each other.

The teams are required to bring the riders up to the respective Commissaires and to ensure that the rider is in the correct place. The Holder is not responsible for moving the rider up or down the track. If the Holder is positioned correctly, then the rider is in the correct place.



The Holder must hold the rider steadily. Normally this is done by holding the saddle.

The Holder should provide enough resistance so that the rider does not roll away, but is not expected to hang on if the rider tries to go early. Once the start is signalled, the Holder releases the rider and leaves the track.

The PCP must check with all the holders that they know how to hold, and that they are comfortable with holding.

NOTE

The same teams of holders must be used on both sides of the track for the entire duration of each event, including any heats. This ensures consistency in the holding.

5.1.8.3. Assistant Starter

As noted in chapter 5.1.4., the Starter is helped by a Commissaire assigned as an Assistant Starter. See [chapter 5.1.4.3.](#) for the specific tasks associated with the Assistant Starter.

5.1.8.4. Flag Commissaires

In events where there are riders starting on both sides of the track, for example Pursuits and Time Trials, two Commissaires are assigned as Flag Commissaires to assist the Starter, one on each side of the track on the Pursuit Lines. Each of these Commissaires has a flag. Traditionally the Commissaire on the home straight has a red flag and the Commissaire on the back straight a green flag. However, the actual colours of the flags are not critical nowadays.

NOTE

As a minimum, for Team Pursuit events, each Flag Commissaire must ensure they have a red flag.

In terms of keeping the programme on schedule, the role of the Flag Commissaires is critical, as they work to ensure the rider or team is ready to start on time.

As soon as the previous heat has finished, the Flag Commissaire indicates that the starting gate should be brought onto the track by the volunteers responsible for operating it. The Flag Commissaire takes up a position behind the gate to warn riders warming down of the presence of the gate on the track.

As soon as the starting gate is positioned on the track, the Flag Commissaire must ensure that the bicycle is brought out and promptly loaded into the gate. This process should be monitored, ensuring that there is no delay and that the front wheel of the bicycle is not touching the Pursuit Line.

NOTE

In team events, teams will sometimes delay loading the first bicycle while their team gets ready. This should not be tolerated and is considered to be delaying the start. It is the responsibility of the Flag Commissaire to ensure that this delay does not happen.

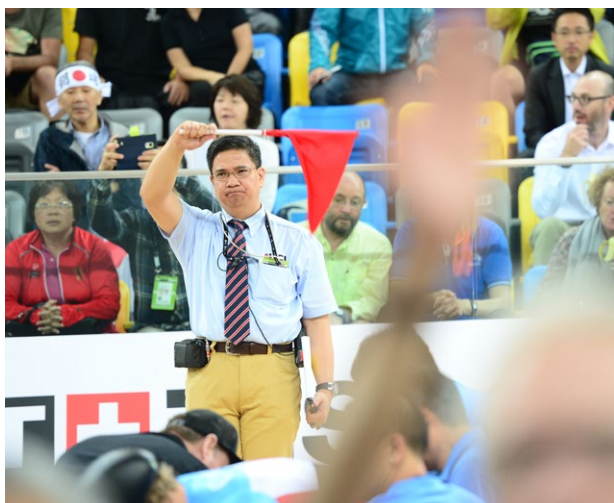

As soon as the bicycle is locked into the starting gate, the Flag Commissaire moves to the outside railing of the track and raises the flag to indicate to the Starter that the side is ready. The Flag Commissaire does not wait for the rider to get on the bicycle or, in the case of a team event, for the other riders to get ready.

In the case of a team event, the Flag Commissaire checks that the team is lined up in a straight line on the Pursuit Line.

As soon as the Starter starts the countdown apparatus, the Flag Commissaire lowers the flag, and watches for any issues on the Pursuit Line.

If something happens that would impact the start, for example, a rider falls over, or there is a problem with the starting gate, the flag is raised to indicate to the Starter to stop the countdown. The Flag Commissaire then works to ensure that the fault is quickly corrected.

NOTE

Unless it is an exceptional case, do not let riders roll away from the start line in the case of an issue developing before the start, as once this happens, it takes considerable time to reset everyone.

The Flag Commissaire does not signal false starts. If the Starter does fire a false start, he or she communicates with the Flag Commissaire, who can then inform the team which rider caused the false start.

For Team Pursuits, after the start is signalled, the Flag Commissaires stay vigilant to monitor one team catching and passing another.

For all other events, the Flag Commissaire is usually given the responsibility of performing sporting control on their straight, if so decided by the PCP.

In this case, they monitor the conduct of the riders in their area. They still need to watch the entire race so that they have context for what happens in their area. If they see something that may affect the race they should inform the Judge-Referee or PCP.

NOTE

The Judge-Referee must provide guidance on how he or she would like to be informed of incidents. The Judge-Referee may ask to be notified over the radio or prefer to only be informed if specifically requesting information.

The Flag Commissaires also monitor the conduct of individuals in the Safety Zone. This includes:

- technical assistants, for example, the starting gate operators,
- coaches and mechanics,
- media representatives.

The Flag Commissaires need to make sure that only authorised personnel are in the Safety Zone and that no-one poses a safety threat.

In the case of any incidents in their area, for example a crash, the Flag Commissaire monitors the conduct of those involved in the incident and ensures the situation is properly controlled according to the regulations.

5.1.8.5. Corner Judges



Corner Judges are Commissaires who are located in the corners of the track. Ideally there should be one in each corner. Sometimes a lack of personnel does not allow this and there may only be a single Corner Judge in corners 1 and 2 and another in corners 3 and 4.

The Corner Judges perform a similar function to the Flag Commissaires as regards sporting control.

Corner Judges monitor the conduct of the riders in their area. They still need to watch the entire race so that they have context for what happens in their area. If they see something that may affect the race they should inform the Judge-Referee or PCP.

NOTE

The Judge-Referee must provide guidance on how he or she would like to be informed of incidents. The Judge-Referee may ask to be notified over the radio or prefer to only be informed if specifically asking for information.

The Corner Judges also monitor the conduct of individuals in the Safety Zone. This includes:

- technical assistants,
- coaches and mechanics,
- media representatives.

The Corner Judges need to make sure only authorised personnel are in the Safety Zone and that no-one poses a safety threat.

In the case of any incidents in their area, for example a crash, the Corner Judge monitors the conduct of those involved in the incident and ensures the situation is properly controlled according to the regulations.

For Pursuit and Time Trial events they monitor the foam pads in their zones, replacing any that get knocked out of place by the riders on the track.

NOTE

It is the responsibility of the organisation to put out and remove the pads for the event. However, it is the Commissaires' responsibility to monitor the pads during racing.

5.1.8.6. Additional Commissaire Roles

Depending on the events in the competition, several other Commissaire roles may be required. These are decided by the PCP.

For bunch races the PCP can assign Commissaires to:

- Monitor laps gained and lost,
- Keep points tables.

NOTE

All Commissaires monitoring a bunch race should score the race (take notes of the race situation). They should record:

- Riders off the front,
- Riders off the back,
- Riders gaining laps,
- Riders losing laps,
- Riders withdrawing.

The notes must be detailed enough so that at the end of the race it is possible to explain what happened throughout the race. Each Commissaire must find a system that works for them.

Commissaires may be assigned to assist with protocol. This means locating riders so that they are ready for the podium ceremony and ensuring that they are appropriately attired.

Commissaires may also be assigned to assist with "whipping", that is ensuring that the riders go to the bicycle check and then to the line on time so that the programme stays on schedule.

5.1.9. DOPING CONTROL OFFICER

Anti-doping controls may be conducted during races by either the Cycling Anti-Doping Foundation (CADF) or the National Anti-Doping Organization. The Doping Control officers fulfill their mission in compliance with their procedures and the WADA code, and WADA International Standard for Testing and Investigations.

The DCO works in collaboration with the doctor appointed to conduct anti-doping controls as well as with the president of the Commissaires' panel (PCP), updating the latter on the operation of the anti-doping controls.

5.1.10. TECHNICAL DELEGATE (TD)

While the TD plays an important role in assisting the Commissaires, the TD is not a Commissaire, and must not be asked to perform Commissaire duties. The TD may not make decisions related to sporting control during the competition.

The primary function of the TD is to represent the UCI and to supervise all the sports-related and technical aspects of major competitions staged by the UCI.

Before the competition, the TD performs a technical survey of the venue to check that the velodrome and technical facilities comply with UCI requirements, particularly with respect to safety rules. The TD then checks the medical service offered by the organisation and ensures that the minimum standards have been met.

The TD has the overall responsibility for supervising the training and warm-up sessions in order to ensure the safety rules are respected.

The TD will mark the different areas on the Safety Zone (as explained in this guide) for the photographers and coaches, as well as for the starting positions for the bikes in the Team Sprint and Team Pursuit events.

He or she will also check the competence of the organisational staff responsible for maintaining the track surface during the competition.

The TD checks the size of the team boxes, as well as their distribution, and then works with the organisation if anything must be changed.

The TD liaises with the PCP before the Team Managers' meeting to decide what will be discussed. The TD then represents the UCI at this meeting.



During the competition, the TD supervises and coordinates technical matters, for example, team boxes, safety, speed of deryn, etc.

During the competition he TD is responsible for coordinating with the organisation any track repairs that become necessary. He or she is also responsible for ensuring that all equipment required for the sporting element of the competition, for example start gates, is available, functioning, and supported by operators who know how to use it.

The TD is always available to the Commissaires and particularly the PCP, for any information, documents or advice which may be needed in respect of the UCI, and may offer advice, if requested, on supervisory issues pertaining to events when these are not fully covered by the regulations.

**REQUIRED KNOWLEDGE**

- The regulatory requirements of each of the Commissaire roles.
- The various roles assigned to members of the Commissaires' Panel at a track competition.
- The general tasks associated with each of the Commissaire roles.
- How the TD can assist the Commissaires.

**WHAT TO DO**

- As PCP, inform the members of the Commissaires' Panel of their roles prior to the competition.
- Find out your role before arriving at the competition.
- Prepare for your role by reviewing the associated regulations.
- Embrace opportunities to work in different roles.
- Be prepared to do any jobs that need to be done.

**WHAT NOT TO DO**

- Refuse to work in certain roles.
- Treat one role as less important than another.
- Perform someone else's tasks without their knowledge or approval.

5.2. COMMISSAIRES' PANEL



All the Commissaires assigned to work at a competition are members of the Commissaires' Panel. The actual number of Commissaires assigned depends on the level of the competition as well as the events being staged.

5.2.1. SIZE OF THE PANEL



The minimum size of the Commissaires' Panel for each type of competition can be found in the table in the UCI Regulations (**ARTICLE 1.2.116**). This table also specifies who is responsible for assigning the different members of the panel and what the qualification of each should be.

The number specified can always be increased to accommodate the type of events being held at the competition.

Depending on the number of Commissaires assigned to the competition, it may be necessary for them to perform several different roles or tasks in different events.

NOTE

Volunteers who are not Commissaires should not be tasked with Commissaire functions.

NOTE

Commissaires who are working at a competition in another capacity, for example, as organisational volunteers, should not be tasked with Commissaire functions.

5.2.2. ASSIGNMENT OF TASKS

The PCP must create a Task Sheet for all the Commissaires assigned to a competition, indicating their role in each of the events.



According to the UCI Regulations (**ARTICLE 1.2.116**), some of the Commissaire roles may be pre-designated by the UCI. In this case the PCP cannot assign another Commissaire to that role. The PCP may however, if possible, ask one of the Commissaires who has been assigned a pre-designated role to perform additional roles. In this case these additional assignments should not impact on their ability to perform their designated role.

On receiving the assignment, the PCP should first check the link to the competition on the Calendar section of the UCI website to see who the other UCI-assigned Commissaires are for the competition, as well as their roles. If this information is not there, then the PCP should contact the UCI for this information. The PCP then contacts the organiser to obtain the names of the Commissaires who will be assigned by the host National Federation. Often the organisation will not be aware of these appointments, but they should be able to provide a contact at the National Federation who will have this information.



TIP

If the PCP knows a Commissaire who is a member of the host National Federation, or if one of the pre-designated roles is to a Commissaire from the host National Federation, this person could be a good contact for researching information about NF-appointed Commissaires.

NOTE

Other than for the UCI-appointed Commissaires in pre-designated roles, the PCP always has the final say on the roles of the Commissaires.

**TIP**

The PCP first creates the Task Sheet showing the events and the roles and then fills in the UCI-assigned Commissaires. Once this stage is completed, the Task Sheet is sent to the person from the host National Federation who is assisting to allow the local Commissaires to be allocated the remaining tasks.



See appendix for a sample of a typical Task Sheet.

Once the Task Sheet has been prepared this should be sent to all the Commissaires, ideally in advance of their arrival at the competition. This will help them with their preparation, as well as ensuring that everyone knows well in advance where they are supposed to be and what they are doing for each event.

**REQUIRED KNOWLEDGE**

- Where to find the table showing the assignment of Commissaires at track competitions.
- The Commissaire roles required for each event.

**WHAT TO DO**

- The PCP works with a locally-assigned Commissaire to allocate the Commissaires appointed by the host National Federation to the various roles.
- The PCP creates a Task List in advance of the competition and circulates it to all Commissaires.
- Review the Task List to prepare for your role.

**WHAT NOT TO DO**

- Wait until the competition to find out what your role will be.

5.3. ORGANISATION FUNCTIONS

The competition organisation is a legal entity, such as a company or association.

5.3.1.

THE ORGANISER

On some occasions, the organising committee comprises several entities. However, from the point of view of the UCI and National Federations, a single organiser is recognised. For this reason, the organiser must be clearly identified in the technical guide, providing the following information:

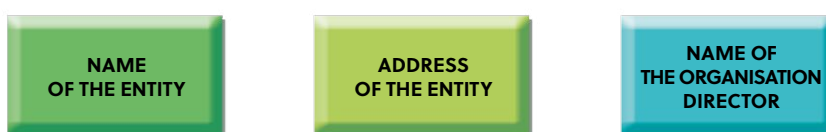

The organiser may register one or more competitions on the UCI calendar.

There are a number of key personnel from the organisation who are required to support the sporting control of the Commissaires.

5.3.2.

THE TRACK DIRECTOR

The Track Director, also sometimes called the Head of Track or Track Manager, is a key organisational person who the PCP must identify and make contact with upon arrival at the velodrome. For some competitions, the Track Director is also the recognised organiser. He is she is the person who knows the venue, as well as the organising committee, and is able to answer any questions, or address any issues, regarding items such as technical equipment, lighting, venue access, rooms, etc.).

The Track Director is responsible for ensuring that the track remains usable throughout the competition. After any incidents on the track, the Track Director works with the track maintenance team to ensure that any necessary repairs are quickly made.

The track maintenance team must be present throughout the competition, including during official training and warmup sessions. The PCP must know where this team is located on the infield and how to contact them.

The Track Director ensures that the medical team is on site and always available during competition, official training and warmup sessions.

Finally, the Track Director ensures that all the equipment required for the various events at the competition is available, positioned in the correct location, suitable for its function and in proper working order.

5.3.3.

THE SPEAKER

The Speaker acts as the announcer for the competition and must be an expert in track cycling.

The Speaker's primary function is to relay sporting control information. This means announcing all the decisions of the Commissaires' Panel as communicated by the PCP. All information is provided in English or French as a minimum.

The PCP must meet the Speaker in advance of the competition to ensure that he or she understands what is required of the function as well as the importance of the role.

To help with the role, the Speaker must have a radio that receives the Commissaires' channel and must have a copy of the Track Penalty Summary Sheet.

It is important to ensure that the Speaker understands how decisions will be communicated to him or her and how these decisions should be announced. It must be made clear that the Speaker must always wait for confirmation from the PCP before announcing any decisions. The Speaker must not offer any opinion on these decisions and they should be announced clearly and calmly.



Example

The PCP may communicate the following information to the Speaker:

- Sprint, heat 1, rider 34, A4.

The Speaker would then announce:

- In the first heat of the Sprint competition, the Commissaires have decided to issue a warning to rider 34, James Smith, for not having held his line during the last 200 m of the race.



TIP

The PCP must listen to ensure that announcements are made after decisions have been communicated to the Speaker. These announcements may have a critical impact on later rounds of the event.

The Speaker, or an assistant, may also sometimes provide race commentary or animate the competition in some way. When doing this, the Speaker should take care not to give away rider strategy - for example announcing that a rider has launched an attack from the back as it happens. This could give the other riders the chance to react as a result of the Speaker's intervention.

NOTE

Communicating race decisions remains the Speaker's primary role and it is important that these are announced in a timely manner.

The Speaker should also observe the following requirements:

- In events where countdown apparatus is used to start the race, the Speaker should not speak during the final 10 seconds of the countdown. This allows the riders who are starting to clearly hear the audible tones of the countdown.
- During the Elimination Race the Speaker should be positioned in the Secretariat near the PCP so that the rider eliminated can be announced as soon as this is decided by the PCP, without any confusion or delay.

5.3.4.

OTHER ORGANISATIONAL ASSISTANTS

There are several other groups, or individuals, from the organisation who assist the sporting requirements of the competition in various ways.

The **Timing Company** is a key organisational function, providing an essential service to the Commissaires. The Timing Company usually provide services such as:

- Electronic timekeeping,
- Photo-finish,
- Electronic starting systems,
- Electronic lap boards,
- Scoreboards.

The Timing Company has a resource role; it is not responsible for making decisions.

Data personnel normally work with the Secretary. They ensure that the Secretary has access to a computer and the facility to print.

Information Distribution personnel also work closely with the Secretary. As noted in chapter 5.1.2., the Secretary meets these individuals upon arrival to ensure a good workflow. The role of the Information Distribution personnel is to:

- ensure there are suitable copying facilities,
- ensure that there is a suitable information distribution system in place (for example, pigeonholes, notice boards, etc.),
- copy all communiqués,
- distribute all communiqués to the stakeholders,
- maintain a backup information system (for example keeping spare communiqués to replace lost copies).

Equipment operators are responsible for installing the technical equipment required at the track. They are often employed by the Timing Company. They may also operate some of the equipment, primarily the starting gates.



The organisation is responsible for ensuring that the starting gate operators have been trained on how to use the equipment before the start of the competition. They are responsible for bringing the starting gate onto the track, locking the bicycle into the gate, arming the gate and removing it from the track once the start has been signalled.

TIP

In some cases, it is good practice to have one of the operators stand or lean on the starting gate to prevent the rider pulling the gate down the track before the start releases the bicycle.

The Derny Driver is a critical person in the Keirin event. A check must be made that they are able to keep their line in the sprinter's lane, accelerate correctly and smoothly, and exit the track in a proper way. If a TD is present they will conduct a test using the driver and derny. If a TD is not present, the PCP must verify the driver's capabilities.

For motor-pacing events, the **Motor-Pacing Drivers** must be assessed by the PCP before the race to ensure they have the technical capabilities.



REQUIRED KNOWLEDGE

- The key organisational functions.
- The role of the Track Director.
- The role of the Speaker.



WHAT TO DO

- Ensure you have identified and met the key organisational people.
- Identify how to contact the Track Director, track maintenance team and Speaker during the competition.
- Ensure the Speaker is aware of his or her primary function and its importance.
- Check that the starting gate operators know how to use the equipment.



WHAT NOT TO DO

- Assume the organiser is also the Track Director.
- Assume the track maintenance team is available at the start of each session.
- Let the Timing Company make decisions.

5.4. INTERACTION BETWEEN THE COMMISSAIRES AND THE ORGANISATION

The interactions between the Commissaires and the organisation are numerous. Thus, the fields of activity and responsibility need to be clear and mutually respected.

The diagram below summarises the situations where interactions between the organisation and Commissaires are most frequent.

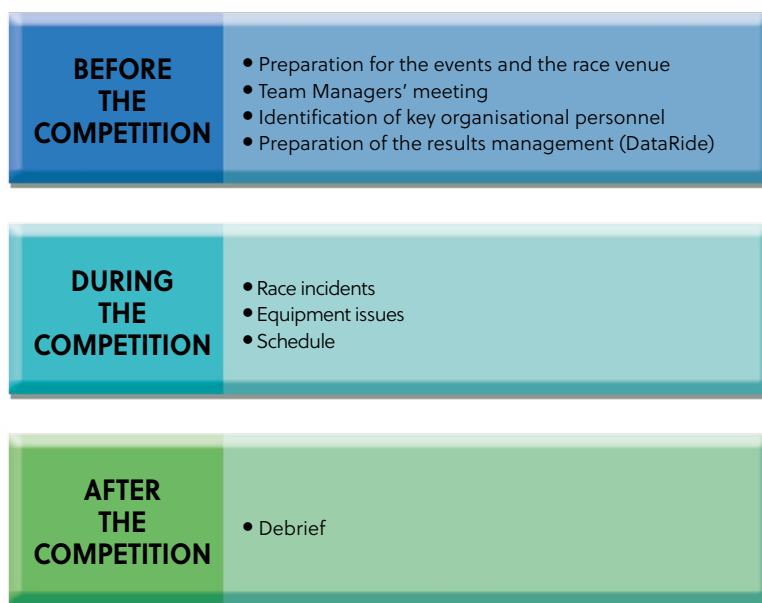

Diagram. Interactions between the organisation and the Commissaires' panel

The organiser is solely responsible for the quality of the functions carried out by the organisation as described in [chapter 5.3](#).

Commissaires will not intervene in the functions carried out by the organiser unless **safety**, the **image of cycling** or the **sporting considerations of the competition** are affected. A Commissaire does not have the authority to demand that certain instructions are observed, but can offer certain advice if remaining **UNASSERTIVE** and acting in a spirit of **PROVIDING INFORMATION**.

Conversely, the organiser may not influence how the competition unfolds.

Race situations are quite normal most of the time, allowing a balance of responsibilities to prevail. This balance may quickly deteriorate, however, if there are race incidents or difficult situations. In this event, Commissaires must quickly allocate responsibilities and ensure that these are observed.

Commissaires are requested by the UCI to evaluate the quality of some of the functions carried out by the organiser by means of an evaluation report. The UCI regularly updates its example reports to make evaluations as objective as possible. While remaining factual and bearing in mind the UCI's standards and regulations, a UCI Commissaire is required to provide an evaluation as the UCI's main reporter.

This evaluation influences the relationship between the UCI-appointed Commissaire and the organiser who sometimes resents the organisation being judged and interprets the assessment as a sanction.

For this reason, during the evaluation, but also throughout the competition, a Commissaire must ensure that his or her interactions have maximum credibility:

- a collaborative attitude must be adopted if the organiser is receptive,
- a more authoritarian attitude should be used if there are significant risks or if progress is slow.

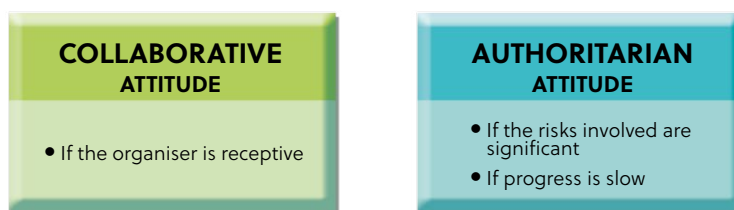

Diagram. Attitudes to be adopted by a Commissaire depending on the situation



TIP

The PCP must carefully evaluate when it is necessary to be more authoritarian. Remember that being authoritarian may affect the level of cooperation, so restrict it to critical or essential issues.



REQUIRED KNOWLEDGE

- How to distinguish which functions are the responsibility of the organisation and which are the responsibility of the Commissaires' Panel.
- How to encourage and maintain the balance of responsibilities, always keeping this issue in mind.



WHAT TO DO

- Prepare for the competition by communicating with the organiser and members of the Commissaires' Panel.
- Prepare the content and guidelines of the pre-race meetings with the organiser.
- Present an objective case regarding requests and the evaluation of the competition.
- Take advantage of all opportunities to enhance credibility.



WHAT NOT TO DO

- Interfere with the organisation.
- Transfer some of the Commissaires' tasks to the organisation or its service providers.
- Blur the lines between the functions of the members of the Commissaires' Panel or seek to exercise the functions of other members.

CHAPTER 6 PREPARATION FOR COMPETITION

UCI 2017 TRACK CYCLING WORLD CHAMPIONSHIPS HONG-KONG CHINA 

PRESENTED BY **TISSOT** 

12-18 April 2017 Communiqué no. 5

Competition Schedule / Programme des compétitions
As of TUE 11 APR 2017

| Date | Session Time | Duration Time | Event |
|------------|---------------|---------------|--|
| WED 12 APR | 15:00 / 16:44 | 48 | Women's Team Pursuit, Qualifying |
| | | 56 | Men's Team Pursuit, Qualifying |
| WED 12 APR | 18:40 / 21:32 | 20 | Opening Ceremony |
| | | 17 | Women's Team Sprint, Qualifying |
| | | 25 | Men's Team Sprint, Qualifying |
| | | 18 | Women's Scratch Race, Final |
| | | 11 | Women's Team Sprint, First Round |
| | | 13 | Men's Team Sprint, First Round |
| | | 8 | Women's Scratch Race, Victory Ceremony |
| | | 26 | Men's Team Pursuit, First Round |
| | | 8 | Women's Team Sprint, Finals |
| | | 8 | Men's Team Sprint, Finals |
| WED 12 APR | 18:40 / 21:32 | 8 | Women's Team Sprint, Victory Ceremony |
| | | 10 | Men's Team Sprint, Victory Ceremony |

The management and supervision of track competitions requires strict, methodical organisation before the start of the competition. Part of this preparation falls to the organisation and part to the Commissaires, in particular the PCP, who must plan for these responsibilities and then direct the team appropriately.

The PCP is also required to ensure that the organiser has properly prepared key aspects of the competition that could affect sporting control. This means that the PCP needs to understand the requirements, what the PCP's role is with regards to these, and how he or she can, and should, intervene to ensure that the competition is held in an optimum manner in sporting terms.

6.1. THE PROGRAMME

Due to the nature of track cycling, the programme of the competition is a critical element. It needs to meet several, sometimes competing, goals. It needs to:

- maintain the interest of the spectators,
- maintain the pace of the competition,
- protect the riders' health and safety,
- maintain event predictability.

While it is the organiser's responsibility to create the programme, it is the Commissaires who are responsible for implementing it. Thus a key function of the PCP is to ensure that the programme is realistic and meets the goals.

The programme must be included in the Technical Guide that is made available to all stakeholders in advance.



TIP

For many lower level competitions, this information is only available on the competition website.

The PCP may need to adapt or modify the programme. This requires the skill to construct a realistic and predictable programme and associated time schedule. This modification may occur before the start of the competition, or even during the competition in certain circumstances, for example, if there is a reduced number of competitors, race incidents, etc.

6.1.1. TYPES OF COMPETITIONS AND EVENTS

Depending on the level of competition, the programme is drawn up by either the UCI, the organiser, or a combination of both.

The Olympic Games are owned by the IOC and the IOC makes the final decision about the events that make up the competition. The UCI is responsible for drafting the programme which is then submitted to the IOC for approval.

The World Championships and World Cups are owned by the UCI and organised by a local organising committee (LOC) selected by the UCI. The programme is created by the UCI in discussion with the LOC. However, the UCI retains the final approval of the programme.

In the case of regional competitions, for example the Commonwealth Games, Continental Championships, Pan American Games, etc., the programme is the responsibility of the organisation, as defined by the rules concerning the ownership of competitions. In many cases, organisers consult with the UCI and other cycling experts, but remain responsible for final approval.

National Federations are responsible for creating the programmes of National Championships.

In all the above cases, the PCP has no role in the creation of the programme. However, the PCP must still receive the programme in advance of the competition and review it for any concerns.

For all other competitions on the international calendar, the organiser, as identified by the UCI, is responsible for creating the programme. For these competitions, it is important that the PCP reviews the programme in advance and proposes any modifications that may be required to either bring it into compliance with the regulations or ensure it can meet the goals of a successful track competition. The PCP may play a greater or lesser role depending on the class of competition and the level of the organiser's experience.

6.1.2. TRACK LIMITS

For safety and sporting reasons, the regulations limit the number of riders on the track.

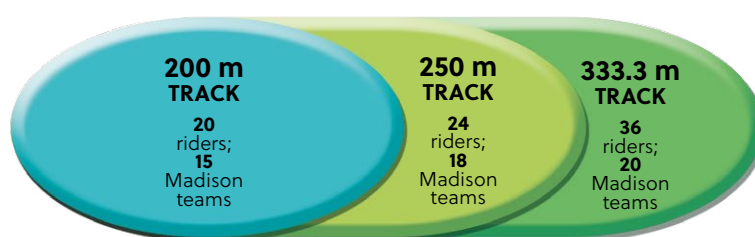

Diagram. Participation Restrictions in number of riders depending on the track length .

Heats may be needed to ensure that these numbers are not exceeded. **They must never be exceeded, not even by a single rider.**

NOTE

For several major competitions, a qualification system is created to ensure that heats are not required so that a final spectator-ready programme can be published well in advance. In other competitions, heats may need to be added or removed based on the entries received. The PCP, together with the Secretary and organiser, modify the programme accordingly and ensure it is properly published so that all stakeholders have the correct information in a timely manner.



TIP

It is best practice not to start a session earlier than originally planned since not all parties may have received notice.

6.1.3. TIMING AND CONSIDERATIONS FOR PROGRAMME PLANNING

The organiser is responsible for creating a programme that meets its needs and satisfies sporting requirements, such as giving athletes enough time to recover between events. However, Commissaires, especially the PCP and Secretary, need to know how a programme is assembled to ensure that it is realistic in terms of timing; they may need to be involved in modifying it in some circumstances.

It is important that all programmes are both realistic and predictable. In other words, if an event is predicted to start at a particular time, unless there is something beyond the control of the organisation, it should be able to start at that time. This is important for all stakeholders, including teams, spectators and television.

The two tables below list the standard timing requirements for elite men and women in perfect conditions. The time indicated is for the entire duration of the event, or heat of an event. This includes the rider coming to the line, the event itself and the rider leaving the track. Some flexibility may be required for competitions that are not on the World Calendar.

Table 1. Elite Men Event Timing

| EVENT | TIME |
|---------------------------|----------------------|
| TEAM PURSUIT | 6 minutes 10 seconds |
| TEAM SPRINT | 3 minutes 6 seconds |
| 30 KM POINTS | 40 minutes |
| 40 KM POINTS | 52 minutes |
| INDIVIDUAL PURSUIT | 6 minutes 40 seconds |
| KEIRIN | 4 minutes 30 seconds |
| 1 KM | 3 minutes |
| ELIMINATION | 17 minutes |
| 200 M TIME TRIAL | 1 minute 20 seconds |
| SPRINT HEATS | 3 minutes 6 seconds |
| 15 KM SCRATCH | 22 minutes |
| 30 KM MADISON | 40 minutes |
| 50 KM MADISON | 60 minutes |
| 10 KM TEMPO RACE | 15 minutes |

Table 2. Elite Women Event Timing

| EVENT | TIME |
|---------------------------|----------------------|
| TEAM PURSUIT | 6 minutes 45 seconds |
| TEAM SPRINT | 2 minutes 45 seconds |
| 20 KM POINTS | 32 minutes |
| 25 KM POINTS | 37 minutes |
| INDIVIDUAL PURSUIT | 5 minutes 40 seconds |
| KEIRIN | 4 minutes 30 seconds |
| 500 M | 2 minutes 45 seconds |
| ELIMINATION | 17 minutes |
| 200 M TIME TRIAL | 1 minute 24 seconds |
| SPRINT HEATS | 3 minutes 6 seconds |
| 10 KM SCRATCH | 17 minutes |
| 20 KM MADISON | 30 minutes |
| 30 KM MADISON | 39 minutes |
| 7.5 KM TEMPO RACE | 14 minutes |

There are several other non-event specific timings that must be considered when planning the programme. If there are protocol ceremonies, 8 minutes should be allowed for each of these.

The programme also needs to ensure that the correct event format is followed. This means that the composition and format of rounds and heats are respected.

For all events where there are heats and rounds, riders need to be given equal recovery consideration. This means that it is not permitted to start a round with two riders where one rider has had one hour of recovery and the other rider has had 10 minutes' recovery. The recovery time does not have to be identical, only reasonably equal.

For the Sprint event, there needs to be a minimum of 10 minutes' rest between Sprint heats of the same riders. The programme also needs to take into account the possibility of a third ride from the quarter finals onwards. This is accommodated by allowing for one possible third ride in each applicable round.

For the Pursuit and Time Trial events, there should be a minimum of one hour between rounds. Ideally the rounds should be in different sessions.

For the Omnium, there should be at least 30 minutes between each of the events.

All the major international competitions include both sprint and endurance events. In these cases, there should be a balance between the events on the programme as well as between men and women events. This makes it possible for riders to participate in multiple events.



Example

- Event 1: Men Flying 200 m,
- Event 2: Women Scratch Race,
- Event 3: Men Sprint Round 1,
- Event 4: Women Keirin Round 1,
- etc.

Event finals tend to be held in later sessions in the day. This is to allow more spectators to attend as well as to ensure the best possible television broadcast opportunities in the host country.

A final consideration that must be allowed for is a warm-up period prior to the start of each competition session. Riders should be given the opportunity to warm up for at least an hour before the start of a competition session.

When the programme is assembled, all timings are rounded to the nearest 5 minutes.



NOTE

It is not necessary to send the highly-detailed programme with timings to the teams. Only the session start time and order of events need be communicated.

NOTE

The programme is normally adjusted on the eve of each competition day based on the number of entries (see the role of the Secretary in chapter 5.1.2.).

The following table is an example of a track programme for a World Cup competition. Note the structure of the programme and timing of events.

|    | | Competition Programme Programme des compétitions | | |
|---|---|---|---|---|
| FRIDAY 3rd NOVEMBER / VENDREDI 3 NOVEMBRE | | | | |
| 10:00 - 12:08 | W - Points race 10 km W - Points race 10 km M - Points race 15 km M - Points race 15 km W - Scratch 5 km W - Scratch 5 km M - Scratch 7.5 km M - Scratch 7.5 km | F - Course aux points 10 km F - Course aux points 10 km H - Course aux points 15 km H - Course aux points 15 km F - Scratch 5 km F - Scratch 5 km H - Scratch 7.5 km H - Scratch 7.5 km | Qualifying - Heat 1 Qualifying - Heat 2 Qualifying - Heat 1 Qualifying - Heat 2 Qualifying - Heat 1 Qualifying - Heat 2 Qualifying - Heat 1 Qualifying - Heat 2 | Qualifications - 1ère manche Qualifications - 2ème manche Qualifications - 1ère manche Qualifications - 2ème manche Qualifications - 1ère manche Qualifications - 2ème manche Qualifications - 1ère manche Qualifications - 2ème manche |
| 14:00 - 20:20 | W - Team Sprint M - Team Sprint W - Team Pursuit M - Team Pursuit W - Points race 20 km M - Points race 30 km W - Scratch 10 km W - Points race 20 km M - Points race 30 km W - Scratch 10 km | F - Vitesse par équipes H - Vitesse par équipes F - Poursuite par équipes H - Poursuite par équipes F - Course aux points 20 km H - Course aux points 30 km F - Scratch 10 km F - Course aux points 20 km H - Course aux points 30 km F - Scratch 10 km | Qualifying Qualifying Qualifying Qualifying Final Final Final Award ceremony Award ceremony Award ceremony | Qualifications Qualifications Qualifications Qualifications Finale Finale Finale Cérémonie protocolaire Cérémonie protocolaire Cérémonie protocolaire |
| SATURDAY 4th NOVEMBER / SAMEDI 4 NOVEMBRE | | | | |
| 12:00 - 16:18 | W - Sprint W - Team Pursuit M - Team Sprint W - Sprint W - Omnium I W - Omnium I W - Keirin W - Keirin W - Sprint W - Omnium II W - Sprint M - Keirin W - Sprint | F - Vitesse H - Poursuite par équipes H - Vitesse par équipes F - Vitesse F - Omnium I F - Vitesse H - Keirin F - Vitesse F - Omnium II F - Vitesse H - Keirin F - Vitesse | Qualifying 200m t.t. 1st round 1st round 1/16 Final Scratch 7.5 km 1/8 Final 1st round 1/4 Final (1st) Tempo Race 7.5 km 1/4 Final (2nd) Repechages 1/4 Final (3rd r.r.) | Qualifications 200m c.l.m. 1er tour de compétition 1er tour de compétition 1/16 Finale Scratch 7.5 km 1/8 Finale 1er tour de compétition 1/4 Finale (1ère) Course Tempo 7.5 km 1/4 Finale (2e) Repechages 1/4 Finale (3e belle év.) |
| 18:00 - 22:11 | W - Sprint M - Team Sprint W - Sprint W - Omnium III W - Sprint M - Team Sprint W - Sprint W - Team Pursuit W - Sprint W - Team Pursuit W - Sprint W - Keirin M - Omnium IV W - Sprint W - Omnium M - Madison 30 km M - Keirin M - Keirin M - Scratch 15 km M - Madison 30 km M - Keirin M - Scratch 15 km | F - Vitesse H - Vitesse par équipes F - Vitesse F - Omnium III F - Vitesse H - Vitesse par équipes F - Vitesse F - Poursuite par équipes F - Vitesse F - Poursuite par équipes H - Keirin F - Omnium IV F - Omnium H - Madison 30 km H - Keirin H - Keirin H - Scratch 15 km H - Madison 30 km H - Keirin H - Scratch 15 km | 1/2 Final (1st) Final places 3-4 & 1-2 1/2 Final (2nd) Elimination 1/2 Final (3rd r.r.) Award Ceremony Finals Final places 3-4 & 1-2 (2nd) Award ceremony Final places 3-4 & 1-2 (3rd r.r.) 2nd round Final Points race 20 km Award Ceremony Final Final places 7 to 12 Final 1 - 6 Final Award ceremony Award ceremony Award ceremony | 1/2 Finale (1ère) Final places 3-4 & 1-2 1/2 Finale (2e) Elimination 1/2 Finale (3e belle év.) Cérémonie protocolaire Finales Final places 3-4 & 1-2 (2e) Cérémonie protocolaire Final places 3-4 & 1-2 (3e belle év.) 2e tour de compétition Finale Course aux points 20 km Cérémonie protocolaire Cérémonie protocolaire Final places 7 à 12 Finale 1 - 6 Finale Cérémonie protocolaire Cérémonie protocolaire Cérémonie protocolaire |
| SUNDAY 5th NOVEMBER / DIMANCHE 5 NOVEMBRE | | | | |
| 11:00 - 16:37 | W - Individual Pursuit M - Sprint M - Team Pursuit W - Team Sprint M - Sprint M - Omnium I M - Sprint W - Keirin M - Sprint M - Omnium II M - Sprint W - Keirin M - Sprint W - Keirin M - Sprint W - Team Sprint W - Individual Pursuit M - Team Pursuit W - Team Sprint M - Team Pursuit W - Individual Pursuit W - Madison 20 km M - Sprint M - Omnium III M - Sprint W - Keirin M - Sprint W - Madison 20 km M - Sprint W - Omnium IV W - Keirin M - Keirin M - Omnium W - Keirin World Cup Round Winner | F - Poursuite individuelle H - Vitesse H - Poursuite par équipes F - Vitesse par équipes H - Vitesse H - Omnium I H - Vitesse F - Keirin H - Vitesse H - Omnium II H - Vitesse F - Keirin H - Vitesse H - Poursuite par équipes F - Poursuite individuelle H - Poursuite par équipes H - Vitesse par équipes H - Poursuite par équipes F - Poursuite individuelle H - Vitesse F - Madison 20 km H - Vitesse H - Omnium III H - Vitesse H - Keirin H - Keirin H - Omnium F - Keirin H - Keirin H - Omnium F - Keirin Award ceremony | Qualifying Qualifying 200m t.t. 1st round 1st round 1/16 Final Scratch 10 km 1/8 Final 1st round 1/4 Final (1st) Tempo Race 10 km 1/4 Final (2nd) Repechages 1/4 Final (3rd r.r.) 1/2 Final (1st) Final places 3-4 & 1-2 Finals 3-4 & 1-2 Finals 1/2 Final (2nd) Award Ceremony Award ceremony 1/2 Final (3rd r.r.) Final Final places 3-4 & 1-2 (1st) Elimination Final places 3-4 & 1-2 (2nd) 2nd round Final places 3-4 & 1-2 (3rd r.r.) Award ceremony Award Ceremony Final Points race 25 km Final places 7 to 12 Final 1 - 6 Award ceremony Award ceremony Award ceremony | Qualifications Qualifications 200m c.l.m. 1er tour de compétition 1er tour de compétition 1/16 Finale Scratch 10 km 1/8 Finale 1er tour de compétition 1/4 Finale (1ère) Course Tempo 10 km 1/4 Finale (2e) Repechages 1/4 Finale (3e belle év.) 1/2 Finale (1ère) Final places 3-4 & 1-2 Finales 3-4 & 1-2 Finales 1/2 Finale (2e) Cérémonie protocolaire Cérémonie protocolaire 1/2 Finale (3e belle év.) Finale Final places 3-4 & 1-2 (1ère) Elimination Final places 3-4 & 1-2 (2e) 2e tour de compétition Final places 3-4 & 1-2 (3e belle év.) Cérémonie protocolaire Cérémonie protocolaire Final Course aux points 25 km Final places 7 à 12 Finale 1 - 6 Cérémonie protocolaire Cérémonie protocolaire Cérémonie protocolaire |

As of 16.10.17

6.1.4. MANAGING THE PROGRAMME

Once the programme has been created and approved, it is the role of the PCP, together with the Commissaires, to manage the programme effectively. This means ensuring that the event order and rounds are respected and that the schedule is observed.

Any modifications to the programme must be communicated to all stakeholders in good time so that they can react appropriately. This is usually done through a communiqué.

NOTE

It is generally not acceptable to move a published start time to earlier than stated. In exceptional circumstances this can be done, but the PCP, together with the organisation and TD, need to ensure that all affected stakeholders are properly informed so that the sporting requirements of the event can be met.

During the competition, if an event is stopped for any reason (for example due to a false start, fall, accident of some kind, etc.), the PCP must ensure that the round is restarted without delay, or should move on to the next round or event. If the stoppage was due to a crash, the PCP must examine the track to see if there is any visible damage at the site of the crash before the round restarts. If there is any visible damage, this should be repaired as quickly as possible by the Track Director. Only then can the round be restarted.

NOTE

Inspection of the track does not mean the PCP or Commissaires are verifying that the surface is rideable or assuming any legal liability for safety or the condition of the racing surface.



TIP

The PCP may sometimes modify the programme slightly to ensure that the competition stays on schedule. For example, in the Sprint competition, this may be done by starting the next heat and then returning to the stopped heat. However, all the heats of an event must be completed before moving on to the next event.



REQUIRED KNOWLEDGE

- Who is responsible for the programme of the various events.
- The track limits for the various size tracks



WHAT TO DO

- Review the timings of the schedule to make sure they are realistic.
- Review the event formats on the programme to ensure that they comply with the regulations.
- Review the programme format to ensure riders are given sufficient rest between rounds and events.
- Manage the approved programme so that the schedule is respected.



WHAT NOT TO DO

- Keep changing the pace of the programme – it is better to plan the pace of the events to ensure this is consistent across the competition.
- Make changes to the programme without informing all stakeholders.
- Move published start times to an earlier time.

6.2. PREPARATION AT HOME BEFORE THE COMPETITION

The management and sporting control of a competition requires methodical organisation by officials before, during and after the race.

Several stages in the preparation and management of the competition can be identified:



Diagram. Competition preparation and management

TRAVEL ARRANGEMENTS

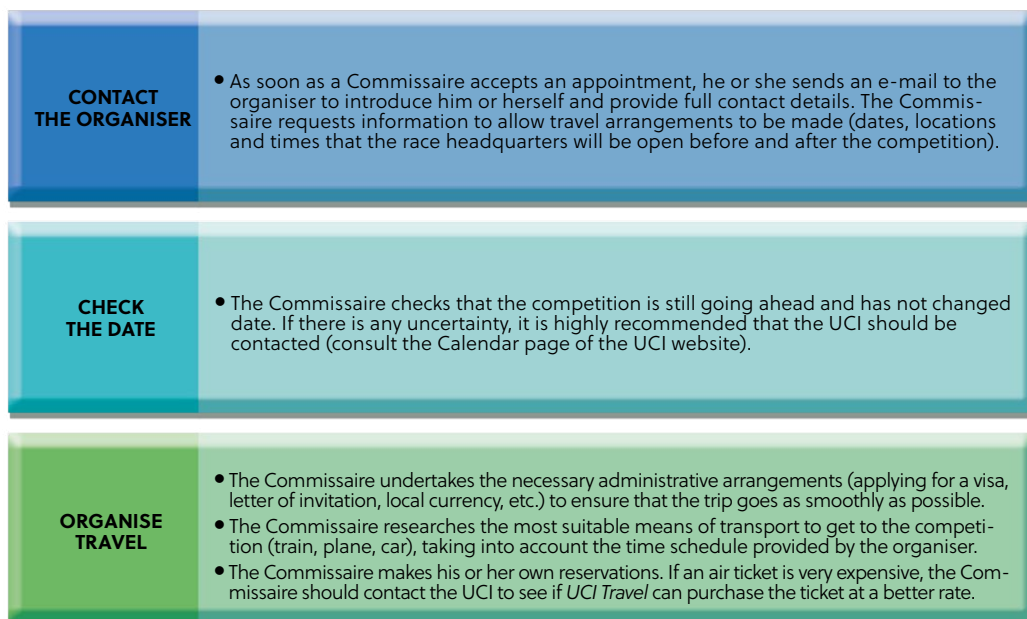

Diagram. Travel arrangements

RECEIPT AND VERIFICATION OF COMPETITION DOSSIER

- When received, the Commissaire carefully studies the competition dossier (technical guide and special regulations sent by the organiser as well as the previous year's evaluation sent by the UCI):
 - for familiarisation with the competition,
 - to become aware of any problems encountered the previous year,
 - to gain information, if necessary, on measures undertaken to correct the said problems.
- The Commissaire contacts the organiser if the competition dossier (or part of it) is not received promptly.
- The Commissaire checks that the documents are properly drawn up in one of the UCI's two official languages (French or English) and that they do not contradict UCI Regulations.
- The Commissaire informs the organisation director of any changes required (whether technical, regulatory or administrative).

6.3. CHECKS AND VERIFICATIONS BEFORE THE COMPETITION

6.3.1.

TECHNICAL GUIDE AND SPECIAL REGULATIONS

The Technical Guide is an important document for the Commissaires, teams, riders and all other people involved in the competition. Drafted in French or English to ensure it is widely understood, it contains all the important information about the competition and must conform with the UCI Regulations.



The list of mandatory information is specified by the UCI Regulations, **PART 3 - §1 – ARTICLE 3.1.002**.



CHECK LIST – Technical guide

■ 1. The competition special regulations

- competition will be run under UCI Regulations,
- if appropriate, give the specific regulations of events,
- the race programme and schedule – including official training,
- a description of the track (length, coating, indoor or outdoor),
- location of the Race Headquarters, Doping Control Room and Press Room,
- the place and time of registration and the distribution of riders' numbers,
- the place and time of the Team Managers' meeting,
- the programme of the official ceremonies,
- prizes,
- the composition of the Commissaires' Panel,
- the name, address and telephone number of the director of the organisation,
- specification that only the UCI Scale of Penalties shall apply,
- the doping control regulations that apply.

■ 2. Venue information

- location
- map from/to the velodrome,
- local transport,
- public transport,
- team containers/equipment storage.

■ 3. Medical emergency

- who to contact,
- hospital locations.

■ 4. Transportation (if applicable)

- shuttle to and from the velodrome,
- shuttle to and from the airport.

■ 5. Meals (if applicable)

- schedule,
- locations.

The PCP must inform the organiser if there is any non-compliance of the special regulations with the UCI Regulations and must endeavour to find a solution as quickly as possible in consultation with the organiser. The organiser must be informed in advance to avoid any problems on the ground and to ensure that lasting solutions can be implemented.

If agreement cannot be reached, the PCP contacts the UCI.



CHECK LIST – Technical guide and special regulations

- 1. Check that all elements of **ARTICLE 3.1.002** are properly indicated in the guide and conform to UCI Regulations.
- 2. Check that the distances and competition formats conform to the event specific regulations in the UCI Regulations, Part 3, Chapter 2, Articles 22 to 264.
- 3. Check that the schedule is realistic and appropriate.
- 4. Check that the warm-up sessions have been properly included.
- 5. Check the compliance of the special regulations with the UCI regulations.
- 6. If necessary, suggest changes to the organiser, concerning the following points in particular:
 - organisation,
 - type of event,
 - participation,
 - programme schedule,
 - prizes,
 - anti-doping (application of UCI and local anti-doping rules),
 - podium ceremonies,
 - penalties (solely the UCI Scale applies).

6.3.2.

PARTICIPANTS, INVITATIONS AND ENTRY OF STARTERS

Participation in most track competitions is governed by the UCI Regulations, Part 3, Chapter 2, Article 1. Other than for major international competitions consisting of the Olympic Games, World Championships and World Cups, the organiser may set any entry criteria desired, provided the age categories specified by **ARTICLE 3.2.001** are observed.

Generally, riders can enter as individuals or as members of a team. The organiser has the right to set any entry restrictions to ensure the track's rider capacity is not exceeded and that the competition can take place in the best possible circumstances.

NOTE

If more than 50% of the field in an event is made up of invited riders rather than through open entry, this must be noted; the number of ranking points awarded by the UCI will be reduced.



Riders and teams must use the entry forms created by the organiser for the competition and must respect the entry deadlines imposed by the organiser.

Participation in major international competitions is governed by the respective articles of the UCI Regulations. Entry is conducted directly with the UCI, who verify that a team's participation is correct. In this case the role of the Commissaires is to make a final check that the entries are correct based on the information provided by the UCI using entry summary forms and to verify that any changes made at the licence control are permitted according to the respective regulations.

NOTE

- Participation in World Cups is governed by **ARTICLES 3.4.004 to 3.4.009bis**.
- Participation in the World Championships is governed by **ARTICLES 9.2.001 to 9.2.009** and **ARTICLES 9.2.022 to 9.2.029**.
- Participation in the Olympic Games is decided by agreement between the UCI and the IOC prior to each Games.

6.4. PREPARATION AT THE VELODROME BEFORE THE START

Several checks need to be made at the velodrome before the sporting aspect of the competition starts.

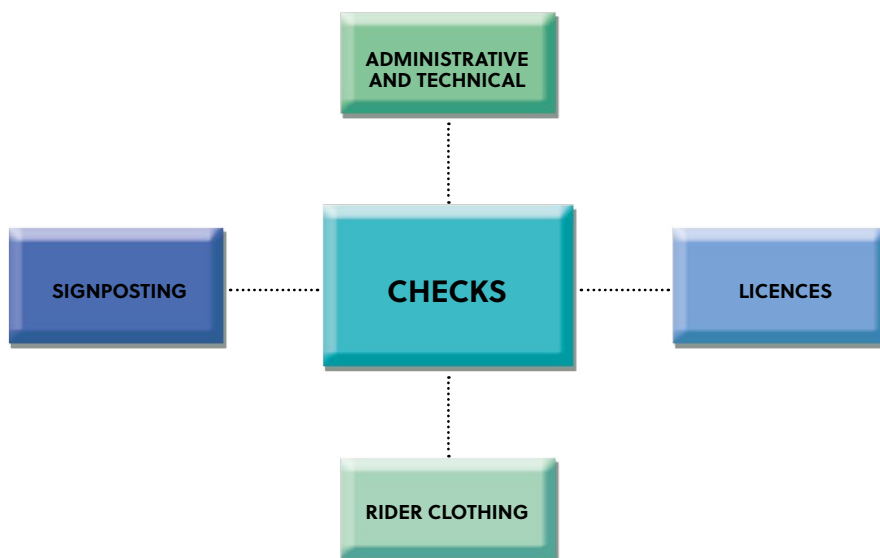

Diagram. The various checks to be conducted by the Commissaire at the venue before the start of the competition

6.4.1. CHECK OF THE VELODROME

The organiser is required to make sure that all the necessary resources for the competition are in place before the arrival of the Commissaires. The TD, if appointed, should have already made a check of all these resources. However, it is important that the PCP still completes all necessary checks since any deficiencies in this area will impact directly on the PCP's work and the sporting control of the competition.

6.4.1.1. Technical Resources

**CHECK LIST – The Commissaire checks the following technical resources:**

- the starting equipment,
- the Starter's podium,
- the Finish Judge's podium,
- the position for the Secretary,
- the Judge-Referee's position,
- the Judge-Referee's equipment,
- the location of the Technical Equipment zone,
- jigs, scales and bicycle-measuring equipment are all in place,
- flags,
- whiteboard and pens for issuing warnings and disqualifications,
- foam pads,
- radios,
- lap boards and bells are in place,
- the Speaker's degree of experience.

**CHECK LIST – The Commissaire liaises with the organiser on the following administrative and technical points:**

- the availability of the required medical personnel,
- the availability of technical computing resources (photo-finish, copiers, communiqué distribution),
- the availability of technical volunteers (for positioning pads, starting gates, access control, etc.),
- the availability of equipment and personnel for track maintenance,
- the location and format of the protocol ceremonies,
- the doping control room (in cooperation with the DCO),
- the team boxes and resources,
- availability of water on the infield,
- the setup of the start line areas (chairs, backdrops, access to the track, etc.),
- any required transportation.

6.4.1.2. Fixtures and Meeting Rooms

The organiser is required to ensure that the following areas and facilities are prepared:

- the velodrome,
- organisational structures (for example, team equipment storage areas),
- meeting rooms (including permanence, Commissaires' room, Team Manager meeting room, etc),
- parking areas,
- accommodation, including transportation and meals where required.

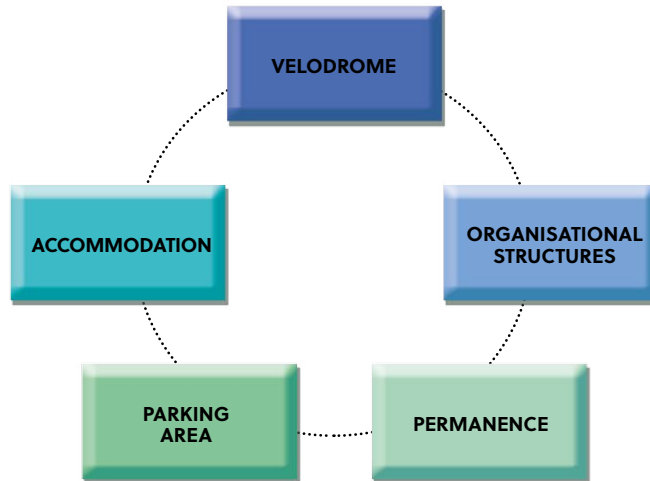

Diagram. Start areas and facilities to be checked



The venue often does not have enough space to manage all the above. In this case the organiser may use temporary facilities such as marquees, storage containers and off-site parking. All these facilities need to be appropriately signposted.



The organiser must make sure that organisation staff are available to help guide stakeholders to the appropriate areas.

The opening hours of the Permanence must be indicated in the Technical Guide. The personnel and equipment at the Permanence must be such that all parties can work in good conditions.

The following items are distributed at the Permanence:

- accreditation for all stakeholders,
- parking passes if required,
- rider numbers. The organiser should ensure that there are sufficient race numbers, Technical Guides, pins and envelopes. The Commissaires normally fill the envelopes for each team once the licence checks have been completed.

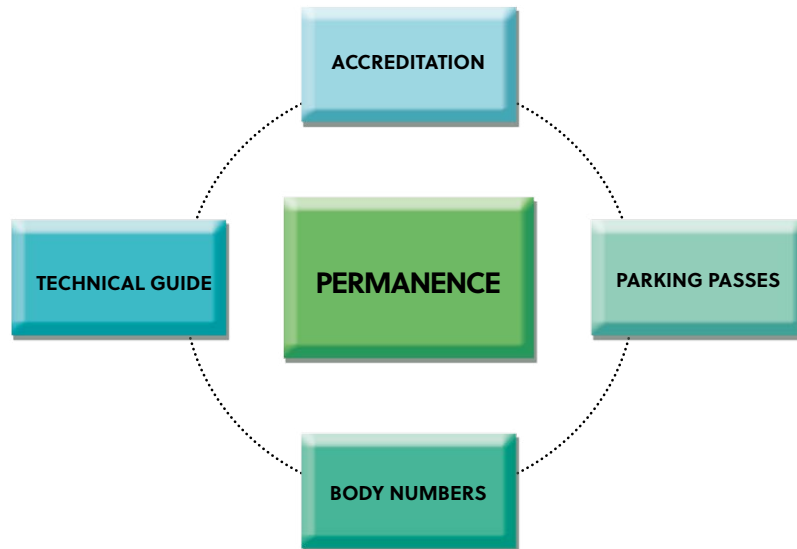
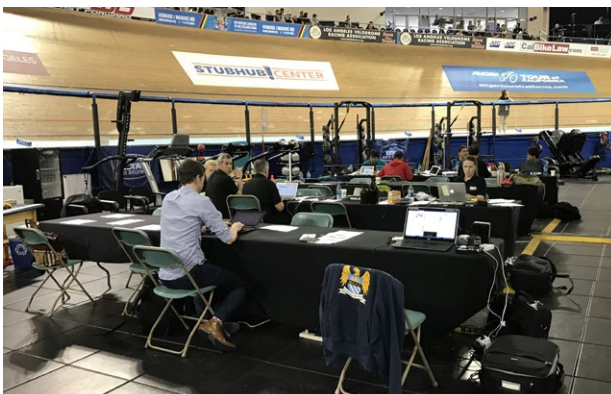

Diagram. Functions of race headquarters

For more information on the Permanence, as well as the other meeting rooms (the Team Managers' Meeting Room, Commissaires' Meeting Room and Doping Control Room) see [chapter 3.3.1](#).

The organiser must also ensure there is a Press Room at the venue. This needs to be available from the day before the start of the competition:

- this room is used to issue journalists' accreditation,
- it should offer work spaces with power points and Internet connections.



For major competitions, this area is often set up in the in-field.

6.4.2.**LICENCE CHECK AND CONFIRMATION OF STARTERS**

Any individual participating in a competition controlled or organised by the UCI, the UCI's Continental Confederations, UCI member federations or their affiliates must be in possession of a licence. Several different categories of licence are available.

**UCI REGULATIONS**

No-one who does not hold the requisite licence may participate in a cycling event organised or supervised by the UCI, the UCI continental confederations, the UCI member federations or their affiliates. **(ARTICLE 1.1.002)**



A licence is an identity document confirming his or her commitment to respect the regulations and statutes that authorises the individual to participate in cycling competitions **(ARTICLE 1.1.001)**.

Commissaires are responsible for checking that riders have valid licences. The licence must be presented to the Commissaires at the time of confirmation by a team representative (a copy is acceptable).

A suspended rider must not be allowed to participate in a competition under any circumstances.

NOTE

Journalists and members of the press who are duly accredited by the organiser do not have the regulatory obligation to be in possession of a licence issued by a national federation **(ARTICLE 2.2.035)**.

**ISSUE OF LICENCES**

Licences are issued by national federations in accordance with criteria set down by these federations. The federation is responsible for checking that these criteria are respected. Before a licence can be issued, the licence holder and federation must verify that the licence holder is covered by civil liability insurance for accidents in all countries in which he or she engages in competitive cycling or training. This insurance must be valid for the entire year for which the licence is issued **(ARTICLE 1.1.006)**.

**UCI REGULATIONS**

- The licence shall be issued by the federation of the country where, according to the legislation of that country, the applicant has his main residence at the time of application. He shall remain affiliated to that federation until the expiry of the licence, even if he changes country of residence **(ARTICLE 1.1.011)**.
- In the case of a country where there is no UCI member federation, the licence shall be issued by the UCI **(ARTICLE 1.1.013)**.

**PERIOD OF VALIDITY**

The licence shall be valid for one year, from 1 January to 31 December. It shall be valid in all countries where there is a UCI member national federation **(ARTICLE 1.1.008)**. A licence holder may hold the licence of only one national federation **(ARTICLE 1.1.009)**.



CATEGORIES OF LICENCE HOLDER (ARTICLE 1.1.010).

The following individuals require a licence:

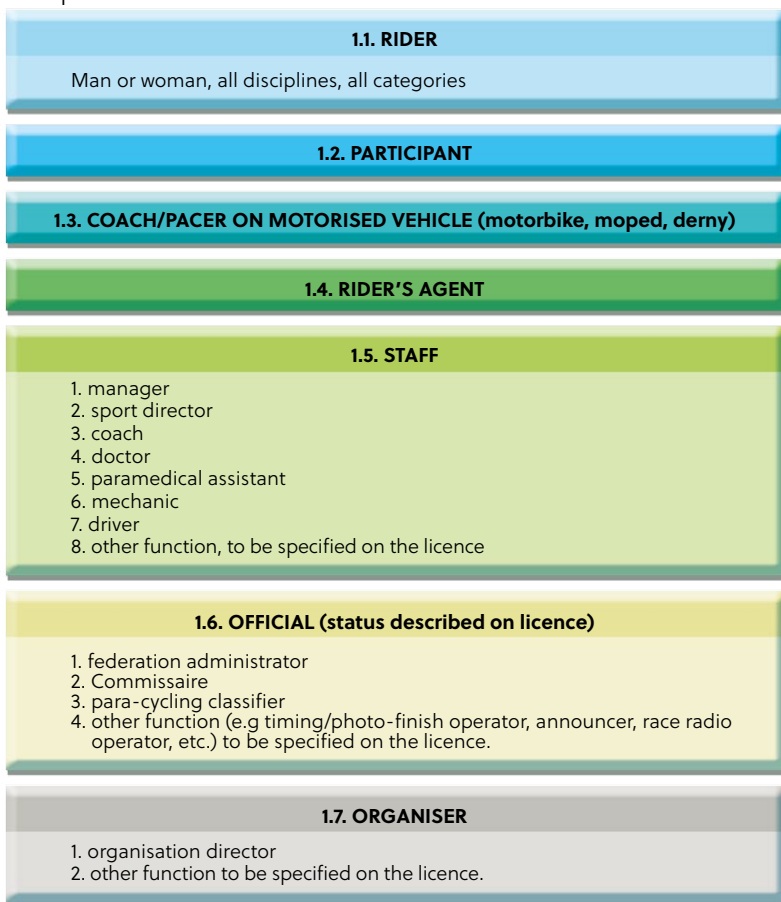

Diagram. Licences

If a licence holder exercises several functions in the world of cycling, he or she must apply for, and be issued with, a licence for each different function. The national federation is responsible for issuing the licence corresponding to the main function according to the order described above.

A rider belonging to a team registered with the UCI may not carry out another role.

SAMPLE

Front



Back

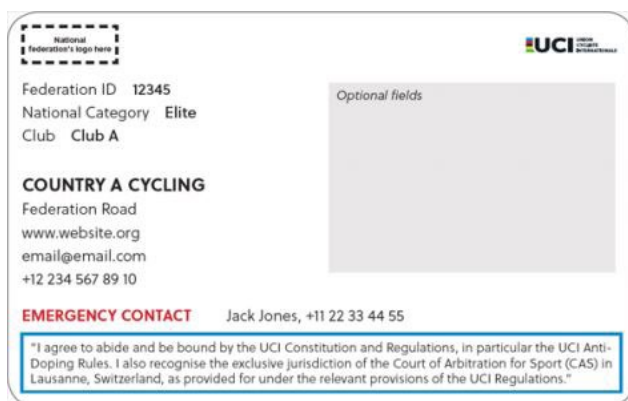

If a licence has been issued by a national federation but does not bear a photo of the holder, Commissaires must ascertain the exact identity of the rider by checking an official identity document (passport, national identity card, etc.).

In respect of riders who have not reached majority age (Men and Women Junior categories), the age of the participant should be checked by means of an official document (passport or other).



LANGUAGE

The licence shall be written in French or English. Other language versions of its text may also appear (**ARTICLE 1.1.025**).

RIDER CATEGORIES

The UCI defines several rider categories. The category in which a rider participates is determined by his or her age, in other words the difference between the year in which the competition is held and the athlete's year of birth. The minimum age to participate in competitions on the international calendar is 17. There is no maximum age.

Table. Categories for Men and Women



| | |
|-----------------------------|--|
| Youth | This category denotes riders aged 16 years or under. It is controlled by the national federations, except for the provisions in place for BMX (ARTICLE 1.1.036). |
| Junior (MJ and WJ) | This category comprises riders aged 17 and 18. |
| Under-23 (MU and WU) | This category comprises riders aged 19-22. |
| Elite (ME and WE) | This category comprises riders aged 23 and over. |
| Master (MM and WM) | This category comprises riders aged 30 and over who choose this status. The choice of Master status is not open to a rider who is a member of a UCI-registered team. |
| Para-cyclist | This category designates riders with disabilities in accordance with the functional classification system for cycling described in Part 16, Chapter 5. A para-cyclist may or may not, depending on reasons of health and safety, be issued with another licence from this list. This depends on the nature and degree of the athlete's disability. A rider may be asked to provide proof of his functional classification. |



Riders of the Under-23 category can take part in Elite competitions. Juniors who are 18 years old can take part in competitions in the Under-23 and Elite categories (**ARTICLE 3.2.001**).

In certain competitions, categories can be mixed within the same event. If several categories participate in the same event, only the category of the majority of participants will be taken into account.

It is possible for younger athletes or masters to participate in elite events in order to expand the size of the bunch. Nevertheless, riders younger than 18 years old will not score UCI points and must not be taken into account in the analysis of the minimum number of participating nations (article 3.8.003). 18-year-old junior riders will score UCI points in elite ranking. However, in all cases, all athletes must be included and appear in the results.

LICENCE CHECKING PROCEDURE

The team manager presents his or her licence to the Commissaires. The Commissaire checks that this is a valid team manager's licence and notes the team manager's details (UCI Unique ID and telephone number) and, if appropriate, confirms where the team is staying.

The team manager then presents the licences of the riders who have been entered to compete. Depending on the level of the competition, it may be possible to make substitutions or present new entries. This must be confirmed in advance with the UCI or organiser, as appropriate.

Commissaires must check the following:

- that the licence presented is valid.
- that no rider attempts to participate in a race or cycling competition without being a holder of the necessary licence. In this case, the rider should be prevented from starting. This information should be forwarded to the relevant bodies to allow an official decision to be made.
- that no rider attempts to participate in a race or competition without carrying his or her licence. The rider should be prevented from starting or disqualified from the competition and fined CHF 50 - 100. Note that cases of carelessness should be treated with more understanding (forgotten or recently lost licence, etc.) (**ARTICLE 1.1.029**).

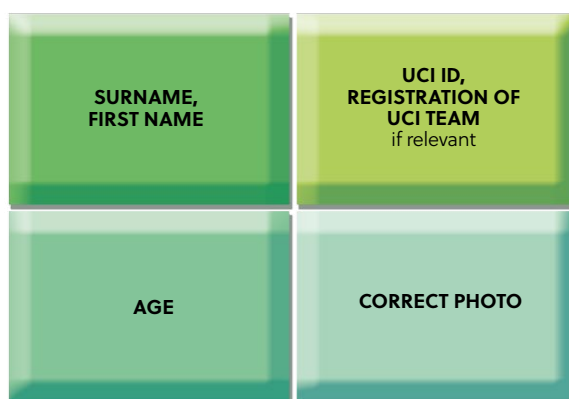

Diagram. Licence check



Check list – Licences

- Check the team manager licence.
- Check licence validities.
- Check the riders' identities, taking into account the race class.

CONFIRMATION OF STARTERS

After licences have been checked by members of the Commissaires' Panel delegated by the PCP, the list of starters is drawn up by the competition's computing service following confirmation by the teams (team managers) of the riders who will start in each event. It is important that team managers also identify any possible reserves for each of the events at this time. Only riders who have either been entered to start the event, or as a reserve for that event, are allowed to participate in that event. The Secretary is responsible for checking this list.

NOTE

If a rider has not been entered as a reserve for a particular event, then he or she is not allowed to be substituted into that event.

Once the list has been checked, the start lists for events are created based on the seeding. [See chapter 5.1.2](#) for more information.

Once the event start lists have been drawn up, the organiser is responsible for the distribution of the lists, without delay, to the teams, officials and media. These initial start lists are sometimes distributed at the Team Managers' meeting.

A digital version of the list of starters should also be sent to the relevant UCI entities depending on the competition class (for example, anti-doping) as soon as possible.

| Heat | Race Number | Country / Name | Time |
|------|-------------|-------------------------------------|------|
| 6 | 190 | FRA - France VOIGER Sébastien | |
| | 184 | EDELIN Benjamin | |
| | 186 | LAFARGUE Quentin | |
| 7 | 332 | RUS - Russia YAKUSHEVSKIY Pavel | |
| | 327 | SANKHIDNO Kiri | |
| | 330 | TKACHEV Aleksei | |
| 8 | 217 | GER - Germany NIESBERG Max | |
| | 213 | ENGLER Eric | |
| | 214 | FORSTSMANN Robert | |
| | 197 | GBR - Great Britain CARLIN Jack | |
| 8 | 203 | TROSMAN Joseph | |
| | 200 | OWENS Ryan | |
| | 351 | NZL - New Zealand MITCHELL Ethan | |
| | 298 | DAWKINS Edward | |
| | 303 | WEBSTER Sam | |
| 8 | 310 | POL - Poland BIELECKI Maciej | |
| | 314 | RIEFLY Marcin | |
| | 313 | MAKSEL Krzysztof | |

Qualification rule:
The fastest eight teams qualify for the Final round.

Note:
The composition of the teams may be subject to change up to 30 minutes before the start of the race. Sorted in the order given by the team.

The list of starters must comprise:

- the words "list of starters" or "start list",
- name of the competition,
- name of the event,
- the date and time of the event,
- the organiser's name,
- the names of the riders participating in the event,
- the associated rider numbers,
- the starting order.

Following the confirmation of starters, the race number envelopes are usually prepared by the Commissaires.



TIP

It is not necessary to assign a consecutive series of numbers to a team. However, it is a good idea to assign low, consecutive numbers to riders in an Omnium or Points Race. This makes managing the race easier.

Sometimes races also require special number sets, for example, the Madison.



TIP

In the case where riders may be assigned different numbers for different events in a competition, the distribution of these numbers can be done on the morning of the relevant event. This reduces the risk of incorrect numbers being worn or numbers being left behind at the riders' accommodation.

6.4.3.**CHECK OF RIDERS' CLOTHING**

Normally, the riders' clothing can only be checked at the last moment, i.e. just before the start, on the start line in fact. The Commissaires may even note certain infringements concerning the riders' clothing during the race. The fact that a rider was permitted to start wearing the incorrect clothing does not mean that that clothing was authorised. The riders are still always responsible for the clothing they wear.

MOST FREQUENT INFRINGEMENTS

Diagram. Most frequent infringements

**WHAT TO DO**

- Check the signposting to the competition's administrative areas and facilities.
- Check that the facilities are suitable.
- Check the technical areas.
- Prepare the room for the confirmation of starters.
- Check the organiser has the required race numbers.
- Check licences and their validity.
- Carry out the confirmation of starters.
- Prepare the rider number envelopes.
- Draw up the list of starters. Check and distribute the list.
- Gather information on the teams' accommodation arrangements.
- Check the riders' bicycles and race clothing.
- Ensure that jerseys comply with the regulations.

6.5. OFFICIAL TRAINING AND WARM UP SESSIONS

The official training and warm up sessions are key components of major track competitions. Both exist to fulfil very specific purposes and the Commissaires have different roles to play in each case.

6.5.1. DIFFERENCE BETWEEN OFFICIAL TRAINING AND WARM UP SESSIONS

Official training sessions occur the days before the start of the competition. Warm up sessions occur on the days of the competition.

OFFICIAL TRAINING

WORLD CHAMPIONSHIPS OFFICIAL TRAINING SESSIONS

| TIME | Saturday 08.04.17 | TIME | Sunday 09.04.17 | TIME | Monday 10.04.17 | TIME | Tuesday 11.04.17 |
|-------------|-------------------|-------------|-----------------|-------------|-----------------|-------------|------------------|
| 9:00-10:45 | B | 9:00-10:45 | C | 9:00-10:45 | E | 9:00-10:45 | E |
| 10:45-12:30 | B | 10:45-12:30 | D | 10:45-12:30 | F | 10:45-12:30 | C |
| 12:30-14:15 | C | 12:30-14:15 | E | 12:30-14:15 | B | 12:30-14:15 | D |
| 14:15-16:00 | D | 14:15-16:00 | F | 14:15-16:00 | A | 14:15-16:00 | E |
| 16:00-17:45 | E | 16:00-17:45 | A | 16:00-17:45 | C | 16:00-17:45 | F |
| 17:45-19:30 | F | 17:45-19:30 | B | 17:45-19:30 | D | 17:45-19:30 | A |

| GROUP A | GROUP B | GROUP C | GROUP D | GROUP E | GROUP F |
|--------------------|-----------------|------------------|-----------------|--------------|--------------------|
| 10 Great Britain** | 20 Italy** | 29 Germany** | 21 Azerbaijan** | 24 Belarus** | 17 Great Britain** |
| 11 Hong Kong** | 31 Netherlands* | 18 France** | 16 China** | 26 Poland** | 16 Hong Kong** |
| 13 Belgium** | 10 Mexico | 13 Spain** | 11 Belarus | 11 Japan** | 13 Belgium** |
| 7 Colombia | 32 Denmark* | 5 Czech Republic | 7 Ukraine | 18 Ukraine | 5 Colombia |
| 5 Venezuela | 4 Hungary | 2 Kazakhstan | 4 Switzerland* | 3 Austria | 3 Venezuela |
| 2 Malaysia | 1 Chile | 3 Chinese Taipei | 2 Portugal | 2 Korea | 3 Malaysia |
| 1 Slovakia | 1 Finland | 1 Norway | 1 | 1 India | 1 Slovakia |
| 1 Greece | 1 Suriname | 1 | 1 | 1 | 1 Greece |
| 62 | 62 | 62 | 62 | 62 | 62 |

As of 04.04.2017

For major competitions, official training sessions are scheduled for all participating teams. These sessions are normally scheduled to start up to four days prior to the competition and end the day before the start of the competition.

The organiser, or UCI, produces a schedule for the teams for official training.

The day is usually broken up into one and a half to two-hour time slots which are assigned to the teams. More than one team will train at the same time in order to facilitate the schedule. Team sizes are taken into account to try to ensure that each session has a similar number of riders on the track.

The sessions are also rotated every day to ensure that it is not always the same teams that have to arrive early at the track, in particular the teams that are in the last session the evening before, etc. The schedule is published well in advance to ensure all teams are aware of their training times.

The organiser normally provides transportation to and from the track for these sessions, and is required to ensure that the track is usable, that all relevant technical equipment is available and that medical services are on hand.

Starting gates and dernys are not permitted during training sessions. Riders may perform standing starts, but only in the sprinter's lane in the home straight and one at a time. It is not permitted for more than one rider to line up either across the track, or one behind the other.

WARM UP SESSIONS

Warm up sessions are scheduled on competition days. Depending on the programme, these sessions usually start two hours before each competition session and end 10 minutes before the start of the events.

The warm up sessions are available to all riders competing in the competition. However, if there are a large number of competitors, it is sometimes necessary to restrict the warm up to just those riders competing in the following session. In some cases, the warm up session may be broken up into two 1-hour blocks, with the first hour reserved for riders not competing in that session, and the second hour reserved for riders competing in that session.

The organiser is required to make sure that the track is usable during these sessions and that medical services are available.

Starting gates and dernys are not permitted during warm up sessions. Riders may perform standing starts, but only in the sprinter's lane in the home straight and one at a time. It is not permitted for more than one rider to line up either across the track, or one behind the other.

6.5.2. MANAGING THE TWO TYPES OF SESSIONS

There should always be two Commissaires on duty monitoring the official training and warm up sessions.

The official training sessions generally take place before the arrival of the assigned Commissaires. The organiser should work with the host National Federation to appoint two Commissaires for all these sessions.

The PCP is responsible for assigning the Commissaires to monitor the warm up sessions. It is advisable to rotate this duty around the Commissaires so it is not always the same people having to do this work.

TIP

It is recommended that the PCP consults one of the host National Federation Commissaires to identify who should work at the warm up sessions.

The general duty of these Commissaires is to monitor the conduct of the riders and personnel on the track and Safety Zone for any dangerous behaviours. While the riders and team members are always responsible for their own conduct, if the Commissaire sees something dangerous, he or she may intervene to stop that behaviour.

For the official training sessions, the Commissaires ensure that only those teams scheduled to participate in the session are on the track. For the warm up sessions, if the session is restricted to just the riders taking part in the following competition session, the Commissaires need to ensure that it is only these riders on the track.

TIP

If, for example, there is no Pursuit in the following session, there should be no riders on pursuit bicycles in the warm up session.



In the case where standing starts are taking place on the track, one of the Commissaires must position themselves in corner 4 with a whistle and red flag to indicate to the riders on the track that they need to move up.

Should it become necessary to close the track, for example, in the case of a crash, the Commissaires ensure that the riders respect the fact that the track is closed.

In the case of any misconduct during these sessions, the Commissaires have the right to impose penalties, including removing riders from the track. All misconduct must be reported to the PCP.

Generally, riders may not do anything during the warm up or official training sessions that they would not be allowed to do during competition.

REQUIRED KNOWLEDGE

- Permitted conduct of riders on the track.
- Permitted use of the Safety Zone.
- Use of standing starts during official training and warm up sessions.
- Permitted use of equipment on the track during official training and warm up sessions.
- Role of the organiser, TD and PCP for official training and warm up sessions.

WHAT TO DO

- Ensure that two Commissaires are assigned to monitor the official training and warm up sessions.
- Monitor the conduct of the riders and team personnel on the track during the official training and warm up sessions.
- Properly supervise any standing starts.

WHAT NOT TO DO

- Permit conduct that is not normally allowed during competition.
- Allow unauthorised teams/riders to use the track.

CHAPTER 7 MEETINGS BEFORE THE COMPETITION

UCI 2017 TRACK CYCLING
WORLD CHAMPIONSHIPS HONG-KONG
CHINA

PRESENTED BY TISSOT



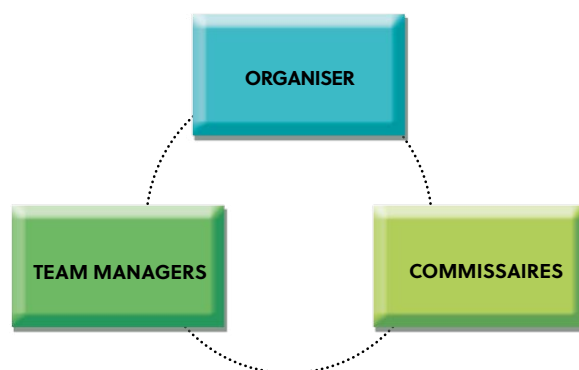

Diagram. Meetings

7.1. MEETING WITH THE ORGANISER

The following individuals should attend:

- The Organiser and Track Director,
- The PCP,
- The TD.

The meeting is run by the PCP.

The preliminary meeting between the organiser and the PCP is an important step towards cementing a productive working relationship.

This collaboration has many objectives which must be accurately defined:

- distributing tasks, competences and responsibilities to each party,
- organising and supervising the conduct of the Team Managers' meeting,
- modifying and communicating any points of the competition's special regulations that do not conform with the UCI regulations,
- reviewing and modifying any elements of the programme (including Warm Up sessions) that do not conform to the regulations,
- verifying that all technical resources are in place.



CHECK-LIST – Checks to be conducted upon meeting the organiser

- **Preparation of the room** for the Team Managers' meeting.
- **Check of the technical resources** to be provided to facilitate sporting control:
 - Starting gates,
 - Starting apparatus,
 - Judge-Referee video equipment,
 - Photo-finish,
 - Electronic timekeeping,
 - Lap boards and bell,
 - Foam pads (if needed),
 - Bicycle-checking equipment,
 - Rider waiting areas,
 - Commissaire radios.

■ **Check of medical facilities:**

- Infield,
- First Aid room,
- Ambulance,
- Doctor and personnel.

■ **Volunteer support:**

- Assisting the Judge-referee,
- Starting gates,
- Access control,
- Communiqué management,
- Foam pads.

■ **Check of the computing resources.**

■ **Discussion of programme:**

- Timing,
- Impact of any live television.

■ **Check of anti-doping facilities (with DCO).**

■ **Service providers:**

- Who is present.

■ **Protocol podium:**

- Location,
- Backdrop,
- Procedure.

■ **Track Maintenance:**

- Location of personnel,
- Availability,
- Sufficient supplies,
- Radio contact.

■ **Clarification of the input** and coordination of the Organiser or Track Director, TD and PCP at the Team Managers' meeting.

7.2. COMMISSAIRES' MEETING

The following individuals must attend:

- Members of the Commissaires' Panel,
- TD.

The Commissaires' Panel meeting is chaired by the PCP who describes the programme of the competition and identifies potential issues. The aims of the meeting are to allocate tasks before and during the competition to members of the Panel, ensure consistency in decision making and make it possible for the programme to run without delays.

A good meeting will promote a healthy team spirit and foster solidarity among the Commissaires. The PCP ensures that the Panel operates on a collegial basis. The meeting is usually held the day before the competition in a private room.

PROCEDURE OF THE MEETING

Ideally, the Commissaires' Panel meets before the licence control and Team Managers' meeting.

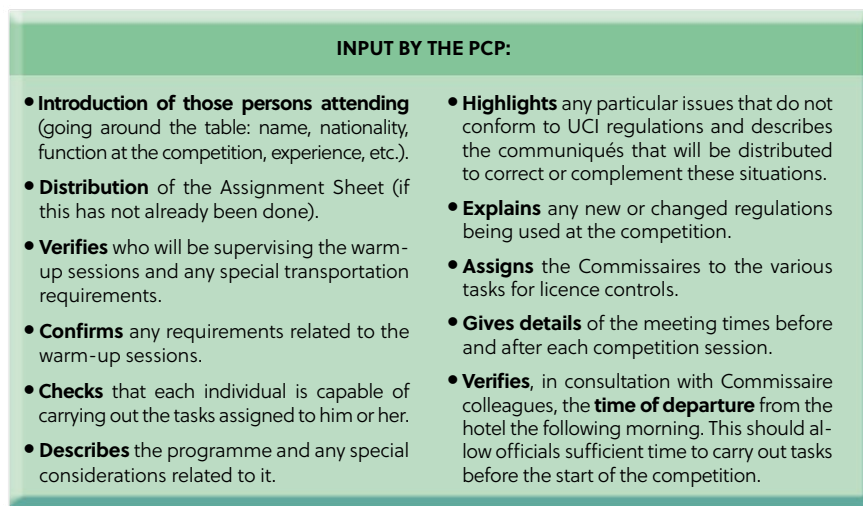

Diagram. Input by the PCP during the meeting of the Commissaires' panel

7.3. TEAM MANAGERS' MEETING

The following individuals must attend:

- The Organiser or Track Director,
- PCP, who chairs the meeting,
- All members of the Commissaires' Panel,
- DCO,
- TD,
- Team managers.

NOTE

Representatives of the press are not allowed at this meeting.



The Team Managers' meeting allows the Commissaires' Panel to explain its role to all stakeholders in the competition. This meeting has the following **objectives**:

- **explaining** the distribution of tasks,
- **presenting** the specific characteristics of the competition, with each party referring to its own special expertise,
- **describing** any specific measures taken, in particular concerning safety,
- **issuing reminders** of the measures required to guarantee sporting regularity.

The PCP offers reminders of the applicable regulations, in particular with regard to the specific characteristics of the competition. Particular attention is focused on any new or changed regulations.



TIP

Do not spend any time reading regulations to the participants or going over old rules. This will not serve any purpose.



TIP

Any important or more detailed information should be included in the initial communiqués and distributed to the team managers at, or immediately after, this meeting.

The organiser must ensure that **the meeting is held in an appropriate venue** that is sufficiently large to accommodate all the participants. Furthermore, **the meeting must start on time**, not be scheduled to last more than 30 minutes and **French/English interpreting services should be provided**.



TIP

Keep the meeting as short as possible. If a lot of information is being provided, people will forget what is being said.



TIME OF MEETING

The meeting must be held in the 24 hours before the event and no later than two hours before the start. The time and place of the meeting must be stated in the Technical Guide. **ARTICLE 1.2.087** sets out rules for the times of meetings.

For World Cup competitions, this meeting must be held prior to the first event. (**ARTICLE 3.4.016**).

PROCEDURE OF THE MEETING

The organiser opens the meeting and welcomes those attending.

The PCP carries out the roll call of the teams. The PCP can use the communiqué prepared after the licence check that lists the teams/nations participating. Any team arriving after the roll call has finished is recorded as missing the meeting and must be issued the fine as indicated in the regulations.

The following chronology is recommended:

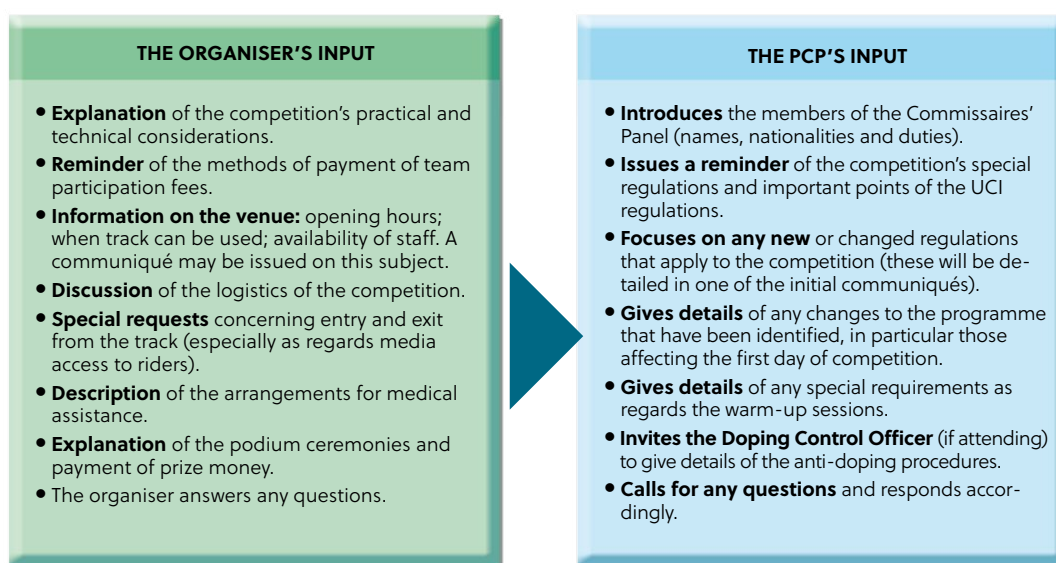

Diagram. Input by the organiser and PCP at the sport directors' meeting.

SPECIAL CASE

If there are any tensions between the teams, organisers or other parties, the Team Managers' meeting could take an unexpected turn. This meeting is one of the few official gatherings of the different parties.

When the PCP asks if the teams have any questions, certain individuals may use the meeting as a platform to bring up subjects that are not directly related to the arrangements for the competition. It is not acceptable for the meeting to be sidetracked; the PCP should refocus the discussion:

- without interrupting the intervention and in a polite manner,
- the PCP should invite those involved to organise another meeting and to desist with the debate,
- other individuals who want to continue the argument should not be invited to speak,
- the PCP should not favour one side or the other,
- in all cases, the PCP should remain calm and diplomatic to retain control of the meeting.



CHECK-LIST – Team Managers' meeting

- Place and time of meeting.
- Persons obliged to attend.
- Roll call of teams.
- Agenda of the meeting.
- The PCP's input with regard to important points.

NOTE

The PCP is the spokesperson for all the Commissaires. During the meeting the PCP alone should present all relevant sporting information. He or she must not permit the other Commissaires to be questioned, nor should the other Commissaires present any information during the meeting. This can lead to inconsistent messaging, and the PCP is responsible for the consistency of the team.



REQUIRED KNOWLEDGE

- What meetings should be prepared.
- Who leads each of the meetings.
- Who must be present at each of these meetings.
- The points that the PCP must check and approve during the meeting with the organiser.
- The points that the PCP must raise during the meeting with the team managers.
- The purpose of the meeting of the Commissaires' Panel.



WHAT TO DO

- Prepare input to the meetings.
- Find solutions to potential problems in a consensual manner.
- Be courteous and polite but remain firm.
- Anticipate any problems that could arise.
- Evaluate the resources made available for the competition.
- Explain and put the case for the real needs of the competition.
- Identify the tasks of those involved (organisation and Commissaires' Panel).
- Immediately intervene in non-compliant situations.



WHAT NOT TO DO

- Arrive at meetings without having prepared for them in advance.
- Refuse to enter into dialogue.
- Be lenient with the organiser if the material resources are insufficient or non-existent.
- Become uncommunicative and rely solely on the regulations.
- Allow meetings to be sidetracked by irrelevant interventions.
- Allow noted instances of non-compliance to continue without correction.



CHAPTER 8 THE RUNNING OF THE TRACK

To enable the safe and proper running of a track competition, as well as to ensure a successful outcome for the organiser, a number of activities are required that support the sporting component of the various events.

8.1. SAFETY OF TRACK ACTIVITIES

 The organiser is responsible for the safety of the competition (**ARTICLE 1.2.033**). However, the Commissaires still have a role in this regard. If a Commissaire sees something that is unsafe they must ask the organiser to rectify the matter. The Commissaires also have the right to take any measures necessary to rectify an unsafe situation, which can include stopping a race.

Even though the Commissaires have the right to intervene in an unsafe situation, this does not absolve the organiser from responsibility for the safety of the competition and facilities.

NOTE

Normally a member of the Commissaires' Panel would bring a safety matter to the attention of the PCP, who would then raise this with the organiser. In this way, the PCP remains the single point of contact with the organisation. However, in urgent cases that require immediate response, a Commissaire can make a request directly to the organisation.

The organiser's primary safety concerns are:

- that the velodrome, track and associated facilities are in good condition and present no danger to any party,
- that the programme does not present any safety issues.

NOTE

Safety is everyone's responsibility. Every stakeholder in the competition has a duty of care regarding safety.

ACCESS TO THE TRACK

The organiser is responsible for ensuring that only those people who need access to the track have this access. For this reason, the velodrome is normally divided up into different zones. These may include:

- Infield,
- Competition area (which includes the Safety Zone and racing surface),
- Finish Line,
- Spectator areas,
- VIP Zones,
- Permanence.



The organiser then uses an accreditation system to control access to the different zones. Competition area access is normally restricted to:

- Track Director,
- Competitors,
- Coaches,
- Commissaires,
- Track maintenance team,
- Medical personnel,
- Certain organisational technical staff (for example starting gate operators, Timing Company personnel, etc.),
- Certain media representatives (who are usually also required to wear distinctive bibs that are distributed by the organisation or UCI Press Officer. [See chapter 8.2](#)).

NOTE

A Commissaire can remove anyone from the track or Safety Zone at any time, even if that person has accreditation giving them access to that zone.

NOTE

Anyone working on the Safety Zone while a race is in progress should never walk along the zone with their back to the approaching riders. In the event of a crash they will not be able to react to move out of the way.

TRACK DIRECTOR AND SAFETY

The Track Director (Head of Track) is the key organisational person regarding the safety of the track. The PCP must be aware of who carries out this function at the competition.

The Track Director monitors the racing surface to ensure it remains safe for competition and that the Safety Zone is kept free of all technical equipment. The Track Director also ensures that medical staff are present during all official parts of the programme. This includes the racing as well as official training and warm up sessions.

The Track Director must work closely with the PCP and TD.

For additional information of the role of the Track Director [see chapter 5.3.2](#).

**REQUIRED KNOWLEDGE**

- Role of the organiser as regards safety.
- Role of the Commissaires as regards safety.

**WHAT TO DO**

- Verify that the organiser has an efficient accreditation system.
- Verify that only those who need to have access to the competition zone have this appropriate access.
- Identify the Track Director.
- Immediately inform the organisation about any unsafe conditions.
- Insist unsafe conditions are rectified.

**WHAT NOT TO DO**

- Ignore unsafe conditions as an organisational responsibility.
- Allow racing to take place under unsafe conditions.

8.2. MEDIA ACTIVITIES



Other than the requirement for the organiser to provide a proper reception for the media, there are no regulatory requirements regarding the media in the UCI Regulations for track cycling.

The relationship between the organiser, the UCI and the media is usually negotiated and agreed by all parties, with the UCI being the final authority. All members of the media must comply with the negotiated requirements.

Generally speaking, the media, organisation and the UCI, together with the Commissaires, work in a collaborative manner to ensure the best possible projection of the sport.

Ultimately, and irrespective of any prior decisions, the Commissaires may override any agreements to preserve the sporting fairness and regularity of the competition if the situation so arises.

GENERAL POINTS

All members of the media must immediately and fully comply with any instructions issued by the organisation or Commissaires. If the media do not comply with any issued instructions, sanctions can be applied.

The most important interaction between the Commissaires and the media involves access to, and working on the Safety Zone. The number of media personnel working in this zone must be restricted and any media representative given permission to work in the zone needs to be clearly identifiable. This is usually done by issuing distinctive bibs. The number of bibs and the control of their distribution is usually managed by the UCI Press Officer or the organisation. Information on the number of bibs and their description must be given to the PCP.

NOTE

The Commissaires may remove a media person from the Safety Zone at any time or restrict access.



Media personnel working on the Safety Zone may not place any equipment on the ground (i.e. it must always be carried), may not attach anything to the railings and may not sit, lie or kneel on the ground. The principle is that they must at all times be able to react to any incidents on the track and not pose a danger to riders having to use the Safety Zone.

Tripods and monopods are never permitted on the Safety Zone as they present a potential hazard.

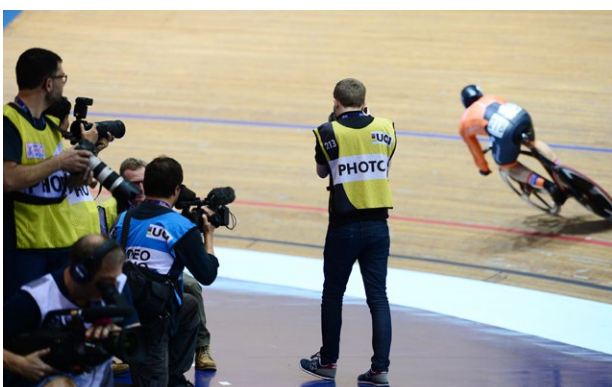

The media must work well back from the Blue Band. Generally, they should be no closer than midway between the Blue Band and the inside railing. They must also not obstruct the work of the Commissaires, Timing Company or coaches.

A media representative must never enter the track surface while a race is taking place.

The media must not be allowed to work in the team pit areas on the Safety Zone during bunch races.

While there is no provision for a meeting between the Commissaires, organisation and media, it is still a good idea to work with the organisation to ensure that the media are aware of any requirements and limitations.

**TIP**

The PCP or TD can mark out an area on the Safety Zone using tape, in which all media personnel are required to remain while the racing is taking place. This also includes taping a zone in front of the Secretariat to keep them out of this area. In larger competitions, it is also useful to tape a triangular zone after the finish line so that if a large number of photographers are working, they are kept back from the edge of the track for the race finish, but still given the opportunity to take their images.

TIP

If possible, the PCP should arrange a short meeting with the person from the organisation responsible for the media, together with the UCI Press Officer, to review any requirements prior to the start of the competition.

NOTE

At World Championships the PCP shall attend the photographers' briefing in order to remind them about the safety rules.

TELEVISION

Working with TV has two main components:

- the programme timings (schedule),
- the recording.

In order to anticipate the behaviour of the TV team, before the start of the competition the Commissaires should establish:

- if the coverage is live or filming is for a recorded programme or highlights package,
- the number of TV cameras working on the Safety Zone,
- the identity of the TV Floor Manager,
- whether the TV Floor Manager has the most up-to-date version of the competition programme.

The PCP, Secretary and Starter are often required to work closely with the TV Floor Manager to ensure that the programme runs according to schedule, especially if there are live TV feeds. [See chapter 5.1](#) for more information on the role of the Commissaires in keeping the programme on time.

NOTE

Working with the TV Floor Manager is a collaboration. The TV Floor Manager does not have the right to interfere in the sporting aspects of the competition. The PCP must ensure that this is properly respected. This includes issues such as not allowing the programme to be modified without prior notice and not allowing lengthy delays or insufficient recovery time for the riders.



There are no regulations regarding the number of TV cameras permitted to record the competition. Generally, most of the cameras are located outside the track. However, there may also be a number of TV cameras working on the Safety Zone. These are usually used to record images prior to the start and possibly at the finish.

The Starter must ensure that these cameras do not cause a delay to the start. The PCP and Commissaires should monitor their conduct to ensure that they do not interfere with the sporting element of the competition in any way.

PHOTOGRAPHERS

Depending on the level of the competition, it is sometimes necessary for the organisation to restrict the number of photographers having access to the Safety Zone. This is usually done by using different coloured media bibs. The Commissaires must know which colour bibs are allowed access to the Safety Zone and strictly enforce this.

It is common for the bibs to be rotated among the photographers present so that different photographers can have access for different days or sessions.

Generally, providing that photographers observe the comments of the General Points section, they may work anywhere along the Safety Zone (i.e. in any of the straights or bends). However, Commissaires always have the authority to remove any photographer from any position.



REQUIRED KNOWLEDGE

- The organisers need for the media.
- Awareness of the arrangements made for the media by the UCI and organiser.
- How to work with the TV Floor Manager.
- The role of the Commissaires in managing the media.
- The limits of media access to the track.



WHAT TO DO

- Ensure a cooperative attitude with the organisation with regards to the media.
- Identify the number, type and identification details of the media allowed access to the Safety Zone.
- Identify the TV Floor Manager.
- Mark out a media area on the Safety Zone.
- Be vigilant with regards to the behaviour of the media on the Safety Zone.
- Ensure no equipment is placed on the Safety Zone.
- Work with the organiser and UCI Press Officer to resolve any problems.
- Intervene immediately if the media fail to obey certain requirements.



WHAT NOT TO DO

- Allow the media to get too close to the Blue Band.
- Allow the media to affect the smooth running of the programme.
- Treat the media differently depending on their professional standing.
- Fail to issue any necessary reprimands.

8.3. MEDICAL SERVICES

BASIC PRINCIPLES

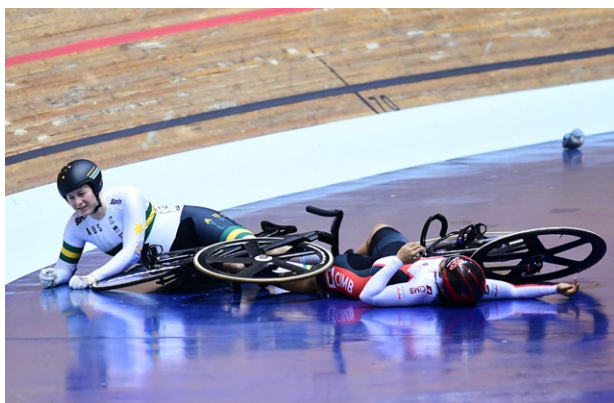

The medical assistance provided in a track competition should be of the highest standard and efficiency in all respects. Any delay, error or indecision could have serious consequences for the physical well-being of an injured person.

It is impossible to define rules to apply in all cases. Every intervention by the medical services varies depending on the severity and nature of the incident. Nevertheless, the following basic principles apply to all types of intervention:

- Medical care should be available as soon as possible after an accident or the appearance of symptoms.
- Evacuation to the most appropriate treatment centre should be conducted as quickly as possible.

Medical services are required during all official training, warm up and competition sessions.

HUMAN RESOURCES

The medical personnel comprise:

- A chief doctor, who specialises in sports or emergency medicine, and who has experience of cycle racing. The chief doctor acts as the general coordinator and should be supported by one or two assistant doctors.
- As a minimum, one ambulance, stationed at the velodrome, crewed by two qualified paramedics.
- A number of additional qualified paramedical assistants.

NOTE

The chief doctor, or any assistant race doctors, may not also be a doctor assigned to Doping Control.

TRANSPORT

The organiser is required to provide at least one ambulance.

It is usual for an organiser to provide two ambulances so that if an ambulance needs to transport a rider there is still an ambulance available at the velodrome. If there is only one ambulance, a second ambulance may be called to the velodrome to transport patients for non-serious cases.

EQUIPMENT REQUIRED BY MEDICAL PERSONNEL

The chief doctor gathers together all the equipment required to carry out the medical duties.

- All medical personnel, including the ambulance, must be linked by radio (on a reserved channel). As a minimum requirement, the chief doctor must also be able to directly contact the organisation management.
- Doctors on the ground should be equipped with mobile phones.

NOTE

In this specialised domain, the evaluation of medical equipment and the competence of medical personnel assigned to a competition is a difficult task for the Commissaires. The PCP may consult team doctors to enquire about any possible deficiencies in the service.

Certain points of reference can be used to assess whether the medical service is effective:

- the presence of more than one doctor,
- the presence of an anaesthetist in the medical team as well as resuscitation and defibrillation equipment,
- the availability of medical personnel before and after the competition.

INFORMATION IN THE TECHNICAL GUIDE

The Technical Guide should describe the competition's medical service and provide the telephone numbers of the medical personnel, as well as the emergency phone number for the country.

The guide should also include a list of hospitals to which riders will be taken in the event of serious injury. This list is checked in advance by the medical service: not all hospitals have the capacity to treat emergency cases. Some institutions may require notice of a track competition to ensure suitable staff members are on duty.

ABSENCE OR LACK OF AVAILABILITY

The PCP must stop an event during the competition if the medical service is entirely absent.

POSITION AT THE VELODROME



During all official training, warm up and competition sessions, the medical services team, including the doctor, should be stationed in a demarcated box in the infield together with a stretcher and other medical equipment. This box must be located near one of the ramps up to the Safety Zone so that the medical team can easily bring any required equipment on to the track.

NOTE

The medical team and their equipment must never be stationed on the Safety Zone.

In addition, there should also be a suitably-equipped First Aid room at the velodrome where treatment can be administered in private.

The ambulance should be stationed close to the velodrome to allow the easy evacuation of an individual from the track to the ambulance and then to a treatment centre.

INTERVENTION

The decision to intervene in a medical incident is always the responsibility of the chief doctor and medical personnel on site.

In the case of an accident during an event, it is the medical team's responsibility to respond to treat any injured athletes. The race is not automatically stopped.



The PCP, together with the Starter, must evaluate the situation to see if the race should be stopped to allow treatment. Things to consider are:

- the number of athletes injured,
- the position of the injured athletes in respect of the racing surface,
- the length of time providing treatment on the Safety Zone,
- the amount of medical equipment and number of medical personnel on the Safety Zone,
- the medically assessed severity of injuries,
- how the medical team will communicate with the Starter and PCP,
- event type,
- the stage of the race.

The following decisions can be made:

- allow the race to continue,
- temporarily neutralise the race,
- temporarily stop the race,
- end the race.

If the situation changes, the decision can also be changed.

If the decision is made to neutralise or stop the race, the Commissaires will decide, based on the event regulations, how to restart it, and what the positions of the riders will be.

If the decision is made to end the race, the Commissaires will decide, based on the event regulations, what the outcome of the race will be.

In the case that the race is allowed to continue while treatment is being provided on the Safety Zone, a Commissaire should be stationed in the corner before the treatment area indicating to the riders that they should take additional care.

If the ambulance leaves the velodrome to transport a rider, the PCP must check with the medical team that another ambulance is available at the venue.

NOTE

In the case of an accident, the Commissaire must never move the rider. The Commissaire can move any rider equipment away from the racing surface.



REQUIRED KNOWLEDGE

- The minimum composition of the medical service (personnel and resources).
- The management of a race in progress in the event of an accident requiring treatment.



WHAT TO DO

- Meet the members of the medical services before the start of the competition.
- Ascertain the location of the Medical Box on the infield.
- Ascertain the location of the First Aid Room.
- Consult team doctors on the effectiveness of the organisation's medical services in the event of any doubt.



WHAT NOT TO DO

- Ignore the risks if there is no ambulance or medical service team at the velodrome during an official session.
- Stop the race every time there is an accident requiring the attention of the medical service team.

8.4. TECHNICAL SERVICES

It is part of the organiser's responsibilities to provide a number of technical services, often using service providers, to support the Commissaires in the sporting aspect of the competition.

8.4.1.

THE TIMING SERVICE PROVIDER

The Timing Service Provider is appointed by the organiser and operates under the organiser's responsibility.

This service provider's mission is to supply, install and operate the technical resources used to provide information and judge the finish of an event:

- photo-finish equipment,
- transponder system,
- display equipment.

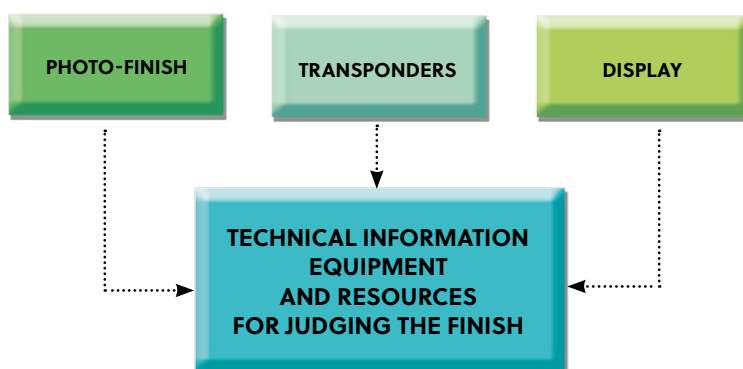

Diagram. Technical information equipment and resources for judging the finish

The Timekeeper and Finish Judge make sure that all the technical resources provided by the organiser and Timing Service Provider comply with the UCI Regulations and that the specifications established for the Timing Service Provider are observed.



UCI REGULATIONS

- For each race, the National Federation of the organiser shall designate a sufficient number of timekeeper-Commissaires duly licenced by it. Timekeeper-Commissaires may be helped in matters other than time-keeping operations proper by other persons licensed by the National Federation of the organiser (**ARTICLE 1.2.104**).
- Timekeeper-Commissaires shall record the times on a form that they shall sign and hand to the finishing judge (**ARTICLE 1.2.105**).

PHOTO-FINISH

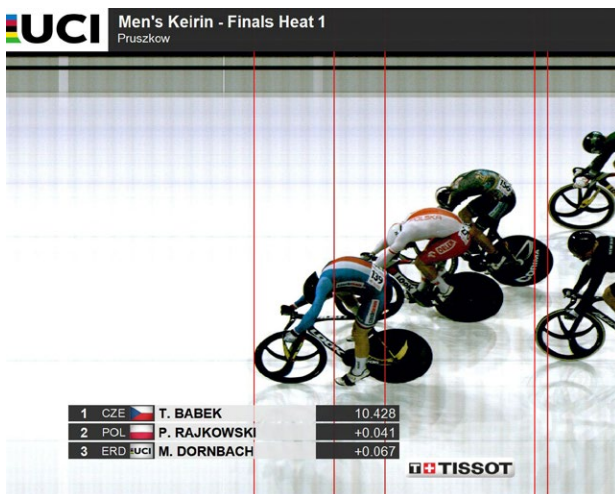

The photo-finish is the reference material that allows all competitors to be allocated a finishing position and time in a bunch event or event in which a time is taken from a particular rider in a team, for example, the Team Pursuit:

- a photo-finish comprises a series of high-definition photos taken one after another. These images are automatically time stamped in a very accurate manner,
- all photo-finish equipment must allow a time-indexed digital recording of images to an **accuracy of one thousandth of a second**,
- synchronisation: the photo-finish cameras must be connected to the official timing device,
- the official time used to draw up the classifications, other than in timed events, shall be that of the photo-finish. The exception to this is an event such as the Team Pursuit (see earlier comment).

TRANSPONDERS

This system identifies riders passing over a line and should be used to obtain a snapshot of the race at a specific point, thus allowing the composition of groups to be established. Transponders do not replace the obligatory use of photo-finish equipment.



While several transponder systems are highly accurate, there are still a number of limitations that must be noted:

- the position of the transponder on the bicycle is never exactly the same for all competitors.
- the orientation of the transponder within the detection field can be significant and can afford an advantage to an individual competitor.

Transponders must be attached to the bicycle on the front fork.

Transponders can be used to:

- quickly identify the passage of riders across the line (exact placings must be verified by photo-finish when this has an impact on the results),
- provide a provisional time,
- provide information to TV production.

DISPLAY



The display units on the scoreboard provide the riders, team managers and spectators with certain information on the race situation. The display must be accurate and kept up to date.

TIMED EVENTS



For any events where time determines the result, the timing system used is critical.

The times achieved by riders or teams must be announced by the Speaker and communicated via the scoreboard.

In events where times are recorded by the passage of a single rider across the line, the times are normally captured using a contact tape switch on the track. Depending on the event, the timing system is either initiated by the release of the starting gate attached to a start mechanism, or by contact with a tape switch. The timing system is stopped by contact with a tape switch.

Timekeepers also record times manually. If the electronic timing system fails, then the manual timekeeping is used.

The Timing Service Provider sends all the results to the Secretary for verification with the manually recorded times.

For the Team Pursuit, or any event where the time is based on the passage of a particular rider's wheel across the line, the photo-finish system is used to determine the time. In this case the photo-finish system and starting equipment is synchronised. The Timekeepers still continue to record backup manual times.

RECORDS

In the event of any world records being set, the electronic timekeeping data and manual timekeeping forms must be provided together with the record application form.

DRAWING UP THE RESULTS

The results are drawn up by the service provider, in collaboration with the Finish Judge and Timekeepers, and coordinated by the Secretary. However, the Commissaires are always responsible for race results:

- The Finish Judge is responsible for bunch races,
- The Secretary is responsible for timed events.

For bunch races, the Finish Judge must always personally examine the photo-finish even though the operator conducts this same process.

The results are compiled using software that complies with the UCI Regulations and all results must be approved by the PCP. This is usually delegated to the Secretary (see chapter 5.1.2). The Secretary also ensures that the Timing Service Provider modifies and reissues any results that are changed due to decisions by the Commissaires' Panel.

The results must be available immediately after the finish of the final rider in an event.

NOTE

The Timing Company is not responsible for copying and distributing the results ([see chapter 5.1.2](#)).



UCI REGULATIONS

- For Unless otherwise specified, the organiser must provide all the equipment required for the organisation of the event, including all timing equipment (**ARTICLE 1.2.035**).



REQUIRED KNOWLEDGE

- The role and functions of the Timing Service Provider.
- The limits of the timing systems in order to appreciate how they operate.
- Understanding the need to change results after decisions made by the Commissaires' Panel.



WHAT TO DO

- Maintain a good working relationship with the Timing Service Provider.
- Encourage cooperation between the Timing Service Provider and Commissaires' Panel.
- Explain the specific needs and requirements of the Commissaires' Panel.
- Provide feedback to the Timing Service Provider on any possible improvements based on experience or changed regulations.



WHAT NOT TO DO

- Fail to adopt a respectful, polite attitude towards the timing system operators.
- Assume that all operators are aware of the UCI Regulations and the specific needs of cycling.

8.4.2.

THE VIDEO REVIEW SERVICE PROVIDER

To support the work of the Judge-Referee, the organiser is required to provide a Video Review Service Provider operating under the organisation's responsibility.

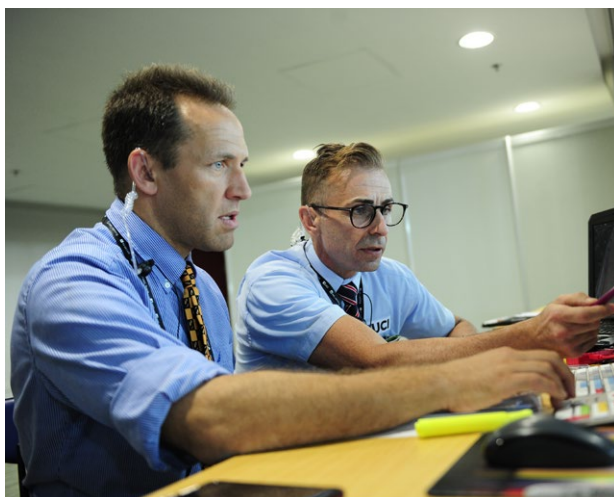

The Video Review Service Provider supplies the following equipment and personnel as a minimum:

- 1 video system operator who speaks English and can run the video camera and operate the playback system,
- 1 HP machine with ORS software,
- 2 monitors,
- 2 Sony PMW EX1 cameras with HD SDI output,
- SDI to HDMU convertor,
- peripheral cabling for PC and monitors,
- long coaxial cable to run to second monitor in Secretariat.

NOTE

Other equipment of the same or higher quality may be substituted for the above.

All equipment must be set up and checked by the Video Review Service Provider prior to the start of the competition. The Judge-Referee and PCP must check with the service provider that the equipment is functioning as it should be, and that all personnel are available (see also chapter 5.1.3). The Judge-Referee must confirm with the video system operator at what times the latter will need to be available during the competition.

The work done by the video system operator is sensitive since it involves decisions on events. The operator is not permitted to disclose any discussions entered into or overheard while working in the Judge-Referee area.

NOTE

It is important for the Judge-Referee to inform the Video Review Service Provider of the strict requirement for confidentiality.

The video system operator is required to film all events in which the Judge-Referee plays a role. Unless otherwise instructed by the Judge-Referee, the operator must follow the head of the race with the camera. Sometimes additional wide angle lens cameras may also be used to monitor the entire track. When following the bunch, or head of the race, the operator must keep the group of riders in focus, and must ensure that the relevant areas of the track are also within the frame, for example, the Sprinter's Lane.



TIP

It is good practice to show the lap count on the board in bunch races so that the situations observed can be better explained later.

The operator should mark any points in the recording when instructed to do so by the Judge-Referee so that these points may be easily found.

The footage being recorded should be transferred immediately to the review system. It should not be necessary to stop the recording in order to download the footage to the system. It is sometimes necessary to review footage in a race even while the recording is continuing.

At the Judge-Referee's request, the operator should be able to immediately play back any of the recorded footage to find specific incidents. This playback material must be displayed on a large monitor in high definition. It must be able to be played back at full speed and in slow motion, and it must be possible to freeze any part of the recording.

The Video Review Service Provider sometimes allocates two operators, one to capture the footage and the other to operate the review system.



REQUIRED KNOWLEDGE

- The role and functions of the Video Review Service Provider.
- The limits of any systems being used in order to adjust the approach appropriately.



WHAT TO DO

- Maintain a good working relationship with the Video Review Service Provider.
- Encourage cooperation.
- Explain the specific needs and requirements of the Judge-Referee and PCP.
- Explain the need for confidentiality.



WHAT NOT TO DO

- Fail to adopt a respectful, polite attitude towards the video review system operators.
- Assume that all operators are aware of the UCI Regulations and the specific needs of cycling.

8.4.3.**OTHER TECHNICAL SERVICES**

Depending on the level of competition and the events being run, the organiser will also provide several other technical services, either directly as part of the organisation or through additional service providers ([see also chapters 5.3.3 and 5.3.4](#)).

DATA PERSONNEL

These people work primarily with the Secretary. They ensure that the Secretary has access to a computer and printing facilities. They also ensure that all the necessary software for data management is installed.

INFORMATION DISTRIBUTION

These individuals also work mainly with the Secretary. They ensure that there are suitable copying facilities and that there is an information distribution system in place ([see also chapter 5.1.2](#)). They ensure that all communiqués are copied and distributed and provide a backup information system.

TECHNICAL EQUIPMENT OPERATORS

These individuals may be responsible for installing the technical equipment required at the track, although this is often the responsibility of the Timing Service Provider. In all cases the organisation remains responsible for ensuring that all required technical equipment is available, appropriate, functional and compliant with any relevant UCI Regulations.

These operators oversee the use of some of the equipment at the track, for example:

- Starting gate operators,
- Deryn driver.

**REQUIRED KNOWLEDGE**

- The role and functions of the various technical services provided by the organisation.
- The limits of any systems being used.

**WHAT TO DO**

- Maintain a good working relationship with all technical service operators.
- Encourage cooperation.
- Explain the specific needs and requirements of the Commissaires' Panel.

**WHAT NOT TO DO**

- Fail to adopt a respectful, polite attitude towards the technical service operators.
- Assume that all operators are aware of the UCI Regulations and the specific needs of cycling.



CHAPTER 9
THE TRACK DISCIPLINES



After all the checks have been made and all meetings with the organisation have been held in advance of the competition (often on the day before the first event), the main part of the competition commences. While all the preparation work is critically important if the competition is to be successful, it is during the actual competition itself that most of the Commissaires' work occurs.

9.1. GENERAL CONDUCT

The sport of track cycling is made up of a lot of different events, each of which has its own regulations. There are common elements in the regulations that apply to different types of event. There are also regulations and behaviours required of riders that apply to all events.

9.1.1.

GENERAL RIDER BEHAVIOUR



COLLUSION

Collusion between riders is always forbidden, even if the riders are from the same team. This does not mean that riders cannot cooperate with each other. In many cases, it is mutually beneficial to work with one another. This is permitted. It is working together in a way that is likely to hinder the conduct or distort the result of a race that is forbidden. This is collusion (**ARTICLE 3.2.002**).



Example

- Two riders in a Points Race escape from the field. The two riders take turns pacing while off the front. This behaviour is permitted. It is mutually beneficial for riders to work together to stay off the front of the race.
- A rider in a Points Race escapes from the field and is approximately three-quarters of a lap up on the field. Another rider drops back from the bunch to join the first rider and then helps him lap the field. This behaviour is forbidden. A rider cannot drop back off the bunch with the purpose of helping another rider lap the field. This is collusion.

NOTE

In the case of collusion, it is possible to penalise both the rider offering the benefit and the rider receiving the benefit.



CONTROL



Riders must always be in firm control of the bike with at least one hand on the handlebar (**ARTICLE 3.2.002**). This is especially important in bunch races where riders need to be ready to react to unforeseen circumstances on the track. Even if the rider is alone, he or she is still required to adhere to this requirement.

Riders are not permitted to simply rest their wrists on the handlebars in order to control the bike. They are also not permitted to use a single finger to control the bike. A hand must be on the bars.

It is common to see riders with wrists on the top of the bars and fingers curled around the front of the bars. This is permitted.



Commissaires must react immediately if they see a rider not in control of the bike. They can indicate to the rider concerned to hold the bars, perhaps using a whistle to gain their attention. If the behaviour persists, a rider can be warned or even disqualified. It is also possible to immediately warn or disqualify a rider if the situation warrants this.

NOTE

Pay attention to the finish of the race where a rider may raise both arms after winning. This situation must be approached with care. It is acceptable unless the rider endangers other riders by this action.



DISTINGUISHABILITY



It must always be possible to easily tell the difference between two riders on the track. This means that if two riders are wearing the same clothing, including gloves, shoes and helmet, they should have something on them that allows you to distinguish between them (**ARTICLE 3.2.003**).

The Starter must insist that there is something distinguishable about the riders and communicate the difference to the rest of the Commissaires' Panel. It is the riders' responsibility to wear something distinguishable.

It is usually possible to tell the difference between riders from the same team as they will be wearing different helmets, gloves or shoes. However, if everything is identical, a possible solution is for one of the riders to wear an armband.



PROGRESSION THROUGH ROUNDS

Many track events have rounds of racing, or heats. For example, the Keirin has a Qualifying Round, Repechage, Second Round and Final. When riders enter an event, they are required to race all the rounds or heats for which they qualify (**ARTICLE 3.2.004**). If a rider qualifies for a following round, or is in a specific heat and then does not participate, that rider is normally disqualified from the entire competition.

NOTE

This is a disqualification from all the events of the competition.

As an exception, if a rider does not take part due to reasons outside his or her control, the rider is not disqualified. These exceptional reasons are usually accident or illness. The rider, or the rider's team, must produce a medical certificate signed by the race doctor confirming that the rider is not able to continue in the event. In many cases, the rider will withdraw from the entire competition. However, if a certificate has been properly issued, the rider shall not be entered for any other event for a minimum of 48 hours from the moment of the specific race.



Example

If a rider qualifies to ride in the Second Round of the Keirin and is also entered in the Sprint, but then withdraws from the Keirin without submitting a proper medical certificate, the rider is disqualified from both the Keirin and the Sprint events.



ATTACHED ITEMS

Riders are not allowed to carry anything that could fall onto the track on their persons or on their bicycles (**ARTICLE 3.2.005**). This means that all equipment components and all items of clothing need to be securely fastened. Items falling on to the track pose a danger to other riders.

Some examples of items that must be securely attached are helmet visors and electronic data recorders. All of these items are permitted, but if used, need to be firmly attached in such a way that they cannot come loose and drop on to the track.



USE OF THE BLUE BAND

Riders are not allowed to use the Blue Band in the race unless they ride onto it involuntarily. If by using it they gain an advantage then they should be relegated or disqualified (**ARTICLE 3.2.008**).

It is fairly common in certain events for riders to use the Blue Band, for example, in the first part of the Sprint event. Commissaires should tolerate this behaviour.

Likewise, if, for example, a rider in the Pursuit momentarily rides on to the Blue Band, this should also be tolerated. It is unlikely a rider can gain an advantage in this kind of event by riding down on to the Blue Band.

The intention of the rule is to stop riders deliberately using the Blue Band to gain an advantage. If they do so, the Commissaires must intervene. Every situation should be quickly and carefully analysed by the relevant Commissaire before making a decision.

NOTE

On longer tracks with shallow bankings, it may be possible for teams in the Team Pursuit and Team Sprint, and riders in the Individual Pursuit and Time Trial events to deliberately ride on the blue band for longer periods of time to gain an advantage. This is strictly forbidden.



Example

In the Sprint event, with two riders sprinting for the Finish Line, the rider on the inside comes out of corner 4 and rides on to the Blue Band, crossing the Finish Line on the Blue Band. Generally, this should be tolerated.



Example

In the Elimination Race, a rider near the back of the bunch at the start of the elimination lap rides down on to the Blue Band to advance a few places forward. This must not be tolerated



Example

In the Points Race, with the Bunch coming out of corner 4, a rider in the middle of the bunch moves down the track, forcing riders who were about to pass underneath down on to the Blue Band. Since the riders did not deliberately attempt to use the Blue Band to gain an advantage this should be tolerated.



Example

In the Team Sprint, just after the start, the team moves down on to the Blue Band and rides through corners 1 and 2 and partly down the back straight before coming back on to the track. In this case the riders have deliberately used the Blue Band to gain an advantage. This must not be tolerated, and the team must be disqualified.

9.1.2. ELECTRONIC EQUIPMENT AND DISPLAYS

 Riders are never allowed to wear any form of headphones on the track, even if in one ear only. This includes for the purposes of radio communication or for music (**ARTICLE 3.2.005**). This requirement applies to competition, training and warm up sessions. Other radio transmission equipment that can be used to communicate with the riders is also prohibited. For example, it is not permitted for a rider to have a light or buzzer system on the bike that a team member could use for communication.

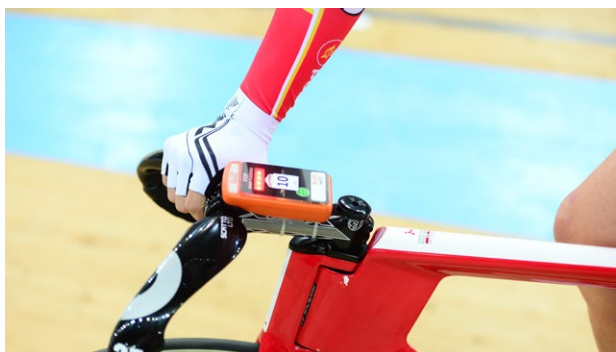

NOTE

The organisation or UCI can require a rider to use an electronic system in order to manage the sporting aspect of a race. An example of this is the electronic light system used in the Elimination Race to indicate to a rider that he or she has been eliminated. The management of these systems falls under the control of the Commissaires' Panel.

 Additionally, riders are not allowed to have any electronic device on the bicycle that provides them with an information display (**ARTICLE 3.2.005**). Devices that store and transmit this information are permitted if properly fixed to the bike. However, if they do have a display, it must be blocked from the rider's view. An example would be to tape over the display making it unreadable. Commissaires must be vigilant to make sure that any such displays are covered and remain covered.



NOTE

To help produce exciting television images, it is becoming increasingly common to ask the riders to carry on-board cameras on their bikes during the competition. Any such requests need the approval of the teams, riders and the UCI. The cameras used must be approved by the UCI in all cases and must be attached to the bikes with accessories provided by the camera manufacturer.



9.1.3. STOPPAGES

STOPPING THE RACE



A rider cannot have a race stopped due to the belief that he or she has suffered some form of incident (**ARTICLE 3.2.006**). It is solely the decision of the Commissaires whether or not to stop a race.

NOTE

It is important for Commissaires to be proactive rather than reactive. They must not wait for an appeal before making a decision.



Example

During the Keirin, after the first lap, a rider touches the wheel of another rider and falls. She slides off the track onto the Safety Zone. Since the incident happened after the first half lap the race is not stopped. However, the rider drags herself back up onto the Blue Band to force the race to be stopped. In this case the Starter stops the race since it is now unsafe. The rider who crashed is not permitted to restart and in addition is penalised for forcing the race to stop. All the other riders restart.



CRASHES

In a bunch race, if a rider crashes or suffers a recognised incident, in many cases he or she is allowed to receive assistance and return to the race (**ARTICLE 3.2.007**). Depending on the event, the rider may be allowed a number of neutral laps to return. Near the end of an event, the rider may not be allowed to return to the track. All these cases are discussed in detail in chapter 9 in the descriptions of the respective events.

In cases where the rider is permitted to return, he or she must return to the track from the place where he or she left it. The rider must join the same group that he or she was in at the time of the crash or incident.

Sometimes the group the rider was in changes before the rider can return to the track. The Commissaires must clearly indicate to the rider which group to join. In all cases, the Commissaires' decision on the group is final.



Example

A rider in a leading group of six crashes. After the crash the group splits into a front group of two riders and a chasing group of three. The rider should return to the group of three since this is the main group. It cannot be assumed that the rider would have gone with the leading group and so he cannot be given this advantage.



Example

A rider in the leading group of two riders crashes. After the crash, the rider she was with is caught by a group of four riders. Two of the four riders then attack. The crashed rider should return to the group with the rider she was riding with before the crash.



Example

In the Elimination Race, with 16 riders on the track, a rider crashes. The race is neutralised. At the end of the neutral laps the rider has still not returned to the bunch. The race is restarted and the crashed rider is eliminated.



Example

A rider in a leading group of 5 riders crashes. After the crash the group catches the main field and is deemed to have lapped the field. The rider should return to the main field and is also given the lap since the group the rider was with is now in the main field. If the group had not lapped the field, but been just behind them, the rider would have been returned to the group, and then lapped the field with them. This is why the rider is also given the lap.

NOTE

The decision to which group a rider returns can be easy or difficult. The Commissaires' decision must always be based on fairness, without either giving the rider an unfair advantage or an additional disadvantage.

The number of neutral laps the rider takes is counted based on the number of times the group the rider was part of passes the point at which he or she left the track. The rider must be back in the group before the permitted number of neutral laps has been completed.

A rider is only considered to be back in the race when rejoining the group he or she was with at the time of the incident; the Commissaire must continue to count the laps out until the rider is back.

For all bunch races, the maximum number of neutral laps a rider may take is the number of laps closest to 1250 m. On a 250 m track this would be 5 laps. Additionally, no rider may return in the final 1 km.

NOTE

Commissaires must not put a rider back into the race if in doing so he or she would be considered lapped in an event that requires lapped riders to be withdrawn.



TIP

The Commissaire monitoring the incident and the return of the rider to the track, should hold up a hand and clearly count and display the number of laps the rider has been out. The laps should be counted up since this way you can immediately tell how many laps the rider has been out.

9.1.4. WARNINGS, RELEGATIONS AND DISQUALIFICATIONS

In track cycling, a warning is a serious action. Commissaires should decide carefully when a warning should be issued.

 The use and application of warnings, relegations and related disqualifications is described in **ARTICLE 3.2.013**.

Warnings are usually issued for unsporting conduct if no other penalty is applicable. If a rider receives two warnings in an event he or she is automatically disqualified. If a rider receives a warning, this is carried through the various rounds of the event.

Example

A rider receives a warning in the first round of the Sprint event. The same rider then receives a warning in the semi-final of the Sprint. Since both these warnings were issued in the same event in the same competition, the rider is automatically disqualified from the Sprint.

Example

A rider receives a warning in the second round of the Sprint event. The same rider then receives a warning in the first round of the Keirin in the same competition. These warnings have been issued in different events, so the rider is still able to participate in both events.

Example

A rider receives a warning in the Scratch Race that is part of the Omnium. The same rider then receives a warning in the Points Race in the Omnium. Since both these warnings were issued in the same event (the Omnium), the rider is automatically disqualified from the Omnium.

NOTE

It is very important for Commissaires to consider the use of a warning. If a warning is issued for a relatively minor action early in an event, for example in the first round of the Sprint, it severely impacts the behaviour of the rider in later rounds, as well as limits the Commissaires' ability to take action for later incidents. While it may sometimes be necessary to disqualify riders in a final, this should be reserved for serious cases. If the Commissaires have been issuing warnings for minor actions, this increases the risk that, to ensure consistency, riders could be disqualified in finals for minor offences.

Commissaires may also choose to relegate a rider. In this case, a decision must be made whether to issue a warning at the same time. This is not a requirement. If a rider is relegated for an action in which his or her behaviour was not intentional or dangerous, then the rider should not be warned. Warnings must be reserved for serious cases.

A rider who has three relegations in the same event is automatically disqualified.



Example

In a Sprint event a rider receives a relegation with a warning in the semi-final. In the final of the Sprint event the rider receives another warning. Since the rider has received two warnings in the Sprint event he is automatically disqualified.



Example

In a Points Race a rider is relegated without being warned in an intermediate sprint. Later in the same race the same rider is given a warning for unsportsmanlike conduct. This rider is not disqualified as only one warning has been received in the Points Race.

Commissaires may also choose to immediately disqualify a rider. This is reserved for the most serious cases. They are not required to warn the rider before the disqualification.



TIP

Commissaires must consider intent and impact before making decisions on warnings, relegations or disqualifications.

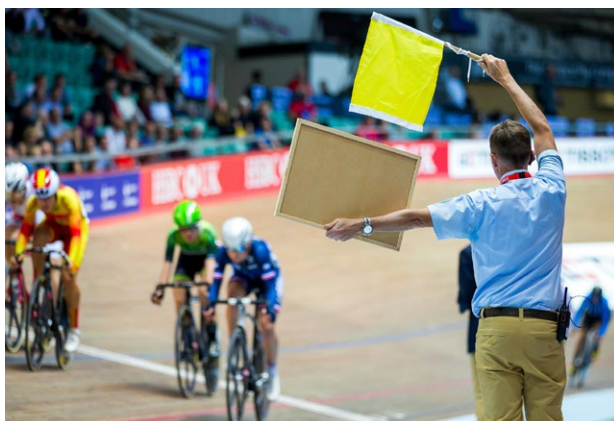

Whenever a warning, relegation (with or without warning) or disqualification is issued, this is communicated by the PCP (no matter who makes the decision) and must be announced by the Speaker.

In bunch races a warning is announced by the Speaker and also displayed to the rider and personnel in the Team Pit area. This is done by writing the number of the rider on a whiteboard, and displaying this, together with a yellow flag, to the rider and Team Pit area. Normally the PCP is responsible for this.

In bunch races a disqualification is shown in a similar manner, except that a red flag is used.

A rider who is disqualified must immediately leave the race.



TIP

When displaying the whiteboard for warnings or disqualifications to the pit area, wait until the riders are on the home straight before showing the board to the back straight since it is more likely that the Team Managers will be looking in your direction at this time. You can also get your back straight Commissaire to inform the relevant Team Manager.

Commissaires should not issue warnings to riders who have already been eliminated. In many cases the eliminated rider will not pay any attention to this. If necessary, the Commissaire should speak directly to the rider if a behaviour needs to be corrected. By issuing a warning in this case, the Commissaire also restrict the way in which they may decide a similar incident when the consequences could be different.

9.1.5. RECOGNISED VERSUS UNRECOGNISED MISHAPS

Depending on the event, Commissaires are sometimes required to make a decision based on whether a rider has had a recognised or unrecognised mishap.



The following are considered recognised mishaps (**ARTICLE 3.2.021**):

- legitimate falls,
- punctures,
- breakage of an essential part of the bicycle.

All other mishaps are considered to be unrecognised.

In all the above cases, the decision of the Commissaires whether or not a mishap is recognised or unrecognised is final.

NOTE

In the Regulations, the words mishap, accident and incident are sometimes used interchangeably.



Example

A saddle coming loose is not considered a recognisable mishap since it is not a breakage and is preventable.



Example

A saddle breaking off a saddle post is considered a recognisable mishap since this is a breakage of an essential part of the bicycle.

NOTE

If the event requires a determination whether or not a mishap is recognised, it is important for the Commissaires to be alert to this and to quickly get to a bicycle where there has been a mishap in order to check it. This is an important role for Pit Commissaires, Corner Commissaires and Back and Home Straight Commissaires.

9.1.6. DELAYING THE START



Riders and their personnel are not permitted to delay the start of any race (**ARTICLE 3.2.017**). If a rider delays the start, the Starter needs to check whether the reason for the delay is acceptable. If it is not, the Starter can warn or fine the rider or not allow the rider to start.

Teams must always be ready at the start line with essential spares in case of a mechanical incident just prior to the start. Such spares include wheels, tools, toe straps, etc.



Example

Just before the start of a Pursuit race, a rider has a puncture. The team has a spare wheel on the Safety Zone. The start is delayed while the team changes the wheel for the rider. This is tolerated since spares were readily available.



Example

Just before the start of a Pursuit race, a rider has a puncture. The team has no spares on the Safety Zone. The bicycle is taken back to the team box so that the wheel can be changed. This should not be tolerated. Depending on the length of the delay, the rider can be fined, or if the delay becomes too lengthy, the rider is not permitted to start.

NOTE

The option to not allow a rider to start should be reserved for very serious cases where the delay is extremely lengthy.

**NOTE**

Commissaires must take care in team events, such as the Team Pursuit and Team Sprint, that the mechanic or manager is not holding back loading the bicycle for rider 1 into the starting gate while the rest of the team gets ready. If the manager/mechanic is deliberately delaying the loading of the bicycle, this is considered delaying the start and must be dealt with by the Starter, usually by a fine, or in serious cases, a warning.

**REQUIRED KNOWLEDGE**

- General rules of conduct for all track events and for when riding on the track.
- How electronic communications and display systems may be used by riders on the track.
- Management of riders returning to the track after a mishap.
- The use and impact of warnings, relegations and disqualifications.
- The difference between recognised and unrecognised mishaps.
- The events in which it is important to distinguish between recognised and unrecognised mishaps.

**WHAT TO DO**

- Ensure the general rules of conduct are appropriately enforced, no matter what the skill level of the riders.
- Monitor all official sessions of a competition for proper adherence to the general rules of conduct.
- Check any electronic display system prior to a race start to ensure that it cannot be read by the rider.
- Monitor laps out for riders suffering a mishap.
- Clearly communicate the number of laps out for a rider suffering a mishap.
- Consider impact and intent before issuing any warnings, relegations or disqualifications.
- Be consistent in applying warnings, relegations and disqualifications.
- Keep a record of the number of warnings and relegations issued to riders in each event.
- Be proactive in verifying whether a mishap is recognised when the decision is based on this verification.

**WHAT NOT TO DO**

- Allow riders to ignore the general conduct regulations during warm up and official training sessions.
- Issue warnings for minor incidents.
- Issue warnings to riders who have been eliminated.
- Punish every instance of riders riding on the Blue Band.
- Permit riders to ride with loose bicycle components or clothing that could fall onto the track.
- Allow riders who have lost too many laps to return to the track after a mishap.
- Allow riders or team members to delay the start

9.2. SPRINT EVENTS

Track events can be divided into four broad categories, the first of which involves the sprint events.

All Commissaires must have a good knowledge of the general tasks and functions of the various Commissaire's roles, as described in chapter 5 of this guide. This section only describes the roles of Commissaires where these are different, or unique, compared to the information provided in chapter 5.

The general requirements for the track set up, as well as descriptions of track equipment and installations, are provided in chapter 3.

Equipment requirements are explained in more detail in chapter 11.

9.2.1.

FLYING 200 M AND FLYING LAP EVENTS

 The Flying 200 m (**ARTICLES 3.2.022 to 3.2.028**) is never usually run on its own but is part of the Sprint event. The way in which this event is conducted has an impact on the Sprint. Nevertheless, it is still an important event in its own right, and a World Record can be established. This means it needs to have a rigorous setup and control.

 The Flying Lap (**ARTICLES 3.2.253 to 3.2.258**) is run in very much the same way, except that it is a stand-alone event. The main differences are the length of the event, and the way in which ties are broken.

Unless otherwise noted, all the information below is for the Flying 200 m. The information for the Flying Lap is identical, except that the timed distance is over the final lap ridden.

9.2.1.1. Event Overview

This event is a timed distance event and consequently the track setup and work of the Commissaires must primarily reflect this. This means that:

- The distance must be controlled,
- The timing must be controlled.

At the same time, any unusual situations must always be resolved taking into account the fundamental duty of fairness.

The timed distance for this event is the final 200 m of the total distance ridden. Riders are allowed to build up speed before their flying start. The rider usually starts on the back straight and is given a certain number of laps to build up speed depending on the length of the track. The number of laps indicated in the regulations includes the final 200 m.



Example

- On a 250 m track a rider will ride 3.5 laps, which includes the final 200 m.
- On a 333.3 m track a rider will ride 2.5 laps, which includes the final 200 m.

As this is part of the Sprint event, the equipment used must be that permitted in the Sprint. This means, for example, that a rider is not permitted to add extensions to the handlebars. The rider can however wear an aero helmet as this can also be worn in the Sprint. One exception to this is that a rider is permitted to use a front disc wheel in the flying 200 m, whereas this is not permitted in the Sprint event.

NOTE

A rider is not required to use identical equipment in both the Flying 200 m and Sprint events. The only requirement is that the equipment used must be permissible in the Sprint.

Since this event is considered part of the Sprint, riders are required to wear two body numbers.

9.2.1.2. Track Setup

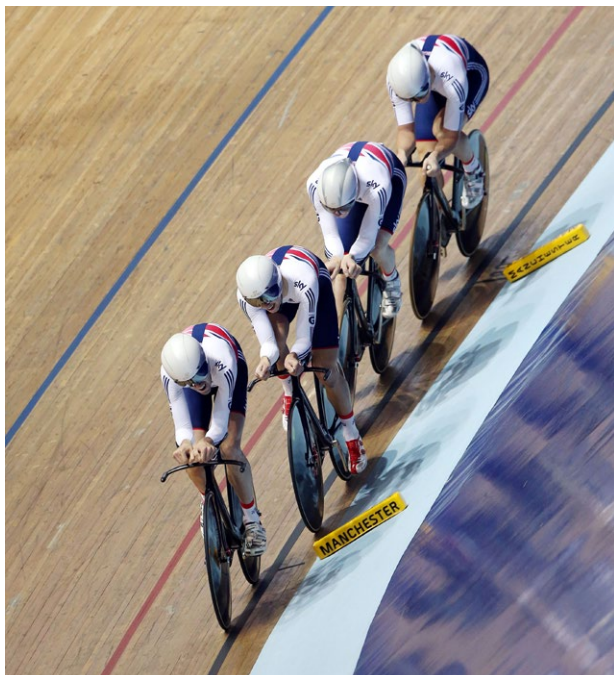

As this is a distance event, foam pads must be used to control the distance. The pads must be placed on the Blue Band all the way around the track for the length of the timed distance. This means that only the length of the track after the start of the 200 m distance has pads. The first pad is always placed at the 200 m line.

The pads must be placed on the Blue Band, starting from the inside edge of the Blue Band, every 5 m through the bends and along the straights. The principle is to make the Blue Band unrideable.

Example

- On a 250 m track it would usually only be corner 1 that would not have pads.
- On a 200 m track the entire length of the track would have pads.

The finish is always on the Finish Line and the timing must be accurate to 1/1000 of a second. This means that electronic timekeeping is a requirement; for records, it is essential.

The usual electronic timekeeping system involves placing contact tape switches on the 200 m line, the 100 m line and the Finish Line. The reason for the 100 m line is that in the event of a tie, the time taken over the final 100 m is used to break the tie.

When setting up the contact tape switches, these should ideally extend down onto the Blue Band since riders do sometimes drift down into this zone, and this behaviour is tolerated. Without the tape switch in this zone, a rider would not record an electronic time.

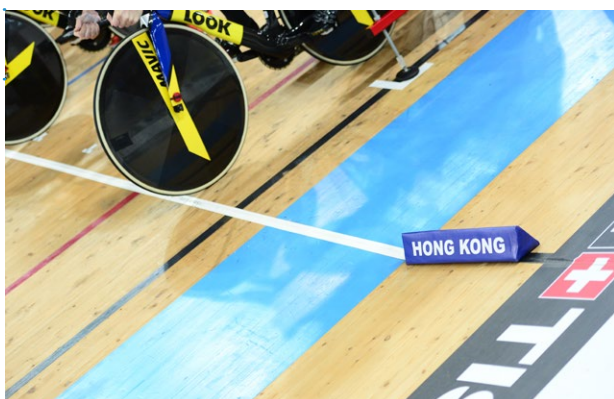

TIP

In some cases, it is not possible to extend the tape switches down into the zone due to cabling that has been prewired into the track. In these cases pads should be placed from the inner edge of the Blue Band just before the various tape switches to prevent the rider riding under them.

9.2.1.3. Start Order

The starting order of riders is drawn up by the Commissaires' Panel. Usually this is done by the Secretary, delegated by the PCP. Depending on the level of the competition (for example World Championships or World Cups), the riders may be seeded on different criteria, including:

- UCI Sprint Ranking,
- defending champions,
- series leaders.

The general principle is that the best riders always start last. However, the Commissaires' Panel always has the right to modify the seeding.

In some cases, the start order may be completely random.

The start order for the Flying Lap is usually compiled by the Commissaires' Panel by means of a random draw. However, UCI rankings may also be considered.

9.2.1.4. Race Conduct

START PROCEDURE



The start of this event is usually in the back straight with the Starter normally located near the Pursuit Line.

Each rider is required to come to the start line with a holder. The Assistant Starter must ensure that there are always riders ready to start. The riders wait on the Safety Zone lined up against the railing in the start order. There should be no more than 5 or 6 riders on the Safety Zone waiting to start to avoid the situation where riders are waiting around the bankings. This should be managed by the Assistant Starter.



Once the Starter gives a rider the start, the rider's holder pushes the rider on to the track to get him or her rolling.

The rider then builds up speed until the final timed distance.

As soon as the rider passes the Starter on the back straight for the final time before the finish, the Starter gives the next rider the start.

NOTE

Commissaires must not allow riders to use the Safety Zone for an excessive amount of time to warm down after their ride.

BREAKING TIES

In the Flying 200 m, if there is a tie in the times, the rider with the tied time who rode the fastest over the final 100 m is given the better place. If after this the riders are still tied, then lots are drawn by the riders to determine the better-placed rider.

If for some reason there are no 100 m times, then lots are drawn to determine the better-placed rider.

NOTE

It is critical to check the results for ties, and to break them correctly, since the rankings from the Flying 200 m determine the seeding for the Sprint as well as potentially who qualifies and who does not qualify for the Sprint.

For the Flying Lap, ties are broken in the same way, except that the fastest time over the final 200 m is used. If the distance of the lap is 200 m or less, then lots are drawn to break the ties.

MISHAPS

In the case of any type of mishap a rider is allowed a restart. Each rider is only allowed one restart for this reason.

The PCP must decide where in the starting order the rider will restart. The PCP takes into account the following considerations in this decision:

- The nature of the mishap,
- How many riders are still left to start.

The PCP must communicate the decision to:

- Rider coach/manager,
- Speaker,
- Timing Company,
- Starter,
- Timekeepers.

Ideally riders who suffer mishaps should not be the last riders to start when they restart, but sometimes this is unavoidable.

9.2.1.5. Specific Commissaire Roles



See also chapter 5 for the general duties of all Commissaire roles at track competitions.

SECRETARY

The Secretary must monitor the times recorded to identify any ties and ensure that they are broken correctly.

Using the times recorded in the Flying 200 m, the Secretary can quickly prepare the start sheet for the first round of the Sprint and use this to check the start sheet created by the Timing Company.

STARTER

The Starter is normally located on the back straight near the Pursuit Line and works with an Assistant Starter. The Assistant Starter ensures that there are always riders ready to start and lined up in the correct order on the Safety Zone with their holders.

The Starter makes a final check that the correct rider is ready to start, quickly reviews the rider's equipment and numbers and then gives the rider the start once the preceding rider on the track has passed for the final time before finishing. The start is given verbally.

If there are any issues with the rider, the Starter can refuse to start the rider or inform the PCP.

The Starter must always monitor the conduct of the riders on the track and be ready to stop the event if necessary, for example in the case of an accident.

TIMEKEEPERS

Timekeepers must manually record all the riders' times. This includes taking a split time on the 100 m line.

Ideally there should be two Timekeepers recording the time of each rider.

The Timekeepers are required to maintain backup manual times and check the electronic timekeeping.

OTHERS

The Lap Board Operator must remain focused on the riders on the track and be ready to change the lap board from a rider who has just finished to the rider just starting.

Corner Commissaires should be available to replace any pads that may be hit or moved by the passing riders.

NOTE

During events volunteers must not be placed in the corners to replace pads. This is a role for Commissaires.

9.2.2. SPRINT



The Sprint event (**ARTICLES 3.2.029 to 3.2.050**) has a number of important technical regulations that riders use in order to gain a tactical advantage. Application of the regulations in this event can be quite complex.

9.2.2.1. Event Overview

In order to qualify for the Sprint event, riders are first required to compete in the Flying 200 m event. The results of that event determine the seeding for the Sprint event.

In order for the Sprint competition to take place there needs to be at least the following:

- a minimum of 8 riders participating,
- a Flying 200 m event to seed the riders,
- straight up quarter-finals (this means one ride only),
- semi-finals ridden as the best of three heats,
- finals ridden as the best of three heats.

NOTE

Normally the quarter-finals are also ridden as the best of three heats. This is a requirement for all major competitions.



The composition of the series is shown in the table in **ARTICLE 3.2.050**.

For major competitions, 28 riders qualify to ride the Sprint event. In other competitions, the same table can be used starting with fewer qualified riders, ideally either 16 or 8 riders.

NOTE

It is possible to qualify a different number of riders than 8 or 16, but Commissaires should take extra care with the composition of the heats to make sure that the format of the series is properly followed.



The general principles of the event are:

- two riders compete against each other in each round,
- from the quarter-finals through to the finals the riders race against each other in two heats, with a third deciding ride if the riders win one heat each,
- the winners of the round move through to the next round,
- the losers of the round are ranked according to their Flying 200 m times and at this point are eliminated from the event. However, for the final four riders, the losers of the semi-finals face each other to race for third place.

In the final round, the heat for the race for third place always takes place before the heat for the race for the first place.



Example

The winners of the round of 16 riders advance to the round of 8 riders. The losers are ranked from 9th to 16th place according to their Flying 200 m times. In the round of 8 riders (quarter-finals), the winners advance to the round of 4 riders (semi-finals) and the losers are ranked from 5th to 8th place according to their Flying 200 m times.

9.2.2.2. Track Setup

There should be no equipment on the Safety Zone during the Sprint event.

No additional track setup is required.

9.2.2.3. Start Order

The start order is based on the results of the Flying 200 m. The fastest riders are given the highest seeding in the Sprint event.

The general principles in the composition of the series is that the highest seeded riders are given the best opportunities in the Sprint event.

Additionally, in the first round, it is sometimes necessary to allow some riders (always the highest ranked) to proceed to the next round without competing in this round.

9.2.2.4. Race Conduct

On tracks of less than 333.3 m, the race is run over 3 laps. On tracks of 333.3 m and longer, the race is run over 2 laps.

The race is essentially run in three phases:

- The first half lap,
- Preliminary phase,
- Final phase – with the sprint engaged.

From a race tactics standpoint, where each phase starts and ends depends on the riders.

THE START



The riders who are due to start need to be ready in the waiting area near the ramp. This must never be on the track. The riders are not permitted to wear tinted visors or glasses until they move up to the track. This is especially important when there is television as it makes identifying individual riders difficult. For consistency, this regulation is applied at all competitions. The Commissaires working near the start line should monitor the riders for this.

The Assistant Starter conducts the draw with the riders to determine which rider will start on the inside of the track (the rider who draws position 1). The Starter is informed of the result of the draw.

In the case where three heats are required to determine who is the winner of the round, for example in the quarter-final, semi-final or final, the order of the riders is reversed in heat 2. If a heat 3 is required, a new draw is made.



When the previous race has finished, the Starter calls the next heat to the start line, which is the Finish Line. The riders come to the line with their holders. The Starter must make sure that the riders do not take too much time in coming to the start and checks that the riders are in the correct order.

NOTE

There is no obligation for the rider who drew the number 1 position (rider 1) to be down near the Sprinter's Lane. Rider 1 can take up a position up the track, as long as enough space is left for the opponent above.



Once the riders are in position on the start line, being held by their coach/manager, the Starter must check that the riders are ready. This is normally done by walking up to the rider at the top of the track and asking if he or she is ready and then moving down to the next rider and asking the same question.

Once the riders are ready, the Starter gives the start by blowing a whistle. The Starter must have a loaded starter pistol ready in case it is necessary to stop the race.

NOTE

After starting the race, the Starter must not turn his or her back on the riders.

As soon as the whistle blows, the coaches must release their riders. Rider 1 has the obligation to lead and so there may be a slight delay in the release of rider 2. This is permitted. However, the Starter must ensure that no-one holds their riders excessively or pushes their rider down the track. The holders are not permitted to step across the start line.

FIRST HALF LAP



The first phase of the race is normally ridden very slowly and is extremely tactical.

Rider 1 is required to lead for the first half lap, up until the Pursuit Line on the back straight. The following rider (rider 2) may choose to go past at any point. In this case rider 2 now takes over responsibility for leading.

The leading rider is not allowed to perform any tactic that forces the other rider to go past, and must move forwards at least at walking pace.

If the Starter observes any faults in this first half lap, the race may be stopped and restarted with the riders in the same order.

NOTE

In this phase of the competition it is common for the riders to ride on the Blue Band. This can be tolerated. However, it is never permitted for the following rider to overtake the leading rider by passing underneath when the leading rider is on the Blue Band. If this happens the Starter must stop the race.

Once the leading rider reaches the Pursuit Line on the back straight at the end of the first half lap, he or she no longer has an obligation to lead.

STANDSTILLS

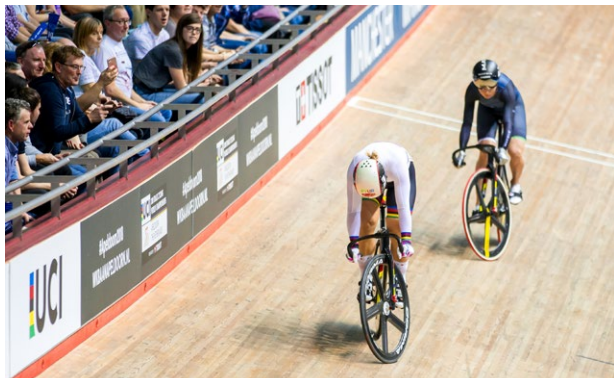

After the first half lap is completed, riders are permitted to perform a standstill. This is when a rider, usually the leading rider, comes to a stop to try to force his or her opponent to go past.

Only two standstills are permitted in each heat of a maximum period of 30 seconds.



Example

Rider A performs a standstill for 15 seconds, then rider B performs a standstill for 10 seconds. No more standstills are permitted since there have now been two standstills in the heat.



Example

Rider A performs a standstill for 10 seconds and then rider A performs another standstill for 10 seconds. No more standstills are permitted since there have now been two standstills in the heat.

During a standstill, the rider may jump the wheel or even roll the bicycle backwards (although the rider is not permitted to ride backwards along the track). The Starter must monitor conduct during the standstill, checking:

- the length of the standstill,
- number of standstills,
- conduct during the standstill.

**TIP**

Often the standstill happens just after the Pursuit Line in the back straight. The Back Straight Commissaire should monitor the conduct of the riders in this case and communicate any irregular behaviour to the Starter. The Starter can also ask the Back Straight Commissaire to relay instructions to the riders.

Once 30 seconds has passed in a standstill, the Starter must tell the front rider to continue. If the rider does not immediately go, then the Starter must stop the race and the offending rider loses the heat.

If a rider attempts to make a third standstill, the Starter must tell the rider to keep moving. If the rider conducts a standstill regardless, the Starter must stop the race and the offending rider loses the heat.

If a rider touches the opponent or the railing, the Starter must stop the race and restart it with the offending rider in position 1.

**TIP**

Pay careful attention to a rider who is very close to the railing when there is a standstill or the riders are moving very slowly. Sometimes a rider may use an arm on the railing to control speed or position. This is not permitted.

NOTE

In a round consisting of three heats, if there is a restart of a heat and the order of the riders is changed, this does not change the order for the subsequent heat.

CONDUCT PRIOR TO THE SPRINT PROPER

Up until the start of the final sprint for the line, the Starter has control of the race. The Starter needs to be ready to react and stop the race if necessary. The most common reasons for intervening are:

- fall,
- puncture,
- breakage of an essential part of the bicycle,
- dangerous or irregular conduct of a rider that affects the opponent.

The decision to intervene is based on whether:

- the conduct of a rider affected the opponent,
- an issue beyond the control of the rider impacted the race,
- a rider fell and this affected the race.

If the Starter decides to stop the race, this is indicated by a double pistol shot.

The Commissaires' Panel (usually the PCP in discussion with the Starter and Judge-Referee) must decide whether the rider at fault can restart or should be relegated or disqualified. The impact and intent of the rider must be considered. If the decision is made to restart, this restart happens immediately.

NOTE

There is no limit to the number of restarts permitted.

Up until the final sprint has started, riders are permitted to use the entire track. However, they still have to obey the rules related to riding on the track. Once the sprint has started the Judge-Referee is responsible for monitoring the conduct of the riders.



TIP

If the Starter is unsure whether the final sprint has started, it should be assumed that it has, and the Starter should not intervene.

CONDUCT IN THE SPRINT

If there is an incident in the sprint, the Judge-Referee has to immediately decide what should happen. Any available resources can be used to help make this decision. The options for the decision are:

- rerun the race (normally only in exceptional circumstances),
- leave the result to stand,
- issue a warning,
- issue a relegation,
- issue a disqualification.



TIP

Sometimes an incident is not serious enough to warrant immediate action. It is a good strategy for the Judge-Referee or PCP to talk to the coach of the offending rider to say that the behaviour is not permitted and may lead to sanctions in the future.

The Judge-Referee should discuss decisions taken with the PCP. The PCP announces the decisions.

The key items for the Judge-Referee to consider when analysing a sprint are:

- does the leading rider stay in a lane (not necessarily the Sprinter's Lane) – not deviating,
- use of the Sprinter's Lane,
- use of the Blue Band,
- passing of riders,
- general conduct.

The Judge-Referee must always consider the impact and intent.

The example situations below offer some general guiding principles. However, every situation is different. It is also important to consider the race as a whole and not just focus on the specific incident. Sometimes the incident being reviewed was caused by something else that could have an impact on the decision.

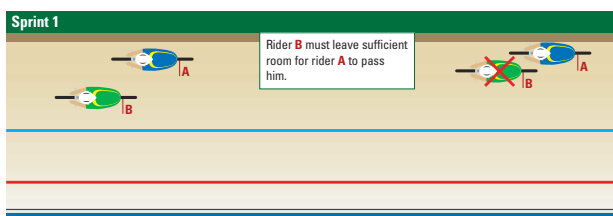

In this situation, rider A is either next to, or starting to pass rider B on the right. Rider B is not allowed to close this space and must leave enough room for Rider A to pass. The space can only be closed if there is a clear bicycle length between the riders.

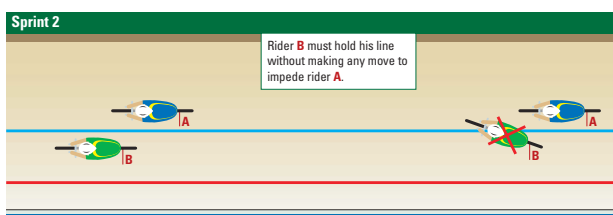

In this situation rider B is ahead of rider A, and rider A is attempting to pass. Rider B is not allowed to change line to prevent rider A from passing. It is important to understand what the rider's true line is, especially upon entering and leaving the turns. The lane is the natural trajectory of the rider as he or she circles the track. It can be considered the rider's predictable line.

The rider is allowed to change line in the sprint, provided this does not prevent the opponent from passing.

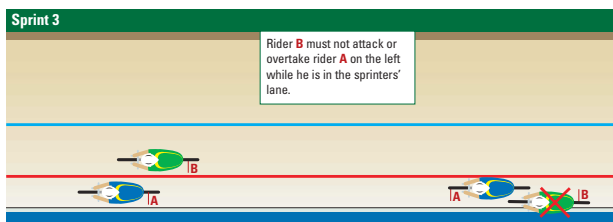

In this situation rider A is riding in the Sprinter's Lane. Rider B is not permitted to pass on the left of rider A as long as rider A remains in the Lane.

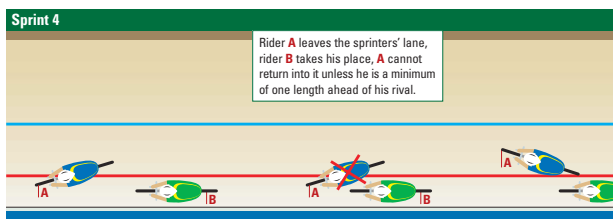

It is important to pay careful attention to the previous situation as sometimes rider A is leading rider B, with rider A in the Sprinter's Lane. As they come out of a bend, rider A cannot hold the line and drifts up and out of the Sprinter's Lane. Immediately rider B responds by moving to pass in the Sprinter's Lane. Rider A is not allowed to return to the Sprinter's Lane unless he or she is a clear length ahead. If Rider A does return, and is not a clear length ahead, then rider A would be at fault.

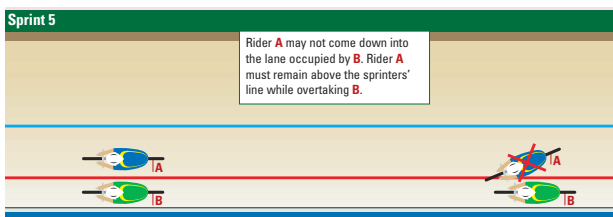

In this situation rider B is in the Sprinter's Lane. Rider A is attempting to overtake rider B. Rider A is not allowed to come into the Sprinter's Lane until completely ahead of rider B.

Be careful with this situation. Just because rider A comes into the Sprinter's Lane does not mean that this rider must be relegated if winning the race. The impact must be considered. The behaviour of rider B must also be considered. For example, if while rider A was next to rider B, rider B went down onto the Blue Band and rider A followed down, then this does not mean rider A is necessarily at fault.

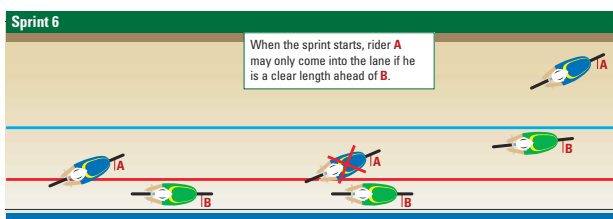

The situation shown is a common one when two riders are high up the banking and then both dive down to the Sprinter's Lane. In this case, even though rider A is ahead of rider B, rider B gets into the Sprinter's Lane first. Rider A is only allowed to go into the lane when a clear length ahead of rider B.

In many cases rider A will pull back out of the Sprinter's Lane. In this case, it is important to determine whether rider A's entry into the Sprinter's Lane hindered rider B. If it did not, then no action should be taken.

9.2.2.5. Specific Commissaire Roles



Please also see chapter 5 for the general duties of all Commissaire roles at track competitions.

STARTER AND ASSISTANT STARTER

The Assistant Starter is responsible for conducting the draws to determine the starting order of the riders on the track. This is done using cards or another method that allows for a fair draw. The Assistant Starter notes the order down on the start list and informs the Starter of the correct order.

The Starter ensures the correct riders are on the track and that they are in the correct order. The Starter quickly reviews the equipment being used and, when the riders are ready, signals the start by blowing a whistle.

The Starter must watch the conduct of the race very closely and must be ready to intervene up until the start of the final sprint. If the Starter needs to stop the race, this is done by means of a double pistol shot.

JUDGE-REFEREE

The Judge-Referee is responsible for monitoring the conduct of the riders during the final sprint and immediately makes any necessary decisions.

Due to the nature of Sprint racing, the Judge-Referee needs to be vigilant throughout the race to:

- observe any race incidents,
- understand how a race incident has evolved,
- make an immediate decision regarding a race incident,
- inform the PCP of any decisions.

The Judge-Referee needs to collaborate with the Starter and PCP when monitoring the race. This is especially important due to the shared responsibility over the various phases of the event.



TIP

The Judge-Referee should keep notes of what happens in a race to allow for later consultation if a situation needs to be explained in detail.

FINISH JUDGE AND TIMEKEEPERS

The Finish Judge is responsible for classifying the order of the riders across the Finish Line in conjunction with the Timing Company. If the result is close, the Finish Judge must personally view the photo-finish and then send the result to the Secretary.

The Finish Judge does not make any decisions relating to the conduct of the race.

The Timekeepers manually record the time of the winner of each heat over the final 200 m. They check the electronic times recorded by the Timing Company.

NOTE

Records for the Flying 200 m distance cannot be established in the Sprint event.

CORNER COMMISSAIRES AND FLAG COMMISSAIRES

These Commissaires monitor the conduct of the riders within their zones. However, they should remain vigilant during the entire race so that they are aware of how an incident evolved.

If they witness anything relevant, they should notify the PCP and Judge-Referee over the radio.

NOTE

Sometimes the Judge-Referee may request not to be contacted and asks colleagues to wait until requested for information. Whenever communicating with the Judge-Referee or PCP, or on seeing an incident, the Commissaire must always be discreet.

OTHER COMMISSAIRES

The Lap Board Commissaire changes the lap board for the riders and rings the bell for the start of the final lap.

9.2.3. TEAM SPRINT

 The Team Sprint (**ARTICLES 3.2.144 to 3.2.155**) is not a very complicated event. However, since this event can be won by thousandths of a second, and there are several ways to gain this advantage that are not permitted, the conduct of the race must be closely monitored.

9.2.3.1. Event Overview



The Team Sprint is a team event where riders can be changed between rounds. In the men's event, there are three riders on the team. In the women's event, there are two riders.

The entire team starts together on the Pursuit Line, with each rider leading one lap before pulling off and allowing the following rider to ride the next lap. The winning team is the team recording the fastest time after their final rider crosses the finish line, which is the Pursuit Line they started from.

Since time is the deciding factor, electronic timing is used.

Due to the nature of the event and the size of the team, the men's race is three laps, while the women's race is two laps.

NOTE

The actual distance of the race can vary depending on the length of the track. The World Record is established only for 250 m tracks. A World Record cannot be set on any other track length.

For all competitions, the event is ridden in three rounds, with two teams on the track at a time. Sometimes the Qualifying Round is ridden with only one team on the track at a time. But this is an exception.

The Qualifying Round is used to find the eight fastest teams.

In the First Round, the teams race against each other according to the following format, where the number indicates their rank from the Qualifying Round:

- 1 against 8
- 2 against 7
- 3 against 6
- 4 against 5

The four winning teams from the First Round race the finals. The two fastest winning teams race for first and second place, and then the next two fastest teams race for third place.

NOTE

The race for third place starts before the race for first and second place.

For the Olympics only, there is an additional round where the losing teams from the First Round race each other to determine fifth to eighth places.

9.2.3.2. Track Setup

The start and finish line for this event is the Pursuit Line, and since two teams start at the same time on opposite sides of the track, there needs to be a bell and lap board on both Pursuit Lines.

There also need to be starting gates on both sides of the track to hold the leading rider, as well as countdown apparatus that is used to manage the start.

Since time is the critical factor, electronic timing is required. This is usually done with contact tape switches set up on the Pursuit Line.

Foam pads must be placed up to the inside edge of the Blue Band on the Pursuit Line, and then at the 5 m, 10 m and 15 m from the Pursuit Lines on both sides of the track. These are to prevent the riders using the Blue Band at the start, as well as to indicate the final point for the changeover.

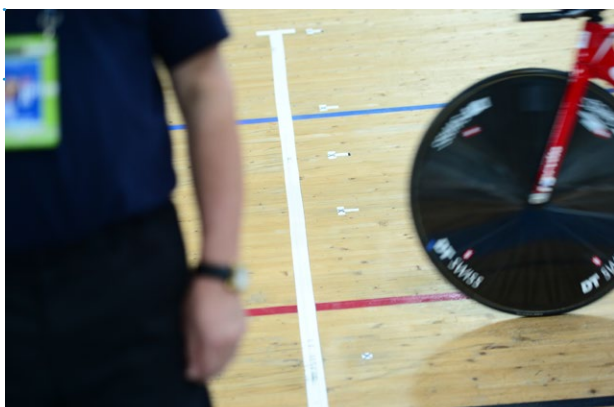

TIP

Before the start of the relevant session, Commissaires should place small marks just behind the Pursuit Line to help with positioning the riders at the start. These marks can be made using non-slip tape. The first mark is where the base of the front wheel is located for the bicycle being held in the starting gate. The second mark is 1.5 m vertically up the track from this mark. The third mark is an additional 1.5 m vertically up the track from the second mark. When the coaches bring their riders to the start line these marks can be used by the Commissaires to ensure the riders are properly lined up for the start.

9.2.3.3. Start Order

The starting order of riders for the Qualifying Round is drawn up by the Commissaires' Panel. Usually this is done by the Secretary, delegated by the PCP. Depending on the level of the competition (for example World Championships or World Cups), the riders may be seeded on different criteria, including:

- UCI Team Sprint Ranking,
- defending champions,
- series leaders.

The general principle is that the best teams always start last. However, the Commissaires' Panel always has the right to modify the seeding. This is sometimes done to try to prevent the two best teams competing against each other in the Qualifying Round, which could mean the potential finalists facing each other at the start of the event.

In some cases, the start order may be completely random.

The best, or fastest teams, always start on the home straight.

9.2.3.4. Race Conduct

THE START

| UCI 2017 TRACK CYCLING WORLD CHAMPIONSHIPS HONG-KONG CHINA | | | | |
|--|-------------------|---------------------------|---------------------------------|--|
| PRESENTED BY TISSOT | | | | |
| 12-16 April 2017 | | | | |
| Men's Team Sprint / Vitesse par équipes hommes | | | | |
| First Round / Premier tour | | | | |
| Start List / Liste de départ | | | | |
| Wed 12 Apr 2017 - Race distance: 3 laps | | | | |
| World Record | | 41.871 GER - Germany | Agua Calientes (MEX) 5 DEC 2013 | |
| Heat | Race Number | Country / Name | Time | |
| 1 | 310 | POL - Poland | | |
| | | | BIELECKI Maciej | |
| | | | RUDYK Mateusz | |
| 313 | CHN - China | | | |
| | | LI Jianan | | |
| | | LIU Yongfa | | |
| 2 | 197 | GBR - Great Britain | | |
| | | | CARLIN Jack | |
| | | | OWENS Ryan | |
| 203 | NED - Netherlands | | | |
| | | VAN T'HOENENBERGDAAL Nils | | |
| | | LAVREYSSEN Harrie | | |
| 3 | 184 | FRA - France | | |
| | | | EDJALIN Benjamin | |
| | | | VIGIER Sebastien | |
| 188 | AUS - Australia | | | |
| | | HART Nathan | | |
| | | GLAETZER Matthew | | |
| 4 | 301 | NZL - New Zealand | | |
| | | | MITCHELL Edman | |
| | | | WEBSTER Sam | |
| 298 | JPN - Japan | | | |
| | | NAKAGAWA Yoshitaku | | |
| | | NITTA Yudai | | |
| 201 | WATANABE Kazunari | | | |

Qualification rule:
The fastest two winning teams race for the gold and silver medals, and the other two winning teams race for the bronze medal. Losers are classified from 9th to 8th place by their times in the first round.

Communique approved by the Secretary of the Commissaires Panel:

Note:
The composition of the teams may be subject to change up to 30 minutes before the start of the race. Sorted in the order given by the team.

Report Created: WED 12 APR 2017 16:57
Timing and Results provided by **TISSOT**

During this event, two teams race against each other.

The teams must be ready and waiting at their respective start lines at the Pursuit Lines on the home and back straights.

NOTE

The start list should always give details of each heat with the team starting on the home straight listed above the team starting on the back straight.



Once the previous heat is finished the respective Flag Commissaires ask the teams to come to the start line. The coaches bring the lead rider's bike to the starting gate and the other two riders to the Pursuit Line.

The riders are positioned vertically up the track with 1.5 m between each of them. The Commissaires should use the prepared marks on the track to position the bicycles. Once the coaches have riders 2 and 3 (men only) in the correct position, Commissaire Holders take over holding the riders. They should hold them just under the saddle with enough pressure to prevent them rolling off, but not so much that they are straining to hold them back.

NOTE

The start list is not required to list the riders in the correct order of start for each team. However, at major competitions (for example, World Cups and World Championships), the Commissaires must ask the team managers for this order at the license control, and the start list must list the riders in the correct order.

As soon as the bicycles of the lead riders on both sides are locked into the starting gate, the start countdown of 50 seconds commences. The Starter does not wait for the entire team to be ready.

As soon as the start is given, the starting gate opens to release the rider and the Commissaire Holders also release their riders. The rider who was held by the starting gate is the lead rider and must lead for the first lap. The second and third riders follow immediately behind the lead rider.

If a team commits a false start, normally by one of the following riders going early, the Starter immediately stops the race with a double pistol shot and the teams restart without delay, if permitted.

In each round of the event, each team is only allowed one restart, either for a false start, or for a mishap.

THE CHANGEOVER

At the end of the first lap, rider 1 pulls off and rider 2 takes over, with rider 3 following immediately behind in the case of the men. At the end of the second lap rider 2 pulls off, with rider 3 completing the following lap. In the case of the women, rider 2 will have completed the race.

The point of changeover from one rider to another must be strictly monitored by the Commissaires.

At all major competitions, a photo-finish camera is placed on both Pursuit Lines to assist in verifying that the changeover happened correctly. If there is doubt over whether the changeover was correct, then the PCP must check the photo-finish. If there is no photo-finish camera, then a Commissaire must be placed on the Pursuit Line to monitor the changeover.

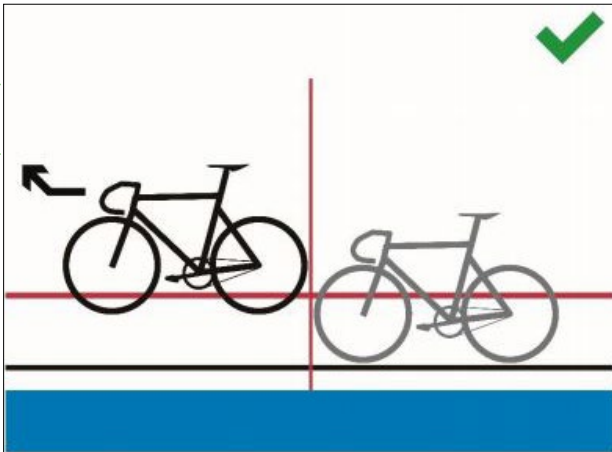

At the completion of a lap, the leading edge of the leading rider's front wheel must cross the Pursuit Line ahead of the leading edge of the front wheel of the following rider. It does not matter where on the track the two riders are in relation to each other, as long as this condition is met (**ARTICLE 3.2.153**).

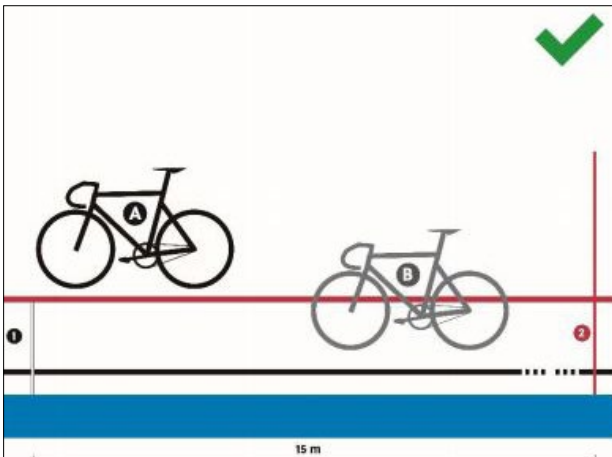

By 15 m after the Pursuit Line, the rider giving up the lead must have pulled up and be above the Sprinter's Line. It does not matter if the following rider has not yet passed the leading rider at this point.

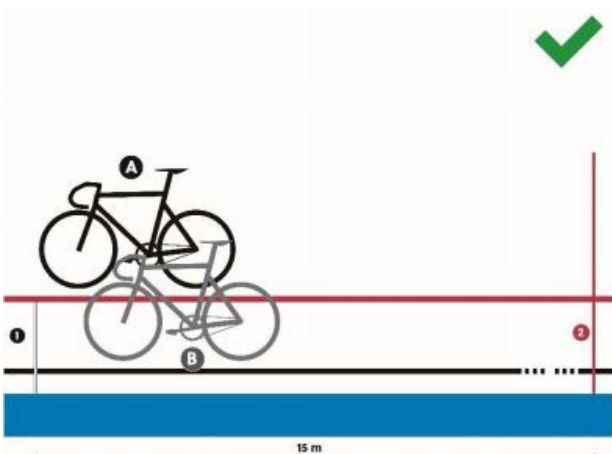

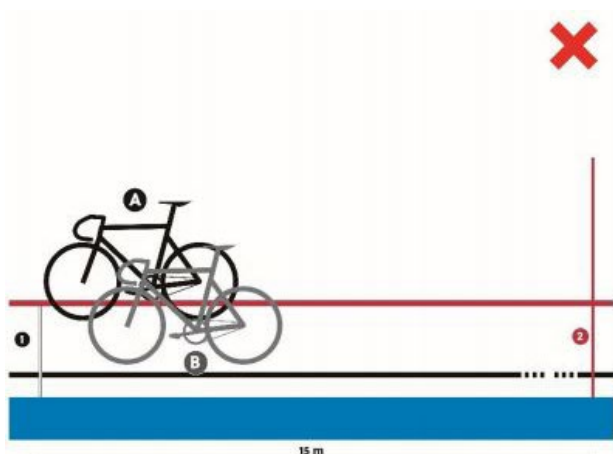

Any team making an incorrect changeover is relegated to last place in that stage of the event.



Example

A team makes an incorrect changeover in the ride for first and second place. If they win the race, they will be relegated to second place.

NOTE

The use of the Blue Band is not permitted during the changeover. This means that the following rider is not allowed to start passing the leading rider by riding underneath on the Blue Band. A team doing this is relegated.

CONDUCT

If the order of riders on the start line is not respected during the race, then the team is relegated to last place in that stage of the competition.



Example

At the start, rider 2 takes the lead for the team, and then at the end of the first lap pulls off with rider 1 now taking the lead. In this case the team is relegated.

Teams may not voluntarily ride on the Blue Band. If a team does so momentarily, then no decision is required. However, if a team chooses to ride part of the race on the Blue Band, then that team must be disqualified.



Example

Between corner 1 and corner 2, rider 1 from the team drops down on to the Blue Band, but then comes back up on to the track. This is allowed and no action is required.



Example

Just after corner 2, a team drops down on to the Blue Band and rides the length of the straight on the band. Soon after exiting corner 3 the team returns to the track. This is not allowed and the team must be disqualified.

NOTE

It is unlikely that teams will voluntarily use the the Blue Band on shorter tracks with steep bankings. On longer tracks with shallower bankings, it may be an advantage for the team to ride on the Blue Band. Commissaires must pay particular attention to this.

MISHAPS

For mishaps, the general principles are:

- it does not matter if the mishap is recognised or unrecognised,
- the mishap can happen at any point in the race,
- each team is allowed one restart due to a mishap, in each round of the event, if they have not yet already had a restart in that round, in this case they would be relegated to the last place in that round of the event, or in the final, loose the race,
- a team having a second mishap in the same round of the event is relegated to last place in that round of the event, or in the final, loses the race,
- if the Starter must stop the race due to a mishap, this is indicated by a double pistol shot.

In the Qualifying Round, if a team suffers a mishap, the Starter should not stop the race unless the other team would be impacted in some way, for example, if the track is obstructed. Any teams that suffer a mishap get a second start after all the other teams have completed their rides, if permitted. The team should start from the same start line from which they started before the mishap.

In the First Round and Finals, if a team has a mishap, and it has not already had a restart in that round, the Starter must immediately stop the race, which must be rerun without delay. If a team has a second mishap in the same round, the Starter must not stop the race and must let the riding team complete their race to record a time, unless the other team is impacted in some way, for example, by the track being obstructed.

NOTE

If the Starter stops the race in the event of a false start, mishap or start gate failure, starting gate operators must never leave the gate in position on the track. **After each start, the gate must always be removed.**

TIES



Ties are broken according to **ARTICLE 3.2.147**.

TEAM CHANGES

A team can change its riders from one round to the next. They are entitled to change all their riders, provided that the replacement riders have been entered for the Team Sprint event.

A team wanting to make a change must inform the Secretary at least 30 minutes before the start of the round of the event in which the change is being made.

Changes are not permitted after this deadline. If a team starts with a changed rider, but the Secretary has not been informed of the change within the time limit, the team is disqualified.

9.2.3.5. Specific Commissaire Roles



Please also see chapter 5 for the general duties of all Commissaire roles at track competitions.

PRESIDENT

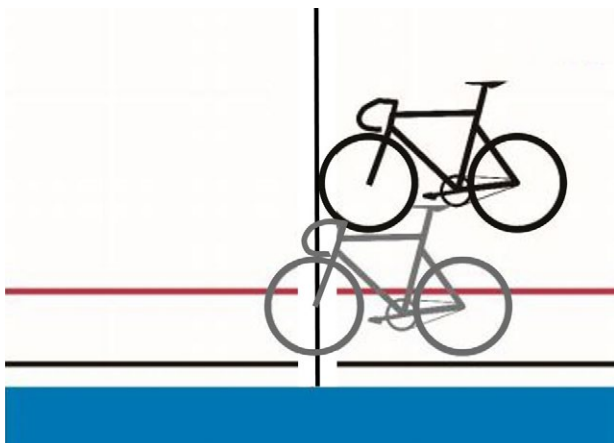

The PCP is responsible for monitoring the changeover and must review the photo-finish if there is an issue. Even if the changeover is only incorrect by one pixel on the photo, it is still incorrect and appropriate action must be taken.

The PCP also monitors the general conduct of the race, for example ensuring that riders do not push each other.

Any decisions must be announced as soon as possible.

SECRETARY

The Secretary oversees any changes to team compositions by:

- monitoring the time limit,
- updating the Start List,
- ensuring all Commissaires are informed of changes.

The Secretary also monitors the results for any ties and makes sure that these have been broken properly.

The Secretary ensures that all the rounds are formed correctly.

STARTER AND ASSISTANT STARTER



The Starter must have an Assistant Starter for this event. They are positioned in the centre of the track, normally standing back-to-back, each monitoring one of the Pursuit Lines and a team for any mishaps.

The Starter and Assistant Starter monitor the formation of the team on the start line. If a team is not lined up properly they can ask the Flag Commissaire to intervene to resolve the issue.

Once the Flag Commissaires indicate that the teams are ready, the Starter initiates the countdown mechanism and then monitors the start together with the Assistant Starter.

In the case of a false start, the Starter immediately fires a double pistol shot to stop the race. However, if the team has already had a restart in that round of the event, the Starter should not fire the gun unless the other team is impacted, as this would disadvantage the other team. A team having a second false start is relegated.

If something happens to cause a stoppage to the countdown, the Starter must decide to either restart the countdown or resume it from where it was stopped. Normally, if there are more than 30 seconds to the start, the countdown is resumed.

The Starter and Assistant Starter must remain vigilant for the entire event and be ready to intervene if necessary in the case of a mishap.

They should also monitor the order of the riders during the event. If a team does not respect the order that was lined up on the start line, the Starter must inform the PCP, and that team will be relegated.

TIMEKEEPERS

There must be at least one timekeeper at each Pursuit Line. They manually record the times of each team, recording the lap and half-lap times set on the Pursuit Line. They use these times to check the times recorded by the Timing Company.

The times are taken based on the front wheel of the front rider crossing the Pursuit Line.

If a World Record is set the Timekeepers are required to sign the World Record application form.

FLAG COMMISSAIRES

The Flag Commissaires must make sure the teams come to the line promptly. On the side for which the Flag Commissaire is responsible, he or she must make sure that the lead bicycle is immediately loaded into the starting gate and does not wait for the rest of the team to get ready. As soon as the bicycle is loaded into the Starting gate and the gate is locked, the Flag Commissaire indicates this to the Starter by raising the flag. Once the countdown starts, the flag is lowered.

The Flag Commissaire monitors the riders being brought to the line:

- the Flag Commissaire verifies that the riders on the line are the correct riders. If there is a discrepancy, he or she first checks with the Secretary to make sure there were no changes. If there is still a discrepancy, the Starter and PCP are informed,
- the Flag Commissaire ensures that the riders are positioned correctly.



While waiting for the start, the Flag Commissaire should stand up near the railing, on the Pursuit Line. From here the Flag Commissaire can monitor the start and assist the Starter with any requests.

If there is an incident prior to the start, the Flag Commissaire must raise the flag to notify the Starter so that the countdown is stopped. The Flag Commissaire then lowers the flag and monitors the situation. Once the situation has been resolved the flag is raised again to indicate to the Starter that the team is ready.

NOTE

The Flag Commissaire must not react to any potential false starts.

If something happens that obstructs the line after the start, the Flag Commissaire needs to indicate this to the other team as they approach, by means of the flag and whistle.

The Flag Commissaire may also be asked by the PCP to monitor the changeovers on the Pursuit Line. In this case, the Flag Commissaire discreetly informs the PCP if an irregularity is observed.



At the end of the heat the Flag Commissaire monitors the starting gate being brought back on to the track. The Flag Commissaire:

- takes up a position behind the gate with a flag to indicate to riders who have just finished to move up,
- monitors the riders coming on to the track,
- asks the Commissaire Holders to assist.

NOTE

The Commissaires must not allow riders who have just finished to continue circulating on the track or Safety Zone. Two laps are sufficient.

OTHER COMMISSAIRES



Commissaire Holders are located on the Pursuit Lines. These Commissaires hold riders 2 and 3 for the start. The Commissaires must position themselves in the correct place on the track. They can use the marks prepared on the Pursuit Line to help with this. The coaches are required to position the riders correctly; once they are in the correct position the Commissaire Holders take over holding the rider.

When the lead rider is released from the starting gate, the Commissaire Holders release their riders.

They should hold the riders firmly, but if the rider pulls away, they should let the rider go.

At the end of the heat, the Commissaire Holders help the Flag Commissaires with monitoring the starting gate and the next team being brought out on to the track.

9.2.4. KEIRIN

 The Keirin event (**ARTICLES 3.2.134 to 3.2.143**) is a complex event run in two very distinct phases, with rider conduct in each phase well defined. The second phase of the event is very similar to the Sprint event, except for the number of riders on the track. Consequently, the Commissaires must be very familiar with the Sprint regulations and sporting management ([see chapter 9.2.2](#)).

9.2.4.1. Event Overview



The event is normally made up of around six riders competing on the track at the same time.

It is run in two phases:

- Phase 1 is behind the derny, a small motorised cycle that offers shelter that is similar to that of a cyclist,



- Phase 2 is the rest of the race after the derny has left the track.

The total distance of the event is based on the distance after the derny leaves the track. The derny always leaves the track on one of the Pursuit Lines. The distance the riders complete without the derny is the number of laps closest to 750 m. The total distance of the race is then double this distance.



Example

On a 250 m track, the derny leaves the track with 3 laps to go (750 m), and so on the Pursuit Line on the home straight. The total distance of the race is therefore 6 laps, with 3 of them behind the derny.



Example

On a 200 m track, the derny leaves the track with 3.5 laps to go (700 m), and so on the Pursuit Line on the back straight. The total distance of the race is therefore 7 laps, with 3.5 of the behind the derny.



Example

On a 333.3 m track, the derny leaves the track with 2.5 laps to go (833 m), and so on the Pursuit Line on the back straight. The total distance of the race is therefore 5 laps, with 2.5 laps behind the derny.

Riders are not permitted to pass the derny until it leaves the track.

The start is always on the Pursuit Line on the home straight. The finish is always on the Finish Line.

For the event to take place there needs to be at least the following:

- 10 riders competing,
- Qualifying Round, 2 heats of 5 riders,
- Final for places 1 to 6.

However, the event normally involves more competitors and comprises:

- First Round,
- Repechage,
- Second Round,
- Final for places 7 to 12,
- Final for places 1 to 6.

 The table in **ARTICLE 3.2.135** must be followed when organising the series. The general goal is to ensure you have 12 riders in the finals. There is usually a final for places 7 to 12 and always a final for places 1 to 6.

NOTE

The composition example shown in **ARTICLE 3.2.135** is only an example. The Commissaires' Panel may modify which riders are in which heats as required (for more detail [see chapter 9.2.4.3](#)).

In the first phase of the race, the riders ride behind the derny as its speed gradually and consistently increases. Once the derny exits the track, the race is ridden like a Sprint competition.

9.2.4.2. Track Setup

The track is set up as it would be for the Sprint event ([see chapter 9.2.2.2](#)), with the addition of one extra piece of equipment, the derny.

 The derny is a motorised bicycle and can be either fuel- or electric-powered. It must be possible to maintain a steady speed, as well as to increase this speed in a consistent way. The derny rider must have an accurate speed display. See **ARTICLES 3.6.029 to 3.6.051** for the requirements of a derny. There is no expectation for the Commissaires to measure the derny. However, it must be safe to use on the track and must not create any hazards (for example, dripping fuel on the track).

The organiser should have a backup derny available in case of any malfunctions.

 The derny rider is dressed like a cyclist (**ARTICLE 3.6.063**).

The principle is that the derny offers the same shelter as that of a bicycle.

A photo-finish camera is placed on the Pursuit Line where the derny exits the track to assist in verifying that no rider has passed the derny.



9.2.4.3. Start Order

The riders are seeded for the First Round by the Commissaires' Panel. Usually this is done by the Secretary, delegated by the PCP. Depending on the level of the competition (for example World Championships or World Cups), the riders may be seeded on different criteria, including:

- UCI Keirin Ranking,
- defending champions,
- series leaders.

Sometimes the UCI Sprint Ranking will also be considered.

Once the riders are seeded, the Secretary then assigns them to First Round heats based on the composition example in **ARTICLE 3.2.135**. Riders who have no ranking, or for whom no information is available, are placed randomly in the various heats. It is not a requirement to strictly adhere to the composition example, but the Secretary must ensure that the heats are evenly balanced.



TIP

It is good practice to try to avoid riders from the same team racing in the same heat to minimise the possibility of collusion.

As the event progresses, the Secretary can construct each heat in the following rounds using the composition example as a starting point. However, the heats can be modified to ensure balance and if possible avoid riders from the same team competing against each other. This also allows for modifications due to riders who qualify but do not start in the following rounds.

NOTE

The progression from the Second Round to the Final cannot be modified.

NOTE

The general formula as shown in the first tables in **ARTICLE 3.2.135** cannot be modified.

The general formula used for the event must be published. This is not about which heat a rider goes in to, it is about:

- how many riders are in each heat in the First Round,
- how many riders qualify for the Second Round from each heat of the First Round,
- how many riders are in each heat of the Repechage,
- how many riders qualify from each heat of the Repechage.

9.2.4.4. Race Conduct

THE START

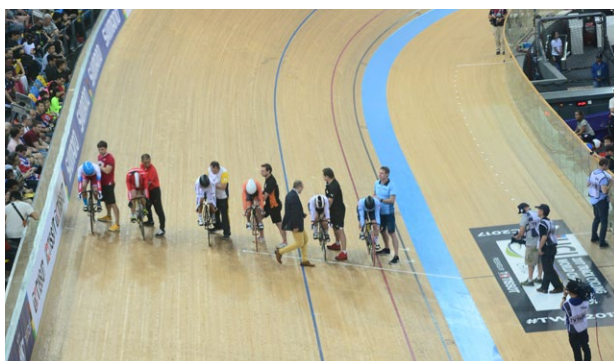

The riders in the heat must be ready and waiting in the waiting area. They must not wear glasses or visors until they go up onto the track.

The Assistant Starter conducts the draw with the riders, notes the order down and informs the Starter. The rider drawing 1 takes the inside position and, when called, comes to the start line (the home straight Pursuit Line) with his or her coach and takes up a position with front wheel just behind the Pursuit Line, towards the bottom of the track. The Sprinter's Lane is left free for the derny. The remaining riders line up vertically along the Pursuit Line, in the order that they drew. They are all held by their coaches.

The deryn should be waiting near the Pursuit Line on the back straight.

The Starter checks that all the riders are ready. Once this is confirmed the Starter signals to the deryn to start. The deryn approaches the riders at the initial race speed.

The Starter should stand either slightly behind the riders, or if ahead of the riders, hold the starter's pistol in such a way that the riders cannot see it. This prevents them anticipating the start.

About 5 m before the deryn reaches the start line, the Starter fires the pistol to start the race.

The coaches normally give their riders a small push to get them going. This is permitted. However, the coaches must not step across the Pursuit Line. As soon as they have pushed off the riders they normally take up positions on the home straight to monitor their riders. The coaches must not be allowed to get too close to the track and are never permitted on the Blue Band.



For the first lap, the riders are required to line up immediately behind the deryn in the same order as the draw. The Starter must allow some time for the line to form (at least a quarter of a lap). If the riders do not form up behind the deryn the race must be stopped and any riders at fault disqualified. In this case the riders would then restart in the same order without the offending rider(s).

NOTE

Sometimes the Starter may fire the pistol too late, not giving the riders the opportunity to form up behind the deryn. This is the fault of the Starter and no-one should be disqualified.

If the riders do not form up in the correct order, then the race must be stopped and the offending riders disqualified. The remaining riders restart in the same order. In this case, it is very important to establish which riders are at fault. This means the Starter and PCP must pay close attention to the start. If a rider is not in the correct position this does not necessarily mean that he or she is at fault.



Example

At the start, rider 3 accelerates and takes position 1, rider 2 follows rider 3, and rider 1 is at the back. The race must be stopped. In this case rider 3 is at fault and should be disqualified. The positions of the other riders were due to the actions of rider 3.



Example

At the start, rider 1 starts slowly, forcing rider 2 past. Rider 3 accelerates to take position 1. The race must be stopped. In this case rider 1 and rider 3 are disqualified. Rider 1 forced rider 2 past, and rider 3 made a deliberate move to take position 1.

SPEED OF THE DERYN

The speed of the deryn when it first approaches the riders for the start must be 30 km/h. The deryn must then gradually build up speed until, with approximately half a lap to go until it leaves the track, it is travelling at 50 km/h.

The deryn must exit the track on the relevant Pursuit Line at 50 km/h.

If for any reason the deryn loses speed while on the track, the Starter must stop the race and conduct a restart.

Normally the Technical Delegate monitors the speed of the deryn. If there is no Technical Delegate, then either the PCP, or a Commissaire delegated by him or her, should perform this function.

To help monitor the speed of the deryn, a table has been created with half-lap times for the deryn that reflects a gradual increase of speed. This table can be found in chapter 15.2.6.

The Starter must ensure that the derny rider understands the role:

- the starting speed,
- the finishing speed,
- the need to be consistent,
- where to exit the track,
- when to exit the track.

CONDUCT BEHIND THE DERNY

For the first lap, see the description of The Start (above).



Once the first lap is complete, and until the derny leaves the track, the riders may change positions. They may also ride next to each other. They must behave in a sporting manner and may not use any illegal moves. If there is irregular behaviour but it has not yet had an impact, the Starter can first warn the rider by indicating to him or her and using the whistle. If the behaviour continues, or has had an impact, or is serious, the Starter must stop the race. The offending rider is disqualified and the remaining riders restart in the same order.

Examples of irregular behaviour are:

- head butting,
- barging,
- sudden irregular movements with the bicycle.

Until the derny leaves the track, the riders may not leave a gap behind the derny, or between themselves. If a gap is left, the Starter must stop the race and the offending rider is disqualified. The race is then restarted with the remaining riders in the same start order.

NOTE

For the purposes of this regulation, a gap should be considered about 10 m.

The derny leaves the track at the relevant Pursuit Line. Even if the derny is no longer riding above the Blue Band, it is not considered to have left the track until it reaches the Pursuit Line. A rider cannot claim the derny left the track simply because it drifted down onto the Blue Band. As long as the derny does not significantly slow down and does not drop off the Blue Band, the riders may not pass the derny until it reaches the Pursuit Line. If the derny slows down, or drops down below the Blue Band, the Starter must stop the race and restart it due to the fault of the derny.

The derny is considered to have reached the Pursuit Line when the leading edge of its front wheel reaches the Pursuit Line.

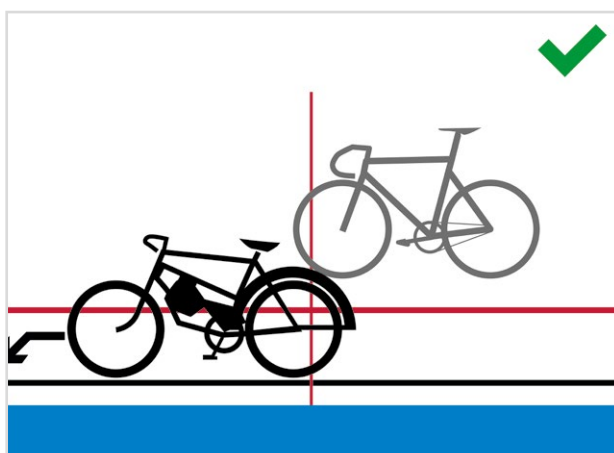

A rider is considered to have passed the derny if the leading edge of the front wheel of the rider passes the leading edge of the front wheel of the derny, before the derny reaches the Pursuit Line.

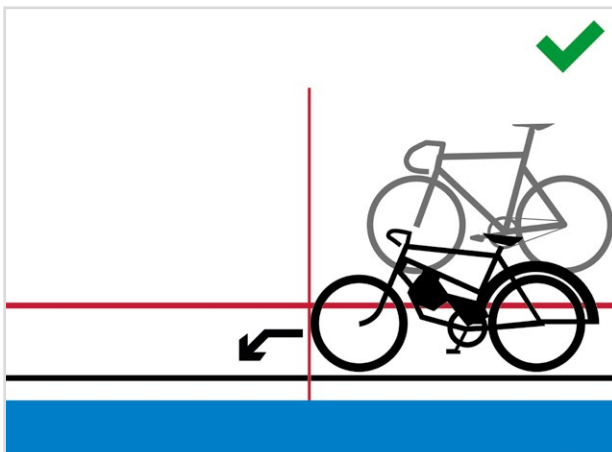

If a rider passes the derny before the Pursuit Line, the Starter must stop the race and restart it with the offending rider disqualified. The remaining riders restart in the same order.

If the Starter does not stop the race, and afterwards it is found that one or more riders had passed the derny before it exited the track, all those riders are disqualified. The race is not restarted, but the riders are placed according to their finish, filling in the places of the offending riders.

NOTE

It is very important for the Starter to pay close attention to any riders passing the derny and to stop the race immediately. In this way, only one rider is disqualified rather than potentially more than one.

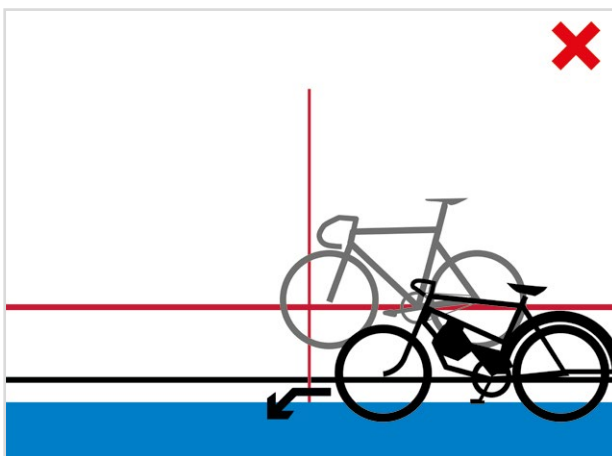

If the Starter believes a rider has passed the derny and stops the race, the photo-finish on the Pursuit Line can be used to verify whether the rider overtook the derny. If no rider passed the derny, the race is then restarted with all the riders.

CONDUCT AFTER THE DERNY LEAVES

Once the derny leaves the track, the race is essentially a Sprint event and is monitored and controlled in the same way (see chapter 9.2.2).

The main differences are due to the number of riders on the track. This can lead to riders trying to force their opponents out of the way or to collusion. The Judge-Referee must watch for both situations.

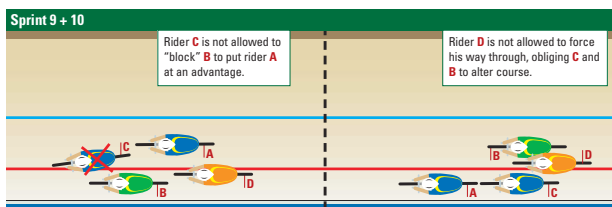

In this situation, rider B is riding next to rider A. Rider D would need to go out the back and pass over the top of rider B. However, she pushes through between riders A and B forcing them to change their course or speed. Rider D is at fault.

Pay careful attention. Sometimes rider D will be positioned behind and rider B either moves or drifts up the track opening a gap for rider D, who then starts to pass. Rider B then comes back down. In this case rider B would be at fault for coming down on rider D.

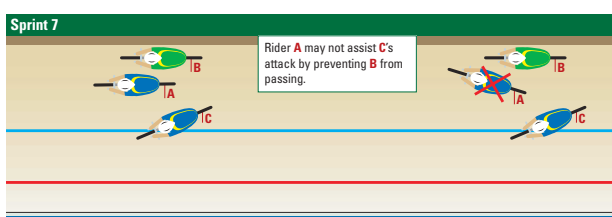

In this situation rider A is keeping rider B high up on the track. Rider C sprints away. Rider A then moves up to prevent rider B passing. Rider A is guilty of collusion. Both riders A and C can be sanctioned for collusion.

If, however, rider A stayed high and made no move to block rider B from passing, this would be acceptable.

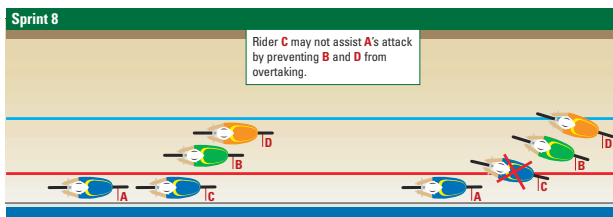

Rider A and rider C are from the same team. During the sprint, rider A accelerates away from the group, with rider C on his wheel. As he accelerates, rider B attempts to pass but rider C moves up the track. In this case rider C is guilty of collusion, and riders A and C can be sanctioned.

If, however, rider C had held his line, even if slowing down, he would not be guilty of collusion as he would not have prevented rider B from passing.

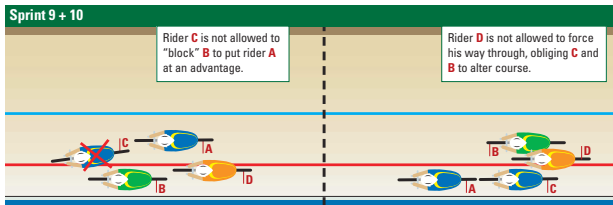

In this case rider C moves down to block rider B, giving an advantage to rider A. Rider C is guilty of collusion. Riders A and C can be sanctioned.

NOTE

Collusion can be very difficult to prove. However, it is important for the Commissaires to be aware of the potential for this, especially if more than one rider from the same team is in the heat.

DECISIONS IMPACTING RANKINGS

It is extremely important to consider the conduct of all the riders in each round, even if they are not qualifying for the next round. This is because their ranking is based on their relative placings. So if a rider commits an offence that would normally have them relegated, but that rider did not qualify for the next round, it is still important to relegate that rider otherwise they will have a higher ranking than the riders who finished behind them.

Riders are ranked based on their relative positions in each round.



Example

In a Keirin event, after the first round, there are 4 repechage heats, with 5 riders in each heat, and the first rider qualifying for the second round.

The rankings for the top 12 riders are determined by the Finals.

The riders who came second in each of the 4 repechages are placed in joint 13th position.

The riders who came third in each of the 4 repechages are placed in joint 17th position.

The riders who came fourth in each of the 4 repechages are placed in joint 21st position.

The riders who came fifth in each repechage are placed in joint 25th position.

It is thus very important to ensure that if a rider should be relegated in the repechage, they are.

MISHAPS

If there is a mishap in the first half lap, the race is stopped immediately and restarted with all the riders in the same order. There is no limit to the number of restarts.

After the first half lap, the race is not stopped for mishaps and any rider who suffers a mishap is placed last in the heat.

If for some reason the race is stopped after the first half lap, the race is restarted, but any rider who suffered a mishap is not permitted to restart and is placed last in the heat.

NOTE

If the track is obstructed, or there is a dangerous situation, the Starter must stop the race.

9.2.4.5. Specific Commissaire Roles



Please see chapter 5 for the general duties of all Commissaire roles at track competitions as well as chapter 9.2.2.5 for the roles of Commissaires in the Sprint event.

In a similar way to the Sprint event, the Starter has control of the event up until the final sprint starts. This means that while the riders are behind the derny, the Starter has control of the event. Once the derny leaves the track, the Judge-Referee is responsible for monitoring conduct.

After the start is given, the Flag Commissaire on the home straight monitors the conduct of the coaches in the home straight, ensuring that they do not get too close to the track or stand on the Blue Band.

The time is recorded over the final 200 m only.

The Secretary must ensure the rankings for all the riders are awarded correctly.

9.2.5.

KILOMETRE AND 500 M TIME TRIAL



The Kilometre and 500 m Time Trial events (**ARTICLES 3.2.101 to 3.2.113**) are run as time trial events. World Records can be set, so the distance and timing must be rigorously controlled.

9.2.5.1. Event Overview



This event is run purely as a time trial on the track and is intended for sprinters.

It is a standing start event where men compete over a distance of 1 km and women compete over a distance of 500 m.

It is run in two phases:

- Qualifying Round,
- Final.

All riders must complete the phase in the same session. If this is not possible for some reason, the entire phase must be rerun.

The finish line is always the Pursuit Line. Depending on the length of the track, the start line is also normally the Pursuit Line.

In the Qualifying Round, two riders start at the same time on the Pursuit Lines on opposite sides of the track. The riders race solely to record a time and are not in direct competition with each other.

The eight fastest times qualify for the Final.

NOTE

In the case of a tie for 8th position, the riders remain tied, and both tied riders will qualify for the Final (i.e. nine riders will contest the Final).

In the Final, riders race alone on the track. The start line is located in such a way that the finish line is always the Pursuit Line on the home straight.

In the Final, the riders are placed according to their times, with the fastest time being the winner.

9.2.5.2. Track Setup

The track is set up to control distance and time.

This means that foam pads are placed around the track making the Blue Band unrideable (see Pads in chapter 3.2.1) and electronic timekeeping is used.

Since it is a standing start, starting gates and countdown mechanisms are used to control the start.

9.2.5.3. Start Order

The riders are seeded for the Qualifying Round by the Commissaires' Panel. Usually this is done by the Secretary, delegated by the PCP. Depending on the level of the competition (for example World Championships or World Cups), the riders may be seeded on different criteria, including:

- UCI Kilometre/500 m Ranking,
- defending champions,
- series leaders.

Riders with no ranking are seeded randomly.

The highest seeded riders must always start in the final heats of a round.

When creating the start list, the best riders in each pair must finish on the home straight.

NOTE

Pay careful attention to which side a rider starts and finishes on. On the start list the rider whose name appears first in a two-up heat always starts on the home straight.

Example

- On a 333.3 m track, in the 500 m Time Trial Qualifying Round, Rider A is seeded higher than Rider B. So, Rider A must finish on the home straight. On this track the race is over 1.5 laps. Hence the rider finishing on the home straight must start on the back straight. The Start List would show the following order for the heat:
 - Rider B
 - Rider A
- On a 250 m track, since the distance would be two laps, and the start and finish would be on the same Pursuit Line, the start list would show the following order for the heat:
 - Rider A
 - Rider B

For the Final, the riders start in inverse order of their results from the Qualifying Round. This means that the fastest rider starts last.

NOTE

In the Final, the riders must always finish on the home straight.

9.2.5.4. Race Conduct

THE START

During the Qualifying Round, two riders race against each other. During the Final, one rider at a time races on the track.

The riders must be ready and waiting at their respective start lines at the Pursuit Lines on the home and back straights.

Once the previous heat has finished, the respective Flag Commissaires ask the riders to come to the start line. The coach brings the rider's bike to the starting gate.

As soon as the bicycles for the riders are locked into the starting gate, the start countdown of 50 seconds commences. When the start is given, the starting gate opens to release the rider.

MISHAPS AND FALSE STARTS

If the Starter needs to stop the race, this is done by a double pistol shot.

In the case of a false start the Starter must stop the race immediately. The riders restart without delay.

If there is a mishap, the Starter must only stop the race if the track is obstructed. The rider who had the mishap gets a restart after a wait of about 15 minutes. Even if there is only one rider on the track the Starter should not fire the pistol.

In total, only one restart is permitted for each rider in each round.



Example

In the Qualifying Round, a rider causes a false start and then in the next start has a mishap. The rider has already had a restart and so is eliminated.



Example

In the Qualifying Round a rider causes a false start and then in the Final the same rider has a mishap. The rider is allowed a restart in the Final since she has had only one start in this round.



Example

In the Final a rider pulls his foot out at the start. He gets a second start. In his second start he pulls his foot out again. The rider does not get another start. However, he can attempt to replace his foot in the pedal and keep going. If the Starter fires the pistol he would have already had a restart and so would be eliminated.

NOTE

If a rider keeps going after suffering a mishap, once the ride is completed a new ride cannot be requested.

9.2.5.5. Specific Commissaire Roles



Please also see chapter 5 for the general duties of all Commissaire roles at track competitions.

STARTER

The Starter must have an Assistant Starter for this event when it is a two-up start. They are positioned in the centre of the track, normally standing back-to-back, each monitoring one of the Pursuit Lines. In the case of a single rider starting, only the Starter is positioned in the centre of the track.

Once the Flag Commissaires indicate that their riders are ready, the Starter starts the countdown mechanism. The Starter and Assistant Starter then monitor the start.

In the case of a false start, a double pistol shot must be immediately fired to stop the race. In the case of two riders starting on the track, if a rider has already had one false start in that round of the competition, the Starter should not fire the gun unless the other rider is impacted, as this would disadvantage the other rider. The rider having the second false start is eliminated.

If something happens to cause a stoppage to the countdown, the Starter must decide to either restart the countdown or resume it from where it was stopped. Normally, if there are more than 30 seconds to the start, the countdown is resumed.

The Starter and Assistant Starter must remain vigilant for the entire event and be ready to intervene if necessary in the case of a mishap.

TIMEKEEPERS

There must be at least one timekeeper at each Pursuit Line. They manually record the times of each rider, recording the lap and half-lap times set on the Pursuit Line. They use these times to check the times recorded by the Timing Company.

The times are taken when the leading edge of the rider's front wheel crosses the Pursuit Line.

If a World Record is set the timekeepers are required to sign the World Record application form.

FLAG COMMISSAIRES AND CORNER COMMISSAIRES

The Flag Commissaire must make sure the rider comes to the line promptly and ensure that the bicycle is immediately loaded into the starting gate. As soon as the bicycle is loaded into the starting gate and the gate is locked, the Flag Commissaire indicates this to the Starter by raising the flag. Once the countdown starts, the Flag Commissaire lowers the flag.

While waiting for the start the Flag Commissaire should stand up near the railing, on the Pursuit Line. From here the Flag Commissaire can monitor the start and assist the Starter with any requests.

If there is an incident prior to the start, the Flag Commissaire must raise the flag to notify the Starter so that the countdown is stopped. The Flag Commissaire then lowers the flag and monitors the situation. Once the situation has been resolved the flag is raised again to indicate to the Starter that the rider is ready.

NOTE

The Flag Commissaire must not react to any potential false starts.

If something happens that obstructs the line after the start, the Flag Commissaire needs to indicate this to the other rider who is approaching, by means of the flag and whistle.

At the end of the heat the Flag Commissaire monitors the starting gate being brought back on to the track. The Flag Commissaire:

- takes up a position behind the gate with a flag to indicate to riders who have just finished to move up,
- monitors the riders coming on to the track.

Corner Commissaires should be available to replace any pads that may be hit or moved by the passing riders.

NOTE

The Commissaires must not allow the riders who have just finished to continue circulating on the track or Safety Zone. Two laps are sufficient.



REQUIRED KNOWLEDGE

- The definition of recognised mishaps.
- The use of warnings and relegations.
- Specific regulations of sprint-type events.
- Track set-up for each event.
- Permitted use of the Blue Band and Sprinter's Lane.
- Event specific functions for each Commissaire role.
- Role of the Speaker.



WHAT TO DO

- Keep track of warnings and relegations issued to riders in each event.
- Communicate with fellow Commissaires.
- If unsure, review video and photo evidence before making decisions.
- Consider the evolution of the incident before making a decision.
- Keep notes on incidents.
- Be discreet in response to incidents.
- Be consistent.



WHAT NOT TO DO

- Apply sanctions to every infringement observed.
- Leave the race management and decisions to the organiser or a member of the Commissaires' Panel even though you are the PCP and the decision is your responsibility.
- Apply decisions without considering their impact throughout the competition.

9.3. PURSUIT EVENTS

Track events can be divided into four broad categories, the second of which includes Pursuit events. Pursuit events are unusual as they combine the element of a time trial with the element of one rider or team catching another. Both elements have a role to play in different ways, depending on the round of the event.

All Commissaires must have a good knowledge of the general tasks and functions of the various Commissaire roles, as described in chapter 5 of this guide. This section only describes Commissaire roles where these are different or unique compared to the information provided in chapter 5.

The general requirements for the track set up, as well as descriptions of track equipment and installations, are provided in chapter 3.

Equipment requirements are explained in more detail in chapter 11.

9.3.1. INDIVIDUAL PURSUIT



The Individual Pursuit (**ARTICLES 3.2.051 to 3.2.076BIS**) is essentially an individual time trial with the added component that the riders chase and try to catch each other.

Since these are timed distance events, the control of distance and time is important and affects the management of the event.

9.3.1.1. Event Overview

The main component of this event is that it is an individual time trial. This means that the distance and time need to be controlled.

The second component of this event is that it is a chase. The riders chase each other around the track in an attempt to catch their opponent. If one rider catches the other, this may have an impact on the race depending on the round of the event.

The Individual Pursuit is a standing start event. Depending on the rider category, the distance varies between 2 km and 4 km.

The event is run in two phases:

- Qualifying Round,
- Final.

The finish line is always the Pursuit Line. The start line is also normally the Pursuit Line, depending on the length of the track.

Two riders start at the same time on the Pursuit Lines on opposite sides of the track.

In the Qualifying Round, the riders race solely to record a time.

The four fastest times qualify for the Final.

In the Final, the two fastest riders from the Qualifying Round race for first and second and the next two fastest riders race for third place.

The winner of the event overall is the rider who wins the race for first and second place.

NOTE

The winner is not necessarily the rider with the fastest time.



Example

A rider winning the ride for third place could record a faster time than the rider winning the ride for first place. However, the rider who wins the event overall is the rider winning the ride for first place.

World Records can be established in this event.

9.3.1.2. Track Setup

The track is set up in such a way as to control distance and time.

This means that pads are placed around the track making the Blue Band unrideable (see Pads in chapter 3.2.1) and electronic timekeeping is used.

Since it is a standing start, starting gates and countdown mechanisms are also used to control the start.

9.3.1.3. Start Order

The riders are seeded for the Qualifying Round by the Commissaires' Panel. Usually this is done by the Secretary, delegated by the PCP. Depending on the level of the competition (for example World Championships or World Cups), the riders may be seeded on different criteria, including:

- UCI Individual Pursuit Ranking,
- defending champions,
- series leaders.

Riders with no ranking are seeded randomly.

The general principle is that the best riders always start last. However, the Commissaires' Panel always has the right to modify the seeding. This is sometimes done to try to prevent the two best riders competing against each other in the Qualifying Round, which could mean the potential finalists facing each other at the start of the event.

The highest seeded rider in each pair must always finish on the home straight.

NOTE

Pay careful attention to which side the riders start and finish on. On the start list, the rider whose name appears first in a two-up heat always starts on the home straight.

In the finals, the race for third place always takes place before the race for first and second place. In each pair, the fastest rider from the previous round always finishes on the home straight.

9.3.1.4. Race Conduct

TIME TRIAL VERSUS PURSUIT

In the Qualifying Round, only time is considered. Any riders who are caught must continue their race to record a time.

A caught rider must drop back and is not permitted to:

- stay in the slipstream of the catching rider,
- re-pass the rider.

A rider who does either of these things is disqualified.

A rider who catches another rider must go past.



TIP

The Flag Commissaires must monitor the conduct of the riders on the track to prevent them taking pace, or one rider re-passing another. They should be ready to intervene with the rider. This can be done by indicating to the rider or speaking to the rider's coach on the Safety Zone. It is always better to prevent a disqualification.

If one rider catches another in the Final, that rider wins the ride. It is not necessary to continue in order to record a time.

NOTE

Pay attention here. Sometimes a rider who has caught an opponent in the Final will continue in order to record a time. This is usually done if there is an opportunity to break a record.

THE START

In all rounds, two riders race against each other.

The riders must be ready and waiting at their respective start lines at the Pursuit Lines on the home and back straights.

Once the previous heat has finished, the respective Flag Commissaires ask the riders to come to the start line. The coach brings the rider's bike to the starting gate.

As soon as the riders' bicycles are locked into the starting gate, the start countdown of 50 seconds commences.

Once the start is given, the starting gate opens to release the rider.

CATCHING AND PASSING

In the Qualifying Round, when one rider catches another they must both still continue in order to record a time:

- a rider may not take pace from another rider,
- a rider who has been caught may not repass the catching rider,
- it is the responsibility of the caught rider to drop back and remain a proper distance behind the passing rider.



Example

In the Qualifying Round, rider A starts very quickly and within eight laps catches rider B and passes her. One lap later rider A slows down significantly. Rider B is continuing to ride the same pace. Rider B starts to catch rider A again. Rider B is not permitted to get close to rider A, or to repass rider A. Rider B has the responsibility to remain a proper distance behind rider A.

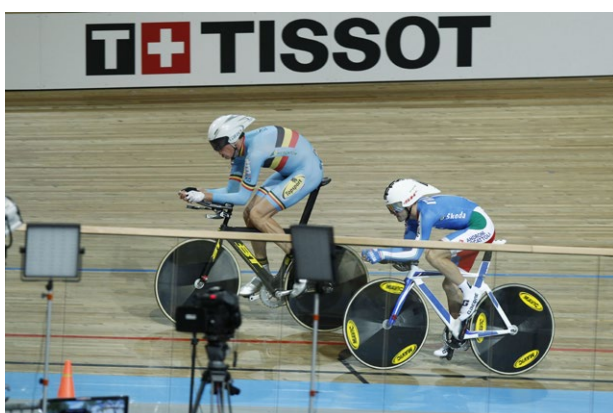

The Commissaires must be ready to intervene to prevent a rider taking pace or repassing.

If one rider catches another, but does not go past, that rider will need to drop back.

One rider is said to have caught another rider when their bicycles are level.



MISHAPS – QUALIFYING ROUND

It does not matter if the mishap is recognised or unrecognised.

In the Qualifying Round, the rider can have a restart due to having suffered a mishap if he has not already had a restart. If a rider has a mishap for a second time in the Qualifying Round the rider is eliminated.

If the mishap happens in the first half lap, the Starter must stop the race and immediately bring the riders back to the line for a restart. If the rider has already had a restart in that round, the Starter should not stop the race unless the track is obstructed.

After the first half lap the race is not stopped. Any rider who has a mishap after this point can have another ride at the end of the round if he or she has not already had a restart in that round.

MISHAPS - FINAL

It does not matter if the mishap is recognised or unrecognised.

In the Final each rider is permitted one restart due to a mishap, provided this has happened in the first half lap, and that he has not already had a restart in this round.

There are two phases to consider:

- first half lap,
- after the first half lap.

• If the mishap happens in the first half lap, the Starter must stop the race and immediately bring the riders back to the line for a restart. If the rider has already had a restart in that round, the Starter should not stop the race unless the track is obstructed. If the rider stops, the race is over.

• If the mishap occurs after the first half lap, the Starter must pay particular attention to the rider who suffered the mishap. If the rider cannot continue the Starter fires a single pistol shot to end the race, and the rider who had the mishap will lose the race.

9.3.1.5. Specific Commissaire Roles



Please also see chapter 5 for the general duties of all Commissaire roles at track competitions.

SECRETARY

The Secretary must monitor the results for any ties and ensure that these have been broken properly.

If riders are tied on time, the rider with the fastest time on the final lap wins.

The Secretary needs to ensure that all the rounds are formed correctly.

STARTER

The Starter must have an Assistant Starter for this event. They are positioned in the centre of the track, normally standing back-to-back, each monitoring one of the Pursuit Lines and a rider for any mishaps.

Once the Flag Commissaires indicate that their riders are ready, the Starter starts the countdown mechanism. The Starter and Assistant Starter then monitor the start.

In the case of a false start, a double pistol shot must be immediately fired to stop the race. If a rider has already had one restart in that round of the competition, the Starter should not fire the gun unless the other rider is impacted, as this would disadvantage the other rider. The rider having the second false start is relegated.

If something happens to cause a stoppage to the countdown, the Starter must decide to either restart the countdown or resume it from where it was stopped. Normally, if there are more than 30 seconds to the start, the countdown is resumed.

The Starter and Assistant Starter must remain vigilant for the entire event and be ready to intervene if necessary in the case of a mishap.

In the Final only, the Starter fires the pistol to end the race:

- if one rider catches another, a single pistol shot is fired when the rider passes,
- if one rider has a mishap, a single pistol shot is fired once the Starter has determined the rider with the mishap cannot continue,
- if there is no catch, a single pistol shot is fired when each rider finishes.

TIMEKEEPERS

There must be at least one Timekeeper at each Pursuit Line. They must manually record the times of each rider, recording the lap and half-lap times set on the Pursuit Line. They use these times to check the times recorded by the Timing Company.

The times are taken based on the leading edge of the front wheel of the rider crossing the Pursuit Line.

The Timekeepers work with the Lap Board Operators to confirm the laps remaining.

If a World Record is set, the timekeepers are required to sign the World Record application form.

FLAG COMMISSAIRES AND CORNER COMMISSAIRES

The Flag Commissaire must make sure the rider comes to the line promptly and ensure that the bicycle is immediately loaded into the starting gate. As soon as the bicycle is loaded into the starting gate and the gate is locked, the Flag Commissaire indicates this to the Starter by raising the flag. Once the countdown starts, the Flag Commissaire lowers the flag.

While waiting for the start, the Flag Commissaire should stand up near the railing, on the Pursuit Line. From here the Flag Commissaire can monitor the start and assist the Starter with any requests.

If there is an incident prior to the start, the Flag Commissaire must raise the flag to notify the Starter so that the countdown is stopped. The Flag Commissaire then lowers the flag and monitors the situation. Once the situation has been resolved the flag is raised again to indicate to the Starter that the rider is ready.

NOTE

The Flag Commissaire must not react to any potential false starts.

If something happens that obstructs the line after the start, the Flag Commissaire needs to indicate this to the other rider who is approaching, by means of the flag and whistle.

During the race, the Flag Commissaire monitors the conduct of the riders and intervenes if a rider is taking pace from the other, or if a rider tries to repass the other. The Flag Commissaire does this by:

- using the whistle and flag to inform the rider at fault,
- asking the relevant coach on the Safety Zone to indicate to the rider to correct his or her behaviour.

At the end of the heat, the Flag Commissaire monitors the starting gate being brought back on to the track. The Flag Commissaire:

- takes up a position behind the gate with a flag to indicate to riders who have just finished to move up,
- monitors the riders coming on to the track.

Corner Commissaires should be available to replace any pads that may be hit or moved by the passing riders.

NOTE

The Commissaires must not allow the riders who have just finished to continue circulating on the track or Safety Zone. Two laps are sufficient.

OTHER COMMISSAIRES

The PCP monitors the general conduct of the race, especially when there are catches and passes.

The Lap Board and Bell Commissaires on each side must work with each other to ensure that the correct laps are being displayed. This is done by each of them turning their lap board inwards to face the other after their rider has passed. In this way they are able to check each other and make sure the lap numbers are correct.

They must remain vigilant for passes.

9.3.2.

TEAM PURSUIT



The Team Pursuit (**ARTICLES 3.2.077 to 3.2.100**) is essentially the same event as the Individual Pursuit ([see chapter 9.3.1](#)) except that it is for teams. The primary differences between the two events take into account the team nature of the Team Pursuit.

9.3.2.1. Event Overview



The main component of this event is that it is a team time trial. This means that the distance and time need to be controlled.

The second component of this event is that it is a chase. The teams chase each other around the track in an attempt to catch their opponents. If one team catches the other, this may have an impact on the race depending on the round of the event.

This is a standing start event over 4 km.

There are four riders in a team and riders can be changed between rounds.

NOTE

In order to start its heat, a team must be complete, that is it must start with all four riders.

The entire team starts together on the Pursuit Line. The final time of the team is taken on the leading edge of the front wheel of the third rider to cross the line. The fourth rider is not required to complete the race.

Since time is the deciding factor, electronic timing is used.

The finish line is always the Pursuit Line. The start line is also normally the Pursuit Line, depending on the length of the track.

Two teams start at the same time on the Pursuit Lines on opposite sides of the track.

Depending on the level of the competition, the event is ridden in either two or three rounds.

TWO ROUNDS

If the event is ridden in two rounds, these are:

- Qualifying Round,
- Final.

In the Qualifying Round, either two teams start at the same time on the Pursuit Lines on opposite sides of the track, or one team starts at a time. The teams race solely to record a time.

The four fastest teams qualify for the Final.

In the Final, the two fastest teams from the Qualifying Round race for first and second and the next two fastest teams race for third place.

THREE ROUNDS

If the event is ridden in three rounds, these are:

- Qualifying Round,
- First Round,
- Final.

In the Qualifying Round, the eight fastest teams qualify for the First Round.

In the First Round, the teams ride against each other according to the following format, where the number indicates their ranking from the Qualifying Round:

- Heat 1: 6 against 7
- Heat 2: 5 against 8
- Heat 3: 2 against 3
- Heat 4: 1 against 4

All the teams ride to record a time.

In the Final (other than for the Olympic Games) the teams ride against each other as follows:

- the winners of Heats 3 and 4 ride for first and second place,
- all the remaining six teams, winners and losers, are ranked according to their times in the First Round,
- the two fastest teams of the remaining six teams ride for third place.

For the Olympic Games only, there are additional rides for places 5 to 8.

NOTE

The race for third place starts before the race for first and second place.

WINNER

The winner of the event overall is the team that wins the race for first and second place.

NOTE

The winner is not necessarily the team with the fastest time.



Example

A team winning the ride for third place could record a faster time than the team winning the ride for first place. However, the team that wins the event overall is the team winning the ride for first place.

World Records can be established in this event.

9.3.2.2. Track Setup



The start and finish line for this event is the Pursuit Line and since usually two teams start at the same time on opposite sides of the track there needs to be a bell and lap board on both Pursuit Lines.

There also needs to be starting gates on both sides of the track to hold the leading rider as well as countdown apparatus to manage the start.

Since time is the critical factor, electronic timing is required. This is usually done with contact tape switches set up on the Pursuit Line.

Foam pads are placed around the track making the Blue Band unrideable (see Pads in chapter 3.1.2).



TIP

Before the start of the relevant session, Commissaires should place small marks just behind the Pursuit Line to help them with positioning the riders at the start. These marks can be made using non-slip tape. The first mark is where the base of the front wheel is located for the bicycle being held in the starting gate. The second mark is 1 m vertically up the track from this mark. The third mark is a further 1 m vertically up the track from the second mark. The final mark is then an additional 1 m vertically up from the third mark. When the coaches bring their riders to the start line these marks can be used by the Commissaires to ensure the riders are properly lined up for the start. If the Team Sprint event is also being run, don't confuse the marks for the Team Sprint with the marks for the Team Pursuit.

9.3.2.3. Start Order

The starting order of teams for the Qualifying Round is prepared by the Commissaires' Panel. Usually this is done by the Secretary, delegated by the PCP. Depending on the level of the competition (for example World Championships or World Cups), the teams may be seeded on different criteria, including:

- UCI Team Pursuit Ranking,
- defending champions,
- series leaders,
- target time communicated by the team manager at the rider confirmation.

The general principle is that the best teams always start last. However, the Commissaires' Panel always has the right to modify the seeding. This is done to try to prevent the two best teams competing against each other in the Qualifying Round, which could mean the potential finalists facing each other at the start of the event.

If two teams are competing against each other at the same time, the Commissaires must do their best to avoid them catching each other in the Qualifying Round by paying careful attention to the seeding.

In all rounds, the best, or fastest teams, always finish on the home straight.

9.3.2.4. Race Conduct

TEAM COMPONENT

This is a team event for four riders. The team must be complete in order to start the heat. This means a team with just three riders is not permitted to start.

A team's final time is taken on the leading edge of the front wheel of the third rider.

A team can change its riders from one round to the next. They are entitled to change all their riders, provided that the replacement riders have been entered for the Team Pursuit event.

A team wanting to make a change must inform the Secretary at least 30 minutes before the start of the round of the event in which the change is being made.

Changes are not permitted after this deadline. If a team starts with a changed rider, but the Secretary has not been informed of the change within the time limit, the team is disqualified.

TIME TRIAL VERSUS PURSUIT

In the Qualifying Round and First Round, only time is considered. Any teams that are caught must continue their race to record a time. A caught team must drop back and is not permitted to:

- stay in the slipstream of the team that caught it,
- repass the team.

A team that does either of these two things is disqualified.

A team that catches the other team must go past.



TIP

The Flag Commissaires must monitor the conduct of the teams on the track to prevent them taking pace, or one team repassing another. They should be ready to intervene with the team. This can be done by indicating to the team or speaking to the team's coach on the Safety Zone. It is always better to prevent a disqualification.

If one team catches another in the Final, that team wins the ride. It is not necessary to continue in order to record a time.

NOTE

Pay attention here. Sometimes a team that has caught its opponents in the Final will continue on in order to record a time. This is usually done if there is an opportunity to break a record.

THE START

During this event, usually two teams race against each other.

The teams must be ready and waiting at their respective start lines at the Pursuit Lines on the home and back straights.

NOTE

The Start List gives details of each heat; the team starting on the home straight is listed above the team starting on the back straight.



Once the previous heat is finished, the respective Flag Commissaires ask the teams to come to the start line. The coaches bring the leader's bike to the starting gate and the other three riders to the Pursuit Line.

The riders must be positioned vertically up the track with 1 m between each of them. The Commissaires should use the prepared marks on the track to position the bicycles. Once the coaches have riders 2, 3 and 4 in the correct position, Commissaire Holders take over holding the riders. They should hold them just under the saddle with enough pressure to prevent them rolling off, but not so much that they are straining to hold them back.

NOTE

The Start List is not required to list the riders in the correct order of start for each team.

As soon as the leading rider's bicycle is locked into the starting gate, the start countdown of 50 seconds commences. The Starter does not wait for the entire team to be ready, only for the lead bicycles on the back and home straight to be locked into the starting gates.

As soon as the start is given, the starting gate opens to release the rider and the Commissaire Holders release their riders. The rider that was held by the starting gate is the lead rider and must initially lead the team. The other riders follow immediately behind the first rider. If the first rider does not lead the team, this is a false start.

If a team commits a false start, normally by one of the following riders going early, or rider 1 not taking the lead, the Starter immediately stops the race with a double pistol shot. The teams restart without delay. Each team is allowed one restart due to a false start in each round.

NOTE

The Starter must allow a period of time for rider 1 to take the lead. Often times rider 2, 3 or 4 may be ahead of rider 1 at the start. This is allowable for a short distance, and provided rider 1 does take the number 1 position once the team forms up behind each other.

CATCHING AND PASSING

In the Qualifying and First Rounds, when one team catches another, they must both still continue in order to record a time:

- a team may not take pace from the other team,
- a team that has been caught may not re-pass the team that caught it,
- it is the responsibility of the caught team to drop back and remain a proper distance behind the team that passed it.

The Commissaires must be ready to intervene to prevent a team taking pace or re-passing.

If one team catches the other, but does not go past, it will need to drop back.



One team is said to have caught the other team when:

- The catching team has at least three riders riding together,
- The front rider of the catching team is about 1 m behind the back rider of the caught team:
 - if the caught team consists of four riders riding together, this is behind the fourth rider,
 - if the caught team consists of three riders, this is behind the third rider, even if that rider has been dropped by the other two riders.



Once a team is about to catch its opponents, and gets close to that team, the Flag Commissaires on both sides of the track must clearly show the caught team a red flag. This means that the team being caught may not make any changes of rider sequence.

The Commissaires must continue to show the team being caught a red flag until either the team has been passed, or in the Final, the Starter fires the pistol and the catching team stops.

If a team makes a change after the red flag is shown it is immediately disqualified.

NOTE

The Commissaires must show the flag earlier rather than later. If there is the possibility of one team catching another in the next half lap, the Commissaires must show the team being caught the red flag, even if the catching team does not immediately go past.

MISHAPS – QUALIFYING ROUND

It does not matter if the mishap is recognised or unrecognised.

Each team only gets one restart in this round due to mishaps if they have not already had a restart.

If a team has a mishap in the first half lap and has not already had a restart, the Starter must stop the race and the teams restart without delay.

If the same team has a mishap again, the Starter must not stop the race. If only one rider is affected, the team could still continue. If the Starter stops the race, then that team would be eliminated as it has already had a restart. It does not matter if the restart was due to a false start or a mishap.

After the first half lap, the Starter must not stop the race unless the track becomes obstructed. If a team has a mishap it can choose to stop if it has not already had a restart, or if it still has three riders, it can choose to continue. If the team chooses to stop, it must do so within one lap of the mishap. If the team stops later than this, it is eliminated.

Any team that stops but has not yet had a restart, gets a restart at the end of the round.

MISHAPS – FIRST ROUND AND FINAL

It does not matter if the mishap is recognised or unrecognised.

Each team gets only one restart in this round due to mishaps if they have not already had a restart.

If a team has a mishap in the first half lap and has not already had a restart, the Starter stops the race and the teams restart without delay.

After the first half lap, the Starter does not stop the race. The team must continue. If it cannot continue, it loses the race.

9.3.2.5. Specific Commissaire Roles

Please see chapter 5 for the general duties of all Commissaire roles at track competitions as well as chapter 9.3.1.5, for the roles of the Commissaires at the Individual Pursuit event.

SECRETARY

The Secretary oversees any changes in team compositions:

- monitors the time limit for changes,
- updates the start list,
- ensures all the Commissaires are informed of the changes.

The Secretary also monitors the results for any ties and ensures that these have been broken properly.

The Secretary needs to ensure that all the rounds are formed correctly.

STARTER

The Starter must have an Assistant Starter for this event. They are positioned in the centre of the track, normally standing back-to-back, each monitoring one of the Pursuit Lines and a team for any mishaps.

The Starter and Assistant Starter monitor the formation of the team on the start line. If a team is not lined up properly they can ask the Flag Commissaire to intervene to resolve the issue.

Once the Flag Commissaires indicate that both the teams are ready, the Starter starts the countdown mechanism and then monitors the start together with the Assistant Starter.

In the case of a false start, the Starter immediately fires a double pistol shot to stop the race. If the team has already had a restart in that round of the competition, the team is relegated.

If something happens to cause a stoppage to the countdown, the Starter must decide to either restart the countdown or resume it from where it was stopped. Normally, if there are more than 30 seconds to the start, the countdown is resumed.

The Starter and Assistant Starter must remain vigilant for the entire event and be ready to intervene if necessary in the case of a mishap.

In the Final only, the Starter fires the pistol to end the race:

- if one team catches the other, the pistol is fired once when the team is caught,
- if there is no catch, the pistol is fired once when each team finishes.

TIMEKEEPERS

There must be at least one Timekeeper at each Pursuit Line. They must manually record the times of each team, recording the lap and half-lap times set on the Pursuit Line. They use these times to check the times recorded by the Timing Company.

The times are taken based on the leading edge of the front wheel of the front rider crossing the Pursuit Line, except for the final lap, where the leading edge of the front wheel of the third rider in the team crossing the Pursuit Line is used.

If a World Record is set, the timekeepers are required to sign the World Record application form.

FLAG COMMISSAIRES AND CORNER COMMISSAIRES

The Flag Commissaire must make sure the team comes to the line promptly and ensures that the lead bicycle is immediately loaded into the starting gate and does not wait for the rest of the team to get ready. As soon as the bicycle is loaded into the starting gate and the gate is locked, the Flag Commissaire indicates this to the Starter by raising the flag. Once the countdown starts, the flag is lowered.

The Flag Commissaire monitors the riders being brought to the line.

- The Flag Commissaire verifies that the riders on the line are the correct riders. If there is a discrepancy, he or she first checks with the Secretary to make sure there were no changes. If there is still a discrepancy, the Starter and PCP are informed.
- The Flag Commissaire ensures that the riders are positioned correctly.

While waiting for the start, the Flag Commissaire should stand up near the railing, on the Pursuit Line. From here the Flag Commissaire can monitor the start and assist the Starter with any requests.

If there is an incident prior to the start, the Flag Commissaire must raise the flag to notify the Starter so that the countdown is stopped. The Flag Commissaire then lowers the flag and monitors the situation. Once the situation has been resolved the flag is raised again to indicate to the Starter that the team is ready.

NOTE

The Flag Commissaire must not react to any potential false starts.

If something happens that obstructs the line after the start, the Flag Commissaire needs to indicate this to the other team as they approach, by means of the flag and whistle.

During the race, the Flag Commissaire monitors the conduct of the teams and intervenes if one team is taking pace from the other, or if a team tries to repass the other. The Flag Commissaire does this by:

- using the whistle and flag to inform the team at fault,
- by asking the relevant coach on the Safety Zone to indicate to the team to correct its behaviour.

The Flag Commissaires must also monitor a team catching and passing the other team. The team being caught is clearly shown the red flag to let it know that it may not make any more changes of rider sequence. The Flag Commissaires continue to show the team being caught a red flag until either the team has been passed, or in the Final, the Starter fires the gun and the catching team stops.

At the end of the heat the Flag Commissaire monitors the starting gate being brought back on to the track. The Flag Commissaire:

- takes up a position behind the gate with a flag to indicate to riders who have just finished to move up,
- monitors the riders coming on to the track,
- asks the Commissaire Holders to assist.

Corner Commissaires should be available to replace any pads that may be hit or moved by the passing teams.

Corner Commissaires may be required to help with holding.

NOTE

The Commissaires must not allow the riders who have just finished to continue circulating on the track or Safety Zone. Two laps are sufficient.

OTHER COMMISSAIRES



The PCP monitors the general conduct of the teams in the race, paying special attention to catches and passes.

Commissaire Holders are located on the Pursuit Lines. These Commissaires hold riders 2, 3 and 4 for the start. The Commissaires must position themselves in the correct place on the track. They can use the marks prepared on the Pursuit Line to help with this. The coaches are required to position the riders correctly. Once they are in the correct position, the Commissaire Holders take over holding the riders.

When the lead rider is released from the starting gate, the Commissaire Holders release their riders.

They should hold the riders firmly, but if the rider pulls away, they should let the rider go.

At the end of the heat, the Commissaire Holders help the Flag Commissaires with bringing the starting gate and next team out on to the track.



REQUIRED KNOWLEDGE

- Specific regulations for pursuit events.
- Track set-up for each event.
- Specific functions of each Commissaire role in each event.
- Actions to be taken in the case of mishaps in the various rounds.
- When team changes can be made.



WHAT TO DO

- Verify team compositions prior to the team starting.
- Ensure all members of the Commissaires' Panel are appropriately positioned.
- Be discreet in response to incidents.
- Be consistent.
- Remain focused on your role.



WHAT NOT TO DO

- Fail to respond to false starts.
- Refuse to assist in another Commissaire role if required (for example, holding or monitoring the pads).
- Leave the race management and decisions to the organiser or a member of the Commissaires' Panel even though you are the PCP and the decision is your responsibility.
- Apply decisions without considering their impact throughout the competition.

9.4. ENDURANCE EVENTS

Track events can be divided into four broad categories, the third of which includes Endurance events. Endurance events are generally the bunch races on the track.

All Commissaires must have a good knowledge of the general tasks and functions of the various Commissaire roles, as described in chapter 5 of this guide. This section only describes Commissaire roles where these are different or unique compared to the information provided in chapter 5.

The general requirements for the track set up, as well as descriptions of track equipment and installations, are provided in chapter 3.

Equipment requirements are explained in more detail in chapter 11.

9.4.1. POINTS RACE

Bunch races are the most complex events on the track and require Commissaires to be able to quickly change their focus from narrow issues to a broad overview at just the right time.



The Points Race (**ARTICLES 3.2.114 to 3.2.133**) is the most complex of the bunch races; a good understanding of this event makes it easier to understand the other bunch races.

9.4.1.1. Event Overview

The Points Race is a bunch race over a set distance that depends on the level of the competition and rider category.

Riders earn points by winning sprints at set intervals and by gaining laps.



The number of sprints and the distance between the sprints is defined in the regulations (**ARTICLES 3.2.116 and 3.2.117**). The first four riders in each sprint score 5, 3, 2, and 1 points respectively. In the final sprint at the end of the race, the first four riders score 10, 6, 4 and 2 points respectively.

A rider scores 20 points when gaining a lap.

A rider is deducted 20 points when losing a lap.

The winner is the rider with the most points at the end of the race.

If the number of riders entered for the event exceeds the track maximum, heats must be held. The length of the heats and number of sprints are defined in the regulations.

NOTE

It is not a requirement to have the maximum possible number of riders in the Points Race Final if heats are required. The heats should be competitive, and the Commissaires' Panel decides how many riders from each heat go through to the Final. The only requirements are:

- the heats must be balanced in terms of the best riders,
- each heat must have the same number of riders (one heat can have one more in the case of an odd number of riders),
- the same number of riders from each heat qualify for the Final.

9.4.1.2. Track Setup

There is a lap board and bell on the Finish Line.

A whiteboard and marker pens are required. The PCP writes a number on the whiteboard and holds it up with a yellow or red flag to indicate warnings and disqualifications to the riders.



TIP

Ideally a consecutive set of low series race numbers should be used. This makes tracking the riders in the various bunches much easier, giving better control of the race.

9.4.1.3. Start Order

The riders are seeded for the start by the Commissaires' Panel. Usually this is done by the Secretary, delegated by the PCP. Depending on the level of the competition (for example World Championships or World Cups), the riders may be seeded on different criteria, including:

- UCI Points Race Ranking,
- defending champions,
- series leaders.

Riders with no ranking are seeded randomly.

For the start, half the riders line up in single file holding the railing and the other half line up in single file being held by their coaches in the Sprinter's Lane. The riders are lined up based on their seeding, with the highest seeded riders at the front, alternating between the railing and Sprinter's Lane. The Start List must indicate the order of the riders and whether they start on the railing or in the Sprinter's Lane.

| Race Number | Name | Country Code |
|-------------------------|-----------------------|--------------|
| At the fence | | |
| 55 | RAMANAU Raman | BLR |
| 54 | DE KETELE Kenny | BEL |
| 60 | LOVASSY Kriszian | HUN |
| 72 | SCARTEZZINI Michele | ITA |
| 56 | JAMESON Adam | CAN |
| 60 | TERUEL ROVIRA Eloy | ESP |
| 85 | IMHOFF Claudio | ITA |
| 74 | KURABAYASHI Takuo | JPN |
| 61 | KNESKY Morgan | FRA |
| 51 | MEYER Cameron | AUS |
| 88 | KOVALCIK Zachary | USA |
| 78 | DOUGH Regan | NZL |
| At the blue band | | |
| 80 | PSZCZOLARSKI Wojciech | POL |
| 70 | DOWNEY Mark | IRL |
| 86 | RYNOVY Vasily | UKR |
| 59 | LARSEN Niklas | DEN |
| 63 | STEWART Mark | GBR |
| 76 | PANASSENKO Nikita | KAZ |
| 86 | LISS Lukas | GER |
| 52 | GRAP Andreas | AUT |
| 83 | STRAKHOV Dmitri | RUS |
| 82 | MATHIAS João | POR |
| 58 | BLAHA Martin | CZE |
| 67 | CHEUNG King Lok | HKG |

9.4.1.4. Race Conduct

THE START



The race starts and finishes on the Finish Line.

For the start, the riders line up, starting from the Finish Line, in single file on the railing and in the Sprinter's Lane, according to the Start List. The riders who line up in the Sprinter's Lane must bring a holder with them. The position of the riders must be respected.



Once all the riders are present and in the correct position, the Starter, standing on the Safety Zone at the Finish Line, blows a whistle to start a neutral lap. When the riders approach the start line at the end of the neutral lap, the Starter fires the pistol to start the race.

NOTE

The start must only be given if all the riders are riding generally together in a single bunch. If there are riders off the front or back, or if a rider has a mishap, the Starter must indicate to the riders that the neutral laps will continue until all the riders are together in one bunch.

NOTE

Neutral laps are not counted as part of the race distance.

LEADERS AND THE BUNCH

There are two important concepts in bunch races

Leader on the track (Head of the race):

- rider at the front or off the front of the bunch,
- lap board and bell operates on this rider.

Leader of the race:

- rider with the most points,
- this rider would win the race if the race ended at that point.

These two leaders are often not the same person.

The bunch is another important race concept as the awarding of points depends on which group is considered to be the bunch. The bunch is normally taken to be the largest group of riders on the track.

Take care as this can repeatedly change. It is important for the Commissaires to communicate so that everyone understands which group of riders is the bunch. The Commissaires need to be able to quickly recognise which group of riders is the bunch and respond to that.

The decision on which group of riders is the bunch is dependent on several factors:

- size of the group,
- point in the race,
- whether the group is actively racing,
- whether the group is breaking up or forming,
- whether riders are off the front or the back.

In some cases, it may be decided that the largest group on the track is not the bunch. Sometimes the decision on which group is the bunch is made based on anticipating how the race will unfold. What is important is that the decision on which group is the bunch must be clearly communicated by the PCP to all the Commissaires.



Example



The race situation with 2 laps to go to the end of the race is that 2 riders have attacked off the front of the race, and the remaining riders are spread out in groups around the track. These 2 riders are being chased by a group of 4 riders, who are being chased by a group of 5 riders. The remaining 7 riders have sat up and are just riding to the finish, not racing. The 2 riders catch this group of 7 riders in the final lap. If this group of 7 riders, which is the largest group on the track, is declared to be the peloton, then the 2 riders will have gained a lap. However, the 7 riders were not racing and so this could create an unfair situation. In this case, it would be better to declare the chasing group of 5 riders to be the bunch since they are the largest group still racing. This decision would be based on the race being in the final laps and that the largest group is no longer racing.



NOTE

The decision on which group is the bunch requires:

- experience,
- the ability to change focus,
- the ability to anticipate.

LAPPING



A rider gains a lap when he or she laps the bunch. A rider is said to lap the bunch upon reaching the back of the bunch. Sometimes this is very clear, other times it can be complicated, especially if a points sprint is approaching. Sometimes a rider may wait just off the back of the bunch in order to get the sprint points, before then lapping the bunch.

The Commissaires must consider the following when deciding on whether a rider has gained a lap:

- cohesiveness of bunch (is the bunch riding together or are riders being dropped),
- proximity to sprint lap (how close is the rider to a sprint lap),
- proximity to back rider in bunch (how close is the rider to the last rider still considered to be in the bunch – not riders being dropped off the back of the bunch),
- racing posture of rider (is the rider attempting to gain the bunch).

Once a rider gains a lap, any riders off the front of the bunch who were behind this rider now become the leaders on the track. When a rider gains a lap, this must be clearly communicated by the responsible Commissaire to all other Commissaires and the Timing Company.

The lap board is always changed on the leaders on the track.

NOTE

If a rider gains a lap, the lap board is changed immediately, and is then operated on the new leader on the track.

NOTE

The lap board must not be changed more than once a lap.

If the leader on the track gets the bell to indicate the start of a points sprint, and laps the bunch before the bunch gets to the Finish Line, the rider gets 20 points for lapping the field but the points for the sprint are awarded to the riders at the front of the bunch.

NOTE

The bell is only rung once, loudly, to indicate the start of a sprint lap when the leader crosses the finish line.

Riders who have been dropped by the bunch are not permitted to help riders who are off the front of the bunch. Specifically, they may not lead any riders trying to lap the bunch. If they do so, they should be warned, and if persisting, disqualified.

Any riders off the back of the bunch can be brought back to the bunch by riders lapping the field.

A rider loses a lap upon being caught by the bunch.

Any riders off the back of the bunch, who have been caught by riders off the front of the bunch, do not score points in any points sprints.

NOTE

Commissaires must pay careful attention to who is off the back of the bunch and who is off the front of the bunch.

| | |
|---|--|
| <p>①</p> <p>up</p> <p>40 47 48 49 50 51 52 53 54 55 56 57 58 59 60 61 62 63 64 65 66 67 68 69 70 71 72 73 74 75 76 77 78 79 80 81 82 83 84 85 86 87 88 89 90 91 92 93 94 95 96 97 98 99 100</p> <p>41</p> | <p>②</p> <p>down</p> <p>21 22 23 24 25 26 27 28 29 30 31 32 33 34 35 36 37 38 39 40 41 42 43 44 45 46 47 48 49 50 51 52 53 54 55 56 57 58 59 60 61 62 63 64 65 66 67 68 69 70 71 72 73 74 75 76 77 78 79 80 81 82 83 84 85 86 87 88 89 90 91 92 93 94 95 96 97 98 99 100</p> <p>41</p> |
| <p>+</p> <p>17</p> <p>49</p> | <p>-</p> <p>10</p> |
| <p>+</p> <p>17</p> <p>49</p> | <p>-</p> <p>41</p> <p>40</p> <p>27</p> <p>10</p> |

TIP

- All Commissaires who are monitoring the race should make notes to keep track of riders:
- off the front,
 - off the back,
 - who have lost laps,
 - who have gained laps.

Commissaires should use a simple system that is easy to use and works for them. This is known as scoring the race. Ideally a Commissaire should be able to recall every situation during a race if necessary.

When a rider loses a lap, this must be clearly communicated by the responsible Commissaire to all Commissaires and the Timing Company. This rider then loses 20 points.

A rider who has lost a lap is allowed to score points again and can also lead other riders.

TIP

The Commissaires should pay attention to possible collusion when a rider who has lost a lap then leads other riders. The Commissaires should ask themselves if this rider is riding for his or her own result or for another rider.

If a rider loses more than one lap the Commissaires can decide to take him or her out of the race.

TIP

If a rider is to be taken out of the race, do not wait for the rider to actually lose the second lap. While the rider is off the back of the bunch the responsible Commissaire should indicate to him or her to leave the race. The rider's coach in the pits can also be informed.

MISHAP AND THE PITS



Each rider is permitted to have one coach on the Safety Zone. Unless there is a mishap, this coach is required to remain in the team pits area, normally located on the back straight near the Pursuit Line. A Commissaire should be placed in this area to monitor their conduct.

Equipment must not be kept on the Safety Zone or hung from the fencing on the inside of the track. All spare equipment, as well as additional mechanics, must remain on the infield and must not be on the ramp.

A rider who has a recognised mishap can take out the number of laps closest to 1250 m to get back into the group with which he or she was racing.

+ See the section on Crashes in chapter 9.1.3 for more information.

Example

On a 250 m track the rider is allowed up to 5 laps to return to the track.

Once these laps have elapsed, if the rider has not returned to the group he or she was in, the rider starts to lose laps.

NOTE

Do not return a rider to the track who has lost two or more laps.

If a rider has a recognised mishap in the final 1 km, he or she is not allowed to return to the track but keeps the points scored and is placed in the results accordingly.



TIP

All Commissaires must be fully aware when the final 1 km start.

If a rider has had a recognised mishap, and the final kilometre starts while they still have permitted laps to return, the rider does not return but keeps the points scored and is placed in the results accordingly.

If there is a crash that causes the race to be stopped, then if the race is restarted, the riders start as one group, keeping their points already scored.

MANAGING AND SCORING THE RACE

The keys to success in managing this event are:

- continuous communication between the Commissaires,
- ability to change focus,
- constantly scoring the race.

The following information should be communicated to all Commissaires as required, usually over the radio:

- who is the leader on the track,
- which group is the bunch,
- riders who have gained a lap,
- riders who have lost a lap.



TIP

Commissaires must not let team personnel distract them from their job during the race. It is very easy to lose track of the race. Be firm but polite and advise any team personnel who wish to talk to you during the race to come back after the event.

The situations below offer some general guiding principles. However, almost every situation is unique. It is also important to consider the race as a whole.

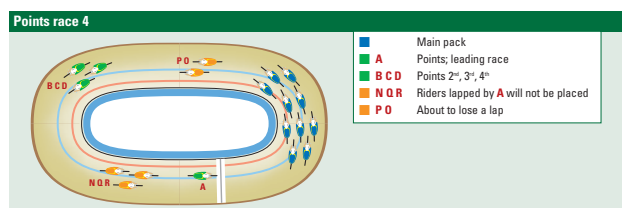
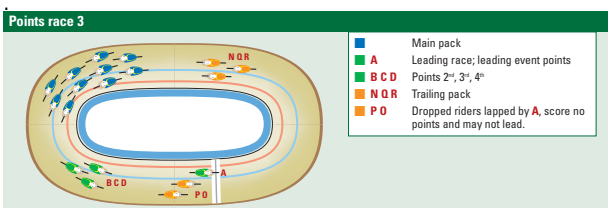
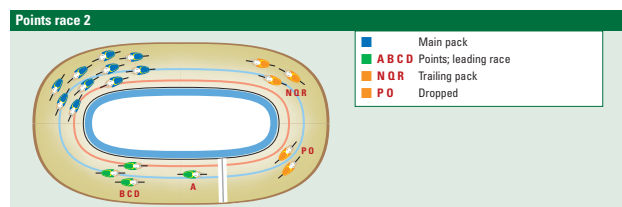
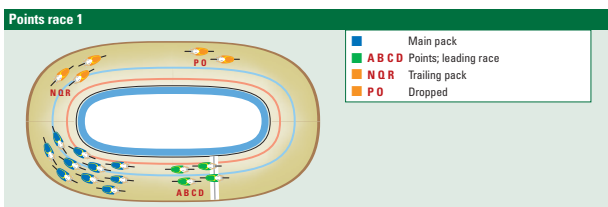

Points race 5

4th place in pack placings

- Main pack
- A** Rider **A** has caught up main pack. He gains 1 lap so 20 points.
- B C D** Leading race – score points and are about to take 1 lap (they are considered as being on the same lap as the pack).
- N Q R** Resume their positions in the pack.
- P O** Have lost a lap, so lose 20 points.

Points race 6

- Main pack
- A** Rider **A** race leader for lap countdown.
- B C D** Race leaders winning the points and about to gain a lap so 20 points.
- P O** Riders trying to regain lost lap so 20 points – points for 4th place.

Points race 7

- Main pack
- C D** The bell rings on **C** and **D** for the last sprint.
- B P O** Riders **B, P** and **O** rejoin pack, win 1 lap so 20 points. **P** and **O** regain the lap they had lost so gain 20 points and are back at 0 points like the pack.

Points race 8

- Main pack
- C D** Riders **C** and **D** have rejoined pack, gain 1 lap so 20 points.

Riders' final placings decided on points

Whole pack is at the finish

Points race 9

- Lead group **A**
- Group **B**
- Group **C**

Three similar groups. Group **A** gaining on **C**.

Points race 10

- Group **A** catches Group **C**
- Group **B**
- Group **C**

Riders **A** gain 1 lap when they catch Group **C** (main group) so 20 points. Sprints points are awarded to riders **B**.

Points race 11 (1st situation)

The bell rings on A, B and C

Last lap for lead riders. The bell rings, the pack crosses the line.

Points race 12

Whole pack is at the finish

Riders **A, B** and **C** have rejoined the pack, they gain 1 lap so 20 points. Points will be awarded to the riders leading the pack immediately they cross the line which will determine the placing for the final finishing sprint.

Note: in this situation the pack completes one lap less.

RESULTS

The rider with the most points wins the race. If any riders are tied on points, the tie is broken based on their respective placings in the final sprint.

9.4.1.5. Specific Commissaire Roles



Please also see chapter 5 for the general duties of all Commissaire roles at track competitions.

PRESIDENT

The PCP is ultimately responsible for the race. The PCP assigns the members of the Commissaires' Panel to the various tasks associated with the Points Race and ensures there is good communication between them. The PCP has several duties during the race, some of which may be delegated to other Commissaires.

The PCP is responsible for:

- declaring the bunch,
- making the final decision on who gains and loses laps,
- assisting the Judge-Referee on judging sportsmanlike conduct,
- issuing all warnings and disqualifications, including those from the Judge-Referee,
- removing lapped riders.

The PCP must keep an overall picture and score the race.

SECRETARY

The Secretary keeps a note of all points awarded as well as laps won and lost.

The Secretary works with the Scoring Commissaire to track the race status and liaises with the Scoring Commissaire and Finish Judge to verify the results.

The Secretary must also monitor the Speaker and the scoreboard to ensure that the race status is constantly announced and displayed, and is current and correct.

STARTER

The Starter works with an Assistant Starter at the beginning of the race to ensure all the riders are in the correct position for the start and to identify any non-starters. They also make a final quick review of the equipment being used.

The Starter must inform the Finish Judge and Secretary of any non-starters.

The Starter starts the neutral lap and then fires the pistol to commence the race once all the riders are together.



The PCP will normally delegate the role of indicating the leader on the track (head of the race) to the Starter. The Starter does this by clearly pointing to the leading rider as he or she comes down the home straight. The other Commissaires and Timing Company watch for this.

NOTE

The Starter should only point to the leader on the track when he or she is on the home straight. If the leader has attacked and is on the back straight while the bunch is on the home straight, and the Starter points to the leader on the back straight, this will provide information to the bunch and give it an unfair advantage.

In the case of a major crash or if the track is obstructed, the Starter stops the race with a double pistol shot.

JUDGE-REFEREE

The Judge-Referee monitors the conduct of the riders in each of the sprints. The Judge-Referee must pay careful attention in the laps leading up to the sprint as sometimes what happens in the sprint itself has been influenced by an incident that happened earlier.

The Judge-Referee also monitors the general conduct of the riders.

The Judge-Referee takes advantage of a good overall view of the track to monitor the status of the race. This means the Judge-Referee scores the race but this is not his or her primary function and the PCP must not rely on this information.

FINISH JUDGE

The Finish Judge usually works with an assistant.

The Finish Judge records the result of each sprint and the finish and verifies the result from the photo-finish operator. The Finish Judge must record more than the top four riders in case there are relegations.

At the end of each sprint the Finish Judge gives the Secretary and Scoring Commissaire the result of the sprint in writing.

At the end of the race the Finish Judge works with the Secretary and Scoring Commissaire to finalise the result.

CORNER COMMISSAIRES AND FLAG COMMISSAIRES

The Flag Commissaire on the back straight monitors the conduct of the coaches in the team pit area. In the case of any warnings or disqualifications, the Flag Commissaire works with the PCP to inform the relevant coach.



In the case of mishaps, the relevant Corner Commissaire or Flag Commissaire works with the PCP in monitoring the return of the rider to the track, keeping note of the number of laps the rider is out. If, after the permitted number of laps out, the rider has lost two or more laps to the bunch, he or she must not be allowed to return to the track.

SCORING COMMISSAIRES

The Scoring Commissaire keeps track of the points won and lost using a Points Table. An example Points Table can be found in chapter 15.2.1.

The Scoring Commissaire receives this information from the Finish Judge.

Whatever Points Table is used, it must show a record of how the points are scored and keep a running total.



TIP

The Points Table must be a manual record on paper in case the electronic system fails.

The Scoring Commissaire must monitor the scoreboard to ensure that the points displayed are correct.

At the end of the race, the Scoring Commissaire works with the Secretary and Finish Judge to verify the results.

LAP BOARD AND BELL COMMISSAIRE

The Lap Board and Bell Commissaire is a critical role that requires complete focus. It is a very responsible job.

This official must be sure of the number of laps of the race, as well as the laps on which the bell must be rung to indicate the start of a sprint lap. The Lap Board and Bell Commissaire must clearly ring the bell at the start of these laps.

The Lap Board and Bell Commissaire must stay focused on which rider is the leader on the track.

When a rider gains a lap, the Lap Board and Bell Commissaire advances the lap board to the new leader on the track.

OTHER COMMISSAIRES

One or two Commissaires may be assigned to record which riders lose and gain laps. These Commissaires must be aware of:

- which group of riders constitutes the bunch,
- which rider is the leader on the track.

Their focus is on the riders off the front and back of the bunch.

When riders lose or gain laps, they note this information down and hand it to the Secretary.

These Commissaires also keep a record of any riders abandoning or being withdrawn from the race.

9.4.2. MADISON

The Madison (**ARTICLES 3.2.156 to 3.2.172**) is essentially a Points Race for teams of two riders. Most of the differences between the events are due to the team nature of the race.

The information provided in chapter 9.4.1 for the Points Race applies. Only the differences relevant to the Madison are highlighted below.

9.4.2.1. Event Overview

The Madison is a bunch race contested by teams of two riders over a set distance that depends on the level of competition and rider category.

One of the two riders in the team must always be racing (the racing rider). While this rider is racing, the other member of the team rolls around the track waiting to be relayed into the race (the relief rider).

Teams earn points by winning sprints at set intervals and by gaining laps. Only the racing rider is considered when deciding who wins the points.

The number of sprints and distance between sprints is defined in the regulations (**ARTICLES 3.2.116 and 3.2.117**). The first four racing riders in each sprint score 5, 3, 2, and 1 points respectively. In the final sprint at the end of the race, the first four racing riders score 10, 6, 4 and 2 points respectively.

When a team gains a lap, it scores 20 points.

When a team loses a lap, it loses 20 points.

The winner is the team with the most points at the end of the race.

If the number of teams entered for the event exceeds the track maximum, heats must be held. The length of the heats and number of sprints are defined in the regulations.

NOTE

It is not a requirement to have the maximum possible number of teams in the Madison Final if heats are required. The heats should also be competitive, and the Commissaires' Panel decides how many teams from each heat go through to the Final. The only requirements are:

- the heats must be balanced in terms of the best teams,
- each heat must have the same number of teams (one heat can have one more in the case of an odd number of teams)
- the same number of teams from each heat qualify for the Final.

9.4.2.2. Track Setup

The track setup for the Madison is the same as for the Points Race.



The riders' race numbers should be a consecutive series starting from 1. There must be two pairs of each number, one pair red and one pair black.

One member of the team wears the black numbers and the other member wears the red numbers. It must be noted which rider is wearing which colour in case a decision about a rider needs to be made. It does not matter which colour numbers a rider wears in terms of who starts.

9.4.2.3. Start Order

The teams are seeded for the start by the Commissaires' Panel. Usually this is done by the Secretary, delegated by the PCP. Depending on the level of the competition (for example World Championships or World Cups), the teams may be seeded on different criteria, including:

- UCI Madison Ranking,
- defending champions,
- series leaders.

Teams with no ranking are seeded randomly.

On the Start List, the teams are listed in numerical order, with information on which rider is wearing the red number and which the black number.

UCI 2017 TRACK CYCLING WORLD CHAMPIONSHIPS HONG-KONG CHINA
 PRESENTED BY **TISSOT**
 13-16 April 2017 Communiqué no. 127

Women's Madison / Madison femmes
 Final / Finale
 Start List / Liste de départ
 Sat 15 Apr 2017 - Race distance: 120 laps (30km) with 12 sprints

| Race Number | Team | Colour | Name |
|-------------|----------------------|--------|--------------------------------|
| 1 | GBR - Great Britain | BLACK | BARKER Elinor |
| | | RED | NELSON Emily |
| 2 | AUS - Australia | BLACK | CURE Amy |
| | | RED | MANLY Alexandra |
| 3 | FRA - France | BLACK | DEMAY Coralie |
| | | RED | BERTHON Laurie |
| 4 | RUS - Russia | BLACK | AVERINA Maria |
| | | RED | KLIMOVA Diana |
| 5 | ITA - Italy | BLACK | CONFALONIERI Maria Giulia |
| | | RED | BARBIERI Raechle |
| 6 | NZL - New Zealand | BLACK | SHEATH Raquel |
| | | RED | DRUMMOND Michaela |
| 7 | UKR - Ukraine | BLACK | NAHRINA Anna |
| | | RED | KLACHINA Oksana |
| 8 | HKG - Hong Kong | BLACK | MENG Zhaojuan |
| | | RED | PANG Yao |
| 9 | IRL - Ireland | BLACK | GURLEY Lydia |
| | | RED | BOYLEAN Lydia |
| 10 | CZE - Czech Republic | BLACK | MACHOČOVA Jarmila |
| | | RED | HOCHMANN Lucie |
| 11 | BEL - Belgium | BLACK | KOPECKY Lotte |
| | | RED | DHOORE Jorien |
| 12 | BLR - Belarus | BLACK | PATROUSKAYA Katsaryna |
| | | RED | PRONAROVA Polina |
| 13 | POL - Poland | BLACK | PKULIK Daria |
| | | RED | PLUSAJ Nici |
| 14 | USA - United States | BLACK | ZUBRS Kimberly |
| | | RED | GEIST Kimberly |
| 15 | MEX - Mexico | BLACK | SALAZAR VAZQUEZ Lisbeth Yareli |
| | | RED | ARREOLA NAVARRO Sofia |
| 16 | CAN - Canada | BLACK | BROWN Laura |
| | | RED | ROORDA Stephanie |

www.hktrackcycling.com www.uci.ch Timing and Results provided by **TISSOT**
 Report Created: FRI 14 APR 2017 15:42 Page 1/2

TISSOT SHIMANO HONG KONG TACX 香港體育委員會 2017 UCI TRACK CYCLING WORLD CHAMPIONSHIPS HONG KONG CHINA HKT THE CLUB 中華人壽保險(海外)有限公司

9.4.2.4. Race Conduct

THE START

The race starts and finishes on the Finish Line.



For the start, the racing riders line up in numerical order along the railing behind the Finish Line on the home straight. The relief riders line up, in any order, along the railing on the back straight.

Once all the riders, racing and relief, are present, the Starter blows a whistle to commence a neutral lap for the racing riders. The relief riders remain on the railing. When the racing riders, riding as a group, approach the start line at the end of the neutral lap, the Starter fires the pistol to start the race. The relief riders are not supposed to leave the railing on the back straight until the pistol has fired. However, some early movement should be tolerated if it happens once the racing riders have passed them on their neutral lap.

Once the pistol is fired to start the race, the relief riders let go of the railing. Some delay should be tolerated. If after a lap of racing a relief rider is still holding on to the railing, he or she must be asked to let go.

THE RELAY

During the event, one member of the team must always be racing. There is no restriction on how many laps the racing rider must do before relaying in the relief rider.



The racing rider relays in the relief rider by making contact with him or her. This contact can be done in any way, but is usually achieved by:

- a hand sling,
- touching or pushing the teammate by the shorts.

The riders must make contact. In normal circumstances, if the racing rider does not make contact with the relief rider, the relay is not conducted and the rider must continue racing. If this does not happen, the rider should be warned. If the behaviour continues, the rider should be disqualified.

NOTE

Commissaires must be careful when considering the relay. If the riders are set up to perform the relay and are at the same height on the track, this should be taken into consideration. Sometimes the two riders could be in position to make a relay but there is a rider between them that prevents this. An exchange with no contact can be tolerated in this case. There is no advantage as the rider has to accelerate to race speed without the benefit of a hand sling.

NOTE

Any warnings or disqualifications issued to one of the riders apply to the team.

Other riders may not interfere with a relay.

LEADERS AND THE BUNCH

The leaders and the bunch are defined in the same way as for the Points Race. In the Madison, you consider the position of the racing rider, not the relief rider.

LAPPING

The way in which lapping is defined is the same as for the Points Race. In the Madison, you consider the position of the racing rider, not the relief rider.

MISHAPS AND THE PITS

If one of the team members has a mishap, the other rider must either stay in the race as the racing rider, or, if the unaffected rider was the relief rider, immediately join the group the racing rider was with and act as the racing rider until the teammate can be relayed in.

There is no restriction on how long a team member can be out of the race, as long as the racing rider remains in the race. The one restriction is that no riders are allowed to return to the race in the final kilometre. In this case the racing rider would have to continue, racing until the finish.

If both riders have a mishap, the team gets a neutralisation of a maximum of the number of laps closest to 1250 m. By the end of this 1250 m, one of the riders must be back in the race as the racing rider. This is managed in the same way as it is in the Points Race.

If both riders of the team have a mishap in the final kilometre, then neither rider returns to the track. However, the team keeps the points that it had at the time of the incident.

NOTE

It is permissible for the relief rider to stop on the Safety Zone in order to make an equipment change. The Commissaires must monitor the conduct of this rider and team manager. There is no restriction on how long the rider may receive this support. The only requirements are that the racing rider is required to remain the racing rider for the entire period, and that the relief rider is not allowed to return in the final 1 km.

RELIEF RIDER CONDUCT

Once the racing rider is relayed out, he or she becomes the relief rider.

The relief rider may not:

- obstruct any of the racing riders (it is the relief rider's responsibility to stay out of the way),
- obstruct any riders making relays,
- stop and rest on the railing (the rider must keep rolling) or in the Safety Zone (relief riders must stay above the Stayer's Line),
- feed (in some situations this may be permitted, but it is unusual. If feeding is allowed it is always from the coaches in the Team Pits and to the relief rider only).

MANAGEMENT AND SCORING OF THE RACE

The management and scoring of the race is the same as for the Points Race. It is always the racing rider that is considered.

There are only a few differences as a result of the team nature.



TIP

If a team needs to be withdrawn, this can be done easily by withdrawing the relief rider first. It is much easier to communicate with this rider.



TIP

One race management technique is to constantly count the racing riders on the track in order to identify where all of them are.

RESULTS

The results are calculated in the same way as for the Points Race.

9.4.2.5. Specific Commissaire Roles

Please see chapter 5 for the general duties of all Commissaire roles at track competitions as well as chapter 9.4.1.5 for the roles of Commissaires during the Points Race.

The main difference between the two events is that the Madison requires a higher level of attention: the conduct of the relief rider and both riders during the relay also has to be monitored.

9.4.3.

SCRATCH RACE



The Scratch Race (**ARTICLES 3.2.173 to 3.2.183**) is very similar to a Points Race, although there are no sprints for points. Most of the differences between the events are due to it being purely a distance event on the track.

The information provided in chapter 9.4.1 applies. Only the differences relevant to the Scratch Race are highlighted below.

9.4.3.1. Event Overview

The Scratch Race is a bunch race over a set distance that depends on the level of competition and rider category.

The winner is the first rider across the line at the end of the race, taking into account any laps gained. So, for example, if just one rider has lapped the bunch, then this rider will win the race at the end of the event. If two riders have lapped the bunch, then the first rider of the two to cross the finish line at the end of the event wins the race.

Riders lapped by the bunch are eliminated.

If the number of riders entered for the event exceeds the track maximum, then heats must be held. The length of the heats is defined in the regulations.

NOTE

It is not a requirement to have the maximum possible number of riders in the Scratch Race Final if heats are required. The heats should be competitive, and the Commissaires' Panel decides how many riders from each heat go through to the Final. The only requirements are:

- the heats must be balanced in terms of the best riders
- each heat must have the same number of riders (one heat can have one more in the case of an odd number of riders)
- the same number of riders from each heat qualify for the Final.

9.4.3.2. Track Setup

The track setup for the Scratch Race is the same as for the Points Race.

9.4.3.3. Start Order

The way in which the start order is prepared is the same as for the Points Race, except that the UCI Scratch Race ranking is used.

9.4.3.4. Race Conduct

THE START

The start is managed in the same way as for the Points Race.

LEADERS AND THE BUNCH

The leaders and the bunch are defined and managed in a very similar way to the Points Race. The principle difference is due to there being no points awarded in the race.

The leader of the race is any rider who has lapped the bunch. If more than one rider has lapped the bunch, then between these riders, the leader is the rider who is furthest ahead. In the Scratch Race, distance is the only determination.

LAPPING

The way in which riders gain and lose laps is the same as in the Points Race.

A rider is immediately eliminated upon losing a lap.

NOTE

The rider must have lost a lap to the bunch to be eliminated. If, for example, a rider had gained a lap but is then later dropped and lapped by the bunch, the rider is not eliminated as he or she is now on the same lap as the bunch.

NOTE

Deciding which group of riders is the bunch in the Scratch Race is very important, as any riders who are dropped by this group and lose a lap are eliminated.

MISHAPS AND THE PITS

The use of the team pit area and the management of mishaps is the same as for the Points Race.

However, if a rider suffering a mishap loses one or more laps to the bunch at the end of the permitted neutralisation period, the rider is eliminated and must not be allowed to return to the track.

No riders are permitted to return in the final kilometre. Any rider not allowed to return does not finish the race.

MANAGEMENT AND SCORING OF THE RACE

The management and scoring of the race is achieved in the same way as for the Points Race.

RESULTS

Only riders who finish the race are classified in the results. The winner is the first rider across the finish line, taking into account any laps gained.

9.4.3.5. Specific Commissaire Roles

Please see chapter 5 for the general duties of all Commissaire roles at track competitions as well as chapter 9.4.1.5 for the roles of the Commissaires at the Points Race event.

The main difference between the two events is that no points are awarded during the Scratch Race. Consequently, a Scoring Commissaire is not required.

9.4.4. ELIMINATION

 The Elimination (**ARTICLES 3.2.218 to 3.2.226BIS**) features many of the components of the other bunch races. However, as riders are constantly being eliminated, this leads to some unique challenges.

9.4.4.1. Event Overview

The Elimination is a bunch race on the track where the last rider across the Finish Line every lap, or second lap, is eliminated until there are just two riders left on the track. These riders then sprint for first and second place, with the winner being the first rider across the finish line at the end of the race.

The distance of the race depends on the number of riders on the track at the start of the race.

9.4.4.2. Track Setup

The track is set up in the same way as for the Points Race.

The lap board is not used.

If the elimination is every second lap, the bell is used to indicate the start of an elimination lap. If the elimination is every lap, the bell is not used.

The scoreboard and lap boards on the Pursuit Lines are used to display the number of the rider who has been eliminated. These lap boards should be turned to face the riders on the track.



For major competitions, every rider is supplied with an electronic elimination signalling device to attach to their handlebars. A panel at the Secretariat is used to control these devices. When a rider is eliminated a switch is turned on the control panel that causes the electronic device on the relevant rider's handlebars to flash.

9.4.4.3. Start Order

If the race is run as a stand-alone event, the riders are seeded randomly.

When the race is part of the Omnium event ([see chapter 9.5.1](#)) the riders are seeded according to their current Omnium ranking at that competition.

At the start, half the riders line up in single file holding the railing and half line up in single file being held by the coaches in the Sprinter's Lane. The riders are lined up based on their seeding, with the highest seeded riders at the front, alternating between the railing and Sprinter's Lane. The Start List must indicate the order of the riders and whether they start on the railing or in the Sprinter's Lane.

Even if the seeding is random, the riders must line up according to the order on the Start List.

9.4.4.4. Race Conduct

THE START



The start is managed in the same way as for the Points Race. The holders are allowed to push their riders, but they must remain in their position (they are not allowed to run down the track as they push their rider off).

NOTE

In the Elimination, the neutral lap tends to be ridden very fast. It is important for the Starter to make sure the riders are together before firing the pistol to start the race.



TIP

To start the neutral lap, the Starter stands behind all the riders when blowing the whistle. This prevents the riders anticipating the start.

BUNCH

The way in which the bunch is defined is the same as for the Points Race.

In the Elimination, there is no real concept of leader of the race and leader on the track.

LAPPING

The way in which riders gain laps is the same as in the Points Race. However, gaining a lap makes no difference, a rider can still be eliminated if he or she is the last rider across the line, even if a lap up. It is thus highly unlikely a rider will gain a lap as it is a disadvantage to do so.

Riders do not lose laps since they would be eliminated before they lost the lap.

RACE NEUTRALISATION



To neutralise the race the PCP holds up a yellow flag on the Finish Line. Until the race is restarted the riders are required to ride as one group.

The yellow flag must remain out as long as the race is neutralised.

To end the neutralisation the PCP withdraws the yellow flag as the group of riders exits turn 4. The Starter fires the pistol as the riders approach the Finish Line to restart the race.

ELIMINATIONS

The PCP is responsible for deciding which rider is eliminated.

The decision on which rider to eliminate must be clearly communicated by the PCP so that if it is the last rider across the line, the Finish Judge can identify the rider number and provide this to the Speaker and the Timing Company. A decision must not be announced until the PCP decides which rider to eliminate.



Once the decision is made, and the Finish Judge has identified the rider number, the Speaker announces the number and possibly the rider's name. The Technical Delegate switches on that rider's flashing elimination device and the Timing Company displays the rider's number on the Scoreboard and Pursuit Line lap boards.

If the PCP decides at any point to not eliminate a rider, no rider number must be communicated or announced.

NOTE

Once a rider number is communicated or announced, it is almost impossible to change this decision. If the decision is made to allow a rider to continue after his or her elimination has been announced, but before the next elimination, the race may need to be neutralised to allow the rider to return. In this case, unless there is a decision to eliminate a different rider due to bad conduct, no riders should be eliminated in the neutralisation period.

The rider to be eliminated must be identified and announced prior to the bunch reaching the Pursuit Line on the back straight after the elimination lap. If not done by that point, the PCP must clearly inform the Finish Judge that no rider is to be eliminated.

If there is no elimination, then the PCP must display a green flag on the finish line as the riders come past on that lap.

Once the eliminated rider's number is announced he or she must immediately leave the race and the track. If the rider fails to do so, he or she is disqualified. If the PCP considers that a rider who has been eliminated and has not yet left the track is affecting the race, the race can be neutralised until the rider leaves the track.

At the end of each elimination lap, riders can be eliminated for the following reasons:

- last rider across the line,
- abandoning the race,
- being lapped,
- unsporting conduct (this often concerns passing on the Blue Band).

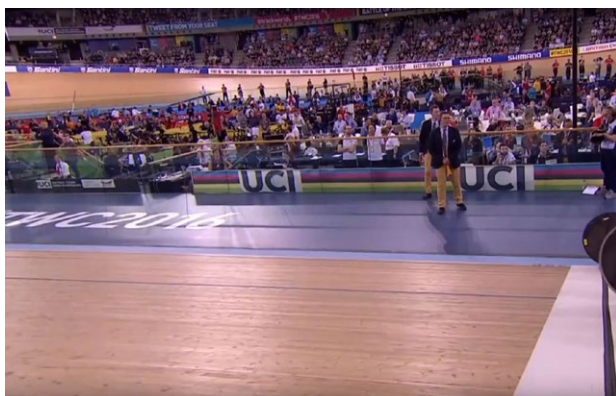

To determine the last rider across the line, the rear edge of the back wheel is used. The rider for whom the rear edge of the back wheel was adjudged to be last across the finish line is the rider eliminated.



TIP

If the PCP decides to eliminate the last rider, the Finish Judge should be informed just after the riders exit corner 4. The PCP does not need to identify the actual rider, just that the back rider should be eliminated.

Any riders who abandon or are lapped on an elimination lap are declared as the eliminated riders. In this case, more than one rider may be eliminated and no additional riders are eliminated from the back of the bunch.

A decision can also be made to eliminate a rider for unsporting conduct. Some examples would be passing on the Blue Band or head butting. In this case, these riders are eliminated on the next elimination lap. No other riders would then be eliminated from the bunch (other than any riders who may be lapped or abandon).

MISHAPS AND THE PITS

The team pit area, and its management, is the same as for the Points Race.

Up until there are four or fewer riders on the track, if one or more riders has a recognised mishap, they are allowed to rejoin the race. In this case the race is neutralised and the riders get a maximum of the number of laps closest to 1250 m to return to the track. Any riders who have not returned by this point are eliminated. They are placed according to the number of riders left on the track at this point.

If all the riders fall, irrespective of how many are left on the track, then the race is neutralised for a maximum of three minutes. Any riders who do not return after this time are eliminated.

Once there are four or fewer riders left in the race, there is no more neutralisation unless all the remaining riders crash. Any riders who have a mishap from this time are eliminated.

MANAGEMENT AND SCORING OF THE RACE



During the race all non-essential personnel should leave the Secretariat.

The TD, Finish Judge, Speaker and photo-finish operator, must all be located close to each other in line with the Finish Line.

The PCP must be on the Safety Zone, near the Finish Line.

This setup allows for clear communication between the necessary people.



TIP

This event should not be managed over radios. Communication is best done face to face.

RESULTS

Riders are placed in inverse order according to when they were eliminated in the race. If more than one rider was eliminated on the same lap, they are given a tied ranking. The winner is the first rider to cross the Finish Line at the end of the race.

9.4.4.5. Specific Commissaire Roles

Please see chapter 5 for the general duties of all Commissaire roles at track competitions as well as chapter 9.4.1.5 for the roles of the Commissaires at the Points Race. These same general roles apply. There is no Scoring Commissaire.

It is always the PCP's decision as to who will be eliminated. If the Judge-Referee sees an incident, the PCP can be informed of this. Due to the nature of the event, there is no opportunity for discussion. The Judge-Referee needs to clearly and concisely provide the rider's number and describe his or her conduct. The PCP must then decide whether that rider should be eliminated.

NOTE

It is not possible to display warnings to any riders during this race. Any warnings issued have to be communicated to the rider and team at the end of the race.

NOTE

It is not possible for the Judge-Referee to review any incidents on the video replay system during the race. Any information they provide to the PCP is based on what is seen live.

The PCP always informs the Finish Judge of the decision as to which rider to eliminate. The Finish Judge identifies the rider and communicates this information to the Speaker, TD and Timing Company.

If the decision is made to eliminate the last rider but his or her identity is not completely confirmed, the Finish Judge checks the photo-finish to identify the rider. The Finish Judge must never guess. If the last rider cannot be clearly identified, then no rider is eliminated.

The lap board is not used. The bell is only used if the elimination is every second lap.

9.4.5.

TEMPO RACE



The Tempo Race (**ARTICLES 3.2.259 to 3.2.264**) is simply a modified form of the Points Race. The primary difference concerns how many points are awarded and the way in which they are awarded.

The information provided in chapter 9.4.1 for the Points Race applies. Only the differences relevant to the Tempo Race are highlighted below.

9.4.5.1. Event Overview

The event is based on the Points Race and generally the same regulations and format apply. This includes for the distance. From the fifth lap onwards (including the fifth lap), the winner of every lap scores 1 point.

The lap board must display the total number of laps to be ridden and is used in the same way as in the Points Race.

At the end of the fourth lap, the bell is rung to indicate the start of the sprint laps. The bell is not rung again until the end of the penultimate lap when it is used to indicate the start of the final lap.

A rider gaining a lap scores 20 points.

A rider who is lapped by the bunch loses 20 points.

9.4.5.2. Track Setup

The track setup for the Tempo Race is the same as for the Points Race.

9.4.5.3. Start Order

If the race is run as a stand-alone event, the riders are seeded randomly.

When the race is part of the Omnium event (see chapter 9.5.1) the riders are seeded according to their current Omnium ranking at that competition.

At the start, half the riders line up in single file holding the railing and half line up in single file being held by the coaches in the Sprinter's Lane. The riders are lined up based on their seeding, with the highest seeded riders in the front, alternating between the railing and Sprinter's Lane. The Start List must indicate the order of the riders and whether they start on the railing or in the Sprinter's Lane.

Even if the seeding is random, the riders must line up according to the order on the Start List.

9.4.5.4. Race Conduct

THE START

The start is managed in the same way as for the Points Race.

LEADERS AND THE BUNCH

The leader and the bunch are defined and managed in the same way as the Points Race.

LAPPING

The way in which riders gain and lose laps is the same as in the Points Race.

MISHAPS AND THE PITS

The way in which the team pits and mishaps are managed is the same as in the Points Race.

MANAGEMENT AND SCORING OF THE RACE

The management and scoring of the race is done in the same way as for the Points Race.

RESULTS

The ranking for the race is prepared in the same way as for the Points Race. Any riders who were eliminated are ranked after the riders who finished, according to when they were eliminated. This means, for example, that the first rider to be eliminated is placed last. If two or more riders are eliminated on the same lap, they are ranked relative to each other according to the points they scored. If they are tied on points they share the same ranking.

NOTE

If this event is part of the Omnium, the points accumulated during the Tempo Race are not added to the points total that the rider starts with in the Points Race (see chapter 9.5.1). Only the points awarded due to the ranking are applied to the Points Race (see **ARTICLE 3.2.251**).

9.4.5.5. Specific Commissaire Roles

Please see chapter 5 for the general duties of all Commissaire roles at track competitions as well as chapter 9.4.1.5 for the roles of the Commissaires at the Points Race.

**REQUIRED KNOWLEDGE**

- Specific regulations for endurance events.
- Track set-up for each event.
- Specific functions of each Commissaire role in each event.
- Actions to be taken in the case of mishaps in the various events.
- How to identify the main bunch.
- How to identify the leaders.
- How laps are gained and lost.

**WHAT TO DO**

- Ensure all members of the Commissaires' Panel are appropriately positioned.
- Be discreet in response to incidents.
- Be consistent.
- Communicate clearly and concisely.
- Remain focused on your role.
- Score the races.

**WHAT NOT TO DO**

- Refuse to assist in another Commissaire role if required (for example, monitoring the return of riders).
- Focus on only one area of the track.
- Fail to be proactive when managing lapped riders.
- Leave the race management and decisions to the organiser or a member of the Commissaires' Panel even though you are the PCP and the decision is your responsibility.
- Apply decisions without considering their impact throughout the competition.

9.5. OTHER EVENTS

Track events can be divided into four broad categories, the fourth of which is known as Other Events. Other events are generally either modified versions or combinations of the other three categories of event. This means it is relatively simple to explain and manage these events.

All Commissaires must have a good knowledge of the general tasks and functions of the various Commissaire roles, as described in Chapter 5 of this guide. This section only describes Commissaire roles where they are different or unique compared to the information provided in Chapter 5.

If an event refers to one of the events explained in Chapter 9.4, a good knowledge of that event will be required.

The general requirements for the track set up are provided in Chapter 3 together with descriptions of the track equipment and installations.

Equipment requirements are explained in more detail in Chapter 11.

9.5.1. OMNIUM



The Omnium (**ARTICLES 3.2.247 to 3.2.252**) is considered an event for endurance track racers. All the events that make up the Omnium are endurance races.

9.5.1.1. Event Overview

The Omnium is an event made up of four separate endurance events. These events are run in a predefined order on one day. Riders score points based on their ranking in each of the first three events.

The final event is a Points Race. The points totals achieved by the riders in the first three events are carried over to give the riders an initial points score in the Points Race.

The winner of the Omnium is then the winner of the Points Race.

9.5.1.2. Competition Format

The Omnium is made up of the following events:

- Scratch Race (chapter 9.4.3),
- Tempo Race (chapter 9.4.5),
- Elimination (chapter 9.4.4),
- Points Race (chapter 9.4.1).

These events must be run in this order, all on the same day.

The distance of each of the events is described in the regulations and depends on the rider category.

Other than when described specifically in the Omnium regulations, each of the four events are run according to the UCI event regulations. The main difference is to take into account the ongoing nature of the Omnium over the four separate events.



TIP

The rider race numbers should be a consecutive series of numbers starting from 1. This makes managing the event much easier.

9.5.1.3. Race Conduct

QUALIFYING

The number of riders who participate in the Omnium is limited to the track maximum, although the organiser or the special regulations of the competition may set a lower limit.

If more riders are entered for the event than are permitted to start, then a qualification event is required, namely a Points Race (see also chapter 9.4.1).

The Points Race qualifying heats must meet the following requirements:

- They must be run according to the regulations for Points Race heats,
- The heats must be balanced in terms of the best riders,
- Each heat must have the same number of riders (one heat can have one more in the case of an odd number of riders),
- The same number of riders from each heat qualify for the Final,
- Riders who do not qualify are ranked last in the final Omnium classification,
- Riders who do not finish are not ranked in the Omnium classification.

The riders for the qualifying heats are seeded for the start by the Commissaires' Panel. Usually this is done by the Secretary, delegated by the PCP. Depending on the level of the competition (for example World Championships or World Cups), the riders may be seeded on different criteria, including:

- UCI Omnium Ranking,
- defending champions,
- series leaders.

NOTE

It is not a requirement to have the maximum possible number of riders in the Omnium event if qualifying heats are required. The heats should be competitive, and the Commissaires' Panel decides how many riders from each heat go through to the Omnium.

STARTING

Each of the separate races is started according to the specific race regulations.

If qualifying heats are not required, then the starting order for the first race, the Scratch Race, is determined in the same way as for the regular Scratch Race, except that the UCI Omnium Ranking is used.

If qualifying heats are required, then the starting order is based on the ranking from the heats, with the highest-ranked riders seeded first.



Example

Two qualifying Points Race heats are run to determine who will participate in the Omnium event. For the start order for the Scratch Race, the two winners from the heats start in the front row, on the railing and on the Blue Band. The two second-placed riders from the heats start next, on the railing and on the Blue Band, etc.

At the end of each race, the updated Omnium event ranking is prepared. This is used as the seeding to determine the starting order for the following event.

SCORING POINTS IN THE OMNIUM

NOTE

If qualifying heats are required, the results of these heats, as well as points won and lost, are not carried forward into the Omnium event other than to determine who qualifies and the order of the start.

For the Omnium event, there are two phases for the purposes of points scoring:

- Phase 1: After each of the first three events,
- Phase 2: The Points Race.

Phase 1 points are scored as follows:

- after each event a full ranking is drawn up,
- the winner of each event gets 40 points,
- second place gets 38 points,
- third place gets 36 points,
- etc.,
- 21st place and lower each get 1 point,
- after each race, the Omnium event ranking is updated with the points scored based on the rankings for that race.

Phase 2 points are scored as follows:

- The riders start the Points Race with the points they have accumulated through the rankings in Phase 1,
- Riders win and lose points in the Points Race according to Points Race regulations.

The final Omnium ranking is determined by the ranking of the Points Race.

The winner of the Points Race is the winner of the Omnium.



Example

Rider A wins the Scratch Race, comes second in the Tempo Race and fourth in the Elimination.

Rider A has scored:

Scratch Race = 40 points,

Tempo Race = 38 points,

Elimination = 34 points,

Rider A will start the Points Race with $40 + 38 + 34 = 112$ points.

During the Points Race, rider A wins two intermediate sprints, gains one lap, and finishes third in the final sprint. At the end of the Points Race, rider A will have scored:

intermediate sprint = 5 points,

intermediate sprint = 5 points,

gaining lap = 20 points,

third in final sprint = 4 points,

points from Phase 1 = 112 points,

Rider A points total = $5 + 5 + 20 + 4 + 112 = 146$ points.

Rider A's position in the final Omnium ranking is based on the points scored, i.e. 146 points. The rider with the most points wins.

RANKINGS FOR RIDERS NOT FINISHING

Scratch Race

- Rider falls and cannot return:
 - rider ranking is based on the number of riders on the track at that moment.
- Rider cannot return in the final kilometre:
 - rider ranking is based on the number of riders on the track at that moment.
- Rider lapped twice by the bunch:
 - rider ranking is based on the number of riders on the track at that moment.

NOTE

In the Omnium event riders must be lapped twice in the Scratch Race before being withdrawn.

NOTE

Unless practicably not possible, riders who have been lapped twice should be withdrawn as leaving them in will potentially impact ranking points scored.

Tempo Race

- Rider falls and cannot return:
 - rider ranking is based on the number of riders on the track at that moment.
- Rider cannot return in the final kilometre:
 - rider ranking is based on the number of riders on the track at that moment.

Points Race

- Rider cannot return in the final kilometre:
 - place in the final sprint is based on the number of riders on the track at that moment.

NOTE

If a rider is withdrawn from the Scratch or Tempo Race, in addition to any ranking points earned, the rider is also penalised with -40 ranking points.

NOTE

Any rider who abandons any of the events by their own decision is eliminated from the Omnium event and marked as DNF.



Example

18 Riders start the Scratch Race. During the first half of the race, two riders abandon the race. With 15 laps to go riders A, B and C are lapped by the field. With 9 laps to go rider A is again lapped by the field. With 6 laps to go, riders C, D and E crash and cannot return. With 1 lap to go rider F crashes.

The 2 riders who abandon the race are marked as DNF (did not finish) and are not permitted to continue in the Omnium.

When rider A is lapped for the second time there are 16 riders on the track. Rider A is ranked 16th in the Scratch Race and scores the points for 16th place (10 points) and a deduction of -40 points for a total of -30 points in the ranking.

When riders C, D and E crash there are 15 riders on the track. In relation to D and E, rider C has lost 1 lap, and so rider C is ranked 15th and scores the points for 15th place (12 points). Riders D and E are ranked in tied 13th position (since with their removal there will only be 12 riders left on the track). They both score points for 13th place (16 points each).

When rider F crashes there are 12 riders on the track. He is ranked 12th in the Scratch Race and scores the points for 12th place (18 points).

At the end of the race, rider B will be ranked in 11th place as he is down one lap on the bunch, and scores the points for 11th place (20 points).

The remaining riders score ranking points based on their relative positions in the final sprint.

9.5.1.4. Specific Commissaire Roles

Please see chapter 5 for the general duties of all Commissaire roles at track competitions as well as:

- Chapter 9.4.1.5 (Points Race),
- Chapter 9.4.3.5 (Scratch Race),
- Chapter 9.4.4.5 (Elimination),
- Chapter 9.4.5.5 (Tempo Race).

The Commissaire duties are the same as for each of the events.

9.5.2.

SHOW EVENTS

The number of events that can be held on a track is essentially limitless. The key is that they should always be governed by sporting criteria and riders should not be put into an unsafe situation.

9.5.2.1. General Principles

Show events can be created by organisers to meet specific needs. They must comply with the following requirements:

- based on sporting criteria,
- riders are not placed in unsafe conditions,
- event regulations are published in the competition special regulations.



These events may be races that were part of the competition calendar in the past. Sometimes they are races specific to a region or they may be specially created events.

Whatever the event, they should follow the general principles of the UCI Regulations:

- sprinting events follow the sprint regulation requirements,
- time trial or pursuit events follow the Time Trial or Pursuit regulation requirements,
- bunch races observe the endurance event regulation requirements.

Some events may even be combinations of the various event types; the regulations that would apply depend on the phase of the race at the specific moment.



Example

A race requires the riders to race 40 laps and score points every 10 laps, after which the event becomes an elimination race. The first phase in which points are scored follows the principles of the Points Race regulations. The second phase in which the riders are eliminated follows the Elimination Race regulations.

9.5.2.2. Specific Commissaire Roles

The Commissaire roles in these races depend on the event type.

The PCP must ensure that the event special regulations are published and that the event is:

- safe,
- fair,
- still a competition.

9.5.3.

SIX-DAY RACES



Six-Day Races (**ARTICLES 3.2.227 to 3.2.246**) are track races run for teams of two or three riders, over the course of six consecutive days.

The organiser is free to create whatever programme is desired but must publish a technical guide listing all the relevant races and describing the overall scoring process.

A major component of Six-Day Races is Madisons.

All the events that make up a Six-Day Race are governed by their specific event regulations, with only some minor differences as described in the Six-Day Race regulations. These differences account for:

- the team nature of the event,
- the fact the event takes place over several consecutive days,
- the overall race scoring, based on laps gained and lost and points scored.

9.5.3.1. Event Overview



Six-Day Races are held primarily in Europe.

Within the Six-Day Race there may also be other events for other rider categories. Separate events may even be held for the riders participating in the Six-Day Race, the results of which may or may not count towards the Six-Day Race classification. If these races are on the international calendar, they must be run according to UCI Regulations. They are included in the Six-Day Result according to the specific race regulations.

The events of a Six-Day Race are decided by the organiser. These include:

- individual events – where individual team members race,
- Madisons – where the team races.

NOTE

The Madison is sometimes also known as the Chase.

The organisation must provide cabins on the infield for the riders to rest in when they are not racing.

For the Six-Day Race, the overall winner is the team that completes the most laps. For teams tied on the same number of laps, the points scored in intermediate sprints are used to break the ties.

All the events that are part of the Six-Day Race are governed by the Six-Day Event regulations. The differences in the regulations address how to manage:

- accidents,
- riders abandoning,
- teams being reformed.

9.5.3.2. Specific Commissaire Roles

Please see chapter 5 for the general duties of all Commissaire roles at track competitions. See also the relevant chapters related to the events that make up the Six-Day Race programme.

9.5.4. WORLD CHAMPIONSHIPS



The UCI Track Cycling World Championships showcase cycling to the whole world. The UCI is the sole owner of the World Championships and acts as the organiser. The World Championships are held once a year for each discipline.

In addition to taking into consideration the very special level of the competition, Commissaires called upon to officiate at the UCI Track Cycling World Championships should take note of certain special requirements. These are listed mainly in Parts 3 and 9 of the UCI Regulations. Pay special attention to the fact that sometimes the event format changes at the World Championships.

Here are some examples of regulations specific to the World Championships:



UCI REGULATIONS

| SUBJECT | ARTICLE | INFORMATION |
|----------------------------|----------------|--|
| Rider attire at ceremonies | 9.1.046 | <ul style="list-style-type: none"> • Wearing racing attire • Bareheaded |
| Participation | 9.2.001 | <ul style="list-style-type: none"> • National Federation team selection |
| Confirmation | 9.2.007 | <ul style="list-style-type: none"> • Rider confirmation by noon on the eve of the first race of the competition |
| Participation | 9.2.022 | <ul style="list-style-type: none"> • World Championship events • Maximum participation by nation |
| Age | 9.2.024 | <ul style="list-style-type: none"> • For elite Championships rider must be at least 18 |

In addition, chapter 9 also covers the following:

- the award of the World Championships to candidate municipalities,
- the sharing of responsibilities between the local organiser and the UCI (the official organiser),
- the procedures for entries by nations, quotas per nation, participants,
- organisation of competition headquarters and pre-race meetings.

9.5.5.
OLYMPIC GAMES

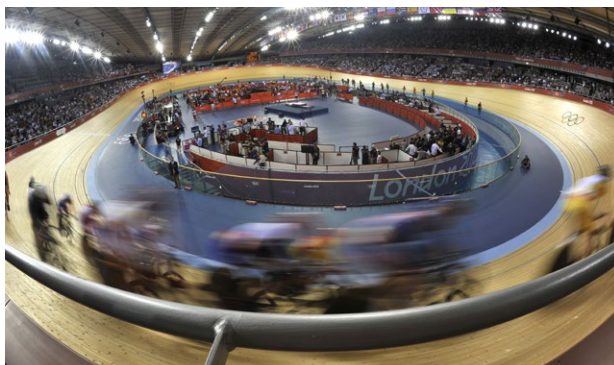

The Olympic Games are organised every four years by the International Olympic Committee. The Olympic track cycling events are held under UCI Regulations for technical matters while IOC rules apply with regards to certain administrative provisions and the image of the Olympic Games.

In addition to taking into consideration the very special level of the competition, Commissaires called upon to officiate at the Olympic Games should take note of certain special requirements. These are listed mainly in Parts 3 and 11 of the UCI Regulations. Pay special attention to the fact that sometimes the event format changes at the Olympic Games. There is also a very restricted participation per nation.



UCI REGULATIONS

| SUBJECT | ARTICLE | INFORMATION |
|---------------|-----------------|---|
| Confirmation | 11.1.002 | <ul style="list-style-type: none"> Rider confirmation by noon on the eve of the first race of the competition |
| Participation | 11.1.003 | <ul style="list-style-type: none"> Riders must be at least 18 Must be licensed by National Federation |
| Programme | 11.1.004 | <ul style="list-style-type: none"> Events on the programme |

Part 11 of the UCI Regulations concerns administrative arrangements for the Olympic Games for all disciplines.

For track events, the regulations cover the following topics:

- the procedures for entries by nations, quotas per nation, participants,
- organisation of competition headquarters and pre-race meetings,
- podium ceremonies.



REQUIRED KNOWLEDGE

- Omnium format.
- Regulations for each of the Omnium events.
- Commissaire roles for each of the Omnium events.
- Omnium rankings.
- Six-Day Race requirements.
- Principles for show events.
- World Championships programme.
- Olympic Games programme.



WHAT TO DO

- Review the specific regulations of each race.
- Score the races as required.
- Respond to incidents as required by the event regulations.



WHAT NOT TO DO

- Officiate in a race with unsporting requirements.
- Allow racing in unsafe conditions.
- Leave the race management and decisions to the organiser or a member of the Commissaires' Panel even though you are the PCP and the decision is your responsibility.
- Apply decisions without considering their impact throughout the competition.



CHAPTER 10
AFTER THE EVENTS
AND COMPETITION

Once the competition is over, the PCP is still required to complete some important tasks. The objective of these activities is to ensure:

- the continuing improvement of the sport,
- cataloguing and archiving results.

10.1. DEBRIEFING OF THE COMMISSAIRES' PANEL

The Commissaires' debriefing is carried out in two stages:

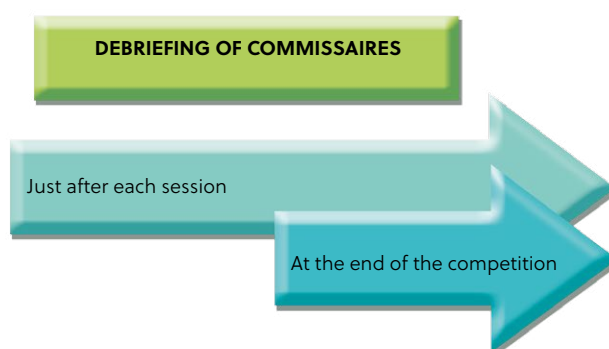

Diagram. Two-stage debriefing of Commissaires

1 - Immediately after each session, in the vicinity of the Secretariat:

- to review any incidents from that session,
- to answer any questions raised by members of the Commissaires' Panel,
- to confirm the programme of the next session and the time at which Commissaires should attend.
- to review any important regulations for the events in the next session.

NOTE

Sometimes this meeting may be held prior to the start of the next session.

2 - At the end of the competition, normally in the Commissaires' Meeting Room, in particular to:

- gather opinions on the organisation of the competition,
- prepare the debriefing with the organiser,
- offer feedback on the Commissaires' work.

The PCP conducts an informal evaluation of the operation of the Commissaires' Panel as a whole with regards to officiating at the competition, in particular to:

- congratulate and motivate Commissaires with regards to positive points,
- implement corrective action for negative points.

The PCP asks the Commissaires for their views on the general organisation of the competition and their comments and suggestions for improvements. The PCP should also share his or her assessment of the competition in order to compare his or her views and expectations with the Commissaires' opinions and possibly with local practice.

There should also be a review of any incidents where the regulations potentially had a role in negatively affecting the outcome, or where they did not address the incident and caused a problem. Potential regulation improvements should be identified.

10.2. DEBRIEFING WITH THE ORGANISER

For all competitions, the PCP has a meeting with the organiser before leaving the venue, to discuss the positive and negative points of the competition.

The following diagram offers guidelines for this debriefing:

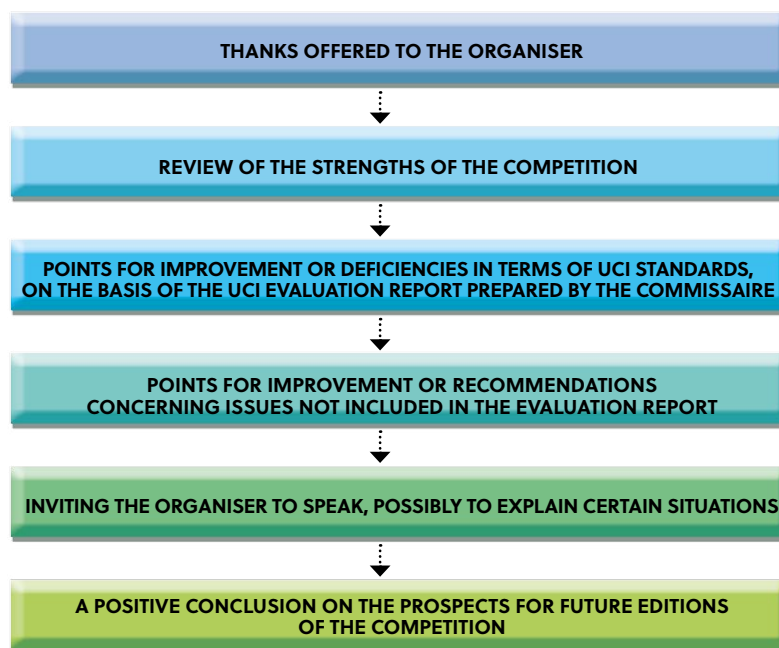

Diagram. Debriefing with the organiser

It is important to be comprehensive when referring to the standards described in the UCI report. The organisation will receive a summary of significant points (positive and negative) from the UCI which may come from various sources (teams, riders, officials, media, etc.). If points appear in this summary without having been mentioned during the debriefing, this may affect the credibility of the PCP and Commissaires appointed to future competitions.

During a competition that stretches over multiple sessions there may be a number of these meetings with the organiser as issues arise, allowing the organiser to be informed of points that can be improved without delay. Any criticism by Commissaires should be constructive in order to encourage the organiser to develop the competition. It is essential to give the organiser the opportunity to address any problems encountered during a session.

It is not acceptable to leave a competition without conducting this debriefing. If it is genuinely impossible to hold the debriefing (logistical reasons, organiser detained due to podium ceremony obligations, etc.), then a telephone conference should be held as soon as possible.

Presenting criticism can be a delicate matter. The Commissaire should proceed diplomatically otherwise an organiser may feel hurt or become stubborn; this is not conducive to correcting behaviour.

EXPRESSING CRITICISM

Expressing criticism requires a great deal of diplomacy from the Commissaire to avoid the organiser feeling hurt or balking at suggestions. An organiser who is not in a positive frame of mind or who feels targeted, will be less willing to follow advice and implement suggested improvements or corrections.

The Commissaire should adapt his or her tone and the wording of the criticism to the circumstances and the organiser's situation:

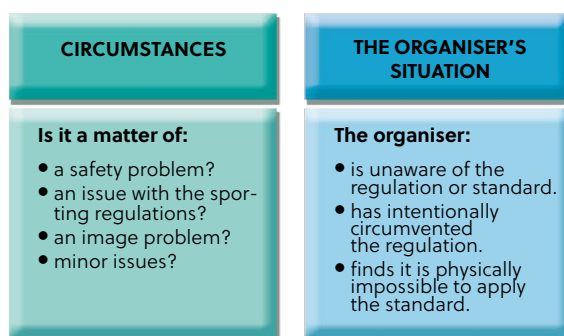

Diagram. Adapting the Commissaire's tone and wording of criticisms to the situation

After emphasising a point that requires improvement, the PCP should suggest a solution on the basis of his or her experience. Organisers often feel that there is an element of competitiveness between them, so it is not recommended to cite another competition as an example, especially if this competition is of an equal or lower standard.

The PCP must bear in mind the Commissaires' scope of action. Positive points may be made about issues that do not fall within the remit of Commissaires, but the PCP should not criticise such matters (e.g. communication, marketing, image, podium ceremonies, environment, atmosphere, etc.).

The evaluation of negative points should also take into account the preceding PCP's report on the previous edition of the competition (a copy of the evaluation is sent to the subsequent PCP). Any correction or progress made should be emphasised. However, if an undesirable situation remains unresolved, this must be highlighted.

10.3. UCI EVALUATION REPORT

The form for the UCI evaluation report is available on the Commissaires extranet. This form is updated every year. Only the PCP completes the form.

The evaluation form comprises questions on:

- detailed competition information,
- official documents (technical guide and special regulations),
- participation,
- general organisation (reception, venues, meetings),
- safety,
- the track,
- the facilities,
- specific technical equipment for the sporting aspect,
- competition format,
- results and podium ceremony,
- the media and media coverage,
- any incidents.

NOTE

A complementary report may be attached to the evaluation report by the PCP if necessary. This may offer justification of a particularly negative point or an issue that gave rise to exceptional decisions. It is also the occasion for the PCP to report any positive developments to the UCI (e.g. innovation by the organiser). It can also be used to suggest any potential regulatory changes.

The race report is a very important document for UCI sports coordinators as it is the only reference material that allows an objective opinion to be formed on both the quality of the competition organisation and the application of the regulations.

10.4. SENDING THE RACE DOSSIER TO THE UCI

The race dossier must be sent to the UCI within two weeks of the competition. If there are circumstances that delay the dispatch of the dossier to the UCI, the PCP must inform the coordinator.

The following documents must be included:

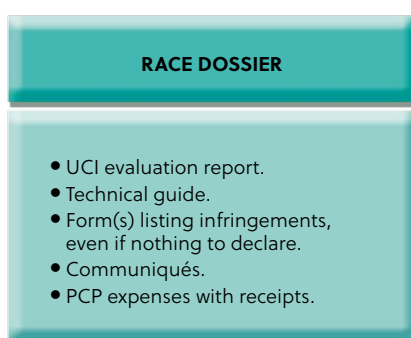

Diagram. Contents of the race dossier sent to the UCI

The documents must be sent to the UCI electronically. In some cases it may be necessary to scan some of the documents in order to send them. These documents should all be sent to: track@uci.ch

The results should already have been uploaded to UCI DataRide.

It is recommended that a paper copy of the dossier should be retained for a year.



TIP

If the files are too big to send to the UCI by email, a free file transfer service such as WeTransfer (<https://wetransfer.com>) can be used.



REQUIRED KNOWLEDGE

- Organising the Commissaires' debriefing.
- Preparing and conducting the debriefing with the organiser.
- Where to find the UCI Evaluation Report



WHAT TO DO

- In debriefings, firstly refer to positive points and improvements.
- Guide the debriefings towards obtaining corrections without offering offence to any individuals taking part.
- Draw up a complementary report of positive or negative points not covered by the standard questions of the UCI report.



WHAT NOT TO DO

- Use an obsolete version of the UCI evaluation report form.
- Fail to raise a point described in the UCI report with the organiser.
- Change the headings of the evaluation report.

A man in a blue polo shirt is focused on adjusting a bicycle wheel mounted on a complex, silver-colored metal frame. The frame has various adjustment points and a yellow label with the number '33'. The wheel is black with a white and red design and the text 'FAST FORWARD' on the rim. In the background, another man in a dark blue polo shirt is looking at a device. The setting appears to be a trade show or exhibition hall with a high ceiling and other people visible in the distance. A blue semi-transparent box with white text is overlaid on the right side of the image.

CHAPTER 11 EQUIPMENT AND CLOTHING

11.1. EQUIPMENT

The equipment regulations are of primary importance in the sport of cycling. The development of equipment has required rules that assert the primacy of humans over machines. Observance of the UCI regulations by all parties facilitates sporting fairness and safety during competition.

The Lugano Charter, which came into effect in 1996, illustrates the UCI's determination to counter any loss of control over technical issues and reasserts that the purpose of cycle sport is to allow riders to compete on an equal basis in order to determine which athlete is the best in physical terms.

The practical guide entitled [Clarification Guide of the UCI Technical Regulation](#) is available on the UCI website. It is important that all Commissaires are conversant in the use of this publication.

All the articles relating to the equipment regulations for riders are published in Part I, Chapter III, §1 and §2 of the UCI Regulations.

11.1.1.

PRINCIPLES

- It is important to emphasise the “**primacy of humans over machines**”.
- Licence holders are responsible for the equipment they use in competition. The equipment must comply with the prevailing safety standards (**ARTICLE 1.3.001**).
- Equipment must not constitute a danger to the rider or other competitors (**ARTICLE 1.3.001**).
- Competitors and/or team helpers are not authorised to modify equipment from the condition in which it was supplied by the manufacturer (**ARTICLE 1.3.002**) for obvious safety reasons. The act of modifying equipment is also prohibited as it annuls the guarantee in most cases.
- The addition of handlebar tape to improve the rider's grip is authorised, but tape must be identifiable and only used where the rider's hands grip the handlebars.
- Commissaires are authorised to carry out checks at any time, as considered appropriate, on equipment used in competition, whether during or after an event (**ARTICLE 1.3.003**).

11.1.2.

TECHNICAL INNOVATION

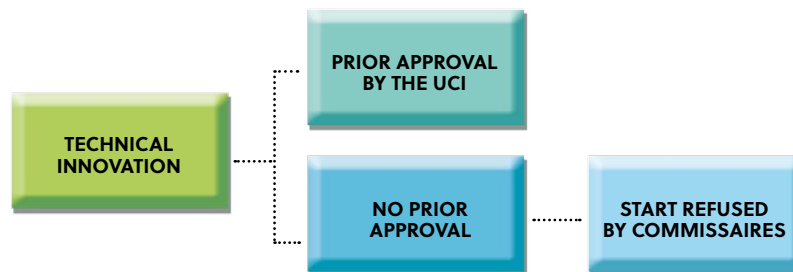

Diagram. Technical innovation and approval by the UCI

- No technical innovation may be used in competition until approved by the UCI (**ARTICLE 1.3.004**).
- If a competitor attempts to use a technical innovation that has not received the prior approval of the UCI, the Commissaires must prohibit the rider from starting (**ARTICLE 1.3.005**).
- Equipment that is used must be generally available for sale to the public. Under certain conditions the UCI can issue an exception to this requirement under strict conditions, but it is still necessary for this equipment to be made available for sale to the public within a set timeframe (**ARTICLE 1.3.006**).

11.1.3. THE BICYCLE

- The wheels shall be of equal diameter. The front wheel shall be steerable and the rear wheel driven.
- The bicycle is propelled only by the rider's legs.
- The steering system must be reliable and allow manoeuvres to be conducted in complete safety.
- The rider normally assumes a sitting position on the bicycle. The only points of support authorised are the following: the feet on the pedals, the hands on the handlebars and the seat on the saddle. For certain events elbow supports are also permitted.

11.1.4. MEASUREMENTS AND DIMENSIONS

Commissaires must be aware of the approved dimensions for bicycles. These dimensions concern the following issues:

- overall size: the total length, width and height of the complete bike,
- the position of the saddle in relation to the bottom bracket and handlebars; the saddle's horizontality,
- the position of the handlebars in relation to the bottom bracket and front wheel; the angle of the handlebar extensions,
- technical safety specifications relating to manoeuvrability and any impairment of manoeuvrability,
- the required minimum weight,
- configuration and structure.



Commissaires are authorised to check that the equipment used by riders fulfils the regulatory criteria defined in **ARTICLES 1.3.011 to 1.3.025**.

11.1.5. THE RULES ON POSITION

THE POSITION OF HANDLEBARS – BUNCH EVENTS

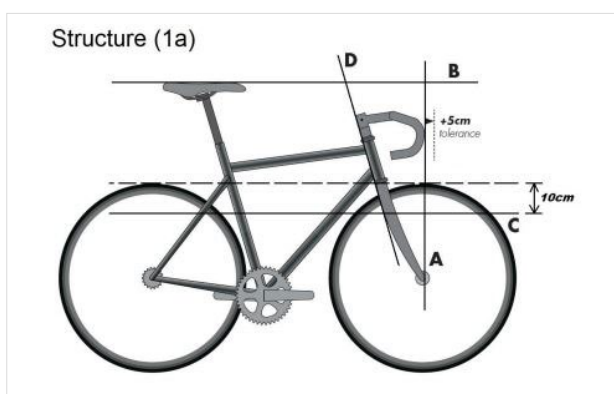

These events include Points Race, Scratch Race, Tempo Race, Madison, Elimination, etc.

In bunch races, handlebars must be of a traditional type and positioned within a specific zone:

- above, by the horizontal plane passing through the top of the saddle (B),
- below, by the horizontal line passing 10 cm below the highest point of the wheels (C),
- at the rear, by the axis of the head tube (D),
- at the front, by the vertical line passing through the front wheel axle, with a tolerance of 5 cm (A).

THE POSITION OF HANDLEBARS – SPRINT EVENTS

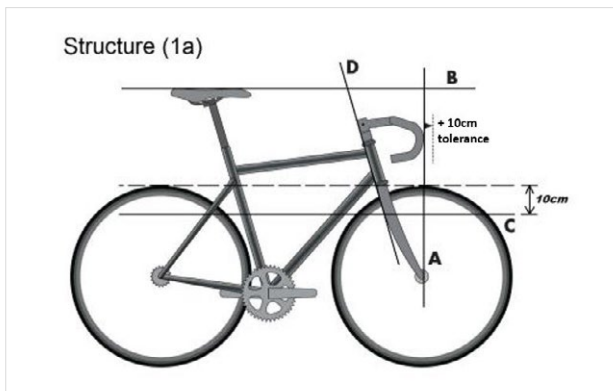

These events include Sprint, Keirin, Team Sprint, flying starts, etc.

In sprint events, handlebars must be of a traditional type and positioned within a specific zone:

- above, by the horizontal plane passing through the top of the saddle (B),
- below, by the horizontal line passing 10 cm below the highest point of the wheels (C),
- at the rear, by the axis of the head tube (D),
- at the front, by the vertical line passing through the front wheel axle, with a tolerance of 10 cm (A).

THE POSITION OF HANDLEBARS – PURSUIT EVENTS AND TIME TRIAL EVENTS

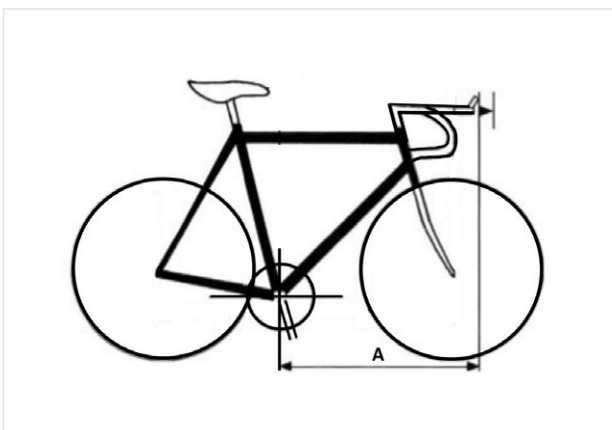

These events include Individual Pursuit, Team Pursuit, Kilo-metre Time Trial, 500 m Time Trial, etc.

In pursuit and time trial events, handlebar extensions may be added to the handlebars. These must meet the following requirements:

- the added handlebars must consist of two extensions with a maximum cross section of 4cm each.
- the distance between the end of the handlebar extensions and a vertical line passing through the bottom bracket axle must not exceed 75 cm,
- this limit of 75 cm may be increased to 80 cm for morphological reasons (see later in this section for further explanation),
- this limit of 80 cm may be further increased to 85 cm for morphological reasons in the case of tall riders (rider is 1.90 m or taller - see later in this section for further explanation),
- the elbow rests must be made up of two parts with maximum dimensions of 12.5cm by 12.5cm and the maximum inclination, measured on the support surface, being 15 degrees,
- in no circumstances may the end of the handlebar extensions exceed the maximum limit of 85 cm,
- the height difference between the midpoint of the elbow support points and the highest and lowest points of the handlebar extension must be less than 10 cm.

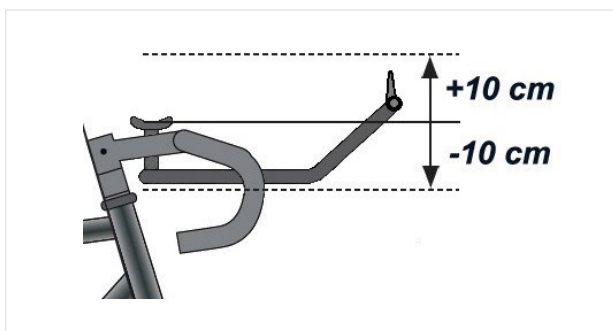

NOTE

If a traditional handlebar is used in a Time Trial event, the same rules as for Sprint events apply.

SADDLE POSITION

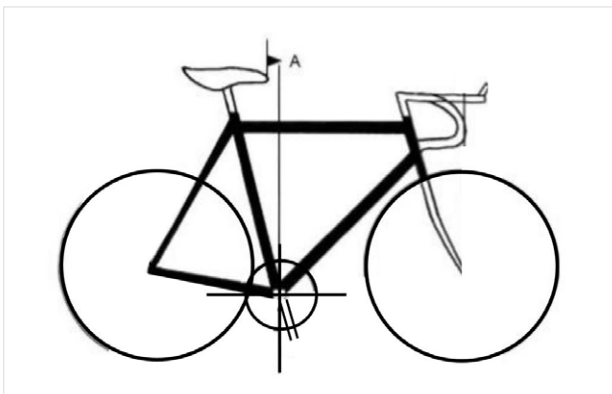

- The tip of the saddle must be positioned at least 5 cm behind the vertical line passing through the bottom bracket axle.
- For morphological reasons (see later in this section for further explanation), the tip of the saddle may be moved forward to less than 5 cm behind the vertical line passing through the bottom bracket axle.
- In no case may the tip of the saddle pass beyond the vertical line passing through the bottom bracket axle.
- The saddle may be tilted no more than plus or minus 9 degrees, measured through its highest points at the front and back.



MORPHOLOGICAL EXEMPTIONS

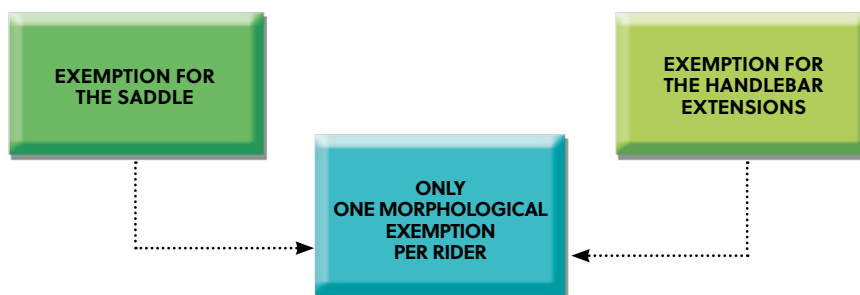

Diagram. Number of morphological exemptions allowed per rider

Every rider is entitled to one of the morphological exemptions. There is no need to measure the rider. Each rider can either:

- move the saddle from the 5 cm to 0 cm position behind the bottom bracket; OR
- move the handlebar extension (where permitted) forward from 75 cm to 80 cm in front of the bottom bracket position. In the case of a rider 1.90 m or taller, this distance can be extended to 85cm.

NOTE

Each rider may only have one of the exemptions, never both.

NOTE

In the case of a rider claiming to be 1.90 m or taller, this height must be verified. The rider's height without shoes and helmet must be measured.

In the case of non-compliance, adjustments must be made and the bicycle rechecked before a start can be authorised.

NOTE

If the Commissaires notice that the rider has adjusted his or her equipment, they can recheck the equipment immediately after the race. If the equipment is found to be non-compliant the rider should be disqualified. Other penalties may also potentially apply. Commissaires always have the right to check equipment at any time.

11.1.6.**SPECIFIC COMMENTS****PROTECTIVE SCREENS**

Photo. Example of a protective screen

- A protective screen is defined as a fixed element that protects or covers another component of the bicycle in order to reduce its wind resistance.
- Protective screens are prohibited in competition.

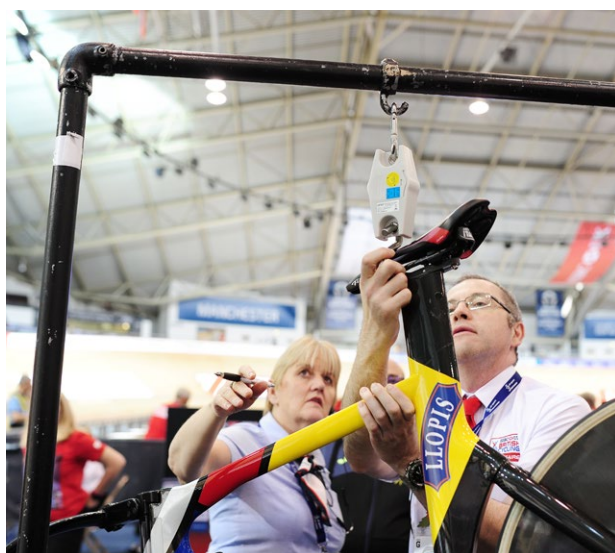
BICYCLE WEIGHT

- The weight of a bicycle must not be less than 6.8 kg. This is the UCI's main safety rule for bikes. It is imposed to prevent bicycles becoming unstable. Furthermore, below this weight limit manufacturers would be tempted to reduce the thickness of frame tubes, thus making structures more fragile.
- Checks of bike weights may be conducted by Commissaires before all events. This can also include any spare bikes to be used in bunch races. The whole bike is weighed, as shown by the photo.
- The scales used must be certified as compliant and regularly checked by an approved body.
- All removable equipment must be taken off before weighing the bicycle (computers, etc.).
- Nothing can be attached to the bicycle or inserted into the frame for the sole purpose of making the bicycle heavier (weights attached under the saddle or inserted into frame tubes, etc.).

STREAMLINING

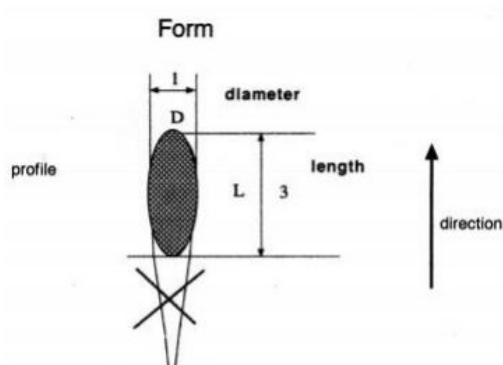

None of the equipment used on the bicycle may be streamlined beyond a 3:1 ratio. This means the ratio between the length and diameter, measured at the same point, must not exceed 3.

NOTE

If the bike has a UCI approval sticker it there is no need to measure the frame. However, any attachments such as seat posts, handlebars, etc must still be checked.

ELECTRONIC EQUIPMENT

- Any electronic equipment attached to the bicycle that is used to measure performance in any way must not have a display visible to the rider nor may it provide the rider with data by any other method during the competition.
- Any equipment used on the bike must be firmly attached so that it cannot drop onto the track.

PROPULSION ASSISTANCE: ON-BOARD MOTORS

- Checks can be conducted using a variety of tools.
- These checks are usually carried out by an appointed Technical Commissaire together with the UCI Equipment Unit.
- If the potential presence of a motor is detected, access must be afforded to the relevant part of the frame to verify the situation.

11.1.7.

APPROVAL PROCEDURES



Photo. Three-dimensional scanner

- All new models of frame and forks produced after 1 January 2011 must be approved for use in competition (road, track and cyclo-cross).
- The approval procedure is not obligatory for older models.
- The [list of approved models](#) is available on the UCI website.
- The first UCI check of approved frames and forks conducted in the field took place at the 2012 Tour de France using a three-dimensional scanner.

PROCEDURES FOR CHECKS IN THE FIELD

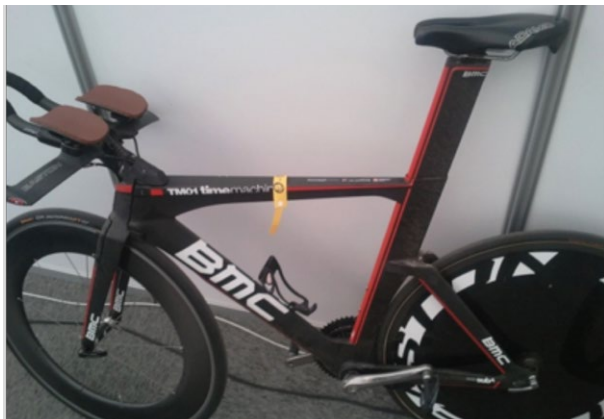

Photo. Bike to be checked identified by a security band

- At the end of an event, the bikes selected for checks are identified by a security band.
- The bikes are then checked at a pre-determined location using three-dimensional measurement apparatus which scans the bikes' geometry.
- The results of the scan are compared to the approved 3-D designs (submitted to the UCI by the manufacturers during the approval procedure) in order to check that they are identical.
- The procedure lasts approximately 15 minutes for each model.

CHECKING "UCI FRAME" AND "UCI FORK" LABELS

Commissaires should make sure that the labels affixed to the frame and fork of a bike being checked correspond to the manufacturer and model.

NOTE

The frame and fork are labelled separately. It must not be assumed that because the frame has a label, the fork also has a label.

Table. Examples of labels showing the bike manufacturer and model

| BIKE MANUFACTURER AND MODEL | LABELS |
|------------------------------|--------------|
| Pinarello, FPDUE, Road | PINA-F737-RD |
| Scott, Plasma 3, TT | SCOT-PLA3-TT |
| Corima, VIF, Track | CORI-VIF-TR |
| Richard Sachs, Signature, CX | SACH-RSS-CX |

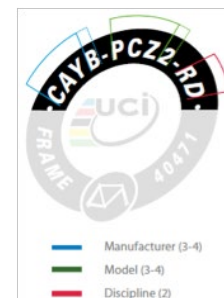
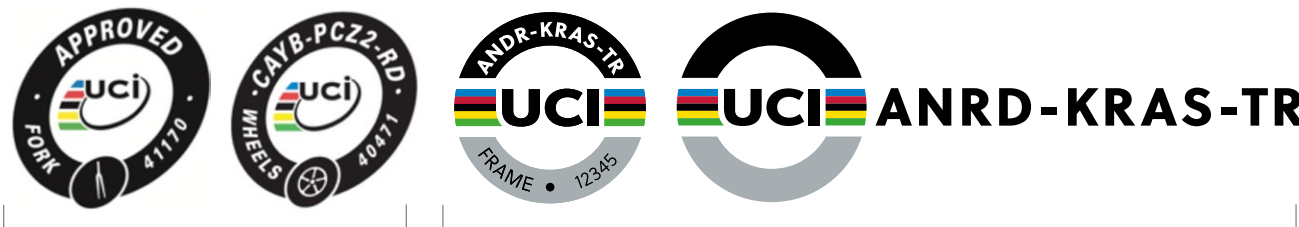

Diagram. Contents of a compliance label



Old labels

New labels

Diagram. Frame and fork label

- In the event of any doubt or problem with compliance, the frame/fork identification codes should be noted.
- It is also necessary to check that the label is the correct size and shape, visible, indelible and cannot be removed from the frame and/or fork. If this is not the case, this must be mentioned in the report.
- The Commissaire must inform the UCI of any suspicion of a frame or fork model manufactured after 2011 that does not have an approval label.



Diagram. Examples of non-compliant labels – prohibited

NOTE

No other equipment is currently labelled by the UCI. Any UCI approval labels attached to any other equipment (for example, wheels, handlebars, etc.) are fraudulent.

CHECKS TO BE CONDUCTED

Only the manufacturer is authorised to apply these labels and repaint frames and forks.

Extensive checks will be conducted at major road, track and cyclo-cross events.

In the event of non-compliance of approved models during checks:

- The manufacturer’s approval will be withdrawn.
- The manufacturer will be fined CHF 10,000-100,000.

→ **The manufacturer is responsible for the equipment it produces.**

- Disqualification of rider.
- Investigation of the team concerned.
- Performances not recognised.

→ **The licence holder is responsible for the equipment he or she rides.**

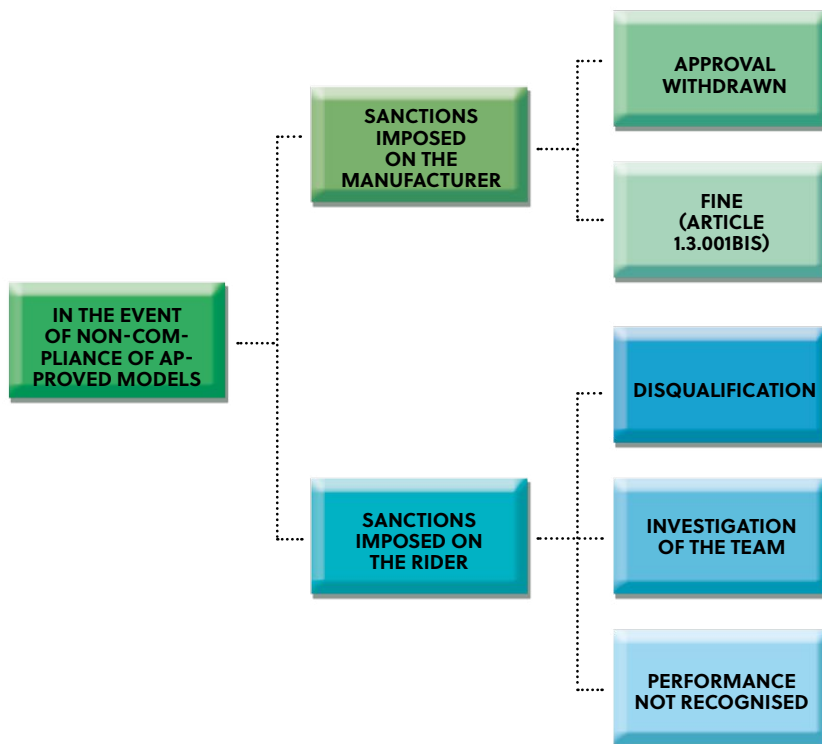

Diagram. Sanctions in the event of non-compliance during checks of approved models



WHEELS

For track cycling events, any wheels are permitted provided they conform to **ARTICLES 1.3.001 to 1.3.003**, and that they are the same size, with diameter between 55 cm and 70 cm, including the tyre.

The only restriction is that a front disk wheel is only permitted in timed events (flying 200 m, 1 km Time Trial, Individual Pursuit, Team Sprint, etc.).



REQUIRED KNOWLEDGE

- The spirit and principles of the Lugano Charter.
- The basic principles of the regulatory position of the rider on the bike.
- Recognition of technical innovations.
- Recognition and identification of a change of usage.
- Regulatory checks of bicycles.
- Where to find lists of approved frames and forks.
- The management of morphological exemptions.
- The restrictions on on-board electronic equipment.
- Recognition of valid UCI labels.



WHAT TO DO

- Keep up to date on technical developments.



WHAT NOT TO DO

- Fail to check the list of approved frames and forks.
- Accept UCI approval labels for equipment other than frames and forks.

11.2. RACE NUMBERS

Body numbers are used to identify the competitors in track cycling competitions. These are affixed to the rider's jersey. The organiser is required to provide the body numbers, which must be compliant with the UCI Regulations.



For track events, the riders are identified in the following manner (**ARTICLE 1.3.073**):

- Sprint – 2 numbers,
- Keirin – 2 numbers,
- Team Sprint – 1 number,
- Individual Pursuit – 1 number,
- Team Pursuit – 1 number,
- 1 km TT – 1 number,
- 500 m TT – 1 number,
- Points Race – 2 numbers,
- Scratch Race – 2 numbers,
- Tempo Race – 2 numbers,
- Elimination – 2 numbers,
- Madison – 2 numbers,
- Omnium (all events) – 2 numbers.

NOTE

The general principle is:

- Bunch races – 2 numbers,
- Individual and timed events – 1 number.

NOTE

The Flying 200 m is part of the Sprint event and so 2 numbers must be worn.



Unless otherwise stipulated, body numbers shall bear black characters on a white background (**ARTICLE 1.3.074**).



Riders shall ensure that their identification number is visible and legible at all times. The identification number shall be well fixed and may not be folded or altered (**ARTICLE 1.3.076**).

Teams/riders are provided with body numbers free of charge. Furthermore, the organiser should have sufficient spare numbers available, especially if the competition lasts a number of days.

The figures that appear on the body numbers should be printed in such a manner that they are clearly visible. The font selection is very important. The number 7 should have a horizontal bar across it to assist in identification.



| | |
|-------------------|--|
| Dimensions | <ul style="list-style-type: none"> • 16 cm wide x 18 cm high, • numbers 10 cm high, • thickness of lines comprising the number, 1.5 cm, • advertising may be authorised in a rectangle of a maximum height of 6 cm on the lower part of the body number. |
| Materials | <ul style="list-style-type: none"> • tear-proof paper, printed with water-resistant ink, • self-adhesive body numbers are allowed, • avoid reflective surfaces that can reduce visibility in sunlight. |
| Colour | <ul style="list-style-type: none"> • preferably black on a white background, • distinctive body numbers on a different coloured background are authorised providing they remain legible. |

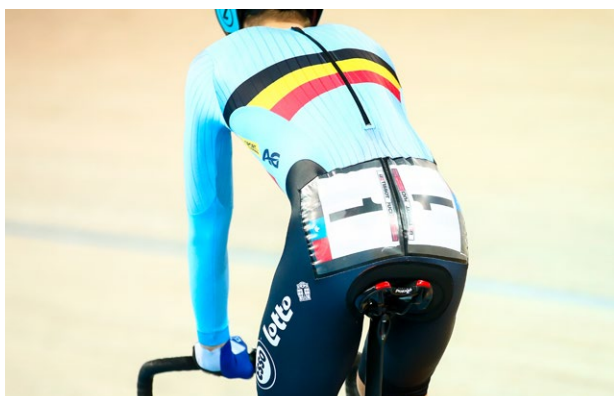

To ensure consistency across all events, and that the numbers can be properly read by all stakeholders, both in the infield, and on the outside of the track, the numbers must be positioned in the following way:

- 2 numbers:
 - side by side,
 - vertically,
 - lower back.
- 1 number
 - horizontally,
 - centre lower back.

As long as the numbers are positioned as described, these can be fixed to the rider using pins, some form of adhesive, or a clear pouch that is part of the clothing and does not in any way obscure any part of the number.



If a rider loses or damages a body number, he or she should inform the Secretary immediately so that a replacement number can be issued.

- The failure to use body numbers or their illegibility may be subject to a fine.

| | | |
|--|--|---|
| 4. Number, epaulet, cycle plate or frame plate changed or badly positioned | <ul style="list-style-type: none"> • Elite World Championships, • Men Elite World Cup, • Elite 6-days, Other Elite events | <ul style="list-style-type: none"> • Other events |
| 4.1. One-Day Race | <ul style="list-style-type: none"> • Rider: 50 | <ul style="list-style-type: none"> • Rider: 30 |
| 4.2. Stage Race | <ul style="list-style-type: none"> • 1st offence: 50 • 2nd offence: 200 • 3rd offence: elimination | <ul style="list-style-type: none"> • 1st offence: 30 • 2nd offence: 50 • 3rd offence: elimination |
| 5. ID number or frame plate invisible or unrecognisable <ul style="list-style-type: none"> • One-Day Race • Stage Race | <ul style="list-style-type: none"> • Rider: 100 • 1st offence: 100 • 2nd offence: 200 • 3rd offence: elimination | <ul style="list-style-type: none"> • Rider: 50 • 1st offence: 30 • 2nd offence: 50 • 3rd offence: elimination |

NOTE

A track competition can generally be considered as a stage race for the purpose of applying penalties.

Race numbers that are modified, obscured or badly positioned, make the Commissaires' work more difficult and can delay distribution of the results.

NOTE

Riders must wear the numbers that the organisation provides. They are not permitted to make their own numbers.

**REQUIRED KNOWLEDGE**

- How to recognise non-compliant race numbers issued by an organiser.

**WHAT TO DO**

- Verify the organisation has sufficient numbers that comply with the regulations.
- Verify that numbers are correctly positioned.

**WHAT NOT TO DO**

- Allow the organiser or Timing Company to dictate the placement of numbers.
- Allow riders to start without the required numbers.
- Allow riders to start with numbers not provided by the organisation.
- Fail to have spare numbers.

11.3. RIDERS' CLOTHING

The UCI Regulations specify the materials and appearance of clothing (**ARTICLES 1.3.026 to 1.3.072**). Some additional information is also contained in Part 3.

In response to continuing innovation in clothing, the UCI is seeking to retain control over developments. For the sake of clarity, further information on clothing innovation is provided in the final section of this chapter.

Commissaires should refer to the following basic information:



UCI REGULATIONS – PART I AND 3

| | |
|-------------------------------|--|
| General provisions | 1.3.026 Jerseys, shorts and skinsuits 1.3.027 Unique appearance of prestigious jerseys 1.3.029 Distinguishability of jerseys 1.3.031 Wearing helmets and conformity 1.3.033 Non-essential and additional clothing, including surface roughness and morphology altering. 1.3.071 Order of priority of wearing distinctive jerseys 1.3.072 Sanctions for clothing infringements |
| Teams registered with the UCI | 3.7.018 Registration of clothing 1.3.038 to 1.3.043 Advertising on clothing 1.3.044 Neutral jerseys and Six-Day Events |
| Regional and club teams | 1.3.045 to 1.3.047 Submission of samples, uniformity 1.3.048 Advertising on club clothing |
| Leader's clothing | 1.3.055BIS Leader's jerseys for UCI Cups, circuits and rankings |
| National team clothing | 1.3.056 Submission of national jerseys, conformity 1.3.057 to 1.3.058 Advertising on national jerseys 1.3.059 Events in which national jerseys are worn |
| World champion's clothing | 1.3.060 Right to use the rainbow colours 1.3.063 Wearing the world champion's jersey 1.3.064 and 1.3.065 Rainbow piping, authorisation 1.3.066 and 1.3.067 Advertising on rainbow clothing, approval |
| National champion's jersey | 1.3.068 Wearing the national champion's jersey: rights and obligations 1.3.069 Advertising on national champion's jersey, approval |
| Continental champion's jersey | 1.3.070 Wearing the continental champion's jersey: rights and obligations |



WORLD CHAMPION'S CLOTHING AND RAINBOW COLOURS (ARTICLES 1.3.060 TO 1.3.067)



- The rainbow design of the world champion's jersey is the exclusive property of the UCI (Copyright). Any commercial use of the rainbow colours is prohibited.
- The design of the world champion's jersey is strictly regulated and the placement of advertising is clearly defined.
- Only the reigning world champion may incorporate the rainbow colours on his or her equipment (bicycle, helmet, shoes, etc.).
 - The world champion may only use such equipment in events of the discipline, specialty and category in which he or she won the title.
- Any equipment bearing the rainbow bands must be submitted to the UCI for approval.



Example

The Elite Sprint World Champion is not permitted to use a helmet with world championship stripes while riding the Team Sprint, unless he is also the World Champion in the Team Sprint. It is specific to the discipline (Track), specialty (Sprint) and category (Elite).



- World champions are obliged to wear their world champion's jersey at all public appearances (races, podium ceremonies, press conferences, interviews, photo shoots, etc.).
- In Madison events, only the Madison world champions may wear the rainbow jersey. If only one of the riders is the Madison world champion, then both riders must either wear the same team jersey, or if the rider wears his or her world champion's jersey, the other rider must wear a plain white jersey.
- The rainbow colours may not be used during the World Championships as the title of world champion is at stake.
- All **former world champions** have the right to incorporate rainbow piping on the collar and sleeve cuffs of their jerseys. The former world champion may only wear such jerseys in events of the discipline, specialty and category in which he or she won the title.
- As is the case for the reigning world champion, the jerseys of former world champions featuring rainbow piping must be submitted to the UCI for approval.
- However, apart from rainbow piping on the collar and cuffs of a jersey, former world champions do not have the right to use the rainbow colours on other equipment.

NOTE

In six-day races, only Madison world champions may wear the rainbow jersey (this is the case even if they are not paired together).

**NATIONAL CHAMPION'S CLOTHING (ARTICLES 1.3.068 AND 1.3.069)**

- National champions are obliged to wear their distinctive jersey in events that are the same discipline, specialty and category in which they won their title.
- National federations (NF) are responsible for the design of the national champion's jersey. NFs are also responsible for approving, checking and issuing sanctions regarding the jerseys of their national champions.
- Only the reigning national champion is allowed to add national colours to his or her equipment (bike, helmet, shoes, etc.).

**NATIONAL TEAM CLOTHING (ARTICLES 1.3.056 TO 1.3.059)**

- It is obligatory for riders to wear national team clothing during the World Championships, Continental Championships and Olympic Games.
- Advertising placement is reserved for the NF. An exception is at the Track World Cup when advertising placement is reserved for the team, except for an area of 64 cm² on the front of the jersey which is for the NF.
- However, the NF may grant some advertising placement to the personal sponsors (teams) of the selected riders.
- World, continental and national champions must also submit to this rule and wear their national team clothing during the said events. For example, former world champions are not authorised to use rainbow piping on the collar or sleeve cuffs of their national team clothing during the World Championships.

**CONTINENTAL CHAMPION'S CLOTHING (ARTICLE 1.3.070)**

- The Continental Confederation decides if the wearing of this jersey is obligatory. If it is not obligatory, the rider can choose whether he or she wants to wear it.
- The regulations are the same as for the world champion's jersey with regard to the placement of advertising and restrictions.
- For example, the design of the European Champion's jersey is the property of the European Cycling Union (UEC) and the jersey must be submitted to the UEC and UCI for approval and registration.



ORDER OF PRIORITY (ARTICLE 1.3.071)

Unless otherwise specified and for all disciplines, should various provisions requiring the wearing of different jerseys apply to the same rider, the order of priority shall be as follows:

- world champion's jersey,
- leader's jersey of a UCI cup, circuit, series or ranking,
- continental champion's jersey (not mandatory as per **ARTICLE 1.3.070**),
- national champion's jersey,
- national team jersey (in accordance with **ARTICLE 1.3.059**).



FORM OF CLOTHING (ARTICLE 1.3.033)



Garments must not be adapted in any way such that they diverge from their use purely as clothing.

- Riders are prohibited from wearing clothing that has the purpose of improving performance by reducing wind resistance or modifying the rider's physical features (compression, elongation, support).
- It is also prohibited to wear clothing or skinsuits to which non-essential elements have been added with a view to improving aerodynamic properties, such as, for example, "wings" under the arms or an extension between the helmet and the jersey or by adding rigid elements to the clothing.
- The surface roughness of clothing may only be modified according to very specific limits.
- No substances or products may be applied to any part of the body with the aim of improving aerodynamics.



HELMET (ARTICLES 1.3.031 AND 1.3.002)



A helmet must be worn.

- The helmet must be approved in accordance with the prevailing safety standards, must not have been modified and must not have suffered an impact or been involved in an accident. The rider is responsible for the compliance (safety) of the helmet used.
- Removable components must not be added, although the use of a visor is authorised if specifically designed for use with the helmet.
- The surface and the material used for the helmet are not regulated. However, all additions are prohibited (including adhesive tape).
- Electrical systems must not be incorporated into helmets.

SHOES/SOCKS/GLOVES

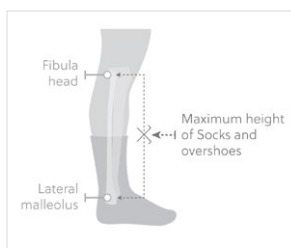

- Shoes that have been made more aerodynamic by the addition of a non-essential element or by a modification to the toe or heel are prohibited from competition.
- No part of the shoe should extend above ankle height.
- Socks may not ride above the height defined by half the distance between the middle of the lateral malleolus and the middle of the fibula head.
- Jersey sleeves may not be integrated with gloves. Any long sleeves must terminate at the wrist. Thumb pieces are not permitted.
- Mittens are not permitted.



INFRINGEMENTS (ARTICLES 1.3.072 AND 12.1.040)

Any infringement concerning unauthorised clothing may be penalised by the Commissaires.



REQUIRED KNOWLEDGE

- Recognition of helmets that comply with the regulations.
- Identification of clothing that has been manufactured to improve/correct a rider's morphology.
- Obligation and prohibition of wearing national and continental champion's jerseys.
- Rights concerning rainbow colours and piping.
- Conformity of UCI team and national team jerseys.



WHAT TO DO

- Implement the order of priority of jerseys.



WHAT NOT TO DO

- Consider that clothing checks are not part of the Commissaire role.
- Allow the priority order of jerseys to be disrespected.
- Allow riders to use jerseys that are not permitted.
- Allow riders to start with modified helmets.
- Allow unauthorised rainbow piping.
- Fail to check specialty and category for world champions and rainbow piping.

11.4. CONDUCTING THE CHECK

For major competitions, the UCI usually designates a Technical Commissaire who is responsible for bicycle checks. The Technical Commissaire must have the assistance of other Commissaires. Ideally each bike check station should have two Commissaires plus a volunteer to assist.

If a rider's equipment does not observe the regulations, the Technical Commissaire is responsible for informing the rider and ensuring compliance. If it is not possible for the equipment (including bicycle, clothing, helmet, etc.) to comply, the Technical Commissaire must inform the PCP and the rider must not be allowed to start.

The PCP is responsible for enforcing the decision.

If a Technical Commissaire has not been appointed, the PCP delegates responsibility for bicycle checks to a member of the Commissaires' Panel. This Commissaire performs the same role as the Technical Commissaire.

11.4.1. LOCATION

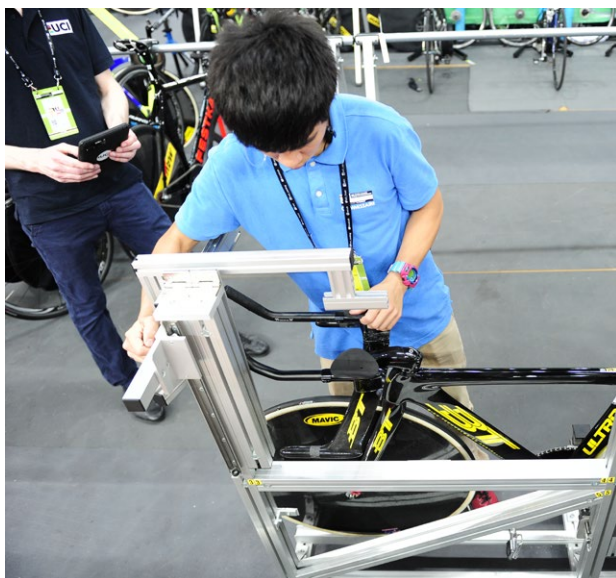

A bicycle check zone must be set up by the organiser with conditions that facilitate the Commissaires' work:

- the area must be large enough to allow for proper bicycle checks,
- the Commissaires prepare the area in cooperation with the organiser,
- the zone must feature a waiting area for riders (chairs, racks for bicycles, etc.),
- ideally there should be two bike check areas located near the ramps on to the track on either straight,
- if there is only one bike check area, this should either be located near the Starter's Podium or near the home straight ramp (where the riders normally access the track),
- the equipment used to conduct the bicycle checks must be verified before use (measuring jig, scales, etc.) and set out in such a way as to allow the checks to be carried out efficiently,
- the area must allow for a proper flow of bicycles.

NOTE

In the case where two jigs are being used, one of the jigs should be identified as the primary measuring device, and all official measurements should be made using this jig. This is to account for small variances between different jigs.

11.4.2.**TOOLS FOR CONDUCTING THE CHECK**

The organiser must make at least one approved measuring jig available to the Commissaires (but preferably two, one for each station).

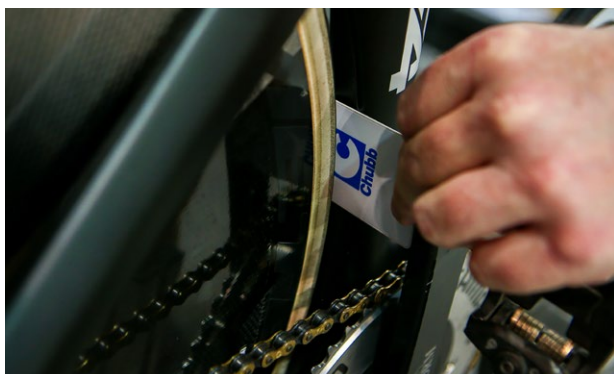

The Commissaires should also bring equipment with them to ensure that all checks are conducted properly. These include:

- Horizontality device (for checking the saddle),
- Vernier calipers (for checking the 3 to 1 ratio),
- Card (for checking fairings),
- Tape measure,
- Camera (for recording images for later verification),
- Adhesive tape,
- Notebook.

11.4.3.**TIMING**

The bike check station should open a minimum of one hour prior to the start of every session..

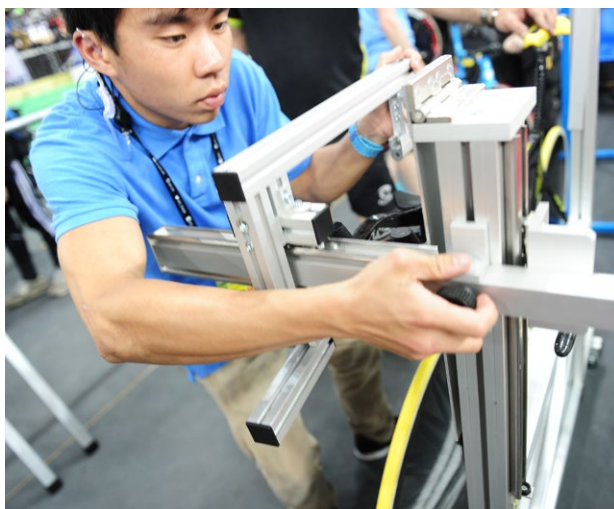

During competition:

- Bikes that have been checked must remain in the checking zone under the observation of the Commissaires until they go up on to the track. If they leave this area without going on to the track, they will need to be rechecked.
- Bikes must be checked prior to every race.
- It is important to ensure that sufficient checking equipment is available for bunch races. It may be necessary to use both bike check areas or to bring both measuring jigs to the same area.
- It is important to NOTE which bikes have been checked and are in compliance with regulations and which bikes must be rechecked before the start.
- If a bike starts without being checked, it must be checked after the race.

- It is always possible to check any bike at any point, even if it has already been checked, including after a race.
- Each Commissaire allocated to equipment checks must have a defined task. The official must be skilled in carrying out the task and be able to repeat the check for all competitors.
- The Commissaires have to carry out a large number of checks in a very short time over the course of the entire competition.
- The Commissaires do not have an easy task and must observe a strict procedural framework. The checking processes must be coherent and reproducible in the given time whatever the Commissaire, country or competition.
- All equipment must be evaluated in a consistent manner.
- In the event of any doubt, the Commissaires should refer to the UCI Equipment Unit through the coordinator.
- The approval procedures have facilitated and improved the equipment checks carried out by Commissaires.
- The rules must be applied in the interests of sporting equity and the safety of the riders in competition while respecting equality of opportunity for all.

**TIP**

If more than one jig is being used, for each individual bicycle, use the same jig for pre-checks as for the final checks. This avoids any potential problems where there may be slight differences between the jigs.

**REQUIRED KNOWLEDGE**

- The role of the Technical Commissaire.
- The setup of the bike check area.
- The organiser's responsibility as regards equipment checks.
- How to use the apparatus for equipment checks.

**WHAT TO DO**

- Work with the organiser and TD to arrange an area to allow checks to be carried out efficiently. Carry out pre-checks if possible.
- Check the conformity of the measuring jig provided by the organisation.
- Carry your own personal equipment to help conduct checks.
- Check all participants in a consistent manner.
- If there are doubts concerning equipment, observe and discuss these with the coaches.
- If any riders are unaware of the technical regulations, remind them of these.
- Stay calm and discreet during checks, although be firm when making decisions.

**WHAT NOT TO DO**

- Consider that the Commissaire's checks do not include equipment.
- Attend the competition without the tools required to conduct equipment checks if this is your responsibility.
- Fail to check bikes before the start or every race.
- Allow unauthorised rainbow piping on bikes.
- Allow a rider to start even if his or her helmet has been modified (hole for radio, visor stuck on, addition of a shield, etc.).
- Allow a rider to start with non-compliant or unauthorised clothing.
- Fail to carry spare batteries (for electronic spirit level and scales).

TISSOT

UCI

TRACK CYCLING
WORLD CUP

MANCHESTER
GREAT BRITAIN

**CHAPTER 12
ANTI-DOPING**

**DOPING
CONTROL**

TISSOT
SWISS WATCHES SINCE 1853

HSBC UK

BRITISH
CYCLING

UK sport
LOTTERY FUNDED

MANCHESTER

As specified by the World Anti-Doping Code, the UCI has the obligation, as is the case for all international federations, to plan and organise anti-doping controls during international cycling competitions.

The objective of this chapter is not to instruct National and International Commissaires on how to carry out anti-doping controls, but rather to draw their attention to the responsibility that is borne solely by Doping Control Officers (DCO) trained by the Cycling Anti-Doping Foundation (CADF) and agents trained by National Anti-Doping Organisations (NADO).

CYCLING ANTI-DOPING FOUNDATION (CADF)



The UCI has mandated the Cycling Anti-Doping Foundation (CADF), a foundation organized under the laws of Switzerland, for the purpose of managing anti-doping activities on behalf of UCI, i.e., in particular: Planning effective Testing, Registered Testing Pool (RTP) management, Biological Passport Program (Hematological and Steroidal), Results Management (initial review) and administrative support for the management of Therapeutic Use Exemptions (TUE). As such, the CADF is responsible for the planning and execution of sample collection process at competitions.

CADF DOPING CONTROL OFFICERS (DCO)

Doping Control Officers, trained and accredited by the CADF, play an important role in protecting riders' rights.

- DCOs act in accordance with procedures/directives.
- They listen to the riders' opinions.
- They behave in a professional and courteous manner at all times.
- They are assigned by the CADF.
- They must renew their accreditation.

ANTI-DOPING CONTROL STATION

The doping control station shall be solely used for anti-doping purposes.

- The doping control station must be in compliance with the Anti-doping Regulations and its appendices.
- The doping control station must be set up within the immediate proximity of the track.
- The doping control station must respect the riders' privacy.
- Access must be restricted solely to accredited persons involved in the anti-doping control, i.e.:
 - the riders,
 - person selected by the rider and an interpreter (one per rider), totaling two people per rider (three for minors),
- CADF Doping Control Officer and staff,
- other individuals authorised by the CADF (observers).

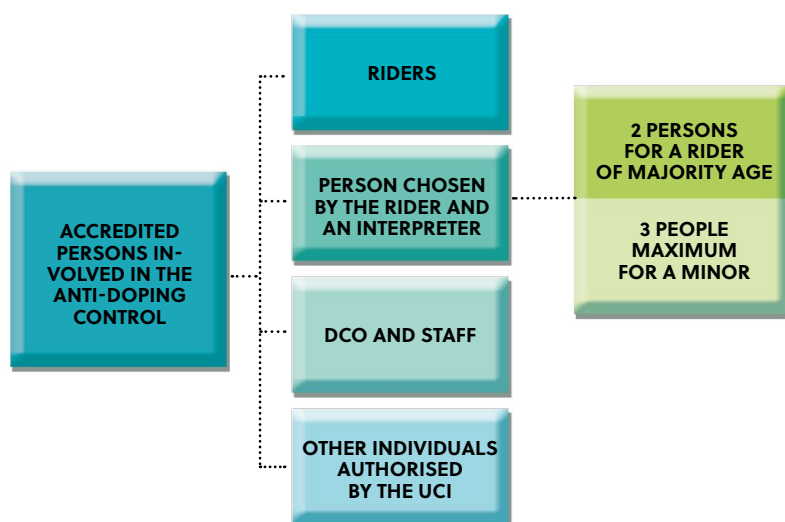

Diagram. Individuals authorised to access the doping control station

SELECTION OF RACES

UCI International Competitions, defined annually by the CADF, are submitted to anti-doping controls according to the UCI Anti-Doping Rules.

Doping controls, conducted under the authority of UCI are organized by the CADF.

Now the competition is either listed as a UCI International Competition for which the UCI is the testing authority, or it is a National Competition for which the NADO is in general the testing authority.

SELECTION OF RIDERS TO BE TESTED

The CADF may designate which riders are to be tested at a specific competition and issue corresponding instructions to the DCO. If such instructions are not issued, the DCO will test riders according to current procedures.

THE ROLE OF THE DOPING CONTROL OFFICER (DCO)

The DCO carries out the following tasks:

- **Contacts the organiser** on receiving the letter of confirmation of appointment in order to confirm certain practical arrangements: equipment, staff, infrastructure, transport of samples, etc.
- **Attends the team managers' meeting** to provide information on the practical details of the controls.
- **Inspects the doping control station** upon arrival to ensure it complies with the regulations: layout, equipment, drinks, etc.
- **Instructs the sample collection personnel (chaperones, sample witness)** and explains the procedures to be observed. Checks availability of appropriate equipment: identification cards, clipboard for notification forms.
- **Posts the list of riders to be tested** at the entrance to the doping control station and at the finish line if applicable.
- **Carries out controls:** every rider to be tested must attend the doping control station as soon as possible and at the latest 30 minutes after finishing the event.

If the rider is taking part in an official ceremony or attending a press conference in accordance with the regulations, this deadline shall be 30 minutes from the end of the ceremony or the time at which the rider is no longer required to attend the press conference, depending on which of these two events is the latest.

- **Sending samples to the laboratory:** the DCO is responsible for sending the samples with the assistance of the organiser.
- **Sending all documentation relative to the anti-doping mission to the CADF** as soon as the race ends.

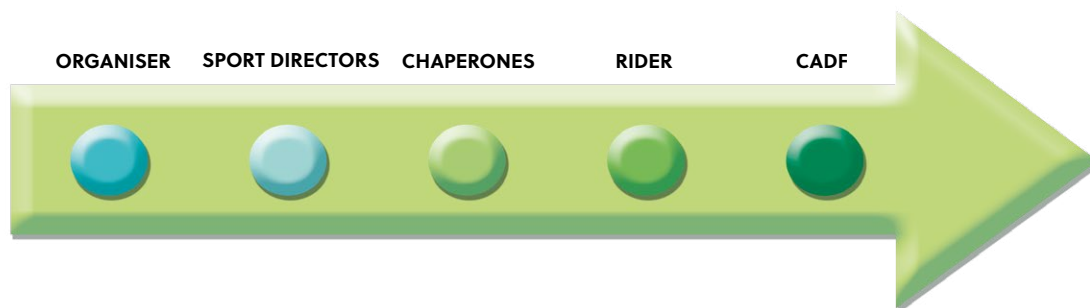

Diagram. Sequence of contacts of a Doping Control Officer



REQUIRED KNOWLEDGE

- Who is responsible for setting up the doping control station.
- Which organisation selects riders to be tested.
- Where to find the UCI anti-doping rules.
- If a DCO is present, allowing him or her to intervene during the sport directors' meeting.
- The organisation of the doping control station.
- How to identify chaperones and knowledge of their roles and limits of action.
- The people who may accompany a rider during an anti-doping control.



WHAT TO DO

- Discuss any problems encountered with the DCO.
- Refrain from making comments or statements on the anti-doping procedures.
- Assist any rider who cannot find the doping control station to get there in time.



WHAT NOT TO DO

- Enter the restricted anti-doping control area with-out authorisation.
- Give an opinion on a test or any result of an abnormal analysis during a competition.
- Fail to help a team assistant who cannot find the list of riders to be tested.
- Speak to the media.



CHAPTER 13
THE ENVIRONMENT

The purpose of this chapter is to make Commissaires aware of the environmental protection procedures that organisers may adopt. There follow examples of actions that an organiser may implement to ensure that a cycling competition respects the environment. At present, these measures are only recommendations rather than obligations on organisers. As a result, Commissaires only act as observers.

13.1. WHY IT MATTERS

Cycling, by its nature, is a flagship activity among sports that respect the environment as it:

- is a non-polluting means of transport,
- can be practised at any time,
- is suitable for all ages,
- can be practised all around the world.

However, despite cycling's natural benefits, the cycling community – in particular competition organisers and national federations – still need to encourage and promote reflection on these advantages.

WHAT CAN THE ORGANISER DO?

Preparation for the competition: this involves planning and launching the initiatives that the organiser wants to implement.

During the competition: implementing the initiatives. The organiser monitors and endeavours to keep control of the situation in the best way possible.

After the competition: the organiser returns any infrastructures to their original condition. A post-race assessment allows the environmental policy to be improved.

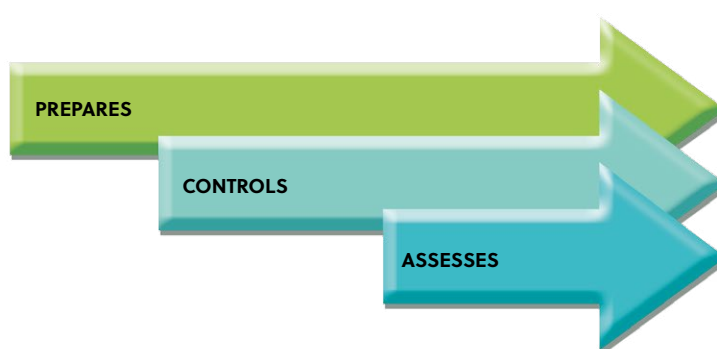

Diagram. The organiser's role

WHAT CAN THE COMMISSAIRE DO?

The UCI cannot oblige organisers or national federations to implement environmental measures in the management of cycling competitions. However, the UCI does have a role as an instigator, ranging from raising awareness of problems to offering concrete advice to organisers on how to minimise the impact of cycling competitions on the environment.

As there is no regulatory framework to oblige organisers to implement environmental measures, the only means that the UCI has to promote its green policies are encouragement, recognition and incentives. Commissaires must be attentive to all environmentally-friendly procedures implemented by an organiser. These positive points can be noted in an annexe to the competition evaluation report.

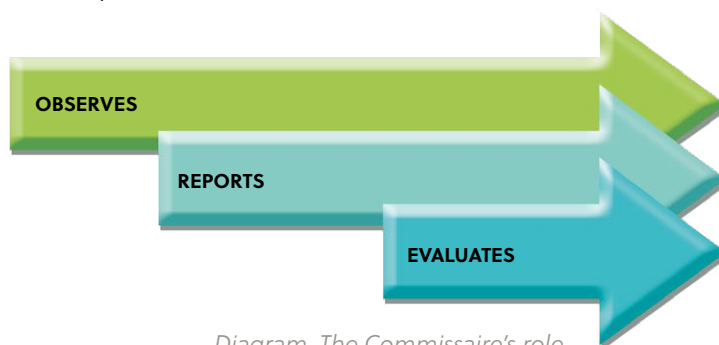

Diagram. The Commissaire's role

13.2. PREPARATION FOR THE COMPETITION

When planning environmental initiatives, the organiser can set targets and organises the competition with a view to minimising negative environmental impacts.

Some example initiatives:

- **Public documents:** internal and external communiqués that emphasise the organiser's responsible commitment and desire to organise a greener competition. Raising awareness during meetings, including the sport directors' meeting.
 - *Meetings, official communications, procedures, specifications, explanations, involvement, incentives and empowerment.*
 - *The Commissaire should also check whether the competition's technical guide contains a reminder to participants on environmental issues in order to raise awareness.*
- **Potential risks:** identifying the risks and inviting the stakeholders concerned to implement a high-quality environmental policy.
 - *Deterioration of the natural environment, damage to infrastructures, sound disturbances, other pollution, waste.*
- **Official recognition:** recognition of an environmental management plan by an official body.
 - *Label, recognition, certificate, etc.*
- **Green transport:** promoting the use of public transport (combined tickets, free public transport to the site), installing signs informing spectators of how many minutes it takes to walk to the competition location; favouring alternative solutions such as the use of natural gas, hybrid or electric vehicles; giving detailed plans of the best routes to take to access the sites while reducing transport times; encouraging parking on hard surfaces (asphalt, hard-packed ground, tarmac) to avoid environmental damage in the event of rain.
 - *Train, shuttle bus, car sharing.*

- **Action plan:** a plan that provides details of environmental initiatives over several years and the allocation of tasks.
- **Communication:** encouraging and promoting environmental initiatives such as the sorting of litter, protecting nature reserves and wildlife areas, appointing an environmental ambassador (a VIP, former professional cyclist, etc.). Delivering "eco-responsible" messages.
 - *Competition website, posters at registration desk, information points, changing rooms, parking areas.*
- **Choice of infrastructure:**
 - *The use of temporary, modular, reusable and transformable infrastructure rather than constructing permanent structures.*
 - *The use of environmentally-friendly materials.*
 - *Reducing and optimising energy use: insulation, ventilation, heating, air conditioning, lighting, etc. (preferably certified or approved units).*
 - *Gathering and reusing rainwater.*
 - *Infrastructure that is easily accessible and well served by public transport services. Consideration should also be given to individuals with reduced mobility*

13.3. DURING THE COMPETITION

During the competition, the Commissaire focuses on the sporting control of the race. Environmental initiatives put in place by the organiser are not subject to any checks by the Commissaire. However, it is useful to be able to recognise the various initiatives that may be applied.

Some example initiatives:

- **Paper:** use of recycled paper, printed on both sides, for communiqués; favouring the dispatch of documents in an electronic format; printing in black and white; electronic versions of all documentation relating to the competition (Program, special regulations, etc. on USB stick or intranet), screens to provide official information.
- **Toilets:** the use of dry or chemical toilets.
- **Signage** should be clear and accurate so that no ecologically fragile areas are damaged. Products that are environmentally-friendly, compostable, recyclable and reusable should be utilised.
- **Noise pollution:** avoid noise pollution as far as possible, e.g. by the use of signs to discourage excessive noise.
- **Air quality:** limit vehicle access as far as possible, enforce no smoking areas, reduce greenhouse gas emissions.
- **Accommodation:** provide accommodation close to the event venue (for both participants and officials).
- **Food and other supplies:** distribute food in packaging that is minimal, recyclable and biodegradable. Favour supplies and services from local providers; use products that are in season.
- **Clean up competition site** after the race.

**REQUIRED KNOWLEDGE**

- The UCI's commitment to enhancing the environment.

**WHAT TO DO**

- Inform the UCI of the organiser's environmental arrangements.
- Assess the effectiveness of the arrangements put in place.
- Observe the measures implemented for the various parties: teams, riders, spectators.

**WHAT NOT TO DO**

- Highlight ineffective or non-existent arrangements.
- Criticise an organiser for the lack of an environmental initiative: at present the UCI policy is only to encourage organisers.

A man in a light blue short-sleeved shirt with a "UCI" logo on the chest and a red lanyard with "UCI CYCLING" text is leaning over a man in a black shirt. The man in the blue shirt is wearing glasses and has his hands on his hips, looking down at the laptop screen. The man in the black shirt is looking up at the man in the blue shirt. The background is blurred, showing other people in a room.

CHAPTER 14 MANAGEMENT AND RELATIONSHIP SKILLS

As a representative of the UCI and the national federation, a Commissaire is one of the main stakeholders in a cycling competition. Commissaires' behaviour and attitudes are constantly observed, analysed and commented upon. The whole family of cycling may judge a Commissaire on his or her conduct.

It is important for a Commissaire to develop basic managerial and relationship skills to allow him or her to carry out all the necessary functions and achieve the assigned mission in an effective manner.

Commissaires must not only remain calm in all circumstances, they should also, over time, continue to work on their behaviour and approach, develop their expert knowledge and refine their communication techniques.

14.1. THE THREE CATEGORIES OF SKILLS

The Commissaire must develop and broaden skills in three main categories: intellectual, organisational and relationship.

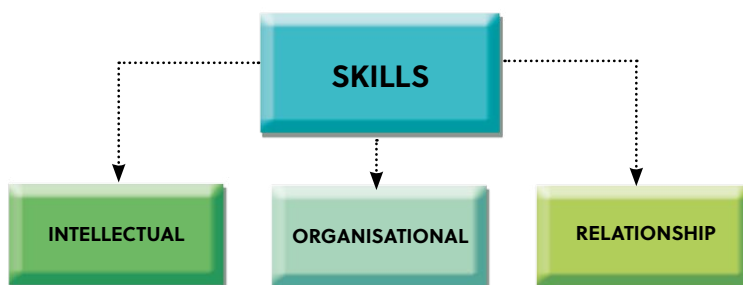

Diagram. The three categories of Commissaire's skills

INTELLECTUAL SKILLS

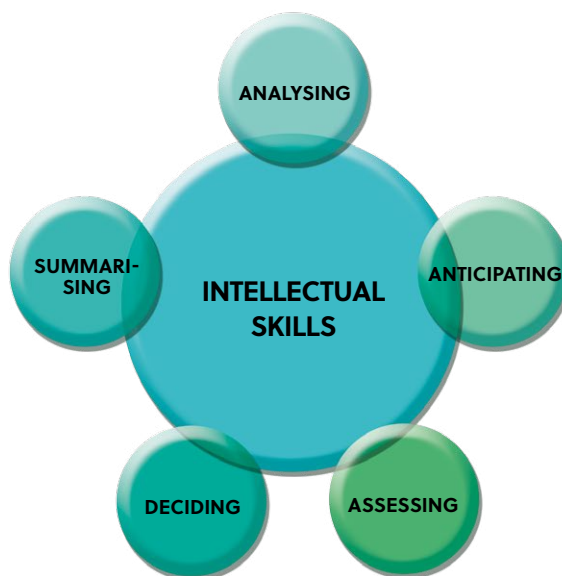

Diagram. A Commissaire's intellectual skills

- **Analysing:** understanding a problem or situation and using it as a means of improvement.
- **Anticipating:** foreseeing a situation before it arises in order to better contain the consequences and limit the effects.
- **Assessing:** assigning a value to an action or issue at the time at which it happens, including by using instinct.
- **Deciding:** making choices after evaluating the risks and weighing up the positive and negative points.
- **Summarising:** collating the essential or important elements of a situation that has occurred in order to present a comprehensive overview that can be understood by parties who are not present.

ORGANISATIONAL SKILLS

Diagram. A Commissaire's organisational skills

- **Checking:** carrying out verifications of existing information.
- **Coordinating:** bringing several different interacting domains or people together to enhance outcomes.
- **Evaluating:** judging according to precise criteria and material deeds.
- **Managing:** taking charge of a specific or particular action with a clear objective.
- **Organising:** defining and implementing a system that frames and integrates all actions to be conducted by a group of clearly identified people.
- **Planning:** scheduling the expected chronology of tasks, taking care not to leave any quiet periods nor, conversely, overburdening the time available.
- **Verifying:** ensuring that everything is running appropriately, taking stock of recommendations made and observing whether these are understood and applied.

RELATIONSHIP SKILLS

Diagram. A Commissaire's relationship skills

- **Advising:** determining and proposing a solution to a situation that has been encountered.
- **Communicating:** encouraging and participating in exchanges that establish clear dialogues. Transmitting information and eliciting responses.
- **Delegating:** confiding a mission or responsibility to a person with a clear objective over a specific time period.
- **Encouraging:** mobilising for a specific action; creating a group dynamic.
- **Instructing:** passing on knowledge and assisting others to make progress.
- **Managing:** leading a group in order to favour collective action, integrating and encouraging participation.
- **Motivating:** boosting the morale of a group of people who come together within a defined framework in order to achieve an objective.
- **Negotiating:** reasoning with one or more interlocutors to express arguments or highlight contradictions with the objective of promoting unity or finding consensus for a current issue.

14.2. SPEAKING AND INTERVENTIONS BY THE COMMISSAIRE

LEADING A MEETING

Preparation in advance is essential. This ensures that nothing is forgotten, that a list of those taking part is compiled and makes it more likely that the meeting will finish on time.

- An introduction allows the background and the objective to be established: the goal to be achieved must be understood by all.
- Interventions should be smooth and fluid. Contributions should not be too long and remain objective.
- The conclusion must be the subject of common agreement or clear decisions.
- Essential background information: the objective to be achieved and the time allotted for this.

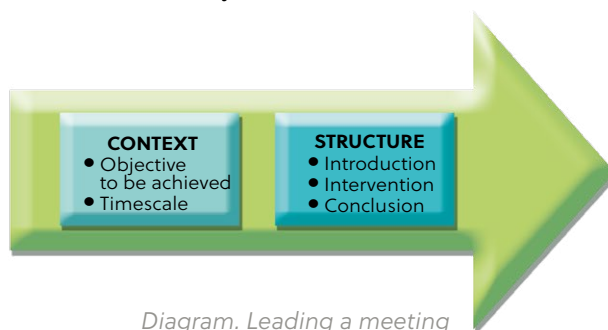

Diagram. Leading a meeting

ONE-OFF INTERVENTIONS BY THE COMMISSAIRE

The Commissaire may intervene in the following meetings

- team managers' meeting,
- Commissaires' Panel meeting,
- briefings set up by the organisation (the media, TV production, medical service, law enforcement agencies, etc.),
- ad hoc meetings for specific situations.

GETTING A MESSAGE ACROSS

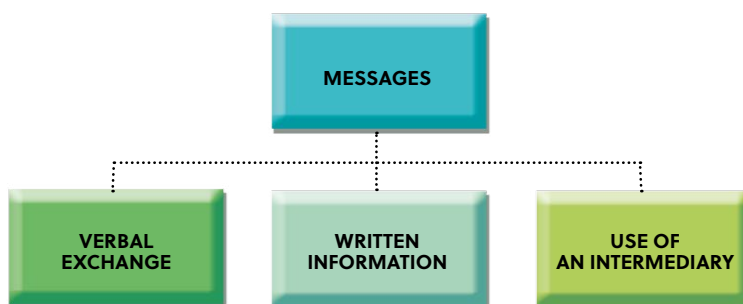

Diagram. Methods of getting a message across

There are several techniques available to a Commissaire who wants to impart a message:

- **a verbal exchange** (suggesting a change to the organiser, reorienting a colleague official, talking to a rider or team manager to explain a sanction, etc.),
- **written information** (drawing up a communiqué on a change in programme, issuing a reminder of a rule or instruction, drawing up a report, etc.),
- **communicating through an intermediary** (asking a Commissaire to pass on information to a team, using an interpreter to overcome language barriers, etc.).

The method used depends on the situation and the desired objective.

A verbal exchange leading to agreement should always be preferred as it involves communication with a specific individual (e.g. a rider who has just committed an infringement: the Commissaire immediately tells this person what has been observed; communication is rapid, clear and accurate).

Written information means that there is traceability and no ambiguity for any of the stakeholders involved (e.g. communiqués on changing the start time. These should be written in a straightforward manner that can be understood by all).

It is important for the Commissaire to know to whom he or she should communicate, in this way adapting the intervention to the relevant situation and selecting a suitable moment and method of broaching the subject.

Before any intervention with a third party, the Commissaire must consider the following questions:

- Who am I addressing?
- What is my objective?
- How am I going to present the subject?
- When shall I intervene?

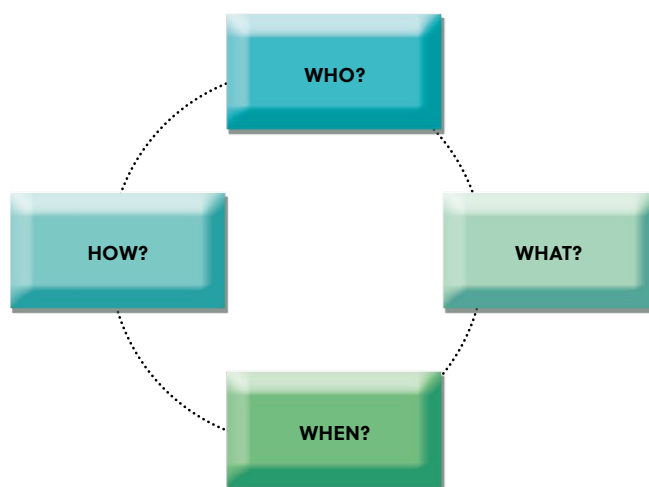

Diagram. Questions to consider before an intervention

INTERVENTION WITH THE PARTIES CONCERNED

When the Commissaire is led to intervene directly with a rider:

- It is always preferable to avoid this when the rider has just made a considerable effort. He or she will not be receptive and the effect could be the opposite of that expected.
- It is often preferable to use the team manager as an intermediary as he or she will have a good idea of the rider's likely reactions or emotions in a given situation.
- If a direct exchange is essential, then this can possibly wait until later in the competition session to allow time for reflection, both for the person issuing and the person receiving the information, thus allowing an empathetic response.
- However, in some serious cases, speed is of the essence and the specific information must be imparted immediately while adopting a suitable manner when presenting facts (that may be upsetting for the recipient).

When a message has to be imparted to the organiser, consideration should be given to any difficulties or problems that the organiser faces by adapting the terms used to the situation or problem, although without any complacency.

Messages for teams and team managers must be firm. On the other hand, they must emphasise sensitivity and receptiveness if a message is to bear fruit. The aim of the message must be clear, accurate, measured and well received by the recipient.

Information for the media should be distributed through the organisation. The objective is to be effective without prejudicing the organisation, as the organisation guarantees the smooth running of the competition and facilitates interactions.

Messages to the Commissaires' Panel or a colleague official generally concern the rules of operation or the need to reframe the approach after operations have gone off course. There must be consideration of what will be said and why an intervention is necessary. The optimum timing should be established; if the whole Commissaires' Panel is concerned, the message should be communicated during a meeting. If the message is directed to an individual member of the Commissaires' Panel, a suitable time must be selected in order to be effective.

14.3. RESPONDING TO AN INTERVIEW

The PCP is the spokesperson for the Commissaires, but should not grant any media interviews, or comment to the media. If an interview or comment is requested of a Commissaire, this request must be referred to the PCP, who in turn must refer the person from the media to either the organisation or UCI Press Officer. The PCP should notify the UCI Press Officer of the request, as well as provide any pertinent information related to that request.

14.4. MANAGEMENT OF THE COMMISSAIRES' TEAM

The President of the Commissaires' panel appointed by the UCI is in an almost unique management situation. The Commissaire may be required to provide leadership:

- of a team that he or she does not necessarily know in advance,
- in a language which he or she may only know partially or not at all,
- against the background of a very different cultural context,
- for a relatively short period of time.

Standard management techniques may thus be difficult to apply as the period of the appointment does not allow the President of the Commissaires' Panel to work while considering the medium or long term.

Despite this, a successful leadership role can be facilitated by adopting the following approaches:

- Basic linguistic and cultural preparation to promote integration and not always have the attitude of "discovering" practices and exchanges, in this way avoiding unacceptable behaviour.
- Active listening, or sympathetic listening, which consists of listening without any preconceptions and without interrupting, before returning to the subject and asking questions, in order to express genuine motivation or concern.
- Identifying the individuals in a team who are dominant due to their experience or position. Checking whether this situation is likely to encourage or inhibit the rest of the team.
- Expressing clear expectations by defining the requirements.
- Always giving background to the requirements, explaining "why".
- Delegation: placing trust in others does not exclude checking the achievement of tasks.
- Knowing how to offer congratulations.
- Knowing how to reorient a situation.



REQUIRED KNOWLEDGE

- Being factual and accurate.
- Being organised.
- Being methodical.
- Knowing how to listen and being ready to understand.
- Capacity to reproduce an exchange or situation.
- Respecting the comments of others.
- Remaining humble.
- Staying calm in all circumstances.
- Observing and checking on the basis of the regulations.
- Analysing situations to avoid acting in haste.
- Offering warnings and information rather than sanctions.
- Considering your role as that of an instructor to all involved.



WHAT TO DO

- Always prepare before speaking.
- Proofread communiqués before distribution.
- Reserve the right not to respond to a problem for which a solution cannot be offered.
- Be alert to any digression of questions which may have serious consequences.
- In the event of any doubt, rephrase a question that may not have been understood.
- Choose the right time at which to speak to a rider, respecting their intense physical efforts.
- Always endeavour to reach consensus.



WHAT NOT TO DO

- Fuel an argument or debate that may be unconstructive or even destructive.
- Indicate that you do not agree with a decision taken by the Commissaires' Panel.
- Accuse and make assertions without proof.
- Spread false reasoning.
- Become involved in issues that are outside your field of action or competence.
- Act or speak in an imprecise or erroneous manner.
- Grant a media interview.

APPENDICES

Abandoning - Accreditation - Anti-doping station - Assistant PCP
 Body numbers
 Calendar, International - Calendar, National - Cancellation - Categories of rider per race type - Competition - Cross - Country Olympic (XCO) - Cross - Country Marathon (XCM) - Cross - Country Eliminator - Cross - Country Short Circuit (XCC) - Cross - Country Stage Races (XCS) - Chaperone - Chicken line - Chief Doctor - Class of event - Commissaires - Continental federation
 Continental championships
 Disqualification (DSQ) - Distance signs - Doping Control Officer (DCO) - Double track Entry fees
 Feed and technical assistance zone (FTA zones) - Final, big - Final, small Fine (monetary) - Finish line - Finishing straight - Forerunner
 Gate - Go-arounds or Chicken line
 Lapped riders - Lead bike - Leader's jerseys - Level crossing - Licence checks
 Marshals - Mechanical incident
 Official ceremony - Onboard camera - Organiser
 Padding - Penalties - Photo - finish - Photographers' zone at the finish - Pinch-point - Plate number - Podium - President of the Commissaires' Panel (PCP) - Press conference - Press
 Profile of the event/stage
 Qualifying round
 Race Director - Registration - Relegation - Race headquarters
 Safety nets - Seeding run - Single track - Special regulations - Sport Director - Staging - Stage race - Start/finish area - Start line - Start list - Sweep bike
 T-bone - Team - Technical guide - Training (official training) - Transponders
 UCI ranking - UCI secretary
 Training - World Championships - World Cup - Yellow/Red flag
 Zone, A and B

15.1. GLOSSARY

100 m LINE

A 4 cm wide white line painted perpendicularly across the track, 100 m before the Finish Line.

200 m LINE

A 4 cm wide white line painted perpendicularly across the track, 200 m before the Finish Line.

A ABANDONING

When a rider voluntarily decides to withdraw from a race.

ACCREDITATION

All individuals that are involved in a competition must be accredited by the organiser. This accreditation affords access to certain zones that are closed to the public.

ANTI-DOPING POST

The organiser must make a suitable location available for controls to be conducted after the race. This facility must be located at the velodrome and very clearly signposted. Access must be monitored and restricted solely to accredited persons involved in the anti-doping control. The control post consists of at least three separate rooms, namely a waiting room for approximately 10 people, an office for the Doping Control Officer and doctor as well as a bathroom where the samples are taken.

B BANKING

The amount of tilt at any point on the track, both on the straights and in the turns. This is usually a function of the length of the track and is used to assist the riders in remaining on the track surface. Sometimes the turns are also referred to as the bankings.

BIKE-CHECKING AREA

Before the start of every race, each rider should present his or her bicycle for a check at least 15 minutes before his or her start time. At least one, but normally two bike-checking areas must be provided for these procedures. The area should be near the ramp on to the track and provided with a bike measuring jig.

BLUE BAND

A rideable blue band painted on the inside of the track that must be at least 10% of the width of the track. While it does not form part of the racing area, it must be usable by the riders during a race.

BODY NUMBERS

Body numbers are used to identify riders in a race. It is the organiser's responsibility to provide body numbers in compliance with the UCI Regulations ([ARTICLE 1.3.074](#)). It is each rider's responsibility to wear the numbers without obscuring or modifying them. Riders are required to wear the numbers provided by the organisation.

BUNCH

Normally the largest group of riders on the track during a bunch race. It is the principal group, as decided by the Commissaires, that is used to determine when riders have gained or lost laps.

C CALENDAR, INTERNATIONAL

An international competition is a race registered on the world calendar or one of the continental calendars. The calendar lists all international competitions in chronological order. The international calendar is drawn up every year for the following season and approved by the UCI Management Committee in September.

CALENDAR, NATIONAL

National calendars are drawn up by the respective national federations.

CATEGORIES OF RIDERS

The UCI's rider categories are as follows:

- **Junior – Men and Women (MJ and WJ):**
riders aged 17 and 18,
- **Under 23 – Men and Women (MU and WU):**
riders aged from 19 to 22,
- **Elite – Men and Women:**
riders aged 23 and over for men and 19 and over for women.

CEREMONY PODIUM

The organiser must provide a podium for the official ceremony. The ceremony platform must be large enough to accommodate the riders, officials, partners, hostesses and master of ceremonies. A waiting area must be provided behind the podium, or close by, to allow the riders to prepare for the ceremony.

CHAPERONE

For anti-doping controls after the race, the organiser is obliged to provide at least one escort for each rider to be tested. These rider escorts are known as "chaperones". The chaperone remains with and observes the rider at all times, accompanying him or her to the doping control post.

CHIEF DOCTOR

The organiser may appoint one or more doctors. Medical care during the competition shall be provided exclusively by the doctor(s). A chief doctor, who specialises in sports or emergency medicine and who has experience of cycling, should be the general coordinator.

COMMISSAIRES

The number of Commissaires appointed to an event varies. Commissaires are appointed by the UCI or the NF depending on the class of competition. Acting under the direction of the PCP, Commissaires carry out the sporting management of the competition on the ground and take decisions on sanctions.

COMMUNIQUÉ

Official competition document issued by either the Commissaires' Panel, Doping Control Officer or Organisation. It is used to provide official information related to the competition, before, during and after the competition.

COMPETITION

A competition is the entirety of all the various events that are held under a single rider registration and confirmation process. The competition is what is registered on a calendar. Examples of competitions are the World Championships, World Cup, London Six Day, Milton Challenge.

CONTACT TAPE SWITCH

A contact tape switch is used in electronic timekeeping. It consists of two metal contacts separated by insulation. When pressure is applied, the contacts join and an electronic signal is sent. These are usually taped at start and finish lines across the track and are activated when a bicycle wheel rolls over them. This device is also known as a contact strip.

COUNTDOWN MECHANISM

This is the electronic apparatus used to start events that require a standing start. It has two main parts. The first is a control panel which is normally located on the Starter's Podium. The second part is a display board that indicates the number of seconds remaining to the start to the rider. When initiated, this provides a visual countdown of the seconds to the start. The countdown mechanism is also usually connected to a timing system and/or starting gate so that when it reaches zero seconds, the timing starts and/or the starting gate opens.

D DEAD HEAT

The finish judge may classify riders as "dead heat" when two riders cross the line simultaneously and cannot be separated. Depending on the event, the riders are either classified as tied, or are separated based on the regulation for that event.

DISCIPLINE

This is one of the main branches of cycling. There are eight disciplines, of which Track cycling is one.

DISQUALIFIED

If a rider commits a serious infringement, he or she may be disqualified and excluded from the results. The disqualification usually applies to a specific event rather than the entire competition.

DOPING CONTROL OFFICER

The DCO is appointed by the UCI or the national federation and works in collaboration with the doctor appointed to conduct the anti-doping control as well as with the PCP. The DCO is responsible for managing anti-doping controls on the ground and oversees the application of the anti-doping rules.

DROPPED RIDERS

In bunch races, dropped riders are those who can no longer maintain the pace of the race and who are left behind by the bunch. In races where points are scored in intermediate sprints, dropped riders are ineligible to score points until they have been lapped by the bunch.

E ELIMINATED

A rider who is eliminated is removed from the race and may not participate in any further rounds of that particular event (other than if the elimination occurs in the Elimination Race in the Omnium). However, the rider is normally ranked based on when he or she was eliminated.

EQUIPMENT CHECK AREA

See *Bike-Checking Area*

EVENT

This is one of the track specialities and may consist of a number of separate races, heats and/or rounds. Examples of events are the Sprint, Individual Pursuit and Team Sprint.

F FINISH JUDGE

The Finish Judge has sole responsibility for drawing up the results. The Finish Judge must stay focused on the entire race so that the leader on the track can be located and identified. The Finish Judge is a member of the Commissaires' Panel.

FINISH LINE

The finish line comprises a line 4 cm in width, painted in black on a white strip 72 cm wide, thus leaving 34 cm of white on each side of the black line.

FLAG, GREEN

This is a flag used by the Commissaire on the back straight to indicate to the Starter that a rider or team is ready for the start. It is also possible to use a red flag.

FLAG, RED

The red flag has a number of purposes:

- it is used by the Commissaire on the home straight to indicate to the Starter that a rider or team is ready for the start,
- it is used by the Commissaires on the back and home straights to indicate to riders in the Team Pursuit competition that they may no longer exchange positions,
- it is used in bunch races to indicate to a rider that he or she has been disqualified. In this case, it is usually used in conjunction with a whiteboard on which the rider's number is also displayed,
- it is used by the Commissaire on the home straight to clear the track prior to the start of a session.

FLAG, YELLOW

This flag is used by the Commissaire on the home straight in bunch races to indicate to a rider that he or she has been given a warning. In this case, it is usually used in conjunction with a whiteboard on which the rider's number is also displayed.

FLYING START

This is a type of start for a timed event where the rider has a certain amount of distance to build up speed prior to the start of the race. When reaching the start line, the rider is usually travelling at a fairly high speed.

H HEAT

Heats are the various races in an individual round that are used to qualify riders for the following round and to eventually determine the finalists.

I INTERMEDIATE SPRINTS

The details of intermediate sprints are normally described in an event's regulations. For unusual events that are not defined by the UCI Regulations, these details must be provided in the competition technical guide. Points are usually awarded in intermediate sprints and used to either determine, or help determine the winner of a race.

J JUDGE-REFEREE

The Judge-Referee is a member of the Commissaires' Panel who is responsible for making decisions on the sporting conduct of riders in most of the bunch races. The Judge-Referee takes up a position outside the track on corner 1, with a view down the home straight. The Judge-Referee communicates decisions made to the PCP, who is responsible for having these announced and implemented.

L LICENCE CHECKS

All persons participating in the competition as riders, or as team managers for the riders, must be licensed. Commissaires should check the licences of the riders and team managers before the start.

LIST OF STARTERS

The list of starters is a definitive list. It is drawn up after the confirmation of the starters and records all the riders participating in the competition.

M MEASUREMENT LINE

A 5 cm black or white line painted longitudinally around the track. The line's inside edge is 20 cm from the edge of the Blue Band and is used to define the length of the track. Small markings starting from the Finish Line are placed every 5 m along this line.

MEASURING JIG

Other than for certain specified major competitions, the organiser must provide a measuring jig for use by the members of the Commissaires' Panel. The jig indicates the dimensions and limits of a bicycle that should be checked. The organiser is solely liable for the compliance of the measuring jig with UCI specifications. For specified major competitions, the UCI Equipment Department is responsible for providing the measuring jig.

MISHAP, RECOGNISED

A recognized mishap is a:

- crash,
- puncture,
- breakage of an essential part of the bicycle.

MISHAP, UNRECOGNISED

An unrecognised mishap is any mishap that is not recognised.

MIXED ZONE

The organiser may set up a "media mixed zone" in the infield. This zone is reserved for the media from different countries (print press, radio, TV) and allows interviews to be conducted in an orderly manner. Boxes are set up in an order of priority and allocated to the accredited media. The riders pass from one box to the next (either immediately after exiting the track or after the podium ceremony) and give interviews.

N NEUTRAL START

This is a type of start normally used in bunch races. The riders line up on the home straight. The starter blows a whistle to indicate the start of a neutral lap. During this lap the riders should all be riding together as a single bunch at a moderate pace. At the end of the lap, if the riders are grouped together, the race is started. If the riders are not grouped together, additional neutral laps are ridden until the riders are in a single group, at which point the start is given.

O ORGANISER

The organiser of a cycle competition bears responsibility in administrative, financial and legal terms. The organiser must be licensed as such by the national federation of the country in which the competition is to take place. The organiser is solely liable for the quality and safety of the organisation and all installations.

P PADS

Pads are used to make the Blue Band unrideable in timed distance events (other than the Team Sprint). They are usually made of foam and are 50 cm long and 10 cm wide and high. They are placed every 5 m around the length of the track on the inside edge of the Blue Band.

PERMANENCE

See Race Headquarters

PHOTO-FINISH

The use of photo-finish equipment is essential at all international-level competitions. This equipment allows the riders to be separated as they cross the finish line and also calculates times.

PODIUM CEREMONY

Certain riders are obliged to attend the podium ceremony after each event (normally the top three). The organiser specifies in the competition's special regulations which riders should attend the podium ceremony and at what time.

PRESIDENT OF THE COMMISSAIRES' PANEL (PCP)

For competitions that are registered on the UCI international calendar, the PCP is an international Commissaire appointed by the UCI. The PCP has several tasks to be conducted before, during and after the competition. The PCP ensures the sporting management of the competition in coordination with the organiser. The PCP also coordinates the Commissaires' Panel. All decisions made by the Commissaires' Panel must be approved by the PCP or by the PCP's delegate.

PRESS ROOM

A press room must be available at the velodrome from the day before the competition. This room is used for the accreditation of journalists and offers work spaces with electrical sockets and Internet connections. This room may also be a cordoned off section of the infield.

PURSUIT LINE

The two Pursuit Lines are 4 cm wide red lines painted vertically across half the track, starting from the Blue Band. They are at the precise midpoint of each straight and are exactly in line with each other.

R RACE

This is any single heat or round of an event with one start and one finish.

RACE HEADQUARTERS

The headquarters desk is open from approximately two hours before the competition until the Commissaires have completed their work after the final event has finished. A member of the organisation personnel is on duty throughout this time. The race headquarters must be equipped with a telephone line, fax, computer and Internet access. The headquarters desk issues the accreditation for all individuals involved in the competition. For some of the major competitions this desk may be required to be open from one or more days prior to the start of the competition. The opening hours must be published in the competition technical guide.

RELEGATION

A decision made by the Commissaires' Panel to change the ranking of a rider to a lower position. In any one event a rider can have a maximum of three relegations, at which point he or she is disqualified.

ROUND

The round is a phase in an event where all the competitors who entered the event, or who are remaining in the event, compete, in different races, to decide who progresses further into the event and who is eliminated. Examples are the quarter-final and semi-final rounds.

S SAFETY ZONE

The Safety Zone is a marked area on the inside of the Blue Band with a defined minimum width. It runs the entire length of the track. During racing, no equipment is permitted on the Safety Zone. Only certain individuals are allowed on the Safety Zone and Commissaires always have the right to remove people from this area.

SCORING

In a bunch race this means taking note of the changing race situation, including laps lost and gained, points scored, riders off the front and back, head of the race and location of the bunch.

SECRETARIAT

The Secretariat is an area normally located near the Finish Line on the inside of the track with access restricted primarily to the Commissaires and the Timing Company. It is where the administrative and secretarial functions of the sporting part of the competition take place.

SECRETARY

The Secretary is a member of the Commissaires' Panel primarily tasked with managing all the administrative and information components of the sporting aspect of the competition.

SESSION

A competition may be made up of one or more sessions. The session has a defined start and end time and consists of a number of separate events. There is always a break between sessions when no racing takes place. Many major competitions typically have two sessions a day, the first running from mid-morning to early afternoon and the second in the evening.

SPEAKER

The Speaker is an organisational function. The primary role of this person is to relay sporting control information.

SPECIAL REGULATIONS

The organiser should draw up any special regulations for the competition concerning sporting matters. The special regulations must be included in the competition's technical guide.

SPECIALTY

A specialty is one of the event types that makes up track cycling. Some examples of specialties are: Sprint, Keirin, Points Race, Madison.

SPRINTER'S LANE

The Sprinter's Lane is the area on the track between the Measuring Line and the Sprinter's Line, including both these lines. It is also sometimes known as the Sprinter's Corridor or Pole Lane.

SPRINTER'S LINE

The Sprinter's Line is a 5 cm wide line, usually red, painted around the track. Its inside edge is 85 cm from the inside edge of the track.

STANDING START

This is a type of start used in Pursuit and most time trial events. The rider is held stationary until the start is given. As soon as the start is signalled, the rider is released and the event timing commences. In most competitions, the rider is held by a starting gate for this type of start.

STARTING GATE

A starting gate is a mechanical apparatus used to hold a rider stationary for standing start events. The back wheel of the bicycle is usually held firmly until the start is given, at which point the gate releases the wheel and the rider can go.

START LINE

The start line is any point, marked or unmarked, on the track where the race distance commences. The most commonly used start lines are the 200 m Line, Pursuit Line and Finish Line.

STARTER

The Starter is a member of the Commissaires' Panel who is responsible for starting every race. The Starter alone decides whether the start was conducted properly and can stop the race if the start is deemed incorrect. In some events, the Starter also has the authority to stop the race if the rider conduct does not meet sporting requirements.

STAYER'S LINE

The Stayer's Line is a 5 cm wide blue line painted around the track at one third of the total width of the track measured from the inside edge of the Blue Band. As a minimum, it must be 2.45 m from the inside edge of this Blue Band.

STRAIGHT, BACK

This is the part of the track between corners two and three.

STRAIGHT, HOME

This is the part of the track between corners four and one. The Finish Line is always located on the Home Straight. The main spectator area is also normally located along this straight.

T TEAM MANAGER

An individual with a team manager's licence who bears responsibility for the team to the Commissaires. The team manager represents the riders in dealings with the Commissaires' Panel and is also held accountable for the conduct of the team.

TECHNICAL DELEGATE

A Technical Delegate (TD) is appointed to major competitions by the UCI. The TD is responsible for representing the UCI and supervising all the sports-related and technical aspects of competitions. The TD does not perform a Commissaire role and is not involved in decision making as regards the sporting control of the competition.

TECHNICAL GUIDE

The technical guide is the reference document for Commissaires, teams, riders and all others involved in the competition. The technical guide contains all essential information concerning the competition and is drafted in French or English as a minimum and optionally in other languages.

TIE

A tie occurs when two or more riders are given the same ranking in the classification (i.e. it is not possible to use an event regulation to separate their ranking).

TIMEKEEPER

The Timekeeper is a member of the Commissaires' Panel who records the times of each race on a form. This is signed and handed to the Finish Judge.

TRACK DIRECTOR

The Track Director is an organisation function who is responsible for ensuring the track remains usable throughout the entire competition and that all required equipment and organisational personnel are available to support the competition.

TRANSPONDERS

This system identifies riders passing over a line and should be used to obtain a snapshot of the race at a specific point. It does not replace the obligatory use of photo-finish equipment. Transponders must be attached to the bicycle at a consistent distance from the tangent of the front wheel. They must not be carried on the rider's body.

TURNS

See Bankings

U UCI ID

A unique 11-digit number issued to UCI licence holders.

W WARNING

A decision made by the Commissaires' Panel and issued to a rider for irregular or prohibited sporting conduct. The warning must be announced by the Speaker and recorded in a communiqué. A rider receiving a second warning in the same event is disqualified from that event.

15.2.3.
COMMISSAIRE TASK GRID

| 2017/18 Track World Cup -- Manchester, UK (v1.0 - 20170926) | | | | | | | | | | | |
|---|-----------------------------|--------------------|--------------------|--------------------|--------------------|---|--------------------|--------------------|--------------------|--------------------|--------------------|
| Position | Team Sprint | Flying 200 | Sprint | Keirin | 1km/500m | Team Pursuit | Points | Tempo | Elimination | Scratch | Madison |
| President Commissaire | Wayne Pomario | Wayne Pomario | Wayne Pomario | Wayne Pomario | Wayne Pomario | Wayne Pomario | Wayne Pomario | Wayne Pomario | Wayne Pomario | Wayne Pomario | Wayne Pomario |
| Starter | Jerome Lappartient | Jerome Lappartient | Jerome Lappartient | Jerome Lappartient | Jerome Lappartient | Jerome Lappartient | Jerome Lappartient | Jerome Lappartient | Jerome Lappartient | Jerome Lappartient | Jerome Lappartient |
| Assistant Starter | Willi Tarran | Willi Tarran | Willi Tarran | Willi Tarran | Willi Tarran | Willi Tarran | Willi Tarran | Willi Tarran | Willi Tarran | Willi Tarran | Willi Tarran |
| Judge Referee | | Andreas Gensheimer | Andreas Gensheimer | Andreas Gensheimer | | | Andreas Gensheimer | Andreas Gensheimer | Andreas Gensheimer | Andreas Gensheimer | Andreas Gensheimer |
| Secretary | Elita Grasina | Elita Grasina | Elita Grasina | Elita Grasina | Elita Grasina | Elita Grasina | Elita Grasina | Elita Grasina | Elita Grasina | Elita Grasina | Elita Grasina |
| Asst. Secretary | Gisela Bradbury | Gisela Bradbury | Gisela Bradbury | Gisela Bradbury | Gisela Bradbury | Gisela Bradbury | Gisela Bradbury | Gisela Bradbury | Gisela Bradbury | Gisela Bradbury | Gisela Bradbury |
| Chief Judge | | | Phil Pollard | Phil Pollard | | | Phil Pollard | Phil Pollard | Phil Pollard | Phil Pollard | Phil Pollard |
| Assistant Judges | | | Alan Sanders & TBC | Alan Sanders & TBC | | | Alan Sanders | Alan Sanders | | Alan Sanders & TBC | Alan Sanders |
| Points Tally Sheet | | | | | | | TBC (was Trevor J) | TBC (was Trevor J) | | | TBC (was Trevor J) |
| Scorer (laps up/down) | | | | | | | Trevor Reade | Trevor Reade | | Trevor Reade | Trevor Reade |
| Timekeeper (Frontstraight) | Lesley Donington | Lesley Donington | Lesley Donington | Lesley Donington | Lesley Donington | Lesley Donington | Lesley Donington | Lesley Donington | Lesley Donington | Lesley Donington | Lesley Donington |
| Timekeeper (Backstraight) | Liz Dodson | Liz Dodson | Liz Dodson | Liz Dodson | Liz Dodson | Liz Dodson | Liz Dodson | Liz Dodson | Liz Dodson | Liz Dodson | Liz Dodson |
| Corner 1 | Kathy Gilchrist | Neil Lawford | Neil Lawford | Neil Lawford | Neil Lawford | Kathy Gilchrist | Neil Lawford | Neil Lawford | Neil Lawford | Neil Lawford | Neil Lawford |
| Corner 2 | | Kathy Gilchrist | Kathy Gilchrist | Kathy Gilchrist | Kathy Gilchrist | | Kathy Gilchrist | Kathy Gilchrist | Kathy Gilchrist | Kathy Gilchrist | Kathy Gilchrist |
| Backstraight | Tim Ward | | Tim Ward | Tim Ward | Tim Ward | Tim Ward | Tim Ward | Tim Ward | Tim Ward | Tim Ward | Tim Ward |
| Pit | | | | | | | Tim Ward | Tim Ward | Tim Ward | Tim Ward | Tim Ward |
| Corner 3 | Julia Gilbert | Julia Gilbert | Julia Gilbert | Julia Gilbert | Julia Gilbert | Julia Gilbert | Julia Gilbert | Julia Gilbert | Julia Gilbert | Julia Gilbert | Julia Gilbert |
| Corner 4 | | Alan Sheldon | Alan Sheldon | Alan Sheldon | Alan Sheldon | | Alan Sheldon | Alan Sheldon | Alan Sheldon | Alan Sheldon | Alan Sheldon |
| Equipment Lead | Julie Rodman | Julie Rodman | Julie Rodman | Julie Rodman | Julie Rodman | Julie Rodman | Julie Rodman | Julie Rodman | Julie Rodman | Julie Rodman | Julie Rodman |
| Bike Measurement (Frontstraight) | Patrick Nestor | Patrick Nestor | Patrick Nestor | Patrick Nestor | Patrick Nestor | Patrick Nestor | Patrick Nestor | Patrick Nestor | Patrick Nestor | Patrick Nestor | Patrick Nestor |
| Bike Measurement (Backstraight) | Paul Mullan | Paul Mullan | Paul Mullan | Paul Mullan | Paul Mullan | Paul Mullan | Paul Mullan | Paul Mullan | Paul Mullan | Paul Mullan | Paul Mullan |
| Laps & Bell (Frontstraight) | Peter Deary | Peter Deary | Peter Deary | Peter Deary | Peter Deary | Peter Deary | Peter Deary | Peter Deary | Peter Deary | Peter Deary | Peter Deary |
| Laps & Bell (Backstraight) | Alan Sanders | | | | Alan Sanders | Alan Sanders | | | | | |
| Frontstraight Flag | Phil Pollard | | | | Phil Pollard | Phil Pollard | | | | | |
| Backstraight Flag | Tim Ward | | | | Tim Ward | Tim Ward | | | | | |
| Holders (Frontstraight) | Alan Sheldon & Trevor Reade | | | | | Patrick Nestor, Alan Sheldon & Trevor Reade | | | | | |
| Holders (Backstraight) | TBC & Neil Lawford | | | | | Paul Mullan, TBC & Neil Lawford | | | | | |
| Protocol | Willi Tarran | Willi Tarran | Willi Tarran | Willi Tarran | Willi Tarran | Willi Tarran | Willi Tarran | Willi Tarran | Willi Tarran | Willi Tarran | Willi Tarran |

15.2.4.
TRACK PENALTIES SUMMARY

|  TRACK - PENALTIES LIST / PISTE - TABLEAU DES SANCTIONS | | | |
|---|---|---|---|
| A | B | C | D |
| WARNING AVERTISSEMENT ADVERTENCIA | FINE AMENDE MULTA | RELEGATION DECLASSEMENT DESCLASIFICACION | DISQUALIFICATION DISQUALIFICATION EXPULSION |
| MOVEMENTS OF RIDERS ON THE TRACK EVOLUTION DES COUREURS SUR LA PISTE EVOLUCION DE LOS CORREDORES EN PISTA | | | |
| 1 | for not holding his/her line during the final sprint pour avoir quitté sa ligne pendant le sprint final por desviarse de su línea durante el sprint final | 9 | for moving down towards the inside of the track when a rival was already there pour s'être rabattu vers l'intérieur alors que son concurrent s'y trouvait déjà por movimiento brusco hacia el interior donde se encontraba su oponente |
| 2 | for riding on the blue band during the sprint pour avoir roulé sur la côte d'azur lors du sprint por pasar por la zona azul durante el sprint | 10 | for moving down towards the inside of the track and forcing the other competitor off the track pour s'être rabattu à la corde obligeant ainsi son adversaire à sortir de la piste por desplazamiento hacia el interior forzando a su adversario a salir de la pista |
| 3 | for deliberately riding on the blue band during the race pour passage volontaire sur la côte d'azur au cours de l'épreuve por pasar de forma intencionada por la zona azul en el transcurso de la prueba | 11 | for crowding his/her opponent with the intention of causing him to slow down pour avoir tassé l'adversaire dans le but de le faire ralentir por presionar cerrando al adversario para obligarle a disminuir su marcha |
| 4 | for not having held his/her line during the last 200 meters of the race pour ne pas avoir tenu sa ligne dans les 200 derniers mètres de l'épreuve por no mantener su línea en los últimos 200 metros de la prueba | 12 | for moving outward with the intention of forcing the opponent to go up pour avoir dévié de sa trajectoire et conduit son adversaire vers l'extérieur de la piste por presionar cerrando al adversario para obligarle a subir hacia el exterior |
| 5 | for irregular movement to prevent his opponent from passing pour manœuvre illicite, faite pour empêcher son adversaire de passer por maniobra irregular para impedir el paso de su oponente | 13 | for going down too quickly after overtaking his/her opponent pour s'être rabattu trop rapidement après avoir dépassé son adversaire por descender demasiado rápido y cerrar a su adversario después de adelantarle |
| 6 | for dangerous riding in the final bend pour manœuvre dangereuse dans le dernier virage por maniobra peligrosa en la última curva | 14 | for deliberate and flagrant fault against ... pour faute flagrante et volontaire contre ... por acción flagrante y voluntaria en contra de |
| 7 | for dangerous riding during the race pour manœuvre dangereuse au cours de l'épreuve por movimientos peligrosos durante la prueba | 15 | for causing the crash of his/her opponent pour avoir provoqué la chute de son adversaire por provocar la caída de su adversario |
| 8 | for entering the sprinter's lane when the opponent was already there pour être entré dans le couloir des sprinters alors que son adversaire s'y trouvait déjà por entrar en el pasillo de sprinters cuando estaba ocupado por su adversario | 16 | for having blocked an opponent pour avoir gêné son adversaire por acciones de bloqueo sobre su oponente |
| | | 21 | for pushing his/her rival pour avoir poussé son adversaire por empujar sobre su oponente |

|  TRACK - PENALTIES LIST / PISTE - TABLEAU DES SANCTIONS | | | |
|---|---|---|---|
| A | B | C | D |
| WARNING AVERTISSEMENT ADVERTENCIA | FINE AMENDE MULTA | RELEGATION DECLASSEMENT DESCLASIFICACION | DISQUALIFICATION DISQUALIFICATION EXPULSION |
| 17 | for being late at the start line pour retard au départ por presentarse con retraso a la línea de salida | 22 | for improper attire/advertising during the protocol ceremony pour vêtement/publicité non conforme lors de la cérémonie protocolaire por usar vestimentas/publicidad contraria a la ceremonia de protocolo |
| 19 | for incorrect gestures pour geste incorrect por realizar gestos incorrectos | 25 | for improper advertising on national jersey or short pour publicité non conforme sur le maillot / cuissard / équipement por publicidad no autorizada en la vestimenta |
| 20 | for incorrect behaviour pour comportement incorrect por comportamiento incorrecto | | SPARE MATERIAL MATERIEL DE RECHANGE MATERIAL DE RICAMBIO |
| 23 | for incorrect behaviour or disrespect towards an official pour comportement incorrect envers un commissaire por comportamiento incorrecto hacia un comisario | 29 | for not being ready with extra wheels or other equipment at the start pour insuffisance de matériel de rechange au départ por no estar preparado con material de ricambio |
| 27 | for protest with hands off handlebar pour avoir levé la main en guise de protestation por realizar gestos de protesta levantando las manos del manillar | | INTERVENTION OF STAFF INTERVENTION DE L'ENCADREMENT INTERVENCION DE LOS ENTRENADORES |
| 30 | for ingoring commissaires instructions to leave track after being overlapped pour avoir ignoré les instructions des commissaires de quitter la piste après avoir été rejoint par son adversaire por haber ignorado las instrucciones de los comisarios de salirse de la pista después de haber sido alcanzado por su adve | 28 | for using two persons to give information to the team / rider pour avoir utilisé deux personnes pour informer son équipe / coureur por utilizar dos personas para informar a su equipo / corredor |
| 31 | for failure to obey commissaires instructions pour avoir ignoré les instructions des commissaires por haber ignorado las instrucciones de los comisarios | | ABSENCES ABSENCES AUSENCIA |
| 32 | for failing to maintain proper control of the bicycle pour ne pas être arrivé à maintenir le contrôle du vélo por no haber conseguido mantener la bicicleta bajo control | 26 | qualified to ... but did not start without justification qualifié pour les ... et absent au départ sans justification clasificado para ... y ausente sin justificación |
| 33 | for taking off their helmet when on the track after passing the finish line pour avoir enlevé son casque sur la piste après avoir franchi la ligne d'arrivée por haberse quitado el casco después de cruzar la meta | | RACE NUMBER DOSSARD DORSAL |
| 34 | for incorrect behaviour behind dery pour comportement incorrect derrière le dery por comportamiento incorrecto detrás del dery | 18 | for wearing only one number pour avoir porté un seul dossard por llevar un sólo dorsal |
| | | 24 | for folding or mutilating the race number pour avoir plié ou modifié son dossard por llevar el dorsal doblado o modificado |

15.2.5.
STARTER REGULATION SUMMARY EXAMPLE

| Track Event Starter's Guide - World Cup & World Championships | | | | | | | | |
|---|---|---|---|---|---|---|--|--|
| Event | 500m / Kilo | Flying 200M | Team Sprint Qualifying | Team Sprint Finals | Individual Pursuit Qualifying | Individual Pursuit Final | Team Pursuit Qualifying | Team Pursuit Final |
| Special Rules | | Sprint bike | 3 laps with 3 riders Men 2 laps with 2 riders Women | | 4km = Elite Men (16 laps) 3km = Elite Women (12 laps) | | Final time is on front wheel 3 rd rider ½ lap times are on the 3 rd rider M & W =4km. Must have 4 riders to start | |
| Seeding | For CDM and WC, by UCI. | For CDM and WC, by UCI. | For CDM and WC, by UCI. Pairs -- In final, highest seed on Homestraight | | For CDM and WC, by UCI. Pairs, fastest last w/o matching presumed best. In final, highest seed finishes on Homestraight | | For CDM and WC, by UCI. Qualifying is run one team at a time with highest seed last. | |
| # To Qualify for Championship | Ridden as a Final | Top 24 | Top 4 to Finals | 3 vs. 4 1 vs. 2 | Top 4 to Finals | 3 vs. 4 1 vs. 2 | Top 8 to Finals | 7 vs 8 3 vs 4 5 vs 6 1 vs 2 |
| Start | 2-ups World Cup. Riders alone for World Champs. Held by starting gate. 50 sec countdown when both bikes are in the gates. | 3.5 laps Rider starts immediately after previous rider passes starter on timed 200m. | Line up vertically along the pursuit line 1.5m gaps. Lead rider held by starting gate. 50 sec countdown. Line up along the pursuit line 1.5m gaps. Lead rider held by starting gate. 50 sec countdown. | | Held by starting gate. 50 sec countdown begins when both riders bikes are secured in the start gates. | | Riders line up with 1m between them vertically along the pursuit line. Lead rider held by starting gate. 50 sec countdown begins when both team's leading rider's bikes are secured in the start gates. | |
| False Start | Called immediately | | Anticipating the start or leading (bottom) rider fails to take the lead | Anticipating the start or leading (bottom) rider fails to take the lead | Called immediately | | False Start by anticipating the start or leading (bottom) rider fails to take the lead | |
| Action: | Double Gunshot; & restart immediately. | | Double Gunshot; & restart immediately. | Double Gunshot; & restart immediately. | Double Gunshot; & restart immediately. | | Double Gunshot; & restart immediately. | |
| Mishap | Restart after approx. 15 min | Allowed to restart | Any mishap = restart at end of round. | Finals: Any mishap = stop w/ double gunshot & restart. | Any. 1 st ½ lap: double gunshot & immediate restart. ----- Between ½ lap & final km = restart positions based upon last half-lap times. ----- Any. After 1 st ½ lap: do NOT stop, rider will restart at end of round. Max. 2 starts. | Any. 1 st ½ lap: double gunshot & immediate restart. ----- Between ½ lap & final km = restart positions based upon last half-lap times. ----- Final km = Race is stopped & use last ½ lap times decide winner. Max. 2 starts. | ½ lap: any = double gunshot & immediate restart ----- After ½ lap: any = team decides within 1 lap to continue or stop Team will restart at end of round Max. 2 starts/team. | Any. 1 st ½ lap: double gunshot & immediate restart. ----- For First Round & Finals: After ½ lap: = no mishap is taken into consideration – team MUST continue if they have 3 riders, otherwise race is over. Max. 2 starts/team. |
| Re-rides | Max. 2 starts. | Max. 2 starts. | Max. 2 starts/team. | Max. 2 starts/team. | | | | |
| Catch | No action | | | | Must finish for time | Single gunshot at catch (leading rider may continue for time at their discretion) | N/A | Single gunshot at catch (leading team may continue for time at their discretion) |
| End of Race | | | | | Gunshot at each finish | | Gunshot at each finish | |
| Time Ties | Riders placed equally | Last 100 m time then draw lots | Faster final lap time | Faster final lap time | Faster final lap time | | Faster final lap time | 1 |

15.2.6 KEIRIN DERNY PACE GUIDELINES

250 M

Derny Pace Guidelines (250 m Track) - Distance 750 m

| 0 | 1/2 Laps | Distance | Speed (km/h) | | 1/2 lap time (in s) | Total time (in s) | E1 | E2 | E3 | E4 | E5 | E6 |
|---------|----------|----------|--------------|--|---------------------|-------------------|----|----|----|----|----|----|
| | S | 0 | 30 | | 0 | 0 | | | | | | |
| 1/2 lap | 1 | 125 | 33,33 | | 14,2 | 14,2 | | | | | | |
| 1/2 lap | 2 | 250 | 36,66 | | 12,9 | 27,1 | | | | | | |
| 1/2 lap | 3 | 375 | 40 | | 11,7 | 38,8 | | | | | | |
| 1/2 lap | 4 | 500 | 43,33 | | 10,8 | 49,6 | | | | | | |
| 1/2 lap | 5 | 625 | 46,66 | | 10,0 | 59,6 | | | | | | |
| 1/2 lap | 6 | 750 | 50 | | 9,3 | 68,9 | | | | | | |

| Speed | Time per lap |
|-------|--------------|
| 30 | 30 |
| 40 | 22,5 |
| 50 | 18 |

200 M

Derny Pace Guidelines (200 m Track) - Distance 700 m

| 0 | 1/2 Laps | Distance | Speed (km/h) | | 1/2 lap time (in s) | Total time (in s) | E1 | E2 | E3 | E4 | E5 | E6 |
|---------|----------|----------|--------------|--|---------------------|-------------------|----|----|----|----|----|----|
| | S | 0 | 30 | | 0 | 0 | | | | | | |
| 1/2 lap | 1 | 100 | 32,9 | | 11,5 | 11,5 | | | | | | |
| 1/2 lap | 2 | 200 | 35,7 | | 10,5 | 22,0 | | | | | | |
| 1/2 lap | 3 | 300 | 38,6 | | 9,7 | 31,6 | | | | | | |
| 1/2 lap | 4 | 400 | 41,4 | | 9,0 | 40,6 | | | | | | |
| 1/2 lap | 5 | 500 | 44,3 | | 8,4 | 49,0 | | | | | | |
| 1/2 lap | 6 | 600 | 47,1 | | 7,9 | 56,9 | | | | | | |
| 1/2 lap | 7 | 700 | 50 | | 7,4 | 64,3 | | | | | | |

| Speed | Time per lap |
|-------|--------------|
| 30 | 24 |
| 40 | 18 |
| 50 | 14,4 |

Average acceleration/half lap (km/h) : 2,9

15.3. SUBMITTING DOCUMENT FEEDBACK

This guide undergoes periodic review and maintenance, with separate updates published frequently, and more complete document version updates completed according to a planned schedule.

If any errors were identified, or there are any suggestions for changes or addition to the content, these should be sent to the Commissaires' Unit using the following link:

<https://www.surveymonkey.com/r/KXGT39F>

DOCUMENT CHANGE CONTROL

| VERSION NUMBER | DATE | REVISION AUTHOR | DESCRIPTION |
|----------------|-------------------|---------------------------------|--|
| 1 | 8 January 2017 | Wayne Pomario | Initial draft created. |
| 2 | 1 February 2017 | Wayne Pomario | Initial draft review completed and reviewed by Alexander Donike. Feedback implemented and document reviewed for consistency. |
| 2.1 | 13 February 2017 | Wayne Pomario | Chapters 1 and 2 edited and added to the document. |
| 3 | 22 June 2017 | Wayne Pomario | Incorporated feedback from Andrius, Gilles and David (editor). |
| 3.1 | 23 June 2017 | Wayne Pomario | Incorporated sections from the road guide. |
| 3.2 | 26 June 2017 | Wayne Pomario | Updated table for age categories. |
| 3.3 | 27 June 2017 | Benjamin Sapin | Updated Layout Table of contents (sections 12 -13 -14). |
| 3.4 | 30 August 2017 | Benjamin Sapin | Updated 5.1.2.2 section 9 and Miscellaneous |
| 3.5 | 25 September 2017 | Wayne Pomario | Made a few changes based on Word document feedback. Note that not all suggested changes were accepted |
| 3.6 | 17 February 2018 | Wayne Pomario | Updated the Individual Pursuit component to reflect new rules issued in March. |
| 4.0 | 26 November 2018 | Wayne Pomario | Major edit, including all new regulations up to March 2019. |
| 4.1 | 21 December 2018 | Wayne Pomario | Updating all photos as per Benjamin Sapin and Andrei Krasilnikau. Including feedback from Monia Turin. |
| 4.2 | 12 March 2019 | Wayne Pomario Benjamin Sapin | Updated following changes made by graphical designer. |



Union Cycliste Internationale

Ch. de la Mêlée 12
CH – 1860 Aigle
Switzerland
Email: uci@uci.ch