

Prosthetics

Lower limbs



Quality for life

Prosthetics



Table of contents

1 | Leg prostheses for children

Prosthetic feet.....	22
Adapters	29
Knee joints.....	34
Hip joint.....	38
Prosthesis covers.....	39
Cosmetic stockings.....	40

2 | Initial and interim prostheses 44

3 | Waterproof walking aids

Prosthetic feet.....	56
Adapters.....	58
Socket technologies.....	64
Knee joints	71

4 | Sports prostheses

Prosthetic feet, adapters and knee joints.....	76
--	----

5 | Prosthetic feet

Article no. structure.....	96
Mobility grade 1.....	97
Mobility grade 1–2.....	103
Mobility grade 2–3.....	128
Mobility grade 3–4.....	148
Pylon feet.....	187
Feet for a limited build height.....	192
Silicone prostheses.....	198
General accessories.....	201
Exoskeletal design.....	202

6 | Adapters

Tube adapters and tube clamp adapters 30 mm.....	212
Tube adapters and tube clamp adapters 34 mm.....	220
Double and sliding adapters.....	226
Lamination anchor.....	238
Socket adapter.....	247
Socket attachment blocks.....	252
Modular adapter kits.....	255
Functional adapters.....	260

7 | Knee joints

Mobility grade 1.....	277
Mobility grade 1–2.....	286
Mobility grade 2–3.....	300
Mobility grade 3–4.....	310
Kenevo.....	320
C-Leg.....	326
Genium.....	334
Genium X3.....	342

8 | Hip joints

Modular hip joints.....	350
Monocentric hip joints.....	351
Helix3D hip joint system.....	352

9 | Socket technologies

Skeo Liner.....	360
Caleo liner.....	375
Uneo liner.....	381
Accessories.....	392
Derma functional accessories.....	393
Vacuum socket systems	
Valves.....	395
Pumps	
– Dynamic Vacuum System.....	403
– Pumps – Harmony system.....	407
Socket sealing and harnesses.....	418
Shuttle lock systems and lanyard systems	
– Shuttle locks.....	424
– Lanyard systems.....	432
Residual limb socks for volume management.....	435
Volume management spots.....	442
Compression therapy.....	443
Accessories/spare parts for socket technology in general.....	447
Sockets.....	448

10 | Prosthesis covers

Overview of prosthesis cover combinations.....	470
Functional cosmesis.....	471
Foam covers.....	476
Custom silicone covers.....	482
Aesthetic finishing.....	485
Cosmetic stockings.....	486
Protective covers.....	490
Accessories for modular leg prostheses.....	498



"Our objective is to offer maximum mobility, independence and normality to people with physical disabilities. This means all our products have to be judged by the functionality they offer users."

Prof. Hans Georg Näder,
Chairperson of the Management Board,
Ottobock SE & Co. KGaA

A changing company

Ottobock develops medical technology products and high-quality treatment concepts for people with limited mobility. Driven by a decisive, pioneering spirit, prosthetist Otto Bock founded the Orthopädische Industrie GmbH company in Berlin in 1919. He had the courage to break new ground and set higher standards that would ultimately revolutionise an entire industry. Under the leadership of his son-in-law, Dr Max Näder, Ottobock continued to grow and succeed. With creativity and inventive talent, he set standards in orthopaedic technology with the development of products such as the modular leg prosthesis solution and the myoelectric upper limb prosthesis. The company began to establish an international network in 1958, when the first foreign branch was founded in the USA. Professor Hans Georg Näder has pursued a consistent, dynamic approach to continue driving this growth, with the result that Ottobock is now a technology and innovation leader. In all aspects of our business, people are always our number one priority: we are committed to helping everyone achieve maximum mobility, independence and quality of life.

Ottobock SE & Co. KGaA is simultaneously a family business and a modern, customer and success-oriented company. A network of sales and service companies in 59 countries ensures proximity to customers and users. This helps us understand user needs and customer requirements and integrate these aspects into the products we develop. With the business areas of Prosthetics, Orthotics, Human Mobility (wheelchairs and rehabilitation devices), Patient Care and Industrials, the broad-based company is capable of offering its customers a nearly unparalleled range of products, coordinated solutions and extensive services.

We take responsibility for improving the quality of life of people with disabilities by creating solutions that are functionally and technologically outstanding – both now and into the future. The role played by high-quality materials is just as essential as expert craftsmanship when it comes to providing treatment for people with physical limitations. Only the treatment team that attends to the patient personally can determine the overall needs and establish the requirements for a custom leg prosthesis on this basis. To help you obtain the best possible treatment result for your patients, you will find appropriate components in the following sections, meeting the various needs of your patients.

Always at your service!

At Ottobock, we place great emphasis on CUSTOMER SERVICE. Our highly experienced representatives are standing by – ready to assist you with their comprehensive expertise, inform you about the latest developments and advise you on every aspect of our products. If you have a complex enquiry, our product experts and specialists from Fabrication will be delighted to help you. Our highly qualified sales team can assist with special technical solutions and their on-site implementation. We also offer end-to-end service plans.

About this catalogue

Searching, finding and ordering

This catalogue is organised into sections.

Tabs on the right-hand page margins as well as the subtitles at the top of every page also serve as quick and easy reference guides.

The list of keywords lists all products in alphabetical order. Alternatively, the index lets you find the page numbers for products by reference number.

1	204	332	2588	304
143-2	205	308	2605	40
1430	130	320	2222	62
1431	110	106, 111, 114, 120	2605	24
181-2	144	100, 120	2295	59
1820	136	200-040	109, 115, 119, 121	24
1821	136	2011	125	197
1822	136	2012	125	197
1823	136	2013	125	197
1824	136	2014	125	197
1825	136	2015	125	197
1826	136	2016	125	197
1827	136	2017	125	197
1828	136	2018	125	197
1829	136	2019	125	197
1830	136	2020	125	197
1831	136	2021	125	197
1832	136	2022	125	197
1833	136	2023	125	197
1834	136	2024	125	197
1835	136	2025	125	197
1836	136	2026	125	197
1837	136	2027	125	197
1838	136	2028	125	197
1839	136	2029	125	197
1840	136	2030	125	197
1841	136	2031	125	197
1842	136	2032	125	197
1843	136	2033	125	197
1844	136	2034	125	197
1845	136	2035	125	197
1846	136	2036	125	197
1847	136	2037	125	197
1848	136	2038	125	197
1849	136	2039	125	197
1850	136	2040	125	197



iFab Customer Center
 You can find the entire digital portfolio of custom products in the iFab Customer Center. The platform guides you through the ordering process quickly and easily. You can reach the iFab Customer Center at: www.iFab-customer-center.com.

Additional catalogues

646K71 Service Fabrication
 As part of the digital transformation, Ottobock iFab offers custom products and services in the fields of orthotics and prosthetics; please see the 646K71 catalogue.

646K1 Materials
 For more information or to place orders for products in the materials and tools category, please use the 646K1 Ottobock materials catalogue.

About this catalogue

Name of product

Illustration of product

Available information material

Scope of delivery

Triton side flex

Reference number 1C68



The 1C68 Triton side flex was developed for highly active users, it is the most prosthetic foot to provide such extraordinary lateral adaptability and adjusts to the current situation immediately.

Key features

- Unique lateral adaptability of +/- 10° for immediate and full-surface ground contact while walking and standing, also on uneven surfaces and slopes
- Enhanced feeling of safety and improved socket comfort
- The linear spring design provides the level of support in the stance phase that is needed for activities where rapid responses are essential
- Customisable shock absorption with two different heel wedge options
- Robust, maintenance-free technology
- Low build height
- Waterproof and corrosion-resistant
- Slim footshell option

Information material

647 GS 088-ALL_INT	IFU Triton side flex
--------------------	----------------------

Scope of delivery

SC05	Triton side flex	1	Piece
SC6	Footshell	1	Piece
2C15	CONNECTION WITH normal footshell cover	1	PIECE
SC50	Connection cover with slim footshell	1	PIECE
2PEU	Heel wedge for Triton	1	Set
SL-SPEL (HA-SOCK)	SPECIAL SOCKS	1	PIECE

Technical data

Max. body weight	max. 105 kg
Side	left (L), right (R)
Size	22-30 cm
Weight without socket**	229 g
Shape of footshell	Slim shape (S) for a heel height of 15 +/- 5 mm (29.57 cm) Normal shape (N) for a heel height of 10 +/- 5 mm (24.90 cm)
Colour of footshell	beige (4), light brown (15)
Weight with normal footshell*	200 g
System height with normal footshell*	68 mm
Build height with normal footshell*	60 mm

Stiffness chart*

Foot size	22CM	23CM	24CM	25CM	26CM	27CM	28CM	29CM	30CM
Body weights									
up to 65 kg	1	1	1	1	1	2	2	2	2
65-75 kg	2	2	2	2	2	3	3	3	3
75-90 kg	3	3	3	3	3	4	4	4	4
90-120 kg	4	4	4	4	4	5	5	5	5

Order example

Reference number	Side	Size	Softness	D / Eriner	Shape
1C00	L	26	3	P / 4	N

Brief product description

Icons and symbols as orientation aids

Technical data for the product

Selection and stiffness tables

Order example

Order code

Select the desired product and determine the article number if applicable. It consists of the reference number plus additional parameters such as the side of the body, size, colour or shape. In addition, the order samples on the respective catalogue pages show how the article number can be determined quickly and easily.

Example:

Order example

Reference number	= Side	Size	/ Colour	Shape
2C6	= L	26	/ 4	N

Technical data

Reference number	2C15=*N	2C15=*S
Side	left (L), right (R)	left (L), right (R)
Shape	normal shape (N)	slim shape (S)
Size	22-30 cm	22-25 cm
Weight	229 g*	184 g**
Heel height	10 +/- 5 mm	15 +/- 5 mm
Colour	beige (4), light brown (15)	beige (4), light brown (15)
	* Technical data refer to the size of 26 cm	** Technical data refer to the size of 25 cm

* Technical data refer to the size of 26 cm

System height – the Ottobock measurement

Ottobock has defined an auxiliary measurement that helps you fill the available space between the end of the socket and floor with appropriate prosthetic components – the system height. Every prosthetic component has a system height.

Adding the individual values quickly and easily gives you the build height of the components you have chosen.

The values determined by Ottobock take into account the fact that the pyramid and pyramid receiver interlock in modular prosthesis construction. You will find the values in table form in the catalogue below the respective product.

The principle is explained to you below with illustrative examples.

Technical principle

In the modular prosthesis solution, the pyramid and pyramid receiver interlock.

The graphic that follows illustrates four essential aspects:

- Every Ottobock prosthetic component has a system height.
- The system height deviates from the actual height of the prosthetic component and therefore cannot be measured by the O&P professional.
- Adding the system heights results in the build height for the combined components.
- There are negative system heights as well. These result from the measurement method.

Examining the socket adapter reveals that the measuring point (centre of the circle) lies within the prosthetic socket. This distance from the measuring point to the outer edge of the socket has to be subtracted. Consequently, the socket adapter has a negative system height.

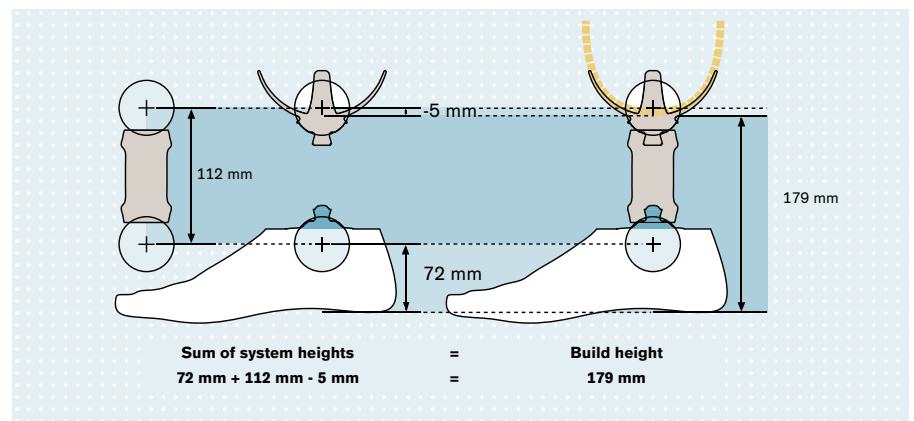

4 steps to check the chosen component combination for accuracy of fit in transtibial prostheses

1. Determine patient measurements

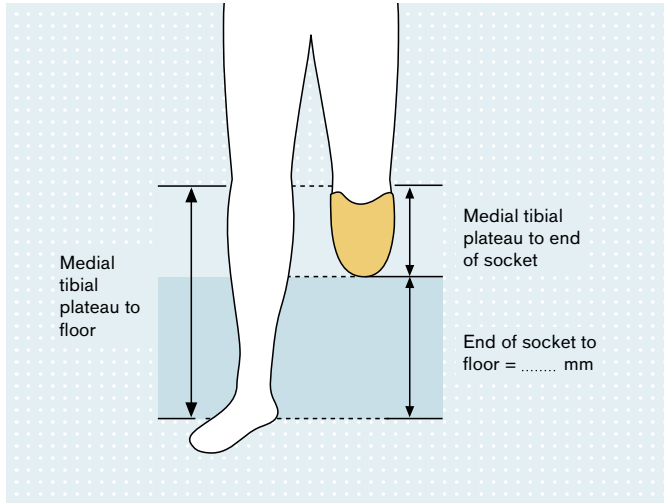

2. Select components

	Reference number	1D35									
	Mobility grade	MG 2 + MG 3									
	Heel height	10 +/- 5 mm									
	Side	links (L), rechts (R)									
	Size	22 cm	23 cm	24 cm	25 cm	26 cm	27 cm	28 cm	29 cm	30 cm	
	System height	57 mm	60 mm	63 mm	66 mm	68 mm	72 mm	74 mm	75 mm	77 mm	
	Weight	-340g	-435g	-510g	-545g	-630g	-645g	-670g	-730g	-755g	
	Max. body weight	75 kg									
	Colour	beige (4), light brown (15)									

	4R116		4R52		4R121=30		1D35, Size 27
---	-------	---	------	---	----------	---	------------------

3. Add system heights

Components that can be shortened have a minimum and maximum system height. The maximum system height specifies the value before shortening, the minimum specifies the value after maximum possible shortening.

Components	System height	
	min.	max.
4R116	2 mm	
4R52	33 mm	
4R121=30	177 mm	553 mm
1D35, Size 27	72 mm	
Build height =	280 mm	656 mm

4. Compare available clearance and structural height of the component combination

The value of the socket end to floor measurement has to be between the minimum and maximum structural height for the component combination.

About this catalogue

Application of the system heights for the knee joint

For the fabrication of a transfemoral prosthesis, all system heights of the individual components are also added to determine the structural height. However, the positioning of the knee joint has to be taken into account here.

Each modular knee joint has an alignment reference point. In monocentric joints this is the rotation axis, in polycentric knee joints it is the anterior, upper axis (see graphic below). We recommend positioning the alignment reference point 20 mm above the medial tibial plateau, illustrated schematically in the following graphic.

The system height of the knee joint alone however does not allow you to draw conclusions about the location of its alignment reference point.

That is why we specify the proximal and distal system height up to the alignment reference point for every modular knee joint. Now you are able to check whether the available distal and proximal space is sufficient to integrate the desired component.

Prostheses for long residual limbs and knee disarticulation often demand a compromise between shifting the knee component distally relative to the recommended position and, where applicable, selecting alternative components with a lower system height.

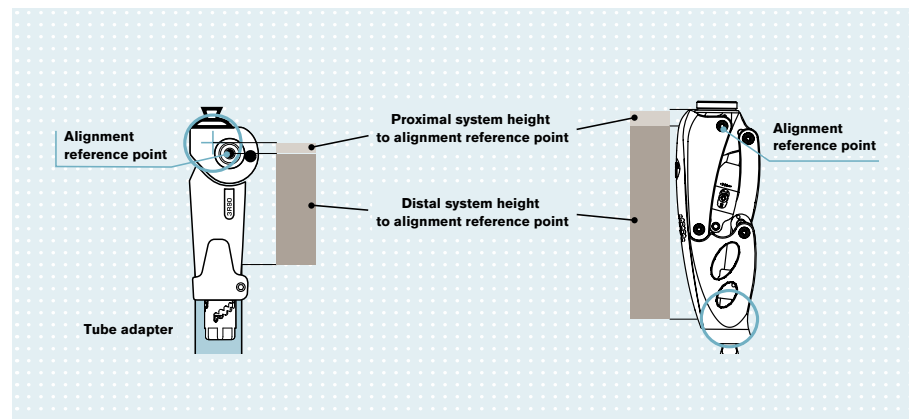

Positioning of the knee joint by means of the alignment reference point

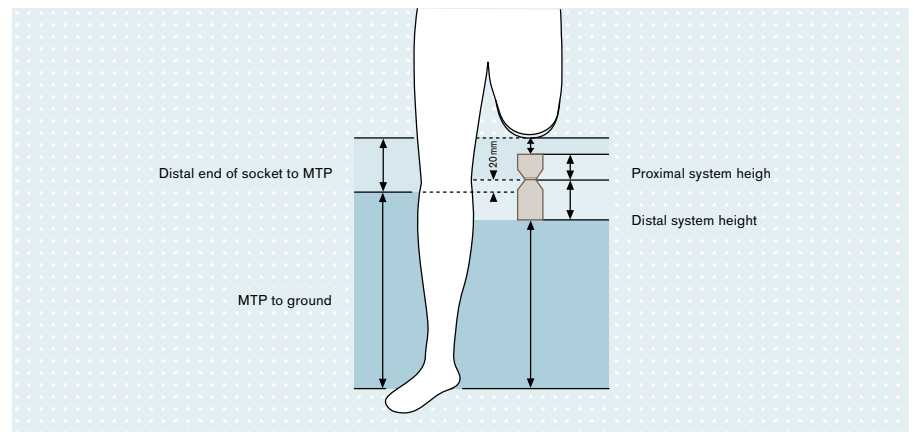

4 steps to check the chosen component combination for accuracy of fit in transfemoral prostheses

1. Determine patient measurements

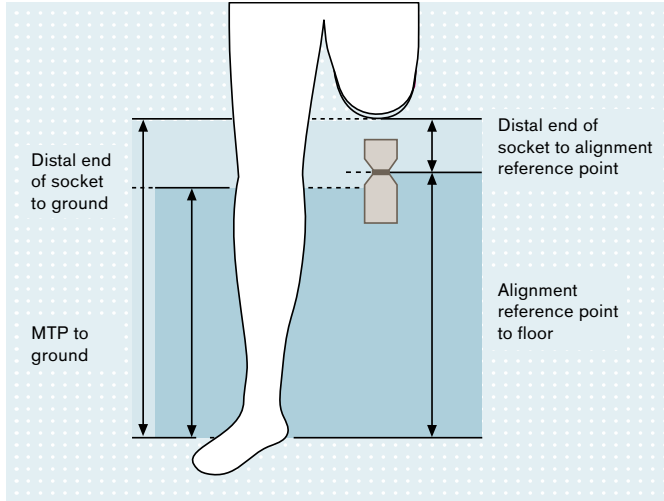

2. Select components



3. Add system heights

Components	System height		
	min.	max.	
4R116	-2 mm		Distal end of socket to alignment reference point = 87 mm
4R72=32	69 mm		
4R57	22 mm		
	proximal -2 mm		Alignment reference point to ground min. = 455 mm, max = 831 mm
3R60	distal 173 mm		
4R52	33 mm		
4R121=30	177 mm	553 mm	
1D35, Gr. 27	72 mm		
Build height =	542 mm	918 mm	

4. Compare available clearance and structural height of the component combination

The value of the socket end to floor measurement has to be between the minimum and maximum structural height for the component combination. In addition, you can now check whether the chosen components permit optimal positioning of the knee joint (alignment reference point + 20 mm above the medial tibial plateau).

About this catalogue

Build height

The build height is another common and practical measurement in orthopaedic technology.

This measurement, which the O&P professional can measure directly on the component, describes the length of the transition between the pyramid and pyramid receiver. The outer termination of the tube clamp is measured on knee joints with a distal tube adapter. In addition, the build height of the tube adapter with or without torsion has to be taken into account.

The build height of a prosthetic foot with pyramid is measured from the bottom of the heel to the lower edge of a vertically installed structural part with pyramid receiver. Since the difference between the system height and build height is about 18 mm, this means 18 mm has to be deducted from the system height for pyramid receivers and 18 mm has to be added for pyramids.

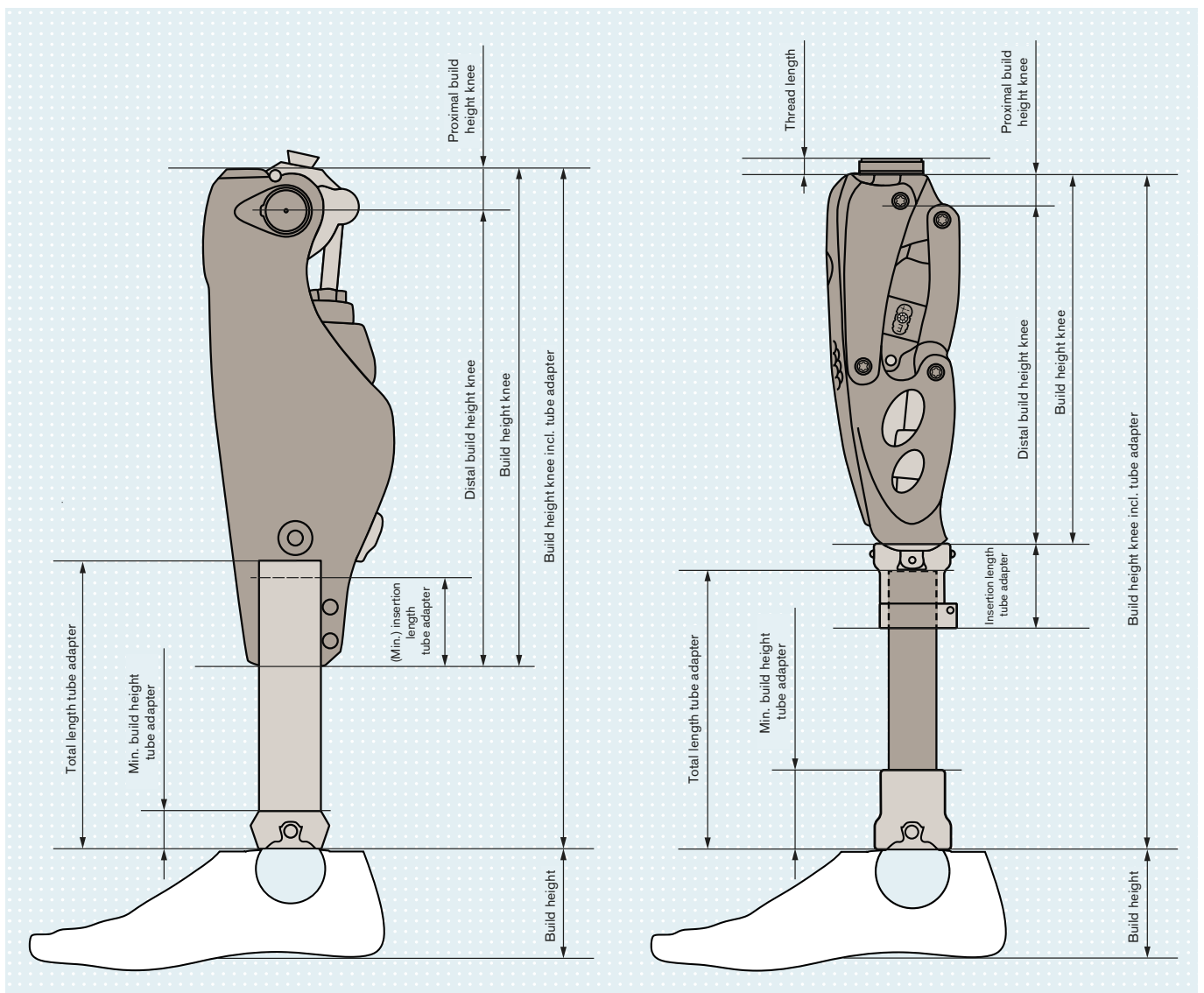

Explanation of symbols



Angled



Moveable



Rotatable



Axial eccentric



Eccentric



Scan your patient



Take your patient's measurements



Enter the measurements on the measurement form



Include measurements, photos and X-ray images as required to assist with modification



Edit and modify the generated model in the software



Take photos of your patient



You have an existing modified, unencrypted STL file from another source



Send the data to Ottobock iFab by e-mail



The product is sent to Ottobock iFab



You will receive the finished product from Ottobock iFab



Prepare an outline sketch on paper



Definitive prosthesis



Version, inside



Check socket for interim fitting



Casting forms, positive/negative, well-fitting check socket or definitive socket as base product



Trial prosthesis

Abbreviations

OI Operating instructions

IFU Instructions for use

QRG Quick reference guide

TI Technical information

About this catalogue

MOBIS – the Ottobock mobility system

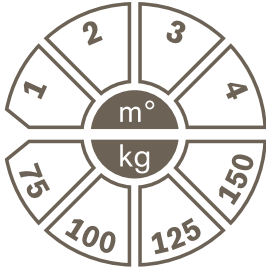

Quality and individuality are our top priorities when fabricating a leg prosthesis. The OP professional's selection of the correct prosthetic components is a decisive factor for treatment success.

MOBIS is a further development of the Ottobock classification system introduced in 1994 that focuses on people and their need for enhanced quality of life.

Four mobility grades and four weight classifications form the basis of the MOBIS selection system. With the help of the MOBIS symbol, the OP professional can see at a glance for what mobility grade and up to what patient weight functional components such as prosthetic feet, knee joints and hip joints are recommended.

With the exception of the torsion adapters and the DeltaTwist, adapters are classified as usual according to patient weight.

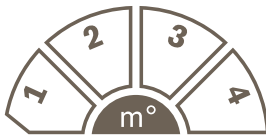

MOBIS is based on 4 mobility grades:

Indoor walker, restricted outdoor walker, unrestricted outdoor walker and unrestricted outdoor walker with particularly high demands.



MOBIS defines 4 weight classes

Patient weight up to 75 kg, up to 100 kg, up to 125 kg and over 125 kg. Ottobock thereby combines all information required for the selection of prosthetic components in one symbol. As usual, the component with the lowest weight classification is decisive for determining the maximum body weight. When a 2R50 tube adapter for example is used, the maximum patient weight of 100 kg applies for the prosthesis as a whole.

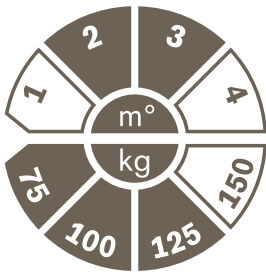

MOBIS is easy to use.

The filled-in fields in the upper half of the symbol show that the 3R60 modular EBS knee joint for example is recommended for patients with mobility grade two and three. The notch on the left edge illustrates the direction of counting. In the lower section, the fields < 75 kg to < 125 kg are filled in. Accordingly the 3R60 is approved for a patient weight up to 125 kg.

Mobility grades and therapy goals

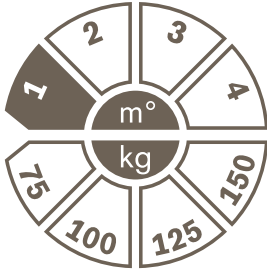

Indoor walker

The patient has the ability or potential to use a prosthesis for transfer purposes or locomotion on level floors at low speed. The amount of time and walking distance are severely limited due to the condition.

Therapy goal:

Restoring the ability to stand and the limited ability to walk indoors.

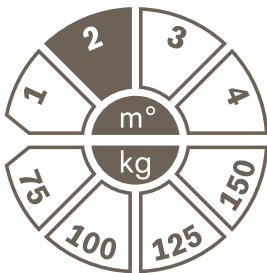

Restricted outdoor walker

The patient has the ability or the potential to walk slowly with the prosthesis and to negotiate low environmental obstacles like curbs, single steps or uneven surfaces. The amount of time and walking distance are severely limited due to the condition.

Therapy goal:

Restoring the ability to stand and the limited ability to walk indoors and outdoors.

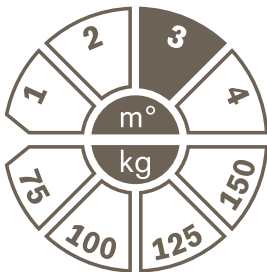

Unrestricted outdoor walker

The patient has the ability or the potential to walk with the prosthesis at a medium to high speed as well as at different speeds and simultaneously overcome most natural obstacles. He or she is also capable of walking outdoors and engaging in professional, therapeutic and other activities that do not subject the prosthesis to above-average mechanical strain. There may be an elevated need for safety due to secondary conditions (additional disability, special living conditions) in combination with a moderate to high need for mobility. The amount of time and walking distance are not significantly limited compared to a person without disabilities.

Therapy goal:

Restoring the ability to stand and the ability to walk indoors and outdoors without significant limitations.

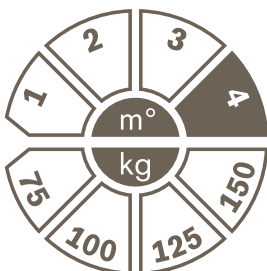

Unrestricted outdoor walker with particularly high demands

The patient's ability or potential to walk with a prosthesis is similar to that of the unrestricted outdoor walker. The amount of time and walking distance are not limited. High impact loads, strain and deformations are also possible due to the high functional demands.

Therapy goal:

Restoring the ability to stand and the ability to walk indoors and outdoors without limitations, with unrestricted mobility.

About this catalogue

Selection tool for hip joints and prosthetic feet

		1S... SACH foot	1D10/1D11 Dynamic foot	1M10 Adjust	1C11 Terion K2	1A30 Greissinger plus	1D35 Dynamic Motion	1C30 Trias	1C40 C-Walk	1C50 Taleo	1C51 Taleo Vertical Shock	1C53 Taleo Low Profile	1E56 Axtion	1E58 Axtion DP	1E57 Lo Rider	1C60 Triton	1C61 Triton Vertical Shock	1C63 Triton Low Profile	1C64 Triton Heavy Duty	1C68 Triton side flex	
HD	7E5	3R20	•	•	•	•															
		3R36	•	•	•	•															
	7E4	3R20	•	•	•	•	•	•													
		3R36	•	•	•	•	•	•													
		3R60=HD			•	•	•	•	•	•	•	•	•	•	•		•	•	•	•	•
		3R60-PRO=HD			•	•	•	•	•	•	•	•	•	•	•		•	•	•	•	•
	7E7	3R60=HD			•	•	•	•	•	•	•	•	•	•	•		•	•	•	•	•
		3R60-PRO=HD			•	•	•	•	•	•	•	•	•	•	•		•	•	•	•	•
		3C98-3 C-Leg		•	•		•	•	•	•	•	•	•	•		•	•	•	•	•	•
	7E9	3R60=HD			•	•	•	•	•	•	•	•	•	•	•		•	•	•	•	•
		3R60-PRO=HD			•	•	•	•	•	•	•	•	•	•	•		•	•	•	•	•
		3C98-3 C-Leg		•			•	•	•	•	•	•	•	•		•	•	•	•	•	•
	7E10	3C98-3 C-Leg		•	•		•	•	•	•	•	•	•	•		•	•	•	•	•	•
		3B1-3 Genium			•			•	•	•	•	•	•	•		•	•	•	•	•	•
		3B5-3 Genium X3						•	•	•	•	•	•	•		•	•	•	•	•	•

This overview is a recommendation for the functional interaction of the hip joint and the prosthetic foot. It is the result of technical tests, biomechanical findings and practical treatment experience and is coordinated according to MOBIS. Please note that the instructions for use provide definitive information regarding the compatibility of individual components. The significant influence of the residual limb and its performance on the overall system must be taken into account for each individual case. An appropriate prosthetic socket and correct alignment are presumed as the basis.

About this catalogue

Selection tool for hip joints and prosthetic feet

	1G6 Lightweight cosmetic foot	1H... Single-axis foot with toes	1S... SACH foot	1D10/1D11 Dynamic foot	1M10 Adjust	1C10 Terion	1C11 Terion K2	1A30 Greissinger plus	1D35 Dynamic Motion	1C30 Trias	1C40 C-Walk	1C50 Taleo	1C51 Taleo Vertical Shock	1C52 Taleo Harmony	1C53 Taleo Low Profile	1E56 Axtion	1E58 Axtion DP	1E57 Lo Rider	1C60 Triton	1C6 1 Triton Vertical Shock	1C62 Triton Harmony	1C63 Triton Low Profile	1C64 Triton Heavy Duty	1C68 Triton side flex	1A1-2 Empower	1B1-2 Meridium	
KD	3R23	•	•	•	•																						
	3R32	•	•	•	•																						
	3R21		•	•	•		•	•																			
	3R30		•	•	•		•	•	•																		
	3R62=1-KD	•	•	•	•		•	•		•	•																
	3R62=KD	•	•	•	•		•	•		•	•																
	3R78=KD		•	•	•		•	•	•	•	•	•	•	•	•	•	•	•			•	•	•	•	•	•	•
	3R106=KD				•		•	•	•	•	•	•	•	•	•	•	•	•			•	•	•	•	•	•	•
	3R106-PRO=KD				•		•	•	•	•	•	•	•	•	•	•	•	•			•	•	•	•	•	•	•
	3R60=KD				•		•	•	•	•	•	•	•	•	•	•	•	•			•	•	•	•	•	•	•
	3R60-PRO=KD				•		•	•	•	•	•	•	•	•	•	•	•	•			•	•	•	•	•	•	•
	3R46									•	•	•	•	•	•	•	•	•			•	•	•	•	•	•	•
	TF	3R40	•	•	•	•																					
3R17		•	•	•	•																						
3R33		•	•	•	•																						
3R41		•	•	•	•																						
3R31/=ST		•	•	•	•																						
3R62/=ST		•	•	•	•		•		•	•	•																
3R62=1/-ST		•	•	•	•		•		•	•	•																
3R15			•	•	•		•	•	•																		
3R49			•	•	•		•	•	•																		
3R20				•	•		•	•	•	•	•																
3R36				•	•		•	•	•	•	•																
3R90				•	•		•	•	•	•	•																
3R93				•	•		•	•	•	•	•																
3R92					•		•	•	•	•	•	•	•	•	•	•	•	•			•	•	•	•	•	•	•
3R78/=ST					•		•	•	•	•	•	•	•	•	•	•	•	•			•	•	•	•	•	•	•
3R106/=ST					•		•	•	•	•	•	•	•	•	•	•	•	•			•	•	•	•	•	•	•
3R106-PRO/=ST					•		•	•	•	•	•	•	•	•	•	•	•	•			•	•	•	•	•	•	•
3R60/=ST					•		•	•	•	•	•	•	•	•	•	•	•	•			•	•	•	•	•	•	•
3R60-PRO/=ST					•		•	•	•	•	•	•	•	•	•	•	•	•			•	•	•	•	•	•	•
3R95/=1									•	•	•	•	•	•	•	•	•	•			•	•	•	•	•	•	•
3R55									•	•	•	•	•	•	•	•	•	•			•	•	•	•	•	•	•
3R80/=ST									•	•	•	•	•	•	•	•	•	•			•	•	•	•	•	•	•
3C60/=ST		•	•	•	•		•	•	•	•	•										•	•	•	•	•	•	•
3C88-3/3C98-3					•		•	•	•	•	•	•	•	•	•	•	•	•			•	•	•	•	•	•	•
3B1-3/=ST					•				•	•	•	•	•	•	•	•	•	•			•	•	•	•	•	•	•
3B5-3/=ST									•	•	•	•	•	•	•	•	•	•			•	•	•	•	•	•	•

This overview is a recommendation for the functional interaction of the knee joint and the prosthetic foot. It is the result of technical tests, biomechanical findings and practical treatment experience and is coordinated according to MOBIS. Please note that the instructions for use provide definitive information regarding the compatibility of individual components. The significant influence of the residual limb and its performance on the overall system must be taken into account for each individual case. An appropriate prosthetic socket and correct alignment are presumed as the basis.





Leg prostheses for children

Leg prostheses for children

Prosthetic feet



SACH foot for children

Reference number 1S30

The 1S30 SACH* foot for children is designed in two sections and is particularly suitable for young children weighing up to 35 kg who require a stable prosthetic foot.

Key features

- Functional properties are achieved through the proven combination of a contoured core and functional foam
- The sole of the foot is replaceable

Technical data

Max. body weight	35 kg
Side	left (L), right (R)
Sizes	12-13 cm
Weight*	90 g
Footshape	Normal shape for a heel height of 10 +/- 5 mm
Colour	beige
System height with adapter*	37 mm
Build height with adapter*	51 mm

* Technical data refer to the size of 12 cm

- * Solid ankle cushion heel

Order example

Reference number	= Side	Size
1S30	= L	12

Information material

647G390=ALL_INT IFU 1K10 1K30 1S30

Scope of delivery

1S30 SACH foot for children 1 Piece

Accessories/spare parts for 1S30

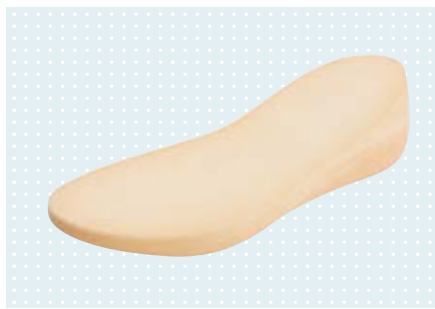

Pedilan sole with heel wedge for 1S30

Reference number 2Z25

The 2Z25 Pedilan sole is a spare part for the 1S30 prosthetic foot for children.

Technical data

Reference number	2Z25=*
Side	left (L), right (R)
Sizes	12-13 cm

Scope of delivery

2Z25 Pedilan sole with heel wedge for 1S30 1 Piece



Information material

647G390=ALL_INT IFU 1K10 1K30 1S30

Scope of delivery

1K30 SACH foot for children 1 Piece

SACH foot for children

Reference number 1K30

The 1K30 SACH* foot for children is a robust children's prosthetic foot that is tailored to the special needs of young prosthesis wearers weighing up to 45 kg.

Key features

- The functional properties are achieved through the combination of a contoured core and functional foam
- Natural foot shape with smooth surface and defined toes

Technical data

Max. body weight	Size 14-17 cm: 35 kg
	Size 18-21 cm: 45 kg
Side	left (L), right (R)
Sizes	14-21 cm
Weight*	125 g
Footshape	Normal shape for a heel height of 5 +/- 5 mm
Colour	beige
System height with adapter*	44 mm
Build height with adapter*	58 mm

* Technical data refer to the size of 16 cm

- * Solid ankle cushion heel

Order example

Reference number	= Side	Size
1K30	= L	16



Information material

647G390=ALL_INT IFU 1K10 1K30 1S30

Scope of delivery

1K10 Dynamic foot for children 1 Piece

Dynamic foot for children

Reference number 1K10

The 1K10 dynamic foot for children is a robust children's prosthetic foot that is tailored to the special needs of young prosthesis wearers weighing up to 45 kg.

Key features

- The design consisting of a contoured core and the use of foams with different characteristics results in a comfortable heel strike and an easier, dynamic rollover
- Natural foot shape with smooth surface and defined toes

Technical data

Max. body weight	45 kg
Side	left (L), right (R)
Sizes	14-21 cm
Weight*	140 g
Footshape	Normal shape for a heel height of 5 +/- 5 mm
Colour	beige
System height with adapter*	44 mm
Build height with adapter*	58 mm

* Technical data refer to the size of 16 cm

Order example

Reference number	= Side	Size
1K10	= L	16

Leg prostheses for children

Prosthetic feet

Accessories/spare parts for 1S30, 1K30, 1K10



Foot adapter with screw connection

Reference number 2R40

The foot adapter is used to integrate the 1S30, 1K10 and 1K30 prosthetic feet for children in modular prostheses.

Technical data

Article number	Material	for	Weight	Max. body weight
2R40=1	Aluminium, Stainless steel	all 1S and 1K children's feet in sizes 18 – 21 cm	80 g	45 kg
2R40=2	Aluminium, Stainless steel	all 1S and 1K children's feet in sizes 12 – 17 cm	45 g	35 kg

Information material

647G97=ALL_INT IFU 2R40 2R41 2R48

Scope of delivery

2R40	Foot adapter with screw connection	1	Piece
2D6	Screw connection	1	Single component pack

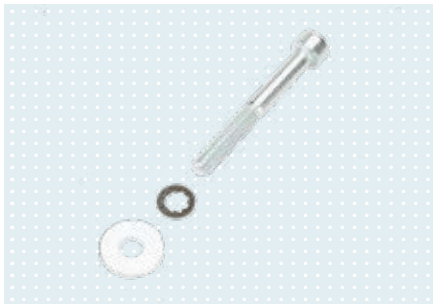

Screw connection

Reference number 2D6

The 2D6 spare parts set is used for the screw connection of the 2R40=1 and 2R40=2 foot adapters with the corresponding prosthetic feet.

Technical data

Article number	Spare part for	Scope of delivery
2D6=M6	2R40=2	1 cap screw (steel) 1 hexagon socket head 1 washer
2D6=M8	2R40=1	1 cap screw (steel) 1 hexagon socket head 1 washer



Chopart footplate for children

Reference number 1E87

The 1E87 Chopart footplate for children is a carbon foot with a very low structural height for treating Chopart or hindfoot amputations. A complete kit for the direct connection to the prosthetic socket is available as an option. The foot is custom-made.

Technical data

Max. body weight	50 kg
Sizes	13-21 cm
Weight*	23 g
Foot shape without footshell	Normal shape for a heel height of 6 +/- 5 mm
Footshell colour	beige
Build height*	16 mm

* Technical data refer to the size of 16 cm

🔗 To order, please use the order form at the end of the section on prosthetic feet.

Information material

647G1076=ALL_INT IFU 1E81 1E87

Scope of delivery

1E87 Chopart footplate for children 1 Piece

Accessories/spare parts for 1E87



Footshell for children

Reference number 2E3

The 2E3 footshell for children is particularly suitable for the 1E87 Chopart footplate for children, with a very low structural height. It is available in sizes from 13 cm to 21 cm. The footshell colour is beige.

Technical data

Reference number	2E3=*
Side	left (L), right (R)
Size	13-21 cm
Weight*	80 g
Colour	beige

* Technical data refer to the size of 16 cm

Scope of delivery

2E3 Footshell for children 1 Piece



Chopart PU adhesive set

Reference number SL=P078

The adhesive set is used for gluing Chopart footplates.

Technical data

Article number	SL=P078
-----------------------	---------

Leg prostheses for children

Prosthetic feet



Chopart PU adhesive set

Reference number SL=P078

Technical data

Article number

SL=P078-PARTS



Footshell foam kit, single application

Reference number SL=P071

Technical data

Article number

SL=P071



Runner junior

Reference number 1E93

The Runner junior is suitable for active children and adolescents who love sports and weigh up to 45 kg. In addition to participation in physical education, the Runner junior supports age-appropriate development and allows children to experience the joy of movement in their social environment.

Key features

- Characterised by a resilient, lightweight carbon spring that provides runners with a powerful drive and stable turning characteristics
- By moving the adapter along the carbon spring, the dynamic response of the running prosthesis can be adapted to the individual needs of the user
- Both trial and definitive fittings are especially straightforward thanks to flexible adjustment possibilities and the connection to the modular prosthesis solution
- Available in different stiffness variants corresponding to the body weight of the user

Information material

647G1145=ALL_INT IFU 1E91 1E93

Scope of delivery

1E93 Runner junior 1 Piece

Technical data

Max. body weight 45 kg

Sizes Universal

Weight 170–210 g

Build height 18.5 cm

Build height, loaded 16 cm

Stiffness chart

Body weight	Stiffness version
15 to 20 kg	SPR-1
21 to 25 kg	SPR-2
26 to 30 kg	SPR-3
31 to 37 kg	SPR-4
38 to 45 kg	SPR-5

Order example

Reference number	=	SPR	-	Stiffness	-	S	-	N-6
1E93	=	SPR	-	3	-	S	-	N-6

Leg prostheses for children

Prosthetic feet

Accessories/spare parts for 1E93



Runner junior adapter with pyramid, rotatable

Reference number 4R224

The pyramid of the 4R224=6 connection adapter can be rotated to any position and makes it easier to adjust the prosthesis to suit the user. Overall, the adapter stands out for its light weight and robustness.



Information material

647G1176=ALL_INT IFU 4R216 4R218 4R224

Technical data

Article number	Material	System height	Build height	Weight	Max. body weight
4R224=6	Aluminium, Stainless steel	3 mm	21 mm	175 g	45 kg



Runner junior sole

Reference number 2Z543

The 2Z543=6 Runner junior universal sole provides an excellent grip, making it suitable for running on a variety of surfaces – from grass to asphalt.

Technical data

Article number	Build height	Weight
2Z543=6	13 mm	90 g

Information material

647G1177=ALL_INT IFU 2Z540 2Z541 2Z543



Tube adapter

Reference number 2R41

The 2R41=1 tube adapter is designed for combination with the 2R40=1 foot adapter. It is intended exclusively for use in transtibial and transfemoral prostheses below the knee joint.

Technical data

Article number	2R41=1
Diameter	22 mm
Material	Aluminium
Min. system height	80 mm
Max. system height	320 mm
Min. build height	45 mm
Overall length	314 mm
Weight	140 g
Max. body weight	45 kg

Information material

647G97=ALL_INT IFU 2R40 2R41 2R48 4R66

Scope of delivery

2R41=1	Tube adapter	1	Piece
506G3=M6X10	Set screw	4	Piece



Tube adapter

Reference number 2R41

The 2R41=2 tube adapter is designed for combination with the 2R40=2 foot adapter. It is intended exclusively for use in transtibial and transfemoral prostheses, both above and below the knee joint.

Technical data

Article number	2R41=2
Diameter	22 mm
Material	Aluminium
Min. system height	80 mm
Max. system height	278 mm
Min. build height	45 mm
Overall length	274 mm
Weight	125 g
Max. body weight	35 kg

Information material

647G97=ALL_INT IFU 2R40 2R41 2R48 4R66

Scope of delivery

2R41=2	Tube adapter	1	Piece
506G3=M6X10	Set screw	4	Piece

Leg prostheses for children

Adapters



Tube adapter, angled

Reference number 2R48

The angled 2R48 tube adapter is designed for combination with the 7E8 hip joint for children.



Technical data

Article number	2R48
Diameter	22 mm
Material	Aluminium
Min. system height	80 mm
Max. system height	219 mm
Min. build height	45 mm
Overall length	220 mm
Weight	105 g
Angled	13°
Max. body weight	45 kg

Information material

647G97=ALL_INT IFU 2R40 2R41 2R48 4R66

Scope of delivery

2R48	Tube adapter, angled	1	Piece
506G3=M6X10	Set screw	4	Piece



Tube clamp adapter

Reference number 4R66

The 4R66 tube clamp adapter is intended exclusively for use in transtibial prostheses.

Technical data

Article number	Diameter	Material	System height	Build height	Weight	Max. body weight
4R66	22 mm	Aluminium	-9 mm	29 mm	45 g	45 kg

Information material

647G97=ALL_INT IFU 2R40 2R41 2R48 4R66

Scope of delivery

4R66	Tube clamp adapter	1	Piece
501S42=M6X18	Oval Allen head screw	1	Piece

Accessories/spare parts for 4R66



Oval Allen head screw

Reference number 501S42

Technical data

Article number	501S42=M6X18
----------------	--------------



Socket attachment block

Reference number 5R9

The 5R9 socket attachment block is intended for use in transtibial and transfemoral prostheses.

Technical data

Article number	Material	System height	Build height	Weight	Max. body weight
5R9	Plastic	30 mm	30 mm	125 g	45 kg

- The enclosed 4X8 lamination dummy is to be used for laminating.

Information material

647G1625=ALL_INT IFU 5R9 4R60

Scope of delivery

5R9	Socket attachment block	1	Piece
501S41=M5X16	Countersunk head screw	4	Piece
4X8	Lamination dummy	1	Piece

Accessories/spare parts for 5R9

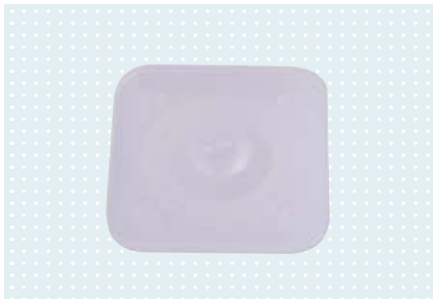

Lamination dummy

Reference number 4X8

Use the 4X8 lamination dummy for laminating with the 5R9 socket attachment block.

Technical data

Article number
4X8



Countersunk head screw

Reference number 501S41

Technical data

Article number
501S41=M5X16

Leg prostheses for children

Adapters



Socket adapter

Reference number 4R60

The 4R60 socket adapter is intended for use in transtibial and transfemoral prostheses.

Technical data

Article number	Material	System height	Build height	Weight	Max. body weight
4R60	Aluminium	33 mm	19 mm	45 g	45 kg

Information material

647G1625=ALL_INT IFU 5R9 4R60

Scope of delivery

4R60	Socket adapter	1	Piece
506G3=M6X10	Set screw	4	Piece



Lamination anchor with pyramid receiver

Reference number 4R110

The 4R110 lamination anchor is intended for use in transtibial and transfemoral prostheses and is laminated into the socket.

Technical data

Article number	Material	System height	Build height	Weight	Max. body weight
4R110	Aluminium	35 mm	21 mm	55 g	45 kg

- The enclosed lamination dummy is to be used for laminating.

Information material

647G1588=ALL_INT IFU 4R110

Scope of delivery

4R110	Lamination anchor with pyramid receiver	1	Piece
501Z2=M4X20	Cap screw (Allen screw)	1	Piece
506G3=M6X10	Set screw	4	Piece
506G3=M6X12	Set screw	2	Piece

Accessories/spare parts for 4R110



Cap screw (Allen screw)

Reference number 501Z2

Technical data

Article number

501Z2=M4X20

Accessories/spare parts for 2R41, 2R48, 4R60, 4R110



Set screw

Reference number 506G3

The 506G3 set screws are intended for adapters with a pyramid receiver. They are available in various lengths.

Technical data

Article number	Length	Spare part for
506G3=M6X10	10 mm	2R41=1 2R41=2 2R48 4R60 4R110
506G3=M6X12	12 mm	4R110

Leg prostheses for children

Knee joints



Knee joint with lock

Reference number 3R39

The 3R39 is a monocentric modular knee joint with lock for children. The integrated locking mechanism secures the joint in the extended position. A lock cable protruding from the upper joint section is used to unlock the locking mechanism and permit flexion.

Key features

- Maximum safety thanks to lock
- Flexion angle of 145° enables extensive freedom of movement for the leg
- Lightweight aluminium design with weight of just 145 g
- Suitable for young users with a body weight of up to 45 kg

Technical data

Article number	3R39
Max. body weight	45 kg
Weight	145 g
Proximal connection	Pyramid
Distal connection	Tube clamp Ø 22
Knee flexion angle	145 °
System height	24 mm
Proximal system height to alignment reference point	2 mm
Distal system height to alignment reference point	22 mm
Build height	61 mm
Proximal build height to alignment reference point	16 mm
Distal build height to alignment reference point	45 mm
Material	Aluminium
Version	monocentric

Information material

647G99=ALL_INT IFU 3R38 3R39

Scope of delivery

3R39 1 Piece

Accessories/spare parts for 3R39

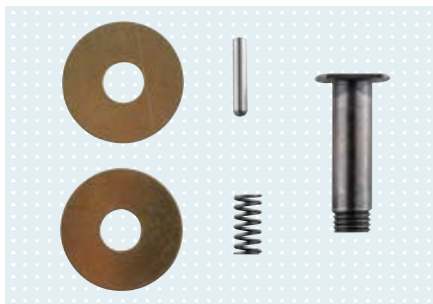

Single component pack

Reference number 4D20

The single component pack consists of spare parts for the 3R39 modular knee joint for children.

Technical data

Article number	Spare part for
4D20	3R39

Components

Joint axis	1 Piece
Washer	2 Piece
Straight pin	1 Piece
Compression spring	1 Piece



Knee joint with adjustable extension assist mechanism

Reference number 3R38

The 3R38 monocentric knee joint for children features an individually adjustable extension assist mechanism to control the swing phase.

Key features

- Made from aluminium for a low weight of 160 g
- Large knee flexion angle of 145° enables extensive freedom of movement
- Suitable for young users with a body weight of up to 45 kg

Technical data

Article number	3R38
Max. body weight	45 kg
Weight	160 g
Proximal connection	Pyramid
Distal connection	Tube clamp Ø 22
Knee flexion angle	145 °
System height	24 mm
Proximal system height to alignment reference point	2 mm
Distal system height to alignment reference point	22 mm
Build height	61 mm
Proximal build height to alignment reference point	16 mm
Distal build height to alignment reference point	45 mm
Version	monocentric

Information material

647G99=ALL_INT	IFU 3R38 3R39
----------------	---------------

Scope of delivery

3R38	1	Piece
------	---	-------

Accessories/spare parts for 3R38

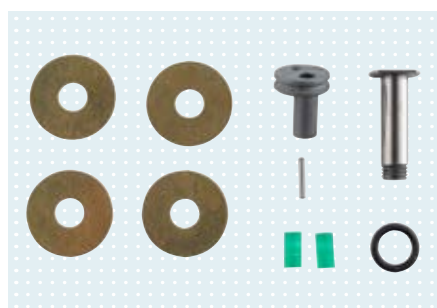

Single component pack

Reference number 4D15

The single component pack consists of spare parts for the 3R38 modular knee joint for children.

Technical data

Article number	Spare part for
4D15	3R38

Components

Cylinder pin	1	Piece
Guide sleeve	1	Piece
O-ring	1	Piece
Joint axis	1	Piece
Washer	2	Piece
Bumper	2	Piece

Leg prostheses for children

Knee joints



Knee joint with integrated rotation

Reference number 3R66

A rotation unit integrated into the lower joint section permits rotation of the prosthetic foot with automatic repositioning when the load is removed. Combined with the large flexion angle of about 179°, this makes a favourable kneeling position possible as well as crouching with the foot turned out.

Key features

- Integrated rotation unit offers a variety of sitting positions and increased mobility
- Lightweight aluminium design with an overall weight of just 310 g
- Large flexion angle of 179° enables extensive freedom of movement for the leg
- Individually adjustable knee stability due to adjustable stop
- Individually adjustable extension assist mechanism to control the swing phase
- Suitable for young users with a body weight of up to 35 kg

Information material

647G1534=ALL_INT IFU 3R66

Scope of delivery

3R66 1 Piece

Technical data

Article number	3R66
Max. body weight	35 kg
Weight	310 g
Proximal connection	Pyramid
Distal connection	Tube clamp Ø 22 mm
Knee flexion angle	179 °
System height	76 mm
Proximal system height to alignment reference point	- 6 mm
Distal system height to alignment reference point	83 mm
Build height	118 mm
Proximal build height to alignment reference point	8 mm
Distal build height to alignment reference point	110 mm
Version	Polycentric

Not suitable for hip disarticulation fittings.



Knee joint with hydraulic swing phase control

Reference number 3R67

The 3R67 supports various walking speeds and offers high stance phase stability. The low-viscosity oil used in the joint's hydraulics results in ease of movement in the swing phase. With a net weight of just 510 g, the joint offers great freedom of movement for young users.

Key features

- Flexible adjustment to various walking speeds through hydraulic swing phase control
- Increased stability in the stance phase for safe standing
- Increased knee stability thanks to four-axis polycentric structure
- Large knee flexion angle of 150° enables extensive freedom of movement
- Suitable for young users with a body weight of up to 45 kg
- Special adapter included in scope of delivery.

Information material

647G1098=ALL_INT IFU 3R67

Scope of delivery

3R67		1	Piece
710H10	Adjustment wrench	1	Piece

Technical data

Article number	3R67
Max. body weight	45 kg
Weight	510 g
Proximal connection	Pyramid
Distal connection	Pyramid
Knee flexion angle	150 °
System height	97 mm
Proximal system height to alignment reference point	1 mm
Distal system height to alignment reference point	96 mm
Build height	129 mm
Proximal build height to alignment reference point	15 mm
Distal build height to alignment reference point	114 mm



Sport knee joint

Reference number 3S80

The patented principle of rotation hydraulics already familiar from the 3R80 prosthetic knee joint is also used in a modified form in the 3S80 Sport. The rotation hydraulics in the 3S80=1 product variant contain oil with a lower viscosity than the standard 3S80 product variant. Due to its lower oil viscosity, the 3S80=1 is particularly well suited for applications demanding maximum ease of movement in the swing phase, for example sport prostheses for children or prostheses used for sprinting.

Technical data

Article number	3S80=1
Max. body weight	100 kg
Weight	682 g
Proximal connection	Pyramid
Distal connection	Pyramid
Range	135 °
System height	48 mm
Proximal system height to alignment reference point	28 mm
Distal system height to alignment reference point	20 mm
Build height	84 mm
Proximal build height to alignment reference point	46 mm
Distal build height to alignment reference point	38 mm

Information material

647G813=ALL_INT IFU 3S80
646D1563=ALL_INT QRG for 3S80, 1E90

Scope of delivery

3S80		1	Piece
710H10	Adjustment wrench	1	Piece

Leg prostheses for children

Hip joint



Hip joint with adjustable extension assist mechanism

Reference number 7E8

The 7E8 modular hip joint for children has an individually adjustable extension assist mechanism to control the swing phase as well as an adjustable abduction/adduction and flexion/extension position.

Technical data

Article number	7E8
Max. body weight	45 kg
Weight	215 g
Proximal connection	Lamination plate
Distal connection	Tube clamp Ø 22
System height	19 mm
Min. build height	60 mm
Version	monocentric

Information material

647G98=ALL_INT IFU 7E8

Scope of delivery

7E8 1 Piece

Accessories/spare parts for 7E8

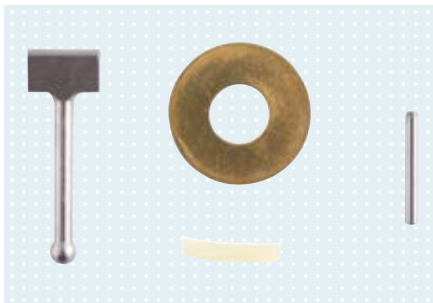

Single component pack

Reference number 7D3

The single component pack consists of spare parts for the 7E8 modular hip joint for children.

Technical data

Article number	Spare part for
7D3	7E8

Components

Cylinder pin	1 Piece
Tappet	1 Piece
Extension stop bumper	1 Piece
Washer	1 Piece

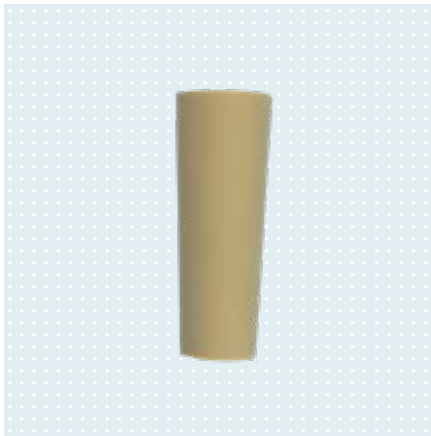

Foam cover

Reference number 6R7

The cover for modular transtibial prostheses for children restores the natural leg volume. It has a 22-mm diameter bore and can be used on the left or right side.

Key features

- Material: PUR foam
- With bore for 22-mm tube diameter
- Suitable for modular transtibial prostheses for children

Technical data

Article number	Material	Tube Ø	Length
6R7	PUR	22 mm	Approx. 35 cm

Information material

647G479=ALL_INT IFU

- The material is flame retardant according to DIN 75200. Complies with MVSS 302 ≤ 100 mm.



Foam cover

Reference number 3R48

The cover for modular transfemoral and hip disarticulation prostheses for children restores the natural leg volume. It has a stepped centre hole with a 22-mm diameter bore in the lower leg area and is partly anatomically pre-shaped. The cover can be used on the left or right side.

Key features

- Material: PUR foam
- Can be used for modular transfemoral and hip disarticulation prostheses for children
- With stepped centre hole (diameter of 22 mm in the lower leg area)
- Partly anatomically pre-shaped
- Pre-flexed in the area of the knee

Technical data

Article number	Material	Calf circumference	Knee flexion	Length
3R48	PUR	32 cm	30 °	Approx. 70 cm

Information material

647G479=ALL_INT IFU

- The material is flame retardant according to DIN 75200. Complies with MVSS 302 ≤ 100 mm.

Leg prostheses for children

Cosmetic stockings

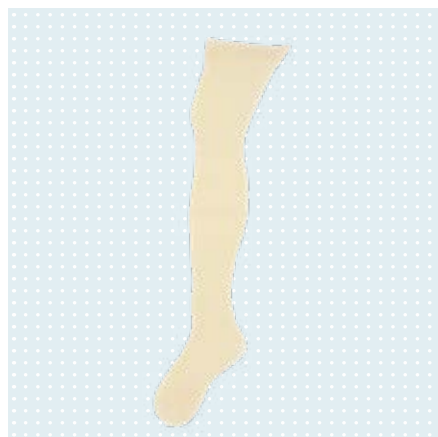

Perlon cosmetic stocking

Reference number 99B22

The perlon cosmetic stocking is intended as an exterior cosmetic cover for modular transfemoral and hip disarticulation prostheses for children.

Key features

- Material: polyamide
- Stocking for modular transfemoral and hip disarticulation prostheses for children
- Available in three sizes
- Delivery unit: one piece

Technical data

Article number	size	Length	Foot length	Ankle (1/2)	Cuff (1/2)	Colour
99B22=1	1	~ 42 cm	~ 15 cm	~ 9 cm	~ 9 cm	Beige
99B22=2	2	~ 63 cm	~ 16.5 cm	~ 9 cm	~ 9 cm	Beige
99B22=3	3	~ 63 cm	~ 17.5 cm	~ 9 cm	~ 9 cm	Beige

- Delivery unit: one piece
- The dimensions listed in the table serve as a guideline. Possible variations in these dimensions may occur during production. They have no effect on elasticity and product function. The desired dimension can be obtained by pulling.





Initial and interim prostheses

Initial and interim prostheses



Tube adapter, length-adjustable

Reference number 2R45=S

The 2R45=S length-adjustable tube adapter serves as an adjusting element for optimising the alignment and must be removed before completing the definitive prosthesis.

Technical data

Article number	Diameter	Material	System height	Build height	Weight	Max. body weight
2R45=S	30 mm	Stainless steel	70 mm	85 mm	200 g	100 kg

- Intended exclusively for use in initial or interim prostheses, for testing and the fitting of lower limb prostheses.

Information material

647G255=ALL_INT IFU 2R45=S 2R45=34



Tube adapter, length-adjustable

Reference number 2R45=34

The 2R45=34 length-adjustable tube adapter serves as an adjusting element for optimising the alignment and must be removed before completing the definitive prosthesis. The length of the adapter can be adjusted thanks to the two pieces of scaled tube that are included. The exterior and interior rotation of the foot can also be adjusted.

Technical data

Article number	2R45=34
Diameter	34 mm
Material	Stainless steel, Aluminium
Min. system height	268 mm
Max. system height	398 mm
Min. build height	130 mm
Overall length	380 mm
Weight (with 2R56=230 tube)	430 g
Weight (with 2R56=300 tube)	470 g
Max. body weight	125 kg

- Intended exclusively for use in initial or interim prostheses, for testing and the fitting of lower limb prostheses.

Information material

647G255=ALL_INT IFU 2R45=S 2R45=34

Spare parts/accessories for 2R45=S, 2R45=34



Cap screw (Allen screw)

Reference number 501Z2

Technical data

Article number

501Z2=M6X25



Grub screw

Reference number 506G3

Technical data

Article number

506G3=M8X12-V



Scaled tube 230 mm

Reference number 2R56

Technical data

Article number	Spare part for	Diameter	Material	Weight	Length	Max. body weight
2R56=230	2R45=34	34 mm	Aluminium	130 g	230	125 kg



Scaled tube 300 mm

Reference number 2R56

Technical data

Article number	Spare part for	Diameter	Material	Weight	Length	Max. body weight
2R56=300	2R45=34	34 mm	Aluminium	170 g	300 mm	125 kg

Initial and interim prostheses



Sliding adapter

Reference number 4R101

The 4R101 sliding adapter permits translational adjustments in the frontal and sagittal planes. It consists of an upper and a lower part, which can be moved against each other. The displacement can be read on a scale. The adapter is installed between the socket attachment block and the socket adapter.



Information material

647G1628=ALL_INT IFU 4R101

Technical data

Article number	Material	System height	Build height	Weight	Offset in m-l and a-p direction	Max. body weight
4R101	Aluminium	25 mm	25 mm	205 g	+/- 11 mm	100 kg

- The 4R101 sliding adapter may only be used in transfemoral prostheses, proximal to the prosthetic knee joint.
- It is suitable for interim and definitive fittings.

Accessories/spare parts for 4R101



Clamping nut

Reference number 4Y212

Technical data

Article number

4Y212



Oval flange head screw (Allen screw)

Reference number 501S44

Technical data

Article number

501S44=M6X25



Countersunk head screw (Allen screw)

Reference number 501S41

Technical data

Article number

501S41=M6X16

Initial and interim prostheses



Information material

647G1624=ALL_INT IFU 4R112

Sliding adapter set

Reference number 4R112

The 4R112 sliding adapter set is used to optimise the alignment of lower limb prostheses within the scope of initial treatment for a limited time and/or interim prostheses. It includes two mounting plates as well as an adapter with pyramid and an adapter with pyramid receiver. Adjustments in the frontal and sagittal plane as well as the rotation direction are possible.



Technical data

Article number	4R112
Material	Aluminium, Titanium
System height (plate plus both adapters)	33 mm
Build height	32 mm
Weight	Between 195 g and max. 510 g
Offset in a-p direction	with mounting plate 1: 48 mm in 12 mm increments with mounting plate 2: 24 mm in 12 mm increments
Offset in m-l direction	with mounting plate 1: 24 mm in 12 mm increments with mounting plate 2: 18 mm in 9 mm increments
Rotation adjustment	+/- 18° in 3° increments
Max. body weight	100 kg

• Exclusively for testing and trial fitting purposes in initial and/or interim prostheses!

Accessories/spare parts for 4R112

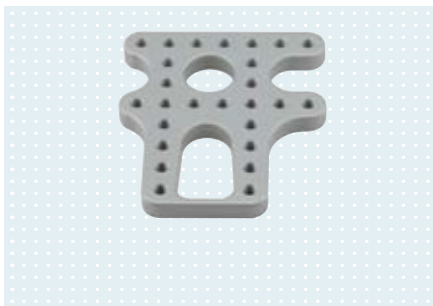

Mounting plate

Reference number 4R112*

Technical data

Article number

4R112-1



Mounting plate

Reference number 4R112*

Technical data

Article number

4R112-2

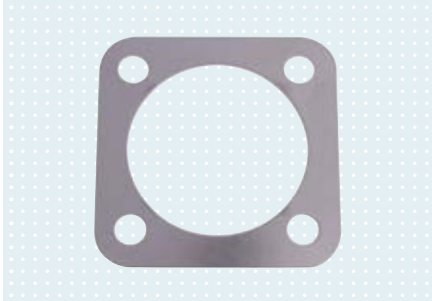

Pressure plate

Reference number 4Y19

Technical data

Article number

4Y19



Countersunk head screw (Allen screw)

Reference number 501S41

Technical data

Article number

501S41=M6X12

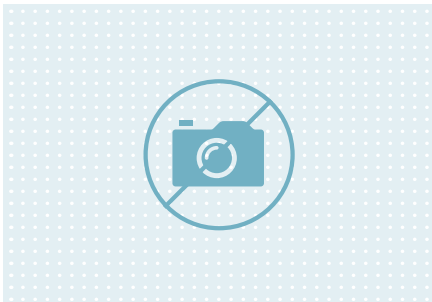

Countersunk head screw (Allen screw)

Reference number 501S71

Technical data

Article number

501S71=M6X25

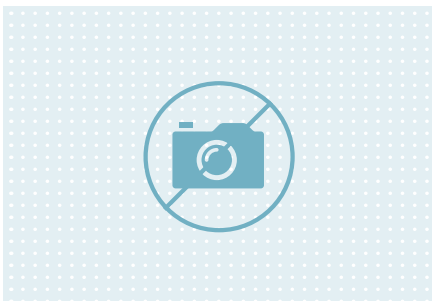

Cap screw (Allen screw)

Reference number 501T48

Technical data

Article number

501T48=M6X25



Cap screw

Reference number 501T61

Technical data

Article number

501T61=M6X12

Initial and interim prostheses



Hexagon nut with conical support

Reference number 502Z22

Technical data

Article number

502Z22=M6



Washer

Reference number 507U12

Technical data

Article number

507U12=6.2X10.3



Grub screw

Reference number 506G3

Technical data

Article number

506G3=M8X12-V



Adjustment adapter

Reference number 4R1

The 4R1 adjustment adapter facilitates the correct static alignment of lower limb prostheses during fitting because it allows adjustments to be made under load on the patient while standing. Reproducible adjustments are possible thanks to the scales, allowing the gait pattern to be optimised quickly during trial walking.



Information material

647G1529=ALL_INT IFU 4R1

Technical data

Article number	4R1
Material	Aluminium
System height	68 mm
Build height	68 mm
Weight	615 g
Offset in a-p direction (max. displacement)	50 mm (corresponds to 25 mm respectively)
Offset in m-l direction (max. displacement)	30 mm (corresponds to 15 mm respectively)
Max. body weight	100 kg

- Intended exclusively for temporary use during fitting of the prosthesis!
- Using the 4R1 is particularly recommended with the 743L500 3D L.A.S.A.R. Posture and the 743A160 Ottobock transfer apparatus.

Accessories/spare parts for 4R1



Countersunk head screw (Allen screw)

Reference number 501S41

Technical data

Article number	501S41=M6X16
-----------------------	--------------



Grub screw

Reference number 506G3

Technical data

Article number	506G3=M8X12-V
-----------------------	---------------

Initial and interim prostheses



Information material

647G644=ALL_INT IFU 4R170

Sliding adapter

Reference number 4R170

The 4R170=1 and 4R170=2 sliding adapters enable fast and easy adjustment of the socket flexion position in transfemoral prostheses thanks to the option to make adjustments along a circular path. The adjustment of the sliding proximal connector is made with an Allen wrench.

Key features

- The 4R170=1 is suitable for fittings with a larger socket flexion setting
- The 4R170=2 is suitable for fittings with a smaller socket flexion setting
- The adjustment range for both adapters is 4°. The socket flexion angle can be changed at any time. The settings can be reproduced with the help of the attached scale
- The exterior thread is used to connect to a lamination anchor with threaded connector
- The 4R50 pyramid can be screwed onto the thread to establish the connection to a prosthetic component with a pyramid receiver
- The proximal connector can be exchanged for the 4R173 pyramid receiver, which has to be ordered separately

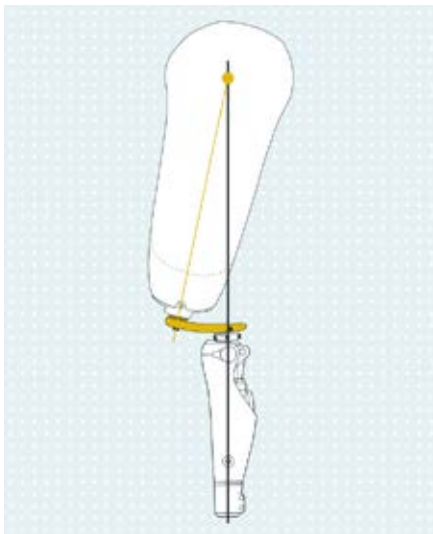

Technical data

Article image



Article number	4R170=1	4R170=2
Material	Stainless steel	Stainless steel
Distal connection	4-hole	4-hole
Proximal connection	Thread	Thread
System height	15 mm	15 mm
Build height	15 mm	15 mm
Weight	555 g	445 g
Displacement	4 mm	4 mm
Max. body weight	150 kg	150 kg

- The 4R170 sliding adapter may only be used in transfemoral prostheses, proximal to the prosthetic knee joint.
- For use in interim and definitive prostheses.
- Position the 4R170 sliding adapter 300 mm distally from the socket reference point, or as close to that as possible. Depending on the design, the length of the prosthesis then remains virtually unchanged despite changes in the socket flexion position.



Pyramid receiver

Reference number 4R173

The 4R173 pyramid receiver can be used instead of the sliding exterior thread of the 4R170.



Technical data

Article number	Material	System height	Build height	Weight	Adjustment range	Max. body weight
4R173	Stainless steel	35 mm	17 mm	170 g	4 °	150 kg

Information material

647G644=ALL_INT IFU 4R170

Accessories/spare parts for 4R170



Countersunk head screw (Allen screw)

Reference number 501S41

Technical data

Article number

501S41=M6X12





Waterproof walking aids

Waterproof walking aids

Prosthetic feet



Aqua foot with modular adapter

Reference number 1WR95

The 1WR95 Aqua foot is a waterproof prosthetic foot. The proximal contact surface in the modular version is coated with a sealing resin before it leaves the factory to protect against water penetration and is connected to a high-grade titanium foot adapter. Access to the adapter screw on the sole of the foot is sealed with a plug.

Key features

- The shape, the lattice-like tread on the sole and the special composition of the material provide excellent grip
- Natural foot shape with defined toes and a separate big toe



Max. 150 kg

Information material

647G634=ALL_INT IFU 1WR95

Scope of delivery

1WR95	Aqua foot with modular adapter	1	Piece
-------	--------------------------------	---	-------

Technical data

Max. body weight	150 kg
Side	left (L), right (R)
Sizes	24-28 cm
Weight*	629 g
Foot shape	Normal shape for a heel height of 0 mm
Colour	beige (4)
System height*	67 mm
Build height*	85 mm

* Technical data refer to the size of 26 cm

Order example

Reference number	=	Side	Size	-	0	-	P	/	Colour
1WR95	=	L	26	-	0	-	P	/	4



Aqua foot without adapter for exoskeletal design

Reference number 1WR95

The 1WR95 Aqua foot without adapter is waterproof and intended for use in waterproof walking aids with an exoskeletal design.

Key features

- The shape, the lattice-like tread on the sole and the special composition of the material provide excellent grip
- Natural foot shape with defined toes and a separate big toe



Max. 150 kg

Information material

647G634=ALL_INT IFU 1WR95

Scope of delivery

1WR95 Aqua foot without adapter for exoskeletal design 1 Piece

Technical data

Max. body weight	150 kg
Side	left (L), right (R)
Sizes	24-28 cm
Weight without adapter*	559 g
Foot shape	Normal shape for a heel height of 0 mm
Colour	beige (4)
Build height without adapter*	85 mm

* Technical data refer to the size of 26 cm

Order example

Reference number	=	Side	Size	-	0	-	W	/	Colour
1WR95	=	L	26	-	0	-	W	/	4

Accessories/spare parts for Aqua foot without adapter for exoskeletal design



Ankle block

Reference number 2K34

Without threaded bushing, for 1WR95 without adapter, to be used on the left or right side.

Technical data

Article number	For foot sizes
2K34=30	26 – 30 cm



Screw connection

Reference number 2Z22

The single component set is used for the screw connection between prosthetic feet and ankle blocks.

Technical data

Article number	for
2Z22=M10	1WR95 Aqua foot without adapter

Waterproof walking aids

Adapters



Tube adapter

Reference number 2WR95

The 2WR95 tube adapter is waterproof. It has four grooves in the pyramid receiver section, which ensure that the tube is flooded when setting foot in water. The prosthesis is prevented from becoming buoyant as a result.



Max. 150 kg



Information material

647G902=ALL_INT IFU Tube adapters

Scope of delivery

2WR95	Tube adapter	1	Piece
506G3=M8X14	Set screw	4	Piece

Technical data

Article number	2WR95
Diameter	34 mm
Material	Titanium
Min. system height	77 mm
Max. system height	472 mm
Min. build height	27 mm
Overall length	454 mm
Weight	330 g
Max. body weight	150 kg

- To achieve the full range of adjusting options for bench alignment of the waterproof walking aid using the 1WR95 Aqua foot with a 0 mm heel height, according to the Ottobock alignment recommendations, we recommend using the 2WR95=1 angled tube adapter. If needed, the 2WR95 tube adapter which is not angled may be used above the knee joint for transfemoral amputees.



Tube adapter, angled

Reference number 2WR95=1

The 2WR95=1 tube adapter is waterproof. It is similar to the 2WR95 tube adapter but, in the interest of alignment optimisation, angled by 6° to achieve the full range of adjusting options for bench alignment of the waterproof walking aid using the 1WR95 Aqua foot with a 0-mm heel height, according to the Ottobock alignment recommendations.



Max. 150 kg



Information material

647G902=ALL_INT	IFU Tube adapters
-----------------	-------------------

Scope of delivery

2WR95=1	Tube adapter	1	Piece
506G3=M8X14	Set screw	4	Piece

Technical data

Article number	2WR95=1
Diameter	34 mm
Material	Titanium
Min. system height	78 mm
Max. system height	473 mm
Min. build height	27 mm
Overall length	455 mm
Weight	330 g
Max. body weight	150 kg

Accessories/spare parts for 2WR95



Set screw

Reference number 506G3

The 506G3 set screws are intended for adapters with a pyramid receiver. They are available in various lengths. Set screws that are protruding or recessed too much should be replaced with appropriate ones.

Technical data

Article number	Length
506G3=M8X12-V	12 mm
506G3=M8X14	14 mm
506G3=M8X16	16 mm

Waterproof walking aids

Adapters



Tube clamp adapter

Reference number 4WR95=3

The 4WR95=3 tube clamp adapter is waterproof. There are four grooves in the pyramid receiver section, which ensure that the adapter is flooded when setting foot in water. The prosthesis is prevented from becoming buoyant as a result.



Max. 150 kg



Information material

647G903=ALL_INT IFU Tube clamp adapters

Scope of delivery

4WR95=3	Tube clamp adapter	1	Piece
4X28=3	Plastic ring	1	Piece
4Y423	Cylinder pin	1	Piece
4Y424	Cylinder pin with interior thread	1	Piece
501T24=M5X25	Clamping screw, blue coated	1	Piece
506G3=M8X14	Set screw	4	Piece

Technical data

Article number	Diameter	Material	System height	Build height	Weight	Max. body weight
4WR95=3	34 mm	Titanium	33 mm	49 mm	130 g	150 kg

Accessories/spare parts for 4WR95=3



Plastic ring

Reference number 4X28

Technical data

Article number

4X28=3



Cylinder pin

Reference number 4Y423

Technical data

Article number

4Y423



Cylinder pin with interior thread

Reference number 4Y424

Technical data

Article number

4Y424



Clamping screw, blue coated

Reference number 501T24

Technical data

Article number

501T24=M5X25



Set screw

Reference number 506G3

The 506G3 set screws are intended for adapters with a pyramid receiver. They are available in various lengths. Set screws that are protruding or recessed too much should be replaced with appropriate ones.

Technical data

Article number	Length
506G3=M8X12-V	12 mm
506G3=M8X14	14 mm
506G3=M8X16	16 mm

Waterproof walking aids

Adapters



Lamination anchor with pyramid, rotatable

Reference number 4WR95=2

The 4WR95=2 lamination anchor is laminated into a prosthetic socket. It serves to connect the prosthetic socket to the distal prosthetic components. It is waterproof.



Max. 125 kg



Information material

647G123=ALL_INT IFU Lamination anchors

Scope of delivery

Article number	Description	Quantity	Unit
4WR95=2	Lamination anchor with pyramid, rotatable	1	Piece
501Z2=M5X30	Cap screw (Allen screw)	1	Piece
507U16=5.2-NIRO	Rounded washer	1	Piece
501T24=M5X25	Clamping screw, blue coated	1	Piece

Technical data

Article number	Material	System height	Build height	Weight	Max. body weight
4WR95=2	INOX stainless steel	2 mm	20 mm	165 g	125 kg

- Suitable only for use in transfemoral prostheses. The 4R117=T lamination anchor can, for example, be used for transtibial prostheses.
- Use the 4X46 lamination dummy when laminating. It must be ordered separately.



Lamination anchor with pyramid receiver and angled arm, rotatable

Reference number 4WR95=1

The 4WR95=1 lamination anchor is laminated into a prosthetic socket. It has an angled anchor arm intended for posterior positioning. This allows for easy positioning of the adapter in order to achieve optimal prosthetic alignment. It is waterproof and takes the flexion position of the residual limb/socket into account.

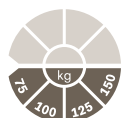

Max. 150 kg



Information material

647G123=ALL_INT IFU Lamination anchors

Scope of delivery

Article number	Description	Quantity	Unit
4WR95=1	Lamination anchor with pyramid receiver and angled arm	1	Piece
501Z2=M5X30	Cap screw (Allen screw)	1	Piece
507U16=5.2-NIRO	Rounded washer	1	Piece
506G3=M8X12-V	Grub screw	4	Piece
501T24=M5X25	Clamping screw, blue coated	1	Piece

Technical data

Article number	Material	System height	Build height	Weight	Max. body weight
4WR95=1	INOX stainless steel	44 mm	26 mm	165 g	150 kg

- Use the 4X46 Lamination Dummy when laminating. It must be ordered separately.

Accessories/spare parts for 4WR95=2, 4WR95=1



Lamination dummy

Reference number 4X46

The 4X46 lamination dummy should be used for laminating the lamination anchors.

Technical data

Article number

4X46



Rounded washer

Reference number 507U16

Technical data

Article number

507U16=5.2-NIRO



Clamping screw, blue coated

Reference number 501T24

Technical data

Article number

501T24=M5X25



Set screw

Reference number 506G3

The 506G3 set screws are intended for adapters with a pyramid receiver. They are available in various lengths. Set screws that are protruding or recessed too much should be replaced with appropriate ones.

Technical data

Article number	Length
506G3=M8X12-V	12 mm
506G3=M8X14	14 mm
506G3=M8X16	16 mm

Waterproof walking aids

Socket technologies



Shuttle lock, waterproof

Reference number 6A30

The shuttle lock is used to secure the liner in the prosthetic socket. It is suitable for trans-femoral and transtibial prostheses. The 6Y13=1 pin is included with this shuttle lock. All common liners with a distal connector can be used. The 6Y43 Skeo Pure silicone liner with no textile cover is recommended for the waterproof walking aid.

Key features

- Waterproof and corrosion-resistant
- Lightweight plastic housing for use in bathing prostheses
- Ratchet unit easy to unlock, even under tensile load

Technical data

Article number	Build height
6A30=20N	42 mm

Information material

647G1645=ALL_INT IFU 6A30=20N

Scope of delivery

6A30=20N	Shuttle lock, waterproof	1	Piece
6Y13=1	Pin	1	Piece

Accessories/spare parts for 6A30

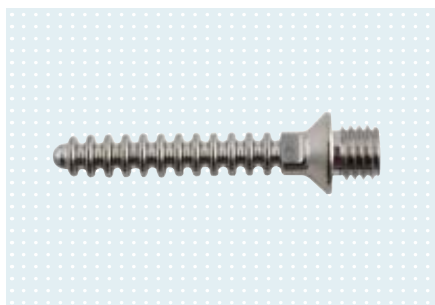



Pin for shuttle lock

Reference number 6Y13

The pin is a component of the shuttle lock and connects the shuttle lock to the liner. After being fully inserted into the shuttle lock, the pin is locked into place.

Technical data

Article image	Article number	Length
	6Y13=1	49.5 mm
	6Y13=2	31 mm
	6Y13=L1	68.7 mm



Ratchet unit

Reference number 6A52

This is a spare part for the 6A30=20N and 6A40 shuttle locks.

Technical data

Article number
6A52=K

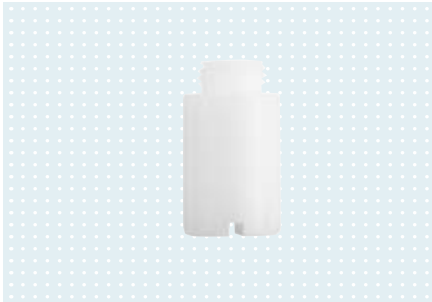

Plastic tab for 6A52

Reference number 6A61

This is a spare part for the 6A20=10, 6A20=20, 6A30=10N, 6A30=20N and 6A40 shuttle locks.

Technical data

Article number

6A61



Shuttle lock housing with bushing

Reference number 5X120

The 5X108 dummy set is a spare part for the 6A30=20 product.

Technical data

Article number

5X120



Set screw

Reference number 506G21

The 5X108 dummy set is a spare part for the 6A30=20 product.

Technical data

Article number

506G21=M4X10

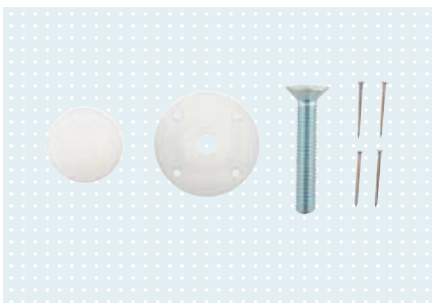

Dummy set

Reference number 5X108

This is a spare part for the 6A30=20N shuttle lock.

Technical data

Article number

5X108

Waterproof walking aids

Socket technologies



PushValve

Reference number 21Y14

The PushValve is opened and closed by pressing together two wings. With its larger size, it is particularly suitable for users with limited finger mobility and for arm prosthesis wearers. The valve is compatible with all common liners without a distal connector and can also be used without a liner.

Key features

- Waterproof
- Threadless valve for transfemoral prostheses
- Easier handling for users, in particular with limited finger mobility

Technical data

Article number	Air discharge	For hole Ø
21Y14	Automatic	22 mm

Information material

647G1560=ALL_INT IFU PushValve, MagValve

Scope of delivery

21Y14 PushValve 1 Piece



ClickValve

Reference number 21Y21

The ClickValve has a multi-option safety shackle that prevents loss of the upper valve part. The considerably reduced height and the outside diameter along with the unusual design ensure good cosmetic processing in the socket.

The valve is compatible with all common liners without a distal connector and can also be used without a liner.

Key features

- Waterproof
- Threadless valve for transfemoral prostheses
- Multi-option safety shackle prevents loss of the upper valve part
- The “click” provides audible feedback for proper valve positioning
- Risk of haematoma is alleviated thanks to lateral air exhaust openings and a flush inside socket surface

Technical data

Article number	Air discharge	For hole Ø
21Y21	Automatic	22 mm

Information material

647G678=ALL_INT IFU ClickValve

Scope of delivery

21Y21 ClickValve 1 Piece

Accessories/spare parts for 21Y14, 21Y21



Two-hole pin wrench

Reference number 21Y222

This is a service part for the valves with reference numbers 21Y12, 21Y14, 21Y15 and 21Y21.

Technical data

Article number

21Y222

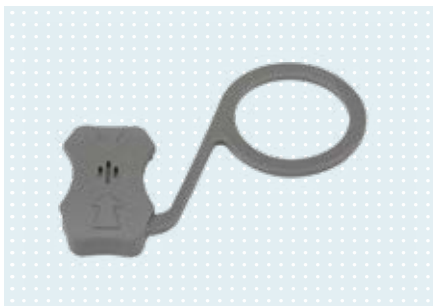

ClickValve safety shackle

Reference number 21Y230

This is a spare part for the 21Y21 ClickValve.

Technical data

Article number

21Y230



ClickValve base

Reference number 21Y21

This is a spare part for the 21Y21 ClickValve.

Technical data

Article number

21Y21=B

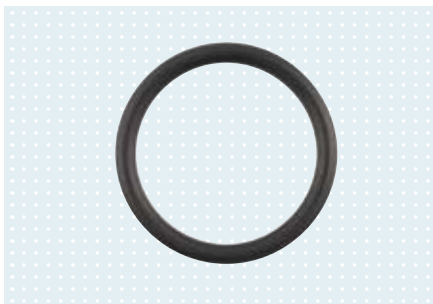

O-ring for ClickValve, black

Reference number 627F13

This is a spare part for the 21Y21 ClickValve.

Technical data

Article number

627F13=24.5X3

Waterproof walking aids

Socket technologies

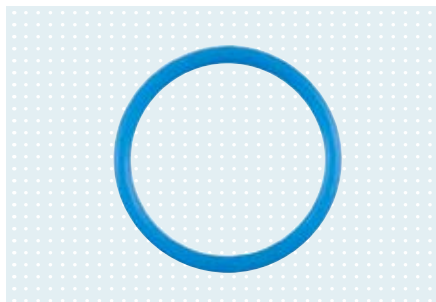

O-ring for ClickValve upper valve part, blue

Reference number 627F13

This is a spare part for the 21Y21 ClickValve.

Technical data

Article number

627F13=19X2



ClickValve

Reference number 21Y21

This is a spare part for the 21Y21 ClickValve.

Technical data

Article number

21Y21=T



PushValve upper part

Reference number 21Y14

This is a spare part for the 21Y14 PushValve.

Technical data

Article number

21Y14=S



Skeo Pure

Reference number 6Y41

The difference is clear. Thanks to its transparency, the Skeo Pure makes it easier to visually check the fit and skin condition, for example in case of interim fittings. The silky-smooth exterior dries quickly and makes it simple to put on and take off the prosthesis without donning spray.

The 6Y41 Skeo Pure (TT) can be combined with a valve.

Technical data

Article number	Size	Wall thickness
6Y41=160	160 mm	3 mm
6Y41=180	180 mm	3 mm
6Y41=200	200 mm	3 mm
6Y41=220	220 mm	3 mm
6Y41=235	235 mm	3 mm
6Y41=250	250 mm	3 mm
6Y41=265	265 mm	3 mm
6Y41=280	280 mm	3 mm
6Y41=300	300 mm	3 mm
6Y41=320	320 mm	3 mm
6Y41=340	340 mm	3 mm
6Y41=360	360 mm	3 mm
6Y41=380	380 mm	3 mm
6Y41=400	400 mm	3 mm
6Y41=160-6	160 mm	6 mm
6Y41=180-6	180 mm	6 mm
6Y41=200-6	200 mm	6 mm
6Y41=220-6	220 mm	6 mm
6Y41=235-6	235 mm	6 mm
6Y41=250-6	250 mm	6 mm
6Y41=265-6	265 mm	6 mm
6Y41=280-6	280 mm	6 mm
6Y41=300-6	300 mm	6 mm
6Y41=320-6	320 mm	6 mm
6Y41=340-6	340 mm	6 mm
6Y41=360-6	360 mm	6 mm
6Y41=380-6	380 mm	6 mm
6Y41=400-6	400 mm	6 mm

Information material

647G380=ALL_INT IFU Liners (qualified personnel)

Amputation level	Transtibial amputation
Material	Silicone
Connection	Without distal connection
Distal cushion	13.5 mm
Textile cover	without
Colour	Transparent
Exterior coating	with
Socket design	Specific weight-bearing socket
Matrix	without
Skinguard	without

Waterproof walking aids

Socket technologies



Skeo Pure

Reference number 6Y43

The difference is clear. Thanks to its transparency, the Skeo Pure makes it easier to visually check the fit and skin condition, for example in case of interim fittings. The silky-smooth exterior dries quickly and makes it simple to put on and take off the prosthesis without donning spray.

The 6Y43 Skeo Pure can be combined with a shuttle lock.

Information material

647G380=ALL_INT

IFU Liners (qualified personnel)

Technical data

Article number	Size
6Y43=120	120 mm
6Y43=140	140 mm
6Y43=160	160 mm
6Y43=180	180 mm
6Y43=200	200 mm
6Y43=210	210 mm
6Y43=220	220 mm
6Y43=235	235 mm
6Y43=250	250 mm
6Y43=265	265 mm
6Y43=280	280 mm
6Y43=300	300 mm
6Y43=320	320 mm
6Y43=340	340 mm
6Y43=360	360 mm
6Y43=380	380 mm
6Y43=400	400 mm
6Y43=420	420 mm
6Y43=450	450 mm
Amputation level	Transtibial amputation
Material	Silicone
Connection	With distal connection
Distal cushion	Approx. 13.5 mm
Wall thickness	3 mm
Textile cover	without
Colour	Transparent
Exterior coating	with
Socket design	Specific weight-bearing socket
Matrix	10 cm length
Skinguard	without



Aqua knee

Reference number 3WR95

The waterproof, monocentric Aqua knee is compact, lightweight and equipped with miniature hydraulics and an integrated lock. Since safety is the top priority, mechanisms for standing securely are particularly important in wet areas. The 3WR95 Aqua knee is easy and straightforward to lock for activities in and around the water using the integrated locking mechanism.

Technical data

Article number	3WR95
Max. body weight	150 kg
Weight	400 g
Proximal connection	Pyramid
Distal connection	Pyramid
Knee flexion angle	135 °
System height	62 mm
Proximal system height to alignment reference point	6 mm
Distal system height to alignment reference point	56 mm
Build height	98 mm
Proximal build height to alignment reference point	24 mm
Distal build height to alignment reference point	74 mm

Information material

647G818=ALL_INT	IFU 3WR95
-----------------	-----------

Scope of delivery

3WR95		1	Piece
4G764	Adjusting tool	1	Piece





Knee joint, monocentric, with rotation hydraulics

Reference number 3R80

The monocentric knee joint and its unique principle of rotation hydraulics allow users to closely approximate a physiological gait pattern, descend stairs step-over-step and walk down slopes. The 3R80 is a waterproof design for wet areas and is approved for a body weight of up to 150 kg.

Technical data

Article image	3R80	3R80=ST
		
Article number	3R80	3R80=ST
Max. body weight	150 kg	150 kg
Mobility grade	3, 4	3, 4
Weight	1240 g	1255 g
Proximal connection	Pyramid	Threaded connector
Distal connection	Tube clamp Ø 34 mm	Tube clamp Ø 34 mm
Knee flexion angle	150 °	150 °
System height	163 mm	179 mm
Proximal system height to alignment reference point	28 mm	44 mm
Distal system height to alignment reference point	135 mm	135 mm
Build height	218 mm	216 mm
Proximal build height to alignment reference point	46 mm	44 mm
Distal build height to alignment reference point	172 mm	172 mm

Information material

647G403=ALL_INT	IFU 3R80
646D1533=ALL_INT	Quick reference guide 3R80

Scope of delivery

3R80	Knee joint, monocentric, with rotation hydraulics	1	Piece
2R58	Tube Adapter, long, 34 mm, Titanium	1	Piece
710H10	Adjustment wrench	1	Piece

Waterproof walking aids

Knee joints

Accessories/spare parts for 3WR95, 3R80



Adjusting tool

Reference number 4G764

This is a spare part for the 3R95 and 3WR95.

Technical data

Article number

4G764



Tube adapter

Reference number 2R57/2R58

The 2R57 and 2R58 tube adapters differ in length. They connect prosthetic components to each other. Adapter combinations allow for controlled angle and translational adaptation in the sagittal and frontal plane as well as adjustment of inward and outward rotation. The 2R57 and 2R58 are resistant to fresh, salt and chlorinated water.

Technical data

Article number	Diameter	Material	Min. system height	Max. system height	Min. build height	Overall length	Weight	Max. body weight
2R57	34 mm	Titanium	77 mm	282 mm	27 mm	264 mm	220 g	150 kg
2R58	34 mm	Titanium	77 mm	472 mm	27 mm	454 mm	330 g	150 kg

You will find additional waterproof products in the sections on prosthetic feet, adapters and knee joints.



Sports prostheses



Sports prostheses

Prosthetic feet, adapters and knee joints



Sprinter

Reference number 1E90

The 1E90 Sprinter is intended for athletes with a body weight of up to 125 kg and has proven itself in international competition as the sports foot of choice for outstanding performance.

Key features

- Distinguished by its low weight
- The spring contour provides high propulsion and low resistance
- Available in different stiffness variants corresponding to the body weight of the user



Max. 125 kg

Information material

647G849=ALL_INT	IFU Sprinter
646D1563=ALL_INT	QRG for 3S80, 1E90
647G1664=ALL_INT	QRG for 4R208, 4R210

Scope of delivery

1E90	Sprinter	1	Piece
------	----------	---	-------

Official Supplier of



Technical data

Suitable for	Jogging and sprints
Max. body weight	125 kg
Sizes	Universal
Weight	550-675 g

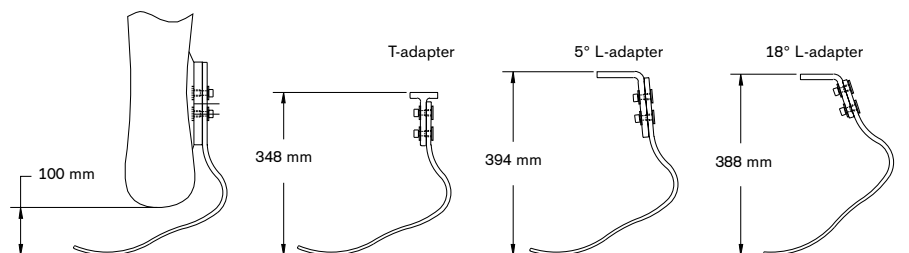

Stiffness chart

Stiffness version	Short-distance running	Long-distance running
1E90 Sprinter	Body weight	Body weight
SPR-1	40 to 52 kg	40 to 59 kg
SPR-2	53 to 63 kg	60 to 70 kg
SPR-3	64 to 79 kg	71 to 86 kg
SPR-4	80 to 95 kg	87 to 102 kg
SPR-5	96 to 111 kg	103 to 118 kg
SPR-6	112 to 125 kg	119 to 125 kg

Order example

Reference number	= SPR	- Stiffness	- S	- N
1E90	= SPR	- 3	- S	- N

Accessories/spare parts for 1E90



Information material

647G981=ALL_INT	IFU 4R212
647G1663=ALL_INT	QRG 4R212

TT test sports foot adapter

Reference number 4R212

The 4R212 TT test sports foot adapter facilitates the alignment of a TT test sports prosthesis in connection with the user's everyday prosthetic socket, the 1E90 prosthetic foot and appropriate adapters. This lets the user gain initial experience with a sports prosthesis.



Max. 100 kg

Technical data

Article number	Material	Weight	Max. body weight
4R212	Aluminium	870 g	100 kg



Information material

647G840=ALL_INT	IFU 4R208 4R210
647G1664=ALL_INT	QRG 4R208 4R210

TT test sports foot adapter

Reference number 4R210

The 4R210 TT test sports foot adapter may only be used for fitting purposes and helps select the appropriate 1E90 Sprinter model. The prosthetic foot is inserted into the adapter and can be moved vertically. This helps determine the appropriate height and length of the foot before shortening it accordingly.



Max. 100 kg

Technical data

Article number	Material	Weight	Max. body weight
4R210	Aluminium	385 g	100 kg



Information material

647G840=ALL_INT	IFU 4R208 4R210
647G1664=ALL_INT	QRG 4R208 4R210

TT definitive sports foot adapter

Reference number 4R208

Once the right 1E90 Sprinter model has been selected and shortened to the definitive length and height, the 4R210 TT test sports foot adapter is replaced by the 4R208 TT definitive sports foot adapter in the definitive prosthesis.



Max. 100 kg

Technical data

Article number	Material	Weight	Max. body weight
4R208	Aluminium	285 g	100 kg

Sports prostheses

Prosthetic feet, adapters and knee joints



Posterior connection plate (set)

Reference number 4R420

The set can be used for direct lamination in transtibial prostheses.



Max. 125 kg

Technical data

Article number	Max. body weight
4R420	125 kg



T-adapter

Reference number 2R176

The T-adapter can be used for direct lamination in transtibial prostheses.



Max. 125 kg

Technical data

Article number	Max. body weight
2R176=T	125 kg



TF test sports foot adapter

Reference number 4R206

The 4R206 TF test sports foot adapter in combination with an appropriate socket adapter (e.g. 4R77 or 4R51) connects the 1E90 Sprinter prosthetic sports foot to a prosthetic sports knee joint (e.g. 3S80). It may only be used for trial fitting purposes and helps select the appropriate 1E90 Sprinter model.



Max. 100 kg

Information material

647G839=ALL_INT IFU 4R204 4R206

Technical data

Article number	Material	System height	Build height	Weight	Max. body weight
4R206	Aluminium	2 mm	2 mm	580 g	100 kg



TF definitive sports foot adapter

Reference number 4R204

Once the right 1E90 Sprinter model has been selected and shortened to the definitive length and height, the 4R206 TF test sports foot adapter is replaced by the 4R204 TF definitive sports foot adapter in the definitive prosthesis.



Max. 100 kg

Information material

647G839=ALL_INT IFU 4R204 4R206

Technical data

Article number	Material	System height	Build height	Weight	Max. body weight
4R204	Aluminium	2 mm	2 mm	440 g	100 kg



L-adapter

Reference number 2R177

The L-adapter can be used in transfemoral prostheses and optionally in transtibial prostheses.



Max. 125 kg

Technical data

Article number	Angle	Max. body weight
2R177=5	5 °	125 kg
2R177=18	18 °	125 kg



Sprinter universal sole

Reference number 2Z500

The 2Z500 Sprinter universal sole with a running shoe tread is suitable for running on a variety of surfaces.

Technical data

Article number
2Z500

Information material

647G848=ALL_INT IFU 2Z500 2Z501

Sports prostheses

Prosthetic feet, adapters and knee joints



Sprinter spike sole

Reference number 2Z501

The 2Z501 Sprinter spike sole is suitable for fast sprints and running on all-weather tracks.

Technical data

Article number

2Z501

Information material

647G848=ALL_INT

IFU 2Z500 2Z501



Safeguard sticker for 1E90 Sprinter

Reference number 2Z358

The safeguard stickers for the 1E90 are rubbery labels that can be applied to the carbon spring of the Sprinter foot to protect it against damage and signs of use caused by impacts. A quick start guide for applying the safeguard stickers is included in the scope of delivery.

Technical data

Article number

2Z358



Runner

Reference number 1E91

From relaxed jogging along forest trails to powerful sprints – the 1E91 Runner proves itself as an ideal running prosthesis for recreational and competitive athletes.

Key features

- Characterised by a resilient, lightweight carbon spring that provides runners with a high level of propulsion and enhanced stability when turning corners
- By moving the adapter along the carbon spring, the dynamic response of the running prosthesis can be adapted to the individual needs of the user
- Both trial and definitive fittings are especially straightforward thanks to flexible adjustment possibilities and the connection to the modular prosthesis solution
- Available in different stiffness variants corresponding to the body weight of the user
- Choice of two sole types (universal sole and spike sole)

Information material

647G1145=ALL_INT IFU 1E91 1E93

Scope of delivery

1E91 Runner 1 Piece

Official Supplier of



Max. 104 kg

Technical data

Suitable for	Jogging and sprints
Max. body weight	104 kg
Sizes	Universal
Weight	460–585g
Build height	30 cm
Build height, loaded	27 cm

Stiffness chart

Body weight	Stiffness version for long-distance running	Stiffness version for sprint
40 to 50 kg	SPR-1	SPR-2
51 to 60 kg	SPR-2	SPR-3
61 to 72 kg	SPR-3	SPR-4
73 to 86 kg	SPR-4	SPR-5
87 to 104 kg	SPR-5	–

Order example

Reference number	= SPR	- Stiffness	- S	- N-6
1E91	= SPR	- 3	- S	- N-6

Sports prostheses

Prosthetic feet, adapters and knee joints

Accessories/spare parts for 1E91



Information material

647G1176=ALL_INT IFU 4R216 4R218 4R224

Runner adapter with pyramid, rotatable

Reference number 4R218

The pyramid of the 4R218=6 connection adapter can be rotated to any position and makes it easier to adjust the prosthesis to suit the user. Overall, the adapter stands out for its light weight and robustness.



Technical data

Article number	Material	System height	Build height	Weight	Max. body weight
4R218=6	Aluminium, Stainless steel	2 mm	23 mm	180 g	125 kg



Information material

647G1176=ALL_INT IFU 4R216 4R218 4R224

Runner four-hole adapter

Reference number 4R216

The 4R216=6 Runner four-hole adapter can be used in combination with a socket adapter with pyramid receiver (4R51 or 4R55). Among other things, it therefore permits a direct connection to the 3S80 knee joint with a low build height.



Technical data

Article number	Material	System height	Build height	Weight	Max. body weight
4R216=6	Aluminium	13 mm	31 mm	175 g	125 kg



Runner universal sole

Reference number 2Z540

The 2Z540=6 Runner sole is a classic all-rounder for terrain such as asphalt, gym floors and nature trails.

Technical data

Article number	Build height	Weight
2Z540=6	15 mm	160 g

Information material

647G1177=ALL_INT IFU 2Z540 2Z541 2Z543



Runner spike sole

Reference number 2Z541

The 2Z541=6 Runner spike sole is particularly suitable for fast sprinting or running on all-weather tracks.

Technical data

Article number	Build height	Weight
2Z541=6	12 mm	135 g

Information material

647G1177=ALL_INT IFU 2Z540 2Z541 2Z543

Sports prostheses

Prosthetic feet, adapters and knee joints



Runner junior

Reference number 1E93

The Runner junior is suitable for active children and adolescents who love sports and weigh up to 45 kg. In addition to participation in physical education, the Runner junior supports age-appropriate development and allows children to experience the joy of movement in their social environment.

Key features

- Characterised by a resilient, lightweight carbon spring that provides runners with a powerful drive and stable turning characteristics
- By moving the adapter along the carbon spring, the dynamic response of the running prosthesis can be adapted to the individual needs of the user
- Both trial and definitive fittings are especially straightforward thanks to flexible adjustment possibilities and the connection to the modular prosthesis solution
- Available in different stiffness variants corresponding to the body weight of the user

Information material

647G1145=ALL_INT IFU 1E91 1E93

Scope of delivery

1E93 Runner junior 1 Piece

Technical data

Max. body weight	45 kg
Sizes	Universal
Weight	170–210 g
Build height	18.5 cm
Build height, loaded	16 cm

Stiffness chart

Body weight	Stiffness version
15 to 20 kg	SPR-1
21 to 25 kg	SPR-2
26 to 30 kg	SPR-3
31 to 37 kg	SPR-4
38 to 45 kg	SPR-5

Order example

Reference number	=	SPR	-	Stiffness	-	S	-	N-6
1E93	=	SPR	-	3	-	S	-	N-6

Accessories/spare parts for 1E93



Runner junior adapter with pyramid, rotatable

Reference number 4R224

The pyramid of the 4R224=6 connection adapter can be rotated to any position and makes it easier to adjust the prosthesis to suit the user. Overall, the adapter stands out for its light weight and robustness.



Information material

647G1176=ALL_INT IFU 4R216 4R218 4R224

Technical data

Article number	Material	System height	Build height	Weight	Max. body weight
4R224=6	Aluminium, Stainless steel	2 mm	21 mm	175 g	45 kg



Runner junior sole

Reference number 2Z543

The 2Z543=6 Runner junior universal sole provides an excellent grip, making it suitable for running on a variety of surfaces – from grass to asphalt.

Technical data

Article number	Build height	Weight
2Z543=6	13 mm	90 g

Information material

647G1177=ALL_INT IFU 2Z540 2Z541 2Z543

Sports prostheses

Prosthetic feet, adapters and knee joints



Challenger

Reference number 1E95

For amateur and professional athletes weighing up to 110 kg who participate in running, field and racket sports, the 1E95 Challenger prosthetic fitness foot is a great option. It is also suitable for everyday use.

Key features

- Suitable for various sports (such as tennis, basketball, jogging)
- Good shock absorption and high energy return
- Heel provides stability during standing and walking (base spring)
- Replaceable heel wedges for adaptable rollover characteristics
- Waterproof



Max. 110 kg

Information material

647G973=ALL_INT IFU Challenger

Scope of delivery

1E95	Challenger	1	Piece
2F95	Heel wedge set	1	Set
2Z95	Forefoot pad	1	Piece
2C101	Footshell replacement tool, plastic	1	Piece

Official Supplier of



Technical data

Suitable for	Running, field and racket sports
Max. body weight	110 kg
Side	neutral (N)
Sizes	23-30 cm
Weight*	785 g
Footshell	No footshell is required, can only be used in the shoe, for a heel height of 10 +/- 5 mm
System height with adapter	156 mm
Build height with adapter	174 mm

* Technical data refer to the size of 25/26 cm

Stiffness chart

Foot size	Foot size							
	23 cm	24 cm	25 cm	26 cm	27 cm	28 cm	29 cm	30 cm
Body weight								
50-70 kg	2		2		2			
71-90 kg			3		3		3	
91-110 kg			4		4		4	

Order example

Reference number	= Side	Size range	- Stiffness	- P / 0
1E95	= N	2526	- 3	- P / 0

Challenger

Get in the game.

Waterproof and corrosion-resistant components

With the Challenger, users can easily spend time outdoors or play sports on the beach, even in poor weather conditions.



Main carbon fibre spring

Thanks to the unique design of its main spring, the Challenger stands out with its good impact damping characteristics and efficient energy return that will support the user during field and racket sports as well as during jogging.

Basic spring for added stability

With its combination of a base spring and heel wedge, the Challenger offers users greater control and therefore an enhanced level of stability – for sudden movements as well as during walking and standing.

Replaceable heel wedge

The Challenger features a flexible heel wedge with varying degrees of stiffness. Depending on the sports and level of strain, users can adapt the heel and rollover characteristics themselves to their individual requirements in just one easy step.

Sports prostheses

Prosthetic feet, adapters and knee joints

Accessories/spare parts for 1E95



Heel wedge set

Reference number 2F95

The 2F95 heel wedge set contains two heel wedges tailored to the user's weight. An additional heel wedge set can be ordered if needed.

Technical data

Article number	Recommended for body weight	Stiffness
2F95=2330-2	50-70 kg	30 35
2F95=2330-3	71-110 kg	40 45

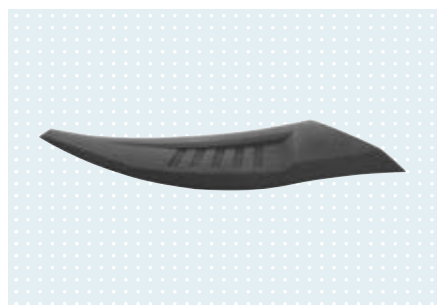

Forefoot pad

Reference number 2Z95

The 2Z95 forefoot pad ensures a more secure hold in the sports shoe.

Technical data

Article number	Size
2Z95=2330	23-30 cm



Footshell replacement tool, plastic

Reference number 2C101

The 2C101 shoehorn is a plastic tool for replacing the footshell on prosthetic feet. In addition to a grey marble look, the shoehorn has a hole to hang it up.

Technical data

Article number	Material
2C101	Plastic



ProCarve prosthetic foot

Reference number 1E2/1E2=1

The 1E2 ProCarve prosthetic sports foot is an outstanding solution for recreational and professional athletes with leg amputations. The foot offers functionality for skiing and snowboarding as well as other types of sports with similar movement patterns, such as wakeboarding or water skiing.

Key features

- The ProCarve foot can be used as an independent unit or in combination with the 3R2 ProCarve knee joint
- It is connected directly to the ski binding or combined with a shell designed specifically for snowboard boots
- The damping element – a combination of a pneumatic spring and a hydraulic unit – ensures a dynamic movement sequence. The individually adjustable air pressure controls the flexion movement, and the hydraulics dampen the extension movement.
- The foot includes a high-performance, robust damping unit for controlling movement around the pivot point
- A second version of the foot (1E2=1) offers increased stiffness, which is most beneficial for advanced skiers with transtibial amputations.
- Robust, low-wearing and waterproof

Information material

647G951=ALL_INT	IFU 1E2 3R2
647G953=ALL_INT	ProCarve quick reference guide

Scope of delivery

1E2/1E2=1	ProCarve prosthetic foot	1	Piece
4G901	Footshell	1	Piece
4G115	Blocking clip ProCarve foot	1	Piece
755Y68	High-pressure air pump	1	Piece



Max. 100 kg

Technical data

Article number	Size	Weight	Max. body weight	System height
1E2	One size	1550 g	100 kg	120 mm (with add-on part for ski binding), 103 mm (with footshell)
1E2=1	One size	1550 g	100 kg	120 mm (with add-on part for ski binding), 103 mm (with footshell)

Sports prostheses

Prosthetic feet, adapters and knee joints

Accessories/spare parts for 1E2/1E2=1



Footshell

Reference number 4G901

Shaped for snowboard boots.

Technical data

Article number
4G901



Blocking clip ProCarve foot

Reference number 4G115

Enables walking without spring action of the 1E2/1E2=1 ProCarve foot.

Technical data

Article number	Spare part for
4G115=1	1E2



High-pressure air pump

Reference number 755Y68

For adjusting the air pressure.

Technical data

Article number	Spare part for
755Y68	1E2
	1E2=1



Sole set

Reference number 2Z503

Similar to the standard ski boot soles for an improved grip while walking.

Technical data

Article number	Spare part for
2Z503=1	1E2
	1E2=1



Sports knee joint

Reference number 3S80

The patented principle of rotation hydraulics already familiar from the 3R80 prosthetic knee joint is also used in a modified form in the 3S80 Sport. The rotation hydraulics in the 3S80=1 product variant contain oil with a lower viscosity than the standard 3S80 product variant. Due to its lower oil viscosity, the 3S80=1 is particularly well suited for applications demanding maximum ease of movement in the swing phase, for example sport prostheses for children or prostheses used for sprinting.

Key features

- Optimal swing phase control for running
- Extension damping throughout the entire extension movement ensures harmonious extension even at high stride rates
- Flexion and extension damping can be adjusted separately and individually
- Larger flexion angle for jogging and sprinting is precisely controlled by flexion damping
- Manual lock

Information material

647G813=ALL_INT	IFU 3S80
646D1563=ALL_INT	QRG for 3S80, 1E90

Scope of delivery

3S80		1	Piece
710H10	Adjustment wrench	1	Piece



Max. 100 kg

Official Supplier of



Technical data

Article number	3S80	3S80=1
Max. body weight	100 kg	100 kg
Weight	682 g	682 g
Proximal connection	Pyramid	Pyramid
Distal connection	Pyramid	Pyramid
Range	135 °	135 °
System height	48 mm	48 mm
Proximal system height to alignment reference point	28 mm	28 mm
Distal system height to alignment reference point	20 mm	20 mm
Build height	84 mm	84 mm
Proximal build height to alignment reference point	46 mm	46 mm
Distal build height to alignment reference point	38 mm	38 mm

Sports prostheses

Prosthetic feet, adapters and knee joints



ProCarve knee joint

Reference number 3R2

The ProCarve is a monocentric sports knee joint made of aluminium and is ideal for both amateur and professional athletes with lower limb amputations. The knee and foot system with damping offers targeted, coordinated functionality for skiing, snowboarding and other sports with similar movement patterns such as wakeboarding or water skiing.

Key features

- The ProCarve knee joint is equipped with a high-performance damping element for dynamic motion sequences.
- The unlocking function makes sitting comfortable (e.g. on a ski lift).
- The damping element – a combination of a pneumatic spring and a hydraulic unit – ensures a dynamic movement sequence. The individually adjustable air pressure controls the flexion movement, and the hydraulics dampen the extension movement.
- Together with the ProCarve foot component, this provides a targeted and coordinated system solution for users with a transfemoral amputation or knee disarticulation.
- Robust, low-wearing and waterproof.

Information material

647G951=ALL_INT	IFU 1E2 3R2
647G953=ALL_INT	ProCarve quick reference guide

Scope of delivery

3R2	ProCarve	1	Piece
4G115	Locking clip	1	Piece



Max. 100 kg

Technical data

Article number	3R2
Max. body weight	100 kg
Weight	2150 g
Proximal connection	Pyramid
Distal connection	Pyramid
Flexion angle (unlocked)	80 °
Flexion angle (locked)	67 °
System height	241 mm
Proximal system height to alignment reference point	34 mm
Distal system height to alignment reference point	207 mm
Build height	277 mm
Proximal build height to alignment reference point	52 mm
Distal build height to alignment reference point	225 mm

Accessories/spare parts for 3R2



Locking clip

Reference number 4G115

Enables walking without spring action of the 3R2 ProCarve prosthetic knee joint.

Technical data

Article number	Spare part for
4G115	3R2



Prosthetic feet



Prosthetic feet

Article no. structure

Article number structure for Ottobock prosthetic feet

The article number structure was established to facilitate the unambiguous ordering of prosthetic feet in the different versions. For prosthetic feet offered in various colours or versions, additional codes specify those characteristics.

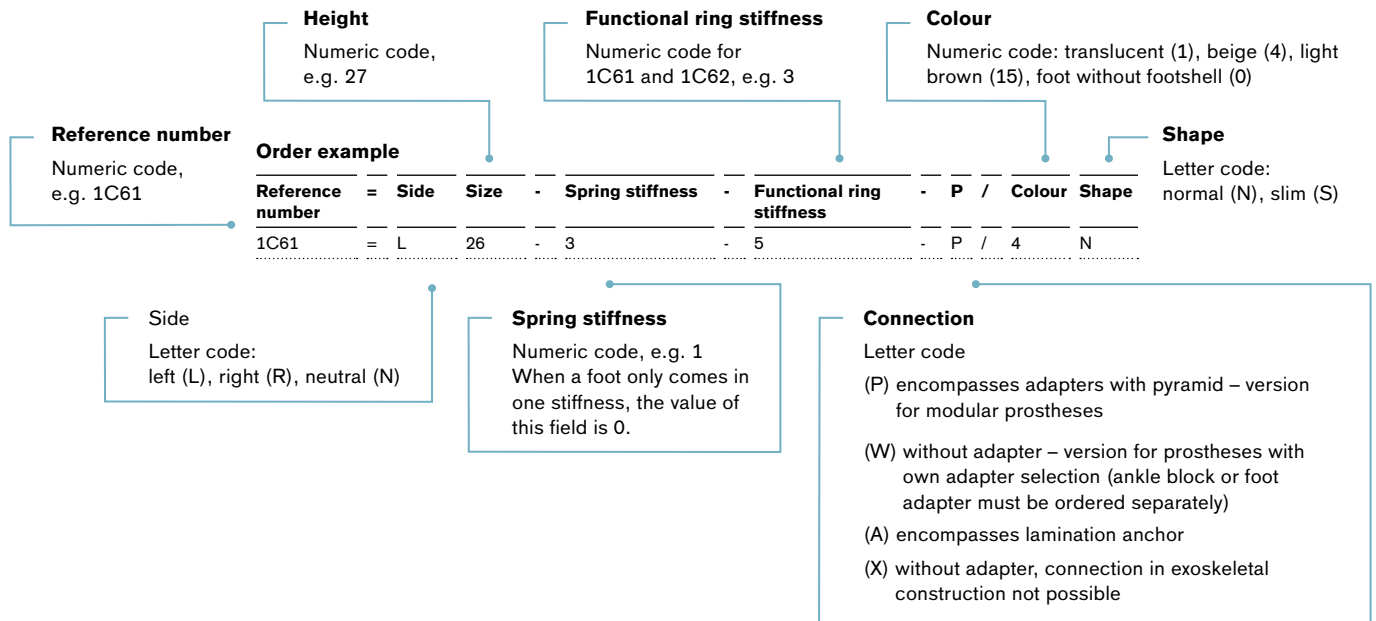



Lightweight cosmetic foot

Reference number 1G6

The 1G6 lightweight cosmetic foot was specially designed for users who are less active. It is appropriate for all amputation levels in the treatment of geriatric patients.

Key features

- Lightweight
- Secure heel strike
- Natural shape with a smooth surface and a separate big toe



Max. 75 kg

Information material

647G448=ALL_INT IFU 1G6

Scope of delivery

1G6 Lightweight cosmetic foot 1 Piece

Technical data

Mobility grade	1
Max. body weight	75 kg
Side	left (L), right (R)
Sizes	23-27 cm
Weight without adapter*	330 g
Foot shape	Normal shape for a heel height of 10 +/- 5 mm
Colour	beige
System height with adapter*	67 mm
Build height with adapter*	85 mm

* Technical data refer to the size of 26 cm

Order example

Reference number	Side	Size
1G6	L	26

Accessories/spare parts for 1G6



Foot adapter with screw connection, aluminium

Article number 2R54=M8

The 2R54 foot adapter made of aluminium connects the SACH, SACH+, 1G6 and Dynamic prosthetic feet to the distal connector of a modular prosthesis.



Max. 100 kg

Information material

647G5=ALL_INT IFU 2R8 2R31 2R54

Technical data

Article number	Max. body weight	Weight
2R54=M8	100 kg	70 g

Prosthetic feet

Mobility grade 1



Foot adapter with screw connection, titanium

Article number 2R31=M8

The 2R31 foot adapter made of titanium connects the SACH, SACH+, 1G6 and Dynamic prosthetic feet to the distal connector of a modular prosthesis.



Max. 100 kg

Information material

647G5=ALL_INT

IFU 2R8 2R31 2R54

Technical data

Article number	Max. body weight	Weight
2R31=M8	100 kg	65 g

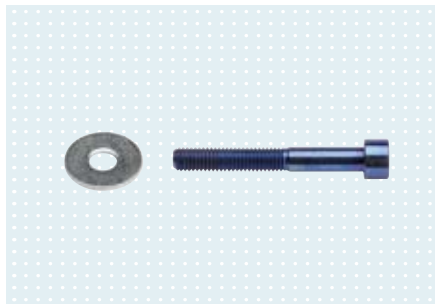

Screw connection foot adapter 2R31=M8, 2R54=M8

Article number 2D7=M8

The spare parts set is used for the screw connection of the 2R31 and 2R54 foot adapters with the corresponding prosthetic feet.

Technical data

Article number	Spare part for
2D7=M8	2R31=M8 2R54=M8

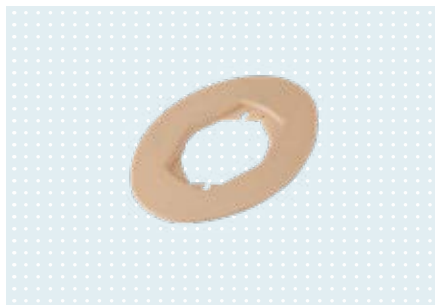

Connection plate

Reference number 2R14

The 2R14 connection plate facilitates the fabrication of cosmetic prostheses and forms the transition from the foam cover to the adapter. It is bonded to the foam cover and then pressed onto the adapter.

Technical data

Article number
2R14



Single-axis foot with toes

Reference number 1H38

In combination with the single-axis joint, the 1H38 single-axis foot with 10 mm heel height allows the user to achieve a secure stance quickly. It is only suitable for transfemoral prostheses.

Key features

- Natural shape with smooth surface and defined toes



Max. 100 kg

Information material

647G45=ALL_INT IFU 1H38 1H40

Scope of delivery

1H38 Single-axis foot with toes 1 Piece

Technical data

Mobility grade	1
Max. body weight	100 kg
Side	left (L), right (R)
Sizes	21-28 cm
Weight without adapter*	ca. 365 g
Foot shape	Normal shape for a heel height of 10 +/- 5 mm
Colour	beige
System height with 2R51, 2R33/2R10*	50 mm, 46 mm
Build height with 2R51, 2R33/2R10*	68 mm, 64 mm

* Technical data refer to the size of 26 cm

- For the 1H38 in size 21 cm, please use the available options for size 22 cm.

Order example

Reference number	= Side	Size
1H38	= L	26

Prosthetic feet

Mobility grade 1



Single-axis foot with toes

Reference number 1H40

In combination with the single-axis joint, the 1H40 single-axis foot with 25 mm heel height allows the user to achieve a secure stance quickly. It is only suitable for transfemoral prostheses.

Key features

- Natural shape with smooth surface and defined toes



Max. 100 kg

Information material

647G45=ALL_INT IFU 1H38 1H40

Scope of delivery

1H40 Single-axis foot with toes 1 Piece

Technical data

Mobility grade	1
Max. body weight	100 kg
Side	left (L), right (R)
Sizes	22-29 cm
Weight without adapter*	ca. 400 g
Foot shape	Normal shape for a heel height of 25 +/- 5 mm
Colour	beige
System height with 2R51, 2R33/2R10*	50 mm, 46 mm
Build height with 2R51, 2R33/2R10*	68 mm, 64 mm

* Technical data refer to the size of 26 cm

Order example

Reference number	= Side	Size
1H40	= L	26

Accessories/spare parts for 1H38, 1H40



Information material

647G1630=ALL_INT IFU 2R10 2R33 2R51

Single-axis foot adapter with screw connection

Reference number 2R51

The 2R51 single-axis foot adapter made of aluminium connects a single-axis prosthetic foot to the distal connector of a modular prosthesis.



Max. 100 kg

Technical data

Article number	Size	Max. body weight	Weight
2R51=22-25	22 - 25 cm	100 kg	230 g
2R51=26-27	26 - 27 cm	100 kg	235 g



Information material

647G1630=ALL_INT IFU 2R10 2R33 2R51

Single-axis foot adapter with screw connection

Reference number 2R33

The 2R33 single-axis foot adapter made of titanium connects a single-axis prosthetic foot to the distal connector of a modular prosthesis.



Max. 100 kg

Technical data

Article number	Size	Max. body weight	Weight
2R33=22-25	22 - 25 cm	100 kg	200 g
2R33=26-30	26 - 30 cm	100 kg	210 g



Information material

647G1630=ALL_INT IFU 2R10 2R33 2R51

Single-axis foot adapter with screw connection

Reference number 2R10

The 2R10 single-axis foot adapter made of steel connects a single-axis prosthetic foot to the distal connector of a modular prosthesis.



Max. 100 kg

Technical data

Article number	Size	Max. body weight	Weight
2R10=22-25	22 - 25 cm	100 kg	325 g
2R10=26-30	26 - 30 cm	100 kg	340 g

Prosthetic feet

Mobility grade 1



Dorsal stop set

Reference number 2S88

The 2S88 dorsal stop set is required for prostheses with the 2R51 single-axis foot adapter. It permits flexible dorsal movement and consists of a hard and a soft blank.

Technical data

Article number	Size range
2S88=22-23	22-23 cm
2S88=24-25	24-25 cm
2S88=26-27	26-27 cm



Connection cap

Reference number 2R22

The 2R22 connection cap facilitates the cosmetic covering of the 1H* single-axis feet. It is bonded to the foam cover then pressed onto the apron of the foot.

Technical data

Article number	Sizes
2R22=*	22-30 cm



Single component pack for single-axis feet

Reference number 2D5

The 2D5 spare parts pack consists of spare parts for the screw connection of the single-axis feet.

Technical data

Article number	Spare part for
2D5	2R10=22-25
	2R10=26-30
	2R33=22-25
	2R33=26-30
	2R51=22-25
	2R51=26-27



SACH foot

Reference number 1S90

With its functional properties, the 1S90 SACH foot has proven itself for users in mobility grades 1–2 with a body weight of up to 125 kg.

Key features

- The functional properties are achieved through the combination of a contoured wooden core and functional foam
- Natural-looking standard foot shape, smooth surface, defined toes and a separate big toe



Max. 100 kg
Size 22 to 25 cm



Max. 125 kg
Size 26 to 28 cm

Information material

647G355=ALL_INT IFU SACH Feet

Scope of delivery

1S90 SACH foot 1 Piece

Technical data

Mobility grade	1, 2
Max. body weight	125 kg
Side	left (L), right (R)
Sizes	22-28 cm
Weight without adapter*	460 g
Foot shape	Normal shape for a heel height of 10 +/- 5 mm
Colour	beige (4)
System height with adapter*	67 mm
Build height with adapter*	85 mm

* Technical data refer to the size of 26 cm

Order example

Reference number	=	Side	Size	-	0	-	W	/	Colour
1S90	=	L	26	-	0	-	W	/	4

Prosthetic feet

Mobility grade 1–2



SACH foot

Reference number 1S49

The 1S49 SACH foot has a heel height of about 10 mm. The functional properties are achieved through the proven combination of a contoured core and functional foam.

Key features

- Natural-looking standard foot shape with a smooth surface and defined toes



Max. 100 kg
Size 21 to 25 cm



Max. 125 kg
Size 26 to 28 cm

Information material

647G355=ALL_INT IFU SACH Feet

Scope of delivery

1S49 SACH foot 1 Piece

Technical data

Mobility grade	1, 2
Max. body weight	125 kg
Sizes	21-28 cm
Side	left (L), right (R)
Weight without adapter*	475 g
Foot shape	Normal shape for a heel height of 10 +/- 5 mm
Colour	beige
System height with adapter*	67 mm
Build height with adapter*	85 mm

* Technical data refer to the size of 26 cm

Order example

Reference number	= Side	Size
1S49	= L	26



SACH foot

Reference number 1S66

The 1S66 SACH foot has a heel height of about 18 mm. The functional properties are achieved through the proven combination of a contoured core and functional foam.

Key features

- Natural-looking standard foot shape with a smooth surface and defined toes



Max. 100 kg
Size 22 to 25 cm



Max. 125 kg
Size 26 to 30 cm

Information material

647G355=ALL_INT IFU SACH Feet

Scope of delivery

1S66 SACH foot 1 Piece

Technical data

Mobility grade	1, 2
Max. body weight	125 kg
Side	left (L), right (R)
Sizes	22-30 cm
Weight without adapter*	485 g
Foot shape	Normal shape for a heel height of 18 +/- 5 mm
Colour	beige
System height with adapter*	67 mm
Build height with adapter*	85 mm

* Technical data refer to the size of 26 cm

Order example

Reference number	=	Side	Size
1S66	=	L	26

Prosthetic feet

Mobility grade 1–2

Accessories/spare parts for 1S90, 1S49, 1S66



Information material

647G5=ALL_INT IFU 2R8 2R31 2R54

Foot adapter with screw connection, aluminium

Article number 2R54=M10

The 2R54 foot adapter made of aluminium connects the SACH, SACH+, 1G6 and Dynamic prosthetic feet to the distal connector of a modular prosthesis.

Technical data

Article number	Max. body weight	Weight
2R54=M10	100 kg	80 g



Information material

647G5=ALL_INT IFU 2R8 2R31 2R54

Foot adapter with screw connection, titanium

Article number 2R31=M10

The 2R31 foot adapter made of titanium connects the SACH, SACH+, 1G6 and Dynamic prosthetic feet to the distal connector of a modular prosthesis.

Technical data

Article number	Max. body weight	Weight
2R31=M10	136 kg	70 g



Information material

647G5=ALL_INT IFU 2R8 2R31 2R54

Foot adapter with screw connection, steel

Article number 2R8=M10

The 2R8 foot adapter made of steel connects the SACH, SACH+ and Dynamic prosthetic feet to the distal connector of a modular prosthesis.

Technical data

Article number	Max. body weight	Weight
2R8=M10	125 kg	125 g



Screw connection foot adapter 2R8=M10

Article number 2D6=M10

The 2D6 spare parts pack consists of spare parts for the screw connection of the 2R40 and 2R8 foot adapters.

Technical data

Article number	Spare part for	Scope of delivery
2D6=M10	2R8=M10	1 cap screw (steel) 1 hexagon socket head 1 washer

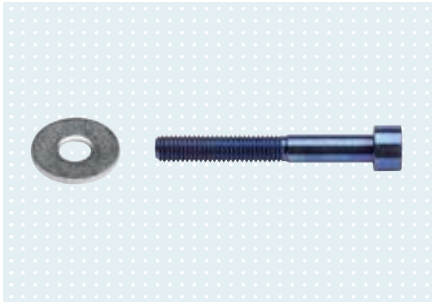

Screw connection foot adapter

2R31=M10, 2R54=M10

Article number 2D7=M10

The spare parts set is used for the screw connection of the 2R31 and 2R54 foot adapters with the corresponding prosthetic feet.

Technical data

Article number	Spare part for
2D7=M10	2R31=M10 2R54=M10



Connection plate for 2R54=M10, 2R31=M10, 2R8=M10

Article number 2R14

The 2R14 connection plate facilitates the fabrication of cosmetic prostheses and forms the transition from the foam cover to the adapter. It is bonded to the foam cover and then pressed onto the adapter.

Technical data

Article number
2R14

Prosthetic feet

Mobility grade 1–2



SACH+ foot

Reference number 1S101

The 1S101 SACH+ foot is suitable for users in mobility grades 1–2 with a body weight of up to 125 kg. It has a heel height of 10 +/- 5 mm.

Key features

- Natural-looking standard foot shape, smooth surface, defined toes and a separate big toe
- Robust and durable design
- Waterproof
- Easier to clean thanks to the smooth surface



Max. 80 kg
Size 22 to 23 cm



Max. 100 kg
Size 24 to 25 cm



Max. 125 kg
Size 26 to 30 cm

Information material

647G762=ALL_INT IFU 1S101

Scope of delivery

1S101 SACH+ foot 1 Piece

Technical data

Mobility grade	1, 2
Max. body weight	125 kg
Side	left (L), right (R)
Sizes	22-30 cm
Weight without adapter*	590 g
Foot shape	Normal shape for a heel height of 10 +/- 5 mm
Colour	beige (4), light brown (15)
System height with adapter*	67 mm
Build height with adapter*	85 mm

* Technical data refer to the size of 26 cm

Order example

Reference number	= Side	Size	- 0 - W / Colour
1S101	= L	26	- 0 - W / 4

Accessories/spare parts for 1S101



Foot adapter with screw connection, aluminium

Article number 2R54=M10

The 2R54 foot adapter made of aluminium connects the SACH, SACH+, 1G6 and Dynamic prosthetic feet to the distal connector of a modular prosthesis.

Technical data

Article number	Max. body weight	Weight
2R54=M10	100 kg	80 g

Information material

647G5=ALL_INT IFU 2R8 2R31 2R54



Foot adapter with screw connection, titanium

Article number 2R31=M10

The 2R31 foot adapter made of titanium connects the SACH, SACH+, 1G6 and Dynamic prosthetic feet to the distal connector of a modular prosthesis.

Technical data

Article number	Max. body weight	Weight
2R31=M10	136 kg	70 g

Information material

647G5=ALL_INT IFU 2R8 2R31 2R54



Foot adapter with screw connection, steel

Article number 2R8=M10

The 2R8 foot adapter made of steel connects the SACH, SACH+ and Dynamic prosthetic feet to the distal connector of a modular prosthesis.

Technical data

Article number	Max. body weight	Weight
2R8=M10	125 kg	125 g

Information material

647G5=ALL_INT IFU 2R8 2R31 2R54



Screw connection foot adapter 2R8=M10

Article number 2D6=M10

The 2D6 spare parts pack consists of spare parts for the screw connection of the 2R40 and 2R8 foot adapters.

Technical data

Article number	Spare part for	Scope of delivery
2D6=M10	2R8=M10	1 cap screw (steel) 1 hexagon socket head 1 washer

Prosthetic feet

Mobility grade 1–2

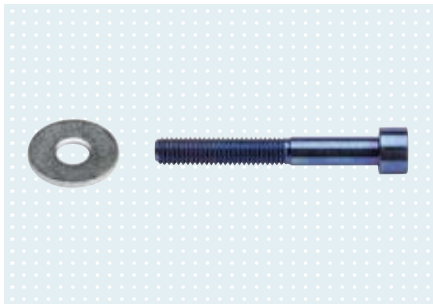

Screw connection foot adapter

2R31=M10, 2R54=M10

Article number 2D7=M10

The spare parts set is used for the screw connection of the 2R31 and 2R54 foot adapters with the corresponding prosthetic feet.

Technical data

Article number

2D7=M10

Spare part for

2R31=M10

2R54=M10



Connection plate for 2R54=M10, 2R31=M10, 2R8=M10

Article number 2R14

The 2R14 connection plate facilitates the fabrication of cosmetic prostheses and forms the transition from the foam cover to the adapter. It is bonded to the foam cover and then pressed onto the adapter.

Technical data

Article number

2R14



Dynamic foot without adapter

Reference number 1D10

The 1D10 dynamic foot without adapter is identical to the version with adapter from a functional and cosmetic perspective. This prosthetic foot permits good forefoot dynamics for users in mobility grades 1–2 and is designed for use in modular prostheses.

Key features

- Functional properties are achieved through the proven combination of a contoured core and functional foam
- Comfortable heel strike and easier rollover
- Natural shape with a separate big toe
- Normal foot shape

Information material

647G356=ALL_INT IFU 1D10 1D11

Scope of delivery

1D10 Dynamic foot without adapter 1 Piece



Max. 125 kg
Size 22 to 30 cm

Technical data

Mobility grade	1, 2
Max. body weight	125 kg
Side	left (L), right (R)
Sizes	22-30 cm
Weight without adapter*	470 g
Foot shape	Normal shape for a heel height of 10 +/- 5 mm
Colour	beige (4), light brown (15)
System height with adapter*	67 mm
Build height with adapter*	85 mm

* Technical data refer to the size of 26 cm

- This foot can be equipped with a custom silicone cover. See the section "Prosthesis covers" for detailed information.

Order example

Reference number	=	Side	Size	-	0	-	W	/	Colour
1D10	=	L	26	-	0	-	W	/	4

Prosthetic feet

Mobility grade 1–2

Accessories/spare parts for Dynamic foot without adapter



Information material

647G5=ALL_INT

IFU 2R8 2R31 2R54

Foot adapter with screw connection, aluminium

Article number 2R54=M10

The 2R54 foot adapter made of aluminium connects the SACH, SACH+, 1G6 and Dynamic prosthetic feet to the distal connector of a modular prosthesis.

Technical data

Article number	Max. body weight	Weight
2R54=M10	100 kg	80 g



Information material

647G5=ALL_INT

IFU 2R8 2R31 2R54

Foot adapter with screw connection, titanium

Article number 2R31=M10

The 2R31 foot adapter made of titanium connects the SACH, SACH+, 1G6 and Dynamic prosthetic feet to the distal connector of a modular prosthesis.

Technical data

Article number	Max. body weight	Weight
2R31=M10	136 kg	70 g



Information material

647G5=ALL_INT

IFU 2R8 2R31 2R54

Foot adapter with screw connection, steel

Article number 2R8=M10

The 2R8 foot adapter made of steel connects the SACH, SACH+ and Dynamic prosthetic feet to the distal connector of a modular prosthesis.

Technical data

Article number	Max. body weight	Weight
2R8=M10	125 kg	125 g



Screw connection foot adapter 2R8=M10

Article number 2D6=M10

The 2D6 spare parts pack consists of spare parts for the screw connection of the 2R40 and 2R8 foot adapters.

Technical data

Article number	Spare part for	Scope of delivery
2D6=M10	2R8=M10	1 cap screw (steel) 1 hexagon socket head 1 washer

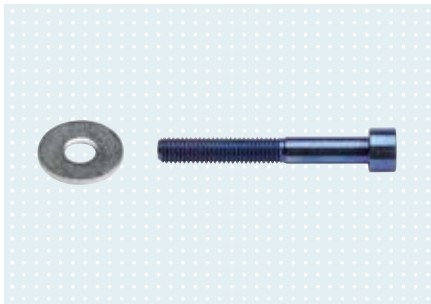

Screw connection foot adapter

2R31=M10, 2R54=M10

Article number 2D7=M10

The spare parts set is used for the screw connection of the 2R31 and 2R54 foot adapters with the corresponding prosthetic feet.

Technical data

Article number	Spare part for
2D7=M10	2R31=M10 2R54=M10





Custom silicone cover lower limb

Article number 88A20

For many users, a natural outward appearance is just as important as the functional benefits of a prosthesis. With high-end, custom-made silicone covers for leg prostheses, Ottobock gives you the opportunity to make this dream come true for your users. The Ottobock iFab acts as your extended workbench for the fabrication of aesthetically pleasing silicone covers, as they are made to your precise and individual specifications – quickly, reliably and in the highest quality.

Technical data

Article image	Article number	Description	Product features
	88A20=C	Custom silicone covers for the lower limbs	<ul style="list-style-type: none"> Anatomical shape Custom silicone cover in two to three colours Anatomical surface structure Single-colour silicone toenails with colour-compatible nail tip
	88A20=N	Custom silicone covers for the lower limbs	<ul style="list-style-type: none"> Anatomical shape Custom silicone cover in 8-10 colours Anatomical surface structure Single-colour silicone toenails with colour-compatible nail tip

• You will find further information on custom silicone covers for the lower limbs in the "Prosthesis covers" section.

Prosthetic feet

Mobility grade 1–2



Dynamic foot with adapter

Reference number 1D10

The 1D10 Dynamic foot is a prosthetic foot with good forefoot dynamics for users in mobility grades 1–2. The foot comes with an assembled titanium adapter and is approved for a body weight of up to 150 kg.

Key features

- Functional properties are achieved through the proven combination of a contoured core and functional foam
- Comfortable heel strike and easier rollover
- Natural shape with a separate big toe
- Normal foot shape



Max. 150 kg
Size 22 to 30 cm

Information material

647G356=ALL_INT IFU 1D10 1D11

Scope of delivery

1D10 Dynamic foot with adapter 1 Piece

Technical data

Mobility grade	1, 2
Max. body weight	150 kg
Side	left (L), right (R)
Sizes	22-30 cm
Weight*	565 g
Foot shape	Normal shape for a heel height of 10 +/- 5 mm
Colour	beige (4), light brown (15)
System height with adapter*	67 mm
Build height with adapter*	85 mm

* Technical data refer to the size of 26 cm

- This foot can be equipped with a custom silicone cover. See the section "Prosthesis covers" for detailed information.

Order example

Reference number	= Side	Size	- 0 - P	/ Colour
1D10	= L	26	- 0 - P	/ 4

Accessories/spare parts for Dynamic foot with adapter





Custom silicone cover lower limb

Reference number 88A20

For many users, a natural outward appearance is just as important as the functional benefits of a prosthesis. With high-end, custom-made silicone covers for leg prostheses, Ottobock gives you the opportunity to make this dream come true for your users. The Ottobock iFab acts as your extended workbench for the fabrication of aesthetically pleasing silicone covers, as they are made to your precise and individual specifications – quickly, reliably and in the highest quality.

Technical data

Article image	Article number	Description	Product features
	88A20=C	Custom silicone covers for the lower limbs	<ul style="list-style-type: none"> Anatomical shape Custom silicone cover in two to three colours Anatomical surface structure Single-colour silicone toenails with colour-compatible nail tip
	88A20=N	Custom silicone covers for the lower limbs	<ul style="list-style-type: none"> Anatomical shape Custom silicone cover in 8-10 colours Anatomical surface structure Single-colour silicone toenails with colour-compatible nail tip

• You will find further information on custom silicone covers for the lower limbs in the "Prosthesis covers" section.

Prosthetic feet

Mobility grade 1–2



Dynamic foot

Reference number 1D11

The 1D11 Dynamic foot is an especially slim prosthetic foot with good forefoot dynamics for users in mobility grades 1–2. It was designed for use in modular prostheses.

Key features

- Functional properties are achieved through the proven combination of a contoured core and functional foam
- Comfortable heel strike and easier rollover
- Natural shape with a separate big toe
- Slim foot shape



Max. 100 kg
Size 22 to 25 cm



Max. 125 kg
Size 26 to 28 cm

Information material

647G356=ALL_INT IFU 1D10 1D11

Scope of delivery

1D11	Dynamic foot	1	Piece
------	--------------	---	-------

Technical data

Mobility grade	1, 2
Max. body weight	125 kg
Side	left (L), right (R)
Sizes	22-28 cm
Weight without adapter*	435 g
Foot shape	Slim shape for a heel height of 20 +/- 5 mm
Colour	beige
System height with adapter*	67 mm
Build height with adapter*	85 mm

* Technical data refer to the size of 26 cm

Order example

Reference number	= Side	Size
1D11	= L	26

Accessories/spare parts for 1D11



Information material

647G5=ALL_INT IFU 2R8 2R31 2R54

Foot adapter with screw connection, aluminium

Reference number 2R54

The 2R54 foot adapter made of aluminium connects the SACH, SACH+, 1G6 and Dynamic prosthetic feet to the distal connector of a modular prosthesis.

Technical data

Article number	Accessory for	Max. body weight	Weight			
2R54=M8	1D11=L22	100 kg	70 g			
	1D11=R22					
	1D11=L23					
	1D11=R23					
	1D11=L24					
	1D11=R24					
	1D11=L25					
	1D11=R25					
	2R54=M10			1D11=L26	100 kg	80 g
				1D11=R26		
1D11=L27						
1D11=R27						
1D11=L28						
1D11=R28						



Information material

647G5=ALL_INT IFU 2R8 2R31 2R54

Foot adapter with screw connection, titanium

Reference number 2R31

The 2R31 foot adapter made of titanium connects the SACH, SACH+, 1G6 and Dynamic prosthetic feet to the distal connector of a modular prosthesis.

Technical data

Article number	Accessory for	Max. body weight	Weight			
2R31=M8	1D11=L22	100 kg	65 g			
	1D11=R22					
	1D11=L23					
	1D11=R23					
	1D11=L24					
	1D11=R24					
	1D11=L25					
	1D11=R25					
	2R31=M10			1D11=L26	136 kg	70 g
				1D11=R26		
1D11=L27						
1D11=R27						
1D11=L28						
1D11=R28						

Prosthetic feet

Mobility grade 1–2



Information material

647G5=ALL_INT

IFU 2R8 2R31 2R54

Foot adapter with screw connection, steel

Reference number 2R8

The 2R8 foot adapter made of steel connects the SACH, SACH+ and Dynamic prosthetic feet to the distal connector of a modular prosthesis.

Technical data

Article number	Accessory for	Weight	Max. body weight
2R8=M8	1D11=L22 1D11=R22 1D11=L23 1D11=R23 1D11=L24 1D11=R24 1D11=L25 1D11=R25	115 g	100 kg
2R8=M10	1D11=L26 1D11=R26 1D11=L27 1D11=R27 1D11=L28 1D11=R28	125 g	125 kg

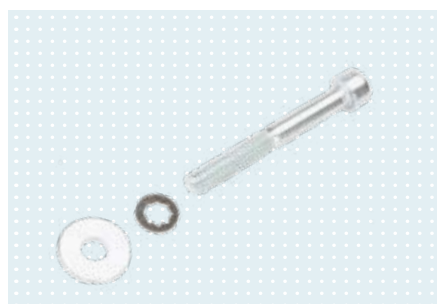

Screw connection foot adapter 2R8=M8

Article number 2D6=M8

The spare parts set is used for the screw connection of the 2R31 and 2R54 foot adapters with the corresponding prosthetic feet.

Technical data

Article number	Spare part for	Scope of delivery
2D6=M8	2R8=M8 2R40=1	1 cap screw (steel) 1 hexagon socket head 1 washer

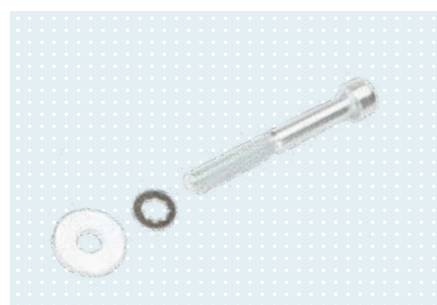

Screw connection foot adapter 2R8=M10

Article number 2D6=M10

The 2D6 spare parts pack consists of spare parts for the screw connection of the 2R40 and 2R8 foot adapters.

Technical data

Article number	Spare part for	Scope of delivery
2D6=M10	2R8=M10	1 cap screw (steel) 1 hexagon socket head 1 washer

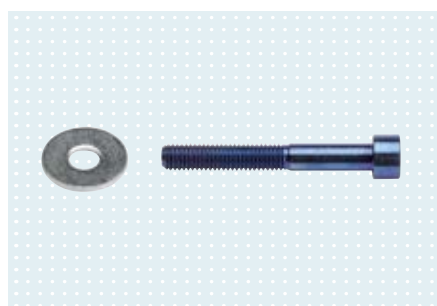

Screw connection foot adapter 2R31=M8, 2R54=M8

Article number 2D7=M8

The spare parts set is used for the screw connection of the 2R31 and 2R54 foot adapters with the corresponding prosthetic feet.

Technical data

Article number	Spare part for
2D7=M8	2R31=M8 2R54=M8

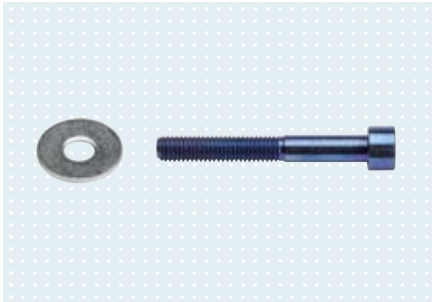

Screw connection foot adapter

2R31=M10, 2R54=M10

Article number 2D7=M10

The spare parts set is used for the screw connection of the 2R31 and 2R54 foot adapters with the corresponding prosthetic feet.

Technical data

Article number	Spare part for
2D7=M10	2R31=M10 2R54=M10



Connection plate

Article number 2R14

The 2R14 connection plate facilitates the fabrication of cosmetic prostheses and forms the transition from the foam cover to the adapter. It is bonded to the foam cover and then pressed onto the adapter.

Technical data

Article number
2R14

Prosthetic feet

Mobility grade 1–2



Adjust

Reference number 1M10

The 1M10 Adjust is a multi-axial prosthetic foot with adjustable heel characteristics. It is suitable for users in mobility grades 1–2 and a body weight of up to 125 kg.

Key features

- Comfortable heel strike with good shock absorption and easy rollover
- Stable stance even with shifting of weight
- The yielding joint and flexibility of the function module and ball pad compensate for uneven surfaces
- Takes individual user needs for the heel characteristics into account with the adjustable function module

Information material

647G439=ALL_INT IFU 1M10

Scope of delivery

Part number	Description	Quantity	Unit
1M10	Adjust	1	Piece
2C1	Footshell	1	Piece
2C19	Connection cover with normal footshell	1	Piece
2C20	Connection cover with slim footshell	1	Piece
SL=SPEC-TRA-SOCK-7	Spectra protective sock black	1	Piece



Max. 80 kg
Size 22 to 23 cm



Max. 100 kg
Size 24 to 25 cm



Max. 125 kg
Size 26 to 30 cm

Technical data

Mobility grade	1, 2
Max. body weight	125 kg
Side	left (L), right (R)
Sizes	22-30 cm
Weight without footshell*	385 g
Footshell shape	Slim shape (S) for a heel height of 20 +/- 5 mm (22-26 cm) Normal shape (N) for a heel height of 10 +/- 5 mm (22-30 cm)
Footshell colour	beige (4), light brown (15)
System height with normal footshell*	57 mm
Build height with normal footshell*	75 mm

* Technical data refer to the size of 26 cm



2010



reddot design award
winner 2010

Stiffness chart

Stiffness	Foot size			
	22–23 cm	24–25 cm	26–27 cm	28–30 cm
1	to 52 kg	to 58 kg	to 72 kg	to 77 kg
2	53–68 kg	59–76 kg	73–95 kg	78–100 kg
3	69–80 kg	77–100 kg	96–125 kg	101–125 kg

Order example

Reference number	= Side	Size	- Stiffness	- P /	Colour	Shape
1M10	= L	26	- 2	- P / 4		N

Accessories/spare parts for 1M10



Footshell

Reference number 2C1

The 2C1 footshell is a protective cover for the 1M10 Adjust prosthetic foot. Its external shape creates a natural appearance in the slim or normal version. It is available in the colours beige and light brown.

Technical data

Reference number	2C1=*N	2C1=*S
Side	left (L), right (R)	left (L), right (R)
Shape	normal shape (N)	slim shape (S)
Size	22-30 cm	22-26 cm
Weight*	195 g	165 g
Heel height	10 +/- 5 mm	20 +/- 5 mm
Colour	beige (4), light brown (15)	beige (4), light brown (15)

* Technical data refer to the size of 26 cm

Information material

647G333=ALL_INT	IFU Footshell
-----------------	---------------

Scope of delivery

Reference number	Description	Quantity	Unit
2C1	Footshell	1	Piece
2C19	Connection cover with normal footshell	1	Piece
2C20	Connection cover with slim footshell	1	Piece

Order example

Reference number	=	Side	Size	/	Colour	Shape
2C1	=	L	26	/	4	N

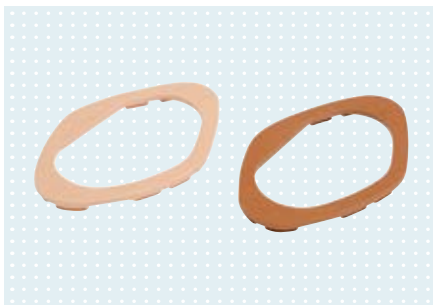

Connection cover

Reference number 2C19

In combination with the 2C1, 2C6 and 2C15 footshells in the normal foot shape, the 2C19 connection cover forms an attractive cosmetic cover that can be glued to a foam cover.

Technical data

Reference number	2C19=*N
Side	left (L), right (R)
Size	22 cm, 23-25 cm, 26-28 cm, 29-31 cm
Colour	beige (4), light brown (15)
for	Footshells 2C1=*N, 2C6=*N, 2C15=*N

Order example

Reference number	=	Side	Size range	/	Colour
2C19	=	L	26-28	/	4

Prosthetic feet

Mobility grade 1–2

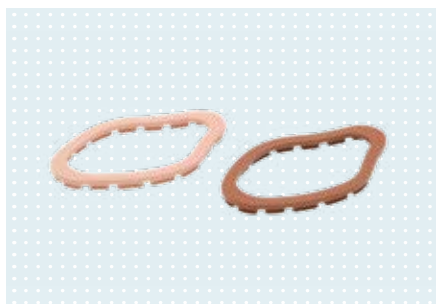

Connection cover

Reference number 2C20

In combination with the 2C1, 2C3, 2C6 and 2C15 footshells in the slim foot shape, the 2C20 connection cover forms an attractive cosmetic cover that can be glued to a foam cover.

Technical data

Reference number	2C20=*
Side	left (L), right (R)
Size	21-27 cm
Colour	beige (4), light brown (15)
for	Footshells 2C1=*S, 2C3=*S, 2C6=*S, 2C15=S*

Order example

Reference number	=	Side	Size	/	Colour
2C20	=	L	26	/	4

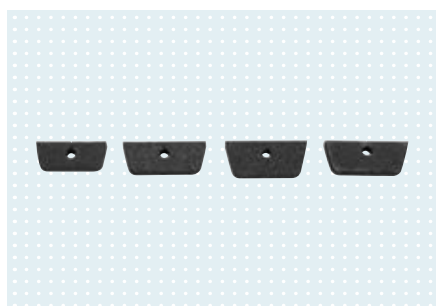

Single component pack

Reference number 2D11

The 2D11 single component pack contains spare parts for the 1M10 Adjust prosthetic foot.

Technical data

Article number
2D11

Prosthetic feet

Mobility grade 1–2



Terion K2

Reference number 1C11

The 1C11 Terion K2 prosthetic foot is intended for users with low to moderate mobility. Thanks to the combination of the functional foam and a spring made of carbon and fibre-glass, it offers a soft heel strike and smooth rollover with adequate energy return.

Key features

- Lightweight, sturdy foot design that provides optimal support
- Elastic heel for balanced load distribution, good ground contact and therefore a high degree of stability while standing and walking
- Universal application options thanks to the low structural height and a maximum user weight of up to 175 kg
- Resistant to dust, dirt and splashed water

Information material

647G1159=ALL_INT IFU Terion K2

Scope of delivery

1C11	Terion K2		1	Piece
2C12	Footshell		1	Piece
2C13	Connection cover		1	Piece
SL=SPEC-TRA-SOCK2-7	Spectra protective sock short black	for sizes 22-28 cm	1	Piece
SL=SPEC-TRA-SOCK-7	Spectra protective sock black	for sizes 29-30	1	Piece

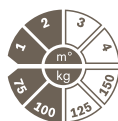

Max. 100 kg
Size 22 to 23 cm



Max. 150 kg
Size 24 to 25 cm



Max. 175 kg
Size 26 to 30 cm

Technical data

Mobility grade	1, 2
Max. body weight	175 kg
Side	left (L), right (R)
Sizes	22-30 cm
Weight without footshell*	325 g
Footshell shape	Slim shape (S) for a heel height of 10 +/- 5 mm (22-23 cm) Normal shape (N) for a heel height of 10 +/- 5 mm (24-30 cm)
Footshell colour	beige (4), light brown (15)
Weight with normal footshell*	573 g
System height with normal footshell*	46 mm
Build height with normal footshell*	64 mm

* Technical data refer to the size of 26 cm

Stiffness chart

Foot size \ Body weight	Foot size			
	22–23 cm	24–25 cm	26–28 cm	29–30 cm
up to 55 kg	1	1	2	
56–75 kg	2	2	3	3
76–100 kg	3	3	4	4
101–125 kg		4	5	5
125–150 kg		5	6	6
151–175 kg				

Slim footshell available
 Normal footshell available

Order example

Reference number	=	Side	Size	-	Stiffness	-	P	/	Colour	Shape
1C11	=	L	26	-	4	-	P	/	4	N

Terion K2

Confidence in every step.

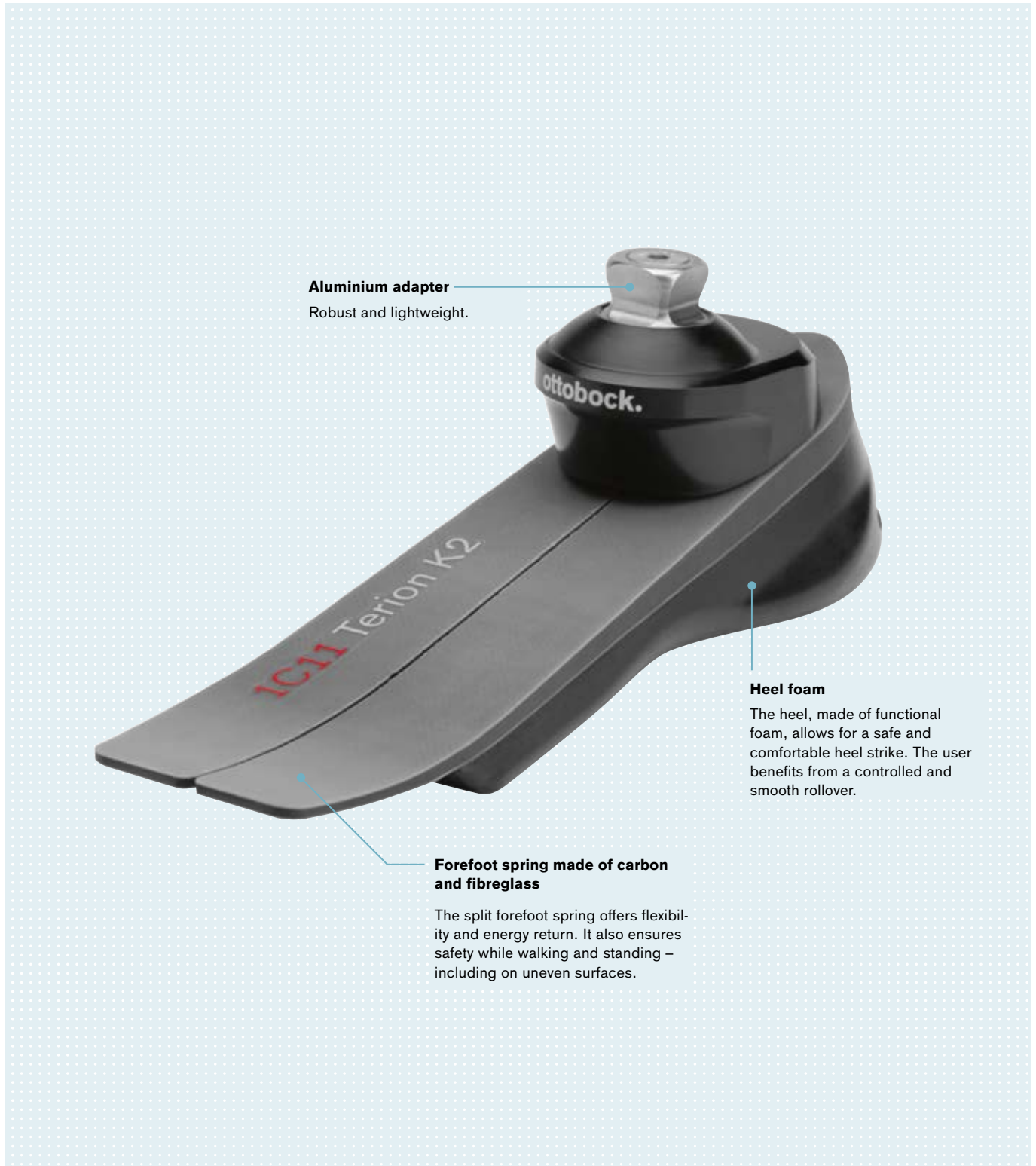

Aluminium adapter
Robust and lightweight.

Heel foam
The heel, made of functional foam, allows for a safe and comfortable heel strike. The user benefits from a controlled and smooth rollover.

Forefoot spring made of carbon and fibreglass
The split forefoot spring offers flexibility and energy return. It also ensures safety while walking and standing – including on uneven surfaces.

Prosthetic feet

Prosthetic feet

Mobility grade 1–2

Accessories/spare parts for 1C11



Footshell

Reference number 2C12

The 2C12 footshell is a low-cut protective cover for the Terion prosthetic feet, making it easy to reach the adjustment screws. Alignment marks enable straightforward and fast bench alignment. Its slim or normal external shape creates a natural appearance. It is available in the colours beige and light brown.

Information material

647G1092=ALL_INT	IFU 2C12
------------------	----------

Scope of delivery

2C12	Footshell	1	Piece
2C13	Connection cover	1	Piece

Technical data

Reference number	2C12=*N	2C12=*S
Side	left (L), right (R)	left (L), right (R)
Shape	normal shape	slim shape
Size	24-30 cm	22-23 cm
Weight	255 g*	192 g**
Heel height	5 +/- 5 mm	5 +/- 5 mm
Colour	beige (4), light brown (15)	beige (4), light brown (15)
	* Technical data refer to the size of 26 cm	** Technical data refer to the size of 23 cm

Order example

Reference number	=	Side	Size	/	Colour	Shape
2C12	=	L	26	/	4	N

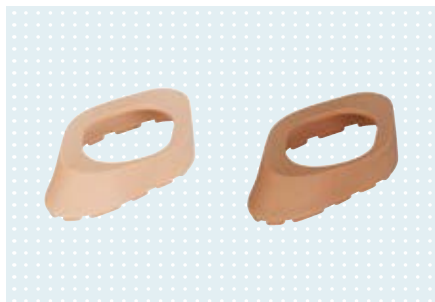

Connection cover

Reference number 2C13

In combination with the 2C12 footshell, the 2C13 connection cover forms an attractive cosmetic cover for the Terion prosthetic feet. Alignment marks on the connection cover contribute to easier, faster bench alignment.

Technical data

Reference number	2C13=*S
Side	left (L), right (R)
Size	22-30 cm
Colour	beige (4), light brown (15)
For	Footshells 2C12=*N, 2C12=*S

Order example

Reference number	=	Side	Size	/	Colour	Shape
2C13	=	L	26	/	4	N



Spectra protective sock short black

Reference number SL=SPECTRA-SOCK2-7

The short Spectra sock in black is an accessory for prosthetic feet. It protects the foot against soiling and prevents possible noises that could develop due to the movement of the prosthesis in the cosmetic foot cover.

Technical data

Article number

SL=SPECTRA-SOCK2-7



Spectra protective sock black

Reference number SL=SPECTRA-SOCK-7

The long Spectra sock in black is an accessory for prosthetic feet. It protects the foot against soiling and prevents possible noises that could develop due to the movement of the prosthesis in the cosmetic foot cover.

Technical data

Article number

SL=SPECTRA-SOCK-7

Prosthetic feet

Mobility grade 2–3



Greissinger plus

Reference number 1A30

The 1A30 Greissinger plus is a prosthetic foot for moderately active users. All-round mobility is achieved by the rollover of the titanium adapter on the ring-shaped elastomer combined with the fork in a flexible suspension.

Key features

- Multi-axial characteristics to compensate for uneven surfaces
- Individually adaptable with elastomers in three degrees of hardness (soft, medium, hard)
- Natural gait pattern thanks to optimal rollover characteristics
- Natural shape with defined toes



Max. 75 kg
Size 24 to 25 cm

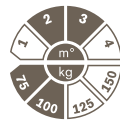

Max. 100 kg
Size 26 to 29 cm

Information material

647G1629=ALL_INT IFU 1A30

Scope of delivery

Reference number	Description	Quantity	Unit
1A30	Greissinger plus	1	Piece
2R86	Foam connecting cap	1	Piece
2D3	Single component pack for size 24-25 cm	1	Piece
2D4	Single component pack for size 26-29 cm	1	Piece

Technical data

Mobility grade	2, 3
Max. body weight	100 kg
Side	left (L), right (R)
Sizes	24-29 cm
Weight*	705 g
Foot shape	Normal shape for a heel height of 10 +/- 5 mm
Colour	beige
System height*	69 mm
Build height*	87 mm

* Technical data refer to the size of 26 cm

Order example

Reference number	=	Side	Size
1A30	=	L	26

Accessories/spare parts for 1A30



Greissinger plus shaped foot component without adapter

Reference number 1A31

The 1A31 Greissinger plus shaped foot component without adapter is a spare part for the 1A30 Greissinger plus prosthetic foot.

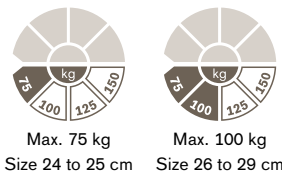

Technical data

Mobility grade	2, 3
Max. body weight	100 kg
Side	left (L), right (R)
Sizes	24-29 cm
Foot shape	Normal shape for a heel height of 10 +/- 5 mm
Colour shaped foot part	beige

* Technical data refer to the size of 26 cm

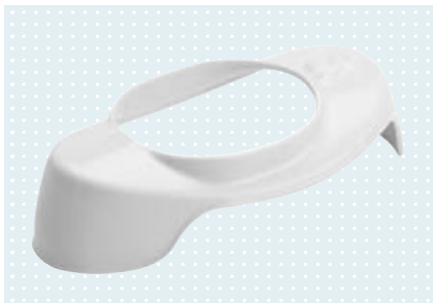

Foam connecting cap

Reference number 2R86

The 2R86 foam connecting cap is bonded to the foam cover and pressed onto the edge of the shaped foot component. Can be used on left/right.

Technical data

Article number	Spare part for	Size
2R86=24	1A30=L24 1A30=R24	24 cm
2R86=25	1A30=L25 1A30=R25	25 cm
2R86=26	1A30=L26 1A30=R26	26 cm
2R86=27	1A30=L27 1A30=R27	27 cm
2R86=28	1A30=L28 1A30=R28	28 cm
2R86=29	1A30=L29 1A30=R29	29 cm

Prosthetic feet

Mobility grade 2–3

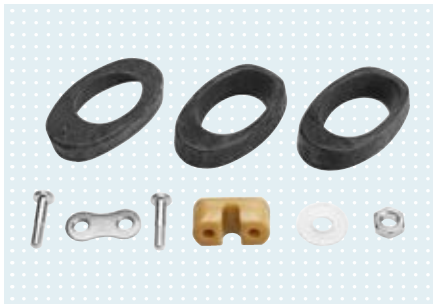

Single component pack

Reference number 2D3

The 2D3 spare parts pack consists of spare parts for the 1A30 Greissinger plus prosthetic foot in sizes 24–25 cm and is used to replace the elastomer.

Technical data

Article number	Spare part for	Size
2D3	1A30=L24 1A30=L25 1A30=R24 1A30=R25	24–25 cm

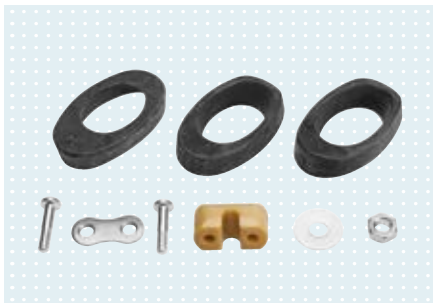

Single component pack

Reference number 2D4

The 2D4 spare parts pack consists of spare parts for the 1A30 Greissinger plus prosthetic foot in sizes 26–29 cm and is used to replace the elastomer.

Technical data

Article number	Spare part for	Size
2D4	1A30=L26 1A30=L27 1A30=L28 1A30=L29 1A30=R26 1A30=R27 1A30=R28 1A30=R29	26–29 cm



Dynamic Motion

Reference number 1D35

The 1D35 Dynamic Motion offers an especially smooth and physiological rollover. The prosthetic foot is suitable for users in mobility grades 2–3 with a body weight of up to 100 kg.

Key features

- Progressive course of the ankle moment in the mid-stance phase for a physiological rollover and effortless walking
- Comfortable heel strike with perceptible plantar flexion
- Optimised back-to-front and side-to-side flexibility
- Good energy return thanks to the special characteristics of the plastic spring combined with the functional foam and the integrated 3D spacer fabric
- Elastic spring effect in the forefoot for a dynamic transition from the stance to swing phase
- Detachable cosmetic connection cover for attractive and easy to handle connection to the foam cover

Information material

647G127=ALL_INT	IFU 1D35
-----------------	----------

Scope of delivery

1D35	Dynamic Motion		1	Piece
2C10	Connection cover	for sizes 21-22 cm	1	Piece
2C11	Connection cover	for sizes 23-30 cm	1	Piece



Max. 75 kg
Size 22 to 25 cm



Max. 100 kg
Size 26 to 30 cm

Technical data

Mobility grade	2, 3
Max. body weight	100 kg
Side	left (L), right (R)
Sizes	22-30 cm
Weight*	630 g
Foot shape	Normal shape for a heel height of 10 +/- 5 mm
Footshell colour	beige (4), light brown (15)
System height*	68 mm
Build height*	86 mm

* Technical data refer to the size of 26 cm

- This foot can be equipped with a custom silicone cover. See the section "Prosthesis covers" for detailed information.

Order example

Reference number	=	Side	=	Size	-	0	-	P	/	Colour
1D35	=	L	=	26	-	0	-	P	/	4

Prosthetic feet

Mobility grade 2–3

Accessories/spare parts for 1D35

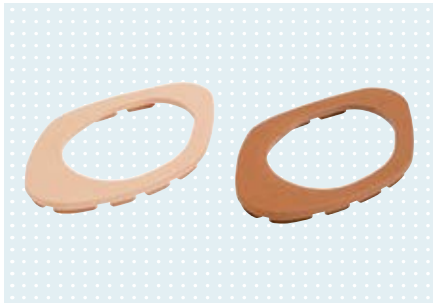

Connection cover

Reference number 2C10

In combination with the 2C3 and 2C5 footshells or the 1D35 Dynamic Motion, the 2C10 connection cover forms an attractive cosmetic cover that can be glued to a foam cover.

Technical data

Reference number	2C10=*		
Side	left (L), right (R)		
Size	21-22 cm, 23-25 cm, 26-28 cm, 29-31 cm		
Colour	beige (4), light brown (15)		
for	Footshells 2C3=* and 2C5=*		
	Dynamic Motion 1D35=* (sizes 21–22 cm)		

Order example

Reference number	= Side	Size range	/ Colour
2C10	= L	26-28	/ 4



Connection cover

Reference number 2C11

In combination with the 2C4 footshell or the 1D35 Dynamic Motion, the 2C11 connection cover forms an attractive cosmetic cover that can be glued to a foam cover.

Technical data

Reference number	2C11=*		
Side	left (L), right (R)		
Size	23-25 cm, 26-28 cm, 29-30 cm		
Colour	beige (4), light brown (15)		
for	Footshells 2C4=*		
	Dynamic Motion 1D35=* (sizes 23–30 cm)		

Order example

Reference number	= Side	Size range	/ Colour
2C11	= L	26-28	/ 4





Custom silicone cover lower limb

Reference number 88A20

For many users, a natural outward appearance is just as important as the functional benefits of a prosthesis. With high-end, custom-made silicone covers for leg prostheses, Ottobock gives you the opportunity to make this dream come true for your users. The Ottobock iFab acts as your extended workbench for the fabrication of aesthetically pleasing silicone covers, as they are made to your precise and individual specifications – quickly, reliably and in the highest quality.

Technical data

Article image	Article number	Description	Product features
	88A20=C	Custom silicone covers for the lower limbs	<ul style="list-style-type: none"> · Anatomical shape · Custom silicone cover in two to three colours · Anatomical surface structure · Single-colour silicone toenails with colour-compatible nail tip
	88A20=N	Custom silicone covers for the lower limbs	<ul style="list-style-type: none"> · Anatomical shape · Custom silicone cover in 8-10 colours · Anatomical surface structure · Single-colour silicone toenails with colour-compatible nail tip

• You will find further information on custom silicone covers for the lower limbs in the "Prosthesis covers" section.

Prosthetic feet

Mobility grade 2–3



Terion

Reference number 1C10

Thanks to the 1C10 Terion prosthetic foot, moderately active users now benefit from carbon fibre technology as well. Lightweight, flexible and durable, the foot also features an anatomically shaped heel and is highly responsive in a wide range of everyday activities.

Key features

- Lightweight, robust and durable carbon foot with low structural height
- Resistant to dust, dirt and splashed water
- A pre-installed toe insert in the footshell lengthens the forefoot and enables different walking speeds

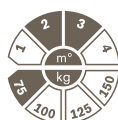

Max. 75 kg
Size 22 to 23 cm



Max. 100 kg
Size 24 to 25 cm

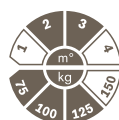

Max. 125 kg
Size 26 to 28 cm

Information material

647G972=ALL_INT IFU Terion

Scope of delivery

1C10	Terion	1	Piece
2C12	Footshell	1	Piece
2C13	Connection cover	1	Piece
SL=SPECTRA-SOCK2-7	Spectra protective sock short black	1	Piece

Technical data

Mobility grade	2, 3
Max. body weight	125 kg
Side	left (L), right (R)
Sizes	22-28 cm
Weight without Footshell*	343 g
Footshell shape	Slim shape (S) for a heel height of 5 +/- 5 mm (22-23 cm) Normal shape (N) for a heel height of 5 +/- 5 mm (24-28 cm)
Footshell colour	beige (4), light brown (15)
Weight with normal footshell*	598 g
System height with normal footshell*	49 mm
Build height with normal footshell*	67 mm

* Technical data refer to the size of 26 cm

Stiffness chart

Foot size	Foot size		
	22 – 23 cm	24 – 25 cm	26 – 28 cm
Body weight			
to 75 kg	Stiffness 2	Stiffness 3	Stiffness 4
76–100 kg			
101–125 kg			

■ Slim footshell available

■ Normal footshell available

Order example

Reference number	Side	Size	Stiffness	P /	Colour	Shape
1C10	L	26	4	P /	4	N



red dot award 2015
winner

Accessories/spare parts for 1C10



Footshell

Reference number 2C12

The 2C12 footshell is a low-cut protective cover for the Terion prosthetic feet, making it easy to reach the adjustment screws. Alignment marks enable straightforward and fast bench alignment. Its slim or normal external shape creates a natural appearance. It is available in the colours beige and light brown.

Technical data

Reference number	2C12=*N	2C12=*S
Side	left (L), right (R)	left (L), right (R)
Shape	normal shape	slim shape
Size	24-30 cm	22-23 cm
Weight	255 g*	192 g**
Heel height	5 +/- 5 mm	5 +/- 5 mm
Colour	beige (4), light brown (15)	beige (4), light brown (15)
	* Technical data refer to the size of 26 cm	** Technical data refer to the size of 23 cm

Information material

647G1092=ALL_INT IFU 2C12

Scope of delivery

2C12	Footshell	1	Piece
2C13	Connection cover	1	Piece

Order example

Reference number	=	Side	Size	/	Colour	Shape
2C12	=	L	26	/	4	N

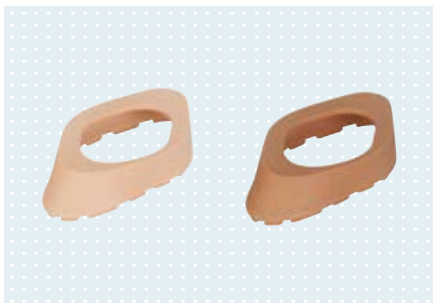

Connection cover

Reference number 2C13

In combination with the 2C12 footshell, the 2C13 connection cover forms an attractive cosmetic cover for the Terion prosthetic feet. Alignment marks on the connection cover contribute to easier, faster bench alignment.

Technical data

Reference number	2C13=*
Side	left (L), right (R)
Size	22-30 cm
Colour	beige (4), light brown (15)
For	Footshells 2C12=*N, 2C12=*S

Order example

Reference number	=	Side	Size	/	Colour	Shape
2C13	=	L	26	/	4	N



Spectra protective sock short black

Reference number SL=SPECTRA-SOCK2-7

The short Spectra sock in black is an accessory for prosthetic feet. It protects the foot against soiling and prevents possible noises that could develop due to the movement of the prosthesis in the cosmetic foot cover.

Technical data

Article number
SL=SPECTRA-SOCK2-7

Prosthetic feet

Mobility grade 2–3



Trias

Reference number 1C30

The 1C30 Trias is a prosthetic foot for moderately active users who navigate indoor and familiar outdoor environments and place a high value on consistent stability when walking.

Key features

- Flexible dual springs provide relief with shock absorption at heel strike and a gentle rollover
- Triangular design for balanced, controlled movements when walking on uneven surfaces
- Lightweight construction technology
- Slim footshell option

Information material

647G279=ALL_INT IFU Trias

Scope of delivery

Item	Description	Quantity	Unit
1C30	Trias	1	Piece
2C3	Footshell	1	Piece
2C10	Connection cover with normal footshell	1	Piece
2C20	Connection cover with slim footshell	1	Piece
SL=SPECTRA-SOCK-7	Spectra protective sock black	1	Piece



Max. 80 kg
Size 21 to 22 cm



Max. 95 kg
Size 23 to 24 cm



Max. 110 kg
Size 25 to 26 cm



Max. 125 kg
Size 27 to 30 cm

Technical data

Mobility grade	2, 3
Max. body weight	125 kg
Side	left (L), right (R)
Sizes	21-30 cm
Weight without footshell*	346 g
Footshell shape	Slim shape (S) for a heel height of 20 +/- 5 mm (21-27 cm) Normal shape for a heel height of 10 +/- 5 mm (21-30 cm)
Footshell colour	beige (4), light brown (15)
Weight with normal footshell*	551 g
System height with normal footshell*	95 mm
Build height with normal footshell*	113 mm

* Technical data refer to the size of 26 cm

- This foot can be equipped with a custom silicone cover. See the section "Prosthesis covers" for detailed information.

Stiffness chart

Body weight	Foot size									
	21 cm	22 cm	23 cm	24 cm	25 cm	26 cm	27 cm	28 cm	29 cm	30 cm
45–60 kg	1	1	1	1	–	–	–	–	–	–
61–80 kg	2	2	2	2	1	1	1	1	–	–
81–95 kg	–	–	3	3	2	2	2	2	1	1
96–110 kg	–	–	–	–	3	3	3	3	2	2
111–125 kg	–	–	–	–	–	–	4	4	3	3

Normal and slim footshell available
 Normal footshell available

Order example

Reference number	Side	Size	Stiffness	P	Colour	Shape
1C30	L	26	2	P	4	S



reddot design award
winner 2007 – best of the best

Trias

Secure as expected.



Lightweight design

The exceptionally low weight and good spring characteristics of the Trias help save energy for what's important – for mobility and independence.

Flexible dual springs

The Trias features interconnected dual springs for high flexibility and support when walking at varying speeds.

Triangular design

The anatomy of the human foot is reflected in the curved, triangular shape. The heel and forefoot sections form an arch structure and are connected to the base spring, forming a unit.

Prosthetic feet

Prosthetic feet

Mobility grade 2–3

Accessories/spare parts for 1C30



Footshell

Reference number 2C3

The 2C3 footshell is a protective cover for the 1C30 Trias prosthetic foot. Its external shape creates a natural appearance in the slim or normal version. It is available in the colours beige and light brown.

Technical data

Reference number	2C3=*	2C3=*S
Side	left (L), right (R)	left (L), right (R)
Shape	normal shape	slim shape
Size	21-30 cm	21-26 cm
Weight*	205 g	165 g
Heel height	10 +/- 5 mm	20 +/- 5 mm
Colour	beige (4), light brown (15)	beige (4), light brown (15)

* Technical data refer to the size of 26 cm

Information material

647G333=ALL_INT	IFU Footshell
-----------------	---------------

Scope of delivery

Reference number	Description	Quantity	Unit
2C3	Footshell	1	Piece
2C10	Connection cover with normal footshell	1	Piece
2C20	Connection cover with slim footshell	1	Piece

Order example

Reference number	=	Side	Size	/	Colour	Shape
2C3	=	L	26	/	4	S

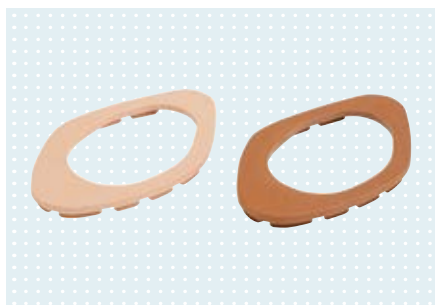

Connection cover

Reference number 2C10

In combination with the 2C3 and 2C5 footshells or the 1D35 Dynamic Motion, the 2C10 connection cover forms an attractive cosmetic cover that can be glued to a foam cover.

Technical data

Reference number	2C10=*
Side	left (L), right (R)
Size	21-22 cm, 23-25 cm, 26-28 cm, 29-31 cm
Colour	beige (4), light brown (15)
for	Footshells 2C3=* and 2C5=* Dynamic Motion 1D35=* (sizes 21–22 cm)

Order example

Reference number	=	Side	Size range	/	Colour
2C10	=	L	26-28	/	4

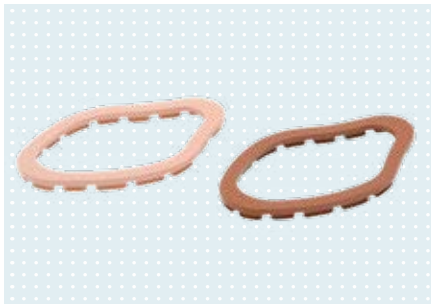

Connection cover

Reference number 2C20

In combination with the 2C1, 2C3, 2C6 and 2C15 footshells in the slim foot shape, the 2C20 connection cover forms an attractive cosmetic cover that can be glued to a foam cover.

Technical data

Reference number	2C20=*
Side	left (L), right (R)
Size	21-27 cm
Colour	beige (4), light brown (15)
for	Footshells 2C1=*S, 2C3=*S, 2C6=*S, 2C15=S*

Order example

Reference number	=	Side	Size	/	Colour
2C20	=	L	26	/	4



Spectra protective sock black

Reference number SL=SPECTRA-SOCK-7

The long Spectra sock in black is an accessory for prosthetic feet. It protects the foot against soiling and prevents possible noises that could develop due to the movement of the prosthesis in the cosmetic foot cover.

Technical data

Article number	SL=SPECTRA-SOCK-7
-----------------------	--------------------------

Prosthetic feet

Mobility grade 2–3



Custom silicone cover lower limb

Reference number 88A20

For many users, a natural outward appearance is just as important as the functional benefits of a prosthesis. With high-end, custom-made silicone covers for leg prostheses, Ottobock gives you the opportunity to make this dream come true for your users. The Ottobock iFab acts as your extended workbench for the fabrication of aesthetically pleasing silicone covers, as they are made to your precise and individual specifications – quickly, reliably and in the highest quality.

Technical data

Article image	Article number	Description	Product features
	88A20=C	Custom silicone covers for the lower limbs	<ul style="list-style-type: none">· Anatomical shape· Custom silicone cover in two to three colours· Anatomical surface structure· Single-colour silicone toenails with colour-compatible nail tip
	88A20=N	Custom silicone covers for the lower limbs	<ul style="list-style-type: none">· Anatomical shape· Custom silicone cover in 8-10 colours· Anatomical surface structure· Single-colour silicone toenails with colour-compatible nail tip

• You will find further information on custom silicone covers for the lower limbs in the "Prosthesis covers" section.

Prosthetic feet

Mobility grade 2–3



Meridium

Reference number 1B1-2

The individually adjustable 1B1-2 Meridium prosthetic foot features an especially close approximation of the anatomy of the human foot. The four-axis design with intelligent hydraulic control in real time and a very large range of motion is moveable in the area of the ankle, foot and toes and adapts with no time delay.

Key features

- Natural motion sequence while walking
- Range of motion of 36.5° (22° PF; 14.5° DF)
- Automatic real-time adjustment to uneven terrain, ramps and slopes
- Intuitive stance permits stable standing on level ground and slopes
- Reduced risk of stumbling thanks to increased ground clearance in the swing phase
- Lets the user descend stairs more safely with full-foot contact
- Relief function provides a comfortable, more natural foot position while sitting
- Automatic heel height adjustment from 0 to 5 cm so shoes can be changed easily
- Weatherproof with IP54

Information material

647G1441=ALL_INT	IFU Qualified Personell Meridium
647H64-1=ALL_INT	IFU User Meridium languages part 1
647H64-2=ALL_INT	IFU User Meridium languages part 2

Scope of delivery

1B1-2	Meridium	1	Piece
2C7	Footshell	1	Piece
4G872	Set of cover caps	1	Piece
2C101	Footshell replacement tool, plastic	1	Piece
4E50-2	Battery charger	1	Piece
757L16-4	Power supply unit	1	Piece



Max. 100 kg
Size 24 to 25 cm



Max. 125 kg
Size 26 to 29 cm

Technical data

Mobility grade	2, 3
Max. body weight	125 kg
Side	left (L), right (R)
Sizes	24-29 cm
Weight*	1330 g
Weight with footshell*	1485 g
System height with footshell*	142 mm
Build height with footshell*	160 mm
Heel height	0-50 mm
Range of motion	36.5° (22° PF; 14.5° DF)
Footshell colour	translucent (1), beige (4), light brown (15)

* Technical data refer to the size of 26 cm

Order example

Reference number	=	Side	=	Size
1B1-2	=	L	=	26

Meridium

Explore new paths.



Prosthetic feet

Mobility grade 2–3

Accessories/spare parts for 1B1-2



Information material

647G1522=ALL_INT IFU 2C7

Scope of delivery

2C7	Footshell	1	Piece
-----	-----------	---	-------

Footshell

Reference number 2C7

The 2C7 footshell is a protective cover for the 1B1-2 Meridium prosthetic foot. Its external shape creates a natural appearance. It is available in the colours translucent, beige and light brown.

Technical data

Reference number	2C7=*
Side	left (L), right (R)
Size	24-29 cm
Weight*	155 g
Colour	translucent (1), beige (4), light brown (15)

* Technical data refer to the size of 26 cm

Order example

Reference number	=	Side	Size	/	Colour
2C7	=	L	26	/	15



Cockpit app

Reference number 4X441-*

The Cockpit app allows users to easily adjust various Ottobock electronic prostheses and orthoses to their individual needs in day-to-day life. Depending on the component's range of functions one can, for example, select preconfigured MyModes for specific activities, read information such as the battery charge level, turn additional functions on or off and adjust settings. The Cockpit app is available in the App Store for iPhones and the Google Play Store for Android devices.

Technical data

Article number

4X441-*



M-Soft

Reference number 4X154

Adjustment software for the Meridium prosthetic foot.

Technical data

Article number

4X154=V1.4

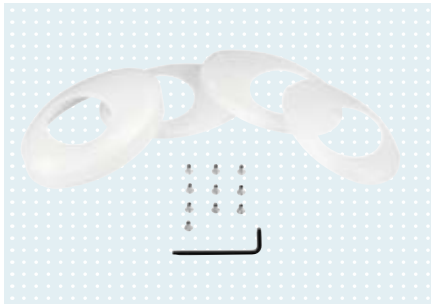

Set of cover caps

Reference number 4G872

Consists of the cover cap with charging receptacle, a cover plate and connection plates for the cosmetic foam cover and protective cover, four Torx screws and T10 Torx screwdriver. Available in the colours translucent (1), beige (4) and light brown (15).

Technical data

Article number	Sizes	Colours
4G872=*	24-25 cm	translucent (1), beige (4), light brown (15)
4G872=*	26-29 cm	translucent (1), beige (4), light brown (15)



Charging cable receptacle closure

Reference number 2G72

The 2G72 closure is a spare part for the charging cable receptacle of the Meridium prosthetic foot. It is available in the colours translucent, beige and light brown. The closure is also included in the 4G872 cover cap set.

Technical data

Article number	Colour
2G72	Translucent
2G72=1	Skin colour
2G72=2	Light brown



BionicLink PC

Reference number 60X5

The BionicLink USB Bluetooth adapter supports wireless data communication between Ottobock products with a Bluetooth interface and a PC with a USB port or USB hub via corresponding Ottobock software products.

Technical data

Article number	for
60X5	Connection to computer (USB Bluetooth adapter)



Power supply unit

Reference number 757L16-4

The power supply for electronic prosthetic components and orthoses from Ottobock. Adapters for the EU and US are included in the scope of delivery. Additional adapters can be ordered under the following article numbers:

- Great Britain: 757S1=GB-4
- Australia: 757S1=AUS-4
- Argentina: 757S1=ARG-4

Technical data

Article number
757L16-4

Prosthetic feet

Mobility grade 2–3



Battery charger

Reference number 4E50-2

For the C-Brace® orthotronic mobility system, the C-Leg knee joint and the Meridium prosthetic foot.

Technical data

Article number

4E50-2



Y-adapter cable

Reference number 757P48

Y-adapter cable for connecting two components (e.g. for C-Leg and Meridium) to a joint power supply. Two Genium or Genium X3 prosthetic joints cannot be charged simultaneously due to the increased power consumption.

Technical data

Article number

757P48



Clamping tool

Reference number 704G30

The clamping tool ensures a secure hold in the vice for pulling on the Meridium footshell and protects the pyramid in the process.

Technical data

Article number

704G30



Footshell replacement tool, plastic

Reference number 2C101

The 2C101 shoehorn is a plastic tool for replacing the footshell on prosthetic feet. In addition to a grey marble look, the shoehorn has a hole to hang it up.

Technical data

Article number

2C101

Material

Plastic

Prosthetic feet

Mobility grade 3–4



C-Walk

Reference number 1C40

The 1C40 C-Walk is designed for users who want a prosthetic foot with multi-axial mobility, flexible shock absorption at heel strike and comfortable walking uphill and on inclines. It is suitable for users in mobility grades 3–4 and a body weight of up to 100 kg.

Key features

- Controlled plantar flexion up to 12°
- Multi-axial mobility to compensate for uneven surfaces
- Reduction of strain on the sound limb
- Elastic damping at heel strike
- Physiological rollover
- Smooth transition from the stance to the swing phase
- Comfortable walking on slopes and inclines

Information material

647G1520=ALL_INT IFU C-Walk

Scope of delivery

1C40	C-Walk	1 Piece
2C4	Footshell	1 Piece
2C11	Connection cover	1 Piece



Max. 75 kg
Size 24 to 25 cm



Max. 100 kg
Size 26 to 30 cm

Technical data

Mobility grade	3, 4
Max. body weight	100 kg
Side	left (L), right (R)
Sizes	24-30 cm
Weight without footshell*	480 g
Footshell shape	Normal shape for a heel height of 10 +/- 5 mm
Footshell colour	beige (4), light brown (15)
Weight with normal footshell*	695 g
System height with normal footshell*	81 mm
Build height with normal footshell*	99 mm

* Technical data refer to the size of 26 cm

- This foot can be equipped with a custom silicone cover. See the section "Prosthesis covers" for detailed information.

Order example

Reference number	= Side	Size	- 0 - P / Colour
1C40	= L	26	- 0 - P / 4

Accessories/spare parts for 1C40



Information material	
647G333=ALL_INT	IFU Footshell

Scope of delivery			
2C4	Footshell	1	Piece
2C11	Connection cover	1	Piece

Footshell

Reference number 2C4

The 2C4 footshell is a protective cover for the 1C40 C-Walk prosthetic foot. Its external shape creates a natural appearance. It is available in the colours beige and light brown.

Technical data

Reference number	2C4=*		
Side	left (L), right (R)		
Shape	normal shape		
Size	24-30 cm		
Weight*	215 g		
Heel height	10 +/- 5 mm		
Colour	beige (4), light brown (15)		

* Technical data refer to the size of 26 cm

Order example

Reference number	= Side	Size	/ Colour
2C4	= L	26	/ 4



Connection cover

Reference number 2C11

In combination with the 2C4 footshell or the 1D35 Dynamic Motion, the 2C11 connection cover forms an attractive cosmetic cover that can be glued to a foam cover.

Technical data

Reference number	2C11=*		
Side	left (L), right (R)		
Size	23-25 cm, 26-28 cm, 29-30 cm		
Colour	beige (4), light brown (15)		
for	Footshells 2C4=*		
	Dynamic Motion 1D35=* (sizes 23–30 cm)		

Order example

Reference number	= Side	Size	/ Colour
2C4	= L	26	/ 4

Prosthetic feet

Mobility grade 3–4



Custom silicone cover lower limb

Reference number 88A20

For many users, a natural outward appearance is just as important as the functional benefits of a prosthesis. With high-end, custom-made silicone covers for leg prostheses, Ottobock gives you the opportunity to make this dream come true for your users. The Ottobock iFab acts as your extended workbench for the fabrication of aesthetically pleasing silicone covers, as they are made to your precise and individual specifications – quickly, reliably and in the highest quality.

Technical data

Article image	Article number	Description	Product features
	88A20=C	Custom silicone covers for the lower limbs	<ul style="list-style-type: none">· Anatomical shape· Custom silicone cover in two to three colours· Anatomical surface structure· Single-colour silicone toenails with colour-compatible nail tip
	88A20=N	Custom silicone covers for the lower limbs	<ul style="list-style-type: none">· Anatomical shape· Custom silicone cover in 8-10 colours· Anatomical surface structure· Single-colour silicone toenails with colour-compatible nail tip

• You will find further information on custom silicone covers for the lower limbs in the "Prosthesis covers" section.



Axtion

Reference number 1E56

The 1E56 Axtion is a compact and lightweight high-performance foot for active amputees. The combination of flexible carbon springs and elastic polyurethane offers the user the highest performance in all gait phases for both everyday activities and recreational sports.

Key features

- Lightweight carbon-polyurethane design with especially low structural height
- Effective shock absorption
- Individually adaptable heel stiffness
- Compensation of smaller surface irregularities
- Outstanding forefoot dynamics and excellent energy return for powerful and controlled toe-off

Information material

647G493=ALL_INT IFU Axtion

Scope of delivery

1E56	Axtion	1	Piece
2F20	Heel wedge for Axtion	1	Set
SL=SPECTRA-SOCK-7	Spectra protective sock black	1	Piece



Technical data

Mobility grade	3, 4
Max. body weight	125 kg
Side	neutral (N)
Sizes	22-31 cm
Weight without footshell*	355 g
Shape of footshell	Normal shape for a heel height of 13 +/- 5 mm
Colour of footshell	beige (4), light brown (15)
Weight with normal footshell*	580 g
System height with normal footshell*	35 mm
Build height with normal footshell*	53 mm

* Technical data refer to the size of 26 cm

- The footshell is not included in the scope of delivery. It must be ordered separately as an accessory.
- This foot can be equipped with a custom silicone cover. See the section "Prosthesis covers" for detailed information.

Stiffness chart

Body weight	Foot size									
	22 cm	23 cm	24 cm	25 cm	26 cm	27 cm	28 cm	29 cm	30 cm	31 cm
up to 50 kg	1	1	1	1	1	1	1	1	1	1
51–65 kg	2	2	2	2	2	2	2	2	2	2
66–85 kg	3	3	3	3	3	3	3	3	3	3
86–100 kg	4	4	4	4	4	4	4	4	4	4
101–125 kg	5	5	5	5	5	5	5	5	5	5

■ no stock items □ stock items

Order example

Reference number	=	Side	Size	-	Stiffness	-	P / Colour
1E56	=	N	26	-	3	-	P / 0



reddot design award
winner 2005

Prosthetic feet

Mobility grade 3–4

Accessories/spare parts for 1E56



Information material

647G333=ALL_INT	IFU Footshell
-----------------	---------------

Scope of delivery

2C5	Footshell	1	Piece
2C10	Connection cover	1	Piece

Footshell

Reference number 2C5

The 2C5 footshell is a protective cover for the 1E* prosthetic feet. Its external shape creates a natural appearance. It is available in the colours beige and light brown.

Technical data

Reference number	2C5=*
Side	left (L), right (R)
Shape	normal shape
Size	22-31 cm
Weight*	225 g
Heel height	10 +/- 5 mm
Colour	beige (4), light brown (15)

Order example

Reference number	=	Side	Size	/	Colour
2C5	=	L	26	/	4

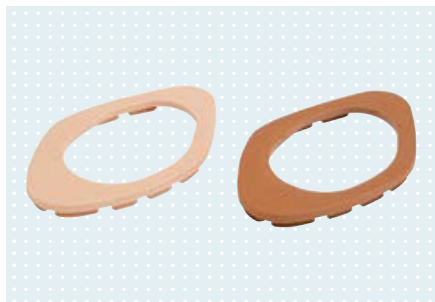

Connection cover

Reference number 2C10

In combination with the 2C3 and 2C5 footshells or the 1D35 Dynamic Motion, the 2C10 connection cover forms an attractive cosmetic cover that can be glued to a foam cover.

Technical data

Reference number	2C10=*
Side	left (L), right (R)
Size	21-22 cm, 23-25 cm, 26-28 cm, 29-31 cm
Colour	beige (4), light brown (15)
for	Footshells 2C3=* and 2C5=*
	Dynamic Motion 1D35=* (sizes 21–22 cm)

Order example

Reference number	=	Side	Size range	/	Colour
2C10	=	L	26-28	/	4



Heel wedge for Axtion

Reference number 2F20

The 2F20 heel wedge set consists of a soft transparent wedge and a stiff black wedge for customising the heel characteristics.

Technical data

Article number	Size
2F20=22-25	22–25 cm
2F20=26-31	26–31 cm



Spectra protective sock black

Reference number SL=SPECTRA-SOCK-7

The long Spectra sock in black is an accessory for prosthetic feet. It protects the foot against soiling and prevents possible noises that could develop due to the movement of the prosthesis in the cosmetic foot cover.

Technical data

Article number

SL=SPECTRA-SOCK-7



Custom silicone cover lower limb

Reference number 88A20

For many users, a natural outward appearance is just as important as the functional benefits of a prosthesis. With high-end, custom-made silicone covers for leg prostheses, Ottobock gives you the opportunity to make this dream come true for your users. The Ottobock iFab acts as your extended workbench for the fabrication of aesthetically pleasing silicone covers, as they are made to your precise and individual specifications – quickly, reliably and in the highest quality.

Technical data

Article image	Article number	Description	Product features
	88A20=C	Custom silicone covers for the lower limbs	<ul style="list-style-type: none"> Anatomical shape Custom silicone cover in two to three colours Anatomical surface structure Single-colour silicone toenails with colour-compatible nail tip
	88A20=N	Custom silicone covers for the lower limbs	<ul style="list-style-type: none"> Anatomical shape Custom silicone cover in 8-10 colours Anatomical surface structure Single-colour silicone toenails with colour-compatible nail tip

• You will find further information on custom silicone covers for the lower limbs in the "Prosthesis covers" section.

Prosthetic feet

Mobility grade 3–4



Taleo

Reference number 1C50

The 1C50 Taleo was designed for active individuals who navigate varied indoor and outdoor environments and place a high value on effortless walking and the ability to go wherever life takes them.

Key features

- Dual springs and a long carbon base spring enable a smooth rollover and efficient energy return at a wide range of walking speeds
- The unique flexible connection of the carbon springs in the forefoot results in optimal adaptation to varying ground conditions
- Customisable shock absorption with three different heel wedge options
- Protected against fresh, salt and chlorinated water
- Water runoff contours on the adapter and openings in the sole of the foot prevent water from collecting in the prosthesis
- Slim connection adapter is suitable for fitting with a cosmesis

Information material

647G2009=ALL_INT IFU 1C50 1C53

Scope of delivery

1C50	Taleo		1	Piece
2C15	Footshell		1	Piece
2C19	Connection cover	with normal footshell	1	Piece
2C20	Connection cover	with slim footshell	1	Piece
2F50	Heel wedges for Taleo		1	set
SL=SPECTRA-SOCK-7	Spectra protective sock black		1	Piece

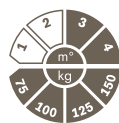

Max. 150 kg

Technical data

Mobility grade	3, 4
Max. body weight	150 kg
Side	left (L), right (R)
Sizes	22-30 cm
Weight without footshell*	461 g
Shape of footshell	Slim shape (S) for a heel height of 15 +/- 5 mm (22-25 cm) Normal shape (N) for a heel height of 10 +/- 5 mm (24-30 cm)
Colour of footshell	beige (4), light brown (15)
Weight with normal footshell*	690 g
System height with normal footshell*	132 mm
Build height with normal footshell*	150 mm

* Technical data refer to the size of 26 cm

Taleo

Ready for everyday life.

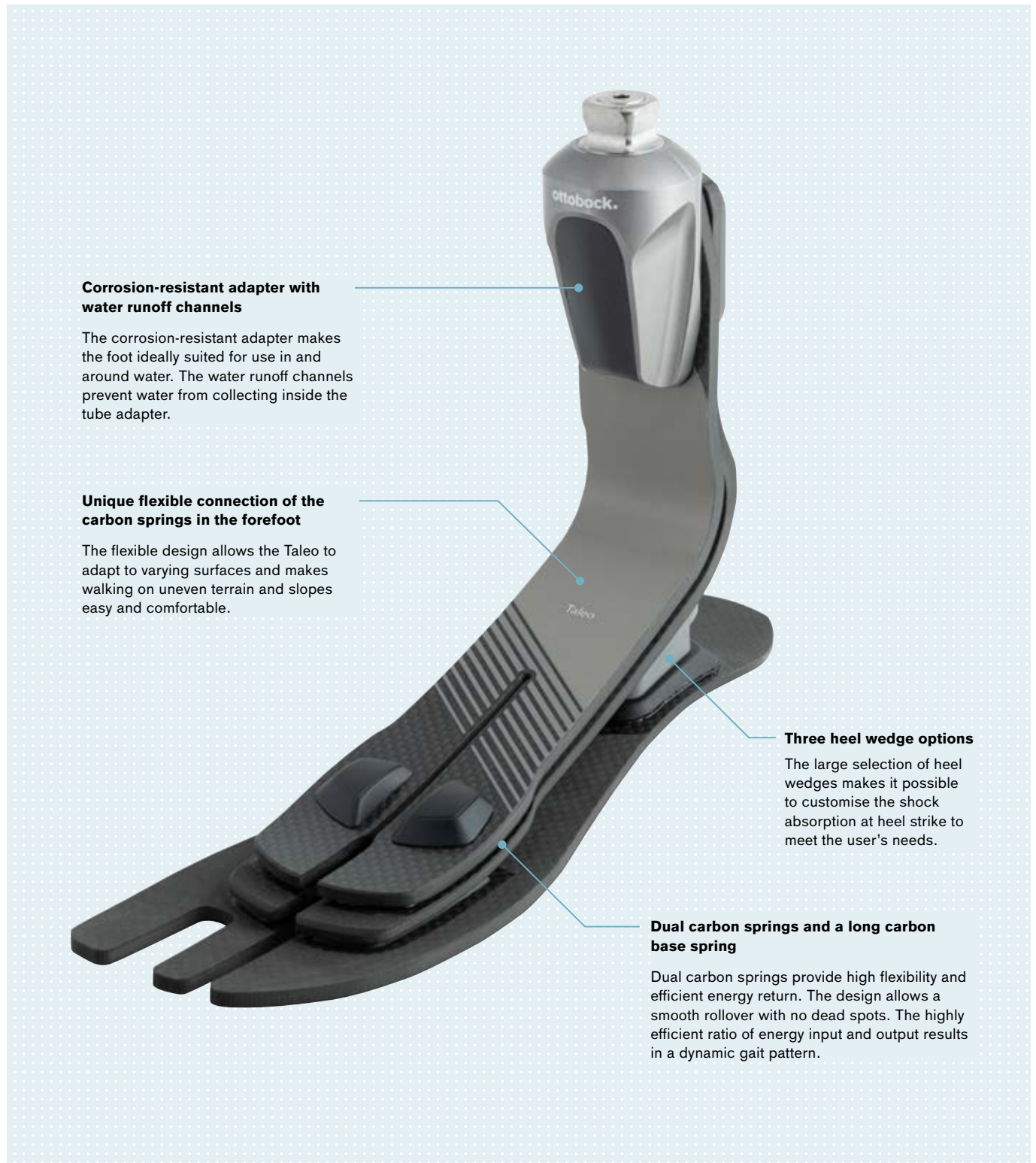

Corrosion-resistant adapter with water runoff channels

The corrosion-resistant adapter makes the foot ideally suited for use in and around water. The water runoff channels prevent water from collecting inside the tube adapter.

Unique flexible connection of the carbon springs in the forefoot

The flexible design allows the Taleo to adapt to varying surfaces and makes walking on uneven terrain and slopes easy and comfortable.

Three heel wedge options

The large selection of heel wedges makes it possible to customise the shock absorption at heel strike to meet the user's needs.

Dual carbon springs and a long carbon base spring

Dual carbon springs provide high flexibility and efficient energy return. The design allows a smooth rollover with no dead spots. The highly efficient ratio of energy input and output results in a dynamic gait pattern.

Prosthetic feet

Mobility grade 3–4

Selection of the spring stiffness relative to

1 body weight and activity as well as

Body weight [kg]	Normal activity level	High activity level
up to 51	1	2
52–58	2	3
59–67	3	4
68–77	4	5
78–88	5	6
89–100	6	7
101–115	7	8
116–130	8	9
131–150	9	–

2 foot size

Stiffness	Foot size								
	1	2	3	4	5	6	7	8	9
22						–	–	–	–
23							–	–	–
24								–	–
25									–
26								*	–
27	–	–						*	*
28	–	–						*	*
29	–	–	–				*	*	*
30	–	–	–				*	*	*

* Do not combine this configuration with a 3C88-3/3C98-3 C-Leg 4.

◻ Slim footshell available
(15 ± 5 mm heel height)

◻ Both footshells available

◻ Normal footshell available
(10 ± 5 mm heel height)

Order example

Reference number	= Side	Size	- Stiffness	- P	/ Colour	Shape
1C50	= L	26	- 4	- P	/ 4	N

Accessories/spare parts for 1C50



Taleo bolt cover

Reference number 2F51

The 2F51 bolt cover is a cosmetic cover for the pyramid attachment screws of the 1C50 Taleo and the housing attachment of the 1C51 Taleo Vertical Shock and 1C52 Taleo Harmony. It is available in two different sizes.

Technical data

Article number	Size
2F51=22-25	22-25 cm
2F51=26-30	26-30 cm



Taleo Vertical Shock

Reference number 1C51

The 1C51 Taleo Vertical Shock was designed for active individuals who navigate varied indoor and outdoor environments and place a high value on effortless walking and the ability to go wherever life takes them. It noticeably relieves the residual limb by effectively absorbing torsion. Together with strong shock absorption, this results in more comfort in everyday life.

Key features

- Effectively absorbs torsion (+/- 10°) to relieve the residual limb and boost comfort in everyday life in combination with vertical shock absorption (up to 15 mm)
- Double carbon springs and a long carbon base spring enable a smooth rollover and efficient energy return at a wide range of walking speeds
- The unique flexible connection of the carbon springs in the forefoot results in optimal adaptation to varying ground conditions
- Custom shock absorption thanks to three different heel wedge options
- Water runoff contours on the adapter and openings in the sole of the foot prevent water from collecting in the prosthesis

Information material

647G1506=ALL_INT IFU 1C51 1C52

Scope of delivery

1C51	Taleo Vertical Shock		1 Piece
2C15	Footshell		1 Piece
2C19	Connection cover	with normal footshell	1 Piece
2C20	Connection cover	with slim footshell	1 Piece
2F50	Heel wedges for Taleo		1 set
2Z362	Taleo Vertical Shock functional ring set		1 set
SL=SPECTRA-SOCK-7	Spectra protective sock black		1 Piece



Max. 150 kg

Technical data

Mobility grade	3, 4
Max. body weight	150 kg
Side	left (L), right (R)
Sizes	22-30 cm
Weight without footshell*	751 g
Shape of footshell	Slim shape for a heel height of 15 +/- 5 mm (22-25 cm) Normal shape for a heel height of 10 +/- 5 mm (24-30 cm)
Colour of footshell	beige (4), light brown (15)
Weight with normal footshell*	980 g
System height with normal footshell*	167 mm
Build height with normal footshell*	185 mm

* Technical data refer to the size of 26 cm

Prosthetic feet

Mobility grade 3–4

Selection of the spring stiffness relative to

1 body weight and activity as well as

Body weight [kg]	Normal activity level	High activity level
up to 51	1	2
52 – 58	2	3
59 – 67	3	4
68 – 77	4	5
78 – 88	5	6
89 – 100	6	7
101 – 115	7	8
116 – 130	8	9
131 – 150	9	–

2 foot size

Stiffness Foot size	Stiffness								
	1	2	3	4	5	6	7	8	9
22						–	–	–	–
23							–	–	–
24								–	–
25									–
26								*	–
27	–	–						*	*
28	–	–						*	*
29	–	–	–					*	*
30	–	–	–					*	*

* Do not combine this configuration with a 3C88-3/3C98-3 C-Leg 4.

Slim footshell available (15 ± 5 mm heel height)
 Both footshells available
 Normal footshell available (10 ± 5 mm heel height)

Order example

Reference number	Side	Size	Stiffness	P	Colour	Shape
1C51	R	26	4	P 4		N

Accessories/spare parts for 1C51



Taleo Vertical Shock functional ring set

Reference number 2Z362

The 2Z362 functional ring is a component of the 1C51 Taleo Vertical Shock prosthetic foot. It is available as a spare part in various stiffness categories adapted to the corresponding weight classification of the foot.

Technical data

Article number	Functional ring stiffness	Max. body weight
2Z362=1	1	51 kg
2Z362=2	2	58 kg
2Z362=3	3	67 kg
2Z362=4	4	77 kg
2Z362=5	5	88 kg
2Z362=6	6	100 kg
2Z362=7	7	115 kg
2Z362=8	8	130 kg
2Z362=9	9	150 kg



Taleo bolt cover

Reference number 2F51

The 2F51 bolt cover is a cosmetic cover for the pyramid attachment screws of the 1C50 Taleo and the housing attachment of the 1C51 Taleo Vertical Shock and 1C52 Taleo Harmony. It is available in two different sizes.

Technical data

Article number	Size
2F51=22-25	22-25 cm
2F51=26-30	26-30 cm

Prosthetic feet

Mobility grade 3–4



Taleo Harmony

Reference number 1C52

The 1C52 Taleo Harmony was designed for active individuals who navigate varied indoor and outdoor environments and place a high value on effortless walking and the ability to go wherever life takes them. Thanks to the integrated vacuum system, it ensures a firm hold and better control over the prosthesis throughout the day, as well as boosting comfort.

Key features

- Integrated Harmony P3 pump ensures the prosthesis fits firmly at all times
- Effectively absorbs torsion (+/- 10°) to relieve the residual limb and boost comfort in everyday life in combination with vertical shock absorption (up to 15 mm)
- Double carbon springs and a long carbon base spring enable a smooth rollover and efficient energy return at a wide range of walking speeds
- The unique flexible connection of the carbon springs in the forefoot results in optimal adaptation to varying ground conditions
- Custom shock absorption thanks to three different heel wedge options
- Water runoff contours on the adapter and openings in the sole of the foot prevent water from collecting in the prosthesis

Information material

647G1506=ALL_INT IFU 1C51 1C52

Scope of delivery

1C52	Taleo Harmony	1	Piece
2C15	Footshell	1	Piece
2C19	Connection cover with normal footshell	1	Piece
2C20	Connection cover with slim footshell	1	Piece
2F50	Heel wedges for Taleo	1	Set
2Z360	Plastic tube	1	Set
2R117	Socket connector	1	Piece
SL=SPECTRA-SOCK-7	Spectra protective sock black	1	Piece

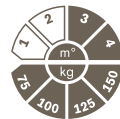

Max. 150 kg

Technical data

Mobility grade	3, 4
Max. body weight	150 kg
Side	left (L), right (R)
Sizes	22-30 cm
Weight without footshell*	751 g
Shape of footshell	Slim shape for a heel height of 15 +/- 5 mm (22-25 cm) Normal shape for a heel height of 10 +/- 5 mm (24-30 cm)
Colour of footshell	beige (4), light brown (15)
Weight with normal footshell*	980 g
System height with normal footshell*	167 mm
Build height with normal footshell*	185 mm

* Technical data refer to the size of 26 cm

- Please order the 4Y383 cosmetic exhaust flange for a cosmetic cover separately.

Selection of the spring stiffness relative to

1 body weight and activity as well as

Body weight [kg]	Normal activity level	High activity level
up to 51	1	2
52 – 58	2	3
59 – 67	3	4
68 – 77	4	5
78 – 88	5	6
89 – 100	6	7
101 – 115	7	8
116 – 130	8	9
131 – 150	9	–

2 foot size

Stiffness	Foot size								
	1	2	3	4	5	6	7	8	9
22									
23									
24									
25									
26								*	
27								*	*
28								*	*
29								*	*
30								*	*

* Do not combine this configuration with a 3C88-3/3C98-3 C-Leg 4.

Slim footshell available (15 ± 5 mm heel height)
 Both footshells available
 Normal footshell available (10 ± 5 mm heel height)

Order example

Reference number	Side	Size	Stiffness	P - /	Colour	Shape
1C52	R	26	4	P - / 4		N

Prosthetic feet

Mobility grade 3–4

Accessories/spare parts for 1C52



Taleo Harmony functional ring

Reference number 2Z360

The 2Z360 functional ring is a spare part for the 1C52 Taleo Harmony prosthetic foot. The scope of delivery includes the functional ring with two valves, two O-rings, spacer washer and lubricant.

Technical data

Article number	Functional ring stiffness	Max. body weight
2Z360=1	1	51 kg
2Z360=2	2	58 kg
2Z360=3	3	67 kg
2Z360=4	4	77 kg
2Z360=5	5	88 kg
2Z360=6	6	100 kg
2Z360=7	7	115 kg
2Z360=8	8	130 kg
2Z360=9	9	150 kg



Taleo bolt cover

Reference number 2F51

The 2F51 bolt cover is a cosmetic cover for the pyramid attachment screws of the 1C50 Taleo and the housing attachment of the 1C51 Taleo Vertical Shock and 1C52 Taleo Harmony. It is available in two different sizes.

Technical data

Article number	Size
2F51=22-25	22-25 cm
2F51=26-30	26-30 cm



Harmony valve with filter

Reference number 2Z361

This is a spare part for the 1C52 Taleo Harmony prosthetic foot.

Technical data

Article number
2Z361

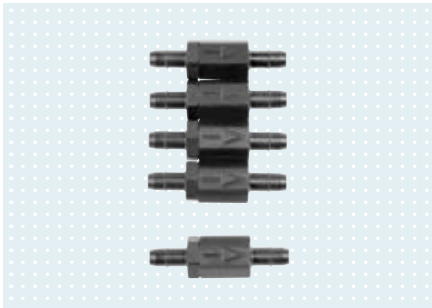

V4 valve, straight

Reference number 4R142

This is a spare part for the 4R136 V4 valve kit and the 4R136=EL V4 EasyLine valve kit as well as the 1C52 Taleo Harmony and 1C62 Triton Harmony prosthetic feet.

Technical data

Article number

4R142

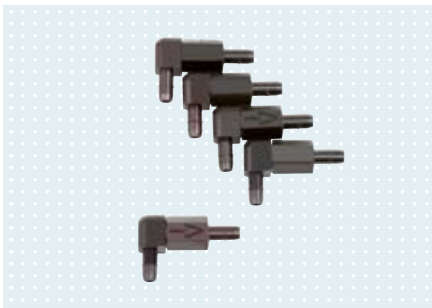

V4 valve, right-angled

Reference number 4R143

This is a spare part for the 4R136 V4 valve kit and the 4R136=EL V4 EasyLine valve kit as well as the 1C52 Taleo Harmony and 1C62 Triton Harmony prosthetic feet.

Technical data

Article number

4R143

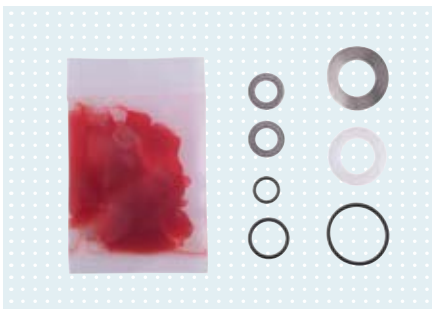

Harmony P3 service set

Reference number 4X148

The 4X148 service set is a spare part for the Harmony P3 system. It consists of two small and two large spacer washers, three O-rings and a lubricant.

Technical data

Article number

4X148

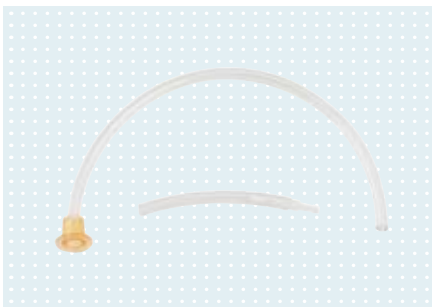

Cosmetic exhaust flange

Reference number 4Y383

The 4Y383 is used in prostheses with the Harmony P3 system that have a cosmetic cover. The Harmony flange kit is mounted on the outlet valve of the Harmony to conduct liquids to the outside of the foam cover.

Technical data

Article number

4Y383

Spare part for

3R60=VC

Prosthetic feet

Mobility grade 3–4



Taleo Low Profile

Reference number 1C53

The 1C53 Taleo Low Profile was designed for active individuals who navigate varied indoor and outdoor environments and place a high value on effortless walking and the ability to go wherever life takes them.

Key features

- Dual carbon springs enable a smooth rollover and efficient energy return at a wide range of walking speeds
- Flexible connection of the carbon springs in the forefoot results in optimal adaptation to varying ground conditions
- The unique pyramid design enables more controlled forward movement during the rollover than normal with low profile feet
- Customisable shock absorption with three different heel wedge options
- Protected against fresh, salt and chlorinated water
- Water runoff contours on the adapter and openings in the sole of the foot prevent water from collecting in the prosthesis
- Low build height

Information material

647G2009=ALL_INT	IFU 1C50 1C53
------------------	---------------

Scope of delivery

1C53	Taleo Low Profile		1	Piece
2C15	Footshell		1	Piece
2C19	Connection cover	with normal footshell	1	Piece
2C20	Connection cover	with slim footshell	1	Piece
2F50	Heel wedges for Taleo		1	Set
SL=SPECTRA-SOCK-7	Spectra protective sock black		1	Piece

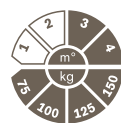

Max. 150 kg

Technical data

Mobility grade	3, 4
Max. body weight	150 kg
Side	left (L), right (R)
Sizes	22-30 cm
Weight without footshell*	355 g
Shape of footshell	Slim shape (S) for a heel height of 15 +/- 5 mm (22-25 cm) Normal shape (N) for a heel height of 10 +/- 5 mm (24-30 cm)
Footshell colour	beige (4), light brown (15)
Weight with normal footshell*	584 g
System height with normal footshell*	47 mm
Build height with normal footshell*	65 mm

* Technical data refer to the size of 26 cm

Selection of the spring stiffness relative to

① body weight and activity as well as

Body weight [kg]	Normal activity level	High activity level
up to 51	1	2
52–58	2	3
59–67	3	4
68–77	4	5
78–88	5	6
89–100	6	7
101–115	7	8
116–130	8	9
131–150	9	–

2 foot size

Stiffness	Foot size								
	1	2	3	4	5	6	7	8	9
Foot size									
22	Light	Light	Light	Light	Light	-	-	-	-
23	Light	Light	Light	Light	Light	Light	-	-	-
24	Light	Light	Light	Light	Light	Light	Light	-	-
25	Light	Light	Light	Light	Light	Light	Light	Light	-
26	Light	Light	Light	Light	Light	Light	Light	Light	Light
27	-	-	Light	Light	Light	Light	Light	Light	Light
28	-	-	Light	Light	Light	Light	Light	Light	Light
29	-	-	-	Light	Light	Light	Light	Light	Light
30	-	-	-	Light	Light	Light	Light	Light	Light

* Do not combine this configuration with a 3C88-3/3C98-3 C-Leg 4.

Light Slim footshell available (15 ± 5 mm heel height)

Light Both footshells available

Light Normal footshell available (10 ± 5 mm heel height)

Order example

Reference number	= Side	Size	- Stiffness	- P / Colour	Shape
1C53	= L	26	- 4	- P / 4	N

Accessories/spare parts for 1C53



Taleo Low Profile bolt cover

Reference number 2F52

The 2F52 bolt cover is a cosmetic cover for the pyramid attachment screws of the Taleo Low Profile. It is available in two different sizes.

Technical data

Article number	
2F52=1	22-30 cm
2F52=2	27-30 cm

Selection chart

Stiffness	Foot size								
	22	23	24	25	26	27	28	29	30
1	Light	Light	Light	Light	Light	-	-	-	-
2	Light	Light	Light	Light	Light	-	-	-	-
3	Light	Light	Light	Light	Light	Light	Light	-	-
4	Light	Light	Light	Light	Light	Light	Light	Light	Light
5	Light	Light	Light	Light	Light	Light	Light	Light	Light
6	-	Light	Light	Light	Light	Light	Light	Light	Light
7	-	-	-	Light	Light	Light	Light	Light	Light
8	-	-	-	-	Light	Light	Light	Light	Light
9	-	-	-	-	-	Light	Light	Light	Light

Light Please order the 2F52=1 bolt cover.

Light Please order the 2F52=2 bolt cover.

Prosthetic feet

Mobility grade 3–4

Accessories/spare parts for 1C50, 1C51, 1C52, 1C53



Information material

647G333=ALL_INT	IFU Footshell
-----------------	---------------

Scope of delivery

2C15	Footshell	1	Piece
2C19	Connection cover with normal footshell	1	Piece
2C20	Connection cover with slim footshell	1	Piece

Footshell

Reference number 2C15

The 2C15 footshell is a protective cover for the Taleo prosthetic feet. Its external shape creates a natural appearance. It also features alignment marks that enable straightforward and fast bench alignment as well as openings in the sole of the foot that allow water to drain away.

Technical data

Reference number	2C15=*N	2C15=*S
Side	left (L), right (R)	left (L), right (R)
Shape	normal shape (N)	slim shape (S)
Size	22-30 cm	22-25 cm
Weight	229 g*	184 g**
Heel height	10 +/- 5 mm	15 +/- 5 mm
Colour	beige (4), light brown (15)	beige (4), light brown (15)
	* Technical data refer to the size of 26 cm	** Technical data refer to the size of 25 cm

Order example

Reference number	=	Side	Size	/	Colour	Shape
2C15	=	L	26	/	4	N

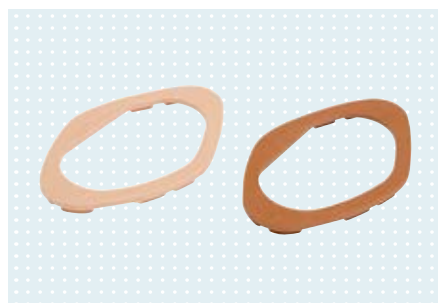

Information material

647G333=ALL_INT	IFU Footshell
-----------------	---------------

Scope of delivery

2C15	Footshell	1	Piece
2C19	Connection cover	1	Piece
2C20	Connection cover	1	Piece

Connection cover

Reference number 2C19

In combination with the 2C1, 2C6 and 2C15 footshells in the normal foot shape, the 2C19 connection cover forms an attractive cosmetic cover that can be glued to a foam cover.

Technical data

Reference number	2C19=*
Side	left (L), right (R)
Size	22 cm, 23-25 cm, 26-28 cm, 29-31 cm
Colour	beige (4), light brown (15)
for	Footshells 2C1=*N, 2C6=*N, 2C15=*N

Order example

Reference number	=	Side	Size range	/	Colour
2C19	=	L	26-28	/	4

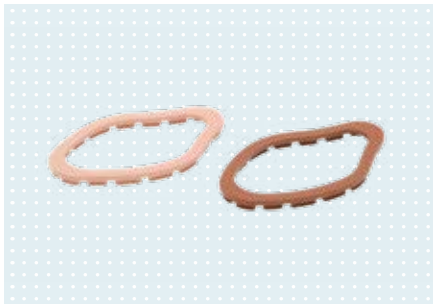

Connection cover

Reference number 2C20

In combination with the 2C1, 2C3, 2C6 and 2C15 footshells in the slim foot shape, the 2C20 connection cover forms an attractive cosmetic cover that can be glued to a foam cover.

Technical data

Reference number	2C20=*
Side	left (L), right (R)
Size	21-27 cm
Colour	beige (4), light brown (15)
for	Footshells 2C1=*S, 2C3=*S, 2C6=*S, 2C15=S*

Order example

Reference number	= Side	Size	/ Colour
2C20	= L	26	/ 4



Heel wedges for Taleo

Reference number 2F50

The 2F50 heel wedge set contains three heel wedges in various degrees of hardness, permitting individual adaptation of the heel stiffness for the user.

Technical data

Article number	Size
2F50=26-28	26-28 cm
2F50=22-25	22-25 cm
2F50=29-30	29-30 cm



Spectra protective sock black

Reference number SL=SPECTRA-SOCK-7

The long Spectra sock in black is an accessory for prosthetic feet. It protects the foot against soiling and prevents possible noises that could develop due to the movement of the prosthesis in the cosmetic foot cover.

Technical data

Article number	SL=SPECTRA-SOCK-7
-----------------------	-------------------

Prosthetic feet

Mobility grade 3–4



Triton

Reference number 1C60

The 1C60 Triton is a versatile carbon prosthetic foot that is perfect for meeting the needs of highly active individuals who navigate varied indoor and outdoor environments and place a high value on uncompromised response.

Key features

- The linear spring design provides the level of support in the stance phase that is needed for activities where rapid responses are essential
- Customisable shock absorption with two heel wedge options
- Suitable for a broad range of applications, from everyday life to demanding occupations to recreational sports
- Slim footshell option

Information material

647G1218=ALL_INT IFU 1C60 1C63 1C64

Scope of delivery

1C60	Triton		1	Piece
2C6	Footshell		1	Piece
2C19	Connection cover	with normal footshell	1	Piece
2C20	Connection cover	with slim footshell	1	Piece
2F60	Heel wedges for Triton		1	Set
SL=SPECTRA-SOCK-7	Spectra protective sock black		1	Piece



Max. 100 kg
Size 21 to 24 cm



Max. 150 kg
Size 25 to 30 cm

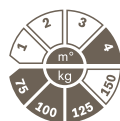

Max. 125 kg
Size 25 to 30 cm

Technical data

Mobility grade	3, 4
Max. body weight	150 kg (MG3), 125 kg (MG 4)
Side	left (L), right (R)
Sizes	21-30 cm
Weight without footshell*	460 g
Shape of footshell	Slim shape (S) for a heel height of 15 +/- 5 mm (21-27 cm) Normal shape (N) for a heel height of 10 +/- 5 mm (24-30 cm)
Colour of footshell	beige (4), light brown (15)
Weight with normal footshell*	680 g
System height with normal footshell*	131 mm
Build height with normal footshell*	149 mm

* Technical data refer to the size of 26 cm

- This foot can be equipped with a custom silicone cover. See the section "Prosthesis covers" for detailed information.



reddot award 2015
winner



Stiffness chart

Body weight	Foot size									
	21 cm	22 cm	23 cm	24 cm	25 cm	26 cm	27 cm	28 cm	29 cm	30 cm
up to 55 kg	1	1	1	1	1	1	-	-	-	-
56–75 kg	2	2	2	2	2	2	2	2	2	2
76–100 kg	3	3	3	3	3	3	3	3	3	3
101–125 kg	-	-	-	-	4	4	4	4	4*	4*
126–150 kg	-	-	-	-	5	5	5*	5*	5*	5*

* Do not combine this configuration with a 3C88-3/3C98-3 C-Leg 4.

◻ Slim footshell available (15 mm heel height)

◻ Both footshells available

◻ Normal footshell available (10 mm heel height)

Order example

Reference number	Side	Size	Stiffness	P	Colour	Shape
1C60	= L	26	- 3	- P	/ 4	N

Triton

Your will. Your way.



Linear carbon spring

It provides the moderate flexibility in the mid-stance phase that is required for good responsiveness as well as exactly the right level of energy return when walking at faster speeds.

Connected spring design

The three interconnected springs prevent the foot from yielding too much when it is overloaded. They provide stability even when you make quick, responsive movements.

Two heel wedges to customise the heel stiffness

The selection of heel wedges makes it possible to customise the shock absorption at heel strike to the user's individual needs.

Prosthetic feet

Mobility grade 3–4



Triton Vertical Shock

Reference number 1C61

The 1C61 Triton Vertical Shock is a versatile carbon prosthetic foot that is perfect for meeting the needs of highly active individuals who navigate varied indoor and outdoor environments and place a high value on uncompromised response. It offers a high degree of shock absorption and torsion capability – for noticeable relief of the residual limb and improved stability.

Key features

- The linear spring design provides the level of support in the stance phase that is needed for activities where rapid responses are essential
- Increased vertical shock absorption and torsion capability
- Customisable shock absorption with two heel wedge options
- Suitable for a broad range of applications, from everyday life to demanding occupations to recreational sports
- Slim footshell option

Information material

647G674=ALL_INT IFU Triton Vertical Shock

Scope of delivery

Reference number	Description	Quantity
1C61	Triton Vertical Shock	1 Piece
2C6	Footshell	1 Piece
2C19	Connection cover with normal footshell	1 Piece
2C20	Connection cover with slim footshell	1 Piece
2F60	Heel wedges for Triton	1 Set
4X260	Functional ring	1 Piece
SL=SPECTRA-SOCK-7	Spectra protective sock black	1 Piece



Max. 100 kg
Size 21 to 24 cm



Max. 150 kg
Size 25 to 30 cm

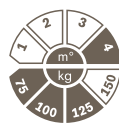

Max. 125 kg
Size 25 to 30 cm

Technical data

Mobility grade	3, 4
Max. body weight	150 kg (MG3), 125 kg (MG 4)
Side	left (L), right (R)
Sizes	21-30 cm
Weight without footshell*	760 g
Shape of footshell	Slim shape (S) for a heel height of 15 +/- 5 mm (21-27 cm) Normal shape (N) for a heel height of 10 +/- 5 mm (24-30 cm)
Colour of footshell	beige (4), light brown (15)
Weight with normal footshell*	980 g
System height with normal footshell*	177 mm
Build height with normal footshell*	195 mm

* Technical data refer to the size of 26 cm

- This foot can be equipped with a custom silicone cover. See the section "Prosthesis covers" for detailed information.

Stiffness chart (spring stiffness – functional ring stiffness)

Body weight	Foot size									
	21 cm	22 cm	23 cm	24 cm	25 cm	26 cm	27 cm	28 cm	29 cm	30 cm
40–47 kg	1-0 Special order – Please contact Customer Service									
48–55 kg	1-1	1-1	1-1	1-1	1-1	1-1	–	–	–	–
56–65 kg	2-2	2-2	2-2	2-2	2-2	2-2	2-2	2-2	2-2	2-2
66–75 kg	2-3	2-3	2-3	2-3	2-3	2-3	2-3	2-3	2-3	2-3
76–87 kg	3-4	3-4	3-4	3-4	3-4	3-4	3-4	3-4	3-4	3-4
88–100 kg	3-5	3-5	3-5	3-5	3-5	3-5	3-5	3-5	3-5	3-5
101–112 kg	–	–	–	–	4-6	4-6	4-6	4-6	4-6*	4-6*
113–125 kg	–	–	–	–	4-7	4-7	4-7	4-7	4-7*	4-7*
126–137 kg	–	–	–	–	5-8	5-8	5-8*	5-8*	5-8*	5-8*
138–150 kg	–	–	–	–	5-9	5-9	5-9	5-9	5-9	5-9

* Do not combine this configuration with a 3C88-3/3C98-3 C-Leg 4.

◻ Slim footshell available (15 mm heel height)

◻ Both footshells available

◻ Normal footshell available (10 mm heel height)

Order example

Reference number	= Side	Size	- Spring stiffness	- Functional ring stiffness	- P	/ Colour	Shape
1C61	= L	26	- 3	- 5	- P	/ 4	N

Accessories/spare parts for 1C61



Functional ring

Reference number 4X260

The 4X260 functional ring is a component of the 1C61 Triton Vertical Shock prosthetic foot. It is available as a spare part in various stiffness categories adapted to the corresponding weight classification of the foot.

Technical data

Article number	Max. body weight	Functional ring stiffness
4X260=0	40 - 47 kg	0
4X260=1	48 - 55 kg	1
4X260=2	56 - 65 kg	2
4X260=3	66 - 75 kg	3
4X260=4	76 - 87 kg	4
4X260=5	88 - 100 kg	5
4X260=6	101 - 112 kg	6
4X260=7	113 - 125 kg	7
4X260=8	126 - 137 kg	8
4X260=9	138 - 150 kg	9

Prosthetic feet

Mobility grade 3–4



Triton Harmony

Reference number 1C62

The 1C62 Triton Harmony is a versatile carbon prosthetic foot that is perfect for meeting the needs of highly active individuals who navigate varied indoor and outdoor environments and place a high value on uncompromised response. It is a highly functional and compact prosthetic foot with integrated Harmony vacuum technology.

Key features

- The linear spring design provides the level of support in the stance phase that is needed for activities where rapid responses are essential
- Integrated Harmony pump for use with an active vacuum
- Increased vertical shock absorption and torsion capability
- Customisable shock absorption with two heel wedge options
- Suitable for a broad range of applications, from everyday life to demanding occupations to recreational sports
- Slim footshell option

Information material

647G675=ALL_INT IFU Triton Harmony

Scope of delivery

1C62	Triton Harmony		1 Piece
2C6	Footshell		1 Piece
2C19	Connection cover	with normal footshell	1 Piece
2C20	Connection cover	with slim footshell	1 Piece
2F60	Heel wedges for Triton		1 set
4X147	Functional ring for Harmony P3		1 Piece
2R117	Socket connector		1 Piece
4Y383	Cosmetic exhaust flange		1 Piece
SL=SPECTRA-SOCK-7	Spectra protective sock black		1 Piece

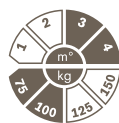

Max. 100 kg
Size 21 to 24 cm

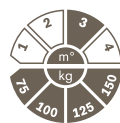

Max. 150 kg
Size 25 to 30 cm

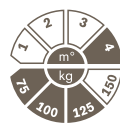

Max. 125 kg
Size 25 to 30 cm

Technical data

Mobility grade	3, 4
Max. body weight	150 kg (MG3), 125 kg (MG 4)
Side	left (L), right (R)
Sizes	21-30 cm
Weight without footshell*	760 g
Shape of footshell	Slim shape (S) for a heel height of 15 +/- 5 mm (21-27 cm) Normal shape (N) for a heel height of 10 +/- 5 mm (24-30 cm)
Colour of footshell	beige (4), light brown (15)
Weight with normal footshell*	980 g
System height with normal footshell*	177 mm
Build height with normal footshell*	195 mm

* Technical data refer to the size of 26 cm

- This foot can be equipped with a custom silicone cover. See the section "Prosthesis covers" for detailed information.

Stiffness chart (spring stiffness – functional ring stiffness)

Body-weight	Foot size									
	21 cm	22 cm	23 cm	24 cm	25 cm	26 cm	27 cm	28 cm	29 cm	30 cm
40–47 kg	1-0 Special order – Please contact Customer Service						–	–	–	–
48–55 kg	1-1	1-1	1-1	1-1	1-1	1-1	–	–	–	–
56–65 kg	2-2	2-2	2-2	2-2	2-2	2-2	2-2	2-2	2-2	2-2
66–75 kg	2-3	2-3	2-3	2-3	2-3	2-3	2-3	2-3	2-3	2-3
76–87 kg	3-4	3-4	3-4	3-4	3-4	3-4	3-4	3-4	3-4	3-4
88–100 kg	3-5	3-5	3-5	3-5	3-5	3-5	3-5	3-5	3-5	3-5
101–112 kg	–	–	–	–	4-6	4-6	4-6	4-6	4-6*	4-6*
113–125 kg	–	–	–	–	4-7	4-7	4-7	4-7	4-7*	4-7*
126–137 kg	–	–	–	–	5-8	5-8	5-8*	5-8*	5-8*	5-8*
138–150 kg	–	–	–	–	5-9	5-9	5-9	5-9	5-9	5-9

* Do not combine this configuration with a 3C88-3/3C98-3 C-Leg 4.

◻ Slim footshell available (15 mm heel height)

◻ Both footshells available

◻ Normal footshell available (10 mm heel height)

Order example

Reference number	= Side	Size	- Spring stiffness	- Functional ring stiffness	- P /	Colour	Shape
1C62	= L	26	- 2	- 3	- P /	4	N

Accessories/spare parts for 1C62



Functional ring for Harmony P3

Reference number 4X147

The 4X147 functional ring is a spare part for the 4R147 Harmony P3 and the 1C62 Triton Harmony prosthetic foot. The scope of delivery includes the functional ring with two valves, two O-rings, spacer washer and lubricant.

Technical data

Article number	Max. body weight	Functional ring stiffness
4X147=0	40 - 47 kg	0
4X147=1	48 - 55 kg	1
4X147=2	56 - 65 kg	2
4X147=3	66 - 75 kg	3
4X147=4	76 - 87 kg	4
4X147=5	88 - 100 kg	5
4X147=6	101 - 112 kg	6
4X147=7	113 - 125 kg	7
4X147=8	126 - 137 kg	8
4X147=9	138 - 150 kg	9

• The 4X147=8 and 4X147=9 may only be used for the 1C62 Triton Harmony



Socket connector

Reference number 2R117

Technical data

Article number
2R117=0

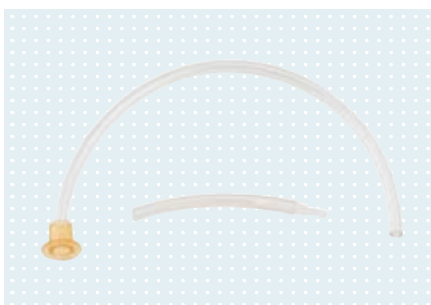

Cosmetic exhaust flange

Reference number 4Y383

The 4Y383 is used in prostheses with the Harmony P3 system that have a cosmetic cover. The Harmony flange kit is mounted on the outlet valve of the Harmony to conduct liquids to the outside of the foam cover.

Technical data

Article number	Spare part for
4Y383	3R60=VC

Prosthetic feet

Mobility grade 3–4



Triton Low Profile

Reference number 1C63

The 1C63 Triton Low Profile is a versatile carbon prosthetic foot that is perfect for meeting the needs of highly active individuals who navigate varied indoor and outdoor environments and place a high value on uncompromised response. It is a carbon foot for users with limited space for integration.

Key features

- The linear spring design provides the level of support in the stance phase that is needed for activities where rapid responses are essential
- Low build height
- Waterproof and corrosion-resistant
- Robust titanium adapter
- Customisable shock absorption with two heel wedge options
- Suitable for a broad range of applications, from everyday life to demanding occupations to recreational sports
- Slim footshell option

Information material

647G1218=ALL_INT IFU 1C60 1C63 1C64

Scope of delivery

1C63	Triton Low Profile		1 Piece
2C6	Footshell		1 Piece
2C19	Connection cover with normal footshell		1 Piece
2C20	Connection cover with slim footshell		1 Piece
2F60	Heel wedges for Triton		1 Set
SL=SPECTRA-SOCK-7	Spectra protective sock black		1 Piece



reddot design award
winner 2013

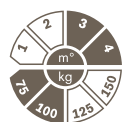

Max. 100 kg
Size 21 to 24 cm

Technical data

Mobility grade	3, 4
Max. body weight	150 kg
Side	left (L), right (R)
Sizes	21-30 cm
Weight without footshell*	415 g
Shape of footshell	Slim shape (S) for a heel height of 15 +/- 5 mm (21-27 cm) Normal shape (N) for a heel height of 10 +/- 5 mm (24-30 cm)
Colour of footshell	beige (4), light brown (15)
Weight with normal footshell*	635 g
System height with normal footshell*	45 mm
Build height with normal footshell*	63 mm

* Technical data refer to the size of 26 cm

- This foot can be equipped with a custom silicone cover. See the section "Prosthesis covers" for detailed information.

Stiffness chart

Body weight	Foot size									
	21 cm	22 cm	23 cm	24 cm	25 cm	26 cm	27 cm	28 cm	29 cm	30 cm
up to 55 kg	1	1	1	1	1	1	-	-	-	-
56–75 kg	2	2	2	2	2	2	2	2	2	2
76–100 kg	3	3	3	3	3	3	3	3	3	3
101–125 kg	-	-	-	-	4	4	4*	4*	4*	4*
126–150 kg	-	-	-	-	5*	5*	5*	5*	5*	5*

* Do not combine this configuration with a 3C88-3/3C98-3 C-Leg 4.

■ Slim footshell available (15 mm heel height)

■ Both footshells available

■ Normal footshell available (10 mm heel height)

Order example

Reference number	= Side	Size	- Stiffness	- P /	Colour	Shape
1C63	= L	26	- 3	- P /	4	N



Triton Heavy Duty

Reference number 1C64

The 1C64 Triton Heavy Duty is a versatile carbon prosthetic foot that is perfect for meeting the needs of highly active individuals who navigate varied indoor and outdoor environments and place a high value on uncompromised response. It is ideally suited for particularly challenging conditions at work or play.

Key features

- The linear spring design provides the level of support in the stance phase that is needed for activities where rapid responses are essential
- Waterproof and corrosion-resistant
- Robust titanium adapter
- Customisable shock absorption with two heel wedge options
- Suitable for a broad range of applications, from everyday life to demanding occupations to recreational sports
- Slim footshell option

Information material

647G1218=ALL_INT IFU 1C60 1C63 1C64

Scope of delivery

Reference number	Description	Quantity	Unit
1C64	Triton Heavy Duty	1	Piece
2C6	Footshell	1	Piece
2C19	Connection cover with normal footshell	1	Piece
2C20	Connection cover with slim footshell	1	Piece
2F60	Heel wedges for Triton	1	Set
SL=SPECTRA-SOCK-7	Spectra protective sock black	1	Piece

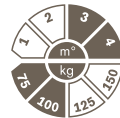

Max. 100 kg
Size 21 to 24 cm

Technical data

Mobility grade	3, 4
Max. body weight	150 kg
Side	left (L), right (R)
Sizes	21-30 cm
Weight without footshell*	535 g
Shape of footshell	Slim shape (S) for a heel height of 15 +/- 5 mm (21-27 cm) Normal shape (N) for a heel height of 10 +/- 5 mm (24-30 cm)
Colour of footshell	beige (4), light brown (15)
Weight with normal footshell*	755 g
System height with normal footshell*	131 mm
Build height with normal footshell*	149 mm

* Technical data refer to the size of 26 cm

- This foot can be equipped with a custom silicone cover. See the section "Prosthesis covers" for detailed information.

Stiffness chart

Body weight	Foot size									
	21 cm	22 cm	23 cm	24 cm	25 cm	26 cm	27 cm	28 cm	29 cm	30 cm
up to 55 kg	1	1	1	1	1	1	-	-	-	-
56–75 kg	2	2	2	2	2	2	2	2	2	2
76–100 kg	3	3	3	3	3	3	3	3	3	3
101–125 kg	-	-	-	-	4	4	4	4	4*	4*
126–150 kg	-	-	-	-	5	5	5*	5*	5*	5*

* Do not combine this configuration with a 3C88-3/3C98-3 C-Leg 4.

◻ Slim footshell available (15 mm heel height)

◻ Both footshells available

◻ Normal footshell available (10 mm heel height)

Order example

Reference number	=	Side	Size	-	Stiffness	-	P /	Colour	Shape
1C64	=	L	26	-	3	-	P /	4	N

Prosthetic feet

Mobility grade 3–4



Triton side flex

Reference number 1C68

The 1C68 Triton side flex was developed for highly active users. It is the first prosthetic foot to provide such extraordinary lateral adaptability and adjusts to the current situation immediately.

Key features

- Unique lateral adaptability of +/- 10° for immediate and full-surface ground contact while walking and standing, also on uneven surfaces and slopes
- Enhanced feeling of safety and improved socket comfort
- The linear spring design provides the level of support in the stance phase that is needed for activities where rapid responses are essential
- Customisable shock absorption with two different heel wedge options
- Robust, maintenance-free technology
- Low build height
- Waterproof and corrosion-resistant
- Slim footshell option

Information material

647G1288=ALL_INT IFU Triton side flex

Scope of delivery

Reference number	Description	Quantity	Unit
1C68	Triton side flex	1	Piece
2C6	Footshell	1	Piece
2C19	Connection cover with normal footshell	1	Piece
2C20	Connection cover with slim footshell	1	Piece
2F60	Heel wedges for Triton	1	Set
SL=SPECTRA-SOCK-7	Spectra protective sock black	1	Piece



Max. 125 kg

Technical data

Mobility grade	3, 4
Max. body weight	max. 125 kg
Side	left (L), right (R)
Sizes	22-30 cm
Weight without footshell*	585 g
Shape of footshell	Slim shape (S) for a heel height of 15 +/- 5 mm (22-27 cm) Normal shape (N) for a heel height of 10 +/- 5 mm (24-30 cm)
Colour of footshell	beige (4), light brown (15)
Weight with normal footshell*	805 g
System height with normal footshell*	68 mm
Build height with normal footshell*	86 mm

* Technical data refer to the size of 26 cm

Stiffness chart*

Body weight	Foot size								
	22 cm	23 cm	24 cm	25 cm	26 cm	27 cm	28 cm	29 cm	30 cm
up to 55 kg	1	1	1	1	1	-	-	-	-
56–75 kg	2	2	2	2	2	2	2	2	2
76–100 kg	3	3	3	3	3	3	3	3	3
101–125 kg	-	-	-	4	4	4**	4**	4**	4**

* Please read the 1C68 instructions for use regarding potentially excluded combinations of configurations with Ottobock structural components.

** Do not combine this configuration with a 3C88-3/3C98-3 C-Leg 4.

Slim footshell available (15 ± 5 mm heel height)
 Both footshells available
 Normal footshell available (10 ± 5 mm heel height)

Order example

Reference number	Side	Size	Stiffness	P	Colour	Shape
1C68	L	26	3	P	4	N

Triton side flex

Your will. Your way.

Robust titanium adapter

Thanks to integrated seals and the use of corrosion-resistant materials, the mechanism is protected against fresh, salt and chlorinated water.

Stop bumpers

Stop bumpers gently dampen the side-to-side impact when the full range of motion needs to be utilised on very uneven ground or slopes.

Innovative functional module for side-to-side flexibility

The controlled, effortless side-to-side flexibility of the Triton side flex is achieved by a titanium torsion bar. This compact, robust and maintenance-free technology permits sideways adaptability of up to $\pm 10^\circ$.

Proven Triton platform

The familiar properties of the Triton platform are not affected by the side-to-side flexibility and ensure the prosthesis is as dynamic as it needs to be.



Prosthetic feet

Mobility grade 3–4

Accessories/spare parts for 1C60, 1C61, 1C62, 1C63, 1C64, 1C68



Information material

647G333=ALL_INT	IFU Footshell
-----------------	---------------

Scope of delivery

Reference number	Description	Quantity	Unit
2C6	Footshell	1	Piece
2C19	Connection cover with normal footshell	1	Piece
2C20	Connection cover with slim footshell	1	Piece

Footshell

Reference number 2C6

The 2C6 footshell is a protective cover for the Triton prosthetic feet. Its external shape creates a natural appearance in the slim or normal version. It is available in the colours beige and light brown.

Technical data

Reference number	2C6=*N	2C6=*S
Side	left (L), right (R)	left (L), right (R)
Shape	normale shape (N)	slim shape (S)
Size	21-30 cm	21-27 cm
Weight*	220 g	200 g
Heel height	10 +/- 5 mm	15 +/- 5 mm
Colour	beige (4), light brown (15)	beige (4), light brown (15)

* Technical data refer to the size of 26 cm

Order example

Reference number	= Side	Size	- Stiffness	- P /	Colour	Shape
1C68	= L	26	- 3	- P / 4		N

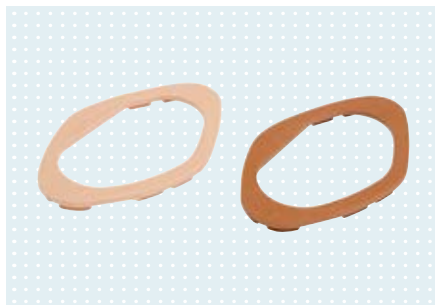

Connection cover

Reference number 2C19

In combination with the 2C1, 2C6 and 2C15 footshells in the normal foot shape, the 2C19 connection cover forms an attractive cosmetic cover that can be glued to a foam cover.

Technical data

Reference number	2C19=*N
Side	left (L), right (R)
Size	22 cm, 23-25 cm, 26-28 cm, 29-31 cm
Colour	beige (4), light brown (15)
for	Footshells 2C1=*N, 2C6=*N, 2C15=*N

Order example

Reference number	= Side	Size range	/ Colour
2C19	= L	26-28	/ 4

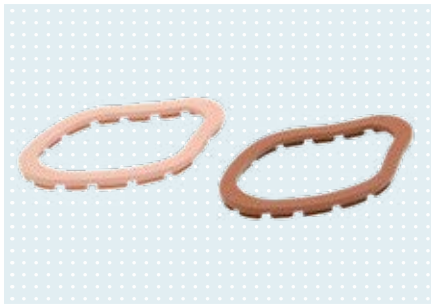

Connection cover

Reference number 2C20

In combination with the 2C1, 2C3, 2C6 and 2C15 footshells in the slim foot shape, the 2C20 connection cover forms an attractive cosmetic cover that can be glued to a foam cover.

Technical data

Reference number	2C20=*
Side	left (L), right (R)
Size	21-27 cm
Colour	beige (4), light brown (15)
for	Footshells 2C1=*S, 2C3=*S, 2C6=*S, 2C15=S*

Order example

Reference number	= Side	Size	/ Colour
2C20	= L	26	/ 4



Heel wedges for Triton

Reference number 2F60

The 2F60 heel wedge set consists of a soft transparent wedge and a stiff black wedge for customising the heel characteristics.

Technical data

Article number	Size
2F60=21-22	21-22 cm
2F60=23-24	23-24 cm
2F60=25-26	25-26 cm
2F60=27-28	27-28 cm
2F60=29-30	29-30 cm



Spectra protective sock black

Reference number SL=SPECTRA-SOCK-7

The long Spectra sock in black is an accessory for prosthetic feet. It protects the foot against soiling and prevents possible noises that could develop due to the movement of the prosthesis in the cosmetic foot cover.

Technical data

Article number	SL=SPECTRA-SOCK-7
-----------------------	-------------------

Prosthetic feet

Mobility grade 3–4



Custom silicone cover lower limb

Reference number 88A20

For many users, a natural outward appearance is just as important as the functional benefits of a prosthesis. With high-end, custom-made silicone covers for leg prostheses, Ottobock gives you the opportunity to make this dream come true for your users. The Ottobock iFab acts as your extended workbench for the fabrication of aesthetically pleasing silicone covers, as they are made to your precise and individual specifications – quickly, reliably and in the highest quality.

Technical data

Article image	Article number	Description	Product features
	88A20=C	Custom silicone covers for the lower limbs	<ul style="list-style-type: none">· Anatomical shape· Custom silicone cover in two to three colours· Anatomical surface structure· Single-colour silicone toenails with colour-compatible nail tip
	88A20=N	Custom silicone covers for the lower limbs	<ul style="list-style-type: none">· Anatomical shape· Custom silicone cover in 8-10 colours· Anatomical surface structure· Single-colour silicone toenails with colour-compatible nail tip

• You will find further information on custom silicone covers for the lower limbs in the "Prosthesis covers" section.

Prosthetic feet

Mobility grade 3–4



Empower

Reference number 1A1-2

The Empower 1A1-2 was especially designed for active individuals who navigate varied indoor and outdoor environments and place a high value on the ability to cover longer distances and walk at a higher walking speed.

Key features

- More energy for longer distances and a higher walking speed – even on ramps and stairs
- Increased balance and stability on uneven terrain thanks to real-time adaptation
- The relief function enables a more natural appearance when sitting in addition to providing relief for the residual limb
- Range of motion: 22° (PF)
- Protected against splashed water (IP 24)

Information material

647G1660=EN_INT	IFU Qualified Personnel 1A1-2
647H920=EN_INT	IFU User 1A1-2

Scope of delivery

1A1-2	Empower	1 Piece
2F50	Heel wedges for Taleo	1 Set
SL=SPECTRA-SOCK-7	Spectra protective sock black	1 Piece
2C16	Empower footshell	1 Piece
757B38	Empower battery	2 Piece
757L38	Empower charger	1 Piece
757L39	Empower AC adapter	1 Piece
BM-214-00005	US power cord	1 Piece
BM-214-00007	EU power cord	1 Piece
BM-214-00008	UK power cord	1 Piece
757S3	Power cord AUS	1 Piece
743Y840	Empower tablet	1 Piece



Max. 130 kg
Size 25 to 30 cm

Technical data

Mobility grade	3, 4
Max. body weight	130 kg
Side	left (L), right (R)
Sizes	25-30 cm
Weight without footshell*	1950 g
Weight with normal footshell*	2145 g
System height with normal footshell*	203 mm
Build height with normal footshell*	221 mm
Footshell colour	beige (4), light brown (15)

* Technical data refer to the size of 27 cm

Stiffness chart

Body weight	Foot size						
	25 cm	26 cm	27 cm	28 cm	29 cm	30 cm	
60–67 kg	3	3	3	–	–	–	
68–77 kg	4	4	4	4	–	–	
78–88 kg	5	5	5	5	5	5	
89–100 kg	6	6	6	6	6	6	
101–115 kg	–	7	7	7	7	7	
116–130 kg	–	–	8*	8*	8*	8*	

* Do not combine this configuration with a 3C88-3/3C98-3 C-Leg 4.

Order example

Reference number	= Side	Size	- Stiffness	/ 7 - Colour
1A1-2	= L	26	- 3	/ 7 - 4

Empower

Restore your power.



Battery indicator

The on/off button and battery indicator that shows the charge level are positioned on the front of the Empower.

Lithium-ions battery

The integrated battery lasts up to 8 hours depending on the user's activity level. A dual bay charger can charge two batteries at once in less than 90 minutes.

Powered propulsion

The combination of a battery-powered motor and high-energy carbon spring provides propulsion that mimics the calf muscles.

Dynamic adaptation

The internal control firmware analyses in real time ankle moment and angle which are provided by high-resolution sensors to mimic physiological ankle function.

Three heel wedge options

Thanks to three different heel wedge options, you can customise the shock absorption at heel strike to meet your users' needs.

Taleo Low Profile base spring

The Taleo Low Profile base spring used in the Empower provides a smooth rollover, efficient energy return as well as an optimal adaptation to varying ground conditions.

Prosthetic feet

Mobility grade 3–4

Accessories/spare parts for 1A1-2



Information material

647G1659=ALL_INT IFU Empower footshell

Empower footshell

Reference number 2C16

The 2C16 footshell is a protective cover for the mechatronic prosthetic foot Empower. Its external shape creates a natural appearance. It also features alignment marks that enable straightforward and fast bench alignment.

Technical data

Reference number	2C16=*N
Side	left (L), right (R)
Sizes	25-30 cm
Weight*	200 g
Heel height	10 mm
Colour	beige (4), light brown (15)

*Technical data refer to the size of 27cm

Order example

Reference number	=	Side	Size	-	Stiffness	/	7	-	Colour
1A1-2	=	L	26	-	3	/	7	-	4



Heel wedges for Taleo

Reference number 2F50

The 2F50 heel wedge set contains three heel wedges in various degrees of hardness, permitting individual adaptation of the heel stiffness for the user.

Technical data

Article number	Size
2F50=26-28	26-28 cm
2F50=22-25	22-25 cm
2F50=29-30	29-30 cm



Spectra protective sock black

Reference number SL=SPECTRA-SOCK-7

The long Spectra sock in black is an accessory for prosthetic feet. It protects the foot against soiling and prevents possible noises that could develop due to the movement of the prosthesis in the cosmetic foot cover.

Technical data

Article number	SL=SPECTRA-SOCK-7
----------------	-------------------



Empower battery

Reference number 757B38

757B38 exchangeable rechargeable battery to operate the 1A1-2 Empower prosthetic foot. The scope of delivery includes two batteries that can be easily exchanged by the user in the course of the day.

Technical data

Article number

757B38



Empower charger

Reference number 757L38

757L38 dual bay charger for the 1A1-2 Empower prosthetic foot. The battery charger can charge two batteries at the same time within just 90 minutes.

Technical data

Article number

757L38



Empower AC adapter

Reference number 757L39

The 757L39 power supply is used with the 757L38 Empower battery charger.

Technical data

Article number

757L39



Power cord

Reference number BM-214

This product is the power cord for the 1A1-2 Empower. The following versions are available: *-5 = US / *-7 = EU / *-8 = UK

Technical data

Article number	Description
BM-214-00005	US power cord
BM-214-00007	EU power cord
BM-214-00008	UK power cord

Prosthetic feet

Mobility grade 3–4

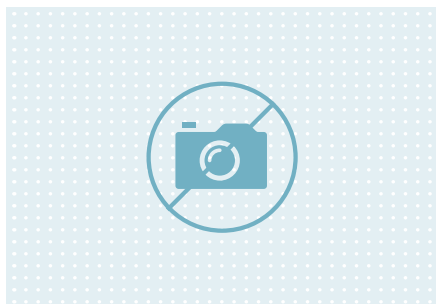

Power cord AUS

Reference number 757S3

The 757S3=AUS is the power cord for the 1A1-2 Empower prosthetic foot with Australian adapter.

Technical data

Article number

757S3=AUS



Empower tablet

Reference number 743Y840

The 743Y840 tablet is optionally included in the scope of delivery of the 1A1-2 Empower. After installation of the Empower Setup App it guides you through the prosthetic alignment and adjustment of the prosthetic foot.

Technical data

Article number

743Y840=V1



Axtion DP pylon foot

Reference number 1E58

The 1E58 Axtion DP is a pylon prosthetic foot for users with moderate to very high mobility, suitable for demanding activities such as running and jumping, tennis or athletic disciplines.

Key features

- Dynamic response, high energy return, good shock absorption and multi-axial function
- Very lightweight foot-ylon system to support proximal load distribution
- Pylon design permits rotation of up to $\pm 8^\circ$



Max. 125 kg

Information material

647G478=ALL_INT	IFU Axtion DP
-----------------	---------------

Scope of delivery

1E58	Axtion DP pylon foot	1	Piece
SL=SPECTRA-SOCK-7	Spectra protective sock black	1	Piece

Technical data

Mobility grade	3, 4
Max. body weight with A-ylon	100 kg
Max. body weight with B-ylon	125 kg
Side	neutral (N)
Sizes	22-31 cm
Weight without footshell*	424 g
Shape of footshell	Normal shape for a heel height of 13 +/- 5 mm
Colour of footshell	beige (4), light brown (15)
Weight with normal footshell*	644 g
Min. system height with A-ylon	184 mm
Min. system height with B-ylon	200 mm

* Technical data refer to the size of 26 cm

- The footshell is not included in the scope of delivery. It must be ordered separately as an accessory.
- To order, please use the order form at the end of the section on prosthetic feet.



Prosthetic feet

Pylon feet

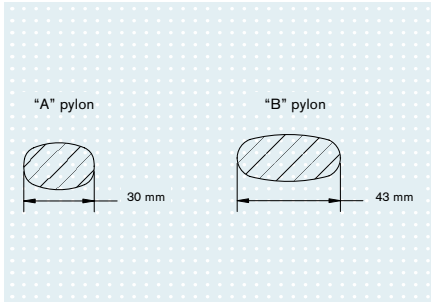

The pylon and its connection options to the modular system

The loads acting on the prosthetic foot increase along with the body weight, activity level and foot size.

With the Axtion DP, the pylon is divided into two widths, the A and B pylon. "A" represents the standard width and "B" stands for a wider version for higher loads.

Various adapters are available for the proximal connection to the modular system:

- The connection to modular components with a pyramid or pyramid receiver is realised with the tube clamp adapter. The spacer sleeve including adhesive to connect the pylon to the sleeve must be ordered separately. If the pylon was unintentionally shortened too much, a longer sleeve (length compensation) can be ordered.
- The connection to the socket adapter, socket attachment block or lamination disc is realised with the available selection of socket adapters. Adapters with and without thread are available. The spacer plate is included in the scope of delivery for both.
- The connection to modular components with a tube clamp is realised with the adapter for transfemoral prostheses (30 mm diameter) or the 34 mm spacer sleeve.

Adapter options for A pylon (up to max. 100 kg body weight)

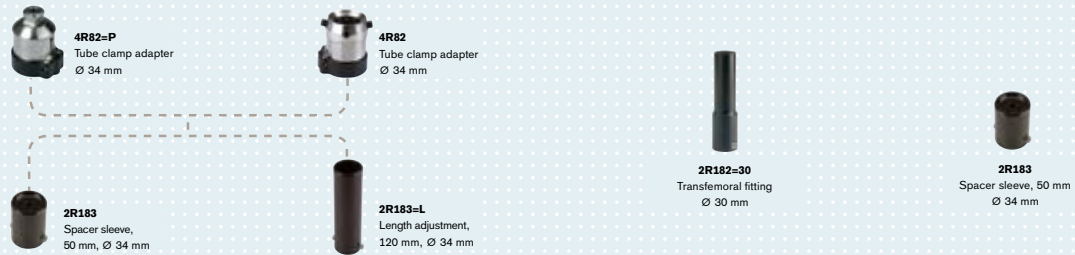

Connection to modular components with pyramid/pyramid receiver

Connection to modular components with tube clamp

Adapter options for B pylon (from 101 – max. 125 kg body weight)

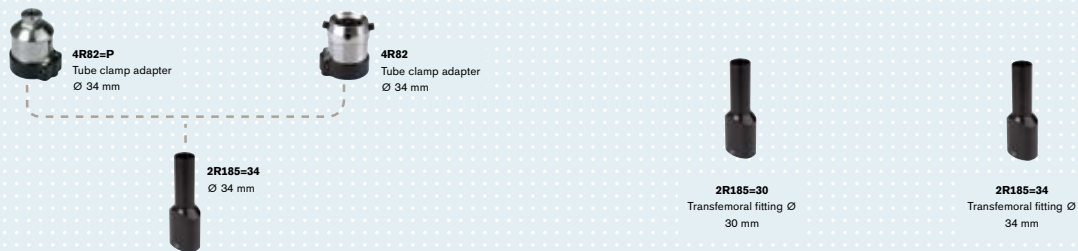

Accessories/spare parts for 1E58



Footshell

Reference number 2C5

The 2C5 footshell is a protective cover for the 1E* prosthetic feet. Its external shape creates a natural appearance. It is available in the colours beige and light brown.

Technical data

Reference number	2C5=*
Side	left (L), right (R)
Shape	normal shape
Size	22-31 cm
Weight*	225 g
Heel height	10 +/- 5 mm
Colour	beige (4), light brown (15)

* Technical data refer to the size of 26 cm

Order example

Reference number	=	Side	Size	/	Colour
2C5	=	L	26	/	4

Information material

647G333=ALL_INT	IFU Footshell
-----------------	---------------

Scope of delivery

2C5	Footshell	1	Piece
2C10	Connection cover	1	Piece



Connection cover

Reference number 2C10

In combination with the 2C3 and 2C5 footshells or the 1D35 Dynamic Motion, the 2C10 connection cover forms an attractive cosmetic cover that can be glued to a foam cover.

Technical data

Reference number	2C10=*
Side	left (L), right (R)
Size	21-22 cm, 23-25 cm, 26-28 cm, 29-31 cm
Colour	beige (4), light brown (15)
for	Footshells 2C3=* and 2C5=* Dynamic Motion 1D35=* (sizes 21-22 cm)

Order example

Reference number	=	Side	Size	/	Colour
2C5	=	L	26	/	4

Accessories/spare parts for 1E58 with A pylon



Tube clamp adapter

Reference number 4R82

Technical data

Article number	Diameter	Material	System height	Weight	Max. body weight
4R82	34 mm	Titanium	33 mm	95 g	150 kg

Prosthetic feet

Pylon feet



Tube clamp adapter

Reference number 4R82

Technical data

Article number	Diameter	Material	System height	Weight	Max. body weight
4R82=P	34 mm	Titanium	-12 mm	90 g	150 kg



Oval pylon adapter, 34 mm

Reference number 2R183

The connection to modular components with a tube clamp or pyramid/pyramid receiver is realised with the 2R183 spacer sleeve (with a diameter of 34 mm) for transfemoral prostheses with an A-ylon.

Technical data

Article number	Diameter	System height
2R183	34 mm	6 mm



Oval pylon adapter, 34 mm, long

Reference number 2R183

The connection to modular components with a tube clamp or pyramid/pyramid receiver is realised with the 2R183 spacer sleeve (with a diameter of 34 mm) for transfemoral prostheses with an A pylon.

Technical data

Article number	Diameter	System height
2R183=L	34 mm	79 mm



Oval pylon adapter, 30 mm

Reference number 2R182

The connection to modular components with a tube clamp is realised with the 2R182 oval pylon adapter (with a diameter of 30 mm) for transfemoral prostheses with an A pylon.

Technical data

Article number	Diameter	System height
2R182=30	30 mm	89 mm

Accessories/spare parts for 1E58 with B pylon



Tube clamp adapter

Reference number 4R82

Technical data

Article number	Diameter	Material	System height	Weight	Max. body weight
4R82	34 mm	Titanium	33 mm	95 g	150 kg



Tube clamp adapter

Article number 4R82=P

Technical data

Article number	Diameter	Material	System height	Weight	Max. body weight
4R82=P	34 mm	Titanium	-12 mm	90 g	150 kg



B oval pylon adapter

Reference number 2R185

The connection to modular components with a tube clamp is realised with the 2R185 B oval pylon adapter (with a diameter of 30 mm or 34 mm) for transfemoral prostheses with a B pylon.

Technical data

Article number	Diameter	System height
2R185=30	30 mm	89 mm
2R185=34	34 mm	89 mm



Connection cover

Reference number 2C10

In combination with the 2C3 and 2C5 footshells or the 1D35 Dynamic Motion, the 2C10 connection cover forms an attractive cosmetic cover that can be glued to a foam cover.

Technical data

Reference number	2C10=*
Side	left (L), right (R)
Size	21-22 cm, 23-25 cm, 26-28 cm, 29-31 cm
Colour	beige (4), light brown (15)
for	Footshells 2C3=* and 2C5=* Dynamic Motion 1D35=* (sizes 21-22 cm)

Order example

Reference number	= Side	Size range	/ Colour
2C10	= L	26-28	/ 4



Chopart PU adhesive set

Reference number SL=P078

The adhesive set is used for gluing Chopart footplates.

Technical data

Article number	
SL=P078	
SL=P078-PARTS	



Chopart PU adhesive set, small parts set

Reference number SL=P078

Technical data

Article number	
SL=P078-PARTS	



Footshell foam kit, single application

Reference number SL=P071

Technical data

Article number	
SL=P071	

Prosthetic feet

Feet for a limited build height



ProSymes

Reference number 1C20

The 1C20 ProSymes is suitable for Syme amputees with a body weight of up to 125 kg who require a dynamic prosthetic foot that offers outstanding reliability and performance.

Key features

- Carbon foot with integrated socket adapter
- Dual spring elements with a carbon/polyurethane sandwich structure enable a dynamic gait pattern
- Dynamic heel element guarantees shock absorption at heel strike
- Adjustment concept permits correction of the foot position during fitting and after finishing the prosthesis
- Facilitates the treatment of Syme amputations and features reproducible adjustment possibilities
- Low build height of only 43 mm (including lamination anchor and footshell)

Information material

647G174=ALL_INT IFU ProSymes

Scope of delivery

1C20	ProSymes	1 Piece
2C2	Footshell	1 Piece
2G120	Lamination anchor	1 Piece
2Z120	Screw set	1 Single component pack
2Z328	Setting aid with screw	1 Package
SL=SPECTRA-SOCK	Spectra protective sock	1 Piece

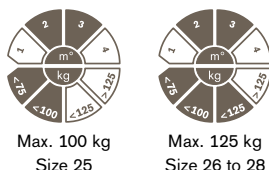

Technical data

Mobility grade	2, 3
Max. body weight	125 kg
Side	left (L), right (R)
Sizes	25-28 cm
Weight with lamination anchor, without footshell*	475 g
Shape of footshell	Normal shape for a heel height of 10 +/- 5 mm
Colour of footshell	beige (4), light brown (15)
Weight with normal footshell*	705 g
Build height without space plate*	43 mm
Build height with space plate*	52 mm

* Technical data refer to the size of 26 cm

Stiffness chart

Body weight	Foot size	
	25 cm	26-28 cm
to 100 kg	1	2
100-125 kg	-	3

Order example

Reference number	Side	Size	Stiffness	A / Colour
1C20	L	26	2	A / 4

Accessories/spare parts for 1C20



Footshell

Reference number 2C2

The 2C2 footshell is a protective cover for the 1C20 ProSymes prosthetic foot. Its external shape creates a natural appearance. It is available in the colours beige and light brown.

Technical data

Reference number	2C2=*
Shape	normal shape
Size	25-28 cm
Weight*	230 g
Heel height	10 +/- 5 mm
Colour	beige (4), light brown (15)

* Technical data refer to the size of 26 cm

Information material

647G333=ALL_INT	IFU Footshell
-----------------	---------------

Scope of delivery

2C2	Footshell	1	Piece
-----	-----------	---	-------

Order example

Reference number	=	Side	Size	/	Colour
2C2	=	L	26	/	4



Lamination anchor

Reference number 2G120

The 2G120 lamination anchor with lamination cover for the 1C20 ProSymes modular prosthetic foot is available as an individual spare part.

Technical data

Article number	2G120
-----------------------	-------

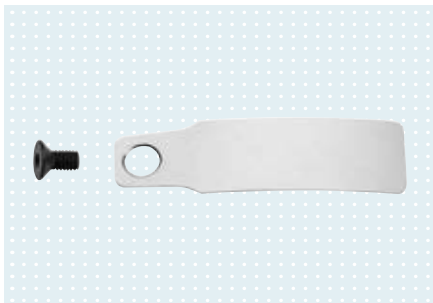

Setting aid with screw

Reference number 2Z328

The 2Z328 setting aid with screw for the 1C20 ProSymes modular prosthetic foot contains single components as spare parts.

Technical data

Article number	2Z328
-----------------------	-------



Screw set

Reference number 2Z120

The 2Z120 screw set for the 1C20 ProSymes modular prosthetic foot contains single components as spare parts.

Technical data

Article number	2Z120
-----------------------	-------

Prosthetic feet

Feet for a limited build height



Lo Rider

Reference number 1E57

The 1E57 Lo Rider is a dynamic foot for Symes amputees. In cases where there is a very low structural height, the foot can be ordered without a pyramid and used in conjunction with the XO coupler.



Technical data

Mobility grade	3, 4
Max. body weight	136 kg (MG3), 100 kg (MG 4)
Side	left (L), right (R)
Sizes	22-31 cm
Weight without footshell*	290 g
Shape of footshell	Normal shape for a heel height of 9 +/- 5 mm
Colour of footshell	beige (4), light brown (15)
Weight with normal footshell*	515 g
System height with normal footshell*	18 mm
Build height with normal footshell*	36 mm

* Technical data refer to the size of 26 cm

- The 2C5 footshell is not included in the scope of delivery. It must be ordered separately as an accessory.
- To order, please use the order form at the end of the section on prosthetic feet.

Accessories/spare parts for 1E57



Footshell

Reference number 2C5

The 2C5 footshell is a protective cover for the 1E* prosthetic feet. Its external shape creates a natural appearance. It is available in the colours beige and light brown.

Technical data

Reference number	2C5=*
Side	left (L), right (R)
Shape	normal shape
Size	22-31 cm
Weight*	225 g
Heel height	10 +/- 5 mm
Colour	beige (4), light brown (15)

* Technical data refer to the size of 26 cm

Order example

Reference number	= Side	Size	/ Colour
2C5	= L	26	/ 4

Information material			
647G1351=ALL_INT	IFU Lo Rider		
Scope of delivery			
1E57	Lo Rider	1	Piece
SL=SPECTRA-SOCK-7	Spectra protective sock black	1	Piece

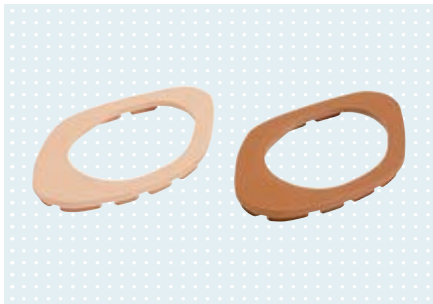

Connection cover

Reference number 2C10

In combination with the 2C3 and 2C5 footshells or the 1D35 Dynamic Motion, the 2C10 connection cover forms an attractive cosmetic cover that can be glued to a foam cover.

Technical data

Reference number	2C10=*
Side	left (L), right (R)
Size	21-22 cm, 23-25 cm, 26-28 cm, 29-31 cm
Colour	beige (4), light brown (15)
for	Footshells 2C3=* and 2C5=* Dynamic Motion 1D35=* (sizes 21-22 cm)

Order example

Reference number	= Side	Size range	/ Colour
2C10	= L	26-28	/ 4



XO coupler

Reference number SL=LR-...

The XO coupler enables an exoskeletal connection of the Lo Rider. It is used to provide for a low structural height.

Technical data

Article number	Diameter	Max. body weight MG 3	Max. body weight MG 4
SL=LR-XOCS-M6	73 mm	93 kg	70 kg
SL=LR-XOCL-M6	85 mm	93 kg	70 kg
SL=LR-XOCL-5/16	85 mm	136 kg	100

- Please order separately.
- Please use a 1/4" Allen key.
- The XO coupler cannot be subsequently combined with the LoRider with pyramid. This means the standard adapter cannot be replaced by the XO coupler.
- Adapter selection is based on the mobility grade and body weight.



Spectra protective sock black

Reference number SL=SPECTRA-SOCK-7

The long Spectra sock in black is an accessory for prosthetic feet. It protects the foot against soiling and prevents possible noises that could develop due to the movement of the prosthesis in the cosmetic foot cover.

Technical data

Article number	SL=SPECTRA-SOCK-7
-----------------------	--------------------------

Prosthetic feet

Silicone prostheses



Custom silicone partial foot prosthesis and toe prosthesis

Reference number 88A32

Silicone partial foot prostheses and silicone toe prostheses harmonise the gait pattern and contribute to the physiological rollover of the foot. The custom design of the prosthetic socket provides a perfect fit, even pressure distribution and compression of the residual limb.

Key features

- Anatomical, customised restoration of the outer appearance
- Very comfortable
- Seamless, tapered socket
- Easy to clean with pH-neutral soap and water
- Skin-friendly medical-grade silicone

Information material

646A251=GB	Information – custom silicone partial foot prostheses
646T1=1.1GB	Technical information Custom silicone partial foot prosthesis
647G543	IFU Custom silicone foot prosthesis
647F285=GB	Colour determination sheet for silicone products

Technical data

Article image	Article number	Description	Product features
	88A31=2	Trial prosthesis for "Basic", "Classic" and "Natural" versions	<ul style="list-style-type: none"> • Trial prosthesis made of Chlorosil and Pastasil • Makes it possible to adjust the inner and outer fit, position and rollover within the four-week trial fitting period • Serves as a template for the definitive prosthesis
	88A31=1	Silicone partial foot and toe prosthesis "Basic"	<ul style="list-style-type: none"> • Custom socket design • Anatomical shape • Silicone foot in one colour • Silicone toenails in skin colour • Little surface structure
	88A32=1	Silicone partial foot and toe prosthesis "Classic"	<ul style="list-style-type: none"> • Custom socket design • Custom anatomical shape • Two to three individual skin tones, matching the contralateral side • Anatomical surface structure • Single-colour silicone toenails with colour-compatible nail tip
	88A32=3	Silicone partial foot and toe prosthesis "Natural"	<ul style="list-style-type: none"> • Custom socket design • Custom anatomical shape • Six to eight individual skin tones, matching the contralateral side • Anatomical surface structure • Single-colour silicone toenails with colour-compatible nail tip

- For the "Natural" variant, the patient must visit an Ottobock Competence Center. Prior to final finishing, a follow-up appointment can also take place in order to optimise the aesthetic appearance.
- To order, please use the ordering process and order form at the end of the "Prosthetic feet" section.

Customised products from Ottobock iFab

The welfare of your patients is the focus of your work. However, you don't always have the resources to fulfil every wish efficiently. This is where Ottobock iFab comes in – we're your expert service provider.

Our team of specialists provides you with straightforward, rapid support so you can focus on the essentials: fitting your patients on site. Learn more about our products and ordering processes in our 646K71 iFab catalogue or contact us by e-mail at iFab@ottobock.de for advice.



Ordering options for 88A32



Multi-colour “Classic” and “Natural” silicone nails

- Custom five-colour silicone toenails

Technical data**Article number**

88A32=S

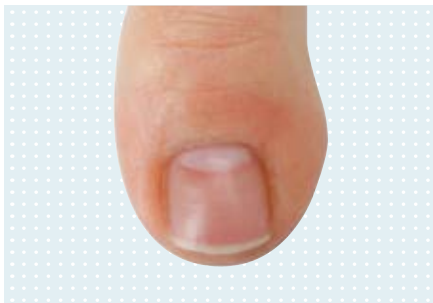

Multi-colour “Classic” and “Natural” acrylic nails

- Deceptively realistic surface characteristics
- Suitable for nail polish

Technical data**Article number**

88A32=A



Hair

- Individually matched to the contralateral side; colour, length, shape and density of hair can be realised on request.

Technical data**Article number**

88A20=H



Tattoo for silicone prostheses

Implementation of special requests, such as applying a tattoo

Technical data**Article number**

88A20=T

Prosthetic feet

Silicone prostheses

Accessories/spare parts for 88A32



Colour determination ring

Colour determination ring for custom prostheses and silicone covers

Technical data

Article number

89D4



Illumination set

Reference number 743R10/743R12

Illumination set for determining the colour of custom silicone products

Technical data

Article number

743R10=0

743R12=0

Description

Illumination set small without camera

Illumination set big without camera



Footshell replacement tool, metal

Reference number 2C100

The 2C100 shoehorn is a metal tool for replacing the footshell on prosthetic feet.

Technical data

Article number	Material
2C100	Stainless steel



Footshell replacement tool, plastic

Reference number 2C101

The 2C101 shoehorn is a plastic tool for replacing the footshell on prosthetic feet. In addition to a grey marble look, the shoehorn has a hole to hang it up.

Technical data

Article number	Material
2C101	Plastic

Prosthetic feet

Exoskeletal design



Pirogoff foot

Reference number 1P9

The Pirogoff foot is a prosthetic foot with an exoskeletal design, consisting of a foot component and a wooden midfoot.

Technical data

Side	left (L), right (R)
Sizes	23-28 cm
Foot shape	Normal foot shape with a heel height of 10 mm
Colour	wood colour/ beige

* Technical data refer to the size of 26 cm

- Use 636W17 PUR adhesive with 636W26 hardener to bond the mid-foot to the foot component. The adhesive and hardener are not included in the scope of delivery and must be ordered separately.

Information material

647G1523=ALL_INT IFU 1P9

Order example

Reference number	= Side	Size
1P9	= L	26

Prosthetic feet (selection)



Page 1/3

Customer		Shipping address (if different from customer address)	
Customer no.	<input type="text"/>	Customer no.	<input type="text"/>
Company	<input type="text"/>	Company	<input type="text"/>
Street	<input type="text"/>	Street	<input type="text"/>
Postal code/ city	<input type="text"/>	Postal code/ city	<input type="text"/>
Phone	<input type="text"/>	Phone	<input type="text"/>
Prosthetist	<input type="text"/>	Com.	<input type="text"/>

Patient data

Name
 Gender male female
 Weight kg
 Foot size cm
 Side of amputation left right both
 Stiffness/flexibility hard medium soft

Mobility grade

Mobility grade 3 
 Moderate activity and low impact load
 Everyday activities such as walking and climbing stairs
 Moderate activity and moderate impact load
 Everyday activities, fast walking, even on difficult terrain, leisure activities such as hiking, playing golf, etc.
 Mobility grade 4 
 Moderate activity and high impact load
 Varied activities, above-average impact and mechanical strain on the prosthesis
 High activity and high impact load
 Leisure activities such as skiing, sprinting, weight-lifting etc.

Date Place Signature

Pylon Foot

Page 2/3

Customer-No.

Pylon Foot

qty. **1E58** Axtion DP with 13 mm heel height
system height: A, B pylon max. 368 mm

 The scope of delivery includes a tool to remove the footshell, a Spectra sock and crepe soles.

Adapter options for A pylon (up to max. 100 kg body weight)

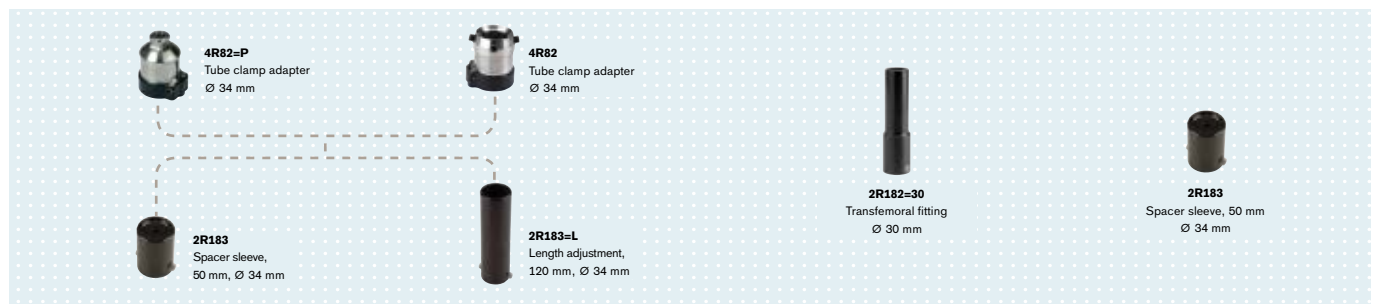

Connection to modular components with pyramid / pyramid receiver

- qty. **4R82=P** Tube clamp adapter \varnothing 34 mm SH* -12 mm
- qty. **4R82** Tube clamp adapter \varnothing 34 mm SH* 33 mm
- qty. **2R183** Spacer sleeve 50 mm SH* 6 mm \varnothing 34 mm
- qty. **2R183=L** Length adjustment 120 mm SH* 79 mm \varnothing 34 mm

Connection to modular components with tube clamp

- qty. **2R182=30** Transfemoral fitting SH* 89 mm \varnothing 30 mm
- qty. **2R183** Spacer sleeve, 50 mm SH* 6 mm \varnothing 34 mm

Adapter options for B pylon (from 101 – max. 125 kg body weight)

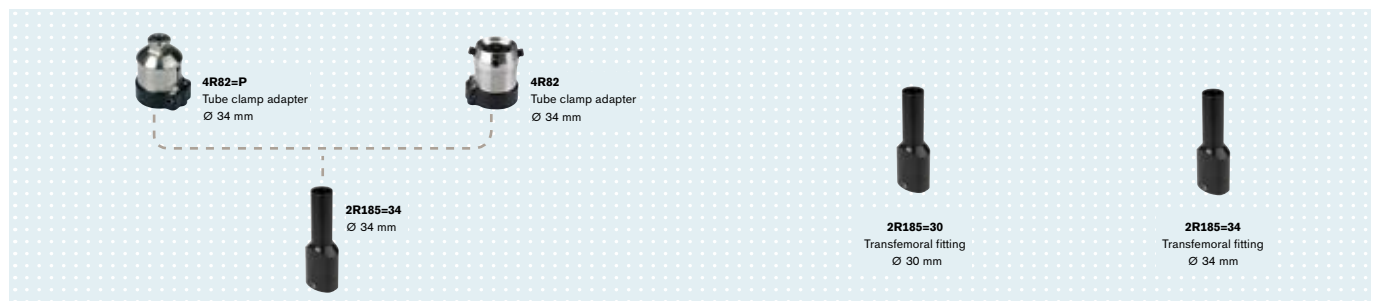

Connection to modular components with pyramid / pyramid receiver

- qty. **4R82=P** Tube clamp adapter \varnothing 34 mm SH* -12 mm
- qty. **4R82** Tube clamp adapter \varnothing 34 mm SH* 33 mm
- qty. **2R185=34** Transfemoral fitting 89 mm SH* \varnothing 34 mm

Connection to modular components with tube clamp

- qty. **2R185=30** Transfemoral fitting 89 mm SH* \varnothing 30 mm
- qty. **2R185=34** Transfemoral fitting 89 mm SH* \varnothing 34 mm

Footshell

qty. **2C5** Footshell with connection cap (Size 22–31)
Colour: beige light brown



Date

Place

Signature

Chopart and Modular Foot System

Page 3/3

Customer-No.

Chopart

qty. **1E81** Chopart footplate with 9 mm heel height
Minimal build height: 17-24 mm

• Please specify the footshell (2C5), adhesive set and optionally the filling foam in the selection below.

qty. **1E87** Children Chopart footplate with 6 mm heel height
Minimal build height: 17 mm

• Please specify the footshell (2E3) and the adhesive set in the selection below.

Modular Feet

qty. **1E57** Lo Rider with 9 mm heel height

• The scope of delivery includes a Spectra sock and heel wedges. Please specify the footshell (2C5 or SL=M/F) in the selection below. If you want to order the LoRider with an XO coupler instead of the pyramid, please specify this under "Adapter option for LoRider".

Adapter options for LoRider

qty. **XO Coupler** Adapter

• The XO coupler cannot be subsequently combined with the LoRider with pyramid. This means the standard adapter cannot be replaced by the XO coupler.

Footshells

qty. **2C5** Footshell with connection cap (Size 22-31) for 1E80, 1E81, 1E56 and 1E57 (Size 24-31)
Color: beige light brown

qty. **SL=M** Normal footshell for 1E57 (Size 23)
Color: beige

qty. **SL=F** Slim footshell for 1E57 (Size 22-23)
Color: beige

qty. **2E3** Footshell for children (Size 13-21)
Color: beige

Additional Accessories

qty. **SL=P078** Chopart Glue Kit

qty. **SL=P071** Fill Foam (optional)

qty. **2C100** Tool for change of foot cosmesis – plast

qty. **2C101** Tool for change of foot cosmesis – metal

qty. **SL=Spectra-Sock-7** Black protective sock

qty. **SL=Spectra-Sock2-7** Black protective sock, short

Date

Place

Signature

Silicone partial foot prosthesis iFab Ordering process

1. As the orthopaedic technician, you are responsible for determining the shape and colour as well as ordering the prosthesis:

The shape includes:

- Measuring the patient's residual limb
- Completing the measurement form
- Taking 4 informative photos of the left and right foot
- Creating a plaster negative of the affected side
- Note for the „Classic“ version: Also prepare a negative for the contralateral side

Depending on the prosthesis version, determine the colour using the colour sheet (647F285=GB) and the colour ring (89D4). The order forms must be fully completed before placing the order.

2. Ottobock Service Fabrication will fabricate the trial prosthesis according to your specifications and ship it within 10 working days.

3. You as the prosthetist can provide the trial prosthesis to your patient for approximately 4 weeks for testing. If required, you can modify the trial prosthesis yourself. After the test phase, please return the trial prosthesis to Ottobock Service Fabrication.

4. Ottobock Service Fabrication will fabricate the definitive prosthesis according to your specifications and ship it within 15 working days.

5. When the definitive prosthesis is received, you can fit your patient with an individual and functional silicone partial foot prosthesis that helps to harmonise the gait pattern.

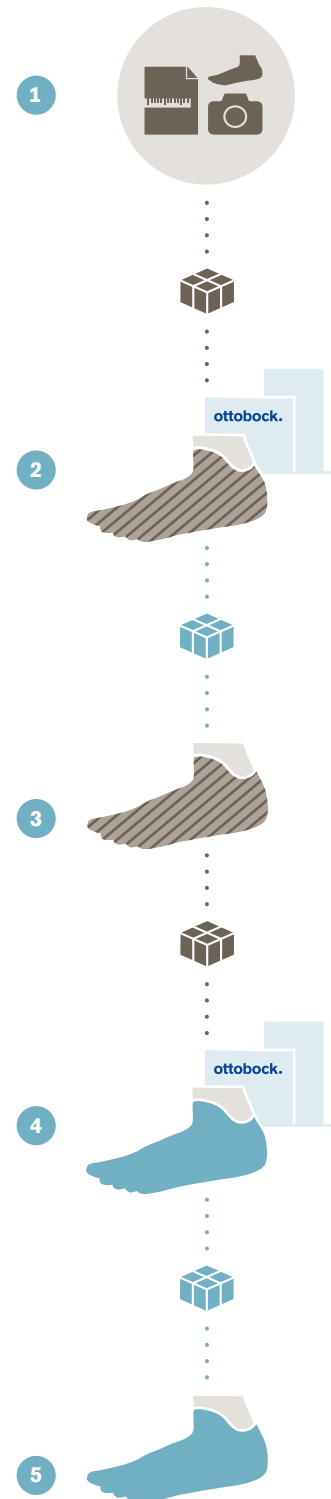

Silicone partial foot prosthesis

iFab Order form

Contact	<input type="text"/>	Customer number	<input type="text"/>	Date	<input type="text"/>
Customer			Shipping address (if different from customer address)		
Company	<input type="text"/>	Company	<input type="text"/>		
Street	<input type="text"/>	Street	<input type="text"/>		
Postal code/city	<input type="text"/>	Postal code/city	<input type="text"/>	<input type="text"/>	
Email	<input type="text"/>	Phone	<input type="text"/>		
Commission	<input type="text"/>				

Age: **Gender:** Female Male
Height: **Affected side:** Left Right
Weight: **Activity level:** 1 2 3 4 

Configuration:

- 88A31=2** Trial prosthesis
- 88A33=P** 2. Trial prosthesis
- 88A31=1** Definitive prosthesis "Basic"
- 88A32=1** Definitive prosthesis "Classic"
- 88A32=3** Definitive prosthesis "Natural"
- Colour determination as per colour determination sheet
- Silicone nails (unicoloured)
- 88A32=S** Silicone nails (multicoloured)
- 88A32=A** Acrylic nails (multicoloured)
- Genuine hair
- 88A20=T** Tattoo (Implementation of special requests)

For the "Classic" and "Natural" versions, the following are also required:

- Colour determination sheet
- Photos with photo background
- Cast of contralateral side

Diagnosis:

- Accident
- Diabetes
- Dysmelia
- Other
- Leg length discrepancy
- Accompanying diseases

Comments:

.....

.....

.....

Silicone partial foot prosthesis

iFab Measurement form

Contact	Customer number	Date
---------	-----------------	------

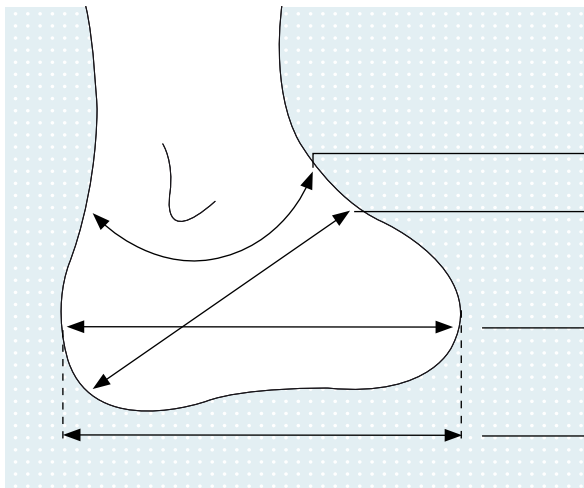

Measurements (in mm)	Residual limb	Plaster	Model
	Prosthetist	Ottobock	
Bow-shaped circumference (below medial and lateral ankle tip)	○		
Circumference heel/back of foot (h-measurement)	○		
Horizontal residual limb circumference (at the widest point)	○		
m-l width measurement below the lateral ankle	□		
Overall residual limb length	□		

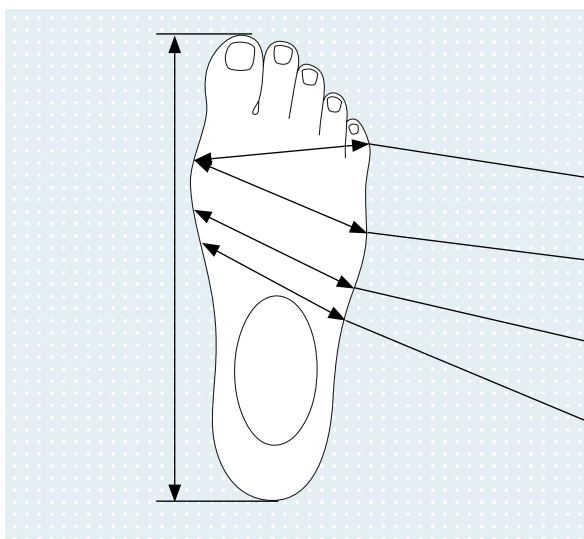

Circumference (in mm)	Residual limb	Plaster	Model
	Prosthetist	Ottobock	
Little toe – Ball of big toe	○		
Ball of little toe – Ball of big toe	○		
Circumference in front of instep	○		
Instep circumference	○		
Overall foot length in mm:	□		

For partial foot amputation, please mark the course of the amputation on the back with corresponding circumference/length measurements.

Comments:

.....

.....

.....

.....

Silicone partial foot prosthesis

iFab Colour determination sheet

Contact <input style="width: 90%;" type="text"/>	Customer number <input style="width: 90%;" type="text"/>	Date <input style="width: 90%;" type="text"/>
--	--	---

Colour determination for "Classic" version

Use pen to mark skin colours on the sketch

Colour sample – colour strength

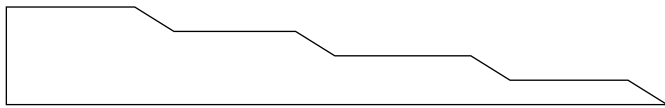

IV	III*	II	I
Pen	Colour sample	Colour strength	
1			
2			
3			
4			
5			
6			
7			
8			

Model blood vessels: Yes No

*Use thickness III for the primer.

Nails

- Acrylic
- Silicone

Nail length

- Like photo
- mm longer

Colour

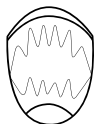

Nail tip

Distal edge

Central

Proximal edge

Moon

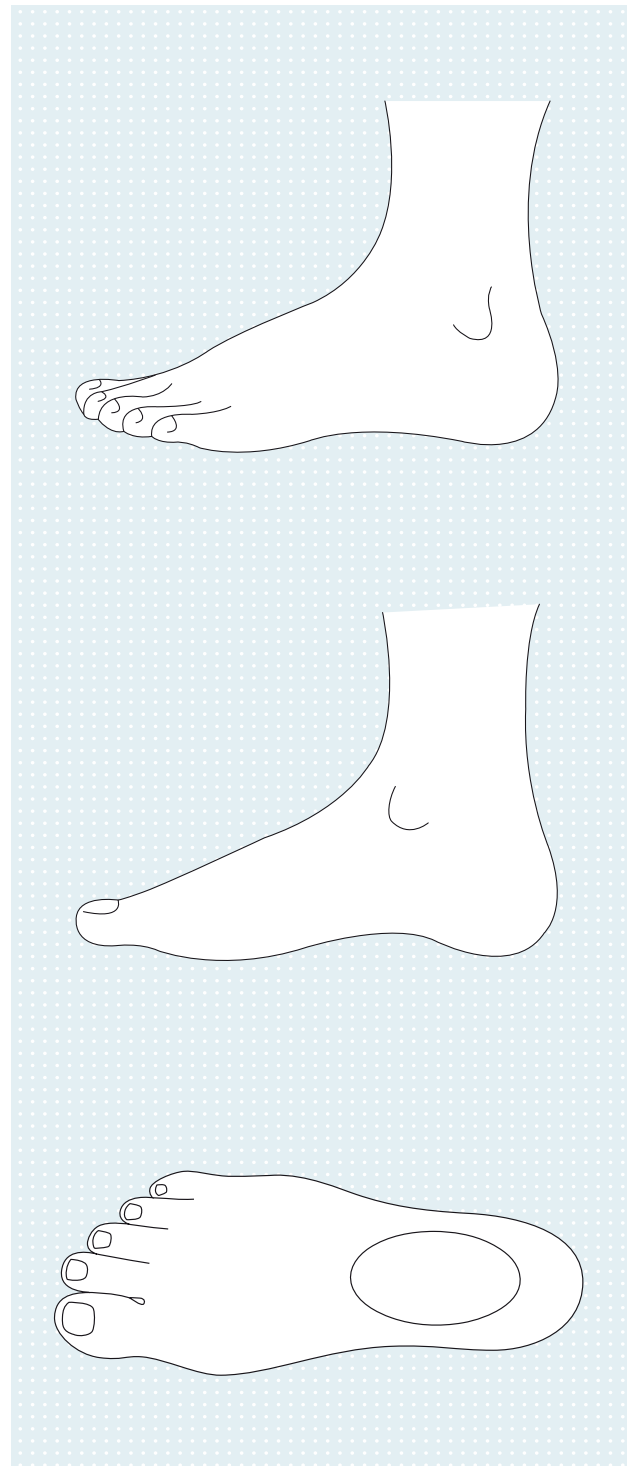



Adapters



Adapters

Tube adapters and tube clamp adapters 30 mm



Tube adapter

Reference number 2R37/2R38

The 2R37 and 2R38 tube adapters differ in length. They connect prosthetic components to each other. Adapter combinations allow for controlled angle and translational adaptation in the sagittal and frontal plane as well as adjustment of inward and outward rotation. They are resistant to fresh, salt and chlorinated water.



Information material

647G902=ALL_INT IFU Tube adapters

Technical data

Article number	Diameter	Material	Min. system height	Max. system height	Min. build height	Overall length	Weight	Max. body weight
2R37	30 mm	Titanium	97 mm	232 mm	53 mm	214 mm	160 g	100 kg
2R38	30 mm	Titanium	97 mm	472 mm	53 mm	454 mm	275 g	136 kg

- For high loads on transtibial prostheses, a tube adapter with Ø 34 mm should be used (e.g. 2R57/2R76).



Tube adapter

Reference number 2R50/2R49

The 2R50 and 2R49 tube adapters differ in length. They connect prosthetic components to each other. Adapter combinations allow for controlled angle and translational adaptation in the sagittal and frontal plane as well as adjustment of inward and outward rotation.



Information material

647G902=ALL_INT IFU Tube adapters

Technical data

Article number	Diameter	Material	Min. system height	Max. system height	Min. build height	Overall length	Weight	Max. body weight
2R50	30 mm	Aluminium	97 mm	232 mm	53 mm	214 mm	155 g	125 kg
2R49	30 mm	Aluminium	97 mm	472 mm	53 mm	414 mm	255 g	125 kg

- For high loads on transtibial prostheses, a tube adapter with Ø 34 mm should be used (e.g. 2R57/2R76).



Tube adapter

Reference number 2R50=AL/2R49=AL

The 2R50=AL and 2R49=AL tube adapters differ in length. They connect prosthetic components to each other. Adapter combinations allow for controlled angle and translational adaptation in the sagittal and frontal plane as well as adjustment of inward and outward rotation.

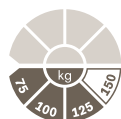

Max. 136 kg

Information material

647G902=ALL_INT	IFU Tube adapters
-----------------	-------------------

Technical data

Article number	Diameter	Material	Min. system height	Max. system height	Min. build height	Overall length	Weight	Max. body weight
2R50=AL	30 mm	Aluminium	97 mm	232 mm	53 mm	214 mm	155 g	136 kg
2R49=AL	30 mm	Aluminium	97 mm	472 mm	53 mm	414 mm	255 g	136 kg

- For high loads on transtibial prostheses, a tube adapter with Ø 34 mm should be used (e.g. 2R57/2R76).



Tube adapter

Reference number 2R2/2R3

The 2R2 and 2R3 tube adapters differ in length. They connect prosthetic components to each other. Adapter combinations allow for controlled angle and translational adaptation in the sagittal and frontal plane as well as adjustment of inward and outward rotation.



Max. 100 kg

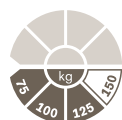

Max. 136 kg

Information material

647G902=ALL_INT	IFU Tube adapters
-----------------	-------------------

Technical data

Article number	Diameter	Material	Min. system height	Max. system height	Min. build height	Overall length	Weight	Max. body weight
2R2	30 mm	Stainless steel	97 mm	232 mm	53 mm	214 mm	195 g	100 kg
2R3	30 mm	Stainless steel	97 mm	472 mm	53 mm	454 mm	315 g	136 kg

- For high loads on transtibial prostheses, a tube adapter with Ø 34 mm should be used (e.g. 2R57/2R76).

Adapters

Tube adapters and tube clamp adapters 30 mm



Information material

647G902=ALL_INT IFU Tube adapters

Tube adapter, angled

Reference number 2R38=10

The 2R38=10 tube adapter connects the prosthetic components with each other. Adapter combinations allow for controlled angle and translational adaptation in the sagittal and frontal plane as well as adjustment of inward and outward rotation. It is angled by 10°.



Max. 100 kg



Technical data

Article number	Diameter	Material	Min. system height	Max. system height	Min. build height	Overall length	Weight	Angular offset	Max. body weight
2R38=10	30 mm	Titanium	98 mm	474 mm	53 mm	459 mm	275 g	10 °	100 kg

- For high loads on transtibial prostheses, a tube adapter with Ø 34 mm should be used (e.g. 2R57/2R76).



Information material

647G903=ALL_INT IFU Tube clamp adapters

Tube clamp adapter

Reference number 4R52

The 4R52 tube clamp adapter connects the prosthetic components with each other. Adapter combinations allow for controlled angle and translational adaptation in the sagittal and frontal plane as well as adjustment of inward and outward rotation.



Max. 100 kg



Max. 136 kg

Technical data

Article number	Diameter	Material	System height	Build height	Weight	Max. body weight
4R52	30 mm	Titanium	33 mm	48 mm	75 g	100 kg
4R52=1	30 mm	Titanium	33 mm	48 mm	80 g	136 kg

- For high loads on transtibial prostheses, a tube clamp adapter with Ø 34 mm (e.g. 4R82/4R91) should be used.
- The 4R52=1 tube clamp adapter may only be used for transfemoral prostheses and must be positioned directly under the prosthetic knee joint or the prosthetic socket.



Tube clamp adapter

Reference number 4R69

The 4R69 tube clamp adapter connects the prosthetic components with each other. Adapter combinations allow for controlled angle and translational adaptation in the sagittal and frontal plane as well as adjustment of inward and outward rotation.



Max. 125 kg

Technical data

Information material

647G903=ALL_INT IFU Tube clamp adapters

Article number	Diameter	Material	System height	Build height	Weight	Max. body weight
4R69	30 mm	Aluminium	33 mm	49 mm	75 g	125 kg

- For high loads on transtibial prostheses, a tube clamp adapter with \varnothing 34 mm (e.g. 4R82/4R91) should be used.



Tube clamp adapter

Reference number 4R69

The 4R69=AL tube clamp adapter connects the prosthetic components with each other. Adapter combinations allow for controlled angle and translational adaptation in the sagittal and frontal plane as well as adjustment of inward and outward rotation.



Max. 136 kg

Technical data

Information material

647G903=ALL_INT IFU Tube clamp adapters

Article number	Diameter	Material	System height	Build height	Weight	Max. body weight
4R69=AL	30 mm	Aluminium	33 mm	49 mm	75 g	136 kg

- For high loads on transtibial prostheses, a tube clamp adapter with \varnothing 34 mm (e.g. 4R82/4R91) should be used.

Adapters

Tube adapters and tube clamp adapters 30 mm



Information material

647G903=ALL_INT IFU Tube clamp adapters

Tube clamp adapter

Reference number 4R21

The 4R21 tube clamp adapter connects the prosthetic components with each other. Adapter combinations allow for controlled angle and translational adaptation in the sagittal and frontal plane as well as adjustment of inward and outward rotation.



Technical data

Article number	Diameter	Material	System height	Build height	Weight	Max. body weight
4R21	30 mm	Stainless steel	33 mm	49 mm	130 g	100 kg
4R21=1	30 mm	Stainless steel	33 mm	49 mm	125 g	136 kg

- A tube clamp adapter with \varnothing 34 mm (e.g. 4R82/4R91) should be used for high loads on transtibial prostheses.
- The 4R21=1 tube clamp adapter may only be used for transfemoral prostheses and must be positioned directly under the prosthetic knee joint or the prosthetic socket.



Information material

647G1618=ALL_INT IFU 4R88 4R103

Tube clamp adapter, movable

Reference number 4R103

The 4R103 adapter permits translational adjustments at the proximal end of a tube adapter. It therefore allows the components of the prosthesis to be shifted in parallel, regardless of the angle adjustment. The adjustments can be made either in the frontal plane – medial or lateral – or in the sagittal plane – anterior or posterior.



Technical data

Article number	Material	System height	Build height	Weight	Max. body weight
4R103	Titanium	51 mm	78 mm	185 g	85 kg

- A tube clamp adapter with \varnothing 34 mm should be used (e.g. 4R88) for high loads on transtibial prostheses.



Tube clamp adapter, movable

Reference number 4R98

The 4R98 adapter permits translational adjustments at the proximal end of a tube adapter. It therefore allows the components of the prosthesis to be shifted in parallel, regardless of the angle adjustment. The adjustments can be made either in the frontal plane – medial or lateral – or in the sagittal plane – anterior or posterior.



Max. 75 kg



Information material

647G1617=ALL_INT IFU 4R98

Technical data

Article number	Diameter	Material	System height	Build height	Weight	Max. body weight
4R98	30 mm	Aluminium	57 mm	84 mm	150 g	75 kg

- A tube clamp adapter with Ø 34 mm should be used (e.g. 4R88) for high loads on transtibial prostheses.



Tube clamp adapter, angled

Reference number 4R56

The 4R56 tube clamp adapter is used in prostheses in combination with a hip joint. It is available with three different angles and, among other things, connects the 7E10 Helix 3D hip joint to the 2R30 tube, and this to the 4R57 rotation adapter or a knee joint.

Key features

- Angled by 10°, 20° and 30° for alignment optimisation

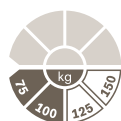

Max. 100 kg



Information material

647G903=ALL_INT IFU Tube clamp adapters

Technical data

Article image



Article number	4R56	4R56=1	4R56=2
Diameter	30 mm	30 mm	30 mm
Material	Titanium	Titanium	Titanium
System height	34 mm	34 mm	35 mm
Build height	54 mm	54 mm	55 mm
Weight	85 g	85 g	100 g
Angular offset	10 °	20 °	30 °
Max. body weight	100 kg	100 kg	100 kg

- The 4R56=1/2 tube clamp adapter with a 20°/30° angle is recommended for larger pelvic sockets. When using "HD" knee joints, note the 10° angle of the pyramid.



Clamping screw

Reference number 501Z16

Technical data

Article number	Spare part for
501Z16	4R103



Single component pack

Reference number 4D4

Technical data

Article number	Spare part for
4D4	4R21 4R52 4R56 4R56=1 4R56=2 4R103

Adapters

Tube adapters and tube clamp adapters 34 mm



Tube adapter

Reference number 2R57/2R58

The 2R57 and 2R58 tube adapters differ in length. They connect prosthetic components to each other. Adapter combinations allow for controlled angle and translational adaptation in the sagittal and frontal plane as well as adjustment of inward and outward rotation. The 2R57 and 2R58 are resistant to fresh, salt and chlorinated water.



Max. 150 kg

Information material

647G902=ALL_INT IFU Tube adapters

Technical data

Article number	Diameter	Material	Min. system height	Max. system height	Min. build height	Overall length	Weight	Max. body weight
2R57	34 mm	Titanium	77 mm	282 mm	27 mm	264 mm	220 g	150 kg
2R58	34 mm	Titanium	77 mm	472 mm	27 mm	454 mm	330 g	150 kg



Tube adapter

Reference number 2R76/2R77

The 2R76 and 2R77 tube adapters differ in length. They connect prosthetic components to each other. Adapter combinations allow for controlled angle and translational adaptation in the sagittal and frontal plane as well as adjustment of inward and outward rotation.



Max. 150 kg

Information material

647G902=ALL_INT IFU Tube adapters

Technical data

Article number	Diameter	Material	Min. system height	Max. system height	Min. build height	Overall length	Weight	Max. body weight
2R76	34 mm	Stainless steel	77 mm	282 mm	27 mm	264 mm	260 g	150 kg
2R77	34 mm	Stainless steel	77 mm	472 mm	27 mm	454 mm	370 g	150 kg



Tube clamp adapter

Reference number 4R82

The 4R82 tube clamp adapter connects the prosthetic components with each other. Adapter combinations allow for controlled angle and translational adaptation in the sagittal and frontal plane as well as adjustment of inward and outward rotation.



Max. 150 kg

Technical data

Information material

647G903=ALL_INT IFU Tube clamp adapters

Article number	Diameter	Material	System height	Build height	Weight	Max. body weight
4R82	34 mm	Titanium	33 mm	49 mm	95 g	150 kg



Tube clamp adapter

Reference number 4R82

The 4R82=P tube clamp adapter connects the prosthetic components with each other. Adapter combinations allow for controlled angle and translational adaptation in the sagittal and frontal plane as well as adjustment of inward and outward rotation.



Max. 150 kg

Technical data

Information material

647G903=ALL_INT IFU Tube clamp adapters

Article number	Diameter	Material	System height	Build height	Weight	Max. body weight
4R82=P	34 mm	Titanium	-12 mm	43 mm	90 g	150 kg

Adapters

Tube adapters and tube clamp adapters 34 mm



Tube clamp adapter

Reference number 4R91

The 4R91 tube clamp adapter connects the prosthetic components with each other. Adapter combinations allow for controlled angle and translational adaptation in the sagittal and frontal plane as well as adjustment of inward and outward rotation.



Max. 150 kg

Technical data

Article number	Diameter	Material	System height	Build height	Weight	Max. body weight
4R91	34 mm	Stainless steel	33 mm	49 mm	140 g	150 kg

Information material

647G903=ALL_INT IFU Tube clamp adapters



Tube clamp adapter, movable

Reference number 4R88

The 4R88 adapter permits translational adjustments at the proximal end of a tube adapter. It therefore allows the components of the prosthesis to be shifted in parallel, regardless of the angle adjustment. The adjustments can be made either in the frontal plane – medial or lateral – or in the sagittal plane – anterior or posterior.



Max. 125 kg



Technical data

Article number	Diameter	Material	System height	Build height	Weight	Displacement	Max. body weight
4R88	34 mm	Titanium	51 mm	78 mm	185 g	+/- 11 mm	125 kg

Information material

647G1618=ALL_INT IFU 4R88 4R103



Information material

647G903=ALL_INT

IFU Tube clamp adapters

Tube clamp adapter, angled

Reference number 4R156

The adapter is available with three different angles.

Due to its high load-bearing capacity, it is preferable for use in combination with the 7E9 prosthetic hip joint. In this case, the adapter is intended for the adjustable proximal connection of the prosthetic hip joint to the 2R36 thigh tube and for the adjustable distal connection of the 2R36 thigh tube to the pyramid of the prosthetic knee joint or the 4R57 rotation adapter.

Key features

- Angled by 10°, 20° and 30° for alignment optimisation



Max. 150 kg



Technical data

Article image



Article number	4R156	4R156=1	4R156=2
Diameter	34 mm	34 mm	34 mm
Material	Titanium	Titanium	Titanium
System height	36 mm	37 mm	38 mm
Build height	50 mm	50 mm	51 mm
Weight	145 g	175 g	185 g
Angular offset	10 °	20 °	30 °
Max. body weight	150 kg	150 kg	150 kg

- The 4R156=1/=2 tube clamp adapter with a 20°/30° angle is recommended for larger pelvic sockets. When using "HD" knee joints, note the 10° angle of the pyramid.



Information material

647G902=ALL_INT

IFU Tube adapters

Light metal tube

Reference number 2R36

The 2R36 Light metal tube is used in treatments with a prosthetic hip joint. It serves as the connection between two tube clamp adapters, e.g. the 4R82 or 4R156.



Max. 125 kg

Technical data

Article number	Diameter	Material	Min. system height	Max. system height	Min. build height	Overall length	Weight	Max. body weight
2R36	34 mm	Aluminium	73 mm	380 mm	10 mm	380 mm	215 g	125 kg

Adapters

Tube adapters and tube clamp adapters 34 mm

Accessories/spare parts for tube adapters and tube clamp adapters 34 mm



Set screw

Reference number 506G3

The 506G3 set screws are intended for adapters with a pyramid receiver. They are available in various lengths. Set screws that are protruding or recessed too much should be replaced with appropriate ones.

Technical data

Article number	Length
506G3=M8X12-V	12 mm
506G3=M8X14	14 mm
506G3=M8X16	16 mm



Single component pack

Reference number 4D4

Technical data

Article number	Spare part for
4D4	4R82 4R82=P 4R88 4R91

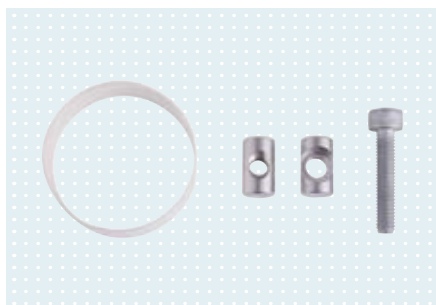

Single component pack

Reference number 4D28

Technical data

Article number	Spare part for
4D28	4R156 4R156=1 4R156=2



Plastic ring

Reference number 4X28

Technical data

Article number	Spare part for
4X28=3	4R156



Clamping screw

Reference number 501Z16

Technical data

Article number

501Z16

Spare part for

4R88

Adapters

Double and sliding adapters



Information material

647G1619=ALL_INT IFU Double adapters titanium

Double adapter, titanium

Reference number 4R72

The 4R72 double adapters made of titanium are used to connect two pyramids. The pyramid receivers enable distal and proximal angle adjustments in the frontal and sagittal planes. They are resistant to fresh, salt and chlorinated water.



Max. 150 kg

Technical data

Article image



Article number	4R72=32	4R72=45	4R72=60	4R72=75
Material	Titanium	Titanium	Titanium	Titanium
System height	69 mm	82 mm	97 mm	112 mm
Build height	32 mm	45 mm	60 mm	75 mm
Weight	85 g	95 g	110 g	125 g
Max. body weight	150 kg	150 kg	150 kg	150 kg



Information material

647G1101=ALL_INT IFU Double adapters aluminium

Double adapter, aluminium

Reference number 4R72

The 4R72 double adapters made of aluminium are used to connect two pyramids. The pyramid receivers enable distal and proximal angle adjustments in the frontal and sagittal planes.



Max. 136 kg

Technical data

Article image



Article number	4R72=32AL	4R72=45AL	4R72=60AL	4R72=75AL	4R72=90AL
Material	Aluminium	Aluminium	Aluminium	Aluminium	Aluminium
System height	69 mm	82 mm	97 mm	112 mm	127 mm
Build height	32 mm	45 mm	60 mm	75 mm	90 mm
Weight	80 g	95 g	105 g	110 g	120 g
Max. body weight	136 kg	136 kg	136 kg	136 kg	136 kg



Double adapter, sliding

Reference number 4R104

The 4R104 sliding double adapter is used to connect two pyramids. The pyramid receivers enable distal and proximal angle adjustments of the prosthetic components in the frontal and sagittal planes. The dovetail guide makes it possible to shift the prosthetic components in the frontal and sagittal planes.



Max. 100 kg



Information material

647G1620=ALL_INT IFU 4R104

Technical data

Article image



Article number	4R104=60	4R104=75
Material	Titanium	Titanium
System height	97 mm	112 mm
Build height	60 mm	75 mm
Weight	215 g	225 g
Displacement	+/- 11 mm	+/- 11 mm
Max. body weight	100 kg	100 kg



Double adapter

Reference number 4R76

The 4R76 double adapter is used to connect two pyramid receivers. Due to the shape of the support surfaces, the adapter permits horizontal shifting on the flat side and an angle adjustment on the rounded side.



Max. 150 kg

Technical data

Article number	Material	System height	Build height	Weight	Max. body weight
4R76	Stainless steel	-32 mm	4 mm	95 g	150 kg

Information material

647G300=ALL_INT IFU 4R76 4R78

Adapters

Double and sliding adapters



Double adapter

Reference number 4R78

The 4R78 double adapter is used to connect two pyramid receivers. Due to the shape of the support surfaces, the adapter permits an angle adjustment on both sides.



Max. 150 kg

Technical data

Article number	Material	System height	Build height	Weight	Max. body weight
4R78	Stainless steel	-30 mm	6 mm	115 g	150 kg

Information material

647G300=ALL_INT IFU 4R76 4R78



Sliding adapter

Reference number 6A53

The 6A53 sliding adapter permits the distal components of the modular prosthesis to be shifted in parallel, regardless of the angle adjustment by the pyramids. The adjustments can be made either in the frontal plane – medial or lateral – or in the sagittal plane – wwanterior or posterior.



Max. 125 kg



Technical data

Article number	Material	System height	Build height	Weight	Displacement	Max. body weight
6A53	Aluminium	-16 mm	20 mm	180 g	20 mm	125 kg

Information material

647G763=ALL_INT IFU 6A53 6A54



Sliding adapter

Reference number 6A54

The 6A54 sliding adapter permits the distal components of the modular prosthesis to be shifted in parallel, regardless of the angle adjustment by the pyramids. The adjustments can be made either in the frontal plane – medial or lateral – or in the sagittal plane – anterior or posterior.



Max. 125 kg



Information material

647G763=ALL_INT

IFU 6A53 6A54

Technical data

Article number	Material	System height	Build height	Weight	Displacement	Max. body weight
6A54	Aluminium	33 mm	33 mm	180 g	20 mm	125 kg



Double adapter

Reference number 4R84

The 4R84 double adapter features a pyramid and pyramid receiver. It serves as a connecting element between prosthetic components. Proximal and distal angle adjustments in the frontal and sagittal planes are possible.



Max. 150 kg

Technical data

Article number	Material	System height	Build height	Weight	Max. body weight
4R84	Titanium	36 mm	36 mm	115 g	150 kg

Information material

647G1621=ALL_INT

IFU 4R84

Adapters

Double and sliding adapters



Connection adapter

Reference number 4R84=D

The 4R84=D and 4R84=D-62 connection adapters provide the connection between a tube clamp and a pyramid receiver. They differ in length and the material. The 4R84=D-62 adapter can be shortened. The 4R84=D adapter is resistant to fresh, salt and chlorinated water.



Max. 150 kg

Information material

647G1622=ALL_INT

IFU Connection adapters

Technical data

Article image



Article number	4R84=D	4R84=D-62
Diameter	30 mm	30 mm
Material	Titanium	Stainless steel
System height	19 mm	-
Min. system height	-	20 mm
Max. system height	-	48 mm
Min. build height	10 mm	10 mm
Weight	65 g	145 g
Max. body weight	150 kg	150 kg

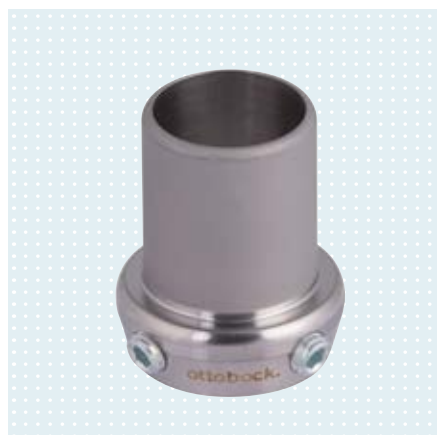

Information material

647G1622=ALL_INT IFU Connection adapters

Connection adapter with pyramid receiver

Reference number 4R72=D

The 4R72=D and 4R72=D-62 connection adapters provide the connection between a tube clamp and a pyramid. They differ in length and the material. The 4R72=D-62 adapter can be shortened.



Max. 150 kg

Technical data

Article image



Article number	4R72=D	4R72=D-62
Diameter	30 mm	30 mm
Material	Titanium	Stainless steel
System height	66 mm	-
Min. system height	-	67 mm
Max. system height	-	96 mm
Min. build height	21 mm	21 mm
Overall length	76 mm	47 mm
Weight	70 g	150 g
Max. body weight	150 kg	150 kg



Information material

647G1622=ALL_INT IFU Connection adapters

Connection adapter with pyramid receiver

Reference number 4R75

The 4R75=D-70 connection adapter provides the connection between a tube clamp and a pyramid. It can be shortened.



Max. 150 kg

Technical data

Article number	4R75=D-70
Diameter	34 mm
Material	Stainless steel
Min. system height	76 mm
Max. system height	106 mm
Min. build height	25 mm
Overall length	89 mm
Weight	170 g
Max. body weight	150 kg

Adapters

Double and sliding adapters



Pyramid with threaded connector

Reference number 4R50

The 4R50 pyramid with threaded connector is used in combination with the 4R44=L pyramid receiver with threaded connector for individual length compensation and rotation adjustment in lower limb prostheses.



Max. 150 kg

Information material

647G185=ALL_INT IFU 4R44=L 4R50

Technical data

Article number	Material	System height	Build height	Weight	Max. body weight
4R50	Titanium	-1 mm	17 mm	70 g	150 kg



Pyramid receiver with threaded connector

Reference number 4R44=L

The 4R44=L adapter is used in combination with the 4R50 pyramid with threaded connector for individual length compensation and rotation adjustment in lower limb prostheses. The adapter can be reduced in length. The combination of the 4R44=L with a lamination anchor with threaded connector creates a length-adjustable socket connector.



Max. 150 kg

Information material

647G185=ALL_INT IFU 4R44=L 4R50

Technical data

Article number	4R44=L
Min. system height	31 mm
Max. system height	91 mm
Min. build height	22 mm
Overall length	87 mm
Weight	210 g
Max. body weight	150 kg
Material	Stainless steel



Sliding adapter

Reference number 4R101

The 4R101 sliding adapter permits translational adjustments in the frontal and sagittal planes. It consists of an upper and a lower part, which can be moved against each other. The displacement can be read on a scale. The adapter is installed between the socket attachment block and the socket adapter.



Max. 100 kg



Information material

647G1628=ALL_INT IFU 4R101

Technical data

Article number	Material	System height	Build height	Weight	Offset in m-l and a-p direction	Max. body weight
4R101	Aluminium	25 mm	25 mm	205 g	+/- 11 mm	100 kg

- The 4R101 sliding adapter may only be used in transfemoral prostheses, proximal to the prosthetic knee joint.

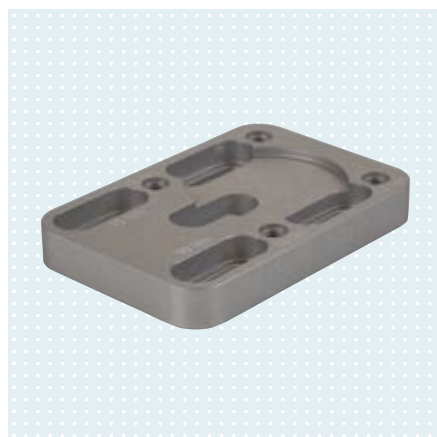

Adapter plate

Reference number 4R118

The 4R118 adapter plate is installed between the socket attachment block and socket adapter of a transfemoral prosthesis. It shifts the prosthetic knee joint in the posterior direction. The adapter plate permits repositioning between 10 mm and 25 mm.



Max. 125 kg



Information material

647G319=ALL_INT IFU 4R118

Technical data

Article number	Material	System height	Build height	Weight	Displacement	Max. body weight
4R118	Aluminium	10 mm	10 mm	75 g	10 - 25 mm	125 kg

- The 4R118 adapter plate may only be used in transfemoral prostheses, proximal to the prosthetic knee joint.

Adapters

Double and sliding adapters



Information material

647G644=ALL_INT IFU 4R170

Sliding adapter

Reference number 4R170

The 4R170=1 and 4R170=2 sliding adapters enable fast and easy adjustment of the socket flexion position in transfemoral prostheses thanks to the option to make adjustments along a circular path. The adjustment of the sliding proximal connector is made with an Allen wrench.

Key features

- The 4R170=1 is suitable for prostheses with a larger socket flexion setting
- The 4R170=2 is suitable for fittings with a smaller socket flexion setting
- The adjustment range for both adapters is 4°. The socket flexion angle can be changed at any time. The settings can be reproduced with the help of the attached scale
- The exterior thread is used to connect to a lamination anchor with threaded connector
- The 4R50 pyramid can be screwed onto the thread to establish the connection to a prosthetic component with a pyramid receiver
- The proximal connector can be exchanged for the 4R173 pyramid receiver, which has to be ordered separately



Max. 150 kg

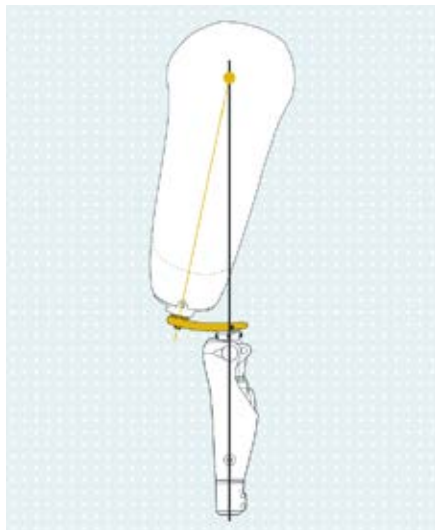

Technical data

Article image



Article number	4R170=1	4R170=2
Material	Stainless steel	Stainless steel
Distal connection	4-hole	4-hole
Proximal connection	Thread	Thread
System height	15 mm	15 mm
Build height	15 mm	15 mm
Weight	555 g	445 g
Displacement	4 mm	4 mm
Max. body weight	150 kg	150 kg

- The 4R170 sliding adapter may only be used in transfemoral prostheses, proximal to the prosthetic knee joint.
- For use in interim and definitive prostheses.
- Position the 4R170 sliding adapter 300 mm distally from the socket reference point, or as close to that as possible. Depending on the design, the length of the prosthesis then remains virtually unchanged despite changes in the socket flexion position.



Pyramid receiver

Reference number 4R173

The 4R173 pyramid receiver can be used instead of the sliding exterior thread of the 4R170.



Max. 150 kg



Information material

647G644=ALL_INT IFU 4R170

Technical data

Article number	Material	System height	Build height	Weight	Adjustment range	Max. body weight
4R173	Stainless steel	35 mm	17 mm	170 g	4 °	150 kg

Accessories/spare parts for double and sliding adapters



Set screw

Reference number 506G3

The 506G3 set screws are intended for adapters with a pyramid receiver. They are available in various lengths. Set screws that are protruding or recessed too much should be replaced with appropriate ones.

Technical data

Article number	Length
506G3=M8X12-V	12 mm
506G3=M8X14	14 mm
506G3=M8X16	16 mm



Clamping screw

Reference number 501Z16

Technical data

Article number	Spare part for
501Z16	4R104=60 4R104=75

Adapters

Double and sliding adapters



Set screw

Reference number 506G3

Technical data

Article number	Spare part for
506G3=M5X8	4R104=60 4R104=75



Cap screw (Allen screw)

Reference number 501Z2

Technical data

Article number	Spare part for
501Z2=M6X20	4R50



Clamping nut

Reference number 4Y212

Technical data

Article number	Spare part for
4Y212	4R101



Oval flange head screw (Allen screw)

Reference number 501S44

Technical data

Article number	Spare part for
501S44=M6X25	4R101

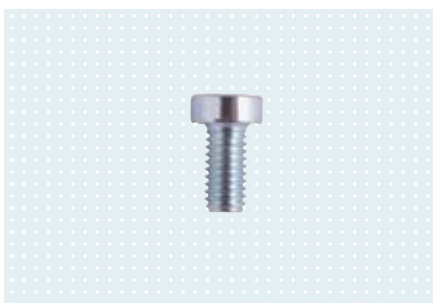

Cap screw

Reference number 501T61

Technical data

Article number	Length	Spare part for
501T61=M6X12	12 mm	4R118
501T61=M6X25	25 mm	4R118
501T61=M6X30	30 mm	4R118



Countersunk head screw (Allen screw)

Reference number 501S41

Technical data

Article number	Spare part for
501S41=M6X12	4R101 4R118
501S41=M6X16	4R101 4R118

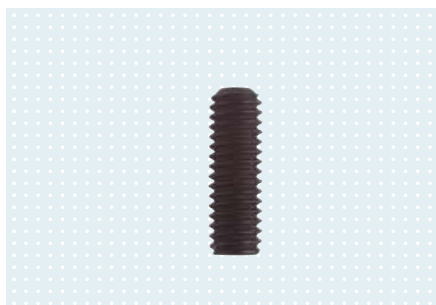

Set screw

Reference number 506G3

Technical data

Article number	Spare part for
506G3=M4X12	4R101

Adapters

Lamination anchor



Information material

647G1627=ALL_INT IFU 4R63 4R68 4R100

Lamination anchor with pyramid

Reference number 4R100

The 4R100 lamination anchor is intended for lamination into the transtibial socket. It serves to connect with the distal prosthetic components and is equipped with a pyramid. The 4R100 is resistant to fresh, salt and chlorinated water.



Max. 100 kg

Technical data

Article number	Material	System height	Build height	Weight	Max. body weight
4R100	Titanium	-7 mm	11 mm	40 g	100 kg

- The 4X3 lamination dummy and 4X52 lamination dummy are to be used for laminating. They are included with the lamination anchor.



Information material

647G1627=ALL_INT IFU 4R63 4R68 4R100

Lamination anchor with pyramid

Reference number 4R68

The 4R68 lamination anchor is intended for lamination into the transtibial socket. It serves to connect with the distal prosthetic components and is equipped with a pyramid.



Max. 100 kg

Technical data

Article number	Material	System height	Build height	Weight	Max. body weight
4R68	Aluminium	-7 mm	11 mm	70 g	100 kg

- The 4X3 lamination dummy is to be used for laminating. It is included with the lamination anchor.



Information material

647G1627=ALL_INT IFU 4R63 4R68 4R100

Lamination anchor with pyramid

Reference number 4R63

The 4R63 lamination anchor is intended for lamination into the transtibial socket. It serves to connect with the distal prosthetic components and is equipped with a pyramid.



Max. 136 kg

Technical data

Article number	Material	System height	Build height	Weight	Max. body weight
4R63	Stainless steel	-7 mm	11 mm	85 g	136 kg

- The 4X3 and 4X52 lamination dummies should be used during laminating. They are included with the lamination anchor.

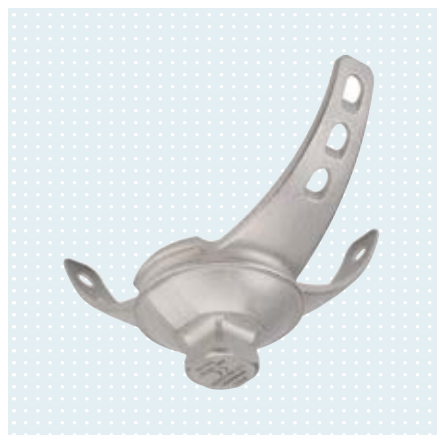

Lamination anchor with pyramid

Reference number 4R42

The 4R42 and 4R42=1 lamination anchors are laminated into a prosthetic socket. They serve to connect the prosthetic socket to the distal prosthetic components. The pyramid of the 4R42=1 has a bore-hole.



Max. 150 kg



Max. 136 kg

Information material

647G123=ALL_INT

IFU Lamination anchors

Technical data

Article image



Article number	4R42	4R42=1
Material	Stainless steel	Stainless steel
System height	-5 mm	-5 mm
Build height	13 mm	13 mm
Weight	130 g	125 g
Max. body weight	150 kg	136 kg

- The 4X3 lamination dummy is to be used for laminating. It is enclosed with the lamination anchors.



Lamination anchor with threaded connector

Reference number 4R43

The 4R43 lamination anchor is laminated into a prosthetic socket. It serves to connect the prosthetic socket to the distal prosthetic components.



Max. 125 kg

Technical data

Article number	Material	System height	Build height	Weight	Max. body weight
4R43	Stainless steel	8 mm	8 mm	95 g	125 kg

- The 4X46 or 4X46=ST lamination dummy (in combination with the 4R57=ST or 4R57=ST-WR) should be used when laminating. It must be ordered separately.

Information material

647G123=ALL_INT

IFU Lamination anchors

Adapters

Lamination anchor



Lamination anchor with pyramid, rotatable

Reference number 4R89

The 4R89 lamination anchor is laminated into a prosthetic socket. It serves to connect the prosthetic socket to the distal prosthetic components.



Max. 125 kg



Information material

647G123=ALL_INT IFU Lamination anchors

Technical data

Article number	Material	System height	Build height	Weight	Max. body weight
4R89	Stainless steel	-3 mm	15 mm	180 g	125 kg

- Use the 4X46 lamination dummy when laminating. It must be ordered separately.



Lamination anchor with pyramid receiver, rotatable

Reference number 4R41

The 4R41 lamination anchor is laminated into a prosthetic socket. It serves to connect the prosthetic socket to the distal prosthetic components.



Max. 125 kg



Information material

647G123=ALL_INT IFU Lamination anchors

Technical data

Article number	Material	System height	Build height	Weight	Max. body weight
4R41	Stainless steel	39 mm	21 mm	170 g	125 kg

- Use the 4X46 lamination dummy when laminating. It must be ordered separately.



Lamination anchor with threaded connector

Reference number 4R111=N/4R111=T

The 4R111=N and 4R111=T lamination anchors are laminated into a prosthetic socket. They serve to connect the prosthetic socket to the distal prosthetic components. The 4R111=T is waterproof.



Max. 150 kg



Max. 125 kg

Information material

647G123=ALL_INT IFU Lamination anchors

Technical data

Article number	Material	System height	Build height	Weight	Max. body weight
4R111=N	Stainless steel	13 mm	13 mm	80 g	150 kg
4R111=T	Stainless steel	13 mm	13 mm	85 g	125 kg

- During the lamination process the laminating aid 4X46 or 4X46=ST (in combination with 4R57=ST or 4R57=ST-WR) should be used. It must be ordered separately.
- The 4R111=T may only be used in transfemoral prostheses.



Lamination anchor with pyramid, rotatable

Reference number 4R116

The 4R116 and 4R116=T lamination anchors are laminated into a prosthetic socket. They serve to connect the prosthetic socket to the distal prosthetic components. The 4R116=T is waterproof.



Max. 150 kg



Max. 125 kg



Information material

647G123=ALL_INT IFU Lamination anchors

Technical data

Article number	Material	System height	Build height	Weight	Max. body weight
4R116	Stainless steel	2 mm	20 mm	165 g	150 kg
4R116=T	Stainless steel	2 mm	20 mm	170 g	125 kg

- Use the 4X46 lamination dummy when laminating. It must be ordered separately.
- The 4R116=T may only be used in transfemoral prostheses.

Adapters

Lamination anchor



Information material

647G123=ALL_INT

IFU Lamination anchors

Lamination anchor with pyramid receiver, rotatable

Reference number 4R111

The 4R111 lamination anchor is laminated into a prosthetic socket. It serves to connect the prosthetic socket to the distal prosthetic components.



Max. 150 kg



Technical data

Article number	Material	System height	Build height	Weight	Max. body weight
4R111	Stainless steel	44 mm	26 mm	155 g	150 kg

- Use the 4X46 lamination dummy when laminating. It must be ordered separately.



Information material

647G123=ALL_INT

IFU Lamination anchors

Lamination anchor with threaded connector and angled arm

Reference number 4R119=N*

The 4R119=N and 4R119=NT lamination anchors are laminated into a prosthetic socket. The angled anchor arm is intended for posterior positioning. It takes the flexion position of the residual limb/socket into account. The 4R119=NT is waterproof.



Max. 150 kg

Technical data

Article number	Material	System height	Build height	Weight	Max. body weight
4R119=N	Stainless steel	13 mm	13 mm	95 g	150 kg
4R119=NT	Stainless steel	13 mm	13 mm	95 g	150 kg

- The 4X46 or 4X46=ST lamination dummy (in combination with the 4R57=ST or 4R57=ST-WR) should be used when laminating. It must be ordered separately.
- The 4R119=N may only be used in transfemoral prostheses.



Lamination anchor with pyramid and angled arm, rotatable

Reference number 4R117

The 4R117 and 4R117=T lamination anchors are laminated into a prosthetic socket. The angled anchor arm is intended for posterior positioning. It takes the flexion position of the residual limb/socket into account. The 4R117=T is waterproof.



Max. 150 kg



Information material

647G123=ALL_INT

IFU Lamination anchors

Technical data

Article number	Material	System height	Build height	Weight	Max. body weight
4R117	Stainless steel	2 mm	20 mm	145 g	150 kg
4R117=T	Stainless steel Titanium	2 mm	20 mm	145 g	150 kg

- Use the 4X46 Lamination dummy when laminating. It must be ordered separately.



Lamination anchor with pyramid receiver and angled arm, rotatable

Reference number 4R119

The 4R119 and 4R119=T lamination anchors are laminated into a prosthetic socket. They have an angled anchor arm intended for posterior positioning. It takes the flexion position of the residual limb/socket into account. The 4R119=T is waterproof.



Max. 150 kg



Information material

647G123=ALL_INT

IFU Lamination anchors

Technical data

Article number	Material	System height	Build height	Weight	Max. body weight
4R119	Stainless steel	44 mm	26 mm	165 g	150 kg
4R119=T	Stainless steel Titanium	44 mm	26 mm	135 g	150 kg

- Use the 4X46 lamination dummy when laminating. It must be ordered separately.
- The 4R119 may only be used in transfemoral prostheses.

Adapters

Lamination anchor

Accessories/spare parts for lamination anchor



Lamination dummy

Reference number 4X3

Technical data

Article number	Spare part for
4X3	4R42 4R42=1 4R63 4R68 4R100



Lamination dummy

Reference number 4X52

Technical data

Article number	Spare part for
4X52	4R63 4R100



Lamination dummy

Reference number 4X46

Use the 4X46 lamination dummy when the lamination anchor is to be used with a screwed insert. Use the 4X46=ST when the next prosthetic component will be screwed directly into the anchor (e.g. 4R57=ST). It is somewhat higher proximally so that the thread does not come into contact with the laminate when fully screwed in.

Technical data

Article image



Article number	4X46	4X46=ST
Accessory for	4R41 4R43 4R89 4R111 4R111=N 4R111=T 4R116 4R116=T 4R117 4R117=T 4R119 4R119=N 4R119=NT 4R119=T	4R43 4R111=N 4R111=T 4R119=N 4R119=NT



Pyramid with threaded connector

Reference number 4R87

The 4R87 and 4R87=T pyramids with threaded connector are screwed into a lamination anchor with threaded connector. The 4R87=T is waterproof.

Technical data

Article number	Material	System height	Build height	Weight	Spare part for
4R87	Stainless steel	-11 mm	7 mm	85 g	4R89 4R116 4R117
4R87=T	Titanium	-11 mm	7 mm	50 g	4R116=T 4R117=T



Pyramid receiver with threaded connector

Reference number 4R44

The 4R44=N and 4R44=T pyramid receivers with threaded connector are screwed into a lamination anchor with threaded connector. The 4R44=T is waterproof.

Technical data

Article number	Material	System height	Build height	Weight	Spare part for
4R44=N	Stainless steel	31 mm	13 mm	75 g	4R41 4R111 4R119
4R44=T	Titanium	31 mm	13 mm	45 g	4R119=T



Cap screw (Allen screw)

Reference number 501Z2

Technical data

Article number	Length	Spare part for
501Z2=M5X22	22 mm	4R111 4R111=N 4R116 4R117 4R119 4R119=N
501Z2=M5X30	30 mm	4R41 4R43 4R89 4R111=T 4R116=T 4R117=T



Clamping screw, blue coated

Reference number 501T24

Technical data

Article number	Length	Spare part for
501T24=M5X25	25 mm	4R111=T 4R116=T 4R117=T 4R119=T 4R119=NT

Adapters

Lamination anchor



Rounded washer

Reference number 507U16

Technical data

Article number	Spare part for
507U16=5.2-NIRO	4R111
	4R111=N
	4R111=T
	4R116
	4R116=T
	4R117
	4R117=T
	4R119
	4R119=N
	4R119=T



Set screw

Reference number 506G3

The 506G3 set screws are intended for adapters with a pyramid receiver. They are available in various lengths. Set screws that are protruding or recessed too much should be replaced with appropriate ones.

Technical data

Article number	Length
506G3=M8X12-V	12 mm
506G3=M8X14	14 mm
506G3=M8X16	16 mm



Socket adapter with pyramid

Reference number 4R54

The 4R54 socket adapter is used to connect prosthetic components with a four-hole connector, such as the 5R1 and 5R2 socket attachment blocks or the Quickchange adapter. It is resistant to fresh, salt and chlorinated water.



Max. 150 kg

Technical data

Article number	Material	System height	Build height	Weight	Max. body weight
4R54	Titanium	-11 mm	7 mm	50 g	150 kg

Information material

647G1626=ALL_INT IFU Socket adapters



Socket adapter with pyramid

Reference number 4R74

The 4R74 socket adapter is used to connect prosthetic components with a four-hole connector, such as the 5R1 and 5R2 socket attachment blocks or the Quickchange adapter.



Max. 100 kg

Technical data

Article number	Material	System height	Build height	Weight	Max. body weight
4R74	Aluminium	-7 mm	11 mm	55 g	100 kg

Information material

647G1626=ALL_INT IFU Socket adapters



Socket adapter with pyramid

Reference number 4R74

The 4R74=AL socket adapter is used to connect prosthetic components with a four-hole connector, such as the 5R1 and 5R2 socket attachment blocks or the Quickchange adapter.

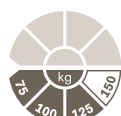

Max. 136 kg

Technical data

Article number	Material	System height	Build height	Weight	Max. body weight
4R74=AL	Aluminium	-7 mm	11 mm	70 g	136 kg

Information material

647G1626=ALL_INT IFU Socket adapters

Adapters

Socket adapter



Socket adapter with pyramid

Reference number 4R23

The 4R23 socket adapter is used to connect prosthetic components with a four-hole connector, such as the 5R1 and 5R2 socket attachment blocks or the Quickchange adapter.



Max. 125 kg

Technical data

Article number	Material	System height	Build height	Weight	Max. body weight
4R23	Stainless steel	-11 mm	7 mm	85 g	125 kg

Information material

647G1626=ALL_INT IFU Socket adapters



Socket adapter with pyramid, rotatable

Reference number 4R77

The 4R77 socket adapter is used to connect prosthetic components with a four-hole connector, such as the 5R1 and 5R2 socket attachment blocks or the Quickchange adapter. It is waterproof.



Max. 150 kg



Technical data

Article number	Material	System height	Build height	Weight	Max. body weight
4R77	Titanium	-9 mm	9 mm	70 g	150 kg

Information material

647G1626=ALL_INT IFU Socket adapters



Socket adapter with pyramid, eccentric

Reference number 4R73

The 4R73=A and 4R73=D socket adapters are used to connect prosthetic components with a four-hole connector, such as the 5R1 and 5R2 socket attachment blocks or the Quickchange adapter.

The 4R73=A enables displacement in the sagittal or frontal plane.

The 4R73=D enables displacement in the sagittal and frontal plane.



Max. 150 kg

Information material

647G1626=ALL_INT

IFU Socket adapters

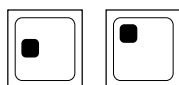

Technical data

Article number	Material	System height	Build height	Weight	Pyramid alignment	Max. body weight
4R73=A	Titanium	-11 mm	7 mm	115 g	Axially offset by 7 mm	150 kg
4R73=D	Titanium	-11 mm	7 mm	115 g	Diagonally offset by 5 mm	150 kg



Socket adapter with pyramid receiver

Reference number 4R55

The 4R55 socket adapter is used to connect prosthetic components with a four-hole connector, such as the 5R1 and 5R2 socket attachment blocks or the Quickchange adapter.



Max. 150 kg

Information material

647G1626=ALL_INT

IFU Socket adapters

Technical data

Article number	Material	System height	Build height	Weight	Max. body weight
4R55	Titanium	33 mm	15 mm	50 g	150 kg

Adapters

Socket adapter

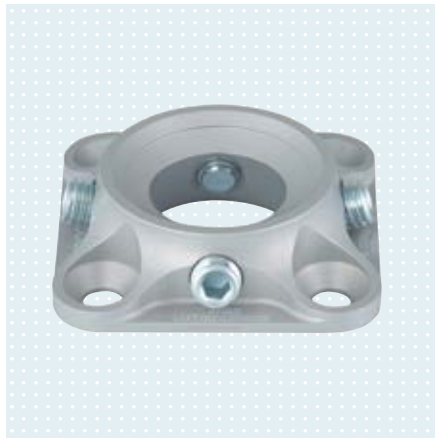

Socket adapter with pyramid receiver

Reference number 4R95

The 4R95 socket adapter is used to connect prosthetic components with a four-hole connector, such as the 5R1 and 5R2 socket attachment blocks or the Quickchange adapter.



Max. 100 kg

Technical data

Article number	Material	System height	Build height	Weight	Max. body weight
4R95	Aluminium	33 mm	15 mm	50 g	100 kg

Information material

647G1626=ALL_INT IFU Socket adapters



Socket adapter with pyramid receiver

Reference number 4R22

The 4R22 socket adapter is used to connect prosthetic components with a four-hole connector, such as the 5R1 and 5R2 socket attachment blocks or the Quickchange adapter.



Max. 125 kg

Technical data

Article number	Material	System height	Build height	Weight	Max. body weight
4R22	Stainless steel	33 mm	15 mm	85 g	125 kg

Information material

647G1626=ALL_INT IFU Socket adapters



Socket adapter with pyramid receiver, rotatable

Reference number 4R51

The 4R51 socket adapter is used to connect prosthetic components with a four-hole connector, such as the 5R1 and 5R2 socket attachment blocks or the Quickchange adapter.



Max. 150 kg



Technical data

Article number	Material	System height	Build height	Weight	Max. body weight
4R51	Titanium	36 mm	18 mm	80 g	150 kg

Information material

647G1626=ALL_INT IFU Socket adapters



Socket adapter with pyramid receiver, rotatable

Reference number 4R37

The 4R37 socket adapter is used to connect prosthetic components with a four-hole connector, such as the 5R1 and 5R2 socket attachment blocks or the Quickchange adapter.



Max. 125 kg



Information material

647G1626=ALL_INT IFU Socket adapters

Technical data

Article number	Material	System height	Build height	Weight	Max. body weight
4R37	Stainless steel	36 mm	18 mm	140 g	125 kg

Accessories/spare parts for socket adapter



Set screw

Reference number 506G3

The 506G3 set screws are intended for adapters with a pyramid receiver. They are available in various lengths. Set screws that are protruding or recessed too much should be replaced with appropriate ones.

Technical data

Article number	Length
506G3=M8X12-V	12 mm
506G3=M8X14	14 mm
506G3=M8X16	16 mm



Countersunk head screw (Allen screw)

Reference number 501S41

Technical data

Article number	Length	Spare part for
501S41=M6X12X11.4	12 mm	4R73=D 4R73=A
501S41=M6X25X11.4	25 mm	4R73=D 4R73=A
501S41=M6X30X11.4	30 mm	4R73=D 4R73=A

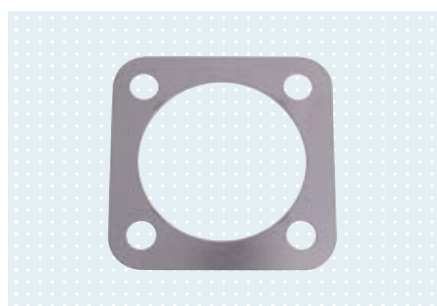

Pressure plate

Reference number 4Y19

Technical data

Article number	Spare part for
4Y19	4R37 4R51 4R77

Adapters

Socket attachment blocks



Socket attachment block for lamination technique

Reference number 5R1

The 5R1=1, 5R1=2, 5R1=6 and 5R1=6-H socket attachment blocks can be adapted to the contour of the prosthetic socket. They are laminated into the socket and serve to connect the prosthetic socket to a socket adapter.



Information material

647G92=ALL_INT IFU 5R1

Scope of delivery

5R1	Socket attachment block for lamination technique	1	Piece
501S41=M6X25	Countersunk head screw (Allen screw)	4	Piece
4X6	Lamination dummy	1	Piece

Technical data

Article image

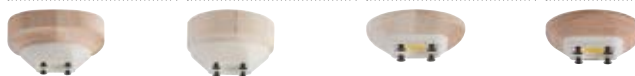

Article number	5R1=1	5R1=2	5R1=6	5R1=6-H
Material	Wood, Plastic	Wood, Plastic	Wood, Plastic	Wood, Plastic
System height	-	-	30 mm	33 mm
Min. system height	46 mm	46 mm	-	-
Max. system height	64 mm	64 mm	-	-
Build height	-	-	30 mm	33 mm
Min. build height	46 mm	46 mm	-	-
Overall length	64 mm	64 mm	-	-
Weight	445 g	305 g	155 g	155 g
Max. body weight	125 kg	125 kg	125 kg	150 kg

- The enclosed 4X6 lamination dummy is to be used for laminating.



Lamination disc

Reference number 5R2

The 5R2 lamination disc is laminated into the prosthetic socket. It serves to connect the prosthetic socket to a socket adapter.



Technical data

Article number	Material	System height	Build height	Weight	Max. body weight
5R2	Aluminium	9 mm	9 mm	70 g	150 kg

- The enclosed 4X86 lamination dummy is to be used for laminating.

Information material

647G179=ALL_INT IFU 5R2

Scope of delivery

5R2	Lamination disc	1	Piece
501S41=M6X12	Countersunk head screw (Allen screw)	4	Piece
501S41=M6X16	Countersunk head screw (Allen screw)	4	Piece
501S74=3.5X9.5	Sheet metal screw	6	Piece
4X86	Lamination dummy	1	Piece



Socket attachment

Reference number 5R2=C

The 5R2=C socket attachment made of carbon can be integrated into the prosthetic socket using prepreg technology. It serves to connect the prosthetic socket to a socket adapter.



Max. 150 kg

Technical data

Article number	Material	System height	Build height	Weight	Max. body weight
5R2=C	Carbon	10 mm	10 mm	50 g	150 kg

Information material

647G821=ALL_INT IFU 5R2=C

Scope of delivery

5R2=C	Socket attachment	1	Piece
501S41=M6X12	Countersunk head screw (Allen screw)	4	Piece
501S41=M6X16	Countersunk head screw (Allen screw)	4	Piece
4X301	Lamination dummy	1	Piece

- The enclosed 4X301 lamination dummy is to be used for laminating.
- 616B10=5 carbon fibre woven prepreg is particularly suitable for fabricating a thin-walled, high-strength and lightweight socket.



Socket attachment block for thermoplastic socket

Reference number 5R6

The 5R6 socket attachment block serves to provide a detachable connection for self-supporting sockets with a socket adapter. It is available in three sizes for various residual limb circumferences.



Max. 100 kg



Information material

647G1623=ALL_INT IFU 5R6

Scope of delivery

5R6	Socket attachment block for thermoplastic socket	1	Piece
501S41=M6X30	Countersunk head screw (Allen screw)	4	Piece

Technical data

Article image			
Article number	5R6=1	5R6=2	5R6=3
Material	Aluminium	Aluminium	Aluminium
Residual limb end circumference	~400 mm	~320 mm	~250 mm
System height	4 mm	4 mm	4 mm
Build height	4 mm	4 mm	4 mm
Weight	160 g	135 g	115 g
Max. body weight	100 kg	100 kg	100 kg

- Use the 5Y14 tool to create the proper distal shape. It must be ordered separately.

Adapters

Socket attachment blocks

Accessories/spare parts for socket attachment blocks



Tool

Reference number 5Y14

The 5Y14 tool makes it easier to create the proper distal shape. It is available in three sizes corresponding to the 5R6 socket attachment block.

Technical data

Article number	for
5Y14=1	5R6=1
5Y14=2	5R6=2
5Y14=3	5R6=3



Countersunk head screw (Allen screw)

Reference number 501S41

Technical data

Article number	Length	Spare part for
501S41=M6X12	12 mm	5R2
501S41=M6X16	16 mm	5R2
501S41=M6X25	25 mm	5R1
501S41=M6X30	30 mm	5R6



Sheet metal screw

Reference number 501S74

Technical data

Article number	Spare part for
501S74=3.5X9.5	5R2



Modular transtibial kit

Reference number 2R120

The modular transtibial kit consists of the 4R52 tube clamp adapter and 2R37 tube adapter.



Max. 100 kg

Technical data

Article number	Diameter	Material	Max. body weight
2R120	30 mm	Titanium	100 kg

- Technical data and information regarding the individual components of the kit can be found under the respective components.

Information material

647G903=ALL_INT	IFU Tube clamp adapters
647G902=ALL_INT	IFU Tube adapters

Scope of delivery

4R52	Tube clamp adapter	1 Piece
2R37	Tube adapter	1 Piece



Modular transtibial kit

Reference number 2R121

The modular transtibial kit consists of the 4R100 lamination anchor with pyramid, 4R52 tube clamp adapter and 2R37 tube adapter.

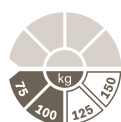

Max. 100 kg

Technical data

Article number	Diameter	Material	Max. body weight
2R121	30 mm	Titanium	100 kg

- Technical data and information regarding the individual components in the kit can be found under the respective components.

Information material

647G1627=ALL_INT	IFU 4R63 4R68 4R100
647G903=ALL_INT	IFU Tube clamp adapters
647G902=ALL_INT	IFU Tube adapters

Scope of delivery

4R100	Lamination anchor with pyramid adapter	1 Piece
4R52	Tube clamp adapter	1 Piece
2R37	Tube adapter	1 Piece

Adapters

Modular adapter kits

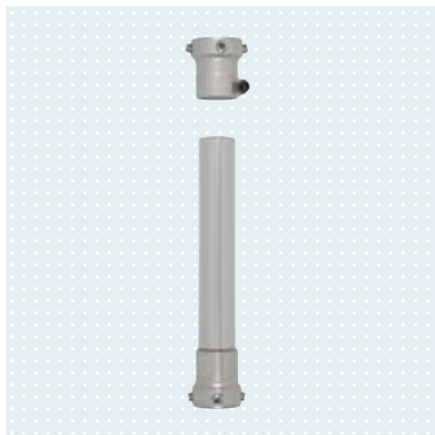

Modular transtibial kit

Reference number 2R105

The modular transtibial kit consists of the 4R69 tube clamp adapter and 2R50 tube adapter.



Max. 125 kg

Technical data

Article number	Diameter	Material	Max. body weight
2R105	30 mm	Aluminium	125 kg

- Technical data and information regarding the individual components in the kit can be found under the respective components.

Information material

647G903=ALL_INT	IFU Tube clamp adapters
647G902=ALL_INT	IFU Tube adapters

Scope of delivery

4R69	Tube clamp adapter	1 Piece
2R50	Tube adapter	1 Piece



Modular transtibial kit

Reference number 2R122

The modular transtibial kit consists of the 4R68 lamination anchor with pyramid, 4R69 tube clamp adapter and 2R50 tube adapter.



Max. 100 kg

Technical data

Article number	Diameter	Material	Max. body weight
2R122	30 mm	Aluminium	100 kg

- Technical data and information regarding the individual components in the kit can be found under the respective components.

Information material

647G1627=ALL_INT	IFU 4R63 4R68 4R100
647G903=ALL_INT	IFU Tube clamp adapters
647G902=ALL_INT	IFU Tube adapters

Scope of delivery

4R68	Lamination anchor with pyramid adapter	1 Piece
4R69	Tube clamp adapter	1 Piece
2R50	Tube adapter	1 Piece



Modular transtibial kit

Reference number 2R123

The modular transtibial kit consists of the 4R21 tube clamp adapter and 2R2 tube adapter.



Max. 100 kg

Technical data

Article number	Diameter	Material	Max. body weight
2R123	30 mm	Stainless steel	100 kg

- Technical data and information regarding the individual components in the kit can be found under the respective components.

Information material

647G903=ALL_INT	IFU Tube clamp adapters
647G902=ALL_INT	IFU Tube adapters

Scope of delivery

4R21	Tube clamp adapter	1 Piece
2R2	Tube adapter	1 Piece



Modular transtibial kit

Reference number 2R124

The modular transtibial kit consists of the 4R63 lamination anchor with pyramid, 4R21 tube clamp adapter and 2R2 tube adapter.



Max. 100 kg

Technical data

Article number	Diameter	Material	Max. body weight
2R124	30 mm	Stainless steel	100 kg

- Technical data and information regarding the individual components in the kit can be found under the respective components.

Information material

647G1627=ALL_INT	IFU 4R63 4R68 4R100
647G903=ALL_INT	IFU Tube clamp adapters
647G902=ALL_INT	IFU Tube adapters

Scope of delivery

4R63	Lamination anchor with pyramid	1 Piece
4R21	Tube clamp adapter	1 Piece
2R2	Tube adapter	1 Piece

Adapters

Modular adapter kits

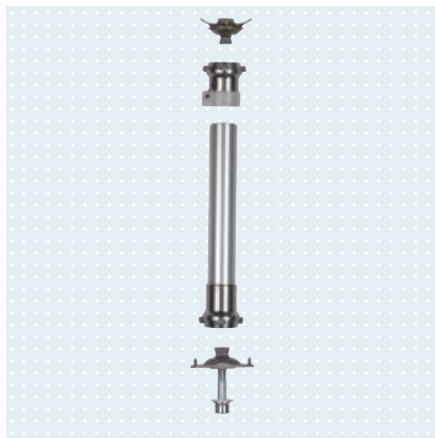

Modular transtibial kit

Reference number 2R125

The modular transtibial kit consists of the 4R63 lamination anchor with pyramid, 4R21 tube clamp adapter, 2R2 tube adapter and 2R8 SACH* foot adapter with threaded connection.



Information material

647G1627=ALL_INT	IFU 4R63 4R68 4R100
647G903=ALL_INT	IFU Tube clamp adapters
647G902=ALL_INT	IFU Tube adapters
647G5=ALL_INT	IFU 2R8 2R31 2R54

Scope of delivery

4R63	Lamination anchor with pyramid	1	Piece
4R21	Tube clamp adapter	1	Piece
2R2	Tube adapter	1	Piece
2R8	Foot adapter with screw connection, steel	1	Piece

Technical data

Article number	Diameter	Material	Max. body weight
2R125=M8	30 mm	Stainless steel	100 kg
2R125=M10	30 mm	Stainless steel	100 kg

- Technical data and information regarding the individual components in the kit can be found under the respective components.



Modular transtibial kit

Reference number 2R102

The modular transtibial kit consists of the 4R82 tube clamp adapter and 2R57 tube adapter.



Information material

647G903=ALL_INT	IFU Tube clamp adapters
647G902=ALL_INT	IFU Tube adapters

Scope of delivery

4R82	Tube clamp adapter	1	Piece
2R57	Tube adapter	1	Piece

Technical data

Article number	Diameter	Material	Max. body weight
2R102	34 mm	Titanium	150 kg

- Technical data and information regarding the individual components in the kit can be found under the respective components.

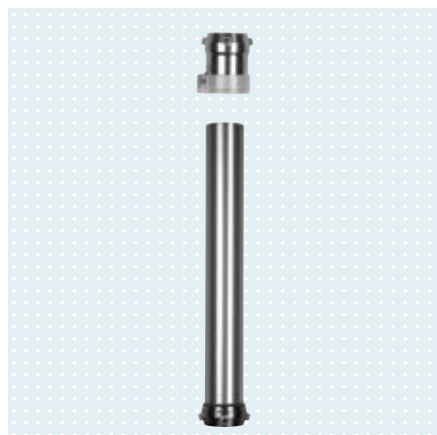

Modular transtibial kit

Reference number 2R103

The modular transtibial kit consists of the 4R91 tube clamp adapter and 2R76 tube adapter.



Max. 150 kg

Technical data

Article number	Diameter	Material	Max. body weight
2R103	34 mm	Stainless steel	150 kg

- Technical data and information regarding the individual components in the kit can be found under the respective components.

Information material

647G903=ALL_INT	IFU Tube clamp adapters
647G902=ALL_INT	IFU Tube adapters

Scope of delivery

4R91	Tube clamp adapter	1 Piece
2R76	Tube adapter	1 Piece



Modular transfemoral kit

Reference number 4R201

The modular transfemoral kit consists of the 4R37 socket adapter with pyramid receiver, 3R40 modular lightweight knee joint and 2R49 tube adapter.



Max. 100 kg

Technical data

Article number	Mobility grade	Diameter	Material	Max. body weight
4R201	1	30 mm	Aluminium, Stainless steel	100 kg

- Technical data and information regarding the individual components in the kit can be found under the respective components.

Information material

647G1626=ALL_INT	IFU Socket adapters
647G82=ALL_INT	IFU 3R40
647G902=ALL_INT	IFU Tube adapters

Scope of delivery

4R37	Socket adapter with pyramid receiver, rotatable	1 Piece
3R40	Lightweight knee joint, monocentric, with lock	1 Piece
2R49	Tube adapter	1 Piece

Adapters

Functional adapters



Quickchange

Reference number 4R10

With the 4R10=111 Quickchange adapter, amputees can release their prosthetic foot by themselves when needed, in just one step. This makes it easier to dress and undress, and makes sitting more comfortable. Various feet that can be independently changed by the user can also be provided for one prosthesis.

Key features

- Easy removal of the foot, making it easier to put on clothing in daily life or for more comfortable sitting.
- Prosthesis wearers can use feet with different functions.
- The prosthetic alignment is not altered by using the Quickchange. The adapter is mounted like a normal structural component.
- Conducting trial fittings to test various prosthetic feet is especially simple.
- The locking bolt ensures a secure hold until the next foot change.
- Prosthesis wearers can handle the Quickchange on their own, with no tools required.

Information material

647G1248=ALL_INT IFU Quickchange

Scope of delivery

4R10	Quickchange	1	Piece
4R10=01	Quickchange lower section	1	Piece



Max. 125 kg

Technical data

Article number	4R10=111
Mobility grade	2, 3, 4
Material	Aluminium, Plastic
Proximal connection	Pyramid
Distal connection	Four-hole connection
Min. system height	12 mm
Max. system height	15 mm
Min. build height	30 mm
Weight	235 g
Max. body weight	125 kg

- The maximum allowable body weight can deviate for combinations with certain prosthetic feet. See the instructions for use for information on the maximum allowable body weight.
- The product may only be used in transtibial prostheses or positioned below the prosthetic knee joint in transfemoral prostheses.

Accessories/spare parts for 4R10



Quickchange lower section

Reference number 4R10=01

An additional 4R10=01 Quickchange lower part allows the change with additional prosthetic feet.

Technical data

Article number	Material	Weight	Max. body weight
4R10=01	Aluminium, Plastic	130 g	125 kg



Quickchange locking bolt

Reference number 4X345

The 4X345 locking bolt ensures a secure hold until the next time the prosthetic foot is unscrewed.

Technical data

Article number
4X345

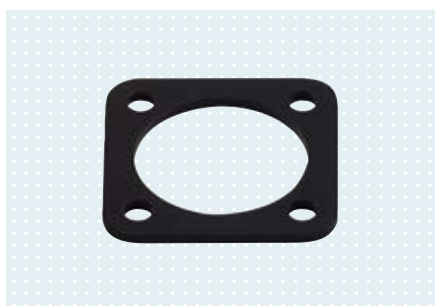

3 mm spacer plate

Reference number 4G791

Technical data

Article number
4G791



Countersunk head screw

Reference number XEKT2137

Technical data

Article number
XEKT2137

Adapters

Functional adapters



Rotation adapter

Reference number 4R57

Incorporating the rotation adapter above the knee joint makes it possible to rotate the lower leg relative to the socket with the knee flexed. This considerably enhances safety and comfort for the amputee. The adapter's rotating mechanism is activated by pressing the release button and locks automatically.

Key features

- **Enhanced safety:** the prosthesis can be swung to the side while driving. This minimises the risk of the prosthetic foot becoming stuck in the area of the pedals. In addition, this function allows the amputee to sit with the leg in a more relaxed position, improving their focus on road traffic.
- **Enhanced comfort:** the rotation adapter makes everyday activities easier, such as putting on shoes without strain on the back, and allows the user to sit comfortably. The sitting position can be varied up to sitting cross-legged.
- The thread of the 4R57=ST enables the space-saving installation of the adapter, since it can for instance be screwed into the 4R111=N and 4R43 lamination anchors.

Information material

647G258=ALL_INT

IFU 4R57 4R57=ST



Max. 150 kg

Technical data

Article image



Article number	4R57	4R57=ST
Mobility grade	1, 2, 3, 4	1, 2, 3, 4
Material	Steel, stainless	Steel, stainless
Proximal connection	Pyramid	Thread
Distal connection	Pyramid receiver	Pyramid receiver
System height	22 mm	42 mm
Build height	22 mm	24 mm
Weight	170 g	185 g
Rotation	max. 360° (without foam cover)	max. 360° (without foam cover)
Max. body weight	150 kg	150 kg

- In order to properly screw the 4R57=ST into the lamination anchor, the 4X46=ST lamination dummy must be used for laminating. It must be ordered separately.
- The 4R57 cannot be combined with the 2R49, 2R50, 4R95 and 4R98 because the connectors have different dimensions.

Accessories/spare parts for 4R57



Lamination dummy

Reference number 4X46

Technical data

Article number	for
4X46=ST	4R57=ST/4R57=ST-WR



Release button cover

Reference number 4X69

Technical data

Article number	Colour
4X69=1	Grey
4X69=7	Black



Set screw

Reference number 506G3

The 506G3 set screws are intended for adapters with a pyramid receiver. They are available in various lengths. Set screws that are protruding or recessed too much should be replaced with appropriate ones.

Technical data

Article number	Length
506G3=M8X10	10 mm
506G3=M8X12-V	12 mm
506G3=M8X14	14 mm
506G3=M8X16	16 mm

Adapters

Functional adapters



Rotation adapter

Reference number 4R57=WR

Incorporating the rotation adapter above the knee joint makes it possible to rotate the lower leg relative to the socket with the knee flexed. This considerably enhances safety and comfort for the amputee. The adapter's rotating mechanism is activated by pressing the release button and locks automatically.

Key features

- Waterproof and corrosion-resistant (fresh, salt and chlorinated water) and therefore particularly well suited for combination with the Genium X3, 3R80 and 3WR95
- Enhanced safety: the prosthesis can be swung to the side while driving. This minimises the risk of the prosthetic foot becoming stuck in the area of the pedals. In addition, this function allows the amputee to sit with the leg in a more relaxed position, improving their focus on road traffic.
- Enhanced comfort: the rotation adapter makes everyday activities easier, such as putting on shoes without strain on the back, and allows the user to sit comfortably. The sitting position can be varied up to sitting cross-legged.
- The thread of the 4R57=WR-ST enables the space-saving installation of the adapter, since it can for instance be screwed into the 4R111=T lamination anchor.

Information material

647G1303=ALL_INT IFU 4R57=WR
4R57=WR-ST



Max. 166 kg

Technical data

Article image



Article number	4R57=WR	4R57=WR-ST
Mobility grade	1, 2, 3, 4	1, 2, 3, 4
Material	Steel	Steel
Proximal connection	Pyramid	Thread
Distal connection	Pyramid receiver	Pyramid receiver
System height	25 mm	47 mm
Build height	25 mm	29 mm
Weight	214 g	253 g
Rotation	Max. 360°	Max. 360°
Max. body weight	166 kg	166 kg

- In order to properly screw the 4R57=WR-ST into the lamination anchor, the 4X46=ST lamination dummy must be used for laminating. It must be ordered separately.
- The 4R57=WR cannot be combined with the 2R49, 2R50, 4R69, 4R95 and 4R98 because the connectors have different dimensions.

Accessories/spare parts for 4R57=WR



Lamination dummy

Reference number 4X46

Technical data

Article number	for
4X46=ST	4R57=ST/4R57=ST-WR



Protective cap

Reference number 4Y492

Technical data

Article number
4Y492



Set screw

Reference number 506G3

The 506G3 set screws are intended for adapters with a pyramid receiver. They are available in various lengths. Set screws that are protruding or recessed too much should be replaced with appropriate ones.

Technical data

Article number	Length
506G3=M8X12-ZNNI	12 mm
506G3=M8X16 ZN	16 mm

Adapters

Functional adapters



Torsion adapter with tube clamp

Reference number 4R85

The 4R85 torsion adapter minimises shear forces that occur between the residual limb and socket while walking, thereby improving wearing comfort. Individually adjustable torsion of max. 20° in any direction helps reduce compensating movements during tight turns in confined spaces, thereby counteracting the development of secondary damage.



Max. 100 kg

Information material

647G23=ALL_INT IFU Torsion adapters

Technical data

Article number	4R85
Mobility grade	1, 2, 3, 4
Diameter	30 mm
Material	Steel, nickel-plated Stainless steel
Proximal connection	Pyramid receiver
Distal connection	Tube clamp
System height	68 mm
Build height	84 mm
Weight	350 g
Rotation angle limitation by stops	+/- 20°
Max. body weight	100 kg

- When the 4R85 is used with the 3R15 and 3R49 knee joints with friction brake, the longer extension assist pulley included with the torsion adapter must be installed.



Torsion adapter with tube clamp

Reference number 4R86

The 4R86 torsion adapter minimises shear forces that occur between the residual limb and socket while walking, thereby improving wearing comfort. Individually adjustable torsion of max. 20° in any direction helps reduce compensating movements during tight turns in confined spaces, thereby counteracting the development of secondary damage.



Max. 110 kg

Information material

647G23=ALL_INT IFU Torsion adapters

Technical data

Article number	4R86
Mobility grade	1, 2, 3, 4
Diameter	34 mm
Material	Steel, nickel-plated Titanium
Proximal connection	Pyramid receiver
Distal connection	Tube clamp
System height	68 mm
Build height	93 mm
Weight	340 g
Rotation angle limitation by stops	+/- 20°
Max. body weight	110 kg



Torsion adapter with 4-hole connection

Reference number 4R40

The 4R40 torsion adapter minimises shear forces that occur between the residual limb and socket while walking, thereby improving wearing comfort. Individually adjustable torsion of max. 20° in any direction helps reduce compensating movements during tight turns in confined spaces, thereby counteracting the development of secondary damage.



Max. 125 kg

Information material

647G23=ALL_INT IFU Torsion adapters

Technical data

Article number	4R40
Mobility grade	1, 2, 3, 4
Material	Steel, nickel-plated Steel
Proximal connection	4-hole-connection
Distal connection	Pyramid receiver
System height	58 mm
Build height	40 mm
Weight	340 g
Rotation angle limitation by stops	+/- 20°
Max. body weight	125 kg

Adapters

Functional adapters



Torsion adapter with tube

Reference number 4R39

The 4R39 torsion adapter minimises shear forces that occur between the residual limb and socket while walking, thereby improving wearing comfort. Individually adjustable torsion of max. 20° in any direction helps reduce compensating movements during tight turns in confined spaces, thereby counteracting the development of secondary damage.



Max. 125 kg

Information material

647G23=ALL_INT IFU Torsion adapters

Technical data

Article number	4R39
Mobility grade	1, 2, 3, 4
Diameter	30 mm
Material	Steel, nickel-plated Aluminium
Proximal connection	Tube
Distal connection	Pyramid receiver
Min. system height	113 mm
Max. system height	476 mm
Min. build height	62 mm
Overall length	455 mm
Weight	500 g
Rotation angle limitation by stops	+/- 20°
Max. body weight	125 kg



Torsion adapter with tube

Reference number 2R67

The 2R67 torsion adapter minimises shear forces that occur between the residual limb and socket while walking, thereby improving wearing comfort. Individually adjustable torsion of max. 20° in any direction helps reduce compensating movements during tight turns in confined spaces, thereby counteracting the development of secondary damage.



Max. 125 kg

Information material

647G23=ALL_INT

IFU Torsion adapters

Technical data

Article number	2R67
Diameter	34 mm
Material	Steel, nickel-plated Titanium Aluminium
Proximal connection	Tube
Distal connection	Pyramid receiver
Min. system height	117 mm
Max. system height	322 mm
Min. build height	66 mm
Overall length	304 mm
Weight	520 g
Rotation angle limitation by stops	+/- 20°
Max. body weight	125 kg

Adapters

Functional adapters

Accessories/spare parts for torsion adapters

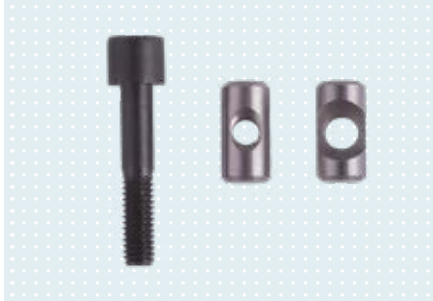

Single component pack

Reference number 4D4

Technical data

Article number	Spare part for
4D4	4R85
	4R86

Scope of delivery

501Z2	Cap screw (Allen screw)	1	Piece
506A17=1	Cylinder pin	1	Piece
506A17=2	Cylinder pin	1	Piece



Set screw

Reference number 506G3

The 506G3 set screws are intended for adapters with a pyramid receiver. They are available in various lengths. Set screws that are protruding or recessed too much should be replaced with appropriate ones.

Technical data

Article number	Length
506G3=M8X12-V	12 mm
506G3=M8X14	14 mm
506G3=M8X16	16 mm



DeltaTwist

Reference number 4R120/4R121

The DeltaTwist is able to compensate for the loss of important proprioceptors and muscle groups to a certain extent. It provides safety, mobility and comfort with its torsion function and by absorbing shocks.

Key features

- **Function:** The DeltaTwist is a shock absorber and torsion adapter in one. A more symmetrical gait pattern can be achieved with its integration into the prosthesis. Instabilities can be eliminated, and compensating movements are reduced. It relieves the locomotor system and residual limb socket
- **Pistoning in the axial direction:** up to 8 mm
- **Rotation around the longitudinal axis:** up to 20° interior and exterior rotation
- **Adjustability:** both shock absorption and torsion can be adjusted individually and independently by means of various elastomer elements
- **For transtibial and transfemoral prostheses**

Information material

647G1601=ALL_INT IFU Delta Twist

Scope of delivery

Reference number	Description	Quantity	Unit
4R120/4R121	DeltaTwist	1	Piece
709H5=1	Elastomer plate, hardness: soft	1	Piece
709H5=2	Elastomer plate, hardness: medium	1	Piece
709H5=3	Elastomer plate, hardness: hard	1	Piece
709H6=1	Elastomer bar, hardness: soft	1	Piece
709H6=2	Elastomer bar, hardness: medium	1	Piece
709H6=3	Elastomer bar, hardness: hard	1	Piece
709H4	Combination wrench	1	Piece
633F30	Special grease	1	Tube

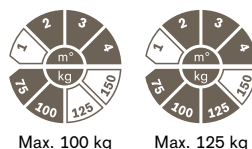

Technical data

Article image



Article number	4R120	4R121=30	4R121=34
Mobility grade	2, 3, 4	2, 3, 4	2, 3, 4
Diameter	30 mm	30 mm	34 mm
Material	Aluminium	Aluminium	Aluminium
Proximal connection	Tube clamp	Tube	Tube
Distal connection	Pyramid receiver	Adjustment screw	Pyramid receiver
System height	117 mm	-	-
Min. system height	-	117 mm	218 mm
Max. system height	-	553 mm	578 mm
Build height	138 mm	-	-
Min. build height	-	130 mm	130 mm
Overall length	-	535 mm	558 mm
Weight	~ 340 g	~ 530* g	~ 585* g
Max. inner torsion	20 °	20 °	20 °
Max. outer torsion	20 °	20 °	20 °
Max. dampening	~ 8 mm	~ 8 mm	~ 8 mm
Max. body weight	100 kg	100 kg	125 kg

- After maximum shortening, the weight of the 4R121=30 is 325 g and the weight of the 4R121=34 is 355 g.
- Elastomer rods and plates in the various degrees of hardness as well as special grease and combination spanners are included in the scope of delivery.

Adapters

Functional adapters

Accessories/spare parts for 4R120/4R121



Socket nut, 1/2" hexagon SW11

Reference number 709H7

The socket nut is a single component for socket wrenches.

Technical data

Article number

709H7

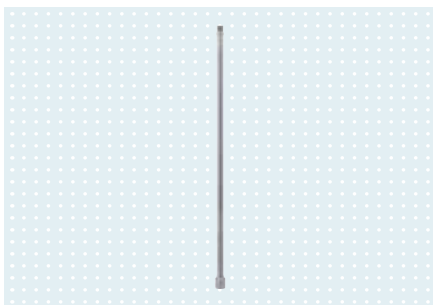

Socket extension, 1/2"

Reference number 709H8

The socket extension is a single component for socket wrenches.

Technical data

Article number

709H8

Length

575 mm

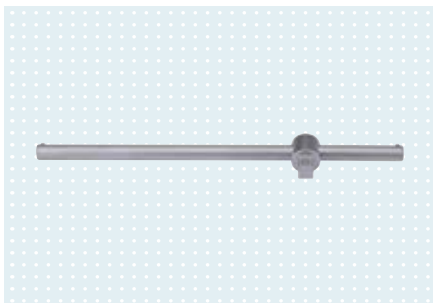

T-handle, 1/2"

Reference number 709H9

The T-handle is a single component for socket wrenches.

Technical data

Article number

709H9



Special grease

Reference number 633F30

The special grease is used for lubricating plastic, to reduce friction and protect against wear and tear.

Technical data

Article number

633F30



Combination wrench

Reference number 709H4

The combination wrench is used to replace the elastomer plates in the DeltaTwist.

Technical data

Article number

709H4

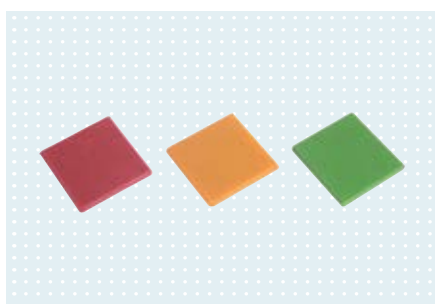

Elastomer plate

Reference number 709H5

The exchangeable elastomer elements (plates and rods of varying degrees of hardness) and the continuously variable pretension enable individual adjustment of the DeltaTwist's spring and damping characteristics.

Technical data

Article number	Hardness	Colour
709H5=1	soft	Red
709H5=2	medium	Yellow
709H5=3	hard	Green



Rotation locking plate, extra hard

Reference number 709H5

The 709H5=4 rotation lock segment is used to suppress the torsion function. It has to be ordered separately.

Technical data

Article number	Hardness	Colour
709H5=4	extra hard	Black

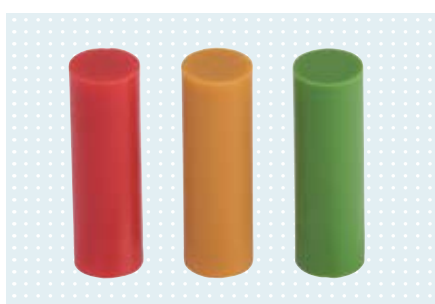

Elastomer rod

Reference number 709H6

The exchangeable elastomer elements (plates and rods of varying degrees of hardness) and the continuously variable pretension enable individual adjustment of the DeltaTwist's spring and damping characteristics.

Technical data

Article number	Hardness	Colour
709H6=1	soft	Red
709H6=2	medium	Yellow
709H6=3	hard	Green



Knee joints



	MOBIS				Max. body weight				Joint structure		Stance phase safety through alignment and:			Swing phase control				
	1	2	3	4	≤ 75 kg	≤ 100 kg	≤ 125 kg	≤ 150 kg	monocentric	polycentric	lock	brake	polycentric	characteristics	mechanics	pneumatics	hydraulics	
TF	3R31/=ST	•				•	•	•		•				sitting assist				
	3R40	•				•	•			•								
	3R41	•				•	•			•								
	3R33/3R17	•				•	•	•	•	•					•			
	3R62/=ST	•	•			•	•	•		•			•	EBS	•			
	3R62=1/-ST	•	•			•	•	•		•			•	EBS	•			
	3R49/3R15	•	•			•	•			•		•			•			
	3R36/3R20	•	•			•	•			•			•		•			
	3R93	•	•			•	•	•		•		•			•			
	3R90	•	•			•	•	•		•		•			•			
	3R92		•	•		•	•	•		•		•				•		
	3R106/=ST		•	•		•	•			•			•			•		
	3R106-PRO/=ST		•	•		•	•	•		•				servopneumatics		•		
	3R60/=ST		•	•		•	•	•		•			•	EBS			•	
	3R60-PRO/=ST		•	•		•	•			•			•	progressive EBS			•	
	3R78/=ST		•	•		•	•			•			•			•		
	3R80/=ST			•	•	•	•			•		•		rotary hydraulics			rotary hydraulics	
	3R55			•	•	•	•			•			•				•	
	3R95			•	•	•	•	•	•	•								•
	3C60/=ST	•	•			•	•	•		•				hydraulics + electronics				electronically controlled
3C98-3/3C88-3		•	•	•	•	•	•	•	•				hydraulics + electronics				electronically controlled	
3B1-3/=ST		•	•	•	•	•	•	•	•				hydraulics + electronics				electronically controlled	
3B5-3/=ST			•	•	•	•			•				hydraulics + electronics				electronically controlled	
KD	3R32/3R23	•				•	•	•		•		•						
	3R30/3R21	•				•	•	•		•		•			•			
	3R62=KD	•	•			•	•	•		•			•	EBS	•			
	3R62=1-KD	•	•			•	•	•		•			•	EBS	•			
	3R78=KD		•	•		•	•			•			•			•		
	3R106=KD		•	•		•	•			•			•			•		
	3R106-PRO=KD		•	•		•	•	•		•			•	servopneumatics		•		
	3R60=KD		•	•		•	•	•		•			•	EBS			•	
	3R60-PRO=KD		•	•		•	•			•			•	progressive EBS			•	
	3R46			•	•	•	•			•			•				•	
	3C60/=ST	•	•			•	•	•		•				hydraulics + electronics				electronically controlled
	3C98-3/3C88-3		•	•	•	•	•	•	•	•				hydraulics + electronics				electronically controlled
	3B1-3/=ST		•	•	•	•	•	•	•	•				hydraulics + electronics				electronically controlled
3B5-3=ST			•	•	•	•			•				hydraulics + electronics				electronically controlled	
HD	3R36/3R20	•				•	•			•			•		•			
	3R60=HD		•	•		•	•	•		•			•	EBS			•	
	3R60-PRO=HD		•	•		•	•			•			•	progressive EBS			•	
	3C98-3/3C88-3		•	•	•	•	•	•	•	•				hydraulics + electronics				electronically controlled
	3B1-3/=ST		•	•	•	•	•	•	•	•				hydraulics + electronics				electronically controlled
	3B5-3/=ST			•	•	•	•			•				hydraulics + electronics				electronically controlled



Locking knee joint, monocentric, with lock

Reference number 3R41

The 3R41 is based on cutting-edge plastics technology and is suitable for users with a high need for safety. It is moisture-resistant, lightweight and especially low-wearing. You also benefit from the easy handling of the innovative release mechanism, which can even be operated under partial load.



Max. 125 kg

Information material

647G340=ALL_INT IFU 3R41

Scope of delivery

3R41		1	Piece
4F18	Lock slide	1	Piece

Technical data

Article number	3R41
Max. body weight	125 kg
Mobility grade	1
Weight	385 g
Proximal connection	Pyramid
Distal connection	Tube clamp Ø 30 mm
Knee flexion angle	150 °
System height	24 mm
Proximal system height to alignment reference point	12 mm
Distal system height to alignment reference point	12 mm
Build height	100 mm
Proximal build height to alignment reference point	30 mm
Distal build height to alignment reference point	70 mm

Knee joints

Mobility grade 1



Lightweight knee joint, monocentric, with lock

Reference number 3R40

The upper joint section with pyramid and lower joint section with tube clamp are made of a light metal alloy and connected by an axis. The adjustable lock in the lower joint section secures the joint in the extended position. Flexion is enabled using the lock cable.



Max. 100 kg

Information material

647G82=ALL_INT IFU 3R40

Scope of delivery

3R40	1 Piece
4F17 Lock slide	1 Piece

Technical data

Article number	3R40
Max. body weight	100 kg
Mobility grade	1
Weight	290 g
Proximal connection	Pyramid
Distal connection	Tube clamp Ø 30 mm
Knee flexion angle	155 °
System height	23 mm
Proximal system height to alignment reference point	1 mm
Distal system height to alignment reference point	22 mm
Build height	74 mm
Proximal build height to alignment reference point	19 mm
Distal build height to alignment reference point	55 mm
Material	Aluminium

Accessories/spare parts for 3R40



Single component pack

Reference number 4D16

The single component pack consists of spare parts for the 3R40 modular lightweight knee joint.

Technical data

Article number	for
4D16	3R40

Components

Plastic knee cap	1 Piece
Set screw	2 Piece
Lock bale with cable guide	1 Piece
Perlon cable	5 Piece
Threaded sleeve	1 Piece
Suspension rosette	1 Piece
Plastic ring	1 Piece
Bumper	2 Piece
Pad screw head	1 Piece
Lamination disk, serrated	1 Piece
Lock slide	1 Piece



Knee joint for disarticulation, polycentric, with lock

Reference number 3R32

As with the 3R23, the upper joint section of the 3R32 with coupling unit and the lower joint section with pyramid are connected to one another by linkage bars. The detachable lamination anchor connects the knee to the prosthetic socket. The adjustable lock secures the knee in extension. Flexion is enabled using the lock cable.



Max. 125 kg

Information material

647G1634=ALL_INT IFU 3R23 3R32

Scope of delivery

3R32		1	Piece
4G70	Lamination anchor	1	Piece

Technical data

Article number	3R32
Max. body weight	125 kg
Mobility grade	1
Weight	655 g
Proximal connection	Lamination anchor
Distal connection	Pyramid
Knee flexion angle	110 °
System height	99 mm
Proximal system height to alignment reference point	17 mm
Distal system height to alignment reference point	82 mm
Build height	117 mm
Proximal build height to alignment reference point	17 mm
Distal build height to alignment reference point	100 mm
Material	Titanium

Knee joints

Mobility grade 1



Knee joint for disarticulation, polycentric, with lock

Reference number 3R23

As with the 3R32, the upper joint section of the 3R23 with coupling unit and the lower joint section with pyramid are connected to one another by linkage bars. The detachable lamination anchor connects the knee to the prosthetic socket. The adjustable lock secures the knee in extension. Flexion is enabled using the lock cable.



Max. 125 kg

Information material

647G1634=ALL_INT IFU 3R23 3R32

Scope of delivery

3R23		1	Piece
4G70	Lamination anchor	1	Piece

Technical data

Article number	3R23
Max. body weight	125 kg
Mobility grade	1
Weight	880 g
Proximal connection	Lamination anchor
Distal connection	Pyramid
Knee flexion angle	110 °
System height	99 mm
Proximal system height to alignment reference point	17 mm
Distal system height to alignment reference point	82 mm
Build height	117 mm
Proximal build height to alignment reference point	17 mm
Distal build height to alignment reference point	100 mm
Material	Stainless steel

Accessories/spare parts for 3R32,3R23



Single component pack

Reference number 4D9

The single component pack consists of spare parts for the 3R32 and 3R23 modular knee joints.

Technical data

Article number	Spare part for
4D9	3R23 3R32

Components

Slotted bushing	4	Piece
Bevel washer	4	Piece
Lock nut	2	Piece
Retaining ring DIN 471	2	Piece
Grub screw	3	Piece
Knee stop	2	Piece
Cap screw	4	Piece
Two hole joint nut	4	Piece



Lamination anchor

Reference number 4G70

The lamination anchor serves as the proximal connection for modular knee joints. It is suitable only for use with prosthetic knee joints for knee disarticulations.

Technical data

Article number	Material	Max. body weight
4G70	Stainless steel	125 kg

Knee joints

Mobility grade 1



Knee joint, monocentric, with lock and extension assist

Reference number 3R33

The upper and lower joint sections of the 3R33 are connected through the knee axes by the bushings and ball bearings. The adjustable lock secures the joint in the extended position. Flexion is enabled using the lock cable. Locking of the 3R33 occurs automatically with assistance from the extension assist spring.



Max. 125 kg

Information material

647G34=ALL_INT IFU 3R17 3R33

Scope of delivery

3R33		1	Piece
4F17	Lock slide	1	Piece

Technical data

Article number	3R33
Max. body weight	125 kg
Mobility grade	1
Weight	530 g
Proximal connection	Pyramid
Distal connection	Pyramid
Knee flexion angle	120 °
System height	43 mm
Proximal system height to alignment reference point	6 mm
Distal system height to alignment reference point	37 mm
Build height	79 mm
Proximal build height to alignment reference point	24 mm
Distal build height to alignment reference point	55 mm
Material	Titanium



Knee joint, monocentric, with lock and extension assist

Reference number 3R17

The upper and lower joint sections of the 3R17 are connected through the knee axes by the bushings and ball bearings. The adjustable lock secures the joint in the extended position. Flexion is enabled using the lock cable. Locking of the 3R17 occurs automatically with assistance from the extension assist spring.



Max. 150 kg

Information material

647G34=ALL_INT IFU 3R17 3R33

Scope of delivery

3R17		1	Piece
4F17	Lock slide	1	Piece

Technical data

Article number	3R17
Max. body weight	150 kg
Mobility grade	1
Weight	695 g
Proximal connection	Pyramid
Distal connection	Pyramid
Knee flexion angle	120 °
System height	43 mm
Proximal system height to alignment reference point	6 mm
Distal system height to alignment reference point	37 mm
Build height	79 mm
Proximal build height to alignment reference point	24 mm
Distal build height to alignment reference point	55 mm
Material	Stainless steel

Knee joints

Mobility grade 1

Accessories/spare parts for 3R33, 3R17



Single component pack

Reference number 4D10

The single component pack consists of spare parts for the 3R17 and 3R33 modular knee joints.

Technical data

Article number	Spare part for
4D10	3R17 3R33

Components

Plastic knee cap	1	Piece
Bushing	2	Piece
Spring guide housing	1	Piece
Compression spring	1	Piece
Compression spring	2	Piece
Set screw	1	Piece
Safety plate	1	Piece
Slotted oval countersunk head screw	1	Piece
Rubber bumper	1	Piece
Ball thrust bearing	2	Piece
Spring Guide Pin	2	Piece
Slotted oval head screw (lock screw)	2	Piece
Guide Pin	1	Piece

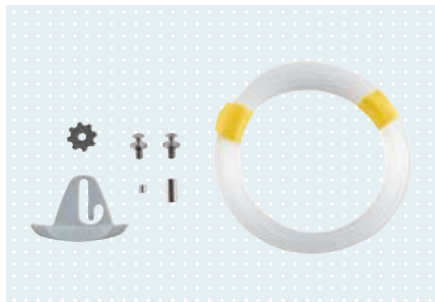

Single component pack

Reference number 4D11

The single component pack consists of spare parts for the factory-installed 4F18=N lock slide.

Technical data

Article number	Spare part for
4D11	3R17 3R33

Components

Lock slide	1	Piece
Threaded sleeve	1	Piece
Suspension rosette	1	Piece
Perlon cable	5	linear metres
Pad screw head	2	Piece
Lamination disk, serrated	1	Piece



Prosedo monocentric locking knee joint, with hydraulic sitting assist

Reference number 3R31

With the Prosedo, the hydraulic sitting assist can be individually adapted to the patient's needs and body weight.

Key features

- Once the lock is released, high flexion resistance supports users as they sit down
- The weight can also be shifted to the prosthetic leg
- The patient's balance while sitting down is improved
- Reduced strain on the sound side

Information material

647G989=ALL_INT IFU 3R31

Scope of delivery

3R31	Prosedo	1	Piece
2R49	Tube adapter	1	Piece
709S10	Allen key	1	Piece



Max. 125 kg

Technical data

Article image



Article number	3R31	3R31=ST
Max. body weight	125 kg	125 kg
Mobility grade	1	1
Weight	595 g	590 g
Proximal connection	Pyramid	Threaded connector
Distal connection	Tube clamp Ø 30 mm	Tube clamp Ø 30 mm
Knee flexion angle	145 °	145 °
System height	102 mm	115 mm
Proximal system height to alignment reference point	3 mm	16 mm
Distal system height to alignment reference point	99 mm	99 mm
Build height	168 mm	163 mm
Proximal build height to alignment reference point	21 mm	16 mm
Distal build height to alignment reference point	147 mm	147 mm

Knee joints

Mobility grade 1–2



Pheon polycentric knee joint, with mechanical swing phase control

Reference number 3R62

The polycentric knee joint with stance phase control and mechanical swing phase control is particularly suitable for users with low mobility. The Pheon provides targeted support for the post-amputation therapy process – from the initial standing and walking exercises with the interim prosthesis through to the final prosthesis.

Key features

- Integrated, optional lock can be permanently activated or deactivated by the O&P professional
- Innovative extension assist spring and a self-readjusting friction element to control the extension movement, ensuring a harmonious extension stop

Information material

647G876=ALL_INT Instructions for use for 3R62 Pheon

Scope of delivery

3R62	Pheon		1 Piece
2R49	Tube adapter		1 Piece
4G70	Lamination anchor	only with 3R62=KD	1 Piece
710H10	Adjustment wrench		1 Piece



45 to 75 kg



Max. 125 kg

Technical data

Article image



Article number	3R62/3R62=1	3R62=KD/3R62=1-KD	3R62=ST/3R62=1-ST
Max. body weight	125 / 75 kg	125 / 75 kg	125 / 75 kg
Mobility grade	1, 2	1, 2	1, 2
Weight	846 g	865 g	865 g
Proximal connection	Pyramid	Lamination anchor	Threaded connector
Distal connection	Tube clamp Ø 30 mm	Tube clamp Ø 30 mm	Tube clamp Ø 30 mm
Knee flexion angle	155 °	155 °	155 °
System height	142 mm	165 mm	160 mm
Proximal system height to alignment reference point	-3 mm	20 mm	15 mm
Distal system height to alignment reference point	145 mm	145 mm	145 mm
Build height	195 mm	200 mm	195 mm
Proximal build height to alignment reference point	15 mm	20 mm	15 mm
Distal build height to alignment reference point	180 mm	180 mm	180 mm
Material	Aluminium	Aluminium	Aluminium



reddot award 2015
winner



Knee joint with friction brake, monocentric, with extension assist and protective sleeve

Reference number 3R49

The axis clamp with swing axle and brake axle forms the connection between the upper joint section and lower joint section of the 3R49 and acts as a load-dependent brake. It secures the stance phase in combination with the posterior location. The axle friction and spring force of the extension assist spring can be adjusted to control the swing phase.



Max. 100 kg

Information material

647G1562=ALL_INT IFU 3R15 3R49

Scope of delivery

3R49		1	Piece
21Y70	Protective sleeve	1	Piece

Technical data

Article number	3R49
Max. body weight	100 kg
Mobility grade	1, 2
Weight	360 g
Proximal connection	Pyramid
Distal connection	Pyramid
Knee flexion angle	150 °
System height	9 mm
Proximal system height to alignment reference point	8 mm
Distal system height to alignment reference point	1 mm
Build height	45 mm
Proximal build height to alignment reference point	26 mm
Distal build height to alignment reference point	19 mm
Material	Titanium

Knee joints

Mobility grade 1–2



Knee joint with friction brake, with extension assist and protective sleeve

Reference number 3R15

The axis clamp with swing axle and brake axle forms the connection between the upper joint section and lower joint section of the 3R15 and acts as a load-dependent brake. It secures the stance phase in combination with the posterior location. The axle friction and spring force of the extension assist spring can be adjusted to control the swing phase.



Max. 100 kg

Information material

647G1562=ALL_INT IFU 3R15 3R49

Scope of delivery

3R15		1	Piece
21Y70	Protective sleeve	1	Piece

Technical data

Article number	3R15
Max. body weight	100 kg
Mobility grade	1, 2
Weight	490 g
Proximal connection	Pyramid
Distal connection	Pyramid
Knee flexion angle	150 °
System height	9 mm
Proximal system height to alignment reference point	8 mm
Distal system height to alignment reference point	1 mm
Build height	45 mm
Proximal build height to alignment reference point	26 mm
Distal build height to alignment reference point	19 mm
Material	Stainless steel

Accessories/spare parts for 3R49, 3R15



Protective sleeve

Reference number 21Y70

External sleeve made of injection-moulded granulate to protect the knee joint, extension assist unit and cosmetic foam cover or clothing.

Technical data

Article number	Spare part for
21Y70=N	3R15 3R49

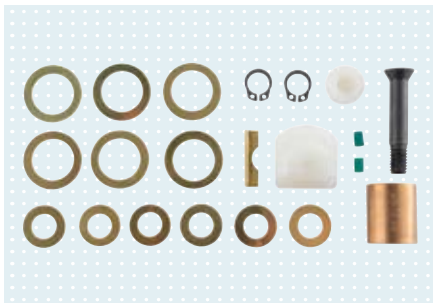

Single component pack

Reference number 4D1

The single component pack consists of spare parts for the 3R15 and 3R49 modular knee joints with friction brake.

Technical data

Article number	Spare part for
4D1	3R15 3R49

Components

Bumper	1 Piece
Bumper	2 Piece
Bumper	1 Piece
Safety device for bushing	1 Piece
Retaining ring DIN 471	2 Piece
Axis screw	1 Piece
Washer	2 Piece
Washer	2 Piece
Bearing washer	2 Piece
Bearing washer	2 Piece
Bearing washer	2 Piece
Bearing washer	2 Piece
Bronze bearing	1 Piece

Knee joints

Mobility grade 1–2



Habermann knee joint, polycentric, with integrated extension assist

Reference number 3R36

With the 3R36, as with the 3R20, the upper and lower joint sections are connected to one another by linkage bars. Stance phase stability is achieved through the polycentric kinematics (setting the moment pivot point by adjusting the stop). To control the swing phase, the axial friction and extension assist spring are continuously adjustable.



Max. 100 kg

Information material

647G72=ALL_INT IFU 3R20 3R36

Scope of delivery

3R36 1 Piece

Technical data

Article number	3R36
Max. body weight	100 kg
Mobility grade	1, 2
Weight	445 g
Proximal connection	Pyramid
Distal connection	Pyramid
Knee flexion angle	110 °
System height	41 mm
Proximal system height to alignment reference point	-3 mm
Distal system height to alignment reference point	44 mm
Build height	77 mm
Proximal build height to alignment reference point	15 mm
Distal build height to alignment reference point	62 mm
Material	Titanium



Habermann knee joint, polycentric, with integrated extension assist

Reference number 3R20

With the 3R20, as with the 3R36, the upper and lower joint sections are connected to one another by linkage bars. Stance phase stability is achieved through the polycentric kinematics (setting the moment pivot point by adjusting the stop). To control the swing phase, the axial friction and extension assist spring are continuously adjustable.



Max. 100 kg

Information material

647G72=ALL_INT IFU 3R20 3R36

Scope of delivery

3R20 1 Piece

Technical data

Article number	3R20
Max. body weight	100 kg
Mobility grade	1, 2
Weight	690 g
Proximal connection	Pyramid
Distal connection	Pyramid
Knee flexion angle	110 °
System height	41 mm
Proximal system height to alignment reference point	-3 mm
Distal system height to alignment reference point	44 mm
Build height	77 mm
Proximal build height to alignment reference point	15 mm
Distal build height to alignment reference point	62 mm
Material	Stainless steel

Knee joints

Mobility grade 1–2

Accessories/spare parts for 3R36, 3R20



Single component pack

Reference number 4D13

The single component pack consists of spare parts for the 3R36 and 3R20 Ottobock Habermann modular knee joints.

Technical data

Article number	Spare part for
4D13	3R36 3R20

Components

Plastic knee cap	1 Piece
Cap screw (Allen screw)	1 Piece
Extension stop	1 Piece
Stop bumper	1 Piece
Pin for extension assist	1 Piece
Extension assist spring	1 Piece
Adjustment screw	1 Piece
Bearing ball	1 Piece
Lock nut	2 Piece
Posterior Axis Pins	2 Piece
Washer	4 Piece
Rounded washer	4 Piece



Knee joint with friction brake, monocentric, with lock

Reference number 3R93

The 3R93 is a monocentric knee joint with a load-dependent brake mechanism and an optional locking function. An integrated, adjustable extension assist spring controls the swing phase.

Key features

- Provides targeted support for the therapy process following an amputation
- Used as a locking knee joint with manual release or as a knee joint with friction brake
- The O&P professional can permanently deactivate the locking function
- Integrated extension assist spring can be optimally adjusted from the outside and controls the pendulum motion of the prosthetic lower leg

Information material

647G525=ALL_INT IFU 3R93

Scope of delivery

3R93		1	Piece
2R77	Tube adapter	1	Piece
710H10	Adjustment wrench	1	Piece



Max. 125 kg

Technical data

Article number	3R93
Max. body weight	125 kg
Mobility grade	1, 2
Weight	760 g
Proximal connection	Pyramid
Distal connection	Tube clamp, 34 mm Ø
Knee flexion angle	130 °
System height	82 mm
Proximal system height to alignment reference point	8 mm
Distal system height to alignment reference point	74 mm
Build height	141 mm
Proximal build height to alignment reference point	26 mm
Distal build height to alignment reference point	115 mm
Material	Aluminium



Practical recommendation 3R93

The 3R93 modular knee joint with friction brake and lock is not suitable for users with:

- Hip disarticulation
- Hemipelvectomy
- Bilateral amputation

Knee joints

Mobility grade 1–2

Accessories/spare parts for 3R93



Tube adapter

Reference number 2R76/2R77

The 2R76 and 2R77 tube adapters differ in length. They connect prosthetic components to each other. Adapter combinations allow for controlled angle and translational adaptation in the sagittal and frontal plane as well as adjustment of inward and outward rotation.

Technical data

Article number	Diameter	Material	Min. system height	Max. system height	Min. build height	Overall length	Weight	Max. body weight
2R76	34 mm	Stainless steel	77 mm	282 mm	27 mm	264 mm	260 g	150 kg
2R77	34 mm	Stainless steel	77 mm	472 mm	27 mm	454 mm	370 g	150 kg



Tube adapter

Reference number 2R57/2R58

The 2R57 and 2R58 tube adapters differ in length. They connect prosthetic components to each other. Adapter combinations allow for controlled angle and translational adaptation in the sagittal and frontal plane as well as adjustment of inward and outward rotation. The 2R57 and 2R58 are resistant to fresh, salt and chlorinated water.

Technical data

Article number	Diameter	Material	Min. system height	Max. system height	Min. build height	Overall length	Weight	Max. body weight
2R57	34 mm	Titanium	77 mm	282 mm	27 mm	264 mm	220 g	150 kg
2R58	34 mm	Titanium	77 mm	472 mm	27 mm	454 mm	330 g	150 kg



Locking unit

Reference number 4F34

For use on both left and right sides, adjustable for push and pull. Can be used instead of the factory-installed 4F18=N lock slide.

Technical data

Article number	Accessory for
4F34	3R93



Single component pack for knee joint cover

Reference number 4D29

The single component pack consists of spare parts for the knee joint cover of the 3R93 modular knee joint with friction brake and lock.

Technical data

Article number

4D29

Components

Isopropyl alcohol	1 Piece
Side spring	1 Piece
Side spring	1 Piece
Protective cap	4 Piece
Knee joint cover	1 Piece
Felt strip	1 Piece

Knee joints

Mobility grade 1–2



Knee joint with friction brake, monocentric, with extension assist

Reference number 3R90

The load-dependent brake mechanism offers targeted safety for the user. A heel load activates the brake, providing high stability in the stance phase. The swing phase is controlled by means of an integrated mechanical extension assist with a spring combination.



Max. 125 kg

Information material

647G475=ALL_INT IFU 3R90 3R92

Scope of delivery

3R90		1	Piece
2R77	Tube adapter	1	Piece

Technical data

Article number	3R90
Max. body weight	125 kg
Mobility grade	1, 2
Weight	745 g
Proximal connection	Pyramid
Distal connection	Tube clamp
Knee flexion angle	135 °
System height	97 mm
Proximal system height to alignment reference point	8 mm
Distal system height to alignment reference point	89 mm
Build height	216 mm
Proximal build height to alignment reference point	26 mm
Distal build height to alignment reference point	190 mm

i Practical recommendation 3R90

In the treatment of users with mobility grade 1, these knee joints with friction brake are contraindicated for unconfident users who are unable to systematically use the braking mechanism during the gait cycle – with security at heel contact and switching under forefoot load.

Accessories/spare parts for 3R90



Tube adapter

Reference number 2R76/2R77

The 2R76 and 2R77 tube adapters differ in length. They connect prosthetic components to each other. Adapter combinations allow for controlled angle and translational adaptation in the sagittal and frontal plane as well as adjustment of inward and outward rotation.

Technical data

Article number	Diameter	Material	Min. system height	Max. system height	Weight	Max. body weight
2R76	34 mm	Stainless steel	77 mm	282 mm	260 g	150 kg
2R77	34 mm	Stainless steel	77 mm	472 mm	370 g	150 kg



Knee joint for disarticulation, polycentric, with mechanical extension assist

Reference number 3R30

The upper joint section of the 3R30 with coupling unit and the lower joint section are connected to each other by linkage bars. The detachable lamination anchor connects the knee to the prosthetic socket. Stance phase stability is achieved through polycentric kinematics. The extension assist spring and axial friction are both continuously adjustable.



Max. 125 kg

Information material

647G44=ALL_INT IFU 3R21 3R30

Scope of delivery

3R30		1	Piece
4G70	Lamination anchor	1	Piece

Technical data

Article number	3R30
Max. body weight	125 kg
Mobility grade	1, 2
Weight	655 g
Proximal connection	Lamination anchor
Distal connection	Pyramid
Knee flexion angle	110 °
System height	99 mm
Proximal system height to alignment reference point	17 mm
Distal system height to alignment reference point	82 mm
Build height	117 mm
Proximal build height to alignment reference point	17 mm
Distal build height to alignment reference point	100 mm
Material	Titanium

Knee joints

Mobility grade 1–2



Knee joint for disarticulation, polycentric, with mechanical extension assist

Reference number 3R21

The upper joint section of the 3R21 with coupling unit and the lower joint section are connected to each other by linkage bars. The detachable lamination anchor provides the connection to the prosthetic socket. Stance phase stability is achieved through polycentric kinematics. The force of the extension assist spring and axial friction are continuously adjustable.



Max. 125 kg

Information material

647G44=ALL_INT IFU 3R21 3R30

Scope of delivery

3R21		1	Piece
4G70	Lamination anchor	1	Piece

Technical data

Article number	3R21
Max. body weight	125 kg
Mobility grade	1, 2
Weight	1.010 g
Proximal connection	Lamination anchor
Distal connection	Pyramid
Knee flexion angle	110 °
System height	99 mm
Proximal system height to alignment reference point	17 mm
Distal system height to alignment reference point	82 mm
Build height	117 mm
Proximal build height to alignment reference point	17 mm
Distal build height to alignment reference point	100 mm
Material	Stainless steel

Accessories/spare parts for 3R30, 3R21



Single component pack

Reference number 4D7

The single component pack consists of spare parts for the 3R30 and 3R21 modular knee joints.

Technical data

Article number	Spare part for
4D7	3R21 3R30

Components

Slotted bushing	4	Piece
Bevel washer	4	Piece
Retaining ring DIN 471	2	Piece
Knee stop	2	Piece
Extension assist spring	1	Piece
Bearing for extension assist	1	Piece
Plastic guide	1	Piece
Guide pin for extension assist	1	Piece
Knob for extension assist	1	Piece
Cap screw	4	Piece
Two hole joint nut	4	Piece
Lock nut	2	Piece
Grub screw	1	Piece
Grub screw	2	Piece



Lamination anchor

Reference number 4G70

The lamination anchor serves as the proximal connection for modular knee joints. It is suitable only for use with prosthetic knee joints for knee disarticulations.

Technical data

Article number	Material	Max. body weight
4G70	Stainless steel	125 kg

Knee joints

Mobility grade 2–3



Knee joint with friction brake, monocentric, with pneumatic swing phase control

Reference number 3R92

The 3R92 monocentric knee joint with friction brake and pneumatic swing phase control has the same brake mechanism as the 3R90. The lower joint section is constructed as a pneumatic cylinder. To control the swing phase, the flexion and extension damping of the progressively acting dual-chamber pneumatics can be adjusted individually.



Max. 125 kg

Information material

647G475=ALL_INT IFU 3R90 3R92

Scope of delivery

3R92		1	Piece
2R77	Tube adapter	1	Piece

Technical data

Article number	3R92
Max. body weight	125 kg
Mobility grade	2, 3
Weight	895 g
Proximal connection	Pyramid
Distal connection	Tube clamp
Knee flexion angle	135 °
System height	154 mm
Proximal system height to alignment reference point	8 mm
Distal system height to alignment reference point	146 mm
Build height	216 mm
Proximal build height to alignment reference point	26 mm
Distal build height to alignment reference point	190 mm



Practical recommendation 3R92

In the treatment of users with mobility grade 1, these knee joints with friction brake are contraindicated for unconfident users who are unable to systematically use the braking mechanism during the gait cycle – with security at heel contact and switching under forefoot load.



Knee joint, polycentric, with pneumatic swing phase control

Reference number 3R78

The development of the 3R78 focused on a robust, dust-resistant design that is durable and resistant against environmental impacts. This polycentric prosthetic knee joint with pneumatic swing phase control offers reliable stance phase security for prosthesis wearers with moderate activity levels. In addition to the existing variant with proximal pyramid, other connection variants are now offered as well for users with a long residual limb (threaded connector) or knee disarticulation (lamination anchor, only included in the scope of delivery with the 3R78=KD). This allows an even larger group of patients to benefit from the advantages of this knee joint.



Max. 100 kg

Information material

646D1537=ALL_INT	Product information for technicians/qualified personnel
647G556=ALL_INT	IFU 3R78

Scope of delivery

3R78			1 Piece
4G70	Lamination anchor	only with 3R78=KD	1 Piece

Technical data

Article image



	3R78	3R78=KD	3R78=ST
Article number	3R78	3R78=KD	3R78=ST
Max. body weight	100 kg	100 kg	100 kg
Mobility grade	2, 3	2, 3	2, 3
Weight	760 g	780 g	790 g
Proximal connection	Pyramid	Lamination anchor	Threaded connector
Distal connection	Tube clamp Ø30	Tube clamp Ø30	Tube clamp Ø30
Knee flexion angle	150 °	150 °	150 °
System height	156 mm	179 mm	174 mm
Proximal system height to alignment reference point	-7 mm	16 mm	11 mm
Distal system height to alignment reference point	163 mm	163 mm	163 mm
Build height	211 mm	216 mm	211 mm
Proximal build height to alignment reference point	11 mm	16 mm	11 mm
Distal build height to alignment reference point	200 mm	200 mm	200 mm
Material	Aluminium	Aluminium	Aluminium

Knee joints

Mobility grade 2–3

Accessories/spare parts for 3R78=KD



Lamination anchor

Reference number 4G70

The lamination anchor serves as the proximal connection for modular knee joints. It is suitable only for use with prosthetic knee joints for knee disarticulations.

Technical data

Article number	Material	Max. body weight
4G70	Stainless steel	125 kg



Knee joint, polycentric, with pneumatic swing phase control

Reference number 3R106

With the 3R106 polycentric knee joint, the stance phase is secured due to the four-axis joint design. Powerful dual-chamber pneumatics with integrated extension assist spring produce smooth pendulum movements of the prosthetic lower leg, even at higher walking speeds. The 4G70 lamination anchor is only included in the scope of delivery with the 3R106=KD variant.



Max. 100 kg

Information material

647G1640=ALL_INT IFU 3R106

Scope of delivery

3R106			1	Piece
2R49	Tube adapter		1	Piece
4G70	Lamination anchor	only with 3R106=KD	1	Piece
513D83	Compression spring		1	Piece
513D83	Compression spring, heavy duty		1	Piece

Technical data

Article image



	3R106	3R106=KD	3R106=ST
Article number	3R106	3R106=KD	3R106=ST
Max. body weight	100 kg	100 kg	100 kg
Mobility grade	2, 3	2, 3	2, 3
Weight	760 g	755 g	765 g
Proximal connection	Pyramid	Lamination anchor	Threaded connector
Distal connection	Tube clamp Ø 30 mm	Tube clamp Ø 30 mm	Tube clamp Ø 30 mm
Knee flexion angle	170 °	170 °	170 °
System height	162 mm	184 mm	180 mm
Proximal system height to alignment reference point	-6 mm	16 mm	12 mm
Distal system height to alignment reference point	168 mm	168 mm	168 mm
Build height	212 mm	216 mm	212 mm
Proximal build height to alignment reference point	12 mm	16 mm	12 mm
Distal build height to alignment reference point	200 mm	200 mm	200 mm

Knee joints

Mobility grade 2–3



Knee joint, polycentric, with servo-pneumatic swing phase control

Reference number 3R106-PRO

Servo-pneumatic control forms the centrepiece of the polycentric 3R106-PRO, encompassing high-performance, dual-chamber pneumatics with progressive damping characteristics. The flexion resistance increases auto-adaptively at faster walking speeds. As a result, the pendulum movements in the swing phase are smoothly controlled, even at higher walking speeds. The 4G70 lamination anchor is only included in the scope of delivery for the 3R106-PRO=KD variant.



Max. 125 kg

Information material

647G208=ALL_INT IFU 3R106-PRO

Scope of delivery

3R106-PRO			1 Piece
2R49	Tube adapter		1 Piece
4G70	Lamination anchor	only with 3R106-PRO=KD	1 Piece
513D83	Compression spring		1 Piece
513D83	Compression spring, heavy duty		1 Piece
710H10	Adjustment wrench		1 Piece

Technical data

Article image



	3R106-PRO	3R106-PRO=KD	3R106-PRO=ST
Article number	3R106-PRO	3R106-PRO=KD	3R106-PRO=ST
Max. body weight	125 kg	125 kg	125 kg
Mobility grade	2, 3	2, 3	2, 3
Weight	885 g	910 g	915 g
Proximal connection	Pyramid	Lamination anchor	Threaded connector
Distal connection	Tube clamp Ø 30 mm	Tube clamp Ø 30 mm	Tube clamp Ø 30 mm
Knee flexion angle	175 °	175 °	175 °
System height	163 mm	187 mm	181 mm
Proximal system height to alignment reference point	-7 mm	16 mm	11 mm
Distal system height to alignment reference point	170 mm	170 mm	170 mm
Build height	219 mm	224 mm	219 mm
Proximal build height to alignment reference point	11 mm	16 mm	11 mm
Distal build height to alignment reference point	208 mm	208 mm	208 mm
Material	Aluminium	Aluminium	Aluminium

Accessories/spare parts for 3R106-PRO, 3R106



Tube adapter

Reference number 2R50/2R49

The 2R50 and 2R49 tube adapters differ in length. They connect prosthetic components to each other. Adapter combinations allow for controlled angle and translational adaptation in the sagittal and frontal plane as well as adjustment of inward and outward rotation.

Technical data

Article number	Diameter	Material	Min. system height	Max. system height	Min. build height	Overall length	Weight	Max. body weight
2R50	30 mm	Aluminium	97 mm	232 mm	53 mm	214 mm	155 g	125 kg
2R49	30 mm	Aluminium	97 mm	472 mm	53 mm	414 mm	255 g	125 kg

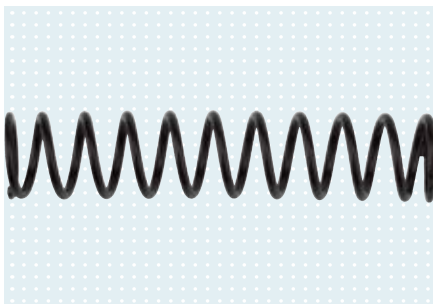

Compression spring

Reference number 513D83

The 513D83=1.1X12.9X66 compression spring is available as a spare part for the 3R106 and 3R106-PRO knee joints.

Technical data

Article number	Spare part for
513D83=1.1X12.9X66	3R106 3R106=KD 3R106=ST 3R106-PRO 3R106-PRO=KD 3R106-PRO=ST

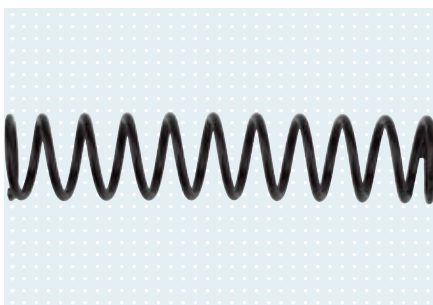

Compression spring, heavy duty

Reference number 513D83

The 513D83=1.4X12.6X66 compression spring is available as a spare part for the 3R106 and 3R106-PRO knee joints.

Technical data

Article number	Spare part for
513D83=1.4X12.6X66	3R106 3R106=KD 3R106=ST 3R106-PRO 3R106-PRO=KD 3R106-PRO=ST

Knee joints

Mobility grade 2–3

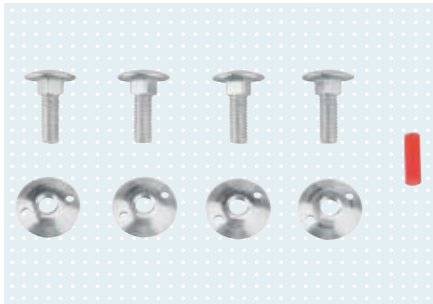

Single component pack

Reference number 4D3

The single component pack consists of spare parts for the 3R106 and 3R106-PRO knee joints.

Technical data

Article number	Spare part for
4D3	3R106 3R106=KD 3R106=ST 3R106-PRO 3R106-PRO=ST 3R106-PRO=KD

Components

Two hole joint nut	4	Piece
Stop for 3R106	1	Piece
Cap screw	4	Piece



Lamination anchor

Reference number 4G70

The lamination anchor serves as the proximal connection for modular knee joints. It is suitable only for use with prosthetic knee joints for knee disarticulations.

Technical data

Article number	Material	Max. body weight
4G70	Stainless steel	125 kg



EBSpro knee joint, polycentric, with hydraulic swing phase control

Reference number 3R60-PRO

The 3R60-PRO is a polycentric knee joint for users with a moderate activity level and a low weight of up to 75 kg. The 3R60-PRO enables controlled knee flexion at heel strike and features powerful hydraulic swing phase control. The EBS elastic flexion unit provides enhanced comfort and safety for users.

Key features

- Polycentric joint design permits controlled, spring-loaded flexion up to max. 15° on heel contact without initiating normal knee flexion
- Individually adjustable stance phase flexion gives the user added knee stability
- Different walking speeds possible
- Significant reduction of loads on the residual limb, hip and spine

Information material

647G381=ALL_INT	IFU 3R60-PRO
-----------------	--------------

Scope of delivery

3R60-PRO			1	Piece
4G70	Lamination anchor	only with 3R60-PRO=KD	1	Piece
710H10	Adjustment wrench		1	Piece



Max. 75 kg

Technical data

Article image



Article number	3R60-PRO	3R60-PRO=HD	3R60-PRO=KD	3R60-PRO=ST
Max. body weight	75 kg	75 kg	75 kg	75 kg
Mobility grade	2, 3	2, 3	2, 3	2, 3
Weight	770 g	770 g	840 g	750 g
Proximal connection	Pyramid (movable)	Pyramid (10° inclined)	Lamination anchor	Threaded connector
Distal connection	Pyramid	Pyramid	Pyramid	Pyramid
Knee flexion angle	175 °	175 °	145 °	125 °
System height	150 mm	150 mm	169 mm	165 mm
Proximal system height to alignment reference point	2 mm	2 mm	21 mm	17 mm
Distal system height to alignment reference point	148 mm	148 mm	148 mm	148 mm
Build height	186 mm	186 mm	187 mm	183 mm
Proximal build height to alignment reference point	20 mm	20 mm	21 mm	17 mm
Distal build height to alignment reference point	166 mm	166 mm	166 mm	166 mm

Knee joints

Mobility grade 2–3



EBS knee joint, polycentric, with hydraulic swing phase control

Reference number 3R60

Proven multiple times, the 3R60 enables controlled knee flexion at heel strike and features powerful hydraulic swing phase control. The EBS elastic flexion unit provides enhanced comfort and safety for users.

Key features

- Polycentric joint design permits controlled, spring-loaded flexion up to max. 15° on heel contact without initiating normal knee flexion
- Individually adjustable stance phase flexion gives the user added knee stability
- Different walking speeds possible
- Significant reduction of loads on the residual limb, hip and spine

Information material

647G167=ALL_INT IFU 3R60

Scope of delivery

3R60			1 Piece
4G70	Lamination anchor	only with 3R60=KD	1 Piece
710H10	Adjustment wrench		1 Piece



Max. 125 kg

Technical data

Article image



Article number	3R60	3R60=HD	3R60=KD	3R60=ST
Max. body weight	125 kg	125 kg	125 kg	125 kg
Mobility grade	2, 3	2, 3	2, 3	2, 3
Weight	845 g	880 g	940 g	845 g
Proximal connection	Pyramid	Pyramid (10° inclined)	Lamination anchor	Threaded connector
Distal connection	Pyramid	Pyramid	Pyramid	Pyramid
Knee flexion angle	150 °	150 °	150 °	150 °
System height	171 mm	174 mm	193 mm	189 mm
Proximal system height to alignment reference point	-2 mm	1 mm	20 mm	16 mm
Distal system height to alignment reference point	173 mm	173 mm	173 mm	173 mm
Build height	207 mm	210 mm	211 mm	207 mm
Proximal build height to alignment reference point	16 mm	19 mm	20 mm	16 mm
Distal build height to alignment reference point	191 mm	191 mm	191 mm	191 mm

Accessories/spare parts for 3R60-PRO, 3R60



Lamination anchor

Reference number 4G70

The lamination anchor serves as the proximal connection for modular knee joints. It is suitable only for use with prosthetic knee joints for knee disarticulations.

Technical data

Article number	Material	Max. body weight
4G70	Stainless steel	125 kg

Knee joints

Mobility grade 3–4



Knee joint, monocentric, with rotation hydraulics

Reference number 3R80

The monocentric knee joint and its unique principle of rotation hydraulics allow users to closely approximate a physiological gait pattern, descend stairs step-over-step and walk down slopes. The 3R80 is a waterproof design for wet areas and is approved for a body weight of up to 150 kg.

Key features

- Individual adaptation of stance and swing phase behaviour
- Flexion and extension resistance can be adjusted independently
- Waterproof design also permits use in wet areas, for example in the shower or at the pool
- Integrated manual lock

Information material

647G403=ALL_INT	IFU 3R80
646D1533=ALL_INT	Quick reference guide 3R80

Scope of delivery

3R80		1	Piece
2R58	Tube adapter	1	Piece
710H10	Adjustment wrench	1	Piece

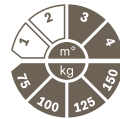

Max. 150 kg

Technical data

Article image



	3R80	3R80=ST
Article number	3R80	3R80=ST
Max. body weight	150 kg	150 kg
Mobility grade	3, 4	3, 4
Weight	1240 g	1255 g
Proximal connection	Pyramid	Threaded connector
Distal connection	Tube clamp Ø 34 mm	Tube clamp Ø 34 mm
Knee flexion angle	150 °	150 °
System height	163 mm	179 mm
Proximal system height to alignment reference point	28 mm	44 mm
Distal system height to alignment reference point	135 mm	135 mm
Build height	218 mm	216 mm
Proximal build height to alignment reference point	46 mm	44 mm
Distal build height to alignment reference point	172 mm	172 mm

Accessories/spare parts for 3R80



Tube adapter

Reference number 2R76/2R77

The 2R76 and 2R77 tube adapters differ in length. They connect prosthetic components to each other. Adapter combinations allow for controlled angle and translational adaptation in the sagittal and frontal plane as well as adjustment of inward and outward rotation.

Technical data

Article number	Diameter	Material	Min. system height	Max. system height	Min. build height	Overall length	Weight	Max. body weight
2R76	34 mm	Stainless steel	77 mm	282 mm	27 mm	264 mm	260 g	150 kg
2R77	34 mm	Stainless steel	77 mm	472 mm	27 mm	454 mm	370 g	150 kg



Tube adapter

Reference number 2R57/2R58

The 2R57 and 2R58 tube adapters differ in length. They connect prosthetic components to each other. Adapter combinations allow for controlled angle and translational adaptation in the sagittal and frontal plane as well as adjustment of inward and outward rotation. The 2R57 and 2R58 are resistant to fresh, salt and chlorinated water.

Technical data

Article number	Diameter	Material	Min. system height	Max. system height	Min. build height	Overall length	Weight	Max. body weight
2R57	34 mm	Titanium	77 mm	282 mm	27 mm	264 mm	220 g	150 kg
2R58	34 mm	Titanium	77 mm	472 mm	27 mm	454 mm	330 g	150 kg

Accessories/spare parts for 3R95



Single component pack

Reference number 4D17

The single component pack consists of spare parts for the 3R95 modular knee joint.

Technical data

Article number	Spare part for
4D17	3R95

Components

Rubber block	1 Piece
Flat head screw	1 Piece



Adjusting tool

Reference number 4G764

This is a spare part for the 3R95 and 3WR95.

Technical data

Article number
4G764

Knee joints

Mobility grade 3–4



Knee joint, polycentric, with hydraulic swing phase control

Reference number 3R55

The upper and lower joint sections of the 3R55 are connected to one another by linkage bars. Stance phase stability is achieved through polycentric kinematics. The swing phase is controlled by the integrated hydraulics. Flexion and extension can be adjusted independently.



Max. 125 kg

Information material

647G1636=ALL_INT IFU 3R55

Scope of delivery

3R55		1	Piece
4X16	Adjustment aid	1	Piece

Technical data

Article number	3R55
Max. body weight	125 kg
Mobility grade	3, 4
Weight	720 g
Proximal connection	Pyramid
Distal connection	Pyramid
Knee flexion angle	110 °
System height	90 mm
Proximal system height to alignment reference point	9 mm
Distal system height to alignment reference point	81 mm
Build height	126 mm
Proximal build height to alignment reference point	27 mm
Distal build height to alignment reference point	99 mm

Accessories/spare parts for 3R55



Single component pack

Reference number 4D19

The single component pack consists of spare parts for the 3R55 modular knee joint.

Technical data

Article number	Spare part for
4D19	3R55

Components

Knee stop	2	Piece
Damper protection	1	Piece
Attachment nipple	2	Piece
Attachment nipple	1	Piece
Slotted bushing	4	Piece
Bevel washer	4	Piece
Retaining ring DIN 471	2	Piece
Lock nut	2	Piece



Knee joint for disarticulation, polycentric, with hydraulic swing phase control

Reference number 3R46

The upper joint section and lower joint section with pyramid of the 3R46 are connected to one another by linkage bars. The detachable lamination anchor provides the connection to the prosthetic socket. Stance phase stability is achieved through polycentric kinematics. The swing phase is controlled by the integrated hydraulics. Flexion and extension can be adjusted independently.



Max. 125 kg

Information material

647G94=ALL_INT IFU 3R46

Scope of delivery

3R46		1	Piece
4G70	Lamination anchor	1	Piece
4X16	Adjustment aid	1	Piece

Technical data

Article number	3R46
Max. body weight	125 kg
Mobility grade	3, 4
Weight	740 g
Proximal connection	Lamination anchor
Distal connection	Pyramid
Knee flexion angle	110 °
System height	99 mm
Proximal system height to alignment reference point	17 mm
Distal system height to alignment reference point	82 mm
Build height	117 mm
Proximal build height to alignment reference point	17 mm
Distal build height to alignment reference point	100 mm

Knee joints

Mobility grade 3–4

Accessories/spare parts for 3R46



Single component pack

Reference number 4D18

The single component pack consists of spare parts for the 3R46 modular knee joint.

Technical data

Article number	Spare part for
4D18	3R46

Components

Knee stop	2	Piece
Cap screw	4	Piece
Two hole joint nut	4	Piece
Slotted bushing	4	Piece
Bevel washer	4	Piece
Grub screw	3	Piece
Retaining ring DIN 471	2	Piece
Lock nut	2	Piece
Attachment nipple	2	Piece
Attachment nipple	1	Piece
Damper protection	1	Piece



Lamination anchor

Reference number 4G70

The lamination anchor serves as the proximal connection for modular knee joints. It is suitable only for use with prosthetic knee joints for knee disarticulations.

Technical data

Article number	Material	Max. body weight
4G70	Stainless steel	125 kg



Electronic knee joint

Reference number 3E80

The 3E80 bundles the benefits of the tried-and-tested rotary hydraulic technology and Ottobock's experience with microprocessor control: It offers amputees remarkable support and increased safety in activities of daily living like walking on uneven terrain, slopes or stairs. Unlike other microprocessor knees, it comes with quick and easy adjustment that's fully manual – in just three steps – with no need for software or a computer.



Max. 125 kg

Information material

647G1516=ALL_INT IFU 3E80

Scope of delivery

3E80	Electronic knee joint	1	Piece
4G497	Charger unit	1	Piece
4G520	Battery 7.4V Li-Ion for 3E80	1	Piece
4G513	Front inlay	1	Piece

Key features

- Automatic adaptation to different user weights and walking speeds
- Lightweight with compact dimensions for a broad fitting range
- Robust and durable
- Battery capacity: up to 96 hours
- High flexion angle of 140°
- Bicycling mode

Technical data

Article number	3E80
Max. body weight	125 kg
Mobility grade	3, 4
Weight	1280 g
Proximal connection	Pyramid
Distal connection	Tube clamp Ø 34 mm
Knee flexion angle	140 °
System height	134 mm
Proximal system height to alignment reference point	25 mm
Distal system height to alignment reference point	109 mm
Build height	195 mm
Proximal build height to alignment reference point	43 mm
Distal build height to alignment reference point	152 mm

Knee joints

Mobility grade 3–4

Accessories/spare parts for 3E80



Lamination anchor with pyramid receiver and angled arm, rotatable

Reference number 4R119

The 4R119 and 4R119=T lamination anchors are laminated into a prosthetic socket. They have an angled anchor arm intended for posterior positioning. It takes the flexion position of the residual limb/socket into account. The 4R119=T is waterproof.

Technical data

Article number	Material	System height	Build height	Weight	Max. body weight
4R119	Stainless steel	44 mm	26 mm	165 g	150 kg
4R119=T	Stainless steel Titanium	44 mm	26 mm	135 g	150 kg



Lamination anchor with pyramid receiver, rotatable

Reference number 4R111

The 4R111 lamination anchor is laminated into a prosthetic socket. It serves to connect the prosthetic socket to the distal prosthetic components.

Technical data

Article number	Material	System height	Build height	Weight	Max. body weight
4R111	Stainless steel	44 mm	26 mm	155 g	150 kg



Lamination anchor with pyramid receiver, rotatable

Reference number 4R41

The 4R41 lamination anchor is laminated into a prosthetic socket. It serves to connect the prosthetic socket to the distal prosthetic components.

Technical data

Article number	Material	System height	Build height	Weight	Max. body weight
4R41	Stainless steel	39 mm	21 mm	170 g	125 kg



Socket adapter with pyramid receiver, rotatable

Reference number 4R51

The 4R51 socket adapter is used to connect prosthetic components with a four-hole connector, such as the 5R1 and 5R2 socket attachment blocks or the Quickchange adapter.

Technical data

Article number	Material	System height	Build height	Weight	Max. body weight
4R51	Titanium	36 mm	18 mm	80 g	150 kg



Socket adapter with pyramid receiver

Reference number 4R55

The 4R55 socket adapter is used to connect prosthetic components with a four-hole connector, such as the 5R1 and 5R2 socket attachment blocks or the Quickchange adapter.

Technical data

Article number	Material	System height	Build height	Weight	Max. body weight
4R55	Titanium	33 mm	15 mm	50 g	150 kg

Knee joints

Kenevo



Kenevo

Reference number 3C60

The Kenevo is a microprocessor-controlled prosthetic knee joint with a focus on supporting the needs of moderately active users. It is also suitable as a knee joint for rehabilitation after amputation. It has 5 basic functions, which offer support in typical everyday situations. In addition, activity modes A, B, B+ and C allow high adaptability to changing mobility.

Key features

- Enhanced safety thanks to sufficient ground clearance, even when taking small steps and walking slowly
- Reliable stance release with different walking aids
- Stumble recovery Plus active at all times
- Safe and comfortable standing in all situations
- Controlled, balanced sitting down and standing up
- Special wheelchair function facilitates manoeuvring in a wheelchair
- Adjustment software with descriptive video tutorials (K-Soft version 1.4 and up)
- Connection to an osseointegrated, percutaneous implant system possible

Information material

647G1415=ALL_INT	IFU Kenevo (qualified personnel)
647H49-1=ALL_INT	IFU Kenevo (user)
647H49-2=ALL_INT	IFU Kenevo (user)

Scope of delivery

3C60	Kenevo	Pyramid	1 Piece
3C60=ST	Kenevo	Threaded connector (alternative)	1 Piece
2R17	AXON tube adapter		1 Piece
757L16-4	Power supply unit		1 Piece
4E70	Inductive charger		1 Piece
4H107	Kenevo 8° flexion stop	already assembled when delivered	1 Piece
4H108	Kenevo 16° flexion stop		1 Piece
646H36=ALL_INT	Prosthesis passport		1 Piece



Max. 125 kg

Technical data

Article image



Article number	3C60	3C60=ST
Mobility grade	1, 2	1, 2
Proximal connection	Pyramid	Threaded connector
Distal connection	Tube clamp	Tube clamp
Knee flexion angle	124 °	124 °
Moisture protection	IP22 (protection against dripping water)	IP22 (protection against dripping water)
Weight (without tube adapter)	915 g	920 g
Max. body weight	125 kg	125 kg
Proximal system height to alignment reference point	5 mm	23 mm
Minimum distal system height with 2R17 AXON tube adapter	274 mm	274 mm
Max. distal system height with 2R17 AXON tube adapter	490 mm	490 mm
Min. build height with 2R17 AXON tube adapter	279 mm	279 + 9* mm
Max. build height with 2R17 AXON tube adapter	495 mm	495 + 9* mm
Proximal build height to alignment reference point	23 mm	23 + 9* mm
Min. distal build height with 2R17 AXON tube adapter	256 mm	256 mm
Max. distal build height with 2R17 AXON tube adapter	472 mm	472 mm

* The thread length is 9 mm.

- The flexion stop reduces the knee flexion angle by 8° (pre-assembled) or 16°.
- Depending on the market, the Kenevo is supplied with a 3/6-year guarantee or these guarantee packages are ordered separately.
- In case of connection to an implant system, verify that the manufacturer of the implant system and the manufacturers of the corresponding exoprosthetic components/adapters also permit this combination.

Kenevo

Mobility grade 1–2

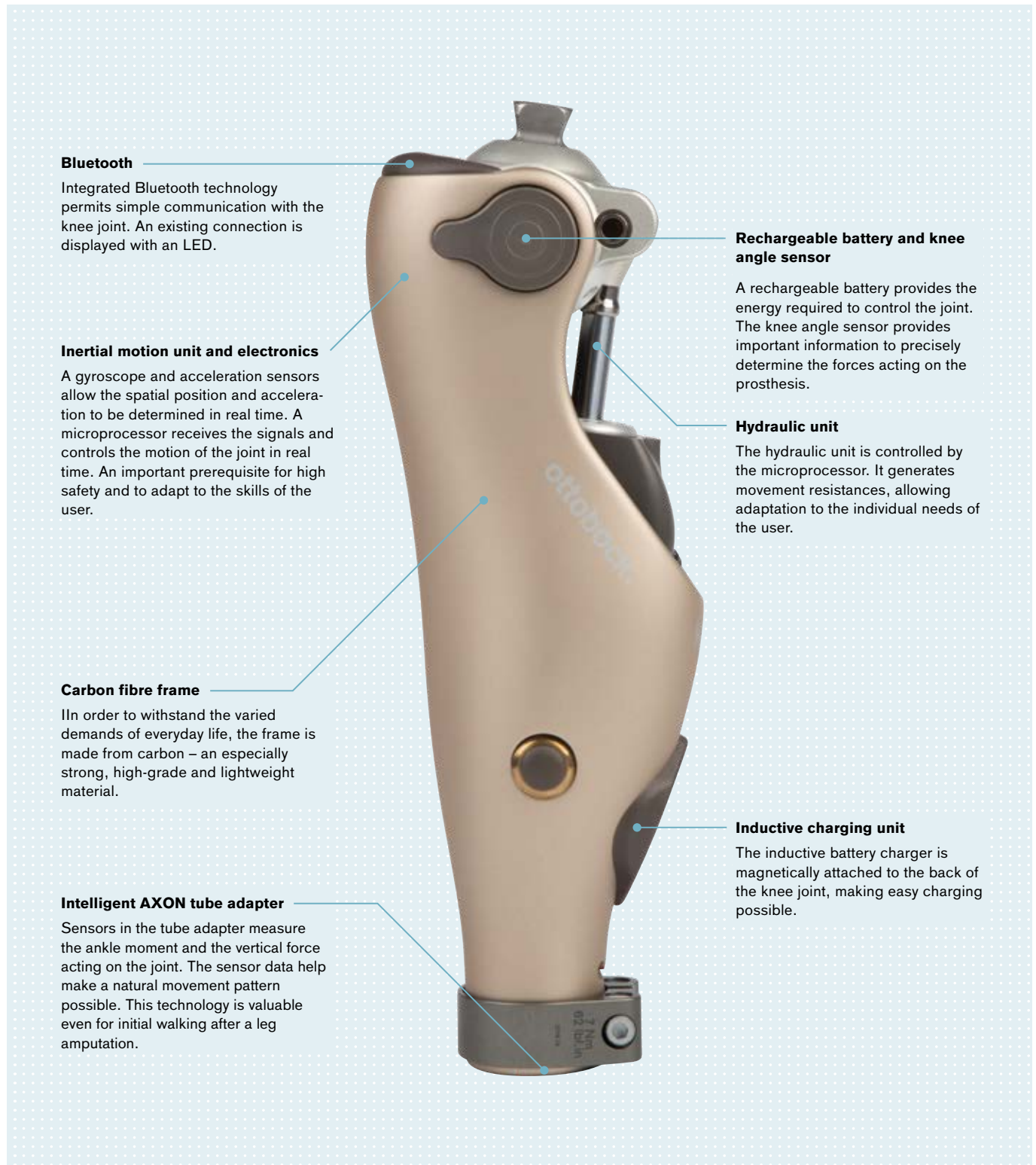

Bluetooth

Integrated Bluetooth technology permits simple communication with the knee joint. An existing connection is displayed with an LED.

Inertial motion unit and electronics

A gyroscope and acceleration sensors allow the spatial position and acceleration to be determined in real time. A microprocessor receives the signals and controls the motion of the joint in real time. An important prerequisite for high safety and to adapt to the skills of the user.

Carbon fibre frame

In order to withstand the varied demands of everyday life, the frame is made from carbon – an especially strong, high-grade and lightweight material.

Intelligent AXON tube adapter

Sensors in the tube adapter measure the ankle moment and the vertical force acting on the joint. The sensor data help make a natural movement pattern possible. This technology is valuable even for initial walking after a leg amputation.

Rechargeable battery and knee angle sensor

A rechargeable battery provides the energy required to control the joint. The knee angle sensor provides important information to precisely determine the forces acting on the prosthesis.

Hydraulic unit

The hydraulic unit is controlled by the microprocessor. It generates movement resistances, allowing adaptation to the individual needs of the user.

Inductive charging unit

The inductive battery charger is magnetically attached to the back of the knee joint, making easy charging possible.

Knee joints

Kenevo

Accessories/spare parts for 3C60



AXON tube adapter

Reference number 2R17

The tube adapter is supplied in a standard length of 515 mm and is cut to length by the O&P professional with a pipe cutter. The correct length of the tube adapter is determined using the K-Soft adjustment software.

Technical data

Article number	Diameter	Material	Weight	Max. body weight
2R17	34 mm	Aluminium	290 g	125 kg



AXON tube adapter

Reference number 2R20

The tube adapter is supplied in a standard length of 515 mm and is cut to length by the O&P professional with a pipe cutter. The correct length of the tube adapter is determined using the adjustment software.

Technical data

Article number	Diameter	Material	Weight	Max. body weight
2R20	34 mm	Aluminium	290 g	150 kg



AXON tube adapter with torsion unit

Reference number 2R21

The tube adapter is supplied in a standard length of 515 mm and is cut to length by the O&P professional with a pipe cutter. The correct length of the tube adapter is determined using the adjustment software.

Technical data

Article number	Diameter	Material	Weight	Max. body weight
2R21	34 mm	Aluminium	530 g	125 kg



K-Soft

Reference number 4X445

The adjustment software is used for the 3C60 Kenevo.

Technical data

Article number
4X445

To the download:





BionicLink PC

Reference number 60X5

The BionicLink USB Bluetooth adapter supports wireless data communication between Ottobock products with a Bluetooth interface and a PC with a USB port or USB hub via corresponding Ottobock software products.

Technical data

Article number	for
60X5	Connection to computer (USB Bluetooth adapter)



Power supply unit

Reference number 757L16-4

The power supply for electronic prosthetic components and orthoses from Ottobock. Adapters for the EU and US are included in the scope of delivery. Additional adapters can be ordered under the following article numbers:

- Great Britain: 757S1=GB-4
- Australia: 757S1=AUS-4
- Argentina: 757S1=ARG-4

Technical data

Article number
757L16-4



Inductive charger

Reference number 4E70

The inductive charger is magnetically attached to the back of the prosthetic knee joint. This technology allows for charging through light clothing.

Technical data

Article number
4E70



USB Adapter for charging

Reference number 757L43

For use with all Ottobock mechatronic knee joints (Genium/Genium X3, C-Leg, Kenevo), C-Brace, Meridium and the MyoBock prosthetic solution including the bebionic prosthetic hand.

Technical data

Article number
757L43

Knee joints

Kenevo



Kenevo 16° flexion stop

Reference number 4H108

The Kenevo 16° flexion stop reduces the knee flexion angle to 108°. It serves to prevent collisions between the socket and hydraulics or frame of the Kenevo.

Technical data

Article number

4H108



Kenevo Protective Cover

Reference number 4X840

The robust Protective Cover shields the Kenevo prosthetic knee joint against jolts, environmental influences and wear and tear. It can be shortened and thereby customised to the prosthesis wearer. The corresponding distal cap is attached after shortening to cover the cut edge.

Technical data

Article number

4X840

Weight

391 g



Foam cover

Reference number 3S26

The 3S26 covers for modular transfemoral prostheses restore the natural leg volume. They have a stepped centre hole and are partly anatomically pre-shaped.

Technical data

Article number	Material	Calf circumference	Knee flexion	Side	Length
3S26=L44	PUR	44 cm	20 °	left	approx. 95 cm
3S26=R44	PUR	44 cm	20 °	right	approx. 95 cm

Compatible prosthetic components

Liner	 6Y110	 6Y81	 6Y400	 6Y700	 6Y85	 6Y88	 6Y200		
Suspension	 21Y21	 452A1	 4R152	 4R160	 5A60				
Adapters	 4R43	 4R89	 4R41	 4R111=N	 4R116	 4R111	 4R119=N	 4R117	 4R119
Prosthetic foot	 1A30 Greissinger plus	 1C10 Terion	 1C11 Terion K2	 1C30 Trias	 1D10 Dynamic foot with adapter				
	 1D11 Dynamic foot	 1D35 Dynamic Motion	 1G6 Lightweight cosmetic foot	 1H38 Single-axis foot with toes	 1H40 Single-axis foot with toes				
	 1M10 Adjust	 1S49 SACH foot	 1S66 SACH foot	 1S90 SACH foot	 1S101 SACH+ foot				

i Please note that the instructions for use are authoritative regarding the compatibility of individual components.

Knee joints

C-Leg



C-Leg 4

Reference number 3C88-3/3C98-3

The C-Leg 4 is the latest generation of the proven knee joint. Controlled by sensors, it adapts to the individual gait pattern in real time, whether on stairs, slopes or even on challenging surfaces.

Key features

- Adapts to the respective situation thanks to intelligent technology
- Active stumble recovery enables rapid stabilisation
- A smooth gait, even on challenging surfaces
- Proven safe backward walking
- Smaller obstacles, complex terrain or large crowds are no problem thanks to the adaptive stance phase resistances
- Increased stability and comfort by choosing between intuitive and manual stance
- Weatherproof (IP67), making activities with occasional exposure to water possible (rain shower)
- Two selectable MyModes
- Smart control via the Cockpit app for iPhone and Android devices
- Adjustment software with descriptive video tutorials (C-Soft Plus Plus version 1.6 and up)
- Connection to an osseointegrated, percutaneous implant system possible

Information material

647G1375=ALL_INT	IFU C-Leg (qualified personnel)
647H569-1=ALL_INT	IFU C-Leg (user)
647H569-2=ALL_INT	IFU C-Leg (user)

Scope of delivery

3C98-3/ 3C98-3=9.2	C-Leg 4	Pyramid	1 Piece
3C88-3/ 3C88-3=9.2	C-Leg 4	Threaded connector (alternative)	1 Piece
2R57/2R58	Tube adapter		1 Piece
2R67	Torsion adapter with tube	alternative	1 Piece
757L16-4	Power supply unit		1 Piece
4E50-2	Battery charger		1 Piece
4H95	C-Leg 8° flexion stop		1 Piece
646C107	Bluetooth PIN card Service		1 Piece
646H36=ALL_INT	Prosthesis passport		1 Piece



Technical data

Article image



Article number	3C98-3	3C98-3=9.2	3C88-3	3C88-3=9.2
Mobility grade	2, 3, 4	2, 3, 4	2, 3, 4	2, 3, 4
Proximal connection	Pyramid	Pyramid	Threaded connector	Threaded connector
Distal connection	Tube clamp	Tube clamp	Tube clamp	Tube clamp
Knee flexion angle	130 °	130 °	130 °	130 °
Moisture protection	Weatherproof	Weatherproof	Weatherproof	Weatherproof
Weight (without tube adapter)	1250 g	1250 g	1255 g	1255 g
Max. body weight	136 kg	136 kg	136 kg	136 kg
Colour	Volcano shadow	Desert pearl	Volcano shadow	Desert pearl
Proximal system height to alignment reference point	5 mm	5 mm	26 mm	26 mm
Minimum distal system height with 257/2R67 tube adapter	289 / 329 mm	289 / 329 mm	289 / 329 mm	289 / 329 mm
Max. distal system height with 257/2R67 tube adapter	494 / 534 mm	494 / 534 mm	494 / 534 mm	494 / 534 mm
Min. build height with 2R57/2R67 tube adapter	294 / 334 mm	294 / 334 mm	297 + 9° / 337 + 9° mm	297 + 9° / 337 + 9° mm
Max. build height with 2R57/2R67 tube adapter	499 / 539 mm	499 / 539 mm	502 + 9° / 542 + 9° mm	502 + 9° / 542 + 9° mm
Proximal build height to alignment reference point	23 mm	23 mm	26 + 9° mm	26 + 9° mm
Min. distal build height with 2R57/2R67 tube adapter	271 / 311 mm	271 / 311 mm	271 / 311 mm	271 / 311 mm
Max. distal build height with 2R57/2R67 tube adapter	476 / 516 mm	476 / 516 mm	476 / 516 mm	476 / 516 mm

* The thread length is 9 mm.

- The flexion stop reduces the knee flexion angle by 8° (pre-assembled) or 16°.
- Depending on the market, the C-Leg 4 is supplied with a 3/6-year guarantee or these guarantee packages are ordered separately.
- In case of connection to an implant system, verify that the manufacturer of the implant system and the manufacturers of the corresponding exoprosthesis components/adapters also permit this combination.

C-Leg

Mobility grade 2–4



Bluetooth

Integrated Bluetooth technology permits straightforward communication with the joint. An existing connection is displayed with an LED. Bluetooth can be disabled if necessary.

Knee angle sensor

The knee angle sensor measures the flexion angle and the angular velocity of the joint.

Inertial motion unit (IMU)

A gyroscope and acceleration sensors allow the C-Leg's spatial position and acceleration to be determined in real time. Control of the prosthesis is based on motion analysis and additional force determination.

Carbon fibre frame

In order to withstand the varied demands of everyday life, the frame is made from carbon – an especially strong, high-grade and lightweight material. The frame houses and protects the electronics, the hydraulics and the battery.

Battery and electronics

A lithium-ion battery provides the energy required to control the knee joint. It is located directly in the rotation axis of the C-Leg. We recommend charging the product once a day when used by the user on a daily basis. The integrated micro-processor coordinates all measurement and control processes.

Hydraulic unit

The hydraulic unit controls the C-Leg. It generates movement resistances for flexion and extension during the stance and swing phase.

Charging

The receptacle for the charger is located on the back of the joint and protected by a cover.

Knee joints

C-Leg

Accessories/spare parts for 3C88-3/3C98-3



Tube adapter

Reference number 2R57/2R58

The 2R57 and 2R58 tube adapters differ in length. They connect prosthetic components to each other. Adapter combinations allow for controlled angle and translational adaptation in the sagittal and frontal plane as well as adjustment of inward and outward rotation. The 2R57 and 2R58 are resistant to fresh, salt and chlorinated water.

Technical data

Article number	Diameter	Material	Min. system height	Max. system height	Weight	Max. body weight
2R57	34 mm	Titanium	77 mm	282 mm	220 g	150 kg
2R58	34 mm	Titanium	77 mm	472 mm	330 g	150 kg



Torsion adapter with tube

Reference number 2R67

The 2R67 torsion adapter minimises shear forces that occur between the residual limb and socket while walking, thereby improving wearer comfort. Individually adjustable torsion of max. 20° in any direction helps reduce compensating movements during tight turns in confined spaces, thereby counteracting the development of secondary damage.

Technical data

Article number	Diameter	Material	Min. system height	Max. system height	Weight	Max. body weight
2R67	34 mm	Steel, nickel-plated Titanium Aluminium	117 mm	322 mm	520 g	125 kg

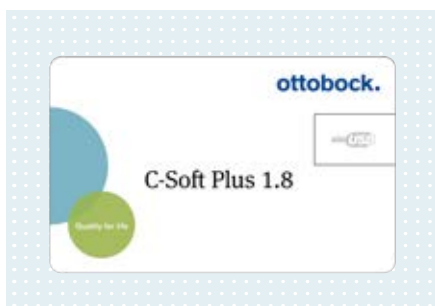

C-Soft Plus

Reference number 4X440

The adjustment software is used for the 3C98-3/3C88-3 C-Leg.

Technical data

Article number

4X440

To the download:





BionicLink PC

Reference number 60X5

The BionicLink USB Bluetooth adapter supports wireless data communication between Ottobock products with a Bluetooth interface and a PC with a USB port or USB hub via corresponding Ottobock software products.

Technical data

Article number	for
60X5	Connection to computer (USB Bluetooth adapter)



Power supply unit

Reference number 757L16-4

The power supply for electronic prosthetic components and orthoses from Ottobock. Adapters for the EU and US are included in the scope of delivery. Additional adapters can be ordered under the following article numbers:

- Great Britain: 757S1=GB-4
- Australia: 757S1=AUS-4
- Argentina: 757S1=ARG-4

Technical data

Article number
757L16-4



Battery charger

Reference number 4E50-2

For the C-Brace® orthotronic mobility system, the C-Leg knee joint and the Meridium prosthetic foot.

Technical data

Article number
4E50-2



USB Adapter for charging

Reference number 757L43

For use with all Ottobock mechatronic knee joints (Genium/Genium X3, C-Leg, Kenevo), C-Brace, Meridium and the MyoBock prosthetic solution including the bebionic prosthetic hand.

Technical data

Article number
757L43

Knee joints

C-Leg



Knee extender

Reference number 4H105

The knee extender is mandatory for bench alignment of the prosthesis. It ensures the recommended sagittal positioning of the prosthetic components – the foot, socket and knee joint – relative to each other and thereby guarantees the full functionality of the C-Leg.

Technical data

Article number

4H105



C-Leg 16° flexion stop

Reference number 4H106

The C-Leg 16° flexion stop reduces the knee flexion angle to 114°. It serves to prevent collisions between the socket and hydraulics or frame of the C-Leg.

Technical data

Article number

4H106



Charger extension cable, ankle

Reference number 4X156

Charger extension cable for relocating the charging receptacle to the ankle, cable length is 30 cm.

Technical data

Article number

4X156



Charger extension cable, knee

Reference number 4X157

Charger extension cable for relocating the charging receptacle to the knee area. Especially well suited when using the functional cosmesis for the C-Leg.

Technical data

Article number

4X157



Charger extension cable, ankle, long

Reference number 4X158

Charger extension cable for relocating the charging receptacle to the ankle, cable length is 80 cm.

Technical data

Article number

4X158



C-Leg Protective Cover (without shield insert)

Reference number 4X860

The C-Leg Protective Cover shields the prosthetic knee joint including tube adapter against impacts, environmental influences and wear and tear. The product 4X860 includes the main Protective Cover component and Protector foot cuff. The main component can be shortened. The 4P863 shield insert shown in the illustration has to be ordered separately. It is available in three different designs.

Technical data

Article number	Size (including cuff)	Weight (Protective Cover including closures)	Weight (cuff)	Colour
4X860=S	S	450 g	60 g	champagne
4X860=S-8.4	S	450 g	60 g	dark volcano
4X860=M	M	450 g	60 g	champagne
4X860=M-8.4	M	450 g	60 g	dark volcano
4X860=L	L	450 g	60 g	champagne
4X860=L-8.4	L	450 g	60 g	dark volcano



Guard for C-Leg

Reference number 4P862

The guard functionally and visually sheaths the C-Leg 4. In the covered area, the guard protects the knee joint, for example against scratching. The guard can be combined with the 4P863 shield insert.

Technical data

Article number	Weight
4P862	225 g



Shield insert

Reference number 4P863

The shield insert is part of the prescribed accessories for the 4X860 C-Leg Protective Cover. It is inserted into the main part of the Protective Cover from the front. Optionally, it can also be used with the 4P862 guard for the C-Leg. The shield insert is available in three different designs.

Technical data

Article image



Article number	4P863=1	4P863=2	4P863=3
Weight	63 g	63 g	63 g

Knee joints

C-Leg

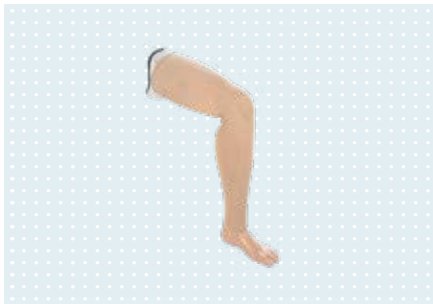

Functional cosmesis C-Leg

Reference number 3F1=1

The functional cosmesis essentially consists of a functional knee part, an individually mouldable functional shank made of foam and a functional stocking that forms the exterior finish of the functional cosmesis. The illustration shows the complete solution. The functional stocking has to be ordered separately (see reference number 99B120).

Technical data

Article number	Weight
3F1=1	910 g



Functional stocking for functional cosmesis

Reference number 99B120

The easy-care functional stocking forms the exterior finish of the functional cosmesis. It features natural shading and various function zones. Compatible with 3F1=1 and 3F1=2. Available in three colours (beige, light brown, black) and two sizes (S, L).

Technical data

Article number	For size	Colour Code
99B120=S-4	S	4
99B120=L-4	L	4
99B120=S-7	S	7
99B120=L-7	L	7
99B120=S-15	S	15
99B120=L-15	L	15



Foam cover

Reference number 3S26

The 3S26 covers for modular transfemoral prostheses restore the natural leg volume. They have a stepped centre hole and are partly anatomically pre-shaped.

Technical data

Article number	Material	Calf circumference	Knee flexion	Side	Length
3S26=L44	PUR	44 cm	20 °	left	approx. 95 cm
3S26=R44	PUR	44 cm	20 °	right	approx. 95 cm



Cockpit app

Reference number 4X441-*

The Cockpit app allows users to easily adjust various Ottobock electronic prostheses and orthoses to their individual needs in day-to-day life. Depending on the component's range of functions one can, for example, select preconfigured MyModes for specific activities, read information such as the battery charge level, turn additional functions on or off and adjust settings. The Cockpit app is available in the App Store for iPhones and the Google Play Store for Android devices.

Technical data

Article number
4X441-*

Compatible prosthetic components

Liner	 6Y110	 6Y81	 6Y400	 6Y700	 6Y85	 6Y88	 6Y200				
Suspension	 21Y21	 452A1		 4R152	 4R160		 5A60				
Adapters	 4R43	 4R89	 4R41	 4R111=N	 4R116	 4R111	 4R119=N	 4R117	 4R119		
Prosthetic foot	 1A1-1 Empower	 1A30 Greissinger plus	 1B1-2 Meridium	 1C10 Terion	 1C11 Terion K2	 1C30 Trias	 1C40 C-Walk				
	 1C50 Taleo	 1C51 Taleo Vertical Shock		 1C52 Taleo Harmony		 1C53 Taleo Low Profile		 1C60 Triton			
	 1C61 Triton Vertical Shock		 1C62 Harmony Triton		 1C63 Triton Low Profile		 1C64 Triton Heavy Duty		 1C68 Triton side flex		
	 1D10 Dynamic foot with adapter		 1D11 Dynamic foot		 1D35 Dynamic Motion		 1E56 Axtion		 1E57 Lo Rider		 1M10 Adjust

i Please note that the instructions for use are authoritative regarding the compatibility of individual components.

Knee joints

Genium



Genium

Reference number 3B1-3

The mechatronic knee joint with OPG technology that was recently upgraded nearly replicates the natural, physiological gait pattern. It enables climbing stairs step-over-step, standing on slopes and walking backwards and lets the user negotiate obstacles with ease.

Key features

- Enhanced safety by reliably triggering the swing phase with adequate ground clearance, even on challenging terrain
- Stumble recovery Plus active at all times
- Saves energy when walking, also on slopes and uneven ground
- Proven safe backward walking
- Climbing stairs step-over-step and crossing obstacles naturally
- Walking speed can be varied up to running pace with the Walk-to-Run feature
- Choice between intuitive and deliberate stance for increased stability and comfort
- Weatherproof (IP67), making activities with occasional exposure to water possible (rain shower)
- Five MyModes can be selected from millions of adjustment possibilities
- Smart control via the Cockpit app for iPhone and Android devices
- Adjustment software with descriptive video tutorials (X-Soft version 1.8 and up)
- Connection to an osseointegrated, percutaneous implant system possible

Information material

647G1380=ALL_INT	IFU Genium (qualified personnel)
647H45-1=ALL_INT	IFU Genium (user)
647H45-2=ALL_INT	IFU Genium (user)

Scope of delivery

3B1-3	Genium	Pyramid	1 Piece
3B1-3=ST	Genium	Threaded connector (alternative)	1 Piece
2R20	AXON tube adapter		1 Piece
2R21	AXON tube adapter	alternative	1 Piece
757L16-4	Power supply unit		1 Piece
4E60	Inductive charger		1 Piece
4X259	Installation ring for inductive charger		1 Piece
4H100	Genium flexion stop 15°		1 Piece
4H103	Genium 22.5° flexion stop	already assembled when delivered	1 Piece
501S137=M3X5	Counter-sunk head Torx screw	as replacement for the already mounted screws of the flexion stop	2 Piece
646C107	Bluetooth PIN card Service		1 Piece
646H36=ALL_INT	Prosthesis passport		1 Piece



Max. 150 kg

Technical data

Article image



	3B1-3	3B1-3=ST
Article number	3B1-3	3B1-3=ST
Mobility grade	2, 3, 4	2, 3, 4
Proximal connection	Pyramid	Threaded connector
Distal connection	Tube clamp	Tube clamp
Knee flexion angle	135°	135°
Moisture protection	IP67 (weatherproof)	IP67 (weatherproof)
Weight (without tube adapter)	1395 g	1400 g
Max. body weight	150 kg	150 kg
Proximal system height to alignment reference point	0 mm	18 mm
Min. distal system height with 2R20/2R21 AXON tube adapter	298 / 330 mm	298 / 330 mm
Max. distal system height with 2R20/2R21 AXON tube adapter	514 / 546 mm	514 / 546 mm
Min. build height with 2R20/2R21 AXON tube adapter	298 / 330 mm	298 + 9* / 330 + 9* mm
Max. build height with 2R20/2R21 AXON tube adapter	514 / 546 mm	514 + 9* / 546 + 9* mm
Proximal build height to alignment reference point	18 mm	18 + 9* mm
Min. distal build height with 2R20/2R21 AXON tube adapter	280 / 312 mm	280 / 312 mm
Max. distal build height with 2R20/2R21 AXON tube adapter	496 / 528 mm	496 / 528 mm

* The thread length is 9 mm.

- The flexion stop reduces the knee flexion angle by 7.5°, 15° or 22.5° (pre-assembled).
- Depending on the market, the Genium is supplied with a 3/6-year guarantee or these guarantee packages are ordered separately.
- In case of connection to an implant system, verify that the manufacturer of the implant system and the manufacturers of the corresponding exoprosthetic components/adapters also permit this combination.

Genium

Mobility grade 2–4



Knee joints

Genium

Accessories/spare parts for 3B1-3



AXON tube adapter

Reference number 2R20

The tube adapter is supplied in a standard length of 515 mm and is cut to length by the O&P professional with a pipe cutter. The correct length of the tube adapter is determined using the adjustment software.

Technical data

Article number	Diameter	Material	Weight	Max. body weight
2R20	34 mm	Aluminium	290 g	150 kg



AXON tube adapter with torsion unit

Reference number 2R21

The tube adapter is supplied in a standard length of 515 mm and is cut to length by the O&P professional with a pipe cutter. The correct length of the tube adapter is determined using the adjustment software.

Technical data

Article number	Diameter	Material	Weight	Max. body weight
2R21	34 mm	Aluminium	530 g	125 kg



X-Soft

Reference number 4X1

Computer-assisted alignment (CAA) allows you to fully utilise the functions of the system in the course of prosthetic alignment. The X-Soft software calculates and visualises the forces acting on the prosthesis, offering individual recommendations for the custom positioning of the prosthetic components. This ensures ultimate individuality.

Technical data

Article number

4X1

To the download:



BionicLink PC

Reference number 60X5

The BionicLink USB Bluetooth adapter supports wireless data communication between Ottobock products with a Bluetooth interface and a PC with a USB port or USB hub via corresponding Ottobock software products.

Technical data

Article number	for
60X5	Connection to computer (USB Bluetooth adapter)



Power supply unit

Reference number 757L16-4

The power supply for electronic prosthetic components and orthoses from Ottobock. Adapters for the EU and US are included in the scope of delivery. Additional adapters can be ordered under the following article numbers:

- Great Britain: 757S1=GB-4
- Australia: 757S1=AUS-4
- Argentina: 757S1=ARG-4

Technical data

Article number

757L16-4



Inductive charger

Reference number 4E60

The inductive charger is magnetically attached to the back of the prosthetic knee joint. This technology allows charging through clothing and cosmetic covers.

Technical data

Article number

4E60



USB Adapter for charging

Reference number 757L43

For use with all Ottobock mechatronic knee joints (Genium/Genium X3, C-Leg, Kenevo), C-Brace, Meridium and the MyoBock prosthetic solution including the bebionic prosthetic hand.

Technical data

Article number

757L43



Installation tool for inductive charger

Reference number 4X258

The tool is used to install the inductive charger on the Genium/Genium X3 when the charging surface is repositioned (for example when using a foam cover).

Technical data

Article number

4X258

Knee joints

Genium



Installation ring for inductive charger

Reference number 4X259

The installation ring is used for shifting the inductive charging surface of the Genium/Genium X3 (for example when using a foam cover).

Technical data

Article number

4X259



Genium 7.5° flexion stop

Reference number 4H99

The Genium 7.5° flexion stop reduces the knee flexion angle to 127.5°. It is used to prevent collisions between the socket and hydraulics or frame of the Genium.

Technical data

Article number

4H99



Genium 15° flexion stop

Reference number 4H100

The Genium 15° flexion stop reduces the knee flexion angle to 120°. It is used to prevent collisions between the socket and hydraulics or frame of the Genium.

Technical data

Article number

4H100



Genium 22.5° flexion stop

Reference number 4H103

The Genium 22.5° flexion stop reduces the knee flexion angle to 112.5°. It is used to prevent collisions between the socket and hydraulics or frame of the Genium.

Technical data

Article number

4H103



Genium Protective Cover

Reference number 4X880

The Genium Protective Cover shields the prosthetic knee joint with tube adapter against impacts, environmental influences and wear and tear. The product 4X880 includes the main Protective Cover component and Protector foot cuff. The main component can be shortened and adapted to the prosthesis.

Technical data

Article number	Weight (Protective Cover including closures)	Weight (cuff)	Size (including cuff)
4X880=S	450 g	60 g	S
4X880=M	450 g	60 g	M
4X880=L	450 g	60 g	L



Foam cover

Reference number 3S26

The 3S26 covers for modular transfemoral prostheses restore the natural leg volume. They have a stepped centre hole and are partly anatomically pre-shaped.

Technical data

Article number	Material	Calf circumference	Knee flexion	Side	Length
3S26=L44	PUR	44 cm	20 °	left	approx. 95 cm
3S26=R44	PUR	44 cm	20 °	right	approx. 95 cm

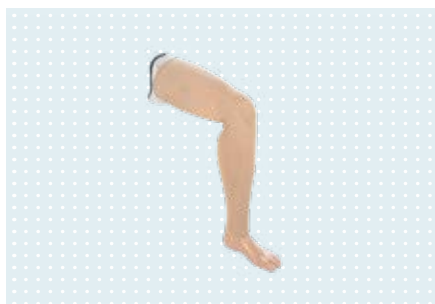

Functional cosmesis Genium

Reference number 3F1=2

The functional cosmesis essentially consists of a functional knee part, an individually mouldable functional shank made of foam and a functional stocking that forms the exterior finish of the functional cosmesis. The illustration shows the complete solution. The functional stocking has to be ordered separately (see reference number 99B120).

Technical data

Article number	Weight
3F1=2	910 g

Knee joints

Genium



Functional stocking for functional cosmesis

Reference number 99B120

The easy-care functional stocking forms the exterior finish of the functional cosmesis. It features natural shading and various function zones. Compatible with 3F1=1 and 3F1=2. Available in three colours (beige, light brown, black) and two sizes (S, L).

Technical data

Article number	For size	Colour Code
99B120=S-4	S	4
99B120=L-4	L	4
99B120=S-7	S	7
99B120=L-7	L	7
99B120=S-15	S	15
99B120=L-15	L	15



Cockpit app

Reference number 4X441-*

The Cockpit app allows users to easily adjust various Ottobock electronic prostheses and orthoses to their individual needs in day-to-day life. Depending on the component's range of functions one can, for example, select preconfigured MyModes for specific activities, read information such as the battery charge level, turn additional functions on or off and adjust settings. The Cockpit app is available in the App Store for iPhones and the Google Play Store for Android devices.

Technical data

Article number
4X441-*

Compatible prosthetic components

Liner	 6Y110	 6Y81	 6Y400	 6Y700	 6Y85	 6Y88	 6Y200
Suspension	 21Y21	 452A1	 4R152	 4R160	 5A60		
Adapters	 4R43	 4R89	 4R41	 4R111=N	 4R116	 4R111	 4R119=N
	 4R117	 4R119	 5R2	 4R77	 4R55	 4R40	 4R72
	 4R76	 4R78	 4R104	 4R57	 4R57=ST	 4R10=111	
Prosthetic foot	 1A1-1 Empower	 1B1-2 Meridium	 1C30 Trias	 1C40 C-Walk	 1C50 Taleo	 1C51 Taleo Vertical Shock	 1C52 Taleo Harmony
	 1C53 Taleo Low Profile	 1C60 Triton	 1C61 Triton Vertical Shock	 1C62 Harmony Triton	 1C63 Triton Low Profile	 1C64 Triton Heavy Duty	 1C68 Triton side flex
	 1D35 Dynamic Motion	 1E56 Axtion	 1E57 Lo Rider	 1E95 Challenger	 1M10 Adjust		

i Please note that the instructions for use are authoritative regarding the compatibility of individual components.

Knee joints

Genium X3



Genium X3

Reference number 3B5-3

The technology of the Genium allows intuitive and natural movements, even when walking backwards, climbing stairs step-over-step or walking at various speeds. The Genium X3 is robust, waterproof and corrosion-resistant.

Key features

- Enhanced safety by reliably triggering the swing phase with adequate ground clearance, even on challenging terrain
- Stumble recovery Plus active at all times
- Saves energy when walking, also on slopes and uneven ground
- Proven safe backward walking
- Climbing stairs step-over-step and crossing obstacles naturally
- Walking speed can be varied up to running pace with the Walk-to-Run feature
- Choice between intuitive and deliberate stance for increased stability and comfort
- Robust and durable
- Waterproof and corrosion-resistant (IP68): full functionality during activities in fresh, chlorinated and sea water
- Selection of five MyModes including activities with water exposure
- Smart control via the Cockpit app for iPhone and Android devices
- Adjustment software with descriptive video tutorials (X-Soft version 1.8 and up)
- Connection to an osseointegrated, percutaneous implant system possible

Information material

647G1374=ALL_INT	IFU Genium X3 (qualified personnel)
647H47-1=ALL_INT	IFU Genium X3 (user)
647H47-2=ALL_INT	IFU Genium X3 (user)

Scope of delivery

3B5-3	Genium X3	Pyramid	1	Piece
3B5-3=ST	Genium X3	Threaded connector (alternative)	1	Piece
4X900	Genium X3 Protective Cover	already mounted	1	Piece
4X193-1	Genium X3 Protective Cover	already mounted (alternative)	1	Piece
2R19	AXON tube adapter		1	Piece
757L16-4	Power supply unit		1	Piece
4E60	Inductive charger		1	Piece
4H102	Genium X3 15° flexion stop		1	Piece
4H104	Genium X3 22.5° flexion stop	already assembled when delivered	1	Piece
501S137=M3X5	Countersunk head Torx screw	as replacement for the already mounted screws of the flexion stop	2	Piece
646C107	Bluetooth PIN card Service		1	Piece
646H36=ALL_INT	Prosthesis passport		1	Piece



Max. 125 kg

Technical data

Article image



Article number	3B5-3	3B5-3=ST
Mobility grade	3, 4	3, 4
Proximal connection	Pyramid	Threaded connector
Distal connection	Tube clamp	Tube clamp
Knee flexion angle	135 °	135 °
Moisture protection	IP68 (waterproof and corrosion-resistant)	IP68 (waterproof and corrosion-resistant)
Weight (without tube adapter)	1710 g	1710 g
Max. body weight	125 kg	125 kg
Proximal system height to alignment reference point	0 mm	18 mm
Minimum distal system height with AXON 2R19 tube adapter	298 mm	298 mm
Max. distal system height with 2R19 AXON tube adapter	514 mm	514 mm
Min. build height with 2R19 AXON tube adapter	298 mm	298 + 9* mm
Max. build height with 2R19 AXON tube adapter	514 mm	514 + 9* mm
Proximal build height to alignment reference point	18 mm	18 + 9* mm
Min. distal build height with 2R19 AXON tube adapter	280 mm	280 mm
Max. distal build height with 2R19 AXON tube adapter	496 mm	496 mm

* The thread length is 9 mm.

- The flexion stop reduces the knee flexion angle by 7.5°, 15° or 22.5° (pre-assembled).
- Depending on the market, the Genium X3 is supplied with a 3/6-year guarantee or these guarantee packages are ordered separately.
- In case of connection to an implant system, verify that the manufacturer of the implant system and the manufacturers of the corresponding exoprosthetic components/adapters also permit this combination.

Genium X3

Mobility grade 3–4



Battery and electronics

The Genium X3's rechargeable battery and electronics are enclosed and protected by the frame and Protective Cover. An integrated microprocessor coordinates all measurement and control processes.

Robust Protective Cover

The robust Protective Cover effectively protects the prosthesis against numerous everyday stresses. In addition to water, dust and dirt, this includes protection against impacts.

Knee moment sensor

The knee moment sensor supplies data about the knee moments that occur: this important information makes it possible to precisely determine the forces acting on the prosthesis.

Intelligent AXON tube adapter

The AXON tube adapter measures the ankle moment and the vertical force acting on the joint in real time. The AXON tube adapter can be connected to a foot without a connecting piece.

Inertial motion unit (IMU)

Prosthesis control is based on motion analysis and additional force measurement. To this end, sensors determine the position and acceleration of the Genium X3 leg prosthesis as well as the flexion angle and flexion angle speed in real time.

Hydraulic unit

The hydraulic unit controls the Genium X3. The flexion and extension resistances are controlled independently by means of two control valves.

Waterproof and corrosion-resistant

The IP rating 68 means protection against the ingress of liquids and solids such as dust and dirt. The Genium X3 is not only waterproof but also fully functional underwater and is protected against strong jets of water. A corrosion-resistant coating makes it easy to enjoy activities in fresh, chlorinated and salt water.

Inductive charging

The inductive charger is magnetically attached to the back of the prosthetic knee joint. This technology allows charging through clothing and cosmetic covers.

Carbon fibre frame

In order to withstand the varied demands of everyday life, the frame is made from carbon – an especially strong, high-grade and lightweight material.

Knee joints

Genium X3

Accessories/spare parts for 3B5-3



AXON tube adapter

Reference number 2R19

The corrosion-resistant tube adapter is supplied in a standard length of 515 mm and is cut to length by the O&P professional with a pipe cutter. The correct length of the tube adapter is determined using the X-Soft adjustment software.

Technical data

Article number	Moisture protection	Diameter	Weight	Max. body weight
2R19	IPX7 (DIN EN 60529)	34 mm	290 g	150 kg

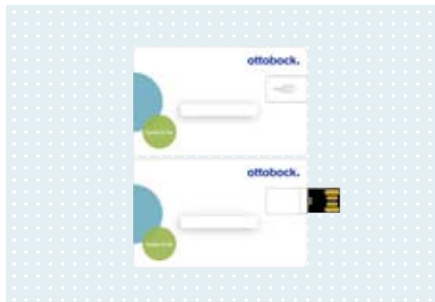

X-Soft

Reference number 4X1

Computer-assisted alignment (CAA) allows you to fully utilise the functions of the system in the course of prosthetic alignment. The X-Soft software calculates and visualises the forces acting on the prosthesis, offering individual recommendations for the custom positioning of the prosthetic components. This ensures ultimate individuality.

Technical data

Article number
4X1

To the download:



BionicLink PC

Reference number 60X5

The BionicLink USB Bluetooth adapter supports wireless data communication between Ottobock products with a Bluetooth interface and a PC with a USB port or USB hub via corresponding Ottobock software products.

Technical data

Article number	for
60X5	Connection to computer (USB Bluetooth adapter)



Power supply unit

Reference number 757L16-4

The power supply for electronic prosthetic components and orthoses from Ottobock. Adapters for the EU and US are included in the scope of delivery. Additional adapters can be ordered under the following article numbers:

- Great Britain: 757S1=GB-4
- Australia: 757S1=AUS-4
- Argentina: 757S1=ARG-4

Technical data

Article number

757L16-4



Inductive charger

Reference number 4E60

The inductive charger is magnetically attached to the back of the prosthetic knee joint. This technology allows charging through clothing and cosmetic covers.

Technical data

Article number

4E60



USB Adapter for charging

Reference number 757L43

For use with all Ottobock mechatronic knee joints (Genium/Genium X3, C-Leg, Kenevo), C-Brace, Meridium and the MyoBock prosthetic solution including the bebionic prosthetic hand.

Technical data

Article number

757L43



Genium X3 7.5° flexion stop

Reference number 4H101

The Genium X3 7.5° flexion stop reduces the knee flexion angle to 127.5°. It is used to prevent collisions between the socket and hydraulics or frame of the Genium X3.

Technical data

Article number

4H101



Genium X3 15° flexion stop

Reference number 4H102

The Genium X3 15° flexion stop reduces the knee flexion angle to 120°. It is used to prevent collisions between the socket and hydraulics or frame of the Genium X3.

Technical data

Article number

4H102

Knee joints

Genium X3



Genium X3 22.5° flexion stop

Reference number 4H104

The Genium X3 22.5° flexion stop reduces the knee flexion angle to 112.5°. It is used to prevent collisions between the socket and hydraulics or frame of the Genium X3.

Technical data

Article number

4H104



Genium X3 Protective Cover

Reference number 4X193-1

To protect against the many stresses of everyday life, the Protective Cover made from a durable PU material covers the knee joint. As a result, the Genium X3 easily stands up to even tough conditions. The Protective Cover also features an expressive, sporty design. Alternatively, the 4X900 Protective Cover can be chosen.

Technical data

Article number

4X193-1

Weight

300 g



Genium X3 Protective Cover

Reference number 4X900

To protect against the many stresses of everyday life, the Protective Cover made from a durable PU material covers the knee joint. As a result, the Genium X3 easily stands up to even tough conditions. The Protective Cover also features a discreet, elegant design. Alternatively, the 4X193-1 Protective Cover can be chosen.

Technical data

Article number

4X900

Weight

315 g



Cockpit app

Reference number 4X441-*

The Cockpit app allows users to easily adjust various Ottobock electronic prostheses and orthoses to their individual needs in day-to-day life. Depending on the component's range of functions one can, for example, select preconfigured MyModes for specific activities, read information such as the battery charge level, turn additional functions on or off and adjust settings. The Cockpit app is available in the App Store for iPhones and the Google Play Store for Android devices.

Technical data

Article number

4X441-*

Compatible prosthetic components

Liner	 6Y110	 6Y81	 6Y400	 6Y700	 6Y85	 6Y88	 6Y200
Suspension	 21Y21	 452A1		 4R152	 4R160	 5A60	
Adapters	 4R43	 4R89	 4R41	 4R111=T	 4R116=T	 4R119=NT	 4R117=T
 4R119=T	 5R2	 4R77	 4R55	 4R40	 4R72	 4R76	
 4R78	 4R104	 4R57=WR	 4R57=WR-ST	 4R10=111			
Prosthetic foot	 1A1-1 Empower	 1B1-2 Meridium	 1C30 Trias	 1C40 C-Walk	 1C50 Taleo	 1C51 Taleo Vertical Shock	
 1C52 Taleo Harmony	 1C53 Taleo Low Profile	 1C60 Triton	 1C61 Triton Vertical Shock	 1C62 Harmony Triton	 1C63 Triton Low Profile		
 1C64 Triton Heavy Duty	 1C68 Triton side flex	 1D35 Dynamic Motion		 1E56 Axtion	 1E57 Lo Rider	 1E95 Challenger	

i Please note that the instructions for use are authoritative regarding the compatibility of individual components.



Hip joints



Hip joints

Modular hip joints



Hip joint, monocentric, with inner extension assist

Reference number 7E7

The top of the prosthetic hip joint is screwed to the lamination plate laminated into the pelvic socket, and the bottom is connected with a tube clamp. The continuously variable extension assist limits the range of motion during walking. The prosthetic joint features a low structural height which minimises pelvic tilt while sitting.



Max. 100 kg

Information material

647G130=ALL_INT IFU 7E7

Scope of delivery

7E7		1 Piece
7Z53	Lamination plate	1 Piece
7Z58	Lamination dummy	1 Piece
709Z11	Bit T40	1 Piece

Technical data

Article number	7E7
Max. body weight	100 kg
Mobility grade	2, 3
Weight	620 g
Proximal connection	Lamination plate
Distal connection	Tube Ø 30 mm
Range	140 °
Min. system height	33 mm
Max. system height	360 mm
Min. build height	60 mm



Monocentric hip joint with hydraulic control

Reference number 7E9

The high-performance mini hydraulics form the centrepiece of the 7E9 hip joint, smoothly damping joint movements in both the swing and the stance phase. The result is a gait pattern for the prosthesis wearer that comes closer to the physiological model. In combination with the Genium and C-Leg microprocessor knees, the 7E9 delivers optimal treatment results. A prosthesis with the 3R60 mechanical knee joint is possible as well. Due to the numerous combination possibilities and high patient weight limit of 125 kg, the hip joint is suitable for a large group of users with hip disarticulation or hemipelvectomy.



Max. 125 kg

Information material

647G774=ALL_INT IFU 7E9

Scope of delivery

7E9		1	Piece
7Z53	Lamination plate	1	Piece
7Z53	Lamination plate	1	Piece
7Z63	Lamination dummy	1	Piece
709Z11	Bit T40	1	Piece

Technical data

Article number	7E9
Max. body weight	125 kg
Mobility grade	2, 3
Weight	695 g
Proximal connection	Lamination anchor
Distal connection	Pyramid
Range	130 °
System height	82 mm
Build height	100 mm
Material	Aluminium

Hip joints

Helix3D hip joint system



Helix3D prosthetic hip joint

Reference number 7E10

The Helix3D hip joint sets standards for enhanced safety, dynamics and comfort. For example, its patented multi-axis joint structure results in three-dimensional hip movement and promotes a natural gait. The Helix3D is approved exclusively in combination with the C-Leg® and Genium knee joints.



Max. 100 kg

Information material

647G387=ALL_INT IFU 7E10

Scope of delivery

7E10	Helix3D	1 Piece
7Z53	Lamination plate	1 Piece
709Z11	Bit T40	1 Piece
7Z63	Lamination dummy	1 Piece

Technical data

	7E10=L	7E10=R
Article number	7E10=L	7E10=R
Max. body weight	100 kg	100 kg
Mobility grade	2, 3	2, 3
Weight	990 g	990 g
Proximal connection	Lamination plate	Lamination plate
Distal connection	Pyramid	Pyramid
Range	130 °	130 °
System height	146 mm	146 mm
Build height	164 mm	164 mm
Side	left (L)	right (R)



reddot design award
winner 2008

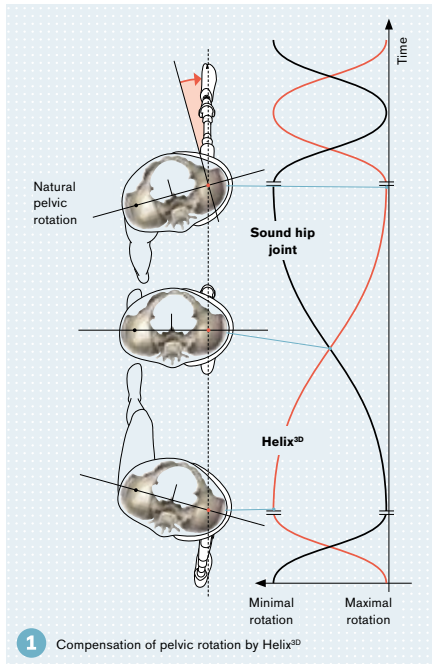

The patented multi-axis joint structure

- Produces a three-dimensional hip movement to compensate for pelvic rotation and promotes a symmetrical and natural gait pattern. (Fig. 1)
- Permits shortening of the leg in the swing phase with the objective of reducing the risk of falling, thereby improving functional safety.
- Ensures optimal sitting characteristics and reduces pelvic obliquity to a minimum.
- Permits a large flexion angle to provide relief in everyday situations such as putting on shoes or getting into a car.



The spring-hydraulics combination

- Supports swing initiation by the prosthesis wearer with integrated expansion springs. Energy stored in the stance phase is used to compensate for the missing hip musculature during swing initiation and reduce the energy expended while walking. (Fig. 2)
- Controls the 3D movement during the entire gait cycle.
- Allows for dampened, controlled heel strike in the stance phase with significantly reduced hyperlordosis as well as smooth extension of the hip joint. Controlled and smooth rollover on the prosthesis under full load becomes possible.
- Allows for an individual stride length setting and makes it possible to control the pendulum motion in the swing phase.

Hip joints

Accessories/spare parts for 7E7, 7E9, 7E10



Single component pack

Reference number 7D2

The single component pack consists of spare parts for the 7E7 modular hip joint.

Technical data

Article number

7D2

Components

Tappet	1	Piece
Guide sleeve	1	Piece
Bumper	1	Piece
Lock pin	1	Piece
Safety plate	1	Piece
Slotted oval countersunk head screw	1	Piece
Cap screw (Allen screw)	1	Piece
Extension assist spring	1	Piece
Cap screw	2	Piece
Cap screw	1	Piece



Lamination plate

Reference number 7Z53

The lamination plate serves as the proximal connection for the 7E7, 7E9 and 7E10 hip joints.

Technical data

Article number	Max. body weight	Material
7Z53	100 kg	Aluminium
7Z53=1-M10	125 kg	Steel



Tube clamp adapter, angled

Reference number 4R56

The 4R56 tube clamp adapter is used in prostheses in combination with a hip joint. It is available with three different angles and, among other things, connects the 7E10 Helix 3D hip joint to the 2R30 tube, and this to the 4R57 rotation adapter or a knee joint.

Technical data

Article image



Article number	4R56	4R56=1	4R56=2
Diameter	30 mm	30 mm	30 mm
Material	Titanium	Titanium	Titanium
System height	34 mm	34 mm	35 mm
Build height	54 mm	54 mm	55 mm
Weight	85 g	85 g	100 g
Angular offset	10 °	20 °	30 °
Max. body weight	100 kg	100 kg	100 kg



Tube clamp adapter, angled

Reference number 4R156

The adapter is available with three different angles. Due to its high load-bearing capacity, it is preferable for use in combination with the 7E9 prosthetic hip joint. In this case, the adapter is intended for the adjustable proximal connection of the prosthetic hip joint to the 2R36 thigh tube and for the adjustable distal connection of the 2R36 thigh tube to the pyramid of the prosthetic knee joint or the 4R57 rotation adapter.

Technical data

Article image



Article number	4R156	4R156=1	4R156=2
Diameter	34 mm	34 mm	34 mm
Material	Titanium	Titanium	Titanium
System height	36 mm	37 mm	38 mm
Build height	50 mm	50 mm	51 mm
Weight	145 g	175 g	185 g
Angular offset	10 °	20 °	30 °
Max. body weight	150 kg	150 kg	150 kg

Hip joints

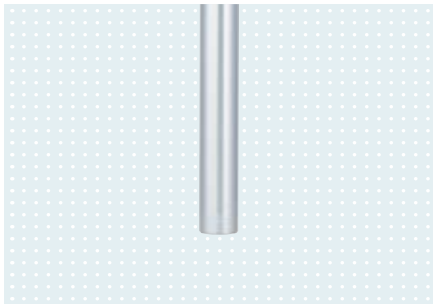

Light metal tube

Reference number 2R30

The 2R30 Light metal tube is used in fittings with a prosthetic hip joint. It serves as the connection between two tube clamp adapters, e.g. the 4R52 or 4R56.

Technical data

Article number	Diameter	Material	Min. system height	Max. system height	Min. build height	Overall length	Weight	Max. body weight
2R30	30 mm	Aluminium	69 mm	400 mm	10 mm	400 mm	200 g	100 kg

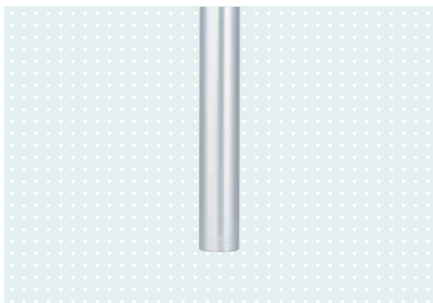

Light metal tube

Reference number 2R36

The 2R36 Light metal tube is used in treatments with a prosthetic hip joint. It serves as the connection between two tube clamp adapters, e.g. the 4R82 or 4R156.

Technical data

Article number	Diameter	Material	Min. system height	Max. system height	Min. build height	Overall length	Weight	Max. body weight
2R36	34 mm	Aluminium	73 mm	380 mm	10 mm	380 mm	215 g	125 kg



Option set for modular hip disarticulation prostheses

Reference number 4R32

The accessory set is used in combination with a foam cover to restore the natural leg volume with modular hip disarticulation prostheses. It is part of a connection cover, which is individually fabricated, glued into the foam cover and attached to the socket using the elastic strap.

Technical data

Components	
Distal Anchor Wedge	2 Piece
Distal anchor ring	2 Piece
Perlon cosmetic stockings, long	1 Pair
ThermoLyn trolene	1 Piece
Ring	2 Piece
Harness strap	1 Piece
Elastic strap	1 Piece

Article number

4R32



Reference determination tool

Reference number 743A29

The reference determination tool is used to determine the pelvic socket reference line.

Technical data

Article number

743A29





Socket technologies

Socket technologies

Skeo liner



Skeo

Reference number 6Y42

The distal matrix of the Skeo liner has a length of 10 cm and prevents lengthwise stretching. It gives the user good control over the prosthesis and a high level of safety. At the same time, the Skeo lower leg liner easily adapts to slight fluctuations in volume thanks to its transverse elasticity. The 6Y42 Skeo (TT) can be combined with a shuttle lock.

Information material

647G380=ALL_INT IFU Liners (qualified personnel)

Technical data

Article number	Size
6Y42=180	180 mm
6Y42=200	200 mm
6Y42=210	210 mm
6Y42=220	220 mm
6Y42=235	235 mm
6Y42=250	250 mm
6Y42=265	265 mm
6Y42=265	265 mm
6Y42=280	280 mm
6Y42=300	300 mm
6Y42=320	320 mm
6Y42=340	340 mm
6Y42=360	360 mm
6Y42=360	360 mm
6Y42=380	380 mm
6Y42=400	400 mm
6Y42=420	420 mm
6Y42=450	450 mm

Amputation level	Transtibial amputation
Material	Silicone
Connection	With distal connection
Distal cushion	13.5 mm
Wall thickness	from approx. 4.5 mm distally, tapering to 2.5 mm proximally
Textile cover	with
Colour	Light grey
Exterior coating	without
Socket design	Specific weight-bearing socket
Matrix	10 cm length
Skinguard	without



Skeo Pure

Reference number 6Y41

The difference is clear. Thanks to its transparency, the Skeo Pure makes it easier to visually check the fit and skin condition, for example in case of interim fittings. The silky-smooth exterior dries quickly and makes it simple to put on and take off the prosthesis without donning spray.

The 6Y41 Skeo Pure (TT) can be combined with a valve.

Information material

647G380=ALL_INT

IFU Liners (qualified personnel)

Technical data

Article number	Size	Wall thickness
6Y41=160	160 mm	3 mm
6Y41=180	180 mm	3 mm
6Y41=200	200 mm	3 mm
6Y41=220	220 mm	3 mm
6Y41=235	235 mm	3 mm
6Y41=250	250 mm	3 mm
6Y41=265	265 mm	3 mm
6Y41=280	280 mm	3 mm
6Y41=300	300 mm	3 mm
6Y41=320	320 mm	3 mm
6Y41=340	340 mm	3 mm
6Y41=360	360 mm	3 mm
6Y41=400	400 mm	3 mm
6Y41=160-6	160 mm	6 mm
6Y41=180-6	180 mm	6 mm
6Y41=200-6	200 mm	6 mm
6Y41=220-6	220 mm	6 mm
6Y41=235-6	235 mm	6 mm
6Y41=250-6	250 mm	6 mm
6Y41=265-6	265 mm	6 mm
6Y41=280-6	280 mm	6 mm
6Y41=300-6	300 mm	6 mm
6Y41=320-6	320 mm	6 mm
6Y41=340-6	340 mm	6 mm
6Y41=360-6	360 mm	6 mm
6Y41=400-6	400 mm	6 mm

Amputation level	Transtibial amputation
Material	Silicone
Connection	Without distal connection
Distal cushion	13.5 mm
Textile cover	without
Colour	Transparent
Exterior coating	with
Socket design	Specific weight-bearing socket
Matrix	without
Skinguard	without

Socket technologies

Skeo liner



Skeo Pure

Reference number 6Y43

The difference is clear. Thanks to its transparency, the Skeo Pure makes it easier to visually check the fit and skin condition, for example in case of interim fittings. The silky-smooth exterior dries quickly and makes it simple to put on and take off the prosthesis without donning spray.

The 6Y43 Skeo Pure can be combined with a shuttle lock.

Information material

647G380=ALL_INT IFU Liners (qualified personnel)

Technical data

Article number	Size
6Y43=120	120 mm
6Y43=140	140 mm
6Y43=160	160 mm
6Y43=180	180 mm
6Y43=200	200 mm
6Y43=210	210 mm
6Y43=220	220 mm
6Y43=235	235 mm
6Y43=250	250 mm
6Y43=265	265 mm
6Y43=280	280 mm
6Y43=300	300 mm
6Y43=320	320 mm
6Y43=340	340 mm
6Y43=360	360 mm
6Y43=380	380 mm
6Y43=400	400 mm
6Y43=420	420 mm
6Y43=450	450 mm

Amputation level	Transtibial amputation
Material	Silicone
Connection	With distal connection
Distal cushion	ca. 13.5 mm
Wall thickness	3 mm
Textile cover	without
Colour	Transparent
Exterior coating	with
Socket design	Specific weight-bearing socket
Matrix	10 cm length
Skinguard	without



Skeo

Reference number 6Y70

The distal matrix of the Skeo liner has a length of 10 cm and prevents lengthwise stretching. It gives the user good control over the prosthesis and a high level of safety. At the same time, the Skeo lower leg liner easily adapts to slight fluctuations in volume thanks to its transverse elasticity. The 6Y70 Skeo (TT) can be combined with a shuttle lock.

Information material

647G380=ALL_INT IFU Liners (qualified personnel)

Technical data

Article number	Size	Wall thickness
6Y70=160	160 mm	From approx. 5 mm distally, tapering to 3 mm proximally
6Y70=180	180 mm	From approx. 5 mm distally, tapering to 3 mm proximally
6Y70=200	200 mm	From approx. 5 mm distally, tapering to 3 mm proximally
6Y70=210	210 mm	From approx. 5 mm distally, tapering to 3 mm proximally
6Y70=220	220 mm	From approx. 5 mm distally, tapering to 3 mm proximally
6Y70=235	235 mm	From approx. 5 mm distally, tapering to 3 mm proximally
6Y70=250	250 mm	From approx. 5 mm distally, tapering to 3 mm proximally
6Y70=265	265 mm	From approx. 5 mm distally, tapering to 3 mm proximally
6Y70=280	280 mm	From approx. 5 mm distally, tapering to 3 mm proximally
6Y70=300	300 mm	From approx. 5 mm distally, tapering to 3 mm proximally
6Y70=320	320 mm	From approx. 5 mm distally, tapering to 3 mm proximally
6Y70=340	340 mm	From approx. 5 mm distally, tapering to 3 mm proximally
6Y70=360	360 mm	From approx. 5 mm distally, tapering to 3 mm proximally
6Y70=380	380 mm	From approx. 5 mm distally, tapering to 3 mm proximally
6Y70=400	400 mm	From approx. 5 mm distally, tapering to 3 mm proximally
6Y70=160-6	160 mm	6 mm
6Y70=180-6	180 mm	6 mm
6Y70=200-6	200 mm	6 mm
6Y70=210-6	210 mm	6 mm
6Y70=220-6	220 mm	6 mm
6Y70=235-6	235 mm	6 mm
6Y70=250-6	250 mm	6 mm
6Y70=265-6	265 mm	6 mm
6Y70=280-6	280 mm	6 mm
6Y70=300-6	300 mm	6 mm
6Y70=320-6	320 mm	6 mm
6Y70=340-6	340 mm	6 mm
6Y70=360-6	360 mm	6 mm
6Y70=380-6	380 mm	6 mm
6Y70=400-6	400 mm	6 mm
Amputation level		Transtibial amputation
Material		Silicone
Connection		with distal connection
Distal cushion		16 mm
Textile cover		with
Colour		Light grey
Exterior coating		without
Socket design		Specific weight-bearing socket
Matrix		10 cm length
Skinguard		without

Socket technologies

Skeo liner



Skeo Skinguard

Reference number 6Y75

The Skeo Skinguard lower leg liner contains an antibacterial additive that reduces the growth of bacteria due to perspiration by 99.9 per cent. A 10 cm matrix in the lower section reduces lengthwise stretching of the liner.

The 6Y75 Skeo Skinguard (TT) can be combined with a shuttle lock.

Information material

647G380=ALL_INT IFU Liners (qualified personnel)

Technical data

Article number	Size
6Y75=160	160 mm
6Y75=180	180 mm
6Y75=200	200 mm
6Y75=210	210 mm
6Y75=220	220 mm
6Y75=235	235 mm
6Y75=250	250 mm
6Y75=265	265 mm
6Y75=280	280 mm
6Y75=300	300 mm
6Y75=320	320 mm
6Y75=340	340 mm
6Y75=360	360 mm
6Y75=380	380 mm
6Y75=400	400 mm
Amputation level	Transtibial amputation
Material	Silicone
Connection	with distal connection
Distal cushion	16 mm
Wall thickness	from approx. 5 mm distally, tapering to 3 mm proximally
Textile cover	with
Colour	Light grey
Exterior coating	without
Socket design	Specific weight-bearing socket
Matrix	10 cm length
Skinguard	with



Skeo 3D

Reference number 6Y77

Thanks to different material thicknesses, the Skeo 3D lower leg liner adapts to the anatomy of the residual limb – without wrinkles and pressure points. It protects sensitive areas with a wall thickness of 7 mm and facilitates greater flexibility with thinner liner zones. The Skeo 3D is pre-flexed in the area of the knee, making it easier to bend the knee. The matrix height that can be chosen according to the residual limb length prevents lengthwise stretching of the liner. All liners in the Skeo product range are durable, easy to clean, have good adhesion properties and provide stability – ideal for residual limbs with large amounts of soft tissue.

The 6Y77 Skeo 3D (TT) can be combined with the shuttle lock.

Technical data

Information material

647G380=ALL_INT

IFU Liners (qualified personnel)

Article number	Size	Residual limb length below the MPT
6Y77=265X75	265 mm (270-290 mm)	75 mm (50-100 mm)
6Y77=180X125	180 mm (185-205 mm)	125 mm (100-150 mm)
6Y77=200X125	200 mm (205-225 mm)	125 mm (100-150 mm)
6Y77=220X125	220 mm (225-245 mm)	125 mm (100-150 mm)
6Y77=235X125	235 mm (240-260 mm)	125 mm (100-150 mm)
6Y77=250X125	250 mm (255-275 mm)	125 mm (100-150 mm)
6Y77=265X125	265 mm (270-290 mm)	125 mm (100-150 mm)
6Y77=280X125	280 mm (285-305 mm)	125 mm (100-150 mm)
6Y77=220X175	220 mm (225-245 mm)	175 mm (150-200 mm)
6Y77=235X175	235 mm (240-260 mm)	175 mm (150-200 mm)
6Y77=250X175	250 mm (255-275 mm)	175 mm (150-200 mm)
6Y77=265X175	265 mm (270-290 mm)	175 mm (150-200 mm)
6Y77=280X175	280 mm (285-305 mm)	175 mm (150-200 mm)
6Y77=300X175	300 mm (305-325 mm)	175 mm (150-200 mm)
6Y77=320X175	320 mm (325-345 mm)	175 mm (150-200 mm)

Amputation level	Trans tibial amputation
Material	Silicone
Connection	With distal connection
Distal cushion	16 mm
Wall thickness	7 mm build-ups at the tibial crest and fibular head, from 4 mm distally, tapering to 3 mm proximally
Textile cover	with
Colour	Light grey
Exterior coating	without
Socket design	Specific weight-bearing socket
Matrix	depending on residual limb length
Skinguard	without

Socket technologies

Skeo liner



Skeo 3D

Reference number 6Y78

The Skeo 3D lower leg liner with Skinguard antibacterial additive adapts to the anatomy of the residual limb: greater wall thicknesses provide added protection, thinner zones permit greater flexibility. The matrix height that can be chosen according to the residual limb length prevents lengthwise stretching of the liner.

The 6Y78 Skeo 3D (TT) can be combined with a shuttle lock.

Information material

647G380=ALL_INT IFU Liners (qualified personnel)

Technical data

Article number	Size	Residual limb length below the MPT
6Y78=265X75	265 mm (270-290 mm)	75 mm (50-100 mm)
6Y78=180X125	180 mm (185-205 mm)	125 mm (100-150 mm)
6Y78=200X125	200 mm (205-225 mm)	125 mm (100-150 mm)
6Y78=220X125	220 mm (225-245 mm)	125 mm (100-150 mm)
6Y78=235X125	235 mm (240-260 mm)	125 mm (100-150 mm)
6Y78=250X125	250 mm (255-275 mm)	125 mm (100-150 mm)
6Y78=265X125	265 mm (270-290 mm)	125 mm (100-150 mm)
6Y78=280X125	280 mm (285-305 mm)	125 mm (100-150 mm)
6Y78=220X175	220 mm (225-245 mm)	175 mm (150-200 mm)
6Y78=235X175	235 mm (240-260 mm)	175 mm (150-200 mm)
6Y78=250X175	250 mm (255-275 mm)	175 mm (150-200 mm)
6Y78=265X175	265 mm (270-290 mm)	175 mm (150-200 mm)
6Y78=280X175	280 mm (285-305 mm)	175 mm (150-200 mm)
6Y78=300X175	300 mm (305-325 mm)	175 mm (150-200 mm)
6Y78=320X175	320 mm (325-345 mm)	175 mm (150-200 mm)

Amputation level	Trans tibial amputation
Material	Silicone
Connection	With distal connection
Distal cushion	16 mm
Wall thickness	7 mm build-ups at the tibial crest and fibular head, from 4 mm distally, tapering to 3 mm proximally
Textile cover	with
Colour	Light grey
Exterior coating	without
Socket design	Specific weight-bearing socket
Matrix	depending on residual limb length
Skinguard	with



Skeo

Reference number 6Y80

The liner's continuous matrix reduces lengthwise stretching. It gives the user good control over the prosthesis with a high level of safety. At the same time, the Skeo thigh liner easily adapts to slight fluctuations in volume thanks to its transverse elasticity.

The 6Y80 Skeo (TF) can be combined with a shuttle lock or the KISS lanyard system.

Technical data

Article number	Size
6Y80=280	280 mm
6Y80=300	300 mm
6Y80=320	320 mm
6Y80=340	340 mm
6Y80=360	360 mm
6Y80=380	380 mm
6Y80=400	400 mm
6Y80=420	420 mm
6Y80=450	450 mm
6Y80=500	500 mm
6Y80=550	550 mm

Information material

647G380=ALL_INT IFU Liners (qualified personnel)

Amputation level	Transfemoral amputation
Material	Silicone
Connection	with distal connection
Distal cushion	14.5 mm
Wall thickness	from approx. 4.5 mm distally, tapering to 2.5 mm proximally
Textile cover	with
Colour	Light grey
Exterior coating	without
Socket design	Specific weight-bearing socket
Matrix	Continuous matrix
Skinguard	without

Socket technologies

Skeo liner



Skeo Skinguard

Reference number 6Y85

The Skeo Skinguard thigh liner contains an antibacterial additive that reduces the growth of bacteria due to perspiration by 99.9 per cent. A continuous matrix reduces lengthwise stretching of the liner.

The 6Y85 Skeo Skinguard (TF) can be combined with a shuttle lock or the KISS lanyard system.

Information material

647G380=ALL_INT IFU Liners (qualified personnel)

Technical data

Article number	Size
6Y85=280	280 mm
6Y85=300	300 mm
6Y85=320	320 mm
6Y85=340	340 mm
6Y85=360	360 mm
6Y85=380	380 mm
6Y85=400	400 mm
6Y85=420	420 mm
6Y85=450	450 mm
6Y85=500	500 mm
6Y85=550	550 mm

Amputation level	Transfemoral amputation
Material	Silicone
Connection	with distal connection, with SkinGuard® Technology
Distal cushion	14.5 mm
Wall thickness	from approx. 4.5 mm distally, tapering to 2.5 mm proximally
Textile cover	with
Colour	Light grey
Exterior coating	without
Socket design	Specific weight-bearing socket
Matrix	Continuous matrix
Skinguard	with



Skeo 3D

Reference number 6Y87

The Skeo 3D thigh liner tapers conically in the distal region so even sensitive soft tissue is enveloped especially gently. The top of the liner is cylindrical in shape, reliably enclosing the residual limb. The continuous matrix counteracts lengthwise stretching of the liner. The 6Y87 Skeo 3D (TF) can be combined with a shuttle lock or the KISS lanyard system.

Information material

647G380=ALL_INT IFU Liners (qualified personnel)

Technical data

Article number	Size
6Y87=250	250 mm
6Y87=265	265 mm
6Y87=280	280 mm
6Y87=300	300 mm
6Y87=320	320 mm
6Y87=340	340 mm
6Y87=360	360 mm
6Y87=380	380 mm
6Y87=400	400 mm
6Y87=450	450 mm

Amputation level	Transfemoral amputation
Material	Silicone
Connection	With distal connection
Distal cushion	14.5 mm
Wall thickness	From 4.5 mm distally, tapering to 2.5 mm proximally
Textile cover	with
Colour	Light grey
Exterior coating	without
Socket design	Specific weight-bearing socket
Matrix	Continuous matrix
Skinguard	without

Socket technologies

Skeo liner



Skeo 3D

Reference number 6Y88

The Skeo 3D thigh liner tapers conically in the distal region so even sensitive soft tissue is enveloped especially gently. The top of the antibacterial liner is cylindrical in shape, reliably enclosing the residual limb. The continuous matrix counteracts lengthwise stretching of the liner.

The 6Y88 Skeo 3D (TF) can be combined with a shuttle lock or the KISS lanyard system.

Information material

647G380=ALL_INT IFU Liners (qualified personnel)

Technical data

Article number	Size
6Y88=250	250 mm
6Y88=265	265 mm
6Y88=280	280 mm
6Y88=300	300 mm
6Y88=320	320 mm
6Y88=340	340 mm
6Y88=360	360 mm
6Y88=380	380 mm
6Y88=400	400 mm
6Y88=450	450 mm

Amputation level	Transfemoral amputation
Material	Silicone
Connection	With distal connection
Distal cushion	14.5 mm
Wall thickness	From approx. 4.5 mm distally, tapering to 2.5 mm proximally
Textile cover	with
Colour	Light grey
Exterior coating	without
Matrix	Continuous matrix
Skinguard	with



Skeo Sealing

Reference number 6Y110

Sealed. Done. The durable sealing ring reliably maintains the vacuum in the socket. The silky-smooth surface with no textile cover saves time during cleaning and when putting on and taking off the prosthesis. The Skinguard antibacterial additive reduces the growth of bacteria.

The 6Y110 Skeo Sealing (TF) liner can be combined with a valve or the Harmony system.

Information material

647G380=ALL_INT

IFU Liners (qualified personnel)

Technical data

Article number	Size
6Y110=280X10	280 mm
6Y110=280X17	280 mm
6Y110=300X10	300 mm
6Y110=300X17	300 mm
6Y110=320X10	320 mm
6Y110=320X17	320 mm
6Y110=340X10	340 mm
6Y110=340X17	340 mm
6Y110=360X10	360 mm
6Y110=360X17	360 mm
6Y110=380X10	380 mm
6Y110=380X17	380 mm
6Y110=400X10	400 mm
6Y110=400X17	400 mm
6Y110=450X10	450 mm
6Y110=450X17	450 mm
6Y110=500X10	500 mm
6Y110=500X17	500 mm
6Y110=550X10	550 mm
6Y110=550X17	550 mm

Amputation level	Transfemoral amputation
Material	Silicone
Wall thickness	From approx. 6 mm, tapering to 2.5 mm
Textile cover	without
Colour	Light grey
Exterior coating	with
Socket design	Specific weight-bearing socket
Matrix	Continuous matrix
Skinguard	with

- We recommend the 10 cm ring height (6Y110=*X10) for residual limbs of medium length and the 17 cm ring height (6Y110=*X17) for long residual limbs.

Socket technologies

Skeo liner



Skeo Unique

Reference number 6Y700

To meet your patient's individual needs, the Skeo liner offers a tailor-made solution for patients with unusual residual limb shapes. The silicone liner is recommended in particular when high stability and durability are required. Skeo Unique liners combine the positive material properties of silicone with the advantages of a gel. They are suitable for transfemoral and transtibial amputees.

Key features

- Stabilises residual limbs with ample soft tissue
- Made of skin-friendly silicone
- Easy handling and quick cleaning
- Good adhesion on the residual limb

Information material

647G1144=ALL_INT IFU Liners (qualified personnel)

Ordering options

Wall thickness		
Uniform	4,5 mm uniform	
Tapering proximally	4,5 mm MPT to 2,5 mm proximal	
Distal cushion		
Locking	21 mm	
Cushion	13 mm	
Connection system		
Dynamic Vacuum System	TT	
Shuttle Lock	TT / TF	
KISS	TF	
Textile		
Textile cover options	No textile	
	With partial textile cover	
	With full textile	
Available textile materials	Spandex textile 0.6 mm skin colour	
	Spandex textile 0.6 mm black	
	Wearforce textile 1.6 mm skin colour	
	Wearforce textile 1.6 mm black	
	Silver textile 1.0 mm	
Treatment options		
	TT	TF
KISS Lanyard System	–	x
Shuttle Lock System	x	x
Valve System	•	–
Dynamic Vacuum System	•	x
Harmony (P3 & P4)	•	•
Harmony (E2)	•	x

x recommended | • possible | – not possible

• To order, please follow the ordering procedure and use the order form at the end of the "Socket technologies" section.

Customised products from Ottobock iFab

Ottobock iFab is an extended workbench that serves as your reliable partner for the centralised fabrication of custom devices in orthotics and prosthetics in the era of digital transformation.

For information about iFab products, or if you have questions or comments, please contact us: ifab@ottobock.com

iFab Customer Center

You can find the entire digital portfolio of custom products in the iFab Customer Center. The platform guides you through the ordering process quickly and easily.

You can reach the iFab Customer Center at: www.iFab-customer-center.com.



Socket technologies

Skeo liner



ProSeal liner

Reference number 6Y81

Together with the ProSeal sealing ring that is integrated into the socket, the transparent ProSeal liner reliably maintains the vacuum. The smooth exterior coating makes it easier to put the liner on and take it off, and to slide into the prosthetic socket.

The 6Y81 ProSeal (TF) liner can be combined with a valve and the Harmony system.

Technical data

Article number	Size	Distal cushion
6Y81=280	280 mm	3 mm
6Y81=300	300 mm	3 mm
6Y81=320	320 mm	3 mm
6Y81=340	340 mm	3 mm
6Y81=360	360 mm	3 mm
6Y81=380	380 mm	3 mm
6Y81=400	400 mm	3 mm
6Y81=420	420 mm	3 mm
6Y81=450	450 mm	3 mm
6Y81=500	500 mm	3 mm
6Y81=550	550 mm	3 mm
6Y81=280-10	280 mm	10 mm
6Y81=300-10	300 mm	10 mm
6Y81=320-10	320 mm	10 mm
6Y81=340-10	340 mm	10 mm
6Y81=360-10	360 mm	10 mm
6Y81=380-10	380 mm	10 mm
6Y81=400-10	400 mm	10 mm
6Y81=420-10	420 mm	10 mm
6Y81=450-10	450 mm	10 mm
6Y81=500-10	500 mm	10 mm
6Y81=550-10	550 mm	10 mm

Information material

647G380=ALL_INT IFU Liners (qualified personnel)

Amputation level	Transfemoral amputation
Material	Silicone
Connection	Without distal connection
Wall thickness	3 mm
Textile cover	without
Colour	Transparent
Exterior coating	with
Matrix	without
Skinguard	without



Caleo

Reference number 6Y90

The Caleo lower leg liner is made of an elastic and mouldable material that can be adapted to the individual residual limb shape. Prosthesis wearers appreciate the way these characteristics reduce friction to a minimum.

The 6Y90 Caleo (TT) can be combined with a shuttle lock.

Technical data

Article number	Size
6Y90=200	200 mm
6Y90=250	250 mm
6Y90=280	280 mm
6Y90=320	320 mm
6Y90=360	360 mm

Information material

647G380=ALL_INT IFU Liners (qualified personnel)

Amputation level	Transtibial amputation
Material	Copolymer
Connection	with distal connection and 10 cm distal matrix
Distal cushion	18 mm
Wall thickness	10 mm thick distal cushion pad; wall thickness tapering from 5.5 mm to 2.5 mm proximal
Textile cover	with
Colour	Olive
Exterior coating	without
Socket design	Specific or total surface weight-bearing socket
Matrix	10 cm length
Skinguard	without

Socket technologies

Caleo liner



Caleo

Reference number 6Y92

The Caleo lower leg liner is made of an elastic and mouldable material that can be adapted to the individual residual limb shape. Prosthesis wearers appreciate the way these characteristics reduce friction to a minimum.

The 6Y92 Caleo (TT) can be combined with a valve.

Technical data

Article number	Size
6Y92=200	200 mm
6Y92=250	250 mm
6Y92=280	280 mm
6Y92=320	320 mm
6Y92=360	360 mm

Information material

647G380=ALL_INT IFU Liners (qualified personnel)

Amputation level	Transtibial amputation
Material	Copolymer
Connection	without distal connection
Distal cushion	13 mm
Wall thickness	10 mm thick distal cushion pad; wall thickness tapering from 5.5 mm to 2.5 mm proximal
Textile cover	with
Colour	Olive
Exterior coating	without
Socket design	Specific or total surface weight-bearing socket
Matrix	without
Skinguard	without



Caleo 3D

Reference number 6Y93

The fit of the Caleo 3D is based on the anatomy of the lower leg. Greater wall thicknesses in the front protect sensitive and bony structures, while reduced wall thicknesses at the rear offer increased flexibility for the knee.

The 6Y93=C Caleo 3D (TT) can be combined with a valve.

The 6Y93=L Caleo 3D (TT) can be combined with a shuttle lock.

Information material

647G380=ALL_INT

IFU Liners (qualified personnel)

Technical data

Article number	Size	Connection	Distal cushion
6Y93=C6-S	S (150-260 mm)	Without distal connection	7.5 mm
6Y93=C6-M	M (180-310 mm)	Without distal connection	7.5 mm
6Y93=C6-MP	MP (200-310 mm)	Without distal connection	7.5 mm
6Y93=C6-L	L (230-350 mm)	Without distal connection	7.5 mm
6Y93=C6-LP	LP (280-430 mm)	Without distal connection	7.5 mm
6Y93=C6-XL	XL (330-500 mm)	Without distal connection	7.5 mm
6Y93=L6-S	S (150-260 mm)	With distal connection	16 mm
6Y93=L6-M	M (180-310 mm)	With distal connection	16 mm
6Y93=L6-MP	MP (200-310 mm)	With distal connection	16 mm
6Y93=L6-L	L (230-350 mm)	With distal connection	16 mm
6Y93=L6-LP	LP (280-430 mm)	With distal connection	16 mm
6Y93=L6-XL	XL (330-500 mm)	With distal connection	16 mm

Amputation level	Transtibial amputation
Material	Copolymer
Wall thickness	From 6 mm distally, tapering to 3 mm proximally
Textile cover	with
Colour	Olive
Exterior coating	without
Socket design	Specific or total surface weight-bearing socket
Matrix	without
Skinguard	without

Socket technologies

Caleo liner



Caleo 3D

Reference number 6Y93F

The fit of the 6Y93F Caleo 3D in the longer version (50 cm) is based on the anatomy of the lower leg and is particularly well suited for Symes and knee disarticulation amputees. Greater wall thicknesses in the front protect sensitive and bony structures, while reduced wall thicknesses at the rear offer increased flexibility for the knee. The 6Y93F=C Caleo 3D (TT) can be combined with a valve. The 6Y93F=L Caleo 3D (TT) can be combined with a shuttle lock.

Information material

647G380=ALL_INT IFU Liners (qualified personnel)

Technical data

Article number	Size	Connection	Distal cushion
6Y93F=C6-S	S (150-260 mm)	Without distal connection	13 mm
6Y93F=C6-M	M (180-310 mm)	Without distal connection	13 mm
6Y93F=C6-MP	MP (200-310 mm)	Without distal connection	13 mm
6Y93F=C6-L	L (230-350 mm)	Without distal connection	13 mm
6Y93F=C6-LP	LP (280-430 mm)	Without distal connection	13 mm
6Y93F=C6-XL	XL (330-500 mm)	Without distal connection	13 mm
6Y93F=L6-S	S (150-260 mm)	With distal connection	21 mm
6Y93F=L6-M	M (180-310 mm)	With distal connection	21 mm
6Y93F=L6-MP	MP (200-310 mm)	With distal connection	21 mm
6Y93F=L6-L	L (230-350 mm)	With distal connection	21 mm
6Y93F=L6-LP	LP (280-430 mm)	With distal connection	21 mm
6Y93F=L6-XL	XL (330-500 mm)	With distal connection	21 mm

Amputation level	Transtibial amputation
Material	Copolymer
Wall thickness	From 6 mm distally, tapering to 3 mm proximally
Textile cover	with
Colour	Olive
Exterior coating	without
Socket design	Specific or total surface weight-bearing socket
Matrix	without
Skinguard	without



Caleo 3D

Reference number 6Y95

The Caleo 3D features a fit based on the anatomy of the body. The material characteristics in the knee area make flexion particularly easy and reduce pressure on the patella.

The 6Y95=C Caleo 3D (TT) can be combined with a valve.

The 6Y95=L Caleo 3D (TT) can be combined with a shuttle lock.

Technical data

Article number	Size	Connection	Distal cushion
6Y95=C6-S	S (150-260 mm)	Without distal connection	7.5 mm
6Y95=C6-M	M (180-310 mm)	Without distal connection	7.5 mm
6Y95=C6-MP	MP (200-310 mm)	Without distal connection	7.5 mm
6Y95=C6-L	L (230-350 mm)	Without distal connection	7.5 mm
6Y95=C6-LP	LP (280-430 mm)	Without distal connection	7.5 mm
6Y95=C6-XL	XL (330-500mm)	Without distal connection	7.5 mm
6Y95=L6-S	S (150-260 mm)	With distal connection	16 mm
6Y95=L6-M	M (180-310 mm)	With distal connection	16 mm
6Y95=L6-MP	MP (200-310 mm)	With distal connection	16 mm
6Y95=L6-L	L (230-350 mm)	With distal connection	16 mm
6Y95=L6-LP	LP (280-430 mm)	With distal connection	16 mm
6Y95=L6-XL	XL (330-500mm)	With distal connection	16 mm

Information material

647G380=ALL_INT IFU Liners (qualified personnel)

Amputation level	Transtibial amputation
Material	Copolymer
Wall thickness	6 mm anterior, 3 mm posterior
Textile cover	with
Colour	Olive
Exterior coating	without
Socket design	Specific or total surface weight-bearing socket
Matrix	without
Skinguard	without

Socket technologies

Caleo liner



Dynamic Vacuum System liner

Reference number 6Y94

Developed especially for the Dynamic Vacuum System, the DVS copolymer liner establishes a direct connection to the vacuum pump. A magnetic coupling between the liner's distal connection and pump piston ensures the required hold.

The liner also nourishes the skin with the controlled release of medical white oil.

Technical data

Article number	Size	Textile cover
6Y94=S	S (150-260 mm)	with
6Y94=M	M (180-310 mm)	with
6Y94=MP	MP (200-310 mm)	with
6Y94=L	L (230-350 mm)	with
6Y94=LP	LP (280-430 mm)	with
6Y94=XL	XL (330-500 mm)	with
6Y94=S-F	S (150-260 mm)	With partial textile
6Y94=M-F	M (180-310 mm)	With partial textile
6Y94=MP-F	MP (200-310 mm)	With partial textile
6Y94=L-F	L (230-350 mm)	With partial textile
6Y94=LP-F	LP (280-430 mm)	With partial textile
6Y94=XL-F	XL (330-500 mm)	With partial textile

Information material

647G380=ALL_INT IFU Liners (qualified personnel)

Amputation level	Transtibial amputation
Material	Copolymer
Connection	With connection for the Dynamic Vacuum System DVS
Distal cushion	16 mm
Wall thickness	From 6 mm distally, tapering to 3 mm proximally
Colour	Olive
Exterior coating	without
Socket design	Specific or total surface weight-bearing socket
Matrix	without
Skinguard	without



Uneo

Reference number 6Y60

The Uneo lower leg liner is made of a soft, yielding material that “flows” to encompass the residual limb. A distal cushion provides additional padding so that pressure points are prevented.

The 6Y60 Uneo (TT) can be combined with a shuttle lock.

Technical data

Article number	Size
6Y60=160	160 mm
6Y60=180	180 mm
6Y60=200	200 mm
6Y60=210	210 mm
6Y60=220	220 mm
6Y60=235	235 mm
6Y60=250	250 mm
6Y60=265	265 mm
6Y60=280	280 mm
6Y60=300	300 mm
6Y60=320	320 mm
6Y60=340	340 mm
6Y60=360	360 mm
6Y60=380	380 mm
6Y60=400	400 mm

Information material

647G380=ALL_INT IFU Liners (qualified personnel)

Amputation level	Transtibial amputation
Material	Polyurethane
Connection	with distal connection
Distal cushion	10 mm
Wall thickness	from approx. 4.5 mm distally, tapering to 2.5 mm proximally
Textile cover	with
Colour	Beige
Exterior coating	without
Socket design	Specific or total surface weight-bearing socket
Matrix	without
Skinguard	without

Socket technologies

Uneo liner



Uneo Flex

Reference number 6Y510

The yielding Uneo Flex is pre-flexed in the area of the knee. This fit makes it easier to bend the knee and prevents bunching of excess material in the hollow of the knee.

The 6Y510 Uneo Flex (TT) can be combined with a valve or the Harmony system.

The 6Y510=-5/-9 Uneo Flex (TT) can be combined with a valve.

Technical data

Article number	Size	Residual limb length below the MPT	Textile cover	Exterior coating	Colour
6Y510=200X75	200 mm	75 mm (50-100 mm)	without	with	Transparent
6Y510=225X75	225 mm	75 mm (50-100 mm)	without	with	Transparent
6Y510=250X75	250 mm	75 mm (50-100 mm)	without	with	Transparent
6Y510=275X75	275 mm	75 mm (50-100 mm)	without	with	Transparent
6Y510=300X75	300 mm	75 mm (50-100 mm)	without	with	Transparent
6Y510=325X75	325 mm	75 mm (50-100 mm)	without	with	Transparent
6Y510=210X125	210 mm	125 mm (100-150 mm)	without	with	Transparent
6Y510=235X125	235 mm	125 mm (100-150 mm)	without	with	Transparent
6Y510=260X125	260 mm	125 mm (100-150 mm)	without	with	Transparent
6Y510=285X125	285 mm	125 mm (100-150 mm)	without	with	Transparent
6Y510=310X125	310 mm	125 mm (100-150 mm)	without	with	Transparent
6Y510=210X175	210 mm	175 mm (150-200 mm)	without	with	Transparent
6Y510=235X175	235 mm	175 mm (150-200 mm)	without	with	Transparent
6Y510=260X175	260 mm	175 mm (150-200 mm)	without	with	Transparent
6Y510=285X175	285 mm	175 mm (150-200 mm)	without	with	Transparent
6Y510=310X175	310 mm	175 mm (150-200 mm)	without	with	Transparent
6Y510=175X75-5	175 mm	75 mm (50-100 mm)	with	without	Anthracite
6Y510=200X75-5	200 mm	75 mm (50-100 mm)	with	without	Anthracite
6Y510=225X75-5	225 mm	75 mm (50-100 mm)	with	without	Anthracite
6Y510=250X75-5	250 mm	75 mm (50-100 mm)	with	without	Anthracite
6Y510=275X75-5	275 mm	75 mm (50-100 mm)	with	without	Anthracite
6Y510=300X75-5	300 mm	75 mm (50-100 mm)	with	without	Anthracite
6Y510=325X75-5	325 mm	75 mm (50-100 mm)	with	without	Anthracite
6Y510=175X75-9	175 mm	75 mm (50-100 mm)	with	without	Beige
6Y510=200X75-9	200 mm	75 mm (50-100 mm)	with	without	Beige
6Y510=225X75-9	225 mm	75 mm (50-100 mm)	with	without	Beige
6Y510=250X75-9	250 mm	75 mm (50-100 mm)	with	without	Beige
6Y510=275X75-9	275 mm	75 mm (50-100 mm)	with	without	Beige
6Y510=300X75-9	300 mm	75 mm (50-100 mm)	with	without	Beige
6Y510=325X75-9	325 mm	75 mm (50-100 mm)	with	without	Beige
6Y510=210X125-5	210 mm	125 mm (100-150 mm)	with	without	Anthracite
6Y510=235X125-5	235 mm	125 mm (100-150 mm)	with	without	Anthracite
6Y510=260X125-5	260 mm	125 mm (100-150 mm)	with	without	Anthracite
6Y510=285X125-5	285 mm	125 mm (100-150 mm)	with	without	Anthracite
6Y510=310X125-5	310 mm	125 mm (100-150 mm)	with	without	Anthracite
6Y510=210X125-9	210 mm	125 mm (100-150 mm)	with	without	Beige
6Y510=235X125-9	235 mm	125 mm (100-150 mm)	with	without	Beige
6Y510=260X125-9	260 mm	125 mm (100-150 mm)	with	without	Beige
6Y510=285X125-9	285 mm	125 mm (100-150 mm)	with	without	Beige
6Y510=310X125-9	310 mm	125 mm (100-150 mm)	with	without	Beige
6Y510=210X175-5	210 mm	175 mm (150-200 mm)	with	without	Anthracite
6Y510=235X175-5	235 mm	175 mm (150-200 mm)	with	without	Anthracite

Information material

647G1144=ALL_INT	IFU Liners (qualified personnel)
647G380=ALL_INT	IFU Liners (qualified personnel)

Article number	Size	Residual limb length below the MPT	Textile cover	Exterior coating	Colour
6Y510=260X175-5	260 mm	175 mm (150-200 mm)	with	without	Anthracite
6Y510=285X175-5	285 mm	175 mm (150-200 mm)	with	without	Anthracite
6Y510=310X175-5	310 mm	175 mm (150-200 mm)	with	without	Anthracite
6Y510=210X175-9	210 mm	175 mm (150-200 mm)	with	without	Beige
6Y510=235X175-9	235 mm	175 mm (150-200 mm)	with	without	Beige
6Y510=260X175-9	260 mm	175 mm (150-200 mm)	with	without	Beige
6Y510=285X175-9	285 mm	175 mm (150-200 mm)	with	without	Beige
6Y510=310X175-9	310 mm	175 mm (150-200 mm)	with	without	Beige

Amputation level	Transtibial amputation
Material	Polyurethane
Connection	without distal connection
Distal cushion	15 mm
Wall thickness	approx. 6 mm to knee centre, tapering to 3 mm from knee centre
Socket design	Total surface weight-bearing socket
Matrix	without
Skinguard	without

Socket technologies

Uneo liner



Uneo / Uneo Pure

Reference number 6Y520

The 6Y520=-5/-9 Uneo is made of a soft, yielding material that “flows” to encompass the residual limb. A distal cushion provides padding so that pressure points are prevented. The transparent 6Y520 Uneo Pure makes it possible to visually check the fit and skin condition.

The 6Y520=-5/9 Uneo (TT) can be combined with a valve or the Harmony system.

Information material

647G1144=ALL_INT	IFU Liners (qualified personnel)
647G380=ALL_INT	IFU Liners (qualified personnel)

Technical data

Article number	Size	Textile cover	Colour	Exterior coating
6Y520=190	190 mm	without	Transparent	with
6Y520=230	230 mm	without	Transparent	with
6Y520=290	290 mm	without	Transparent	with
6Y520=330	330 mm	without	Transparent	with
6Y520=400	400 mm	without	Transparent	with
6Y520=190-5	190 mm	with	Anthracite	without
6Y520=230-5	230 mm	with	Anthracite	without
6Y520=290-5	290 mm	with	Anthracite	without
6Y520=330-5	330 mm	with	Anthracite	without
6Y520=400-5	400 mm	with	Anthracite	without
6Y520=190-9	190 mm	with	Beige	without
6Y520=230-9	230 mm	with	Beige	without
6Y520=290-9	290 mm	with	Beige	without
6Y520=330-9	330 mm	with	Beige	without
6Y520=400-9	400 mm	with	Beige	without

Amputation level	Transtibial amputation
Material	Polyurethane
Connection	Without distal connection
Distal cushion	15 mm
Wall thickness	6 mm
Socket design	Total surface weight-bearing socket
Matrix	without
Skinguard	without



Uneo Pure / Uneo Skinguard

Reference number 6Y522

The 6Y522 Uneo Pure makes it possible to visually check the fit and skin condition. The exterior is easy to clean, dries quickly and makes it simple to put on and take off the prosthesis. The 6Y522=*-G Uneo Skinguard contains an antibacterial additive that reduces the growth of odour-forming bacteria by 99.9 per cent.

The 6Y522 Uneo Pure and 6Y522=*-G Uneo Skinguard can be combined with a valve or the Harmony system.

Information material

647G1144=ALL_INT	IFU Liners (qualified personnel)
647G380=ALL_INT	IFU Liners (qualified personnel)

Technical data

Article number	Size	Skinguard
6Y522=190	190 mm	without
6Y522=210	210 mm	without
6Y522=230	230 mm	without
6Y522=250	250 mm	without
6Y522=290	290 mm	without
6Y522=310	310 mm	without
6Y522=190-G	190 mm	with
6Y522=210-G	210 mm	with
6Y522=230-G	230 mm	with
6Y522=250-G	250 mm	with
6Y522=290-G	290 mm	with
6Y522=310-G	310 mm	with

Amputation level	Transtibial amputation
Material	Polyurethane
Connection	Without distal connection
Distal cushion	15 mm
Wall thickness	From 6 mm distally, tapering to 3 mm proximally
Textile cover	without
Colour	Transparent
Exterior coating	with
Socket design	Total surface weight-bearing socket
Matrix	without

Socket technologies

Uneo liner



Uneo / Uneo Skinguard

Reference number 6Y523

The 6Y523 Uneo is made of a soft, yielding material that “flows” to encompass the residual limb. A distal cushion provides padding so that pressure points are prevented. The 6Y523=*-G Uneo Skinguard contains an antibacterial additive that reduces the growth of odour-forming bacteria by 99.9 per cent. The 6Y523 Uneo and 6Y523=*-G Uneo Skinguard can be combined with a valve or the Harmony system.

Information material

647G1144=ALL_INT	IFU Liners (qualified personnel)
647G380=ALL_INT	IFU Liners (qualified personnel)

Technical data

Article number	Size	Skinguard
6Y523=190	190 mm	without
6Y523=210	210 mm	without
6Y523=230	230 mm	without
6Y523=250	250 mm	without
6Y523=290	290 mm	without
6Y523=310	310 mm	without
6Y523=190-G	190 mm	with
6Y523=210-G	210 mm	with
6Y523=230-G	230 mm	with
6Y523=250-G	250 mm	with
6Y523=290-G	290 mm	with
6Y523=310-G	310 mm	with

Amputation level	Transtibial amputation
Material	Polyurethane
Connection	without distal connection
Distal cushion	15 mm
Wall thickness	6 mm wall thickness up to 10 cm distal, tapering to 3 mm wall thickness proximal
Textile cover	with
Colour	Anthracite
Exterior coating	without
Socket design	Total surface weight-bearing socket
Matrix	without



Uneo Fresh

Reference number 6Y512

A scent that lasts for the liner's daily duration of use is integrated into the material of the Uneo Fresh. The special geometry with varying wall thicknesses – according to the anatomy in the respective area of the residual limb – protects sensitive areas and increases knee mobility.

The 6Y512=*-P Uneo Fresh can be combined with a valve or the Harmony system.

Technical data

Article number	Size	Residual limb length below the MPT	Textile cover	Colour
6Y512=250X75-P	250 mm (255-275 mm)	75 mm (50-100 mm)	without	Transparent
6Y512=210X125-P	210 mm (215-235 mm)	125 mm (100-150 mm)	without	Transparent
6Y512=235X125-P	235 mm (240-265 mm)	125 mm (100-150 mm)	without	Transparent
6Y512=265X125-P	265 mm (260-280 mm)	125 mm (100-150 mm)	without	Transparent
6Y512=280X125-P	280 mm (285-310 mm)	125 mm (100-150 mm)	without	Transparent
6Y512=300X125-P	300 mm (310-335 mm)	125 mm (100-150 mm)	without	Transparent
6Y512=210X175-P	210 mm (215-235 mm)	175 mm (150-200 mm)	without	Transparent
6Y512=235X175-P	235 mm (240-265 mm)	175 mm (150-200 mm)	without	Transparent
6Y512=265X175-P	265 mm (260-280 mm)	175 mm (150-200 mm)	without	Transparent
6Y512=280X175-P	280 mm (285-310 mm)	175 mm (150-200 mm)	without	Transparent
6Y512=300X175-P	300 mm (310-335 mm)	175 mm (150-200 mm)	without	Transparent
6Y512=250X75-F-P	250 mm (255-275 mm)	75 mm (50-100 mm)	with	Anthracite
6Y512=210X125-F-P	210 mm (215-235 mm)	125 mm (100-150 mm)	with	Anthracite
6Y512=235X125-F-P	235 mm (240-265 mm)	125 mm (100-150 mm)	with	Anthracite
6Y512=265X125-F-P	265 mm (260-280 mm)	125 mm (100-150 mm)	with	Anthracite
6Y512=280X125-F-P	280 mm (285-310 mm)	125 mm (100-150 mm)	with	Anthracite
6Y512=300X125-F-P	300 mm (310-335 mm)	125 mm (100-150 mm)	with	Anthracite
6Y512=210X175-F-P	210 mm (215-235 mm)	175 mm (150-200 mm)	with	Anthracite
6Y512=235X175-F-P	235 mm (240-265 mm)	175 mm (150-200 mm)	with	Anthracite
6Y512=265X175-F-P	265 mm (260-280 mm)	175 mm (150-200 mm)	with	Anthracite
6Y512=280X175-F-P	280 mm (285-310 mm)	175 mm (150-200 mm)	with	Anthracite
6Y512=300X175-F-P	300 mm (310-335 mm)	175 mm (150-200 mm)	with	Anthracite

Information material

647G1144=ALL_INT

IFU Liners (qualified personnel)

Amputation level	Transtibial amputation
Material	Polyurethane
Connection	Without distal connection
Distal cushion	15 mm
Wall thickness	9 mm build-ups at the tibial crest and fibular head, from 6 mm distally, tapering to 3 mm proximally
Exterior coating	with
Socket design	Total surface weight-bearing socket
Matrix	without
Skinguard	without

Socket technologies

Uneo liner



Uneo 3D

Reference number 6Y512

The Uneo 3D is precisely adapted to the anatomy of the residual limb. Sensitive areas such as the edge of the shin and head of the fibula are protected by greater wall thicknesses.

Reduced wall thicknesses at the rear on the other hand improve knee mobility.

The 6Y512 Uneo 3D (TT) can be combined with a valve or the Harmony system.

Technical data

Article number	Size	Residual limb length below the MPT	Skinguard	Textile cover	Colour
6Y512=250X75-G	250 mm (255-275 mm)	75 mm (50-100 mm)	with	without	Transparent
6Y512=210X125-G	210 mm (215-235 mm)	125 mm (100-150 mm)	with	without	Transparent
6Y512=235X125-G	235 mm (240-265 mm)	125 mm (100-150 mm)	with	without	Transparent
6Y512=265X125-G	265 mm (260-280 mm)	125 mm (100-150 mm)	with	without	Transparent
6Y512=280X125-G	280 mm (285-310 mm)	125 mm (100-150 mm)	with	without	Transparent
6Y512=300X125-G	300 mm (310-335 mm)	125 mm (100-150 mm)	with	without	Transparent
6Y512=210X175-G	210 mm (215-235 mm)	175 mm (150-200 mm)	with	without	Transparent
6Y512=235X175-G	235 mm (240-265 mm)	175 mm (150-200 mm)	with	without	Transparent
6Y512=265X175-G	265 mm (260-280 mm)	175 mm (150-200 mm)	with	without	Transparent
6Y512=280X175-G	280 mm (285-310 mm)	175 mm (150-200 mm)	with	without	Transparent
6Y512=300X175-G	300 mm (310-335 mm)	175 mm (150-200 mm)	with	without	Transparent
6Y512=250X75-F-G	250 mm (255-275 mm)	75 mm (50-100 mm)	with	with	Anthracite
6Y512=210X125-F-G	210 mm (215-235 mm)	125 mm (100-150 mm)	with	with	Anthracite
6Y512=235X125-F-G	235 mm (240-265 mm)	125 mm (100-150 mm)	with	with	Anthracite
6Y512=265X125-F-G	265 mm (260-280 mm)	125 mm (100-150 mm)	with	with	Anthracite
6Y512=280X125-F-G	280 mm (285-310 mm)	125 mm (100-150 mm)	with	with	Anthracite
6Y512=300X125-F-G	300 mm (310-335 mm)	125 mm (100-150 mm)	with	with	Anthracite
6Y512=210X175-F-G	210 mm (215-235 mm)	175 mm (150-200 mm)	with	with	Anthracite
6Y512=235X175-F-G	235 mm (240-265 mm)	175 mm (150-200 mm)	with	with	Anthracite
6Y512=265X175-F-G	265 mm (260-280 mm)	175 mm (150-200 mm)	with	with	Anthracite
6Y512=280X175-F-G	280 mm (285-310 mm)	175 mm (150-200 mm)	with	with	Anthracite
6Y512=300X175-F-G	300 mm (310-335 mm)	175 mm (150-200 mm)	with	with	Anthracite
6Y512=250X75	250 mm (255-275 mm)	75 mm (50-100 mm)	without	without	Transparent
6Y512=210X125	210 mm (215-235 mm)	125 mm (100-150 mm)	without	without	Transparent
6Y512=235X125	235 mm (240-265 mm)	125 mm (100-150 mm)	without	without	Transparent
6Y512=265X125	265 mm (260-280 mm)	125 mm (100-150 mm)	without	without	Transparent
6Y512=280X125	280 mm (285-310 mm)	125 mm (100-150 mm)	without	without	Transparent
6Y512=300X125	300 mm (310-335 mm)	125 mm (100-150 mm)	without	without	Transparent
6Y512=210X175	210 mm (215-235 mm)	175 mm (150-200 mm)	without	without	Transparent
6Y512=235X175	235 mm (240-265 mm)	175 mm (150-200 mm)	without	without	Transparent
6Y512=265X175	265 mm (260-280 mm)	175 mm (150-200 mm)	without	without	Transparent
6Y512=280X175	280 mm (285-310 mm)	175 mm (150-200 mm)	without	without	Transparent
6Y512=300X175	300 mm (310-335 mm)	175 mm (150-200 mm)	without	without	Transparent
6Y512=250X75-F	250 mm (255-275 mm)	75 mm (50-100 mm)	without	with	Anthracite
6Y512=210X125-F	210 mm (215-235 mm)	125 mm (100-150 mm)	without	with	Anthracite
6Y512=235X125-F	235 mm (240-265 mm)	125 mm (100-150 mm)	without	with	Anthracite
6Y512=265X125-F	265 mm (260-280 mm)	125 mm (100-150 mm)	without	with	Anthracite
6Y512=280X125-F	280 mm (285-310 mm)	125 mm (100-150 mm)	without	with	Anthracite
6Y512=300X125-F	300 mm (310-335 mm)	125 mm (100-150 mm)	without	with	Anthracite
6Y512=210X175-F	210 mm (215-235 mm)	175 mm (150-200 mm)	without	with	Anthracite
6Y512=235X175-F	235 mm (240-265 mm)	175 mm (150-200 mm)	without	with	Anthracite
6Y512=265X175-F	265 mm (260-280 mm)	175 mm (150-200 mm)	without	with	Anthracite
6Y512=280X175-F	280 mm (285-310 mm)	175 mm (150-200 mm)	without	with	Anthracite
6Y512=300X175-F	300 mm (310-335 mm)	175 mm (150-200 mm)	without	with	Anthracite

Information material

647G1144=ALL_INT	IFU Liners (qualified personnel)
647G380=ALL_INT	IFU Liners (qualified personnel)

Amputation level	Trans tibial amputation
Material	Polyurethane
Connection	Without distal connection
Distal cushion	15 mm
Wall thickness	9 mm build-ups at the tibial crest and fibular head, from 6 mm distally, tapering to 3 mm proximally
Exterior coating	without
Socket design	Total surface weight-bearing socket
Matrix	without

Socket technologies

Uneo liner



Uneo Unique

Reference number 6Y400

With the Uneo Unique liner from Ottobock, you can offer your patients an individual, made-to-measure solution that provides them with an unrivalled fit. Thanks to the extraordinary flow properties of the polyurethane material, this custom liner is very comfortable to wear.

Key features

- Very good pressure distribution within the prosthetic socket
- Cushions even highly sensitive or scarred residual limbs
- Reliable damping of shocks and impacts
- Available with fresh fragrance and Skinguard antibacterial additive

Information material

647G1144=ALL_INT IFU Liners (qualified personnel)

Ordering options

Reference number	6Y400	
Wall thickness		
Uniform	6 mm uniform	
Tapering proximally	6 mm MPT to 3 mm proximal	
Distal cushion		
Locking	18 mm	
Cushion	13 mm	
Connection system		
Dynamic Vacuum System	TT	
Shuttle Lock	TT / TF	
KISS	-	
Textile		
Textile cover options	No textile With partial textile cover With full textile	
Available textile materials	Spandex textile 0.6 mm skin colour Spandex textile 0.6 mm black Wearforce textile 1.6 mm skin colour Wearforce textile 1.6 mm black Silver textile 1.0 mm	
Additive		
Fresh (fresh fragrance)	optional	
Skinguard (antibacterial)	optional	
Treatment options		
	TT	TF
KISS Lanyard System	-	•
Shuttle Lock System	•	•
Valve System	x	•
Dynamic Vacuum System	x	-
Harmony (P3 & P4)	x	•
Harmony (E2)	x	•

x recommended | • possible | - not possible

• To order, please follow the ordering procedure and use the order form at the end of the "Socket technologies" section.

Customised products from Ottobock iFab

Ottobock iFab is an extended workbench that serves as your reliable partner for the centralised fabrication of custom devices in orthotics and prosthetics in the era of digital transformation.

For information about iFab products, or if you have questions or comments, please contact us: ifab@ottobock.com

iFab Customer Center

You can find the entire digital portfolio of custom products in the iFab Customer Center. The platform guides you through the ordering process quickly and easily.

You can reach the iFab Customer Center at: www.ifab-customer-center.com.



Socket technologies

Accessories

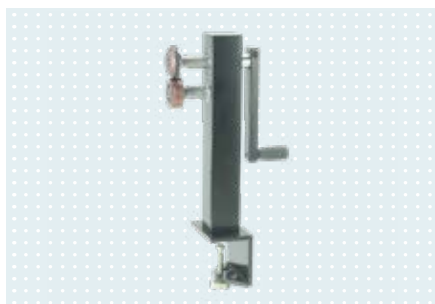

Liner trimmer

Reference number 756L10

For trimming and bevelling the proximal end of gel liners in one process step. The liner trimmer leaves a smooth edge.

Technical data

Article number	Weight
756L10	2.9 kg

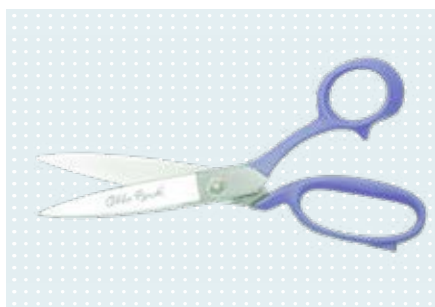

Special scissors for cutting synthetic fabrics

Reference number 719S20

For cutting fabric covered liners. The scissors' special coating is designed to cut through synthetic fibres and ensure effective protection against abrasive wear. The coating makes the scissor blades especially durable. Friction constantly replenishes the ceramic oxide layer. The scissors are resistant against UV and perspiration and extremely corrosion resistant. The very low-friction coating allows the scissors to cut modern high-performance fabrics easily.

Technical data

Article number	Weight
719S20	0.2 kg



Scissors

Reference number 719S7

With the special blades, these sizing scissors are ideal for cutting silicone liners.

Technical data

Article number	Length	Material	Weight
719S7	230 mm	Crucible steel	0.145 kg



Donning spray

Reference number 640F18

The donning spray for Ottobock Skeo liners and prosthetic gloves (silicone, PVC) is needed among other things for putting on and removing the liner or prosthetic glove.

Technical data

Article number	for	Contents
640F18	Prosthetic gloves and liners	90 ml
640F18=900	Prosthetic gloves and liners	900 ml



Derma Prevent

Reference number 453H12

Derma Prevent provides special protection for highly stressed skin. The lotion prevents chafing, protects the skin and keeps it soft and supple. It also inhibits contact with external allergens and reduces perspiration and odour formation.

Technical data

Article number	Order unit	Packaging	Contents
453H12	bottle	Package of 6	100 ml
453H12=1	bottle	1 piece	100 ml



Derma Clean

Reference number 453H10

Derma Clean is a special cleaning lotion for highly stressed skin. The pH-neutral lotion featuring an antibacterial formula is free of alkali and phosphates. Derma Clean is also suitable for cleaning the prosthesis, orthosis or liner.

Technical data

Article number	Order unit	Packaging	Contents
453H10-N	bottle	Package of 6	300 ml
453H10=1-N	bottle	1 piece	300 ml



Derma Repair

Reference number 453H14

Derma Repair provides special basic skin care with panthenol and vitamin E to regenerate highly stressed skin. It soothes irritated skin and makes it noticeably more supple and elastic. Using Derma Repair also promotes the skin's blood circulation and cell growth.

Technical data

Article number	Order unit	Packaging	Contents
453H14	bottle	Package of 6	200 ml
453H14=1	bottle	1 piece	200 ml

Socket technologies

Derma functional accessories



Derma travel set

Reference number 453H30

Contains one bottle each of Derma Clean, Derma Prevent and Derma Repair as well as a handy sponge bag.

Technical data

Article number

453H30=GB

453H30=D



Derma trial set

Reference number 646M453

The Derma trial set contains one small trial bottle each of Derma Clean, Derma Prevent and Derma Repair.

Technical data

Article number

646M453



ClickValve

Reference number 21Y21

The ClickValve has a multi-option safety shackle that prevents loss of the upper valve part. The considerably reduced height and the outside diameter along with the unusual design ensure good cosmetic processing in the socket. The valve is compatible with all common liners without a distal connector and can also be used without a liner.

Key features

- Waterproof
- Threadless valve for transfemoral prostheses
- Multi-option safety shackle prevents loss of the upper valve part
- The “click” provides audible feedback for proper valve positioning
- Risk of haematoma is alleviated thanks to lateral air exhaust openings and a flush inside socket surface

Information material

647G678=ALL_INT IFU ClickValve

Technical data

Article number	Air discharge	For hole Ø
21Y21	Automatic	22 mm



PushValve

Reference number 21Y14

The PushValve is opened and closed by pressing together two wings. With its larger size, it is particularly suitable for users with limited finger mobility and for arm prosthesis wearers. The valve is compatible with all common liners without a distal connector and can also be used without a liner.

Key features

- Waterproof
- Threadless valve for transfemoral prostheses
- Easier handling for users, in particular with limited finger mobility

Technical data

Article number	Air discharge	For hole Ø
21Y14	Automatic	22 mm

Information material

647G1560=ALL_INT IFU PushValve, MagValve

Socket technologies

Vacuum socket systems – Valves



MagValve

Reference number 21Y15

The MagValve is a threadless valve that is closed with magnetic force. The valve is compatible with all common liners without a distal connector and can also be used without a liner.

Key features

- Threadless valve for transfemoral prostheses
- Easy handling, especially for patients with restricted finger functionality
- Low structural height
- “Click” sound confirms valve is being used correctly

Technical data

Article number	Air discharge	For hole Ø
21Y15	Automatic	14 mm

Information material

647G1560=ALL_INT IFU PushValve, MagValve



Threaded valve set

Reference number 21Y12

The threaded valve set with manual air discharge creates a vacuum in the prosthetic socket and is suitable for transfemoral prostheses.

The valve is compatible with all common liners without a distal connector and can also be used without a liner.

Technical data

Article number	Air discharge	For hole Ø
21Y12	Manual	24 mm

Information material

647G1639=ALL_INT IFU 21Y12



Flat rubber valve set

Reference number 21Y96

The threadless valve set with manual air discharge is suitable for interim sockets for transfemoral prostheses.

The valve is compatible with all common liners without a distal connector and can also be used without a liner.

Technical data

Article number	Air discharge	For hole Ø	Substance of content
21Y96	Manual	24 mm	contains nickel



Flat rubber valve set with connection tube

Reference number 21Y97

The threadless valve set with manual air discharge is suitable for ISNY sockets for transfemoral prostheses.

The valve is compatible with all common liners without a distal connector and can also be used without a liner.

Technical data

Article number	Air discharge	For hole Ø	Substance of content
21Y97	Manual	24 mm	contains nickel

Information material

647G83=ALL_INT	IFU 21Y97
----------------	-----------



Flat rubber valve set

Reference number 21Y105

The threadless valve set with manual air discharge is suitable for installation in ISNY sockets for transfemoral prostheses.

The valve is compatible with all common liners without a distal connector and can also be used without a liner.

Technical data

Article number	Air discharge	For hole Ø	Substance of content
21Y105	Manual	24 mm	contains nickel



One-way valve

Reference number 4R140

The 4R140 outlet valve is a check valve intended for fabricating vacuum socket systems. It is integrated directly into the socket and is suitable exclusively for transtibial prostheses.

All common liners without a distal connector can be used.

Technical data

Article number	Air discharge
4R140	Automatic

Information material

647G148=ALL_INT	IFU 4R140
-----------------	-----------

Socket technologies

Vacuum socket systems – Valves

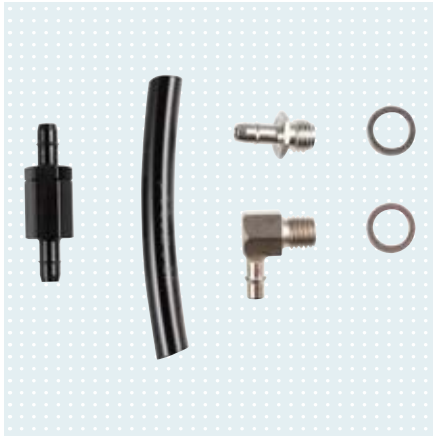

V4 valve set

Reference number 4R136

The 4R136 V4 valve set is suitable for fabricating vacuum socket systems. This set consists of an angled socket connector, a straight socket connector, a valve and a hose. The respective socket connector is screwed in.

All common liners without a distal connector can be used.

Technical data

Article number	Air discharge
4R136	Automatic

Information material

647G1643=ALL_INT	IFU 4R136
------------------	-----------



V4 EasyLine valve set

Reference number 4R136=EL

The 4R136=EL V4 EasyLine valve set is suitable for fabricating vacuum socket systems. The set consists of two socket connectors and one valve. The socket connectors are glued in. All common liners without a distal connector can be used.

Technical data

Article number	Air discharge
4R136=EL	Automatic

Information material

647G529=ALL_INT	IFU 4R136=EL
-----------------	--------------

Accessories/spare parts for valves



Two-hole pin wrench

Reference number 21Y222

This is a service part for the valves with reference numbers 21Y12, 21Y14, 21Y15 and 21Y21.

Technical data

Article number

21Y222

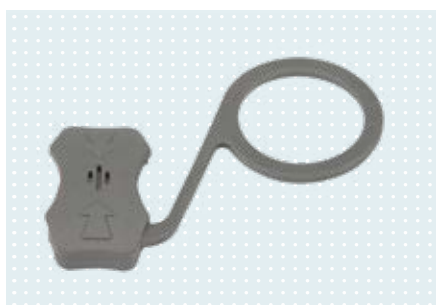

ClickValve safety shackle

Reference number 21Y230

This is a spare part for the 21Y21 ClickValve.

Technical data

Article number

21Y230



ClickValve base

Article number 21Y21=B

This is a spare part for the 21Y21 ClickValve.

Technical data

Article number

21Y21=B



O-ring for ClickValve, black

Article number 627F13=24.5X3

This is a spare part for the 21Y21 ClickValve.

Technical data

Article number

627F13=24.5X3

Socket technologies

Vacuum socket systems – Valves

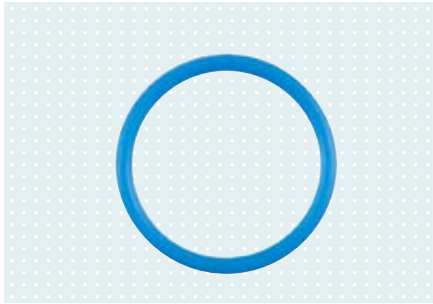

O-ring for ClickValve upper valve part, blue

Article number 627F13=19X2

This is a spare part for the 21Y21 ClickValve.

Technical data

Article number

627F13=19X2



ClickValve

Article number 21Y21=T

This is a spare part for the 21Y21 ClickValve.

Technical data

Article number

21Y21=T



PushValve upper part

Article number 21Y14=S

This is a spare part for the 21Y14 PushValve.

Technical data

Article number

21Y14=S



MagValve upper part

Article number 21Y15=S

This is a spare part for the 21Y15 MagValve.

Technical data

Article number

21Y15=S



Flat silicone valve

Reference number 21Y140

This is a spare part for the 21Y96, 21Y97 and 21Y105 valves.

Technical data

Article number

21Y140

Substance of content

contains nickel



Flat rubber valve

Article number 21Y123=40

This is a spare part for the 21Y96, 21Y97 and 21Y105 valves.

Technical data

Article number	Substance of content
21Y123=40	contains nickel

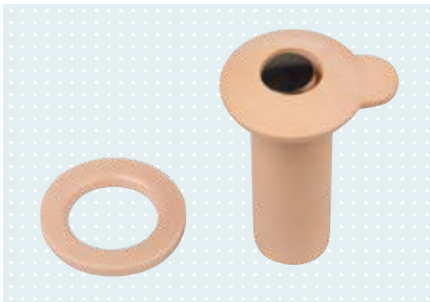

Flat rubber valve

Reference number 21Y94

The rubber flat valve with manual air discharge creates a vacuum in the prosthetic socket. It is suitable for contact adhesion sockets and has a 50 mm long neck as well as a thumb flap and seat ring.

Technical data

Article number	Air discharge	For hole Ø	Substance of content
21Y94	Manual	24 mm	contains nickel



Flat rubber valve

Reference number 21Y95

The rubber flat valve with automatic air discharge and seat ring creates a vacuum in the prosthetic socket.

Technical data

Article number	Air discharge	For hole Ø	Substance of content
21Y95	Automatic	24 mm	contains nickel



Seat ring

Reference number 21Y41

The seat ring for flat rubber valves is available in two sizes with the outside diameters of 32 mm and 40 mm as well as the hole diameters of 20 mm and 24 mm.

Technical data

Article number	For hole Ø
21Y41=32	20 mm
21Y41=40	24 mm

Socket technologies

Vacuum socket systems – Valves



Connecting tube with seat ring

Reference number 21Y77

This is a spare part for the 21Y97 valve.

Technical data

Article number	for	Tube inside Ø
21Y77	Valves with 40 mm outside diameter	24 mm



PVC connection tube

Reference number 99B13

The PVC connection tube serves as a connection channel between the inner and outer sockets.

Technical data

Article number	Diameter	Colour
99B13=16	16 mm	Skin colour
99B13=16-7	16 mm	Black
99B13=21	21 mm	Skin colour
99B13=21-7	21 mm	Black

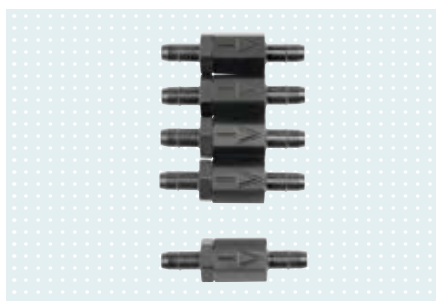

V4 valve, straight

Reference number 4R142

This is a spare part for the 4R136 V4 valve kit and the 4R136=EL V4 EasyLine valve kit as well as the 1C52 Taleo Harmony and 1C62 Triton Harmony prosthetic feet.

Technical data

Article number
4R142



Dynamic Vacuum System pump

Reference number 4R220

The Dynamic Vacuum System for transtibial prostheses offers a comfortably firm hold, convenient volume management and good perception of the ground. A magnetic coupling between the liner and piston generates a permanent vacuum after just a few steps. Can be combined with the following liners: 6Y94=*, 6Y400, 6Y700.



Max. 150 kg

Information material

647G1112=ALL_INT	IFU 4R220
647G1211=ALL_INT	IFU 4R220=1

Technical data

Article image



Article number	4R220	4R220=1
Product features	Load-bearing	Not load-bearing
Weight	210 g	110 g
System height	37 mm	27 mm
Build height	31 mm	40 mm
Mobility grade	2, 3, 4	2, 3, 4
Max. body weight	150 kg	- kg

- The Dynamic Vacuum System requires a pump, a liner and a sealing sleeve.

Can be combined with

Image	Ref.-No.	Product name
	6Y94	Dynamic Vacuum System liner
	6Y400	Uneo Unique
	6Y700	Skeo Unique
	453A3/ 453A4	ProFlex sealing sleeve
	453A30/ 453A40	ProFlex Plus sealing sleeve

- See the respective section for details.

Socket technologies

Vacuum socket systems – Pumps – Dynamic Vacuum System

Accessories/spare parts for 4R220



Duckbill valve

Reference number 21Y226

This is a spare part for the 4R220 and 4R220=1 DVS.

Technical data

Article number

21Y226



Valve bushing

Reference number 4X322

This is a spare part for the 4R220 and 4R220=1 DVS.

Technical data

Article number

4X322



Special grease

Article number 633F30=2

This is a spare part for the 4R220 and 4R220=1 DVS.

Technical data

Article number

633F30=2



Piston

Reference number 4X320

This is a spare part for the 4R220 and 4R220=1 DVS.

Technical data

Article number

4X320

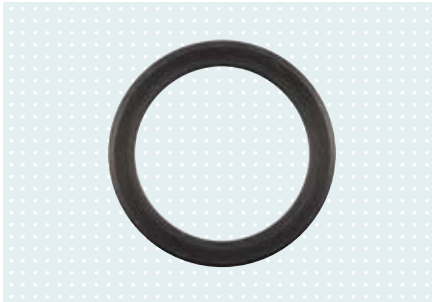

Stop ring

Reference number 4X339

This is a spare part for the 4R220 and 4R220=1 DVS.

Technical data

Article number

4X339

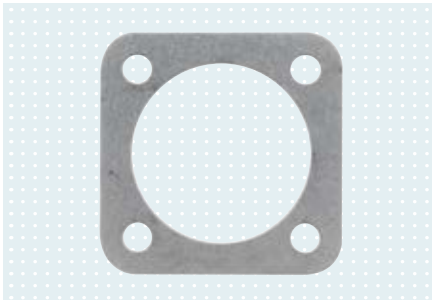

Spacer plate

Reference number 4X314

This is a spare part for the 4R220 DVS.

Technical data

Article number

4X314



Snap bushing

Reference number 5X163

This is a spare part for the 4R220 DVS and the 6A40 MagnoFlex Lock.

Technical data

Article number

5X163

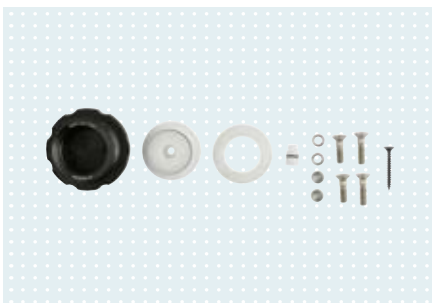

Cylinder body for 4R220

Article number 4X324=3

This is a spare part for the 4R220 DVS.

Technical data

Article number

4X324=3

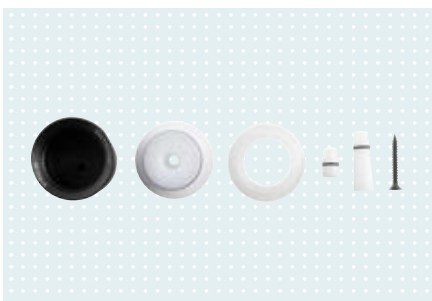

Cylinder body for 4R220=1

Article number 4X324=4

This is a spare part for the 4R220=1 DVS.

Technical data

Article number

4X324=4

Socket technologies

Vacuum socket systems – Pumps – Dynamic Vacuum System

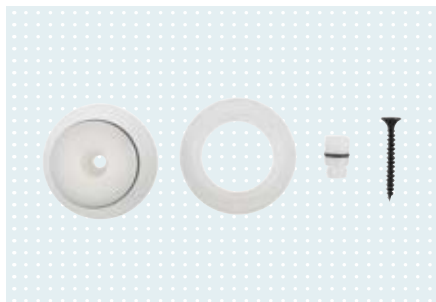

Dummy set for 4R220

Reference number 4X326

This is a spare part for the 4R220 DVS.

Technical data

Article number

4X326

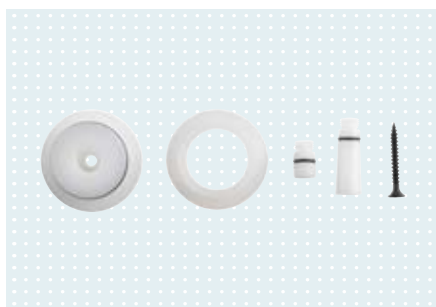

Dummy set for 4R220=1

Reference number 4X326=1

This is a spare part for the 4R220=1 DVS.

Technical data

Article number

4X326=1



Mounting wrench

Reference number 4X338

This is a spare part for the 4R220 and 4R220=1 DVS.

Technical data

Article number

4X338



Harmony P4

Reference number 4R180

The mechanical vacuum pump generates an active vacuum and increases the negative pressure in the prosthetic socket. In combination with an integrated elastomer rod, it dampens vertical impact loads and permits slight torsion of the prosthetic socket.

Key features

- Fast vacuum thanks to double-stroke technology
- Low structural height thanks to direct integration into the prosthetic socket
- Built-in shock absorption and torsion function



Max. 100 kg

Information material

647G1247=ALL_INT IFU Harmony P4, HD

Technical data

Article number	4R180
Proximal connection	Lamination disc
Distal connection	Pyramid receiver
Weight	465 g
System height	132 mm
Build height	114 mm
Mobility grade	2, 3, 4
Recommended for body weight	50 - 100 kg
Max. body weight	100 kg

- Certification is required for treatment with a Harmony system.
- We have successfully tested the following products in combination with Harmony pumps:
 - Polyurethane liners:
 - 6Y512 Uneo 3D
 - Uneo Unique
 - Sealing sleeves to provide proximal sealing:
 - 453A30/453A40 ProFlex Plus

Socket technologies

Vacuum socket systems – Pumps – Harmony system



Harmony P4 HD

Reference number 4R181

The mechanical vacuum pump generates an active vacuum and increases the negative pressure in the prosthetic socket. In combination with an integrated elastomer rod, it dampens vertical impact loads and permits slight torsion of the prosthetic socket.

Key features

- Fast vacuum thanks to double-stroke technology
- Low structural height thanks to direct integration into the prosthetic socket
- Built-in shock absorption and torsion function
- HD version: suitable for a body weight of up to 150 kg



Max. 150 kg

Information material

647G1247=ALL_INT IFU Harmony P4, HD

Technical data

Article number	4R181
Proximal connection	Lamination disc
Distal connection	Pyramid receiver
Weight	590 g
System height	132 mm
Build height	114 mm
Mobility grade	2, 3, 4
Recommended for body weight	50 - 150 kg
Max. body weight	150 kg

- Certification is required for treatment with a Harmony system.
- We have successfully tested the following products in combination with Harmony pumps:
 - Polyurethane liners:
 - 6Y512 Uneo 3D
 - Uneo Unique
 - Sealing sleeves to provide proximal sealing:
 - 453A30/453A40 ProFlex Plus



Harmony P4 modular

Reference number 4R182

The Harmony P4 modular is a completely modular installation version of the Harmony P4 pump. Thanks to novel double-stroke technology, the required vacuum is reached after just a few steps.



Max. 100 kg

Information material

647G1497=ALL_INT IFU Harmony P4 (HD) modular

Technical data

Article number	4R182
Proximal connection	Four-hole connection
Distal connection	Pyramid receiver
Weight	545 g
System height	143 mm
Build height	125 mm
Mobility grade	2, 3, 4
Recommended for body weight	50 - 100 kg
Max. body weight	100 kg

- Certification is required for treatment with a Harmony system.
- We have successfully tested the following products in combination with Harmony pumps:
 - Polyurethane liners:
 - 6Y512 Uneo 3D
 - Uneo Unique
 - Sealing sleeves to provide proximal sealing:
 - 453A30/453A40 ProFlex Plus

Socket technologies

Vacuum socket systems – Pumps – Harmony system



Harmony P4 HD modular

Reference number 4R183

The Harmony P4 HD modular is a complete modular installation version of the Harmony P4 HD pump. Thanks to novel double-stroke technology, the required vacuum is reached after just a few steps.

Suitable for a user weight of up to 150 kg.



Max. 150 kg

Information material

647G1497=ALL_INT IFU Harmony P4 (HD) modular

Technical data

Article number	4R183
Proximal connection	Four-hole connection
Distal connection	Pyramid receiver
Weight	665 g
System height	143 mm
Build height	125 mm
Mobility grade	2, 3, 4
Recommended for body weight	50 - 150 kg
Max. body weight	150 kg

- Certification is required for treatment with a Harmony system.
- We have successfully tested the following products in combination with Harmony pumps:
 - Polyurethane liners:
 - 6Y512 Uneo 3D
 - Uneo Unique
 - Sealing sleeves to provide proximal sealing:
 - 453A30/453A40 ProFlex Plus



Harmony P3

Reference number 4R147

The slim pump weighs only 399 grams and has a low system height. This allows more users to benefit from the advantages of the Harmony system's vacuum solution. The core functionality of the Harmony P3 is provided by a functional ring. It assumes the pumping function, offers vertical shock absorption and permits natural rotation.

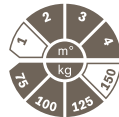

Max. 125 kg

Information material

647G1644=ALL_INT IFU Harmony P3

Technical data

Article number	Proximal connection	Distal connection	Weight	System height	Build height	Mobility grade	Recommended for body weight
4R147=0	Pyramid Receiver	Tube clamp 34 mm	399 g	135 mm	117 mm	2, 3, 4	40 - 47 kg
4R147=1	Pyramid Receiver	Tube clamp 34 mm	399 g	135 mm	117 mm	2, 3, 4	48 - 55 kg
4R147=2	Pyramid Receiver	Tube clamp 34 mm	399 g	135 mm	117 mm	2, 3, 4	56 - 65 kg
4R147=3	Pyramid Receiver	Tube clamp 34 mm	399 g	135 mm	117 mm	2, 3, 4	66 - 75 kg
4R147=4	Pyramid Receiver	Tube clamp 34 mm	399 g	135 mm	117 mm	2, 3, 4	76 - 87 kg
4R147=5	Pyramid Receiver	Tube clamp 34 mm	399 g	135 mm	117 mm	2, 3, 4	88 - 100 kg
4R147=6	Pyramid Receiver	Tube clamp 34 mm	399 g	135 mm	117 mm	2, 3, 4	101 - 112 kg
4R147=7	Pyramid Receiver	Tube clamp 34 mm	399 g	135 mm	117 mm	2, 3, 4	113 - 125 kg

- Certification is required for treatment with a Harmony system.
- We have successfully tested the following products in combination with Harmony pumps:
 - Polyurethane liners:
 - 6Y512 Uneo 3D
 - Uneo Unique
 - Sealing sleeves to provide proximal sealing:
 - 453A30/453A40 ProFlex Plus

Socket technologies

Vacuum socket systems – Pumps – Harmony system



Harmony E2

Reference number 4R152

The Harmony E2 is an electronic pump for the Harmony system. It provides volume management for the residual limb, enhanced suspension and reduced forces in the socket.

Key features

- Electronic pump for the Harmony system
- Volume management on the residual limb
- Four-hole adapter plate for convenient use, e.g. with the 5R2 or 6A94=3 plate and the desired distal adapter
- Free orientation around the tube adapter: medial, lateral or even anterior, posterior
- Two air channels in the connection plate for a direct, tubeless distal connection or the use of a socket connector (e.g. for retrofitting)
- Easy removal of the pump unit, e.g. for charging, weight reduction or switching between different leg prostheses. The adapter plate with an integrated valve keeps the vacuum in the socket.

Information material

647G822=ALL_INT IFU Harmony E2

Product example



Technical data

Article number	Proximal connection	Distal connection	Weight	System height	Build height
4R152	Four-hole connection	Four-hole connection	185 g	95 mm	22 mm
4R152=1	Four-hole connection	Four-hole connection	185 g	95 mm	22 mm

- The 4R152=1 enables installation close to the knee joint (see illustration on the left).
- Certification is required for treatment with a Harmony system.
- Please check potential ground contact because of the system height for low profile alignments.
- We have successfully tested the following products in combination with Harmony pumps:
 - Polyurethane liners:
 - 6Y512 Uneo 3D
 - Uneo Unique
 - Sealing sleeves to provide proximal sealing:
 - 453A30/453A40 ProFlex Plus

Accessories/spare parts for 4R180, 4R181, 4R182, 4R183, 4R147, 4R152



Harmony elastomer rod (red)

Reference number 4Y347

The 4Y347 is a spare part for the Harmony P4.

Technical data

Article number

4Y347



Harmony elastomer rod (yellow)

Reference number 4Y348

The 4Y348 is a spare part for the Harmony P4.

Technical data

Article number

4Y348



Cover for 4R182/4R183

Reference number 4X356

The 4X356 cover is a spare part for the 4R182 Harmony P4 modular pump and the 4R183 Harmony P4 HD modular pump. Aside from the cover, the scope of delivery includes a connection hose.

Technical data

Article number

4X356



Lamination disc and dummy

Reference number 4X903

The 4X903 is a spare part for the 4R180 and 4R181. It consists of a lamination disc and a lamination dummy.

Technical data

Article number

4X903

Socket technologies

Vacuum socket systems – Pumps – Harmony system



Harmony P4 housing screw connection

Reference number 4X904

The 4X904 is a spare part for the 4R180 and 4R182. It consists of a housing screw connection and four M4x6 set screws.

Technical data

Article number

4X904



Harmony P4 HD housing screw connection

Reference number 4X446

The 4X446 is a spare part for the 4R181 and 4R183. It consists of a housing screw connection and four M4x6 set screws.

Technical data

Article number

4X446



Functional ring for Harmony P3

Reference number 4X147

The 4X147 functional ring is a spare part for the 4R147 Harmony P3 and the 1C62 Triton Harmony prosthetic foot. The scope of delivery includes the functional ring with two valves, two O-rings, spacer washer and lubricant.

Technical data

Article number	Max. body weight	Functional ring stiffness
4X147=0	40 - 47 kg	0
4X147=1	48 - 55 kg	1
4X147=2	56 - 65 kg	2
4X147=3	66 - 75 kg	3
4X147=4	76 - 87 kg	4
4X147=5	88 - 100 kg	5
4X147=6	101 - 112 kg	6
4X147=7	113 - 125 kg	7
4X147=8	126 - 137 kg	8
4X147=9	138 - 150 kg	9

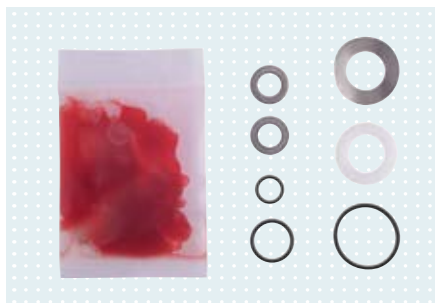

Harmony P3 service set

Reference number 4X148

The 4X148 service set is a spare part for the Harmony P3 system. It consists of two small and two large spacer washers, three O-rings and a lubricant.

Technical data

Article number

4X148

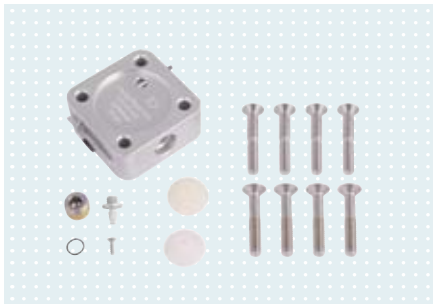

Adapter plate

Reference number 4R153

The adapter plate with integrated valve maintains the vacuum in the prosthetic socket and facilitates straightforward use, e.g. with the 5R2 or 6A94=3 plate and the desired distal adapter.

The 4R153 is a spare part for the 4R152. The 4R153=1 is a spare part for the 4R152=1.

Technical data

Article number

4R153

4R153=1



Socket connector

Reference number 2R117

The socket connector forms the connection between the socket and Harmony pump.

Technical data

Article number

2R117=0

- For use with SL=P091 PU adhesive.



Vacuum connector

Reference number 2R119

Easy-to-use vacuum connector for the connection between the socket and Harmony pump. The design is based on the PushValve and therefore makes it much easier to apply the prosthesis. Aside from the vacuum connection, the scope of delivery includes all parts required for the connection.

Technical data

Article number

2R119



Liner Fit Kit

Reference number 451F20

The liner Fit Kit for Uneo liners consists of four socks, two nylon protective sleeves, two spots and a Fit Kit video.

Technical data

Article number

451F20

Socket technologies

Vacuum socket systems – Pumps – Harmony system



Lubricating cream

Reference number 453H1

Increases the flow properties of the Uneo liners. Recommended use in conjunction with textile-free polyurethane liners.

Technical data

Article number	Contents
453H1=1	100 ml



Harmony vacuum pump set

Reference number 755E20

The Harmony vacuum pump set is used to fabricate the plaster cast as part of the vacuum technique.

Set with latex casting bags.

Technical data

Article number	Operating voltage
755E20=230	230 V
755E20=110	110 V



Latex casting bags

Reference number 683G1

For fabricating plaster casts using the vacuum technique. The scope of delivery includes three latex casting bags: one small, one medium, one large.

Technical data

Article number	Size
683G1=10	Set of 1x small, medium and large

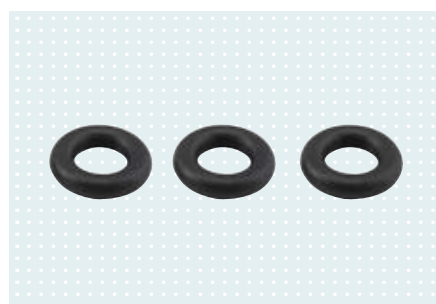

5x2.5 O-ring pack

Reference number 4X315

The 4X315 is a spare part for the 4R152 and consists of three O-rings.

Technical data

Article number
4X315

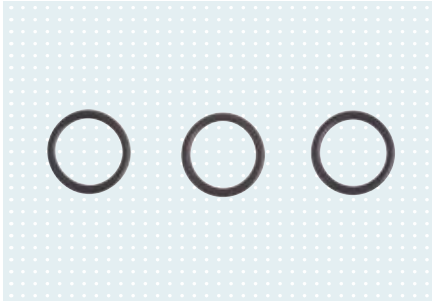

7x1 O-ring pack

Reference number 4X316

The 4X316 is a spare part for the 4R152 and consists of three O-rings.

Technical data**Article number**

4X316



Hose for the outlet

Reference number 4X220

The hose for the outlet is a spare part for the 4R152 Harmony E2.

Technical data**Article number**

4X220

Socket technologies

Socket sealing and harnesses



Derma Protection sealing sleeve

Reference number 453A2

The Derma Protection is a cylindrically shaped sealing sleeve made of a hard-wearing copolymer (TPE) with textile cover. It is used as the primary means of suspension or for sealing a vacuum system.

Key features

- For use with vacuum systems (valve, Dynamic Vacuum System, Harmony)
- Can also be used as the primary suspension system
- Shape: cylindrical

Technical data

Article number	Knee centre circumference	Colour
453A2=1	24 – 32 cm	Beige
453A2=2	30 – 40 cm	Beige
453A2=3	34 – 44 cm	Beige
453A2=4	42 – 56 cm	Beige

Information material

647G281=ALL_INT IFU Sealing Sleeves



ProFlex sealing sleeve

Reference number 453A3/453A4

The ProFlex is an anatomically shaped sealing sleeve made of a hard-wearing copolymer (TPE) with textile cover. It is used as the primary means of suspension or for sealing a vacuum system.

Key features

- Conical shape for a comfortable fit on the thigh
- Pre-shaped patella section for reduced pressure on the patella
- Form: 15° pre-flexion for easier bending of the knee

Technical data

Article number	Knee centre circumference	Circumference 20 cm proximal to knee centre	Overall length	Colour	Detail view
453A3=1	24 - 32 cm	34 - 46 cm	long	Grey	
453A3=2	30 - 40 cm	40 - 54 cm	long	Grey	
453A3=3	36 - 47 cm	48 - 66 cm	long	Grey	
453A3=1-7	24 - 32 cm	34 - 46 cm	long	Black	
453A3=2-7	30 - 40 cm	40 - 54 cm	long	Black	
453A3=3-7	36 - 47 cm	48 - 66 cm	long	Black	
453A4=1	24 - 32 cm	34 - 46 cm	Short	Grey	
453A4=2	30 - 40 cm	40 - 54 cm	Short	Grey	
453A4=3	36 - 47 cm	48 - 66 cm	Short	Grey	
453A4=1-7	24 - 32 cm	34 - 46 cm	Short	Black	
453A4=2-7	30 - 40 cm	40 - 54 cm	Short	Black	
453A4=3-7	36 - 47 cm	48 - 66 cm	Short	Black	

• A = knee centre/MPT B = 20 cm proximal MPT

Information material

647G281=ALL_INT

IFU Sealing Sleeves

Socket technologies

Socket sealing and harnesses



ProFlex Plus sealing sleeve

Reference number 453A30/453A40

The ProFlex Plus is an anatomically shaped sealing sleeve. In addition to the typical features (pre-flexion, conical shape, shaped patella section), it has an elastic textile cover and a flat seam for a virtually imperceptible proximal end. It is used as the primary means of suspension or for sealing a vacuum system.

Key features

- Elastic textile cover for a comfortable proximal end
- Conical shape for a comfortable fit on the thigh
- Pre-shaped patella section for reduced pressure on the patella
- Form: 15° pre-flexion for easier bending of the knee

Technical data

Information material		Article number	Knee centre circumference	Circumference 20 cm proximal to knee centre	Overall length	Colour	Detail view
647G281=ALL_INT	IFU Sealing Sleeves	453A30=1	24 - 32 cm	34 - 46 cm	long	Grey	
		453A30=2	30 - 40 cm	40 - 54 cm	long	Grey	
		453A30=3	36 - 47 cm	48 - 66 cm	long	Grey	
		453A30=1-7	24 - 32 cm	34 - 46 cm	long	Anthracite	
		453A30=2-7	30 - 40 cm	40 - 54 cm	long	Anthracite	
		453A30=3-7	36 - 47 cm	48 - 66 cm	long	Anthracite	
		453A30=1-0	24 - 32 cm	34 - 46 cm	long	Beige	
		453A30=2-0	30 - 40 cm	40 - 54 cm	long	Beige	
		453A30=3-0	36 - 47 cm	48 - 66 cm	long	Beige	
		453A40=1	24 - 32 cm	34 - 46 cm	Short	Grey	
		453A40=2	30 - 40 cm	40 - 54 cm	Short	Grey	
		453A40=3	36 - 47 cm	48 - 66 cm	Short	Grey	
		453A40=1-7	24 - 32 cm	34 - 46 cm	Short	Anthracite	
		453A40=2-7	30 - 40 cm	40 - 54 cm	Short	Anthracite	
		453A40=3-7	36 - 47 cm	48 - 66 cm	Short	Anthracite	
		453A40=1-0	24 - 32 cm	34 - 46 cm	Short	Beige	
		453A40=2-0	30 - 40 cm	40 - 54 cm	Short	Beige	
		453A40=3-0	36 - 47 cm	48 - 66 cm	Short	Beige	

• A = knee centre/MPT, B = 20 cm proximal MPT



Harmony sealing sleeve, cylindrical

Reference number 454A7

The Harmony sealing sleeve made of polyurethane with a durable textile cover creates a tight seal. It is used as the primary means of suspension or for sealing a vacuum system. A gaiter is included with this sealing sleeve.

Key features

- For use with vacuum systems (valve, Dynamic Vacuum System, Harmony)
- Can also be used as the primary suspension system
- Shape: cylindrical

Technical data

Article number	Knee centre circumference
454A7=1	28 – 35.6 cm
454A7=2	30 – 37.5 cm
454A7=3	33 - 40.5 cm
454A7=4	35.5 – 43 cm
454A7=5	38 – 50.5 cm

Information material

647G281=ALL_INT IFU Sealing Sleeves



Harmony sealing sleeve, conical

Reference number 454A8

The Harmony sealing sleeve made of polyurethane with a durable textile cover creates a tight seal. It is used as the primary means of suspension or for sealing a vacuum system. A gaiter is included with this sealing sleeve.

Key features

- For use with vacuum systems (valve, Dynamic Vacuum System, Harmony)
- Can also be used as the primary suspension system
- Shape: conical

Technical data

Article number	Knee centre circumference	Circumference 20 cm proximal to knee centre
454A8=1	25.5 - 33 cm	35 - 43 cm
454A8=2	30.5 - 37 cm	41 - 50 cm
454A8=3	33 - 39 cm	44 - 54 cm
454A8=4	37 – 44.5 cm	49 - 56 cm
454A8=5	43 - 51 cm	53 - 66 cm
454A8=6	48 – 58.5 cm	60 - 70 cm
454A8=7	56 - 66 cm	66 - 75 cm

Information material

647G281=ALL_INT IFU Sealing Sleeves

Socket technologies

Socket sealing and harnesses

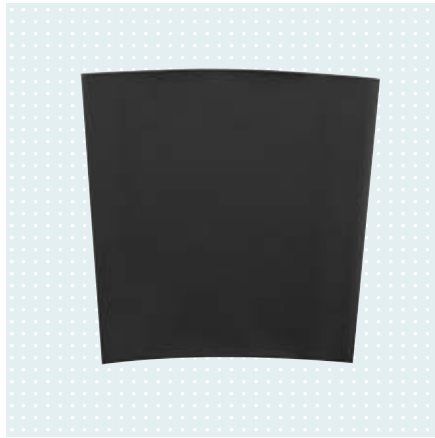

Gaiter for sealing sleeves

Reference number 454A11

The gaiter is intended to increase the lifetime of sealing sleeves. It has a soft Lycra® surface on the inside that slides over the socket brim. The outer surface is impermeable to air, sealing the socket together with the sealing sleeve.

Technical data

Article number	For size	Knee centre circumference
454A11=S	S	25.5 - 35.6 cm
454A11=M	M	30 - 40.5 cm
454A11=L	L	35.5 - 51 cm
454A11=XL	XL	48 - 58.5 cm
454A11=XXL	XXL	56 - 66 cm

Information material

647G281=ALL_INT IFU Sealing Sleeves

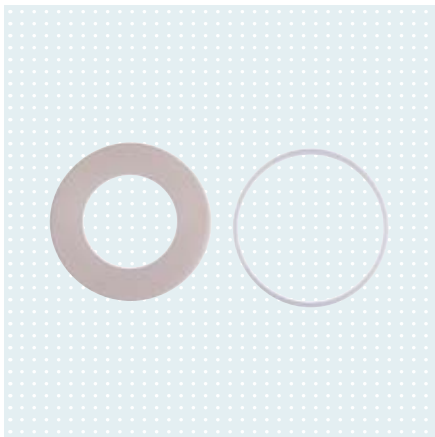

ProSeal ring

Reference number 452A1

The ProSeal ring is suitable for the proximal sealing of transfemoral vacuum sockets with the 6Y81 ProSeal liner.

Technical data

Article number	Proximal circumference
452A1=320	320 mm
452A1=340	340 mm
452A1=360	360 mm
452A1=380	380 mm
452A1=400	400 mm
452A1=420	420 mm
452A1=440	440 mm
452A1=460	460 mm
452A1=480	480 mm
452A1=500	500 mm
452A1=520	520 mm
452A1=540	540 mm
452A1=560	560 mm
452A1=580	580 mm
452A1=600	600 mm
452A1=640	640 mm

Information material

647G597=ALL_INT IFU ProSeal Ring

Product example





TES belt

Reference number 21B37

The total elastic suspension (TES) belts optimise the hold of the prosthesis on the body. The pelvic belt made of polyamide and elastane is fastened with hook-and-loop straps and additionally with buckles. The Neoprene® anti-slip strip at the distal end holds and stabilises the suspension belt.

Technical data

Article number	size	Size	For hip circumference	Socket edge	Colour
21B37=L1	left	S	60 – 74 cm	36 – 40 cm	Beige
21B37=L2	left	M	66 – 80 cm	40 – 44 cm	Beige
21B37=L3	left	L	76 – 90 cm	44 – 48 cm	Beige
21B37=L4	left	XL	86 – 100 cm	48 – 52 cm	Beige
21B37=L5	left	XXL	96 – 110 cm	52 – 56 cm	Beige
21B37=R1	right	S	60 – 74 cm	36 – 40 cm	Beige
21B37=R2	right	M	66 – 80 cm	40 – 44 cm	Beige
21B37=R3	right	L	76 – 90 cm	44 – 48 cm	Beige
21B37=R4	right	XL	86 – 100 cm	48 – 52 cm	Beige
21B37=R5	right	XXL	96 – 110 cm	52 – 56 cm	Beige

Information material

647G1072=ALL_INT

21B37 TES belt
instructions for use

Socket technologies

Shuttle lock systems and lanyard systems–Shuttle locks



Shuttle lock with pyramid

Reference number 6A20

The shuttle lock with pyramid is used to secure a liner in the prosthetic socket. It is suitable for transfemoral and transtibial prostheses. The 6Y13=1 pin is included with this shuttle lock.

All common liners with a distal connector can be used.

Key features

- Coated aluminium housing
- Ratchet unit easy to unlock, even under tensile load
- Includes lamination anchor for laminating



Max. 125 kg

Information material

647G1561=ALL_INT IFU 6A20=10 6A20=20

Technical data

Article number	Distal connection	System height	Build height	Max. body weight
6A20=10	Pyramid	25 mm	43 mm	125 kg



Shuttle lock with pyramid receiver

Reference number 6A20

The shuttle lock with pyramid receiver is used to secure the liner in the prosthetic socket. It is suitable for transfemoral and transtibial prostheses. The 6Y13=2 pin is included with this shuttle lock.

All common liners with a distal connector can be used.

Key features

- Coated aluminium housing
- Ratchet unit easy to unlock, even under tensile load
- Shorter pin
- Includes lamination anchor for laminating

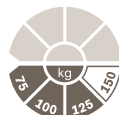

Max. 125 kg

Information material

647G1561=ALL_INT IFU 6A20=10 6A20=20

Technical data

Article number	Distal connection	System height	Build height	Max. body weight
6A20=20	Pyramid receiver	79 mm	61 mm	125 kg



Shuttle lock

Reference number 6A30

The shuttle lock is used to secure the liner in the prosthetic socket. It is suitable for trans-femoral and transtibial prostheses. The 6Y13=1 pin is included with this shuttle lock. All common liners with a distal connector can be used.

Key features

- Coated aluminium housing
- Ratchet unit easy to unlock, even under tensile load
- Integration into the socket

Technical data

Article number	Build height
6A30=10N	37 mm

Information material

647G415=ALL_INT IFU 6A30=10



Shuttle lock, waterproof

Reference number 6A30

The shuttle lock is used to secure the liner in the prosthetic socket. It is suitable for trans-femoral and transtibial prostheses. The 6Y13=1 pin is included with this shuttle lock. All common liners with a distal connector can be used. The 6Y43 Skeo Pure silicone liner with no textile cover is recommended for the waterproof walking aid.

Key features

- Waterproof and corrosion-resistant
- Lightweight plastic housing for use in bathing prostheses
- Ratchet unit easy to unlock, even under tensile load

Technical data

Article number	Build height
6A30=20N	42 mm

Information material

647G1645=ALL_INT IFU 6A30=20N

Socket technologies

Shuttle lock systems and lanyard systems – Shuttle locks



MagnoFlex Lock

Reference number 6A40

The MagnoFlex Lock secures the liner in the prosthetic socket and is suitable for transfemoral and transtibial prostheses. The 6Y13=F1 pin is included with this shuttle lock. All common liners with a distal connector can be used.

Key features

- Straightforward pin guide thanks to flexible pin and integrated magnets
- Quick and straightforward integration into the prosthesis
- 4-hole connector to the modular system
- Available as an option: sliding adapter

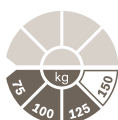

Max. 125 kg

Information material

647G931=ALL_INT

IFU MagnoFlex Lock

Technical data

Article number	Distal connection	System height	Build height	Max. body weight
6A40	4-hole	25 mm	50 mm	125 kg

Accessories/spare parts for Shuttle locks

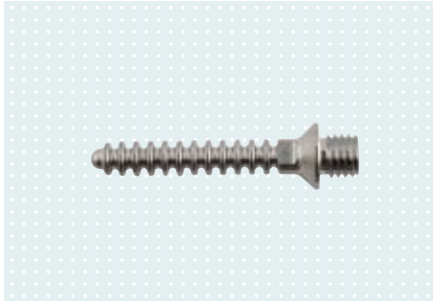

Pin

Article number 6Y13=1

This is a spare part for the 6A20=10, 6A30=10N and 6A30=20N shuttle locks.

Technical data

Article number	Length
6Y13=1	49.5 mm

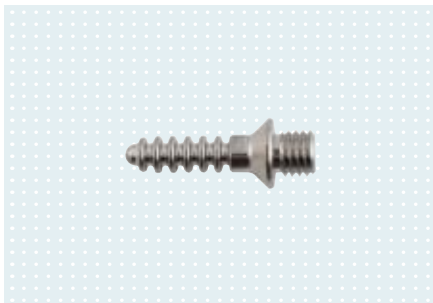

Pin, short

Article number 6Y13=2

This is a spare part for the 6A20=10, 6A20=20, 6A30=10N and 6A30=20N shuttle locks.

Technical data

Article number	Length
6Y13=2	31 mm

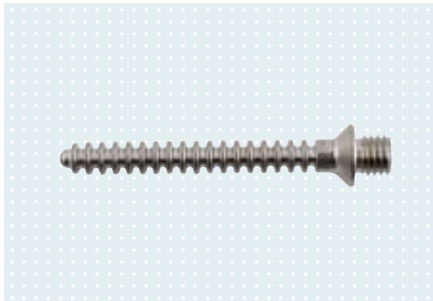

Pin, long

Article number 6Y13=L1

This is a spare part for the 6A20=10, 6A30=10N and 6A30=20N shuttle locks.

Technical data

Article number	Length
6Y13=L1	68.7 mm

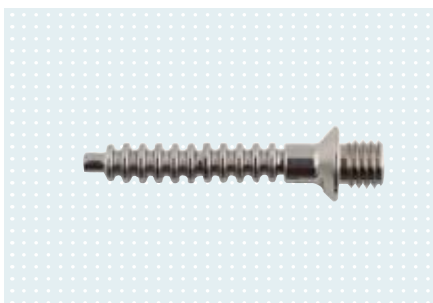

Flexible pin for MagnoFlex lock

Article number 6Y13=F1

This is a spare part for the 6A40 MagnoFlex Lock.

Technical data

Article number	Length
6Y13=F1	47.8 mm

Socket technologies

Shuttle lock systems and lanyard systems–Shuttle locks



Ratchet unit

Article number 6A52

This is a spare part for the 6A20=10, 6A20=20 and 6A30=10N shuttle locks.

Technical data

Article number

6A52



Ratchet unit

Article number 6A52=K

This is a spare part for the 6A30=20N and 6A40 shuttle locks.

Technical data

Article number

6A52=K



Plastic tab for 6A52

Reference number 6A61

This is a spare part for the 6A20=10, 6A20=20, 6A30=10N, 6A30=20N and 6A40 shuttle locks.

Technical data

Article number

6A61



Lamination disc

Reference number 5R2

This is an accessory for the 6A30=20N shuttle lock.

Technical data

Article number	Material	System height	Build height	Weight	Max. body weight
5R2	Aluminium	9 mm	9 mm	70 g	150 kg



Socket attachment block

Reference number 5R2=C

This is an accessory for the 6A30=10N and 6A30=20N shuttle locks.

Technical data

Article number	Material	System height	Build height	Weight	Max. body weight
5R2=C	Carbon	10 mm	10 mm	50 g	150 kg



MagnoFlex Lock socket attachment block

Reference number 6A43

This is an accessory for the 6A40 MagnoFlex Lock.

Technical data

Article number	Max. body weight
6A43	125 kg



Slider plate for MagnoFlex Lock

Reference number 6A41

This is an accessory for the 6A40 MagnoFlex Lock.

Technical data

Article number	Max. body weight
6A41	125 kg



Snap bushing

Reference number 5X163

This is a spare part for the 4R220 DVS and the 6A40 MagnoFlex Lock.

Technical data

Article number
5X163



Lamination anchor with threaded connector

Article number 4R111=N/4R111=T

This is a spare part for the 6A20=10 and 6A20=20 shuttle locks.

Technical data

Article number	Material	System height	Weight	Max. body weight
4R111=N	Stainless steel	13 mm	80 g	150 kg



Shuttle lock housing with bushing

Reference number 5X120

The 5X108 dummy set is a spare part for the 6A30=20 product.

Technical data

Article number
5X120

Socket technologies

Shuttle lock systems and lanyard systems–Shuttle locks



Shuttle lock housing with pyramid

Article number 6A51=10

This is a spare part for the 6A20=10 shuttle lock.

Technical data

Article number

6A51=10



Shuttle lock housing with pyramid receiver

Article number 6A51=20

This is a spare part for the 6A20=20 shuttle lock.

Technical data

Article number

6A51=20



Set screw

Article number 506G21=M4X10

The 5X108 dummy set is a spare part for the 6A30=20 shuttle lock.

Technical data

Article number

506G21=M4X10



Dummy set with screw

Reference number 5X55

This is a spare part for the 6A20=10 and 6A20=20 shuttle locks.

Technical data

Article number

5X55



Dummy set

Reference number 5X108

This is a spare part for the 6A30=20N shuttle lock.

Technical data

Article number

5X108



Dummy set

Reference number 5X125

This is a spare part for the 6A30=10N shuttle lock.

Technical data

Article number

5X125

Socket technologies

Shuttle lock systems and lanyard systems – Lanyard systems



KISS lanyard system

Reference number 4R160

The patented KISS lanyard systems are used for fixation in the transfemoral socket. Thanks to the unique combination of the proximal and distal connection between the socket and liner, pistoning and rotational movements are reduced.

The KISS can be put on while sitting down, making it suitable for users with low mobility grades.

Key features

- Unique proximal and distal connection between the socket and liner
- Reduces pistoning and rotation movements
- Especially well suited for users with low mobility grades
- Can be donned while sitting

Information material



647G1646=ALL_INT IFU KISS



Product example



Technical data

Article image	Article number	Article description	Instructions for use	Max. body weight
	4R160=1	The Delrin KISS kit requires a socket adapter for connection to the modular system.	<ul style="list-style-type: none"> · Contracted residual limbs · Carbon frame sockets in combination with ThermoLyn® soft 	-
	4R160=2	The four-hole endoskeletal KISS kit has a direct connection to the modular system.	<ul style="list-style-type: none"> · Sockets that are laminated entirely from ThermoLyn® soft without using an inner socket · Residual limb positions approximately equivalent to the alignment reference line 	150 kg

Accessories/spare parts for 4R160

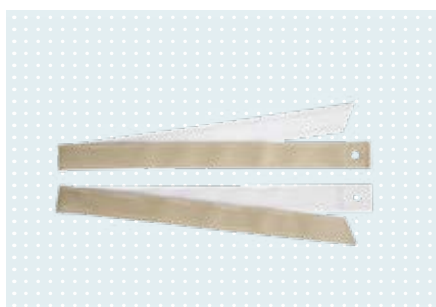

KISS distal belts (2 pieces)

Reference number 4R165

This is a spare part for the 4R160=1 and 4R160=2 KISS.

Technical data

Article number

4R165

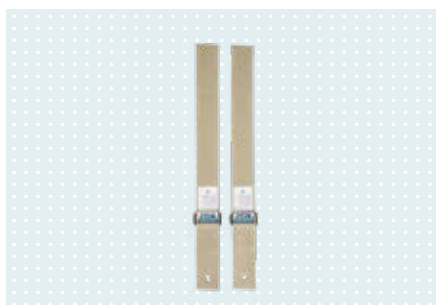

KISS proximal belts (2 pieces)

Reference number 4R166

This is a spare part for the 4R160=1 and 4R160=2 KISS.

Technical data

Article number

4R166

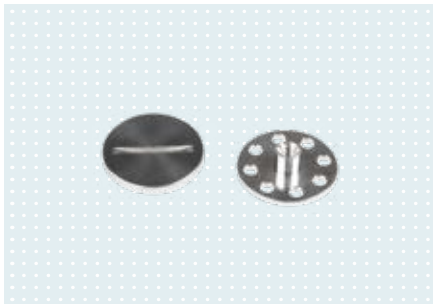

KISS proximal nut and screw (set)

Reference number 4R167

This is a spare part for the 4R160=1 and 4R160=2 KISS.

Technical data

Article number

4R167



KISS hook-and-loop fixation (set with screw and nut)

Reference number 4R175

This is a spare part for the 4R160=1 and 4R160=2 KISS.

Technical data

Article number

4R175



KISS Delrin base

Reference number 4R163

This is a spare part for the 4R160=1 KISS.

Technical data

Article number

4R163



KISS 4-hole base

Reference number 4R164

This is a spare part for the 4R160=2 KISS.

Technical data

Article number

4R164

Socket technologies

Shuttle lock systems and lanyard systems–Lanyard systems



KISS distal screws (two pieces)

Reference number 4R174

This is a spare part for the 4R160=1 and 4R160=2 KISS.

Technical data

Article number

4R174



Lamination set

Reference number 4R161

This is an accessory for the 4R160=2 KISS.

Technical data

Article number

4R161

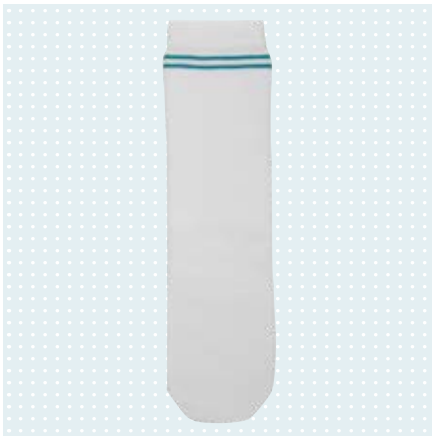

Residual limb sock

Reference number 451F24

This residual limb sock is made of thin cotton in the distal 1/3 and terry cloth in the proximal 2/3. It is ideally suited for managing partial volume fluctuations. It is available in the lengths 30 cm, 35 cm, 40 cm and 45 cm.

Can be cleaned in the washing machine at 60 °C.

Key features

- Distal: 1/3 thin cotton
- Proximal: 2/3 terry cloth

Technical data

Article number	Length
451F24=30	30 cm
451F24=35	35 cm
451F24=40	40 cm
451F24=45	45 cm



Residual limb sock with distal hole

Reference number 451F25

This residual limb sock is made of terry cloth in the distal 1/3 and thin cotton in the proximal 2/3. It is ideally suited for managing partial volume fluctuations. It has a distal hole for use with liners with a connector and is available in the lengths 30 cm, 35 cm, 40 cm and 45 cm.

Can be cleaned in the washing machine at 60 °C.

Key features

- Distal: 1/3 terry cloth
- Proximal: 2/3 thin cotton
- For use with liners with a connector

Technical data

Article number	Length
451F25=30	30 cm
451F25=35	35 cm
451F25=40	40 cm
451F25=45	45 cm

Product example

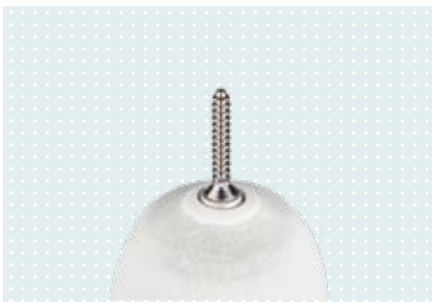

Socket technologies

Residual limb socks for volume management



Residual limb sock

Reference number 451F26

This residual limb sock is made of terry cloth in the distal 1/3 and thin cotton in the proximal 2/3. It is ideally suited for managing partial volume fluctuations. It is available in the lengths 30 cm, 35 cm, 40 cm and 45 cm.

Can be cleaned in the washing machine at 60 °C.

Key features

- Distal: 1/3 terry cloth
- Proximal: 2/3 thin cotton

Technical data

Article number	Length
451F26=30	30 cm
451F26=35	35 cm
451F26=40	40 cm
451F26=45	45 cm



Residual limb sock with distal hole

Reference number 451F27

This residual limb sock is made of thin cotton in the distal 1/3 and terry cloth in the proximal 2/3. It is ideally suited for managing partial volume fluctuations. It has a distal hole for use with liners with a connector and is available in the lengths 30 cm, 35 cm, 40 cm and 45 cm.

Can be cleaned in the washing machine at 60 °C.

Key features

- Distal: 1/3 thin cotton
- Proximal: 2/3 terry cloth
- For use with liners with a connector

Technical data

Article number	Length
451F27=30	30 cm
451F27=35	35 cm
451F27=40	40 cm
451F27=45	45 cm

Product example

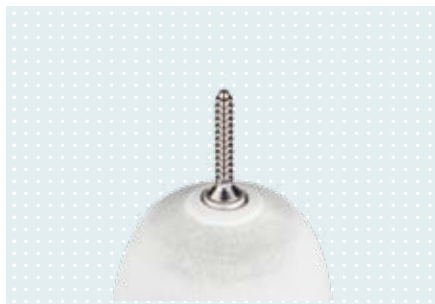



Terry cloth residual limb sock

Reference number 451F2

The terry cloth residual limb sock is white and soft to the touch and is used for transtibial prostheses. Made of cotton (85%) and polyamide (15%), it is available in various lengths.

Key features

- Consistent sock thickness

Technical data

Article number	Length
451F2=20	20 cm
451F2=25	25 cm
451F2=30	30 cm
451F2=35	35 cm
451F2=40	40 cm
451F2=45	45 cm
451F2=50	50 cm
451F2=60	60 cm
451F2=80	80 cm



Cotton residual limb sock

Reference number 451F3

The cotton residual limb sock is white, fine and thin and is used for transtibial prostheses. Made of cotton (80%), polyamide (17%) and spandex (3%), it is available in various lengths.

Key features

- Consistent sock thickness

Technical data

Article number	Length
451F3=20	20 cm
451F3=25	25 cm
451F3=30	30 cm
451F3=35	35 cm
451F3=40	40 cm
451F3=45	45 cm
451F3=50	50 cm
451F3=60	60 cm

Socket technologies

Residual limb socks for volume management



Nylon sheath with distal hole

Reference number 451F4

The nylon sheath is white and has a distal hole for use with liners with a connector. Made of polyamide (90%) and spandex (10%), it is suitable for transtibial and transfemoral prostheses and is available in two lengths for each prosthesis type.

Key features

- Consistent sock thickness
- For use with liners with a connector

Technical data

Article number	Length
451F4=11-30	30 cm
451F4=11-40	40 cm
451F4=20-30	30 cm
451F4=20-40	40 cm

Product example

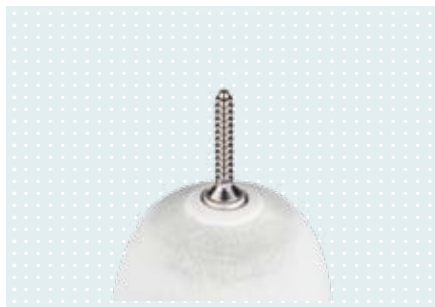

Terry cloth residual limb sock with distal hole

Reference number 451F6

The terry cloth residual limb sock is white and has a distal hole for use with liners with a connector. Made of cotton (85%) and spandex (15%), it is suitable for transtibial and transfemoral prostheses and is available in two lengths for each prosthesis type.

Key features

- Consistent sock thickness
- For use with liners with a connector

Technical data

Article number	Length
451F6=11-30	30 cm
451F6=11-40	40 cm
451F6=20-30	30 cm
451F6=20-40	40 cm

Product example

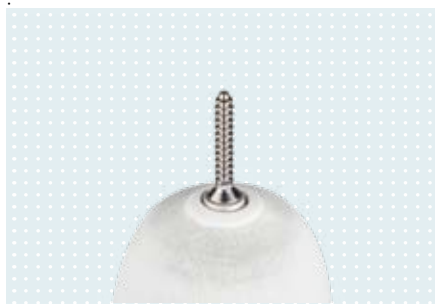



Liner Fit Kit

Reference number 451F20

The liner Fit Kit for Uneo liners consists of four socks, two nylon protective sleeves, two spots and a Fit Kit video.

Technical data

Article number
451F20

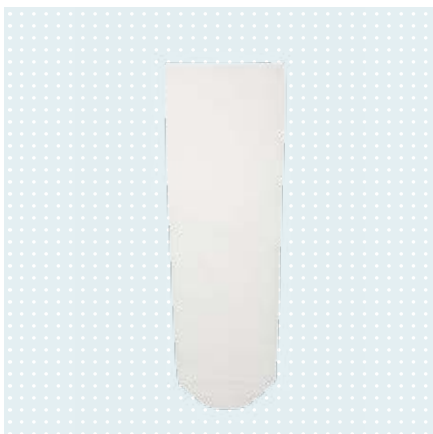

Nylon sheath

Reference number 451F21

The nylon sheath has a proximal double-walled seam and is suitable for transtibial prostheses.

It is available in three different sizes.

Technical data

Article number	Length
451F21=S	25,5 cm
451F21=M	33 cm
451F21=L	40,5 cm



Wool residual limb sock

Reference number 451U1

The wool residual limb sock is suitable for transtibial prostheses and is available in three different lengths. It is made of new wool (70%) and rayon (30%).

Technical data

Article number	Length
451U1=35	35 cm
451U1=45	45 cm
451U1=60	60 cm

Socket technologies

Residual limb socks for volume management



Derma Seal

Reference number 453D7

This residual limb sock is made of nylon stretch fabric and features a soft polymer gel layer on the inside.

Technical data

Article number	Sock length	Gel length	Distal circumference	Proximal circumference
453D7=1	30 cm	20 cm	16 - 22 cm	16 - 25 cm
453D7=2	40 cm	25 cm	18 - 26 cm	18 - 30 cm
453D7=3	40 cm	25 cm	20 - 31 cm	20 - 35 cm
453D7=4	45 cm	33 cm	20 - 31 cm	20 - 35 cm
453D7=5	45 cm	25 cm	23 - 35 cm	23 - 40 cm
453D7=6	50 cm	33 cm	23 - 35 cm	23 - 40 cm
453D7=7	50 cm	33 cm	27 - 40 cm	27 - 45 cm
453D7=8	50 cm	33 cm	30 - 48 cm	30 - 53 cm

Information material

647G1649=ALL_INT IFU 453D4 453D5 453D7

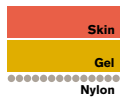

⦿ Possible deviation: ± 10%



Derma Seal Forte

Reference number 453D4

This residual limb sock is made of durable CoolMax® fabric and features a soft polymer gel layer on the inside.

Technical data

Article number	Sock length	Gel length	Distal circumference	Proximal circumference
453D4=1	30 cm	25 cm	15 - 22 cm	20 - 32 cm
453D4=2	30 cm	25 cm	20 - 26 cm	28 - 42 cm
453D4=3	40 cm	30 cm	20 - 26 cm	28 - 45 cm
453D4=10	65 cm	25 cm	15 - 22 cm	20 - 32 cm
453D4=20	75 cm	30 cm	20 - 26 cm	28 - 42 cm

Information material

647G1649=ALL_INT IFU 453D4 453D5 453D7

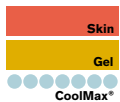

⦿ Possible deviation: ± 10%



Derma Seal Double Forte

Reference number 453D5

This residual limb sock consists of two durable CoolMax® fabric layers. There is a soft polymer gel between these two fabric layers.

Technical data

Article number	Sock length	Gel length	Distal circumference	Proximal circumference
453D5=1	30 cm	25 cm	15 - 20 cm	20 - 28 cm
453D5=2	30 cm	25 cm	20 - 24 cm	28 - 40 cm
453D5=3	40 cm	30 cm	20 - 24 cm	28 - 43 cm
453D5=10	65 cm	25 cm	15 - 20 cm	20 - 28 cm
453D5=20	75 cm	30 cm	20 - 24 cm	28 - 40 cm

● Possible deviation: ± 10%

Information material

647G1649=ALL_INT IFU 453D4 453D5 453D7

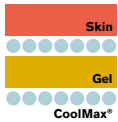

Derma Seal Trans Ped

Reference number 453D2

This high-stretch sock is used for Lisfranc/Chopart partial foot amputees. The Trans Ped has a seamless knit and is made of polyester (95%) and Lycra® spandex (5%). The distal zone inside the sock features a soft polymer gel layer, which protects this specific area from chafing, pressure and loading forces.

Technical data

Article number	Sock length	Size
453D2=N	22 cm	standard
453D2=XL	50 cm	extra long

Information material

647G1635=ALL_INT IFU 453D2

Socket technologies

Volume management spots

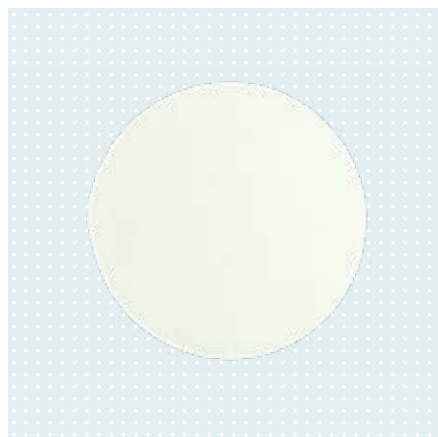

Spots

Reference number 616S134

The spots are PU cushions used to compensate for variations in residual limb volume within the socket.

Technical data

Article number	Diameter
616S134=1	6 cm
616S134=2	9 cm
616S134=3	10 cm
616S134=4	12 cm
616S134=5	14 cm

Information material

647G1647=ALL_INT IFU Sticky Spots



Sticky Spots

Reference number 616S132

The spots are PU cushions used to compensate for volume fluctuations in the socket. These spots have a self-adhesive coating.

Technical data

Article number	Diameter
616S132=1	6 cm
616S132=2	9 cm
616S132=3	10 cm
616S132=4	12 cm
616S132=5	14 cm

Information material

647G1647=ALL_INT IFU Sticky Spots



Residual limb compression sock

Reference number 451F12

The residual limb compression sock with hip attachment is used in transfemoral prostheses. It is assigned to compression class one (CCL1) and is available in the lengths 20 cm, 25 cm, 30 cm and 35 cm.

Information material

647G1632=ALL_INT IFU Compression Socks

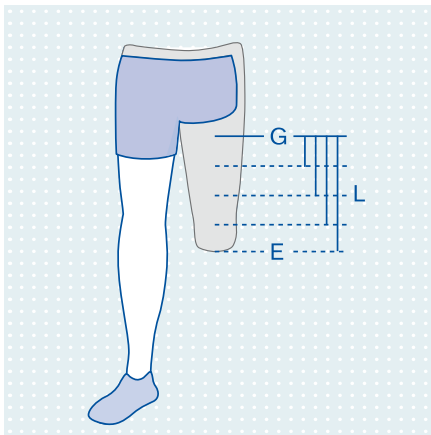

Technical data

Article number	For size	Compression class	Lengths (L) G-E	Circumference E	Circumference G
451F12=XS-20	XS	CCL1	20 cm	29 - 31 cm	41 - 44 cm
451F12=XS-25	XS	CCL1	25 cm	29 - 31 cm	41 - 44 cm
451F12=XS-30	XS	CCL1	30 cm	29 - 31 cm	41 - 44 cm
451F12=XS-35	XS	CCL1	35 cm	29 - 31 cm	41 - 44 cm
451F12=S-20	S	CCL1	20 cm	31 - 34 cm	44 - 48 cm
451F12=S-25	S	CCL1	25 cm	31 - 34 cm	44 - 48 cm
451F12=S-30	S	CCL1	30 cm	31 - 34 cm	44 - 48 cm
451F12=S-35	S	CCL1	35 cm	31 - 34 cm	44 - 48 cm
451F12=M-20	M	CCL1	20 cm	34 - 37 cm	48 - 52 cm
451F12=M-25	M	CCL1	25 cm	34 - 37 cm	48 - 52 cm
451F12=M-30	M	CCL1	30 cm	34 - 37 cm	48 - 52 cm
451F12=M-35	M	CCL1	35 cm	34 - 37 cm	48 - 52 cm
451F12=L-20	L	CCL1	20 cm	37 - 40 cm	52 - 56 cm
451F12=L-25	L	CCL1	25 cm	37 - 40 cm	52 - 56 cm
451F12=L-30	L	CCL1	30 cm	37 - 40 cm	52 - 56 cm
451F12=L-35	L	CCL1	35 cm	37 - 40 cm	52 - 56 cm
451F12=XL-20	XL	CCL1	20 cm	40 - 43 cm	56 - 60 cm
451F12=XL-25	XL	CCL1	25 cm	40 - 43 cm	56 - 60 cm
451F12=XL-30	XL	CCL1	30 cm	40 - 43 cm	56 - 60 cm
451F12=XL-35	XL	CCL1	35 cm	40 - 43 cm	56 - 60 cm
451F12=XXL-20	XXL	CCL1	20 cm	43 - 46 cm	60 - 64 cm
451F12=XXL-25	XXL	CCL1	25 cm	43 - 46 cm	60 - 64 cm
451F12=XXL-30	XXL	CCL1	30 cm	43 - 46 cm	60 - 64 cm
451F12=XXL-35	XXL	CCL1	35 cm	43 - 46 cm	60 - 64 cm

Socket technologies

Compression therapy



Information material

647G1632=ALL_INT IFU Compression Socks

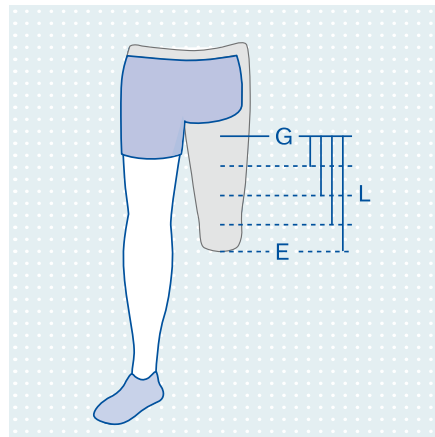

Residual limb compression sock

Reference number 451F11

The residual limb compression sock with hip attachment is used in transfemoral prostheses. It is assigned to compression class two (CCL2) and is available in the lengths 20 cm, 25 cm, 30 cm and 35 cm.

Technical data

Article number	For size	Compression class	Lengths (L) G-E	Circumference E	Circumference G
451F11=XS-20	XS	CCL2	20 cm	29 - 31 cm	41 - 44 cm
451F11=XS-25	XS	CCL2	25 cm	29 - 31 cm	41 - 44 cm
451F11=XS-30	XS	CCL2	30 cm	29 - 31 cm	41 - 44 cm
451F11=XS-35	XS	CCL2	35 cm	29 - 31 cm	41 - 44 cm
451F11=S-20	S	CCL2	20 cm	31 - 34 cm	44 - 48 cm
451F11=S-25	S	CCL2	25 cm	31 - 34 cm	44 - 48 cm
451F11=S-30	S	CCL2	30 cm	31 - 34 cm	44 - 48 cm
451F11=S-35	S	CCL2	35 cm	31 - 34 cm	44 - 48 cm
451F11=M-20	M	CCL2	20 cm	34 - 37 cm	48 - 52 cm
451F11=M-25	M	CCL2	25 cm	34 - 37 cm	48 - 52 cm
451F11=M-30	M	CCL2	30 cm	34 - 37 cm	48 - 52 cm
451F11=M-35	M	CCL2	35 cm	34 - 37 cm	48 - 52 cm
451F11=L-20	L	CCL2	20 cm	37 - 40 cm	52 - 56 cm
451F11=L-25	L	CCL2	25 cm	37 - 40 cm	52 - 56 cm
451F11=L-30	L	CCL2	30 cm	37 - 40 cm	52 - 56 cm
451F11=L-35	L	CCL2	35 cm	37 - 40 cm	52 - 56 cm
451F11=XL-20	XL	CCL2	20 cm	40 - 43 cm	56 - 60 cm
451F11=XL-25	XL	CCL2	25 cm	40 - 43 cm	56 - 60 cm
451F11=XL-30	XL	CCL2	30 cm	40 - 43 cm	56 - 60 cm
451F11=XL-35	XL	CCL2	35 cm	40 - 43 cm	56 - 60 cm
451F11=XXL-20	XXL	CCL2	20 cm	43 - 46 cm	60 - 64 cm
451F11=XXL-25	XXL	CCL2	25 cm	43 - 46 cm	60 - 64 cm
451F11=XXL-30	XXL	CCL2	30 cm	43 - 46 cm	60 - 64 cm
451F11=XXL-35	XXL	CCL2	35 cm	43 - 46 cm	60 - 64 cm



Residual limb compression sock

Reference number 451F13

The residual limb compression sock with silicone anti-slip strip is used for transtibial prostheses. It is assigned to compression class one (CCL1) and is available in the lengths 30 cm, 38 cm and 46 cm.

Information material

647G1632=ALL_INT IFU Compression Socks

Technical data

Article number	For size	Compression class	Lengths (L) F-C	Circumference F	Circumference E	Circumference C
451F13=XS-30-N	XS	CCL1	30 cm	39 - 41 cm	29 - 31 cm	27 - 29 cm
451F13=XS-38-N	XS	CCL1	38 cm	39 - 41 cm	29 - 31 cm	27 - 29 cm
451F13=XS-46-N	XS	CCL1	46 cm	39 - 41 cm	29 - 31 cm	27 - 29 cm
451F13=S-30-N	S	CCL1	30 cm	41 - 44 cm	31 - 34 cm	29 - 32 cm
451F13=S-38-N	S	CCL1	38 cm	41 - 44 cm	31 - 34 cm	29 - 32 cm
451F13=S-46-N	S	CCL1	46 cm	41 - 44 cm	31 - 34 cm	29 - 32 cm
451F13=M-30-N	M	CCL1	30 cm	44 - 47 cm	34 - 37 cm	32 - 35 cm
451F13=M-38-N	M	CCL1	38 cm	44 - 47 cm	34 - 37 cm	32 - 35 cm
451F13=M-46-N	M	CCL1	46 cm	44 - 47 cm	34 - 37 cm	32 - 35 cm
451F13=L-30-N	L	CCL1	30 cm	47 - 50 cm	37 - 40 cm	35 - 38 cm
451F13=L-38-N	L	CCL1	38 cm	47 - 50 cm	37 - 40 cm	35 - 38 cm
451F13=L-46-N	L	CCL1	46 cm	47 - 50 cm	37 - 40 cm	35 - 38 cm
451F13=XL-30-N	XL	CCL1	30 cm	50 - 53 cm	40 - 43 cm	38 - 41 cm
451F13=XL-38-N	XL	CCL1	38 cm	50 - 53 cm	40 - 43 cm	38 - 41 cm
451F13=XL-46-N	XL	CCL1	46 cm	50 - 53 cm	40 - 43 cm	38 - 41 cm
451F13=XXL-30-N	XXL	CCL1	30 cm	60 - 64 cm	43 - 46 cm	41 - 44 cm
451F13=XXL-38-N	XXL	CCL1	38 cm	60 - 64 cm	43 - 46 cm	41 - 44 cm
451F13=XXL-46-N	XXL	CCL1	46 cm	60 - 64 cm	43 - 46 cm	41 - 44 cm

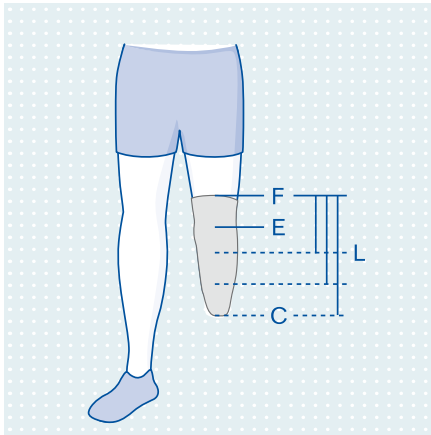

Socket technologies

Compression therapy



Residual limb compression sock

Reference number 451F10

The residual limb compression sock with silicone anti-slip strip is used for transtibial prostheses. It is assigned to compression class two (CCL2) and is available in the lengths 30 cm, 38 cm and 46 cm.

Information material

647G1632=ALL_INT IFU Compression Socks

Technical data

Article number	For size	Compression class	Lengths (L) F-C	Circumference F	Circumference E	Circumference C
451F10=XS-30-N	XS	CCL2	30 cm	39 - 41 cm	29 - 31 cm	27 - 29 cm
451F10=XS-38-N	XS	CCL2	38 cm	39 - 41 cm	29 - 31 cm	27 - 29 cm
451F10=XS-46-N	XS	CCL2	46 cm	39 - 41 cm	29 - 31 cm	27 - 29 cm
451F10=S-30-N	S	CCL2	30 cm	41 - 44 cm	31 - 34 cm	29 - 32 cm
451F10=S-38-N	S	CCL2	38 cm	41 - 44 cm	31 - 34 cm	29 - 32 cm
451F10=S-46-N	S	CCL2	46 cm	41 - 44 cm	31 - 34 cm	29 - 32 cm
451F10=M-30-N	M	CCL2	30 cm	44 - 47 cm	34 - 37 cm	32 - 35 cm
451F10=M-38-N	M	CCL2	38 cm	44 - 47 cm	34 - 37 cm	32 - 35 cm
451F10=M-46-N	M	CCL2	46 cm	44 - 47 cm	34 - 37 cm	32 - 35 cm
451F10=L-30-N	L	CCL2	30 cm	47 - 50 cm	37 - 40 cm	35 - 38 cm
451F10=L-38-N	L	CCL2	38 cm	47 - 50 cm	37 - 40 cm	35 - 38 cm
451F10=L-46-N	L	CCL2	46 cm	47 - 50 cm	37 - 40 cm	35 - 38 cm
451F10=XL-30-N	XL	CCL2	30 cm	50 - 53 cm	40 - 43 cm	38 - 41 cm
451F10=XL-38-N	XL	CCL2	38 cm	50 - 53 cm	40 - 43 cm	38 - 41 cm
451F10=XL-46-N	XL	CCL2	46 cm	50 - 53 cm	40 - 43 cm	38 - 41 cm
451F10=XXL-30-N	XXL	CCL2	30 cm	60 - 64 cm	43 - 46 cm	41 - 44 cm
451F10=XXL-38-N	XXL	CCL2	38 cm	60 - 64 cm	43 - 46 cm	41 - 44 cm
451F10=XXL-46-N	XXL	CCL2	46 cm	60 - 64 cm	43 - 46 cm	41 - 44 cm

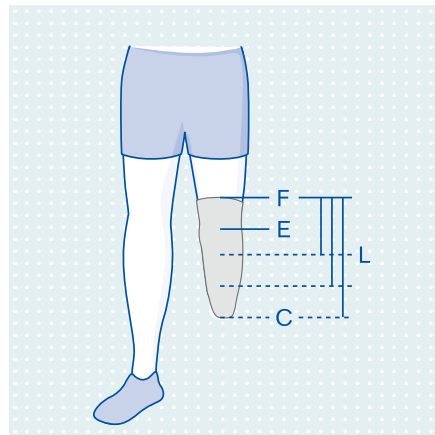

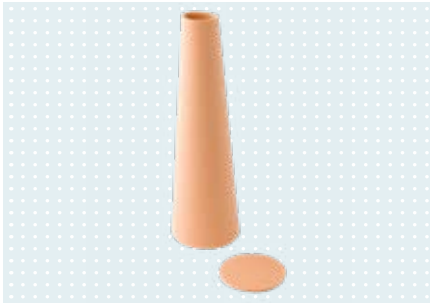

Pedilin cone for soft socket

Reference number 6T2

Pedilin® has proven itself for soft inner sockets over many years. The material retains its shape and is skin-friendly and hygienic. The prefabricated cones have an exact and reliable bond seam. You can start with thermoplastic shaping immediately, eliminating sanding and gluing work.

Technical data

Article number	Circumference 1	Circumference 2	Height	Thickness
6T2=1	420 mm	200 mm	420 mm	5 mm
6T2=2	455 mm	260 mm	420 mm	5 mm
6T2=3	515 mm	295 mm	420 mm	5 mm



Procomfort gel

Reference number 633S2

The gel acts as a lubricant, making the liner easier to put on.

Technical data

Article number	Net contents
633S2	250 ml

Socket technologies

Sockets



Varos

Reference number 5A60

The Varos is an adaptive socket for transfemoral amputations. The user can adapt the Varos to compensate for volume changes.

Technical data

Article number	Side	Distal connection	Residual limb length	Distal residual limb circumference	Proximal residual limb circumference	Mobility grade
5A60=L-M	left (L)	Four-hole connection	200 - 320 mm	350 - 440 mm	460 - 580 mm	1, 2, 3, 4
5A60=R-M	right (R)	Four-hole connection	200 - 320 mm	350 - 440 mm	460 - 580 mm	1, 2, 3, 4

Information material

647G1099=ALL_INT	IFU 5A60 (qualified personnel)
647H901=ALL_INT	IFU 5A60 (user)



Liner

Reference number 6Y200

Varos liner – the liner for the Varos socket system

Technical data

Article number	Distal residual limb circumference
6Y200=M-1	350 mm - 410 mm
6Y200=M-2	380 mm - 440 mm

Information material

647G1239=ALL_INT	IFU Liners (qualified personnel)
------------------	----------------------------------



TF Design check sockets

Reference number 5T9

TF Design is a software solution for the custom design of check sockets and serves as an excellent alternative to the classic plaster cast technique. All socket shapes were developed based on clinically proven knowledge and our experts' many years of expertise. This makes TF Design the ideal introduction to digitisation.

Key features

- You eliminate elaborate plaster casting, plaster modelling, vacuum forming and, when using adapters from iFab, adapter assembly
- This saves 4–5 hours
- Delivery within one working day
- Measuring in the hospital or at the patient's home is possible
- Administration of patient data, residual limb statistics

Information material

646D329=GB	Information for technicians TF Design
646D1204=EN_HQ	Tips and tricks TF Design
647H374	TF Design instructions for use

Technical data

Article image	Article number	Description	Product features
	5T9=S	TF Design check sockets	<ul style="list-style-type: none"> • Check or interim socket made from proven ThermoLyn material • Approved for 6 months as an interim socket
	5T9=M	TF Design check sockets	<ul style="list-style-type: none"> • Foam model made of bubble-free rigid foam for a check or interim socket • Suitable for vacuum forming
	5T9=SM	TF Design check sockets	<ul style="list-style-type: none"> • Check or interim socket made from proven ThermoLyn material • Approved for 6 months as an interim socket • Foam model made of bubble-free rigid foam for a check or interim socket • Suitable for vacuum forming

- The TF Design software can be ordered using reference number 647X6 or alternatively downloaded online at www.ottobock.com/tfdesign.
- To order, please follow the ordering procedure and use the order form at the end of the "Socket technologies" section.

Customised products from Ottobock iFab

Ottobock iFab is an extended workbench that serves as your reliable partner for the centralised fabrication of custom devices in orthotics and prosthetics in the era of digital transformation.

For information about iFab products, or if you have questions or comments, please contact us: ifab@ottobock.com

Socket technologies

Sockets

Accessories/spare parts for 5T9



TT Design/ TF Design case kit

Reference number 743R9

Case including all relevant tools for TT and TF Design

Technical data

Article number

743R9



TF Design bag

Reference number 743R13

Case including all relevant tools for TF Design

Technical data

Article number

743R13



Ottobock TF Design software

Reference number 647X6

CD ROM with TF Design software

Technical data

Article number

647X6



SiOCX TF

Reference number 7T450

By combining innovative materials such as HTV silicone, carbon prepreg and flexible Dyneema woven fabric, SiOCX TF prosthetic sockets ensure optimal bedding of the residual limb as well as optimal control of the prosthesis. SiOCX TF sockets are suitable for users at all activity levels who value functionality, a high degree of mobility, comfort and hygiene.

Key features

- High surface suspension for excellent fixation on the residual limb
 - Greater stability through the use of carbon in the socket attachment block and the outer socket
 - Easy to clean and sterilisable
 - Dermatologically tested material
 - Flexible socket brims that adapt to user movements
 - Gel cushions to protect sensitive areas of the residual limb
 - Enhanced sitting comfort thanks to flexible outer socket sections
- To order, please follow the ordering procedure and use the order form at the end of the "Socket technologies" section.

Information material

646D437=GB	Information for technicians SiOCX TF sockets
646F530=EN	SiOCX TF sockets poster
647G617	SiOCX TF Pro prosthetic sockets instructions for use

Customised products from Ottobock iFab

Ottobock iFab is an extended workbench that serves as your reliable partner for the centralised fabrication of custom devices in orthotics and prosthetics in the era of digital transformation.

For information about iFab products, or if you have questions or comments, please contact us: ifab@ottobock.com

Socket technologies

Sockets



SiOCX TF Pro

Reference number 7T451

With the SiOCX TF Pro, the outer socket has been reduced to the structures necessary for support and guidance of the prosthesis. In the front and rear, the stiff socket brim is replaced by a flexible, strong Dyneema strap. This results in an improved sense of surroundings, more comfortable sitting and greater freedom of movement for the musculature.

Key features

- High surface suspension for excellent fixation on the residual limb
- Greater stability through the use of carbon in the socket attachment block and the outer socket
- Easy-to-clean solution that can be sterilised
- Dermatologically tested material
- Flexible socket brims that adapt to user movements
- Gel cushions to protect sensitive areas of the residual limb
- Enhanced sitting comfort thanks to flexible outer socket sections
- Improved sense of surroundings thanks to frame socket

• To order, please follow the ordering procedure and use the order form at the end of the "Socket technologies" section.

Information material

646D437=GB	Information for technicians SiOCX TF sockets
646F530=EN	SiOCX TF sockets poster
647G617	SiOCX TF Pro prosthetic sockets instructions for use

Customised products from Ottobock iFab

Ottobock iFab is an extended workbench that serves as your reliable partner for the centralised fabrication of custom devices in orthotics and prosthetics in the era of digital transformation.

For information about iFab products, or if you have questions or comments, please contact us: ifab@ottobock.com

Unique custom liner for the lower limbs iFab ordering process

1. Select one of the three options to record the fit for the Unique custom liners:

Ordering option a:

You can use our digital ordering method for Unique custom liners by downloading the iFab EasyScan app and taking patient measurements using the iFab EasyScanner. You can register in the app with your iCC (iFab Customer Center) account. The app guides you through the ordering process step by step.

Ordering option b:

Take a scan of the patient's residual limb, fill in the measurement form and send your data by e-mail to Ottobock iFab.

Ordering option c:

Measure the patient's residual limb and enter the data on the measurement form. Then fabricate an unmodelled plaster negative and send it by post to Ottobock iFab, including the measurement form.

2. Ottobock iFab will fabricate the Unique custom liner for you and ship it within 10–15 working days.

3. Now you can fit your patient with an individual Unique custom liner.

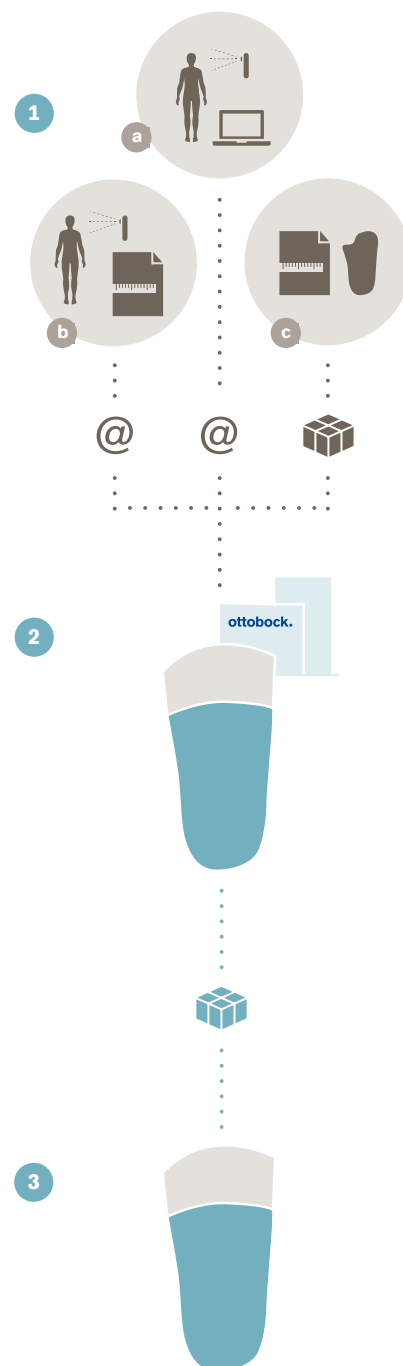

The *iFab EasyScan App* can be downloaded via www.ifab-customer-center.com/downloads

Uneo Unique Liner 6Y400

Order Form – TT and Symes

Contact	Customer number	Date
Customer		Shipping address (if different from customer address)
Company	Company	
Street	Street	
Postal code/city	Postal code/city	
Email	Phone	

Please complete this form and include a scan or cast with patient ID. For alteration liner please call Customer Service.

New Liner Replacement Liner Last Order No.

Patient Information

Uneo Unique Liners are imprinted with your patient ID.

Patient ID:

Left Right
 Transtibial Symes Other:

Select the Appropriate Type of Uneo Unique Liner

Wall Thickness

Uniform (6mm uniform distal wall to proximal)
 Tapered (6mm MPT to 3mm proximal)
 Distal thickness 18mm for locking and 12–13mm for cushion.

Locking Mechanism

Yes* No
 Pin locking
 DVS (Select Partial Textile Cover)
 * Locking Liners must have Exterior Textile selected

Textile Cover

Uncovered Partial Cover
 Full Textile Cover Partial Cover Height: mm

	Tan	Black	Silver
Spandex Fabric	<input type="checkbox"/> 0.6mm	<input type="checkbox"/> 0.6mm	
Wearforce	<input type="checkbox"/> 1.6mm	<input type="checkbox"/> 1.6mm	
Silver Fabric			<input type="checkbox"/> 1.0mm

Additive**

With Fresh scented additive
 With Skinguard antibacterial additive

** Only one can be chosen

Measurements

- Extend measurements as needed. Please mark the MPT and any problem areas on cast or diagramm.
- Please choose between inch or cm and circle one below.

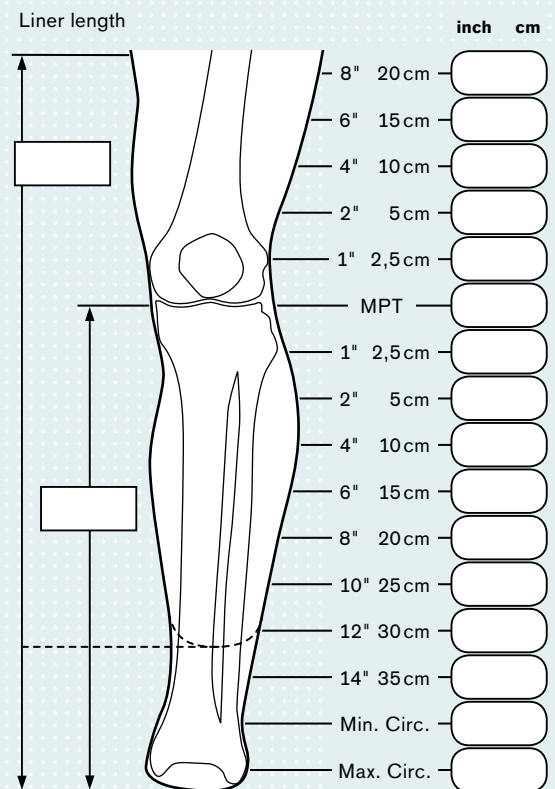

Length of residual limb from MTP to distal end

For limbs > 4" in length the cast or scan should be taken in ≤10° flexion and at least 8" above MPT. For limbs < 4" in length take cast in 20° for best results.
 Ottobock maintains all rights, title and ownership to the custom liner mold and will keep the mold on file for 2 years from the last order date.

Casting for the Uneo Unique Liner

1. Complete all required sections of the Order Form, including limb circumferences.
2. Apply parting agent to the limb, stopping 25 cm (10") above MPT.

Normal Skin: Wrap the limb with plastic wrap or cover with lubricant.

Skin with Invagination or Scarring: Invaginations or deep scarring that do not close when cupped by hand are rare; only 1 – 2% of all patients. If you encounter one of these cases, fill the invagination/scar with plaster bandage wrap. Apply petroleum jelly to the remainder of the limb. Avoid getting petroleum jelly on the bandage wrap. Make a note on the Order Form to alert Ottobock of the invagination/scar.

3. Pull a thin casting sock over the limb to a height of 25 cm (10") above MPT.

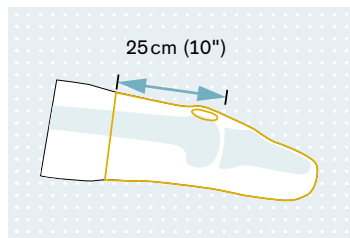

4. Mark the MPT on the casting sock with an indelible pencil. This mark is used by the Ottobock technician when manufacturing the custom liner.

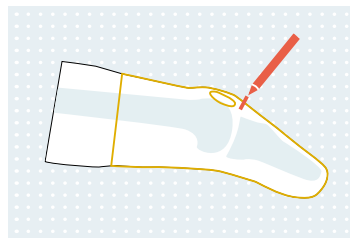

5. Mark a spot on the thigh 23 cm (9") above the MPT mark as a reference for the top of the cast. Have the patient hold their limb at 10° of flexion.

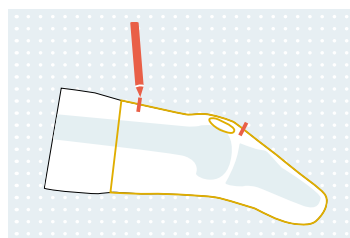

6. Cast the limb with plaster bandage starting proximally at the mark.

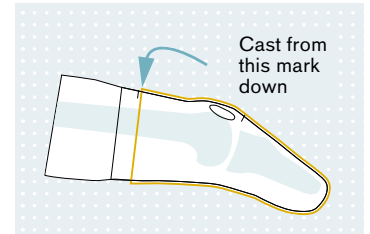

7. Apply 4 layers of nylon or a casting sock over the cast.

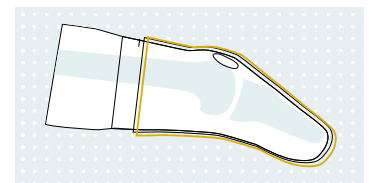

8. Apply casting bag. Extend it up to the thigh to form a seal.

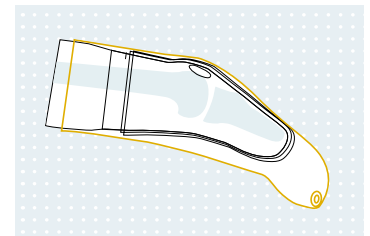

9. If necessary, lightly support any distal, redundant soft tissue that gravity has caused to droop so that it remains in line with the rest of the lower limb until the plaster has set. The reason to support the soft tissue is to avoid producing a liner that tends to hold soft tissue off center.

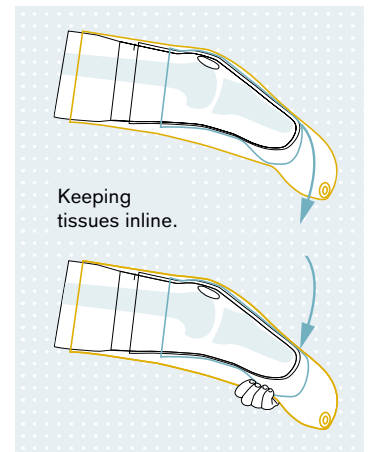

10. Place the knee at 10° of flexion and turn on the casting pump. Maintain vacuum until the cast has set.

Note: For limbs less than 4" long, a 20° knee flexion gives best results.

11. Write the patient ID on the cast and ship with completed order form to Ottobock.

Uneo Unique Liner 6Y400

Order Form – TF and KD

Contact	Customer number	Date
Customer		Shipping address (if different from customer address)
Company	Company	
Street	Street	
Postal code/city	Postal code/city	
Email	Phone	

Please complete this form and include a scan or cast with patient ID. For alteration liner please call Customer Service.

New Liner Replacement Liner Last Order No.

Patient Information

Uneo Unique Liners are imprinted with your patient ID.

Patient ID:

Left Right
 Transfemoral Knee disarticulation Other:

Select the Appropriate Type of Uneo Unique Liner

Wall Thickness

Uniform (6.5mm uniform distal wall to proximal)
 Tapered (6.5mm distal end to 3.5mm proximal)
 Distal thickness 18mm for locking and 12–13mm for cushion.

Locking Mechanism

Yes* No
 Pin locking
 KISS system (Come with grey KISS fabric only)

* Locking Liners must have Exterior Textile selected

Textile Cover

Uncovered Partial Cover
 Full Textile Cover Partial Cover Height: mm

	Tan	Black	Silver
Spandex Fabric	<input type="checkbox"/> 0.6mm	<input type="checkbox"/> 0.6mm	
Wearforce	<input type="checkbox"/> 1.6mm	<input type="checkbox"/> 1.6mm	
Silver Fabric			<input type="checkbox"/> 1.0mm

Additive**

With Fresh scented additive
 With Skinguard antibacterial additive

** Only one can be chosen

Measurements

- Extend measurements as needed. Please mark any problem areas on cast or diagramm.
- Please choose between inch or cm and circle one below.

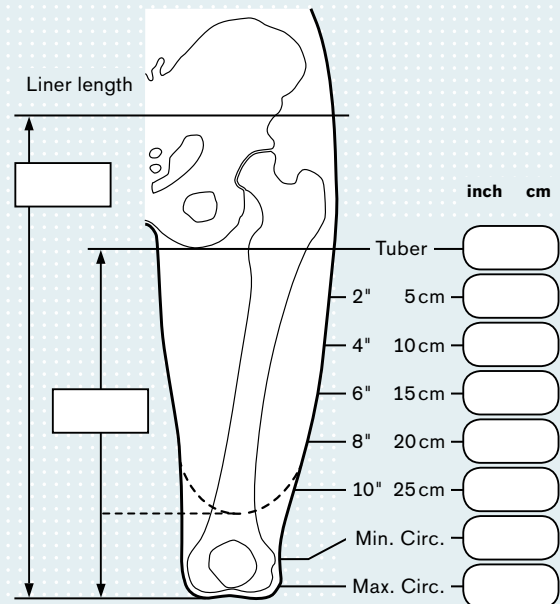

Length of residual limb from tuber to distal end

Plaster negative: Cast the residual limb with loose plaster bandage without vacuum or reduction.

Scan: The scan should be taken while standing in an upright body posture, the residual limb should not be flexed or abducted to prevent soft tissue shifts.

Ottobock maintains all rights, title and ownership to the custom liner mold and will keep the mold on file for 2 years from the last order date.

Skeo Unique Liner 6Y700

Order Form – TT and Symes

Contact	Customer number	Date
Customer		Shipping address (if different from customer address)
Company	Company	
Street	Street	
Postal code/city	Postal code/city	
Email	Phone	

Please complete this form and include a scan or cast with patient ID. For alteration liner please call Customer Service.

New Liner Replacement Liner Last Order No.

Patient Information

Skeo Unique Liners are imprinted with your patient ID.

Patient ID:

Left Right
 Transtibial Symes Other:

Select the Appropriate Type of Skeo Unique Liner

Wall Thickness

Uniform (4.5mm uniform distal wall to proximal)
 Tapered (4.5mm MPT to 2.5mm proximal)
 Distal thickness is 21mm for locking and 13mm for cushion.

Locking Mechanism

Yes* No
 Pin locking
 DVS (Select Partial Textile Cover)
 * Locking Liners must have Exterior Textile selected

Exterior

Textile Cover
 Uncovered Partial Cover
 Full Textile Cover Partial Cover Height: mm

Tan Black Silver
 0.6 mm 0.6 mm
 1.6 mm 1.6 mm
 1.0 mm

Measurements

- Extend measurements as needed. Please mark the MPT and any problem areas on cast or diagramm.
- Please choose between inch or cm and circle one below.

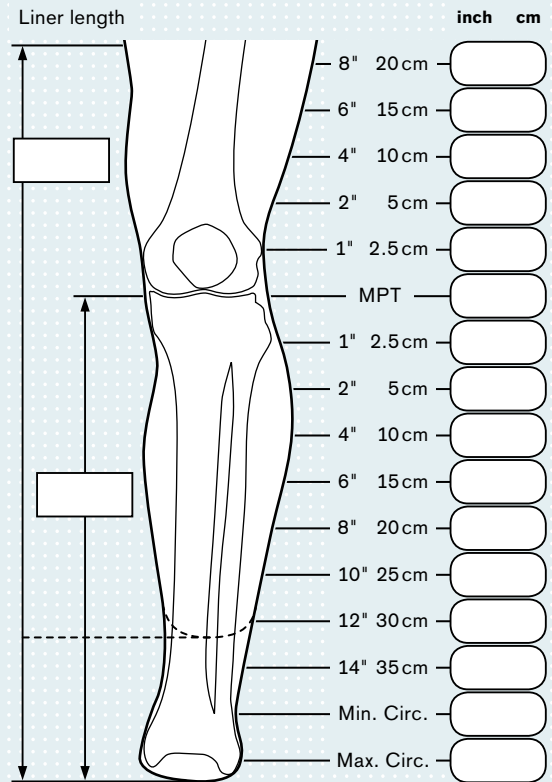

For limbs > 4" in length the cast or scan should be taken in ≤10° flexion and at least 8" above MPT. For limbs < 4" in length take cast in 20° for best results. Ottobock maintains all rights, title and ownership to the custom liner mold and will keep the mold on file for 2 years from the last order date.

Casting for the Skeo Unique Liner

1. Complete all required sections of the Order Form, including limb circumferences.

2. Apply parting agent to the limb, stopping 25 cm (10") above MPT.

Normal Skin: Wrap the limb with plastic wrap or cover with lubricant.

Skin with Invagination or Scarring: Invaginations or deep scarring that do not close when cupped by hand are rare; only 1 – 2% of all patients. If you encounter one of these cases, fill the invagination/scar with plaster bandage wrap. Apply petroleum jelly to the remainder of the limb. Avoid getting petroleum jelly on the bandage wrap. Make a note on the Order Form to alert Ottobock of the invagination/scar.

3. Pull a thin casting sock over the limb to a height of 25 cm (10") above MPT.

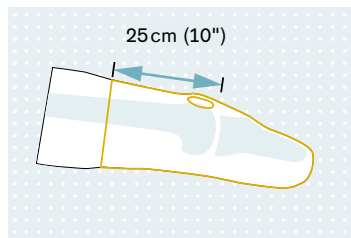

4. Mark the MPT on the casting sock with an indelible pencil. This mark is used by the Ottobock technician when manufacturing the custom liner.

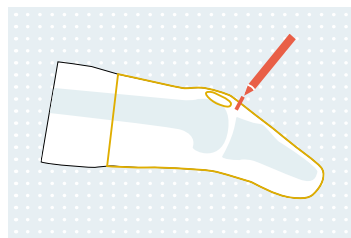

5. Mark a spot on the thigh 23 cm (9") above the MPT mark as a reference for the top of the cast. Have the patient hold their limb at 10° of flexion.

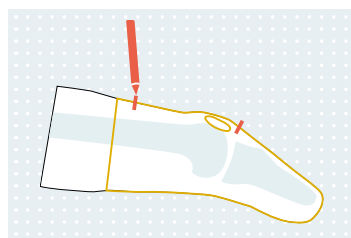

6. Cast the limb with plaster bandage starting proximally at the mark.

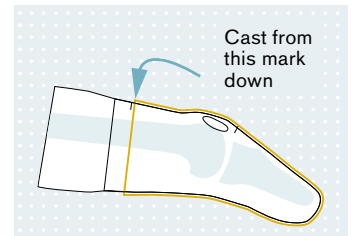

7. Apply 4 layers of nylon or a casting sock over the cast.

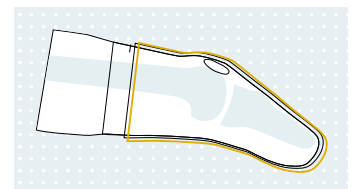

8. Apply casting bag. Extend it up to the thigh to form a seal.

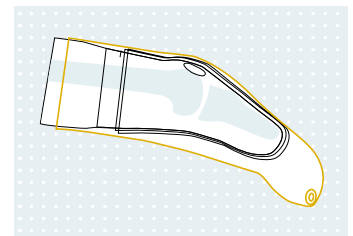

9. If necessary, lightly support any distal, redundant soft tissue that gravity has caused to droop so that it remains in line with the rest of the lower limb until the plaster has set. The reason to support the soft tissue is to avoid producing a liner that tends to hold soft tissue off center.

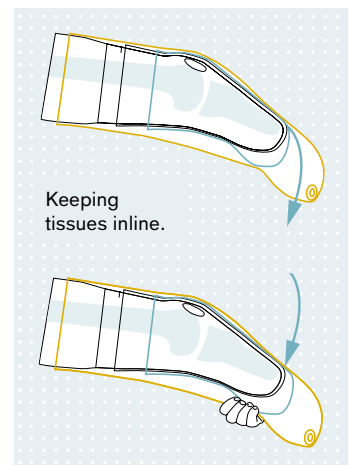

10. Place the knee at 10° of flexion and turn on the casting pump. Maintain vacuum until the cast has set.

Note: For limbs less than 4" long, a 20° knee flexion gives best results.

11. Write the patient ID on the cast and ship with completed order form to Ottobock.

Skeo Unique Liner 6Y700 Order Form – TF and KD

Contact	Customer number	Date
Customer		Shipping address (if different from customer address)
Company	Company	
Street	Street	
Postal code/city	Postal code/city	
Email	Phone	

Please complete this form and include a scan or cast with patient ID. For alteration liner please call Customer Service.

New Liner Replacement Liner Last Order No.

Patient Information

Skeo Unique Liners are imprinted with your patient ID.

Patient ID:

Left Right
 Transfemoral Knee disarticulation Other:

Select the Appropriate Type of Skeo Unique Liner

Wall Thickness

Uniform (4.5mm uniform distal wall to proximal)
 Tapered (4.5mm distal end to 2.5mm proximal)
 Distal thickness is 21mm for locking and 13mm for cushion.

Locking Mechanism

Yes* No
 Pin locking
 KISS system (Come with grey KISS fabric only)

* Locking Liners must have Exterior Textile selected

Exterior

Textile Cover
 Uncovered Partial Cover
 Full Textile Cover Partial Cover Height: mm

	Tan	Black	Silver
Spandex Fabric	<input type="checkbox"/> 0.6mm	<input type="checkbox"/> 0.6mm	
Wearforce	<input type="checkbox"/> 1.6mm	<input type="checkbox"/> 1.6mm	
Silver Fabric			<input type="checkbox"/> 1.0mm

Measurements

- Extend measurements as needed. Please mark any problem areas on cast or diagramm.
- Please choose between inch or cm and circle one below.

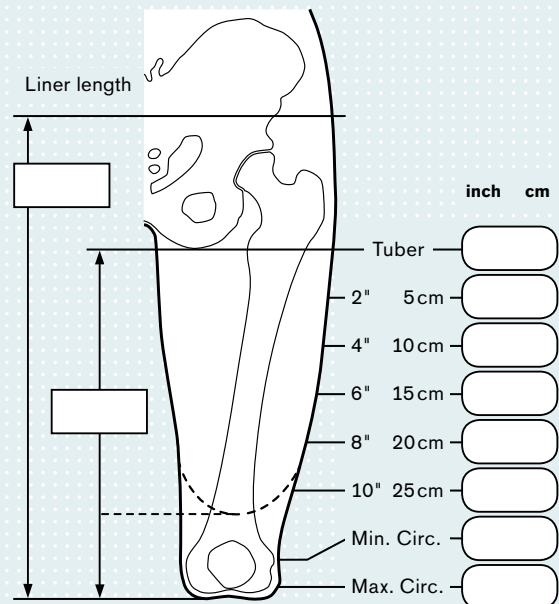

Plaster negative: Cast the residual limb with loose plaster bandage without vacuum or reduction.

Scan: The scan should be taken while standing in an upright body posture, the residual limb should not be flexed or abducted to prevent soft tissue shifts.

Ottobock maintains all rights, title and ownership to the custom liner mold and will keep the mold on file for 2 years from the last order date.

TF Design sockets iFab Ordering process

1. Measure the patient's residual limb (please note the information on the back of the measurement form or the corresponding section in the Instructions for Use 647H374 of the Ottobock TF Design Software 647X6).

Now you have two options to determine the shaping of the socket:

Ordering option a:

- Enter the measurements on the measurement form

Ordering option b:

- Then enter the measurements in the software, specifying the socket shape and design which you can verify and, if required, modify on the 3D model in the software.

Please save the order and send the data to Ottobock iFab by e-mail. You may order any prosthesis components and additional services you need at the same time.

2. Ottobock iFab will fabricate the TF Design socket for you, and usually ships it within 1 working day. If the data are received by 12 noon, shipment is on the same working day.

3. You receive a check socket which meets your specifications precisely thanks to highly modern software.

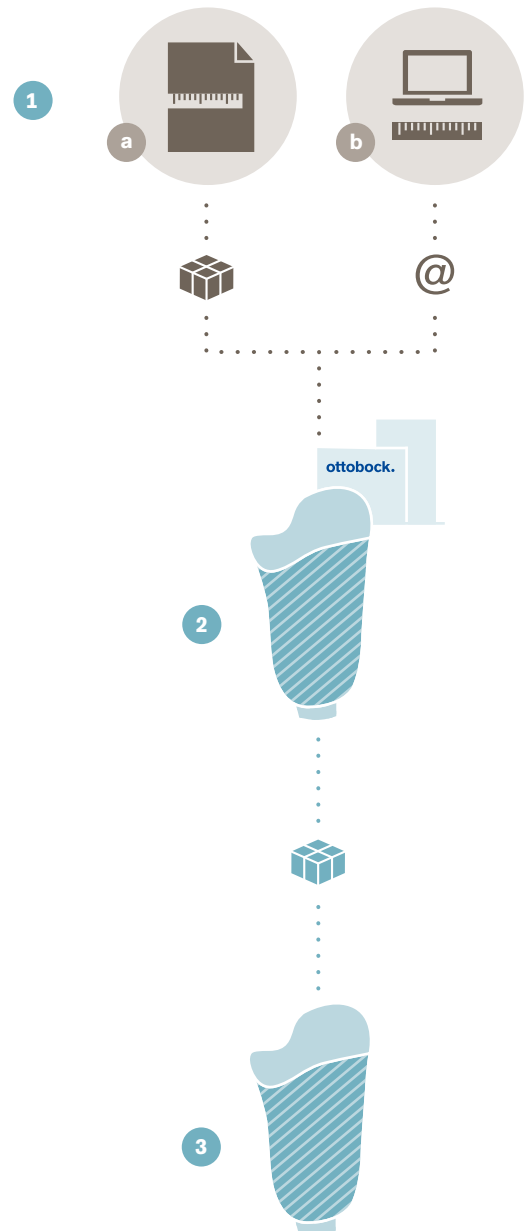

TF Design check socket

iFab Order from (1/2)

Contact person	Customer number	Date
Customer		Shipping address (if different from customer address)
Company	Company	
Street	Street	
Postal code/city	Postal code/city	
Email	Phone	
Commission		

Express shipping requested*

(shipment on the next working day; if the order data are received by 12:00 noon, the socket ships the same working day)

Side Left Right **Requirements** Check socket Positive model Check socket and positive model

Material for check socket ThermoLyn, clear ThermoLyn, rigid (article number)

Valve Preparation only Installation **Positioning** Medial Lateral

- 21Y12 Screw valve 21Y14 PushValve 21Y15 MagValve
- 21Y21 ClickValve 21Y96 Flat rubber valve
- 452A1=* ProSeal ProSeal ring (not glued in and recommended only in combination with the ProSeal socket type and a ProSeal liner)

Shuttle Locks/KISS

- 4R160=1 4R163 4R160=2
- 4R164 6A20=10 6A20=20
- 6A20=30 6A30=10 6A30=20
- SF6A60 Vacuum forming adapter with locking mechanism 6A40

Socket adapter

- SF5R10 Vacuum forming adapter without liner connection
- SF5R11 Vacuum forming adapter with connector for shuttle lock
- 5R6=*

Positioning

Left side:

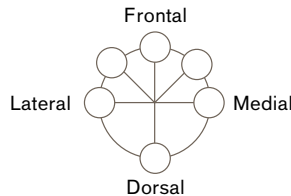

Right side:

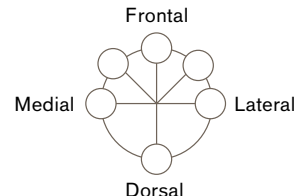

Socket type

- ICS Advanced ProSeal (recommended especially in combination with the ProSeal ring)
- ICS Contoured Quadrilateral Contoured Markant
- ICS Medium Quadrilateral Medium
- ICS Feminine Contoured Quadrilateral Feminine Contoured
- Hybrid

Information for the socket design

Distal end

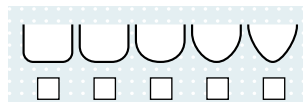

Preparation for liner

- Silikon-Gel-Liner 6Y80 Size
- Size

TF Design check socket

iFab Order from (2/2)

Contact person	Customer number	Date
Commission		

Diagram illustrating the measurement points for the TF Design check socket. The diagram shows a side view of a prosthetic socket with various measurement points indicated by arrows and boxes. The measurements are as follows:

- Distance from ischial tuberosity: + 30 mm
- Residual limb circumference: [] mm
- Reduced circumference: [] mm
- Residual limb length: [] mm
- Socket length: [] mm

Legend for measurements:

- [] ° Flexion angle
- [] ° Adduction angle
- [] mm Bony ML measurement
- [] mm Soft tissue ML measurement
- [] mm Perineum AP measurement
- [] mm Proximal brim adjustment (-15 to +15 mm)

... or reduction in %

<input type="checkbox"/> 0%	<input type="checkbox"/> 1%	<input type="checkbox"/> 2%	<input type="checkbox"/> 3%	<input type="checkbox"/> 4%	<input type="checkbox"/> 5%	<input type="checkbox"/> 6%	proximal
<input type="checkbox"/> 0%	<input type="checkbox"/> 1%	<input type="checkbox"/> 2%	<input type="checkbox"/> 3%	<input type="checkbox"/> 4%	<input type="checkbox"/> 5%	<input type="checkbox"/> 6%	distal

Please note that using patches results in changes to the socket volume

Diagrams illustrating the application of patches to the prosthetic socket. The patches are numbered 1 through 8:

- Lateral Posterior Femur Patch¹ (max. depth of 8 mm)
- Lateral Anterior Femur Patch¹ (max. depth of 8 mm)
- Lateral Trochanter Patch (max. depth of 8 mm)
- Lateral Posterior Distal Femur patch (max. height of 8 mm)
- Posterior Middle Femur Patch (max. depth of 8 mm)
- Medial Adductor Tendon patch² (max. height of 8 mm)
- Medial Patch³ (max. depth of 8 mm)
- Anterior Patch⁴ (max. height of 8 mm)

Footnotes:

- ¹ not possible for ProSeal with liner and ring
- ² not possible for ProSeal with liner and ring or quadrilateral models
- ³ not possible for Hybrid, ProSeal with liner and ring or quadrilateral models
- ⁴ only available for quadrilateral models

Comments:

SiOCX TF with Diagnostic Socket iFab Ordering process

1. If you have a plaster positive or a well-fitting test socket or definitive socket, please complete the order form.

The socket should be worn until the residual limb volume fluctuations are minimised. In the time between ordering and delivery of the definitive SiOCX TF socket, the user should wear a correspondingly fitting socket to minimise changes in residual limb shape and volume.

Please label the socket or plaster positive with the following information:

- Position, size and strength of the soft padding in the perineal region and any additional soft padding
- The valve position

Afterwards: Please send the well-fitting check or the definitive socket or a plaster positive of a well-fitting check or definitive socket to Ottobock iFab. We also require the completed order form for additional information.

2. Ottobock iFab will fabricate the definitive silicone inner socket connected to a thermoplastic outer socket without positioned adapter for you according to your specifications and ship it within 10 working days. This outer socket serves as a diagnostic socket on which changes in shape, socket brim line and adapter position can be made.

3. Please send the delivered definitive silicone inner socket, the completed order form and the thermoplastic diagnostic socket modified by you with trimmed and, if necessary, flared socket brim, marked flexible seat region cut-out (seating band) and definitively positioned adapter to Ottobock iFab.

4. Ottobock iFab will fabricate the SiOCX TF socket comprising a silicone inner socket and a carbon prepreg outer socket according to your specifications and ship it within 7 working days.

5. You receive a well-fitting and individual definitive socket.



SiOCX TF 7T450=1 iFab Order form

Contact	<input type="text"/>	Customer number	<input type="text"/>	Date	<input type="text"/>
Customer			Shipping address (if different from customer address)		
Company	<input type="text"/>		Company	<input type="text"/>	
Street	<input type="text"/>		Street	<input type="text"/>	
Postal code/city	<input type="text"/>	<input type="text"/>	Postal code/city	<input type="text"/>	<input type="text"/>
Email	<input type="text"/>		Phone	<input type="text"/>	
Commission	<input type="text"/>				

Patient weight:
 Overall residual limb length:
 Bony residual limb length:

Mobility grade 1 2 3 4
 Affected side Left Right



Your SiOCX socket system includes the diagnosis socket, the HTV silicone inner socket, a perineum pad, a distal integrated clip and the definitive prepreg outer socket.

- With diagnosis socket (2-step ordering process) Without diagnosis socket (1-step ordering process) for SiOCX follow-up fittings

Silicone inner socket

- SiliconeGel padding
 No perineum pad
 (additional pads requested)
 Mark the position and size of the pads on the check socket.
- Valve*
 21Y12
 21Y14
 21Y21
- Colour
 Skin colour
 Uni (see color sample 646M78)
- No anti-stick coating

Thermoplastic diagnosis outer socket

- Material
 616T52 ThermoLyn rigid
 616T83 ThermoLyn clear
- Adapter
 Without adapter
 Include adapter*: art. no.:

Prepreg outer socket (frame socket)

- Flexible seating tape
- Surface design
 Finished carbon design
 Untreated carbon design
- Adapter*
 5R2=C 4R89 4R41
 4R111 4R116 4R119
 Same adapter position
 Position adapter as close as possible to the distal residual limb end

Comments:

.....

.....

SiOCX TF Pro

iFab Ordering process

1. If you have a well-fitting test socket or definitive socket, please complete the order form.

Please note that the socket should be worn until the residual limb volume fluctuations are minimised. In the time between ordering and delivery of the definitive SiOCX TF Pro socket, the patient should wear a correspondingly fitting socket to minimise changes in residual limb shape and volume.

Please label the socket with the following information:

- Position, size and strength of the soft padding in the perineal region and any additional soft padding
- The valve position
- The medial and lateral frame arms
- The desired outer socket brim line

Afterwards: Please send the well-fitting check or definitive socket with correct adapter position to Ottobock iFab. We also require the completed order form for additional information.

2. Ottobock iFab will fabricate the socket comprising a silicone inner socket and carbon prepreg frame socket according to your specifications and ship it within 15 working days.

3. You receive a well-fitting and individual definitive socket.



SiOCX TF Pro 7T451=1 iFab Order form

Contact	Customer number	Date
Customer		Shipping address (if different from customer address)
Company	Company	
Street	Street	
Postal code/city	Postal code/city	
Email	Phone	
Commission		

Patient weight:
 Overall residual limb length:
 Bony residual limb length:

Mobility grade 1 2 3 4
 Affected side Left Right



Your SiOCX socket system includes the HTV silicone inner socket, a perineum pad, a distal integrated clip and the definitive prepreg frame socket.

To order the frame socket, all of the following criteria have to be met (please check):

- Socket type is Ischial Containment, SIT-Cast, Anatomica or MAS No residual limb volume fluctuations
- Residual limb is at least 20 cm long

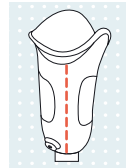

On the socket you are sending in, please mark the course of the axis for the medial and lateral frame bar.

Silicone inner socket

- SiliconeGel padding
- No perineum pad
 - (additional pads requested)
- Mark the position and size of the pads on the check socket.
- Valve* 21Y12 21Y14 21Y21
- Colour Skin colour Uni (see color sample 646M78)
- No anti-stick coating

Prepreg outer socket (frame socket)

- Surface design
- Finished carbon design
 - Untreated carbon design
- Adapter*
- 5R2=C 4R89 4R41
 - 4R111 4R116 4R119
 - Same adapter position
 - Position adapter as close as possible to the distal residual limb end

Comments:

.....

.....

.....

.....

.....



Prosthesis covers



Prosthesis covers

Overview of prosthesis cover combinations

	3F1=1	3F1=2	3S26	3R6	3S106	3R24	3S124	3S107	3S27	6R6*	6R8	6R18	88A20	4X193-1 4X900	4X880	4X860	4P862	4X840	
3C60			●																●
3C88-3	●		●														●	●	
3C98-3	●		●						●								●	●	
3B1-2/3B1-3		●	●						●							●			
3B1-2=ST/3B1-3=ST		●	●													●			
3B5-2/3B5-3														●					
3R15				●	●				●										
3R17/3R20/3R33						●	●		●										
3R21/3R23/3R30/ 3R32/3R46				(●)	(●)					●									
3R31								●	●										
3R31=ST								●											
3R36						●	●		●										
3R40						●	●												
3R41								●											
3R49/3R55			●	●															
3R60/3R60=ST								●											
3R60=KD								(●)		●									
3R60=HD									●										
3R60-PRO/ 3R60-PRO=ST								●											
3R60-PRO=KD								(●)		●									
3R60-PRO=HD									●										
3R62/3R62=ST/ 3R62=1/3R62=1-ST								●											
3R62=KD								(●)		●									
3R62=1-KD								(●)		●									
3R78								●	●										
3R78=KD								(●)		●									
3R78=ST								●											
3R80								●	●										
3R90								●											
3R92								●											
3R93					●			●											
3R95						●	●												
3R106/3R106=ST								●											
3R106=KD								(●)		●									
3R106-PRO								●											
3R106-PRO=ST								●											
3R106-PRO=KD								(●)		●									
7E4/7E5/7E7/7E9/7E10									●										
Transtibial										●	●	●	●						

*The 6R6 lower leg foam cover is recommended for knee disarticulation prostheses. Alternatively, a thigh foam cover can be used according to the combination overview (●)

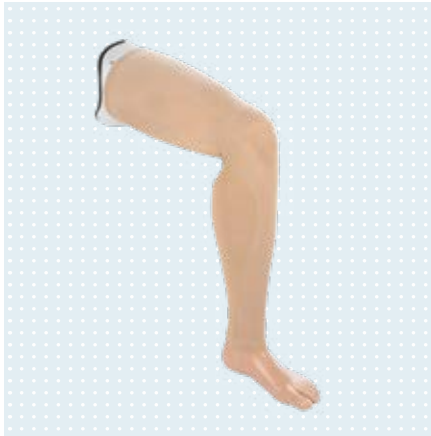

Functional cosmesis C-Leg

Reference number 3F1=1

The functional cosmesis essentially consists of a functional knee part, an individually mouldable functional shank made of foam and a functional stocking that forms the exterior finish of the functional cosmesis. The illustration shows the complete solution. The functional stocking has to be ordered separately (see reference number 99B120).

Key features

- Functional solution to restore the individual leg volume and a natural look
- Functionally harmonised with other prosthesis functions (such as using the rotation adapter)
- Multi-part product: functional knee part with functional shank (3F1=1) and functional stocking (99B120)
- High degree of prefabrication
- Can be used up to a knee axis–floor measurement of 560 mm
- Also suitable for longer sockets. In case of a collision between the functional knee part and the socket, the upper area of the functional knee part can be sanded. If the collision cannot be eliminated by sanding, the upper knee part has to be removed entirely
- Compatible with knee joints: 3C98-3 and 3C88-3
- Compatible with prosthetic feet: 1A30, 1B1, 1C10, 1C11, 1C30, 1C40, 1C50, 1C60, 1C61, 1C63, 1C64, 1C66, 1D10, 1D11, 1D35, 1M10, 1E56, 1E57
- Compatible with rotation adapters: 4R57, 4R57=ST (the medial angle adjustment in the direction of the rotation adapter's release button is limited to max. 4.3°. Otherwise, the rotation adapter and functional knee part come into contact with each other)

Information material

647G1289=ALL_INT	IFU Qualified Personnel 3F1
647H914=ALL_INT	IFU User 3F1

Technical data

Article number	Weight
3F1=1	910 g

Important for your order:

- The 99B120 Functional stocking for the functional cosmesis must be ordered separately.
- The functional cosmesis C-Leg is designed for use with the 4X157 Charger extension cable for the knee. The cable must be ordered separately if required.
- A potential collision between the functional knee part and socket must be checked using the 4H105 C-Leg knee extender. The extender must be ordered separately if required.
- 3F1=1 scope of delivery: functional knee part, functional shank, nylon stocking, screwdriver with flag handle, four cable ties, four dummy plugs (plastic set screws), instructions for use (qualified personnel), instructions for use (user), additional documentation with tips for designing the thigh area

Accessories/spare parts for 3F1=1



Functional cosmesis C-Leg (functional knee part)

Reference number 3F1=1-N

Functional knee part for functional cosmesis C-Leg, spare part for 3F1=1

Technical data

Article number
3F1=1-N

Prosthesis covers

Functional cosmesis



Functional shank C-Leg

Reference number 3P101=1

Functional shank C-Leg (shank made of foam, including nylon stocking), spare part for 3F1=1

Technical data

Article number

3P101=1



Nylon stocking

Reference number 3P102

Nylon stocking for functional cosmesis. The nylon stocking is put on after sanding the shank in order to smooth the surface, making it easier to pull on the functional stocking; spare part for 3F1=1 and 3F1=2

Technical data

Article number

3P102



Charger extension cable, knee

Reference number 4X157

Charger extension cable for relocating the charging receptacle to the knee area. Especially well suited when using the functional cosmesis for the C-Leg.

Technical data

Article number

4X157



Knee extender

Reference number 4H105

The knee extender is mandatory for bench alignment of the prosthesis. It ensures the recommended sagittal positioning of the prosthetic components – the foot, socket and knee joint – relative to each other and thereby guarantees the full functionality of the C-Leg.

Technical data

Article number

4H105

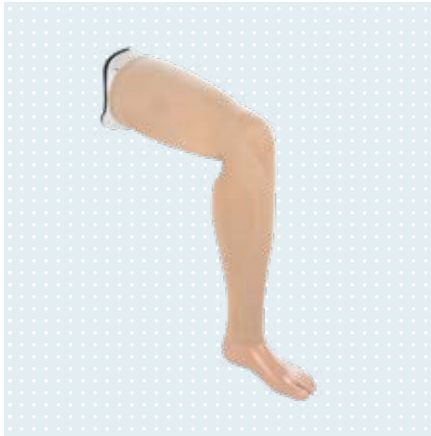

Functional cosmesis Genium

Reference number 3F1=2

The functional cosmesis essentially consists of a functional knee part, an individually mouldable functional shank made of foam and a functional stocking that forms the exterior finish of the functional cosmesis. The illustration shows the complete solution. The functional stocking has to be ordered separately (see reference number 99B120).

Key features

- Functional solution to restore the individual leg volume and a natural look
- Functionally harmonised with other prosthesis functions (such as using the rotation adapter)
- Multi-part product: functional knee part with functional shank (3F1=2) and functional stocking (99B120)
- High degree of prefabrication
- Can be used up to a knee axis–floor measurement of 560 mm
- Also suitable for longer sockets. In case of a collision between the functional knee part and the socket, the upper area of the functional knee part can be sanded. If the collision cannot be eliminated by sanding, the upper knee part has to be removed entirely
- Compatible with knee joints: 3B1-2, 3B1-2=ST, 3B1-3, 3B1-3=ST
- Compatible with prosthetic feet: 1A30, 1B1, 1C10, 1C11, 1C30, 1C40, 1C50, 1C60, 1C61, 1C63, 1C64, 1C66, 1D10, 1D11, 1D35, 1M10, 1E56, 1E57
- Compatible with rotation adapters: 4R57, 4R57=ST (the medial angle adjustment in the direction of the rotation adapter's release button is limited to max. 3.2°. Otherwise, the rotation adapter and functional knee part come into contact with each other)

Information material

647G1289=ALL_INT	IFU Qualified Personnel 3F1
647H914=ALL_INT	IFU User 3F1

Technical data

Article number	Weight
3F1=2	910 g

Important for your order:

- The 99B120 Functional stocking for the functional cosmesis must be ordered separately.
- 3F1=2 scope of delivery: functional knee part, functional shank, nylon stocking, 4X259 Installation ring for inductive charger, screwdriver with flag handle, four cable ties, four dummy plugs (plastic set screws), instructions for use (qualified personnel), instructions for use (user), additional documentation with tips for designing the thigh area

Prosthesis covers

Functional cosmesis

Accessories/spare parts for 3F1=2



Functional cosmesis Genium (functional knee part)

Reference number 3F1=2-N

Functional knee part for functional cosmesis Genium, spare part for 3F1=2

Technical data

Article number

3F1=2-N



Functional shank Genium

Reference number 3P101=2

Functional shank Genium (shank made of foam, including nylon stocking and 4X259 Installation ring for inductive charger), spare part for 3F1=2

Technical data

Article number

3P101=2



Nylon stocking

Reference number 3P102

Nylon stocking for functional cosmesis. The nylon stocking is put on after sanding the shank in order to smooth the surface, making it easier to pull on the functional stocking; spare part for 3F1=1 and 3F1=2

Technical data

Article number

3P102



Functional stocking for functional cosmesis

Reference number 99B120

The easy-care functional stocking forms the exterior finish of the functional cosmesis. It features natural shading and various function zones. Compatible with 3F1=1 and 3F1=2. Available in three colours (beige, light brown, black) and two sizes (S, L).

Key features

- Compatible with 3F1=1 and 3F1=2
- Equipped with functional zones (elastic knee part, area for inductive charging in the calf (Genium), concealing fleece yarn zones)
- Natural shading
- Washable
- Repels dirt and splashed water
- Available in the colours beige (colour no. 4), light brown (colour no. 15) and black (colour no. 7) and in two sizes

Information material

647G1289=ALL_INT	IFU Qualified Personnel 3F1
647H914=ALL_INT	IFU User 3F1

Technical data

Article number	Size	Colour code
99B120=S-4	S	4
99B120=L-4	L	4
99B120=S-7	S	7
99B120=L-7	L	7
99B120=S-15	S	15
99B120=L-15	L	15

Selection of Functional Stocking

MTP to floor measurement	Socket circumference (below tuber)	MTP to floor measurement	
		40 – 46 cm 15,7" – 18,1"	46 – 56 cm 18,1" – 22"
38 – 48 cm 14,9" – 18,9"		S	L ¹
		L	L
> 48 cm > 18,9"		L	L
		L	L

¹ These combinations of measurements can occur in prosthesis users who are very tall and also very slim. For the Functional Stocking to fit the socket well, the socket diameter must be enlarged by adding material in these cases.

Prosthesis covers

Foam covers



Information material

647G479=ALL_INT IFU PUR foam covers

Foam cover

Reference number 3S26

The 3S26 covers for modular transfemoral prostheses restore the natural leg volume. They have a stepped centre hole and are partly anatomically pre-shaped.

Key features

- Material: PUR foam
- Compatible with knee joints: 3C60, 3C88-3, 3C98-3, 3B1-2, 3B1-2=ST, 3B1-3, 3B1-3=ST
- With stepped centre hole
- Partly anatomically pre-shaped
- Pre-flexed in the area of the knee

Technical data

Article number	Material	Calf circumference	Knee flexion	Side	Length
3S26=L44	PUR	44 cm	20 °	left	Approx. 95 cm
3S26=R44	PUR	44 cm	20 °	right	Approx. 95 cm

- The material is flame retardant according to DIN 75200. Complies with MVSS 302 ≤ 100 mm.
- You can have foam covers custom fabricated according to the user's measurements by Ottobock iFab.



Information material

647G479=ALL_INT IFU PUR foam covers

Foam cover

Reference number 3R6

The 3R6 covers for modular transfemoral prostheses restore the natural leg volume. They have a stepped centre hole and are partly anatomically pre-shaped.

Key features

- Material: PUR foam
- Compatible with knee joints: 3R15, 3R21*, 3R23*, 3R30*, 3R32*, 3R46*, 3R49, 3R55
- With stepped centre hole
- Partly anatomically pre-shaped
- Pre-flexed in the area of the knee

Technical data

Article number	Material	Calf circumference	Knee flexion	Side	Length
3R6=L36	PUR	36 cm	30 °	left	Approx. 94 cm
3R6=R36	PUR	36 cm	30 °	right	Approx. 94 cm
3R6=L40	PUR	40 cm	30 °	left	Approx. 94 cm
3R6=R40	PUR	40 cm	30 °	right	Approx. 94 cm
3R6=L44	PUR	44 cm	30 °	left	Approx. 94 cm
3R6=R44	PUR	44 cm	30 °	right	Approx. 94 cm

- *Knee joints for knee disarticulation prostheses. The 6R6 lower leg foam cover is recommended for knee disarticulation prostheses. Alternatively, the appropriate thigh foam cover for the respective joint can be used.
- The material is flame retardant according to DIN 75200. Complies with MVSS 302 ≤ 100 mm.
- You can have foam covers custom fabricated according to the user's measurements by Ottobock iFab.



Foam cover

Reference number 3S106

The 3S106 covers for modular transfemoral prostheses restore the natural leg volume. They have a stepped centre hole and are partly anatomically pre-shaped. The covers also come with a conical opening in the area of the thigh for easier fitting of the prosthetic socket.

Key features

- Material: PUR foam
- Compatible with knee joints: 3R15, 3R21*, 3R23*, 3R30*, 3R32*, 3R46*, 3R49, 3R55, 3R93
- With stepped centre hole
- Partly anatomically pre-shaped
- Pre-flexed in the area of the knee
- Conical opening in the area of the thigh for easier fitting of the socket

Information material

647G479=ALL_INT IFU PUR foam covers

Technical data

Article number	Material	Calf circumference	Knee flexion	Side	Length
3S106=L36	PUR	36 cm	35 °	left	Approx. 94 cm
3S106=R36	PUR	36 cm	35 °	right	Approx. 94 cm
3S106=L40	PUR	40 cm	35 °	left	Approx. 94 cm
3S106=R40	PUR	40 cm	35 °	right	Approx. 94 cm
3S106=L44	PUR	44 cm	35 °	left	Approx. 94 cm
3S106=R44	PUR	44 cm	35 °	right	Approx. 94 cm

- *Knee joints for knee disarticulation prostheses. The 6R6 lower leg foam cover is recommended for knee disarticulation prostheses. Alternatively, the appropriate thigh foam cover for the respective joint can be used.
- The material is flame retardant according to DIN 75200. Complies with MVSS 302 ≤ 100 mm.
- You can have foam covers custom fabricated according to the user's measurements by Ottobock iFab.

Prosthesis covers

Foam covers



Information material

647G479=ALL_INT IFU PUR foam covers

Foam cover

Reference number 3R24

The 3R24 covers for modular transfemoral prostheses restore the natural leg volume. They have a stepped centre hole and are partly anatomically pre-shaped.

Key features

- Material: PUR foam
- Compatible with knee joints: 3R17, 3R20, 3R33, 3R36, 3R40, 3R95
- With stepped centre hole
- Partly anatomically pre-shaped
- Pre-flexed in the area of the knee

Technical data

Article number	Material	Calf circumference	Knee flexion	Side	Length
3R24=L36	PUR	36 cm	30 °	left	Approx. 94 cm
3R24=R36	PUR	36 cm	30 °	right	Approx. 94 cm
3R24=L40	PUR	40 cm	30 °	left	Approx. 94 cm
3R24=R40	PUR	40 cm	30 °	right	Approx. 94 cm
3R24=L44	PUR	44 cm	30 °	left	Approx. 94 cm
3R24=R44	PUR	44 cm	30 °	right	Approx. 94 cm

- The material is flame retardant according to DIN 75200. Complies with MVSS 302 ≤ 100 mm.
- You can have foam covers custom fabricated according to the user's measurements by Ottobock iFab.



Information material

647G479=ALL_INT IFU PUR foam covers

Foam cover

Reference number 3S124

The 3S124 covers for modular transfemoral prostheses restore the natural leg volume. They have a stepped centre hole and are partly anatomically pre-shaped. The covers also come with a conical opening in the area of the thigh for easier fitting of the prosthetic socket.

Key features

- Material: PUR foam
- Compatible with knee joints: 3R17, 3R20, 3R33, 3R36, 3R40, 3R95
- With stepped centre hole
- Partly anatomically pre-shaped
- Pre-flexed in the area of the knee
- Conical opening in the area of the thigh for easier fitting of the socket

Technical data

Article number	Material	Calf circumference	Knee flexion	Side	Length
3S124=L36	PUR	36 cm	35 °	left	Approx. 94 cm
3S124=R36	PUR	36 cm	35 °	right	Approx. 94 cm
3S124=L40	PUR	40 cm	35 °	left	Approx. 94 cm
3S124=R40	PUR	40 cm	35 °	right	Approx. 94 cm
3S124=L44	PUR	44 cm	35 °	left	Approx. 94 cm
3S124=R44	PUR	44 cm	35 °	right	Approx. 94 cm

- The material is flame retardant according to DIN 75200. Complies with MVSS 302 ≤ 100 mm.
- You can have foam covers custom fabricated according to the user's measurements by Ottobock iFab.



Foam cover

Reference number 3S107

The 3S107 covers for modular transfemoral prostheses restore the natural leg volume. They have a stepped centre hole and are partly anatomically pre-shaped.

Key features

- Material: PUR foam
- Compatible with knee joints: 3R31, 3R31=ST, 3R41, 3R60, 3R60=ST, 3R60=KD*, 3R60-PRO, 3R60-PRO=ST, 3R60-PRO=KD*, 3R62, 3R62=ST, 3R62=1-ST, 3R62=KD*, 3R62-1=KD*, 3R78, 3R78=KD*, 3R78=ST, 3R80, 3R90, 3R92, 3R93, 3R106, 3R106=ST, 3R106=KD*, 3R106-PRO
- With stepped centre hole
- Partly anatomically pre-shaped
- Pre-flexed in the area of the knee

Information material

647G479=ALL_INT IFU PUR foam covers

Technical data

Article number	Material	Calf circumference	Knee flexion	Side	Length
3S107=L40	PUR	40 cm	35 °	left	Approx. 94 cm
3S107=R40	PUR	40 cm	35 °	right	Approx. 94 cm
3S107=L44	PUR	44 cm	35 °	left	Approx. 94 cm
3S107=R44	PUR	44 cm	35 °	right	Approx. 94 cm

- *Knee joints for knee disarticulation prostheses. The 6R6 lower leg foam cover is recommended for knee disarticulation prostheses. Alternatively, the appropriate thigh foam cover for the respective joint can be used.
- The material is flame retardant according to DIN 75200. Complies with MVSS 302 ≤ 100 mm.
- You can have foam covers custom fabricated according to the user's measurements by Ottobock iFab.

Prosthesis covers

Foam covers

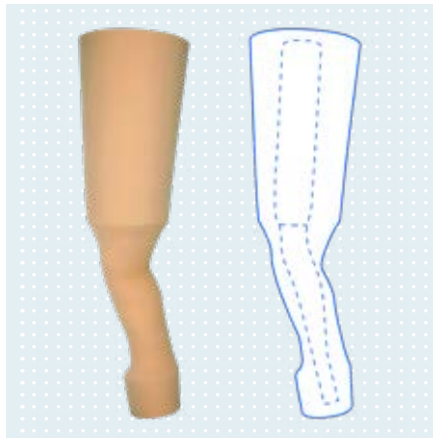

Information material

647G479=ALL_INT

IFU PUR foam covers

Foam cover

Reference number 3S27

The 3S27 covers for modular hip disarticulation prostheses restore the natural leg volume. They have a stepped centre hole and are partly anatomically pre-shaped.

Key features

- Material: PUR foam
- Compatible with hip joints: 7E4, 7E5, 7E7, 7E9, 7E10
- Compatible with knee joints: 3C98-3, 3B1-2, 3B1-3, 3R15, 3R17, 3R20, 3R31, 3R33, 3R36, 3R60=HD, 3R60-PRO=HD, 3R78, 3R80
- With stepped centre hole
- Partly anatomically pre-shaped
- Pre-flexed in the area of the knee
- Longer at about 110 cm and, with a diameter of about 31 cm, wider at the top than the models for transfemoral prostheses

Technical data

Article number	Material	Calf circumference	Knee flexion	Side	Length
3S27=L44	PUR	44 cm	20 °	left	Approx. 110 cm
3S27=R44	PUR	44 cm	20 °	right	Approx. 110 cm

- The material is flame retardant according to DIN 75200. Complies with MVSS 302 ≤ 100 mm.
- You can have foam covers custom fabricated according to the user's measurements by Ottobock iFab.

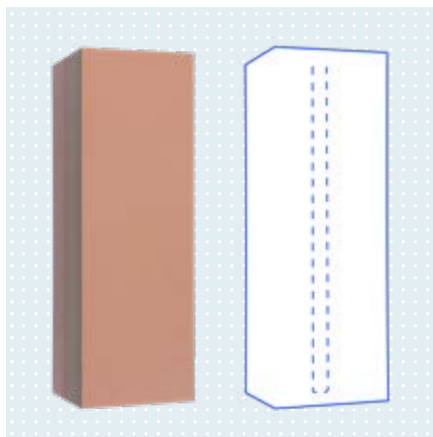

Information material

647G25=ALL_INT

IFU PE foam covers

Foam cover

Reference number 6R8

The 6R8 covers for modular transtibial prostheses restore the natural leg volume. The blocks are not pre-shaped and can be used on the left or right side.

Key features

- Material: PE foam
- With 30 mm or 34 mm diameter bore

Technical data

Article number	Material	For tube diameter	Length
6R8=30	Polyethylene foam	30 mm	Approx. 48 cm
6R8=34	Polyethylene foam	34 mm	Approx. 48 cm

- The material is flame retardant according to ISO 3795 and meets MVSS 302 ≤ 100 mm.
- You can have foam covers custom fabricated according to the user's measurements by Ottobock iFab.



Foam cover

Reference number 6R18

The 6R18 covers for modular transtibial prostheses restore the natural leg volume. They are slightly pre-shaped and can be used on the left or right side.

Key features

- Material: PE foam
- With 30 mm or 34 mm diameter bore
- Slightly pre-shaped

Technical data

Article number	Material	For tube diameter	Length
6R18=30	Polyethylene foam	30 mm	Approx. 48 cm
6R18=34	Polyethylene foam	34 mm	Approx. 48 cm

Information material

647G25=ALL_INT IFU PE foam covers

- The material is flame retardant according to ISO 3795 and meets MVSS 302 ≤ 100 mm.
- You can have foam covers custom fabricated according to the user's measurements by Ottobock iFab.

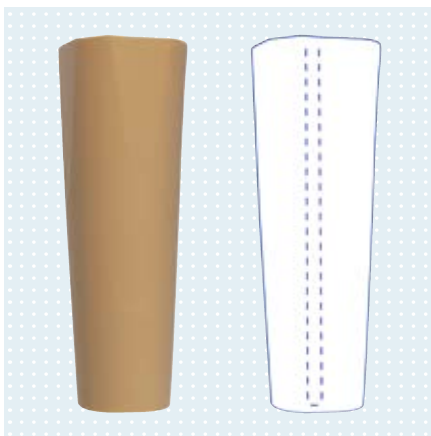

Foam cover

Reference number 6R6

The 6R6 cover for modular transtibial and knee disarticulation prostheses restores the natural leg volume. It can be used for prostheses with a 30-mm and 34-mm tube diameter, on the left or right side. The cover is not pre-shaped.

Key features

- Material: PUR foam
- With 30 mm or 34 mm diameter bore
- Suitable for transtibial and knee disarticulation prostheses

Technical data

Article number	Material	For tube diameter	Length
6R6	PUR	30 and 34 mm	Approx. 55 cm

Information material

647G479=ALL_INT IFU PUR foam covers

- The material is flame retardant according to DIN 75200 and meets MVSS 302 ≤ 100 mm.
- You can have foam covers custom fabricated according to the user's measurements by Ottobock iFab.

Prosthesis covers

Custom silicone covers



Custom silicone cover lower limb

Reference number 88A20

For many users, a natural outward appearance is just as important as the functional benefits of a prosthesis. With high-end, custom-made silicone covers for leg prostheses, Ottobock gives you the opportunity to make this dream come true for your users. The Ottobock iFab acts as your extended workbench for the fabrication of aesthetically pleasing silicone covers, as they are made to your precise and individual specifications – quickly, reliably and in the highest quality.

Key features

- Anatomical, customised restoration of the outer appearance
- Easy to clean with pH-neutral soap and water
- Skin-friendly medical-grade silicone

Information material

646D869=EN	Information for technicians Custom silicone cover for leg prostheses
647F285=GB	Colour determination sheet for silicone products

Technical data

Article image	Article number	Description	Product features
	88A20=C	Custom silicone covers "Classic" for the lower limbs	<ul style="list-style-type: none"> • Anatomical shape • Custom silicone cover in two to three colours • Anatomical surface structure • Single-colour silicone toenails with colour-compatible nail tip
	88A20=N	Custom silicone covers "Natural" for the lower limbs	<ul style="list-style-type: none"> • Anatomical shape • Custom silicone cover in 8-10 colours • Anatomical surface structure • Single-colour silicone toenails with colour-compatible nail tip

- With jointless feet (e.g. 1D10, 1D35), a small gap can be modelled next to the big toe (big toe separation). This makes it possible to wear flip-flops with the prosthesis.
- For the "Natural" variant, the patient must visit an Ottobock Competence Center. Prior to final finishing, a follow-up appointment can also take place in order to optimise the aesthetic appearance.
- Suitable for all Triton prosthetic feet except the 1C68 Triton side flex.
- To order, please follow the ordering procedure and use the order form at the end of the "Prosthesis covers" section.

Recommended system solutions for 88A20

	1C60	Triton
	1C40	C-Walk
	1C30	Trias
	1E56	Axtion
	1D10	Dynamic foot with adapter
	1D10	Dynamic foot without adapter
	1D35	Dynamic Motion

Customised products from Ottobock iFab

Ottobock iFab is an extended workbench that serves as your reliable partner for the centralised fabrication of custom devices in orthotics and prosthetics in the era of digital transformation.

For information about iFab products, or if you have questions or comments, please contact us: ifab@ottobock.com

Ordering options for 88A20



Multi-colour “Classic” and “Natural” silicone nails

Custom five-colour silicone toenails

Technical data

Article number

88A32=S

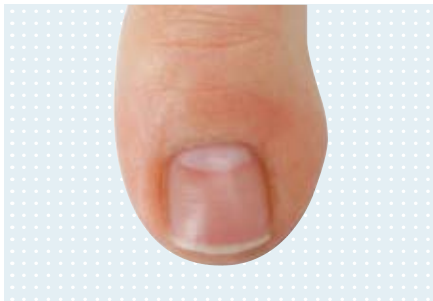

Multi-colour “Classic” and “Natural” acrylic nails

Deceptively realistic surface characteristics
Suitable for nail polish

Technical data

Article number

88A32=A



Hair

Individually matched to the contralateral side; colour, length, shape and density of hair can be realised on request.

Technical data

Article number

88A20=H



Tattoo for silicone prostheses

Implementation of special requests, such as applying a tattoo

Technical data

Article number

88A20=T

Prosthesis covers

Custom silicone covers

Accessories/spare parts for 88A20



Colour determination ring

Colour determination ring for custom prostheses and silicone covers

Technical data

Article number

89D4



Illumination set

Reference number 743R10/743R12

Illumination set for determining the colour of custom silicone products

Technical data

Article number

743R10=0

743R12=0

Description

Illumination set small without camera

Illumination set big without camera

i The foam covers can be coated and finished with SuperSkin. This allows different skin tones to be reproduced (see sampler ring 646M85). For more information on aesthetic finishing with SuperSkin, please refer to our materials catalogue 646K1.



SuperSkin sampler ring

Reference number 646M85

- For the visual and haptic demonstration of the various colour samples (skin tones)
- Aids in selecting the desired hue

Technical data

Article number

646M85

i **Practical recommendation 646M85**

- The colour results provided in the 646M85 SuperSkin sampler ring can be obtained by using different mixing ratios of the SuperSkin colours listed in the colour table.
- For details on the mixture ratios, please see the 646T7=4.8D SuperSkin technical information.

Prosthesis covers

Cosmetic stockings



Perlon cosmetic stockings, long

Reference number 99B14

The perlon cosmetic stockings with a silicone anti-slip strip at the top are intended as exterior cosmetic covers for modular knee disarticulation and transfemoral prostheses. They are available in five sizes and two colours.

Key features

- Material: polyamide and silicone
- Stockings for modular transfemoral and knee disarticulation prostheses
- With anti-slip strip at the top (silicone)
- Available in five sizes and two colours (light = beige, dark = brazil)
- Delivery unit: one pair

Technical data

Article number	Size	Length	Foot length	Ankle (1/2)	Cuff (1/2)	Colour
99B14=0	0	~ 59 cm	~ 18 cm	~ 9 cm	~ 15 cm	Beige
99B14=0B	0	~ 59 cm	~ 18 cm	~ 9 cm	~ 15 cm	Brazil
99B14=1	1	~ 61,5 cm	~ 19 cm	~ 9 cm	~ 16 cm	Beige
99B14=1B	1	~ 61,5 cm	~ 19 cm	~ 9 cm	~ 16 cm	Brazil
99B14=2	2	~ 66 cm	~ 20 cm	~ 9 cm	~ 17 cm	Beige
99B14=2B	2	~ 66 cm	~ 20 cm	~ 9 cm	~ 17 cm	Brazil
99B14=3	3	~ 72 cm	~ 20,5 cm	~ 9,25 cm	~ 18 cm	Beige
99B14=3B	3	~ 72 cm	~ 20,5 cm	~ 9,25 cm	~ 18 cm	Brazil
99B14=4	4	~ 83,5 cm	~ 21 cm	~ 9,5 cm	~ 19 cm	Beige
99B14=4B	4	~ 83,5 cm	~ 21 cm	~ 9,5 cm	~ 19 cm	Brazil

- Delivery unit: one pair
- The dimensions listed in the table serve as a guideline. Possible variations in these dimensions may occur during production. They have no effect on elasticity and product function. The desired dimension can be obtained by pulling.

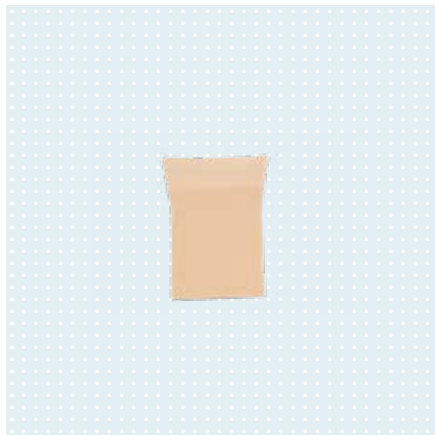

Perlon connecting piece

Reference number 99B15

The perlon connector is intended for fastening the foam cover on the transfemoral socket.

Technical data

Article number	Size	Length	Cuff (1/2)	Colour
99B15=1	1	~ 22 cm	~ 17 cm	Beige
99B15=2	2	~ 22 cm	~ 17,5 cm	Beige
99B15=3	3	~ 22 cm	~ 18 cm	Beige

- The dimensions listed in the table serve as a guideline. Possible variations in these dimensions may occur during production. They have no effect on elasticity and product function. The desired dimension can be obtained by pulling.



Perlon cosmetic stockings for hip disarticulation fittings

Reference number 99B14=HE

The Perlon cosmetic stockings are intended as exterior cosmetic covers for modular hip disarticulation prostheses.

Key features

- Material: polyamide
- Stockings for hip disarticulation prostheses
- Delivery unit: one pair

Technical data

Article number	Length	Foot length	Ankle (1/2)	Cuff (1/2)	Colour
99B14=HE	~ 100 cm	approx. 18.5 cm	~ 10 cm	approx. 14 cm	Beige

- Delivery unit: one pair
- The dimensions listed in the table serve as a guideline. Possible variations in these dimensions may occur during production. They have no effect on elasticity and product function. The desired dimension can be obtained by pulling.



Perlon knee stockings

Reference number 99B16

The perlon knee stockings are intended as exterior cosmetic covers for modular transtibial prostheses. They are available in three sizes and two colours.

Key features

- Material: polyamide
- Stockings for modular transtibial prostheses
- Available in three sizes and two colours (light = beige, dark = brazil)
- Delivery unit: one pair

Technical data

Article number	Size	Length	Foot length	Ankle (1/2)	Cuff (1/2)	Colour
99B16=1	1	~ 38.5 cm	~ 17.5 cm	~ 9 cm	~ 11.5 cm	Beige
99B16=1B	1	~ 38.5 cm	~ 17.5 cm	~ 9 cm	~ 11.5 cm	Brazil
99B16=2	2	~ 40.5 cm	~ 18.5 cm	~ 9.2 cm	~ 11.5 cm	Beige
99B16=2B	2	~ 40.5 cm	~ 18.5 cm	~ 9.2 cm	~ 11.5 cm	Brazil
99B16=3	3	~ 44.5 cm	~ 19 cm	~ 9.25 cm	~ 11.5 cm	Beige
99B16=3B	3	~ 44.5 cm	~ 19 cm	~ 9.25 cm	~ 11.5 cm	Brazil

- Delivery unit: one pair
- The dimensions listed in the table serve as a guideline. Possible variations in these dimensions may occur during production. They have no effect on elasticity and product function. The desired dimension can be obtained by pulling.

Prosthesis covers

Cosmetic stockings



SoftTouch stockings for transtibial prostheses

Reference number 99B116

SoftTouch stockings are stockings with a special coating for modular transtibial prostheses. They are pulled over the PE foam covers (6R8 or 6R18) after sanding their shape, forming the exterior finish of the prosthesis. This provides better protection for the prosthesis against environmental influences and makes it more visually appealing.

Key features

- Stockings with a special coating, for modular transtibial prostheses
- Better protection of the prosthesis against environmental influences (for instance protection against splashed water)
- Available in ten colours and three sizes
- Delivery unit: one pair

Information material

647G1671=ALL_INT IFU 99B116

Technical data

Article number	Size	Ankle circumference	Calf circumference	Foot length	SAP key	Colour
99B116=2-0	2	19 – 21 cm	30 – 33 cm	≥ 21 cm	0	
99B116=4-0	4	22 – 25 cm	34 – 39 cm	≥ 23 cm	0	
99B116=6-0	6	26 – 29 cm	40 – 45 cm	≥ 25 cm	0	
99B116=2-2	2	19 – 21 cm	30 – 33 cm	≥ 21 cm	2	
99B116=4-2	4	22 – 25 cm	34 – 39 cm	≥ 23 cm	2	
99B116=6-2	6	26 – 29 cm	40 – 45 cm	≥ 25 cm	2	
99B116=2-4	2	19 – 21 cm	30 – 33 cm	≥ 21 cm	4	
99B116=4-4	4	22 – 25 cm	34 – 39 cm	≥ 23 cm	4	
99B116=6-4	6	26 – 29 cm	40 – 45 cm	≥ 25 cm	4	
99B116=2-6	2	19 – 21 cm	30 – 33 cm	≥ 21 cm	6	
99B116=4-6	4	22 – 25 cm	34 – 39 cm	≥ 23 cm	6	
99B116=6-6	6	26 – 29 cm	40 – 45 cm	≥ 25 cm	6	
99B116=2-8	2	19 – 21 cm	30 – 33 cm	≥ 21 cm	8	
99B116=4-8	4	22 – 25 cm	34 – 39 cm	≥ 23 cm	8	
99B116=6-8	6	26 – 29 cm	40 – 45 cm	≥ 25 cm	8	
99B116=2-10	2	19 – 21 cm	30 – 33 cm	≥ 21 cm	10	
99B116=4-10	4	22 – 25 cm	34 – 39 cm	≥ 23 cm	10	
99B116=6-10	6	26 – 29 cm	40 – 45 cm	≥ 25 cm	10	
99B116=2-12	2	19 – 21 cm	30 – 33 cm	≥ 21 cm	12	
99B116=4-12	4	22 – 25 cm	34 – 39 cm	≥ 23 cm	12	
99B116=6-12	6	26 – 29 cm	40 – 45 cm	≥ 25 cm	12	
99B116=2-14	2	19 – 21 cm	30 – 33 cm	≥ 21 cm	14	
99B116=4-14	4	22 – 25 cm	34 – 39 cm	≥ 23 cm	14	
99B116=6-14	6	26 – 29 cm	40 – 45 cm	≥ 25 cm	14	
99B116=2-16	2	19 – 21 cm	30 – 33 cm	≥ 21 cm	16	
99B116=4-16	4	22 – 25 cm	34 – 39 cm	≥ 23 cm	16	
99B116=6-16	6	26 – 29 cm	40 – 45 cm	≥ 25 cm	16	
99B116=2-18	2	19 – 21 cm	30 – 33 cm	≥ 21 cm	18	
99B116=4-18	4	22 – 25 cm	34 – 39 cm	≥ 23 cm	18	
99B116=6-18	6	26 – 29 cm	40 – 45 cm	≥ 25 cm	18	

Important for your order:

- You can use the 646M22 colour sampler ring for colour selection. Please note that possible colour deviations between the illustrations in the table of technical data and the actual SoftTouch stockings are due to printing technology reasons.
- Delivery unit: one pair



Colour sampler ring for SoftTouch stockings

Reference number 646M22

Colour sampler ring for SoftTouch stockings with ten different colour samples (skin tones). The sampler ring is used to demonstrate the look and feel of the various SoftTouch versions. It makes it easier to select the desired hue.

Technical data

Article number

646M22

Prosthesis covers

Protective covers



Genium X3 Protective cover

Reference number 4X193-1

To protect against the many stresses of everyday life, the Protective cover made from a durable PU material covers the knee joint. As a result, the Genium X3 easily stands up to even tough conditions. The Protective cover also features an expressive, sporty design. Alternatively, the 4X900 Protective cover can be chosen.

Key features

- Compatible with knee joints: 3B5-2, 3B5-2=ST, 3B5-3 and 3B5=3-ST
- Extremely robust
- Expressive, sporty design
- Colour: Graphite Black (dark anthracite, black)

Technical data

Information material

647G1374=ALL_INT	IFU Qualified Personnel Genium X3
647H47-1=ALL_INT	IFU User Genium X3
647H47-2=ALL_INT	IFU User Genium X3

Article number

4X193-1

Weight

300 g

- The 3B5* Genium X3 may not be used without the Protective cover.

Accessories/spare parts for 4X193-1



Calf closure

Reference number 4X164

Calf closure for Genium X3 Protective cover, spare part for 4X193-1

Technical data

Article number

4X164



Genium X3 Protective cover

Reference number 4X900

To protect against the many stresses of everyday life, the Protective cover made from a durable PU material covers the knee joint. As a result, the Genium X3 easily stands up to even tough conditions. The Protective cover also features a discreet, elegant design. Alternatively, the 4X193-1 Protective cover can be chosen.

Key features

- Compatible with knee joints: 3B5-2, 3B5-2=ST, 3B5-3, 3B5=3-ST
- Extremely robust
- Discreet, elegant design
- Colour: Umbra Grey (warm shade of grey)

Technical data

Information material

647G1374=ALL_INT	IFU Qualified Personnel Genium X3
647H47-1=ALL_INT	IFU User Genium X3
647H47-2=ALL_INT	IFU User Genium X3

Article number	Weight
4X900	315 g

- The 3B5* Genium X3 may not be used without the Protective cover.

Accessories/spare parts for 4X900



Upper closure

Reference number 4P860=U

Calf closure for the 4X900, 4X860, 4X840 and 4P862 covers, spare part

Technical data

Article number
4P860=U

Prosthesis covers

Protective covers



Genium Protective cover

Reference number 4X880

The Genium Protective cover shields the prosthetic knee joint with tube adapter against impacts, environmental influences and wear and tear. The product 4X880 includes the main Protective cover component and Protector foot cuff. The main component can be shortened and adapted to the prosthesis.

Key features

- Compatible with knee joints: 3B1-2, 3B1-2=ST, 3B1-3, 3B1-3=ST
- Compatible with prosthetic feet: 1B1, 1C30, 1C40, 1C50, 1C60, 1C61, 1C63, 1C64, 1D35, 1E56, 1E57, 1M10
- Includes a Protector foot cuff in size S, M or L
- The Protector foot cuff is not compatible with slim footshells
- Can be used for a knee axis–floor measurement from 430 mm (with use of the 1C61 Triton Vertical Shock from 470 mm) to 560 mm
- A charging opening permits inductive charging of the Genium, even through clothing

Information material

647G942=ALL_INT IFU Qualified Personnel
4X880

647H899=ALL_INT IFU User 4X880

Technical data

Article number	Weight (Protective cover including closures)	Weight (cuff)	Size (including cuff)
4X880=S	450 g	60 g	S
4X880=M	450 g	60 g	M
4X880=L	450 g	60 g	L

Important for your order:

- The stated size S, M or L refers to the size of the included Protector foot cuff. It is chosen depending on the foot size of the prosthetic foot (see selection table).
- For combination with the 1B1=*/1B1-2=* Meridium prosthetic foot: The foot includes a connection plate that must be used for the combination with the Protective Cover. The connection plate is compatible with cuff sizes S and M. Cuff size M is equivalent to foot size 29.

Selection table (size)

Prosthetic foot		Protector foot cuff		
Name	Reference number	Size S	Size M	Size L
Triton	1C60	24-25	26-28	29-30
Triton Vertical Shock	1C61	24-25	26-28	29-30
Triton Low Profile	1C63	24-25	26-28	29-30
Triton Heavy Duty	1C64	24-25	26-28	29-30
Trias	1C30	23-25	26-28	29-30
C-Walk	1C40	24-25	26-28	29-30
Taleo	1C50	23-25	26-28	29-30
Dynamic Motion	1D35	23-25	26-28	29-30
Adjust	1M10	23-25	26-28	29-30
Axtion	1E56	23-25	26-28	29-30
Lo Rider	1E57	24-25	26-28	29-31
Meridium	1B1=*/1B1-2*	Connection plate		-



reddot award 2015
winner



DESIGN
AWARD
2015

Accessories/spare parts for 4X880

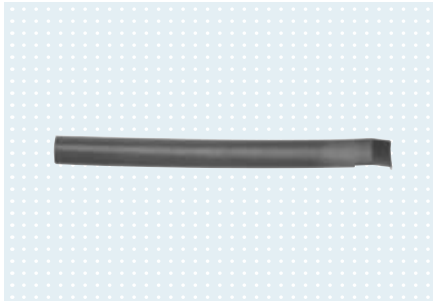

Lengthwise closure

Reference number 4P880=R

Lengthwise closure for Genium Protective cover, spare part for 4X880

Technical data

Article number

4P880=R



Upper closure

Reference number 4P880=U

Upper closure for Genium Protective Cover, spare part for 4X880

Technical data

Article number

4P880=U



Protector foot cuff

Reference number 4P880

Protector foot cuff for the 4X880 Genium Protective cover and 4X860 C-Leg Protective cover, spare part

Technical data

Article number	Size
4P880=S	S
4P880=M	M
4P880=L	L

Prosthesis covers

Protective covers



C-Leg Protective cover (without shield insert)

Reference number 4X860

The C-Leg Protective Cover shields the prosthetic knee joint including tube adapter against impacts, environmental influences and wear and tear. The product 4X860 includes the main Protective Cover component and Protector foot cuff. The main component can be shortened. The 4P863 shield insert shown in the illustration has to be ordered separately. It is available in three different designs.

Key features

- Compatible with knee joints: 3C98-3, 3C88-3
- Compatible with prosthetic feet: 1B1, 1C30, 1C40, 1C50, 1C60, 1C61, 1C63, 1C64, 1D35, 1E56, 1E57, 1M10
- Includes a Protector foot cuff in size S, M or L
- The Protector foot cuff is not compatible with slim footshells
- Can be used for a knee axis–floor measurement from 430 mm (with use of the 1C61 Triton Vertical Shock from 470 mm) to 560 mm
- Available in the colour variants champagne (illustration on the right) and dark volcano (illustration on the left, add -8.4 to the article number for the colour dark volcano)

Information material

647G1113=ALL_INT	IFU Qualified Personnel 4X860
647H908=ALL_INT	IFU User 4X860

Technical data

Article number	Size (including cuff)	Weight (Protective cover including closures)	Weight (cuff)	Colour
4X860=S	S	450 g	60 g	champagne
4X860=S-8.4	S	450 g	60 g	dark volcano
4X860=M	M	450 g	60 g	champagne
4X860=M-8.4	M	450 g	60 g	dark volcano
4X860=L	L	450 g	60 g	champagne
4X860=L-8.4	L	450 g	60 g	dark volcano

Important for your order:

- The stated size S, M or L refers to the size of the included Protector foot cuff. It is chosen depending on the foot size of the prosthetic foot (see selection table).
- The Protective cover has to be combined with the 4P863 shield insert. The shield insert has to be ordered separately.
- For combination with the 1B1=*/1B1-2=* Meridium prosthetic foot: The foot includes a connection plate that must be used for the combination with the Protective Cover. The connection plate is compatible with cuff sizes S and M. Cuff size M is equivalent to foot size 29.

Selection table (size)

Prosthetic foot	Reference number	Protector foot cuff		
		Size S	Size M	Size L
Triton	1C60	24-25	26-28	29-30
Triton Vertical Shock	1C61	24-25	26-28	29-30
Triton Low Profile	1C63	24-25	26-28	29-30
Triton Heavy Duty	1C64	24-25	26-28	29-30
Trias	1C30	23-25	26-28	29-30
C-Walk	1C40	24-25	26-28	29-30
Taleo	1C50	23-25	26-28	29-30
Dynamic Motion	1D35	23-25	26-28	29-30
Adjust	1M10	23-25	26-28	29-30
Axtion	1E56	23-25	26-28	29-30
Lo Rider	1E57	24-25	26-28	29-31
Meridium	1B1=*/1B1-2*	Connection plate		-

Accessories/spare parts for 4X860

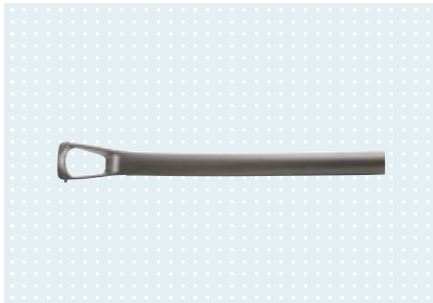

Lengthwise closure

Reference number 4P860=R

Lengthwise closure for 4X860 C-Leg Protective cover, spare part

Technical data

Article number

4P860=R



Upper closure

Reference number 4P860=U

Calf closure for the 4X900, 4X860, 4X840 and 4P862 covers, spare part

Technical data

Article number

4P860=U



Protector foot cuff

Reference number 4P880

Protector foot cuff for the 4X880 Genium Protective cover and 4X860 C-Leg Protective cover, spare part

Technical data

Article number	Size
4P880=S	S
4P880=M	M
4P880=L	L

Prosthesis covers

Protective covers



Shield insert

Reference number 4P863

The shield insert is part of the prescribed accessories for the 4X860 C-Leg Protective cover. It is inserted into the main part of the Protective cover from the front. Optionally, it can also be used with the 4P862 C-Leg Guard. The shield insert is available in three different designs.

Key features

- Available in three designs

Technical data

Article image



Article number	4P863=1	4P863=2	4P863=3
Weight	63 g	63 g	63 g

Information material

647G1113=ALL_INT	IFU Qualified Personnel 4X860
647H908=ALL_INT	IFU User 4X860
647G1214=ALL_INT	IFU Qualified Personnel 4P862



C-Leg Guard

Reference number 4P862

The guard functionally and visually sheaths the C-Leg 4. In the covered area, the guard protects the knee joint, for example against scratching. The guard can be combined with the 4P863 Shield insert.

Key features

- Compatible with knee joints: 3C98-3 and 3C88-3

Technical data

Article number	Weight
4P862	225 g

Information material

647G1214=ALL_INT	IFU Qualified Personnel 4P862
------------------	----------------------------------

Accessories/spare parts for 4P862



Upper closure

Reference number 4P860=U

Calf closure for the 4X900, 4X860, 4X840 and 4P862 covers, spare part

Technical data

Article number
4P860=U



Kenevo Protective cover

Reference number 4X840

The robust protective cover shields the Kenevo prosthetic knee joint against jolts, environmental influences and wear and tear. It can be shortened and thereby customised to the prosthesis wearer. The corresponding distal cap is attached after shortening to cover the cut edge.

Key features

- Compatible with knee joints: 3C60, 3C60=ST
- The Kenevo Protective cover can be used for all knee axis-floor measurements that can be configured with the Kenevo

Technical data

Article number	Weight
4X840	391 g

Information material

647G1139=ALL_INT	IFU Qualified Personnel 4X840
647H910=ALL_INT	IFU User 4X840

Accessories/spare parts for 4X840

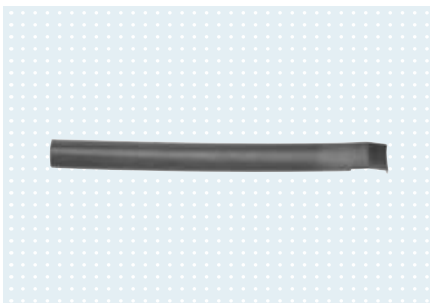

Lengthwise closure

Reference number 4P840=R

Lengthwise closure for 4X840 Kenevo Protective cover, spare part

Technical data

Article number
4P840=R



Upper closure

Reference number 4P860=U

Calf closure for the 4X900, 4X860, 4X840 and 4P862 covers, spare part

Technical data

Article number
4P860=U



Distal cap

Reference number 4P8

The distal cap is a spare part for the 4X840 Kenevo Protective cover and covers the cut edge after shortening the protective cover.

Technical data

Article number
4P8

Prosthesis covers

Accessories for modular leg prostheses



Option set for modular hip disarticulation prostheses

Reference number 4R32

The accessory set is used in combination with a foam cover to restore the natural leg volume with modular hip disarticulation prostheses. It is part of a connection cover, which is individually fabricated, glued into the foam cover and attached to the socket using the elastic strap.

Technical data

Article number

4R32

- Scope of delivery: two connecting straps with ring, two tapered rings, two wedges, one ThermoLyn trolene strip (as casting template), one pair 99B14=3 Perlon cosmetic stockings



Prosthesis bag

Reference number 642C3

PU-coated prosthesis bag with zip and two interior mesh pockets. Colour: warm shade of grey with white Ottobock logo. Available in two sizes (for transfemoral and transtibial prostheses).

Technical data

Article number	For	Length	Width
642C3=1	Transtibial prosthesis	82 cm	39 cm
642C3	Transfemoral prosthesis	118 cm	45 cm

Lower limb silicone cover iFab Ordering process

1. Measure the patient's contralateral side and complete the measurement form. Also please take an impression and photos of the contralateral side, and determine the colour depending on the type of prosthesis with help of the colour sheet (647F285=GB).

Please send the prosthesis to be coated, along with

- the measurement form,
 - the colour determination documents,
 - the impression of the contralateral side, and
 - the photos
- to Ottobock iFab.

2. Ottobock iFab will fabricate the definitive silicone cover for you and ship it within 20 working days.

3. You receive an easy to clean, functional silicone cover that helps restore the outward appearance of your patient.

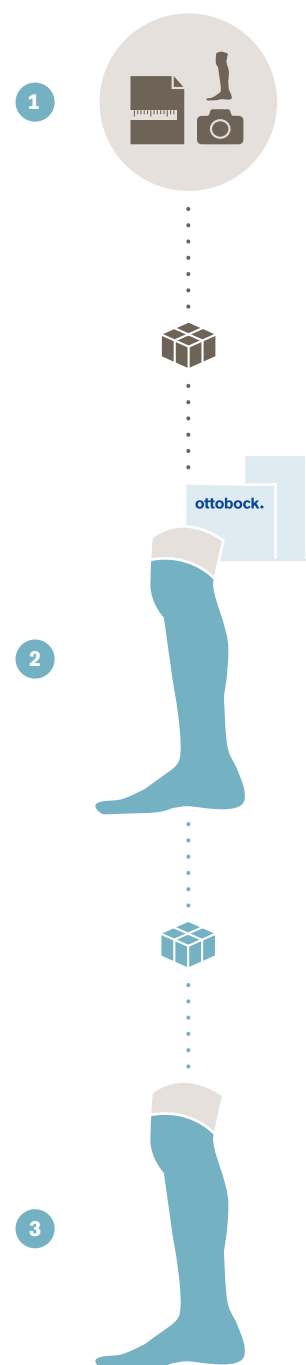

Lower limb silicone cover

iFab Order form

Contact person	Customer	Date
Customer		Shipping address (if different from customer address)
Company	Company	
Street	Street	
Postal code/city	Postal code/city	
E-mail	Phone	
Commission		

Age **Gender** Female Male
Size **Affected side** Left Right
Weight **Mobility grade** 1 2 3 4



Configuration

- 88A20=N** "Natural" silicone cover
- 88A20=C** "Classic" silicone cover
- 88A32=S** Silicone nails (multicoloured)
- 88A32=A** Acrylic nails (multicoloured)
- Colour determination as per colour determination sheet
- 88A20=H** Genuine leg hair (from contralateral side)
- 88A20=T** Tattoo (Implementation of special requests)

Prosthetic feet

- 1C60** Triton
- 1C40** C-Walk
- 1C30** Trias
- 1E56** Axion
- 1D10** Dynamic foot*
- 1D35** Dynamic Motion*

Scope of delivery

- Complete checklist
- Assembled prosthesis
- Cast of the contralateral side
- Photos

Prosthetic foot length in cm:.....
 Heel height in mm:

* Hallux separation possible.

Comments:

.....

.....

.....

.....

.....

.....

Lower limb silicone cover iFab Measurement form

Contact person	Customer	Date
----------------	----------	------

Please take the circumference of the sound leg every 5 cm.

The diagram shows a line drawing of a human lower leg and foot. A vertical double-headed arrow on the right side of the foot indicates a height of 10 cm from the ground to the first measurement point. To the right of the leg, there are two columns of rounded rectangular boxes. The first column is labeled 'Sound leg' and contains 11 boxes. The second column is labeled 'Prosthesis' and contains 11 boxes. Each box in the 'Sound leg' column is connected to a corresponding box in the 'Prosthesis' column by a horizontal line. The bottom-most box in the 'Sound leg' column has an asterisk (*) next to it.

Sound leg **Prosthesis**

* Take first measurement from 10 cm height

Comments:

.....

.....

.....

.....

.....

.....

.....

.....

.....

.....

Lower limb silicone cover iFab Colour determination sheet

Contact person	Customer	Date
----------------	----------	------

Colour sample – colour strength

Use pen to mark skin colours on the sketch

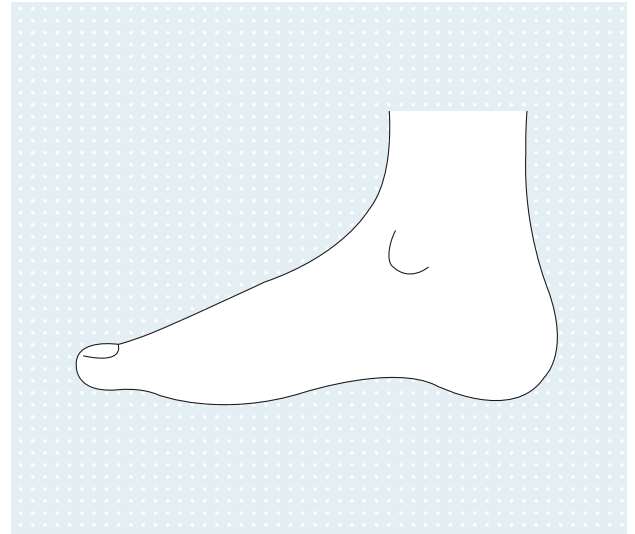

IV	III*	II	I
Pen	Colour sample	Colour strength	
1			
2			
3			
4			
5			
6			
7			
8			

Model blood vessels Yes No

*Choose thickness III for the primer.

Nails

- Acrylic
- Silicone

Nail length

- Like photo
- mm longer

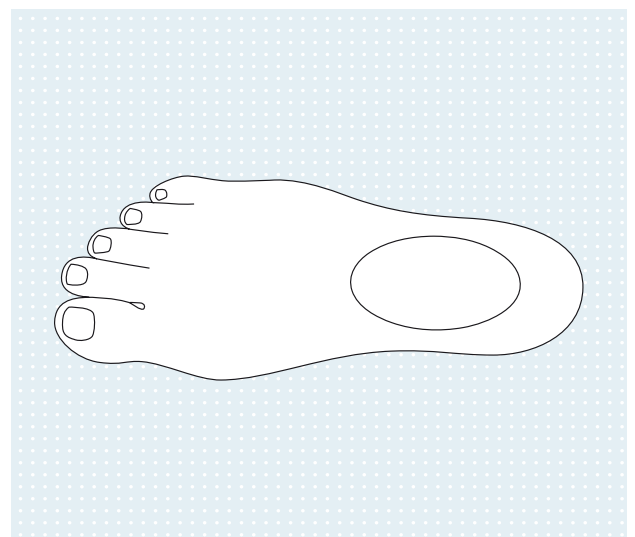

	Hallux	Toes II – V
Nail tip		
Distal edge		
Central		
Proximal edge		
Moon		

Comments:

A	
Adapter plate	233, 415
Adjusting tool	72, 313
Adjustment adapter	51
Ankle block.....	57
Aqua foot with modular adapter.....	56
Aqua foot without adapter for exoskeletal design.....	57
Aqua knee.....	71
AXON tube adapter.....	322, 336, 344
AXON tube adapter with torsion unit.....	322, 336
Axtion.....	151
Axtion DP pylon foot	187
B	
Battery charger	329
BionicLink PC.....	323, 329, 336, 344
Blocking clip ProCarve foot.....	90
BM-214.....	185
B oval pylon adapter.....	191
C	
Caleo	375, 376
Caleo 3D	377, 378, 379
Calf closure.....	490
Cap screw.....	49, 236
Cap screw (Allen screw).....	33, 45, 49, 218, 236, 245
Challenger	86
Charger extension cable, ankle.....	330
Charger extension cable, ankle, long.....	330
Charger extension cable, knee.....	330, 472
Chopart footplate.....	192
Chopart footplate for children	25
Chopart PU adhesive set	25, 26, 193
Chopart PU adhesive set, small parts set	193
Clamping nut.....	47, 236
Clamping screw	219, 225, 235
Clamping screw, blue coated	61, 63, 245
C-Leg 4.....	326
C-Leg 16° flexion stop.....	330
C-Leg Guard.....	496
C-Leg Protective cover (without shield insert).....	331, 494
ClickValve.....	66, 68, 395, 400
ClickValve base.....	67, 399
ClickValve safety shackle.....	67, 399
Cockpit app.....	332, 340, 346
Colour determination ring	200, 484
Colour sampler ring for SoftTouch stockings	489
Combination wrench	273
Compression spring	305
Compression spring, heavy duty.....	305
Connecting tube with seat ring	402
Connection adapter	230
Connection adapter with pyramid receiver	231
Connection cover.....	149, 152, 166, 167, 178, 179, 189, 193, 197
Cosmetic exhaust flange	163, 173
Cotton residual limb sock	437
Countersunk head screw	31
Countersunk head screw	261
Countersunk head screw (Allen screw).....	47, 49, 51, 53, 237, 251, 254
Cover for 4R182/4R183.....	413
C-Soft Plus	328
Custom silicone cover lower limb	150, 153, 180, 482
Custom silicone partial foot prosthesis and toe prosthesis	198
C-Walk	148
Cylinder body for 4R220.....	405
Cylinder pin.....	60
Cylinder pin with interior thread	61
D	
DeltaTwist.....	271
Derma Clean	393
Derma Prevent	393
Derma Protection sealing sleeve	418
Derma Repair.....	393
Derma Seal	440
Derma Seal Double Forte.....	441
Derma Seal Forte	440
Derma Seal Trans Ped.....	441
Derma travel set.....	394
Derma trial set	394
Distal cap.....	497
Donning spray	392
Double adapter.....	227, 228, 229
Double adapter, aluminium.....	226
Double adapter, sliding	227
Double adapter, titanium.....	226
Duckbill valve.....	404
Dummy set.....	65, 430, 431
Dummy set for 4R220.....	406
Dummy set for 4R220=1	406
Dummy set with screw.....	430
Dynamic foot for children.....	23
Dynamic Vacuum System liner	380
Dynamic Vacuum System pump	403
E	
EBS knee joint, polycentric, with hydraulic swing phase control	308
EBSpro knee joint, polycentric, with hydraulic swing phase control	307
Elastomer plate.....	273
Elastomer rod	273
Electronic knee joint	317
Empower.....	182
Empower AC adapter	185
Empower battery.....	185
Empower charger.....	185
Empower footshell.....	184
Empower tablet.....	186
F	
Flat rubber valve.....	401
Flat rubber valve set	396, 397
Flat rubber valve set with connection tube	397
Flat silicone valve	400
Flexible pin for MagnoFlex lock	427
Foam cover	39, 324, 332, 339, 476, 477, 478, 479, 480, 481
Foam cover	39, 480
Foot adapter with screw connection	24
Footshell.....	90, 149, 152, 166, 178, 189, 192, 195, 196
Footshell foam kit, single application.....	26, 193
Footshell for children	25
Footshell replacement tool, metal	201
Footshell replacement tool, plastic.....	88, 201
Forefoot pad	88
Functional cosmesis C-Leg	332, 471
Functional cosmesis C-Leg (functional knee part)	471
Functional cosmesis Genium.....	339, 473
Functional cosmesis Genium (functional knee part)	474
Functional ring	171
Functional ring for Harmony P3	173, 414
Functional shank C-Leg.....	472

- Functional shank Genium..... 474
 Functional stocking for functional cosmesis..... 332, 340, 475
- G**
- Gaiter for sealing sleeves 422
 Genium 334
 Genium 7.5° flexion stop 338
 Genium 15° flexion stop 338
 Genium 22.5° flexion stop 338
 Genium Protective cover 492
 Genium Protective Cover 339
 Genium X3 342
 Genium X3 7.5° flexion stop 345
 Genium X3 15° flexion stop 345
 Genium X3 22.5° flexion stop 346
 Genium X3 Protective cover 490, 491
 Genium X3 Protective Cover 346
 Grub screw 45, 50, 51
 Guard for C-Leg 331
- H**
- Habermann knee joint, polycentric,
 with integrated extension assist 290, 291
 Hair 199, 483
 Harmony E2 412
 Harmony elastomer rod (red) 413
 Harmony elastomer rod (yellow) 413
 Harmony P3 411
 Harmony P3 service set 163, 414
 Harmony P4 407
 Harmony P4 HD 408
 Harmony P4 HD housing screw connection 414
 Harmony P4 HD modular 410
 Harmony P4 housing screw connection 414
 Harmony P4 modular 409
 Harmony sealing sleeve, conical 421
 Harmony sealing sleeve, cylindrical 421
 Harmony Triton 172
 Harmony vacuum pump set 416
 Harmony valve with filter 162
 Heel wedge for Axtion 152
 Heel wedge set 88
 Heel wedges for Taleo 167, 184
 Heel wedges for Triton 179
 Helix3D prosthetic hip joint 352
 Hexagon nut with conical support 50
 High-pressure air pump 90
 Hip joint, monocentric, with inner extension assist 350
 Hip joint with adjustable extension assist mechanism 38
 Hose for the outlet 417
- I**
- Illumination set 200, 484
 Inductive charger 323, 337, 345
 Installation ring for inductive charger 338
 Installation tool for inductive charger 337
- K**
- Kenevo 320
 Kenevo 16° flexion stop 324
 Kenevo Protective cover 497
 Kenevo Protective Cover 324
 KISS 4-hole base 433
 KISS Delrin base 433
 KISS distal belts (2 pieces) 432
- KISS distal screws (two pieces) 434
 KISS hook-and-loop fixation (set with screw and nut) 433
 KISS lanyard system 432
 KISS proximal belts (2 pieces) 432
 KISS proximal nut and screw (set) 433
 Knee extender 330, 472
 Knee joint for disarticulation, polycentric,
 with hydraulic swing phase control 315
 Knee joint for disarticulation, polycentric, with lock 279, 280
 Knee joint for disarticulation, polycentric,
 with mechanical extension assist 297, 298
 Knee joint, monocentric, with hydraulic swing phase control 312
 Knee joint, monocentric, with lock and extension assist 282, 283
 Knee joint, monocentric, with rotation hydraulics 71, 310
 Knee joint, polycentric, with hydraulic swing phase control 314
 Knee joint, polycentric, with pneumatic swing phase control 301, 303
 Knee joint, polycentric, with servo-pneumatic swing phase control 304
 Knee joint with adjustable extension assist mechanism 35
 Knee joint with friction brake, monocentric, with extension assist 296
 Knee joint with friction brake, monocentric,
 with extension assist and protective sleeve 287
 Knee joint with friction brake, monocentric, with lock 293
 Knee joint with friction brake, monocentric,
 with pneumatic swing phase control 300
 Knee joint with friction brake,
 with extension assist and protective sleeve 288
 Knee joint with hydraulic swing phase control 37
 Knee joint with integrated rotation 36
 Knee joint with lock 34
 K-Soft 322
- L**
- L-adapter 79
 Lamination anchor 195, 281, 299, 302, 306, 309, 316
 Lamination anchor with pyramid 238, 239
 Lamination anchor with pyramid and angled arm, rotatable 243
 Lamination anchor with pyramid receiver 32
 Lamination anchor with pyramid receiver and angled arm,
 rotatable 62, 243, 318
 Lamination anchor with pyramid receiver, rotatable 240, 242, 318
 Lamination anchor with pyramid, rotatable 62, 240, 241
 Lamination anchor with threaded connector 239, 241, 429
 Lamination anchor with threaded connector and angled arm 242
 Lamination disc 252, 428
 Lamination disc and dummy 413
 Lamination dummy 31, 63, 244, 263, 265
 Lamination plate 354
 Lamination set 434
 Latex casting bags 416
 Lengthwise closure 493, 495
 Lengthwise closure 497
 Light metal tube 218, 223, 356
 Lightweight knee joint, monocentric, with lock 278
 Liner 448
 Liner Fit Kit 415, 439
 Liner trimmer 392
 Locking clip 92
 Locking knee joint, monocentric, with lock 277
 Locking unit 294
 Lo Rider 196
 Lubricating cream 416
- M**
- MagnoFlex Lock 426
 MagnoFlex Lock socket attachment block 429
 MagValve 396

Index

MagValve upper part.....	400
Modular transfemoral kit.....	259
Modular transtibial kit.....	255, 256, 257, 258, 259
Monocentric hip joint with hydraulic control	351
Mounting plate	48
Mounting wrench	406
Multi-colour “Classic” and “Natural” acrylic nails	199, 483
Multi-colour “Classic” and “Natural” silicone nails.....	199, 483

N

Nylon sheath.....	439
Nylon sheath with distal hole	438
Nylon stocking	472, 474

O

One-way valve.....	397
Option set for modular hip disarticulation prostheses.....	356, 498
O-ring for ClickValve, black	67, 399
O-ring for ClickValve upper valve part, blue	68, 400
Ottobock TF Design software	450
Oval Allen head screw	30
Oval flange head screw (Allen screw)	47, 236
Oval pylon adapter, 30 mm.....	190
Oval pylon adapter, 34 mm	190
Oval pylon adapter, 34 mm, long.....	190

P

Pedilan sole with heel wedge for 1S30	22
Pedilin cone for soft socket	447
Perlon connecting piece.....	486
Perlon cosmetic stocking	40
Perlon cosmetic stockings for hip disarticulation fittings	487
Perlon cosmetic stockings, long.....	486
Perlon knee stockings	487
Pheon polycentric knee joint, with hydraulic swing phase control.....	286
Pin	427
Pin for shuttle lock.....	64
Pin, long	427
Pin, short	427
Pirogoff foot	202
Piston.....	404
Plastic ring.....	60, 224
Plastic tab for 6A52	65, 428
Posterior connection plate (set)	78
Power cord.....	185
Power cord AUS	186
Power supply unit.....	323, 329, 337, 345
Pressure plate	49, 251
ProCarve knee joint.....	92
ProCarve prosthetic foot	89
Procomfort gel	447
ProFlex Plus sealing sleeve	420
ProFlex sealing sleeve	419
ProSeal liner	374
ProSeal ring	422
Prosedo monocentric locking knee joint, with hydraulic sitting assist	285
Prosthesis bag.....	498
ProSymes.....	194
Protective cap	265
Protective sleeve	289
Protector foot cuff	493, 495
PushValve	66, 395
PushValve upper part	68, 400
PVC connection tube.....	402
Pyramid receiver	53, 235

Pyramid receiver with threaded connector	232, 245
Pyramid with threaded connector	232, 245

Q

Quickchange.....	260
Quickchange locking bolt	261
Quickchange lower section.....	261

R

Ratchet unit	64, 428
Reference determination tool.....	356
Release button cover	263
Residual limb compression sock.....	443, 444, 445, 446
Residual limb sock.....	435, 436
Residual limb sock with distal hole	435, 436
Rotation adapter	262, 264
Rotation locking plate, extra hard	273
Rounded washer	63, 246
Runner.....	81
Runner adapter with pyramid, rotatable.....	82
Runner four-hole adapter	82
Runner junior	27, 84
Runner junior adapter with pyramid, rotatable	28, 85
Runner junior sole	28, 85
Runner spike sole	83
Runner universal sole	83

S

SACH foot for children	22, 23
Safeguard sticker for 1E90 Sprinter	80
Scaled tube 230 mm	45
Scaled tube 300 mm	45
Scissors.....	392
Screw connection	24, 57
Screw set.....	195
Seat ring	401
Set screw.....	33, 59, 61, 63, 65, 218, 224, 235, 236, 237, 246, 251, 263, 265, 270, 430
Setting aid with screw.....	195
Sheet metal screw	254
Shield insert	331, 496
Shuttle lock.....	425
Shuttle lock housing with bushing	65, 429
Shuttle lock housing with pyramid.....	430
Shuttle lock housing with pyramid receiver.....	430
Shuttle lock, waterproof	64, 425
Shuttle lock with pyramid	424
Shuttle lock with pyramid receiver	424
Single component pack	34, 35, 38, 219, 224, 270, 278, 281, 284, 289, 292, 299, 306, 313, 314, 316, 354
Single component pack for knee joint cover	295
SiOCX TF	451
SiOCX TF Pro.....	452
Skeo.....	360, 363, 367
Skeo 3D	365, 369
Skeo 3D	366, 370
Skeo Pure.....	70, 362
Skeo Pure	69, 361
Skeo Sealing	371
Skeo Skinguard.....	368
Skeo Skinguard	364
Skeo Unique.....	372
Slider plate for MagnoFlex Lock	429
Sliding adapter	46, 52, 228, 229, 233, 234
Sliding adapter set	48
Snap bushing.....	405, 429

- Socket adapter 32
 Socket adapter with pyramid 247, 248
 Socket adapter with pyramid, eccentric 249
 Socket adapter with pyramid receiver 249, 250, 319
 Socket adapter with pyramid receiver, rotatable 250, 251, 318
 Socket adapter with pyramid, rotatable 248
 Socket attachment 253
 Socket attachment block 31, 428
 Socket attachment block for lamination technique 252
 Socket attachment block for thermoplastic socket 253
 Socket connector 173, 415
 Socket extension, 1/2" 272
 Socket nut, 1/2" hexagon SW11 272
 SoftTouch stockings for transtibial prostheses 488
 Sole set 90
 Spacer plate 405
 Special grease 272, 404
 Special scissors for cutting synthetic fabrics 392
 Spectra protective sock black 153, 167, 179, 184, 197
 Sports knee joint 37, 91
 Spots 442
 Sprinter 76
 Sprinter spike sole 80
 Sprinter universal sole 79
 Sticky Spots 442
 Stop ring 405
 SuperSkin sampler ring 485
- T**
- T-adapter 78
 Taleo 154
 Taleo bolt cover 156, 159, 162
 Taleo Harmony 160
 Taleo Harmony functional ring 162
 Taleo Low Profile 164
 Taleo Low Profile bolt cover 165
 Taleo Vertical Shock 157
 Taleo Vertical Shock functional ring set 159
 Tattoo for silicone prostheses 199, 483
 Terry cloth residual limb sock 437
 Terry cloth residual limb sock with distal hole 438
 TES belt 423
 TF definitive sports foot adapter 79
 TF Design bag 450
 TF Design check sockets 449
 TF test sports foot adapter 78
 T-handle, 1/2" 272
 Threaded valve set 396
 Tool 254
 Torsion adapter with 4-hole connection 267
 Torsion adapter with tube 268, 269, 328
 Torsion adapter with tube clamp 267
 Torsion adapter with tube clamp 266
 Triton 168
 Triton Heavy Duty 175
 Triton Low Profile 174
 Triton side flex 176
 Triton Vertical Shock 170
 TT definitive sports foot adapter 77
 TT Design/ TF Design case kit 450
 TT test sports foot adapter 77
 Tube adapter 29, 58, 72, 212, 213, 220, 294, 296, 305, 311, 328
 Tube adapter, angled 30, 59, 214
 Tube adapter, length-adjustable 44
 Tube clamp adapter 30, 60, 189, 190, 191, 214, 215, 216, 221, 222
 Tube clamp adapter, angled 217, 355
 Tube clamp adapter, angled 223, 355
 Tube clamp adapter, movable 216, 217, 222
 Two-hole pin wrench 67, 399
- U**
- Uneo 381, 384
 Uneo 3D 388
 Uneo Flex 382
 Uneo Fresh 387
 Uneo Pure / Uneo Skinguard 385
 Uneo / Uneo Skinguard 386
 Uneo Unique 390
 Upper closure 491, 493, 495, 496, 497
 USB Adapter for charging 323, 329, 337, 345
- V**
- V4 EasyLine valve set 398
 V4 valve, right-angled 163
 V4 valve set 398
 V4 valve, straight 163, 402
 Vacuum connector 415
 Valve bushing 404
 Varos 448
- W**
- Washer 50
 Wool residual limb sock 439
- X**
- XEKT2137 261
 XO coupler 197
 X-Soft 336, 344
- 1 – 10**
- 3 mm spacer plate 261
 5x2.5 O-ring pack 416
 7x1 O-ring pack 417

Reference number index

1

1A1-2.....	182
1A30.....	128
1A31.....	129
1B1-2.....	142
1C10.....	134
1C11.....	124
1C20.....	194
1C30.....	136
1C40.....	148
1C50.....	154
1C51.....	157
1C52.....	160
1C53.....	164
1C60.....	168
1C61.....	170
1C62.....	172
1C63.....	174
1C64.....	175
1C68.....	176
1D10.....	111, 114
1D11.....	116
1D35.....	131
1E2/1E2=1.....	89
1E56.....	151
1E57.....	196
1E58.....	187
1E81.....	192
1E87.....	25
1E90.....	76
1E91.....	81
1E93.....	27, 84
1E95.....	86
1G6.....	97
1H38.....	99
1H40.....	100
1K10.....	23
1K30.....	23
1M10.....	120
1P9.....	202
1S30.....	22
1S49.....	104
1S66.....	105
1S90.....	103
1S101.....	108
1WR95.....	56, 57

2

2C1.....	121
2C2.....	195
2C3.....	138
2C4.....	149
2C5.....	152, 189, 192, 196
2C6.....	178
2C7.....	144
2C10.....	132, 138, 152, 189, 193, 197
2C11.....	132, 149
2C12.....	126, 135
2C13.....	126, 135
2C15.....	166
2C16.....	184
2C19.....	121, 166, 178
2C20.....	122, 139, 167, 179
2C100.....	201
2C101.....	88, 146, 201
2D3.....	130

2D4.....	130
2D5.....	102
2D6.....	24, 109
2D6=M8.....	118
2D6=M10.....	106, 112, 118
2D7=M8.....	98, 118
2D7=M10.....	107, 110, 113, 119
2D11.....	122
2E3.....	25
2F20.....	152
2F50.....	167, 184
2F51.....	156, 159, 162
2F52.....	165
2F60.....	179
2F95.....	88
2G72.....	145
2G120.....	195
2K34.....	57
2R2/2R3.....	213
2R8.....	118
2R8=M10.....	106, 109, 112
2R10.....	101
2R14.....	98, 107, 110, 119
2R17.....	322
2R19.....	344
2R20.....	322, 336
2R21.....	322, 336
2R22.....	102
2R30.....	218, 356
2R31.....	117
2R31=M8.....	98
2R31=M10.....	106, 109, 112
2R33.....	101
2R36.....	223, 356
2R37/2R38.....	212
2R38=10.....	214
2R40.....	24
2R41.....	29
2R45=34.....	44
2R45=S.....	44
2R48.....	30
2R50=AL/2R49=AL.....	213
2R50/2R49.....	212, 305
2R51.....	101
2R54.....	117
2R54=M8.....	97
2R54=M10.....	106, 109, 112
2R56.....	45
2R57/2R58.....	72, 220, 294, 311, 328
2R67.....	269, 328
2R76/2R77.....	220, 294, 296, 311
2R86.....	129
2R102.....	258
2R103.....	259
2R105.....	256
2R117.....	173, 415
2R119.....	415
2R120.....	255
2R121.....	255
2R122.....	256
2R123.....	257
2R124.....	257
2R125.....	258
2R176.....	78
2R177.....	79
2R182.....	190
2R183.....	190
2R185.....	191

2S88.....	102
2WR95.....	58
2WR95=1.....	59
2Z22.....	57
2Z25.....	22
2Z95.....	88
2Z120.....	195
2Z328.....	195
2Z358.....	80
2Z360.....	162
2Z361.....	162
2Z362.....	159
2Z500.....	79
2Z501.....	80
2Z503.....	90
2Z540.....	83
2Z541.....	83
2Z543.....	28, 85

3

3B1-3.....	334
3B5-3.....	342
3C60.....	320
3C88-3/3C98-3.....	326
3E80.....	317
3F1=1.....	332, 471
3F1=1-N.....	471
3F1=2.....	339, 473
3F1=2-N.....	474
3P101=1.....	472
3P101=2.....	474
3P102.....	472, 474
3R2.....	92
3R6.....	476
3R15.....	288
3R17.....	283
3R20.....	291
3R21.....	298
3R23.....	280
3R24.....	478
3R30.....	297
3R31.....	285
3R32.....	279
3R33.....	282
3R36.....	290
3R38.....	35
3R39.....	34
3R40.....	278
3R41.....	277
3R46.....	315
3R48.....	39
3R49.....	287
3R55.....	314
3R60.....	308
3R60-PRO.....	307
3R62.....	286
3R66.....	36
3R67.....	37
3R78.....	301
3R80.....	71, 310
3R90.....	296
3R92.....	300
3R93.....	293
3R95.....	312
3R106.....	303
3R106-PRO.....	304
3S26.....	324, 332, 339, 476

Reference number index

3S27	480	4R50	232	4R180	407
3S80	37, 91	4R51	250, 318	4R181	408
3S106	477	4R52	214	4R182	409
3S107	479	4R54	247	4R183	410
3S124	478	4R55	249, 319	4R201	259
3WR95	71	4R56	217, 355	4R204	79
4		4R57	262	4R206	78
4D1	289	4R57=WR	264	4R208	77
4D3	306	4R60	32	4R210	77
4D4	219, 224, 270	4R63	238	4R212	77
4D7	299	4R66	30	4R216	82
4D9	281	4R68	238	4R218	82
4D10	284	4R69	215	4R220	403
4D11	284	4R72	226	4R224	28, 85
4D13	292	4R72=D	231	4R420	78
4D15	35	4R73	249	4WR95=1	62
4D16	278	4R74	247	4WR95=2	62
4D17	313	4R75	231	4WR95=3	60
4D18	316	4R76	227	4X1	336, 344
4D19	314	4R77	248	4X3	244
4D20	34	4R78	228	4X8	31
4D28	224	4R82	189, 190, 191, 221	4X28	60, 224
4D29	295	4R82=P	191	4X46	63, 244, 263, 265
4E50-2	146, 329	4R84	229	4X52	244
4E60	337, 345	4R84=D	230	4X69	263
4E70	323	4R85	266	4X147	173, 414
4F34	294	4R86	267	4X148	163, 414
4G70	281, 299, 302, 306, 309, 316	4R87	245	4X154	144
4G115	90, 92	4R88	222	4X156	330
4G764	72, 313	4R89	240	4X157	330, 472
4G791	261	4R91	222	4X158	330
4G872	145	4R95	250	4X164	490
4G901	90	4R98	217	4X193-1	346, 490
4H99	338	4R100	238	4X220	417
4H100	338	4R101	46, 233	4X258	337
4H101	345	4R103	216	4X259	338
4H102	345	4R104	227	4X260	171
4H103	338	4R110	32	4X314	405
4H104	346	4R111	242, 318	4X315	416
4H105	330, 472	4R111=N/4R111=T	241, 429	4X316	417
4H106	330	4R112	48	4X320	404
4H108	324	4R112*	48	4X322	404
4P8	497	4R116	241	4X324=3	405
4P840=R	497	4R117	243	4X324=4	405
4P860=R	495	4R118	233	4X326	406
4P860=U	491, 495, 496, 497	4R119	243, 318	4X326=1	406
4P862	331, 496	4R119=N*	242	4X338	406
4P863	331, 496	4R120/4R121	271	4X339	405
4P880	493, 495	4R136	398	4X345	261
4P880=R	493	4R136=EL	398	4X356	413
4P880=U	493	4R140	397	4X440	328
4R1	51	4R142	163, 402	4X441*	144, 332, 340, 346
4R10	260	4R143	163	4X445	322
4R10=01	261	4R147	411	4X446	414
4R21	216	4R152	412	4X840	324, 497
4R22	250	4R153	415	4X860	331, 494
4R23	248	4R156	223, 355	4X880	339, 492
4R32	356, 498	4R160	432	4X900	346, 491
4R37	251	4R161	434	4X903	413
4R39	268	4R163	433	4X904	414
4R40	267	4R164	433	4Y19	49, 251
4R41	240, 318	4R165	432	4Y212	47, 236
4R42	239	4R166	432	4Y347	413
4R43	239	4R167	433	4Y348	413
4R44	245	4R170	52, 234	4Y383	163, 173
4R44=L	232	4R173	53, 235	4Y423	60
		4R174	434	4Y424	61
		4R175	433	4Y492	265

Reference number index

5

5A60.....	448
5R1.....	252
5R2.....	252, 428
5R2=C.....	253, 428
5R6.....	253
5R9.....	31
5T9.....	449
5X55.....	430
5X108.....	65, 430
5X120.....	65, 429
5X125.....	431
5X163.....	405, 429
5Y14.....	254

6

6A20.....	424
6A30.....	64, 425
6A40.....	426
6A41.....	429
6A43.....	429
6A51=10.....	430
6A51=20.....	430
6A52.....	64, 428
6A52=K.....	428
6A53.....	228
6A54.....	229
6A61.....	65, 428
6R6.....	481
6R7.....	39
6R8.....	480
6R18.....	481
6T2.....	447
6Y13.....	64
6Y13=1.....	427
6Y13=2.....	427
6Y13=F1.....	427
6Y13=L1.....	427
6Y41.....	69, 361
6Y42.....	360
6Y43.....	70, 362
6Y60.....	381
6Y70.....	363
6Y75.....	364
6Y77.....	365
6Y78.....	366
6Y80.....	367
6Y81.....	374
6Y85.....	368
6Y87.....	369
6Y88.....	370
6Y90.....	375
6Y92.....	376
6Y93.....	377
6Y93F.....	378
6Y94.....	380
6Y95.....	379
6Y110.....	371
6Y200.....	448
6Y400.....	390
6Y510.....	382
6Y512.....	387, 388
6Y520.....	384
6Y522.....	385
6Y523.....	386
6Y700.....	372

7

7D2.....	354
7D3.....	38
7E7.....	350
7E8.....	38
7E9.....	351
7E10.....	352
7T450.....	451
7T451.....	452
7Z53.....	354

21 – 60

21B37.....	423
21Y12.....	396
21Y14.....	66, 68, 395
21Y14=S.....	400
21Y15.....	396
21Y15=S.....	400
21Y21.....	66, 67, 68, 395
21Y21=B.....	399
21Y21=T.....	400
21Y41.....	401
21Y70.....	289
21Y77.....	402
21Y94.....	401
21Y95.....	401
21Y96.....	396
21Y97.....	397
21Y105.....	397
21Y123=40.....	401
21Y140.....	400
21Y222.....	67, 399
21Y226.....	404
21Y230.....	67, 399
60X5.....	145, 323, 329, 336, 344

61 – 90

88A20.....	113, 115, 140, 150, 153, 180, 133
88A32.....	198

91 – 100

99B13.....	402
99B14.....	486
99B14=HE.....	487
99B15.....	486
99B16.....	487
99B22.....	40
99B116.....	488
99B120.....	332, 340, 475

401 – 500

451F2.....	437
451F3.....	437
451F4.....	438
451F6.....	438
451F10.....	446
451F11.....	444
451F12.....	443
451F13.....	445
451F20.....	415, 439
451F21.....	439
451F24.....	435
451F25.....	435
451F26.....	436

451F27.....	436
451U1.....	439
452A1.....	422
453A2.....	418
453A3/453A4.....	419
453A30/453A40.....	420
453D2.....	441
453D4.....	440
453D5.....	441
453D7.....	440
453H1.....	416
453H10.....	393
453H12.....	393
453H14.....	393
453H30.....	394
454A7.....	421
454A8.....	421
454A11.....	422

501 – 600

501S41.....	31, 47, 49, 51, 53, 237, 251, 254
501S42.....	30
501S44.....	47, 236
501S71.....	49
501S74.....	254
501T24.....	61, 63, 245
501T48.....	49
501T61.....	49, 236
501Z2.....	33, 45, 218, 236, 245
501Z16.....	219, 225, 235
502Z22.....	50
506G3.....	33, 45, 50, 51, 59, 61, 63, 218, 224, 235, 236, 237, 246, 251, 263, 265, 270
506G21.....	65
506G21=M4X10.....	430
507U12.....	50
507U16.....	63, 246
513D83.....	305

601 – 700

616S132.....	442
616S134.....	442
627F13.....	67, 68
627F13=19X2.....	400
627F13=24.5X3.....	399
633F30.....	272
633F30=2.....	404
633S2.....	447
640F18.....	392
642C3.....	498
646M22.....	489
646M85.....	485
646M453.....	394
647X6.....	450
683G1.....	416

701 – 800

704G30.....	146
709H4.....	273
709H5.....	273
709H6.....	273
709H7.....	272
709H8.....	272
709H9.....	272
719S7.....	392
719S20.....	392

Reference number index

743A29.....	356
743R9.....	450
743R10/743R12.....	200, 484
743R13.....	450
743Y840.....	186
755E20.....	416
755Y68.....	90
756L10.....	392
757B38.....	185
757L16-4.....	145, 323, 329, 337, 345
757L38.....	185
757L39.....	185
757L43.....	323, 329, 337, 345
757P48.....	146
757S3.....	186

A - Z

SL=LR.....	197
SL=P071.....	26, 193
SL=P078.....	25, 26, 193
SL=SPECTRA-SOCK2-7.....	127, 135
SL=SPECTRA-SOCK-7.....	127, 139, 153, 167, 179, 184, 197

Customer Service

Europe

Ottobock HealthCare Deutschland GmbH
Max-Näder-Straße 15 · 37115 Duderstadt
T +49 5527 848-3411 · F +49 5527 848-1414
prothetik@ottobock.de · www.ottobock.de

Otto Bock Healthcare Products GmbH
Brehmstraße 16 · 1110 Wien
F +43 1 5267985
service-admin.vienna@ottobock.com · www.ottobock.at

Otto Bock Adria d.o.o. Sarajevo
Ramiza Salčina 85 · 71000 Sarajevo
T +38 7 33 255-405 · F +38 7 33 255-401
obadria@bih.net.ba · www.ottobockadria.com.ba

Otto Bock Bulgaria Ltd.
41 Tzar Boris III Blvd. · 1612 Sofia
T +35 9 2 80 57 980 · F +35 9 2 80 57 982
info@ottobock.bg · www.ottobock.bg

Otto Bock Suisse AG
Luzerner Kantonsspital 10 · 6000 Luzern 16
T +41 41 455 61 71 · F +41 41 455 61 70
suisse@ottobock.com · www.ottobock.ch

Otto Bock ČR s.r.o.
Protetická 460 · 33008 Zruč-Senec
T +42 377 825044 · F +42 377 825036
email@ottobock.cz · www.ottobock.cz

Otto Bock Iberica S.A.
C/Majada, 1 · 28760 Tres Cantos (Madrid)
T +34 91 8063000 · F +34 91 8060415
info@ottobock.es · www.ottobock.es

Otto Bock France
4 rue de la Réunion · CS 90011
91978 Courtaboeuf Cedex
T +33 1 69188830 · F +33 1 69071802
information@ottobock.fr · www.ottobock.fr

Otto Bock Healthcare plc
32, Parsonage Road · Englefield Green
Egham, Surrey TW20 0LD
T +44 1784 744900 · F +44 1784 744901
bockuk@ottobock.com · www.ottobock.co.uk

Otto Bock Hungária Kft.
Tatai út 74 · 1135 Budapest
T +36 1 4 5110 20 · F +36 1 4 5110 21
info@ottobock.hu · www.ottobock.hu

Otto Bock Adria d.o.o.
Dr. Franje Tuđmana 14 · 10431 Sveta Nedelja
T +38 5 1 3361 544 · F +38 5 1 3365 986
ottobockadria@ottobock.hr · www.ottobock.hr

Otto Bock Italia Srl Us
Via Filippo Turati 5/7 · 40054 Budrio (BO)
T +39 51 692-4711 · F +39 51 692-4720
italia@ottobock.com · www.ottobock.it

Otto Bock Benelux B.V.
Mandenmaker 14 · 5253 RC Nieuwkuijk
T +31 73 5186488 · F +31 73 5114960
info.benelux@ottobock.com · www.ottobock.nl

Industria Ortopédica Otto Bock Unip. Lda.
Av. Miguel Bombarda, 21 - 2º Esq. · 1050-161 Lisboa
T +35 1 21 3535587 · F +35 1 21 3535590
ottobockportugal@mail.telepac.pt

Otto Bock Polska Sp. z o. o.
Ulica Koralkowa 3 · 61-029 Poznań
T +48 61 6538250 · F +48 61 6538031
ottobock@ottobock.pl · www.ottobock.pl

Otto Bock Romania srl
Șos de Centura Chitila · Mogoșoaia Nr. 3
077405 Chitila, Jud. Ilfov
T +40 21 4363110 · F +40 21 4363023
info@ottobock.ro · www.ottobock.ro

OOO Otto Bock Service
p/o Pultikovo, Business Park „Greenwood“
Building 7, 69 km MKAD
143441 Moscow, Region/Krasnogorskiy Rayon
T +7 495 564 8360 · F +7 495 564 8363
info@ottobock.ru · www.ottobock.ru

Otto Bock Scandinavia AB
Barks Väg 7 · Box 4041 · 169 04 Solna
T +46 11 28 06 89
info@ottobock.se · www.ottobock.se

Otto Bock Slovakia s.r.o.
Röntgenova 26 · 851 01 Bratislava 5
T +42 1 2 32 78 20 70 · F +42 1 2 32 78 20 89
info@ottobock.sk · www.ottobock.sk

Otto Bock Sava d.o.o.
Industrijska bb · 34000 Kragujevac
T +38 1 34 351 671 · F +38 1 34 351 671
info@ottobock.rs · www.ottobock.rs

Otto Bock Ortopedi ve Rehabilitasyon Tekniği Ltd. Şti.
Mecidiyeköy Mah. Lati Lokum Sok.
Meriç Sitesi B Blok No: 30/B
34387 Mecidiyeköy-İstanbul
T +90 212 3565040 · F +90 212 3566688
info@ottobock.com.tr · www.ottobock.com.tr

Africa

Otto Bock Algérie E.U.R.L.
32, rue Ahcène Outaleb · Alger
Coopérative les Mimosas Mackle-Ben Aknoun · Alger
T +21 3 21 913863 · F +21 3 21 913863
information@ottobock.fr

Otto Bock Egypt S.A.E.
28 Soliman Abaza St. Mohandessein · Giza
T +20 2 37606818 · F +20 2 37605734
info@ottobock.com.eg

Otto Bock South Africa (Pty) Ltd
Building 3 Thornhill Office Park
94 Bekker Road Midrand · Johannesburg
T +27 11 564 9360
info-southafrica@ottobock.co.za · www.ottobock.co.za

Americas

Otto Bock Argentina S.A.
Av. Belgrano 1477
CP 1093 Ciudad Autónoma de Buenos Aires
T +54 11 5032-8201 · F +54 11 5032-8202
atencionclientes@ottobock.com.ar
www.ottobock.com.ar

Otto Bock do Brasil Tecnica Ortopédica Ltda.
Alameda Maria Tereza, 4036, Bairro Dois Córregos
CEP: 13.278-181 Valinhos-São Paulo
T +55 19 3729 3500 · F +55 19 3269 6061
ottobock@ottobock.com.br · www.ottobock.com.br

Otto Bock HealthCare Canada
5470 Harvester Road · Burlington, Ontario, L7L 5N5
T +1 289 288-4848 · F +1 289 288-4837
info-canada@ottobock.com · www.ottobock.ca

Sucursal Otto Bock Cuba
Centro de Negocios Miramar Edificio Jerusalem
Oficina 112 · Calle 3ra e/ 78 y 80. Playa · La Habana
T +53 72043069
hector.corcho@ottobock.com.br · www.ottobock.com.br

Otto Bock HealthCare Andina Ltda.
Calle 138 No 53-38 · Bogotá
T +57 1 8619988 · F +57 1 8619977
info@ottobock.com.co · www.ottobock.com.co

Otto Bock de Mexico S.A. de C.V.
Prolongación Calle 18 No. 178-ACol. San Pedro de los
Pinos · C.P. 01180 México
T +52 55 5575 0290 · F +52 55 5575 0234
info@ottobock.com.mx · www.ottobock.com.mx

Otto Bock HealthCare LP
11501 Alterra Parkway Suite 600 · Austin, TX 78758
T +1 800 328 4058 · F +1 800 655 4963
usa.customerservice@ottobockus.com
www.ottobockus.com

Asia Pacific

Otto Bock Australia Pty. Ltd.
Suite 1.01, Century Corporate Centre
62 Norwest Boulevard · Baulkham Hills NSW 2153
T +61 2 8818 2800 · F +61 2 8814 4500
healthcare@ottobock.com.au · www.ottobock.com.au

Beijing Otto Bock Orthopaedic Industries Co., Ltd.
B12E, Universal Business Park 10 Jiuxianqiao Road,
Chao Yang District · Beijing, 100015, P.R.
T +86 10 8598 6880 · F +86 10 8598 0040
news-service@ottobock.com.cn · www.ottobock.com.cn

Otto Bock Asia Pacific Ltd.
Unit 1004, 10/F, Greenfield Tower, Concordia Plaza 1
Science Museum Road, Tsim Sha Tsui
Kowloon, Hong Kong
T +85 2 2598 9772 · F +85 2 2598 7886
info@ottobock.com.hk · www.ottobock.com

Otto Bock HealthCare India Pvt. Ltd.
20th Floor, Express Towers · Nariman Point
Mumbai 400 021
T +91 22 2274 5500
information@indiottobock.com · www.ottobock.in

Otto Bock Japan K. K.
Yokogawa Building 8F, 4-4-44 Shibaura · Minato-ku,
Tokyo, 108-0023
T +81 3 3798-2111 · F +81 3 3798-2112
ottobock@ottobock.co.jp · www.ottobock.co.jp

Otto Bock Korea HealthCare Inc.
4F Agaworld Building · 1357-74, Seocho-dong
Seocho-ku, · 137-070 Seoul
T +82 2 577-3831 · F +82 2 577-3828
info@ottobockkorea.com · www.ottobockkorea.com

Otto Bock South East Asia Co., Ltd.
1741 Phaholyothin Road, Kwaeng Chatuchark, Khet
Chatuchark · Bangkok 10900
T +66 2 930 3030 · F +66 2 930 3311
obsea@ottobock.co.th · www.ottobock.co.th

Ottobock SE & Co. KGaA
Max-Näder-Straße 15 · 37115 Duderstadt
T +49 5527 848-1706 · F +49 5527 848-3360
info@ottobock.com · www.ottobock.com