



NeuroOrthopaedics. Product catalogue.

 This is a global catalogue. The product selection is exemplary and may vary depending on local conditions. If you have any questions, please get in touch with your local Ottobock contact.

Please visit www.ottobock.com to obtain up-to-date product information at any time.

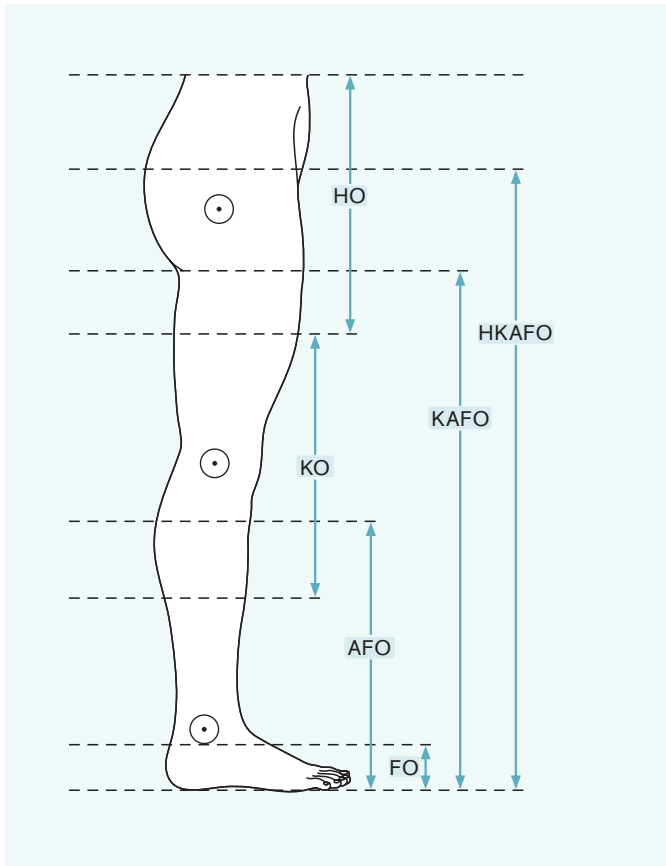



Table of contents.

- 1 | NeuroRehabilitation**
 - Lower limb 13
 - Upper limb 55
 - Full body fittings 62
- 2 | AFO**
 - Flexible ankle joints 76
 - Free motion ankle joints 77
 - Conventional orthotic joints 77
 - System joints 80
 - Ankle joints with dorsiflexion function 84
 - Conventional orthotic joints 84
 - System joints 88
 - Multifunction ankle joints 92
 - Conventional orthotic joints 92
 - System joints 93
 - Dynamic components 126
- 3 | KAFO/KO**
 - “SSCO” – Stance and Swing Phase Control Orthosis 134
 - Free-motion knee joints 150
 - Conventional orthotic joints 150
 - System joints 154
 - “SCO” – Stance Control Orthoses 174
 - Locked knee joints 190
 - Conventional orthotic joints 190
 - 4-in-1 option ring lock 190
 - Ring lock 192
 - Swiss lock 200
 - Covered Swiss lock 201
 - System joints 203
 - Ring lock 203
 - Wedge lock 205
 - Swiss lock 236
 - Covered Swiss lock 237
 - Waterproof walking aid 244
 - Bars for knee orthoses/lower limb prostheses 253
 - Prosthetic joint bars 262
- 4 | HKAFO/HO**
 - Cosa Junior/Cosa Active 276
 - RGO hip joint system 279
 - Free motion joints 282
 - Conventional orthotic joints 282
 - System joints 284
 - Locked hip joints 285
 - Conventional orthotic joints 285
- 5 | Bars/bar accessories**
 - Bilateral bars 292
 - Side bars 292
 - Lamination bars 299
 - Raw material 301
 - Unilateral bars 302
 - Side bars 302
 - Lamination bars 303
 - Bar accessories 304
 - Bending irons 304
 - Hole gauges 306
- 6 | Other**
 - Correction system joints 310
 - Arm bars 314
 - Scar compression 318
 - Models 322

General orthotics.



Global networking has also become important in the medical technology sector. In order to work with the same terminology internationally, the abbreviations of the English terms for the different types of orthoses are used.

These are already used in many countries in the corresponding fitting or device lists. Only the abbreviations common for the lower limbs are shown in the adjacent overview, but these are widely used for the entire locomotor system.

Lower limb orthosis types



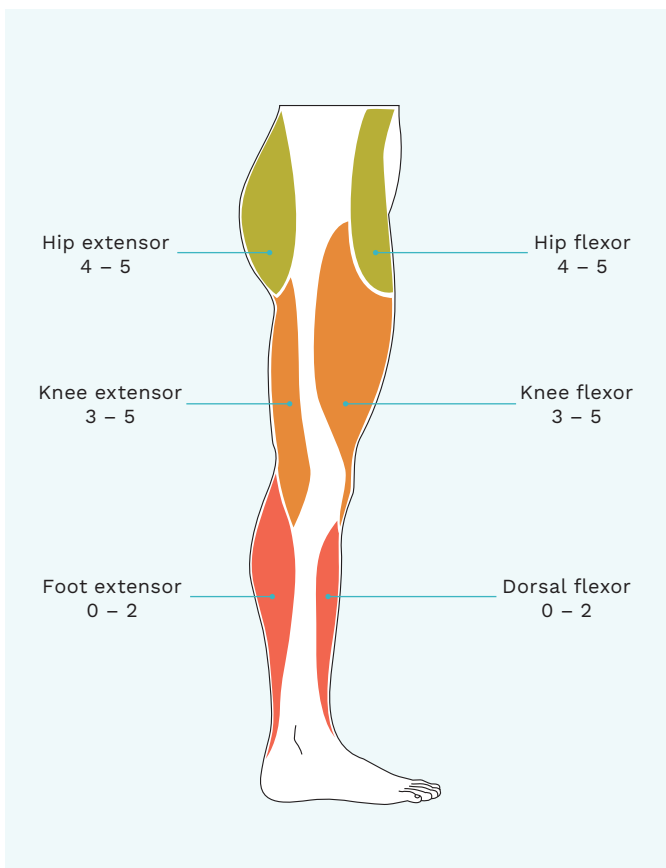





HO	Hip orthosis
HKAFO	Hip-knee-ankle-foot orthosis
KAFO	Knee-ankle-foot orthosis
KO	Knee orthosis
AFO	Ankle-foot orthosis
FO	Foot orthosis











Muscle strength assessment according to Janda

0	No visible and/or palpable muscle contraction
1	Visible and/or palpable muscle contraction with no motor effect
2	Pronounced muscle tension, movement is possible if force of gravity is eliminated
3	Movement against gravity possible
4	Movement against low to medium resistance possible
5	Movement with normal strength

Explanation of symbols.

	Products suitable for children
	Recommended for lamination resin technique
	Recommended for prepreg technique
	Recommended for bar/clamp technique
	Recommended for thermoplastic technique
	Alignment insert, size 1
	Alignment insert, size 2
	Alignment insert, size 3
	Alignment insert, size 4

	Alignment insert, size 5
	Alignment insert, size 6
	Alignment insert, size 7
	Alignment insert, size 8
	Alignment insert, size 9
	Self-adhesive
	Washable at 30 °C
	Washable at 40 °C
	Washable at 60 °C

Searching, finding and ordering.

ottobock.

2 Bilateral orthotic knee joint
17K210 Nexgear posterior knee

Left				Right			
Pc.	Article number	Size	V*	Pc.	Article number	Size	V*
	17K210-L-10-1	10	1		17K210-R-10-1	10	1
	17K210-L-10-2	10	2		17K210-R-10-2	10	2
	17K210-L-10-3	10	3		17K210-R-10-3	10	3
	17K210-L-10-4	10	4		17K210-R-10-4	10	4
	17K210-L-10-5	10	5		17K210-R-10-5	10	5
	17K210-L-10-6	10	6		17K210-R-10-6	10	6
	17K210-L-10-7	10	7		17K210-R-10-7	10	7
	17K210-L-10-8	10	8		17K210-R-10-8	10	8
	17K210-L-10-9	10	9		17K210-R-10-9	10	9
	17K210-L-10-10	10	10		17K210-R-10-10	10	10

***Variant**

Variant	1	2	3	4
Material	straight/straight	straight/contoured	contoured/straight	contoured/contoured

3 Bar
(C) 17S1000 laminar bar (D) 17S4000 side bar

Pc.	Material	Height	Width	Pc.	Material	Height	Width	Minimum
	Aluminum	100	100		Aluminum	100	100	100
	Aluminum	100	100		Aluminum	100	100	100
	Aluminum	100	100		Aluminum	100	100	100
	Aluminum	100	100		Aluminum	100	100	100

5 Orthotic ankle joint
17A2000 Nexgear Strap-in ankle

Pc.	Material	Height	Width	Pc.	Material	Height	Width
	Aluminum	100	100		Aluminum	100	100
	Aluminum	100	100		Aluminum	100	100
	Aluminum	100	100		Aluminum	100	100
	Aluminum	100	100		Aluminum	100	100

7 Extension wedge set
17K210 extension wedge set for 17K210

Pc.	Material	Height	Width	Pc.	Material	Height	Width
	Aluminum	100	100		Aluminum	100	100
	Aluminum	100	100		Aluminum	100	100
	Aluminum	100	100		Aluminum	100	100
	Aluminum	100	100		Aluminum	100	100

This catalogue is organised into sections.

Tabs on the right-hand page margins as well as the subtitles at the top of every page also serve as quick and easy reference guides.

ottobock.

2 Bilateral orthotic knee joint
17K210 Nexgear posterior knee

Titanium				Steel			
Pc.	Article number	Size	V*	Pc.	Article number	Size	V*
	17K210-L-10-1	10	1		17K210-R-10-1	10	1
	17K210-L-10-2	10	2		17K210-R-10-2	10	2
	17K210-L-10-3	10	3		17K210-R-10-3	10	3
	17K210-L-10-4	10	4		17K210-R-10-4	10	4
	17K210-L-10-5	10	5		17K210-R-10-5	10	5
	17K210-L-10-6	10	6		17K210-R-10-6	10	6
	17K210-L-10-7	10	7		17K210-R-10-7	10	7
	17K210-L-10-8	10	8		17K210-R-10-8	10	8
	17K210-L-10-9	10	9		17K210-R-10-9	10	9
	17K210-L-10-10	10	10		17K210-R-10-10	10	10

***Variant**

Variant	1	2	3	4
Material	straight/straight	straight/contoured	contoured/straight	contoured/contoured

The list of keywords lists all products in alphabetical order. Alternatively, the index lets you find the page numbers for products by reference number.

Index

3 Clamping kit 87 EKORUSSE Pans short 66
 Clamping sleeve 185, 276-277 EKORUSSE Pans unisex, short 66
 100-K70 model 292 Clinical telexastic equipment for professionals 51 Extension stop 241, 243-244, 246, 249
A Clinician programmer connection cable 18 208
 Clinician programmer charger 50 Clinician's programmer kit 50 Extension wedge set for 17K210 97
 adhesive pads for foot sensor 44, 49 EKORUSSE 61 Extension attachment plate 61
 Adjustable ankle joint 173 Clinician's programmer kit 50 Cylind cable anchor, large 99
 Adjustable strap 173

Index

100-499	501579	501580	501581	501582	501583	501584	501585	501586	501587	501588	501589	501590	501591	501592	501593	501594	501595	501596	501597	501598	501599																						
Aluminum threaded jaws	170	501579	170	501580	170	501581	170	501582	170	501583	170	501584	170	501585	170	501586	170	501587	170	501588	170	501589	170	501590	170	501591	170	501592	170	501593	170	501594	170	501595	170	501596	170	501597	170	501598	170	501599	170
Aluminum joint bar for children	170	501579	170	501580	170	501581	170	501582	170	501583	170	501584	170	501585	170	501586	170	501587	170	501588	170	501589	170	501590	170	501591	170	501592	170	501593	170	501594	170	501595	170	501596	170	501597	170	501598	170	501599	170
Aluminum joint bar, upper section	170	501579	170	501580	170	501581	170	501582	170	501583	170	501584	170	501585	170	501586	170	501587	170	501588	170	501589	170	501590	170	501591	170	501592	170	501593	170	501594	170	501595	170	501596	170	501597	170	501598	170	501599	170
Aluminum setting nut	170	501579	170	501580	170	501581	170	501582	170	501583	170	501584	170	501585	170	501586	170	501587	170	501588	170	501589	170	501590	170	501591	170	501592	170	501593	170	501594	170	501595	170	501596	170	501597	170	501598	170	501599	170
Aluminum spring	170	501579	170	501580	170	501581	170	501582	170	501583	170	501584	170	501585	170	501586	170	501587	170	501588	170	501589	170	501590	170	501591	170	501592	170	501593	170	501594	170	501595	170	501596	170	501597	170	501598	170	501599	170

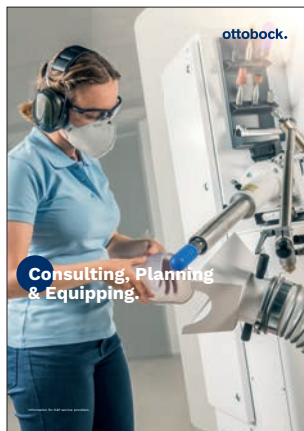

For more information or to place orders for products in the materials and tools category, please use the 646K1 Ottobock "Materials" catalogue.

You can find more on individual solutions for specialist orthopedic technology companies in the "Consulting, Planning and Equipping" catalogue (646K10).

Note: orthosis compendium
Detailed explanations of the underlying illnesses relevant for custom orthotics, the biomechanics of standing and walking and the orthosis designs corresponding to the clinical pictures are found in our orthosis compendium for the lower extremity.
Article-No. 646B7=EN_INT

Name of product

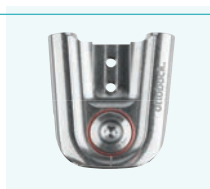

Illustration of product

17LA3N Unilateral system ankle joint

The 17LA3N unilateral ankle joint is a multifunction system ankle joint with a dorsiflexion effect.



Brief product description

Icons and symbols as orientation aids

Technical data

Article number	System width	Max. body weight	Material	Quantity unit
17LA3N=10	10 mm	15 kg (unilateral) / 25 kg (bilateral)	Steel	Piece
17LA3N=10-T	10 mm	15 kg (unilateral) / 25 kg (bilateral)	Titanium	Piece
17LA3N=12	12 mm	20 kg (unilateral) / 40 kg (bilateral)	Steel	Piece
17LA3N=12-T	12 mm	20 kg (unilateral) / 40 kg (bilateral)	Titanium	Piece
17LA3N=14	14 mm	50 kg (unilateral) / 80 kg (bilateral)	Steel	Piece
17LA3N=14-T	14 mm	50 kg (unilateral) / 80 kg (bilateral)	Titanium	Piece
17LA3N=16	16 mm	85 kg (unilateral) / 120 kg (bilateral)	Steel	Piece
17LA3N=16-T	16 mm	85 kg (unilateral) / 120 kg (bilateral)	Titanium	Piece
17LA3N=20	20 mm	110 kg (unilateral) / 160 kg (bilateral)	Steel	Piece
17LA3N=20-T	20 mm	110 kg (unilateral) / 160 kg (bilateral)	Titanium	Piece

When using the product unilaterally, the next higher size must be used in cases where there is flexion contracture in the knee or hip greater than 10°, or distinct torsion or valgus/varus instabilities, or increased physical activity.

Use the product bilaterally if there is any ischial support or valgus/varus malpositions greater than 10°

Technical data for the product

Spare parts for 17LA3N

Replacement parts graphic

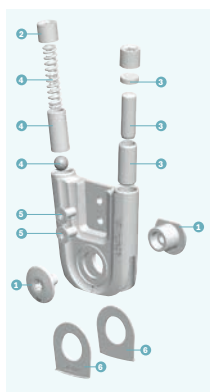

1) 17LA32N Spare part set screwing

Technical data

Article number	Spare part for	Quantity unit
17LA32N=10	17LA3N=10 17LA3N=10-T	Piece
17LA32N=12	17LA3N=12 17LA3N=12-T	Piece
17LA32N=14	17LA3N=14 17LA3N=14-T	Piece
17LA32N=16	17LA3N=16 17LA3N=16-T	Piece
17LA32N=20	17LA3N=20 17LA3N=20-T	Piece

2) 30Y309 Set screw

Technical data

Article number	Spare part for	Quantity unit
30Y309=12	17LA3N=12 17LA3N=14-T	Piece
30Y309=20	17LA3N=16 17LA3N=16-T 17LA3N=20 17LA3N=20-T	Piece

2) 30Y349 Set screw

Technical data

Article number	Spare part for	Quantity unit
30Y349=12	17LA3N=10 17LA3N=10-T 17LA3N=12 17LA3N=12-T	Piece

Product components which serve as spare parts for service and repair.

Please note that the basic colors listed in the catalogue do not necessarily match the actual color effect.



NeuroRehabilitation.

The frequency of neurological diseases has been increasing for years. According to an analysis by Deloitte, the specialist field of neurology will grow by 24.6% by 2030, which is the highest percentage growth in any medical specialist field (Deloitte 2016). The objective of NeuroRehabilitation is to avoid the resulting day-to-day limitations as far as possible through targeted measures, restore functions and thereby improve quality of life. However, improvements are not limited to a certain period of time but can be attained at virtually any time through treatments and applications. Devices can make a major contribution here. Lost and/or limited functions can be replaced, assisted or strengthened by devices. In the rehabilitation phase, a device can maintain and improve therapy results that have been achieved, support the patient's mobilisation or prevent early compensating movements on the part of the patient. In day-to-day life, devices help maintain rehabilitation results and promote the use of mobility that has been regained in specific situations. Ottobock offers numerous devices that have been developed especially for the particular needs of NeuroRehabilitation. This includes pre-fabricated, semi-finished products that are presented in this section. All components required for the fabrication of custom orthoses are also described in detail in this catalogue.

Differentiation within the product portfolio

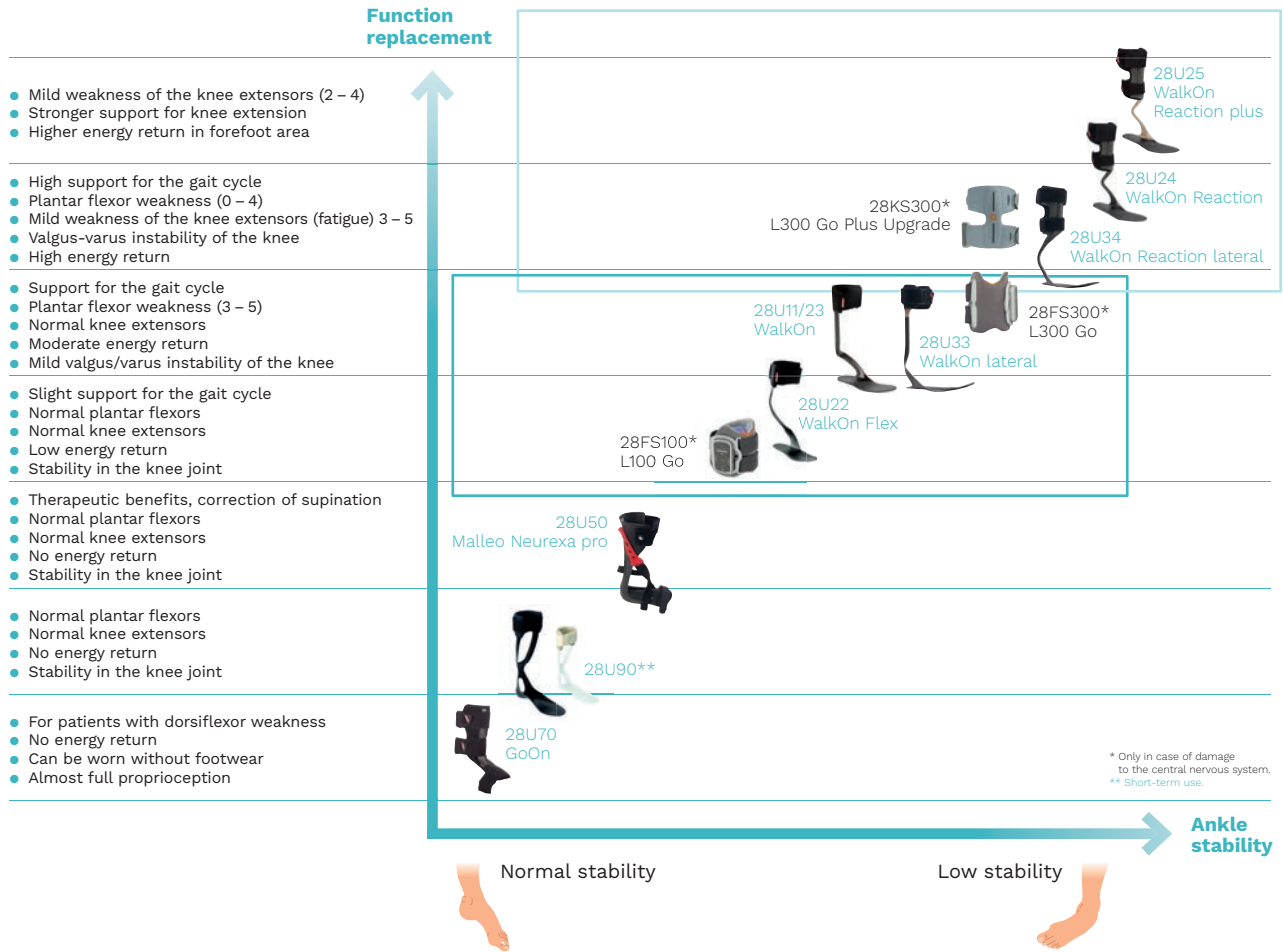



28U70 GoOn

The 28U70 GoOn is an ankle-foot orthosis for elevating the foot in the neutral position.

Features and benefits

- Easy handling and soft materials
 - High acceptance
- Easy to wash
 - Hygienic
- Universal size (adult size)
 - One size fits all users
- Spring elements made of individual filaments
 - Controlled lifting force, moderate guidance and torsion control of the foot
- Orthosis does not cover the heel and forefoot
 - High proprioception
- Dorsal spring construction
 - Can be worn with or without footwear, regardless of heel height. If the orthosis is worn without footwear, an additional hook-and-loop closure is required (included in the scope of delivery)
- Viscoelastic cushion
 - Minimised pressure on the top of the foot
- Front support attached directly to the foot
 - Very secure, firm fit

Indications

- Drop foot in case of:
 - Fatigue syndrome
 - Problems with balance
 - Dementia
 - Parkinson's disease
 - Stroke
 - Traumatic brain injury
 - Multiple sclerosis
 - Neural muscular atrophy
 - Peroneal paralysis (paresis)

Modes of action

- Light support for drop foot

Technical data

Article number	Size
28U70	Universal

Spare parts for 28U70



29U25 Y-hook-and-loop

Y-hook-and-loop closure for pad. Spare part for dynamic ankle-foot orthoses in the WalkOn product range, for 28U70 GoOn and for 17AT1/17AT2 test orthoses.

Technical data

Article number	Spare part for	Size	For belt width	Quantity unit
29U25=2	28U24 WalkOn Reaction 28U25 WalkOn Reaction plus 28U25 WalkOn Reaction junior 28U70 GoOn	2	45 mm	Piece



28U90 Ankle-foot orthosis

Ankle-foot orthosis for lifting the foot in neutral position.

Features and benefits

- Thin-walled design
 - Inconspicuous under clothing and in the shoe
- Long sole
 - Precise guidance of the foot, sole can be shortened as needed
- Low weight
 - No added strain
- Calf pad, easy to remove and washable
 - Good wearer comfort
- Pad with strap suitable for left-hand or right-hand use
 - Straightforward adaptation to the patient

Indications

- Drop foot in case of:
 - Peroneal paralysis (paresis)
 - Stroke
 - Traumatic brain injury
 - Multiple sclerosis
 - Neural muscular atrophy

Modes of action

- Passive, flexible limitation of plantar flexion
- Dynamically returns the foot to the neutral position

Technical data



Article number	Shoe size Europe	Side	Colour
28U90=L35-37-0	35 - 37	left (L)	Beige
28U90=R35-37-0	35 - 37	right (R)	Beige
28U90=L35-37-7	35 - 37	left (L)	Black
28U90=R35-37-7	35 - 37	right (R)	Black
28U90=L37-39-0	37 - 39	left (L)	Beige
28U90=R37-39-0	37 - 39	right (R)	Beige
28U90=L37-39-7	37 - 39	left (L)	Black
28U90=R37-39-7	37 - 39	right (R)	Black
28U90=L39-41-0	39 - 41	left (L)	Beige
28U90=R39-41-0	39 - 41	right (R)	Beige
28U90=L39-41-7	39 - 41	left (L)	Black
28U90=R39-41-7	39 - 41	right (R)	Black
28U90=L41-44-0	41 - 44	left (L)	Beige
28U90=R41-44-0	41 - 44	right (R)	Beige
28U90=L41-44-7	41 - 44	left (L)	Black
28U90=R41-44-7	41 - 44	right (R)	Black
28U90=L44-47-0	44 - 47	left (L)	Beige
28U90=R44-47-0	44 - 47	right (R)	Beige
28U90=L44-47-7	44 - 47	left (L)	Black
28U90=R44-47-7	44 - 47	right (R)	Black

Spare parts for 28U90



29U90 Calf pad with strap

Calf strap with closure for 28U90 ankle-foot orthosis

Technical data

Article number	Spare part for	Size	Colour
29U90=35-37-7	28U90=L35-37-7 28U90=R35-37-7	35 - 37	Black
29U90=35-37-9	28U90=L35-37-0 28U90=R35-37-0	35 - 37	Beige
29U90=37-39-7	28U90=L37-39-7 28U90=R37-39-7	37 - 39	Black
29U90=37-39-9	28U90=L37-39-0 28U90=R37-39-0	37 - 39	Beige
29U90=39-41-7	28U90=L39-41-7 28U90=R39-41-7	39 - 41	Black
29U90=39-41-9	28U90=L39-41-0 28U90=R39-41-0	39 - 41	Beige
29U90=41-44-7	28U90=L41-44-7 28U90=R41-44-7	41 - 44	Black
29U90=41-44-9	28U90=L41-44-0 28U90=R41-44-0	41 - 44	Beige
29U90=44-47-7	28U90=L44-47-7 28U90=R44-47-7	44 - 47	Black
29U90=44-47-9	28U90=L44-47-0 28U90=R44-47-0	44 - 47	Beige



28U50 Malleo Neurexa pro

Thermoplastic ankle-foot orthosis with dynamic pronation strap.

Features and benefits

- Dynamic pronation strap
 - Corrects supination
- Can be used as both a day or night splint
 - Prevents contractures
- Can be worn barefoot as well as with shoes
 - Flexible

Indications

- Drop foot without/with moderate supination of the foot due to spasticity in case of:
 - Stroke
 - Traumatic brain injury
 - Multiple sclerosis
 - Neural muscular atrophy
 - Isolated peroneal paralysis

Modes of action

- The special guidance of the closure straps with the combination of the elastic pronation strap ensures effective correction, even with acute hypertonicity of the lower leg musculature.
- Yields when spasticity occurs
- Returns the foot to the neutral position after relaxation

Technical data



Article number	Shoe size Europe	Side
28U50=L35-37	35 - 37	left (L)
28U50=R35-37	35 - 37	right (R)
28U50=L37-39	37 - 39	left (L)
28U50=R37-39	37 - 39	right (R)
28U50=L39-41	39 - 41	left (L)
28U50=R39-41	39 - 41	right (R)
28U50=L41-44	41 - 44	left (L)
28U50=R41-44	41 - 44	right (R)

Spare parts for 28U50



29S1 Hook-and-loop closure

Hook-and-loop closure for Malleo Neurexa pro and Dyna Ankle.

Technical data

Article number	Spare part for	Size	Side	Length
29S1=L35-37	50S1=L35-37 28U50=L35-37	35 - 37	left (L)	15.0 cm
29S1=R35-37	50S1=R35-37 28U50=R35-37	35 - 37	right (R)	15.0 cm
29S1=L37-39	50S1=L37-39 28U50=L37-39	37 - 39	left (L)	16.5 cm
29S1=R37-39	50S1=R37-39 28U50=R37-39	37 - 39	right (R)	16.5 cm
29S1=L39-41	50S1=L39-41 28U50=L39-41	39 - 41	left (L)	18.0 cm
29S1=R39-41	50S1=R39-41 28U50=R39-41	39 - 41	right (R)	18.0 cm
29S1=L41-44	50S1=L41-44 28U50=L41-44	41 - 44	left (L)	20.0 cm
29S1=R41-44	50S1=R41-44 28U50=R41-44	41 - 44	right (R)	20.0 cm



29S2 Strap piece

Strap piece for Malleo Neurexa pro and Dyna Ankle

Technical data

Article number	Spare part for	Size	Length
29S2=35-37	28U50 Malleo Neurexa pro 50S1 Dyna Ankle	35 - 37	29 cm
29S2=37-41	28U50 Malleo Neurexa pro 50S1 Dyna Ankle	37 - 41	33 cm
29S2=41-44	28U50 Malleo Neurexa pro 50S1 Dyna Ankle	41 - 44	37 cm

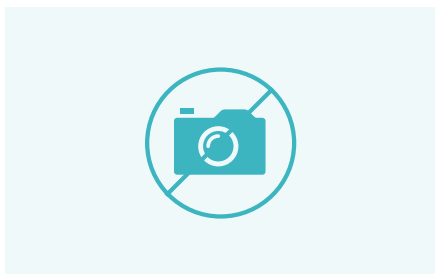

29S24 Calf pad

The calf pad is a spare part for the Malleo Neurexa pro.

Technical data

Article number	Size
29S24=35-39	35 - 39
29S24=39-44	39 - 44



29U34 Component set

The component set is a spare part for the 28U50 Malleo Neurexa pro.

Technical data

Article number
29U34

WalkOn Family. Selection Tool.

Muscle status according to Janda

- 0 No visible and/or palpable muscle contraction
- 1 Visible and/or palpable muscle contraction with no motor effect
- 2 Pronounced muscle tension, movement is possible when gravity is suspended
- 3 Movement against gravity is possible
- 4 Movement against low to medium resistance is possible
- 5 Movement with normal strength

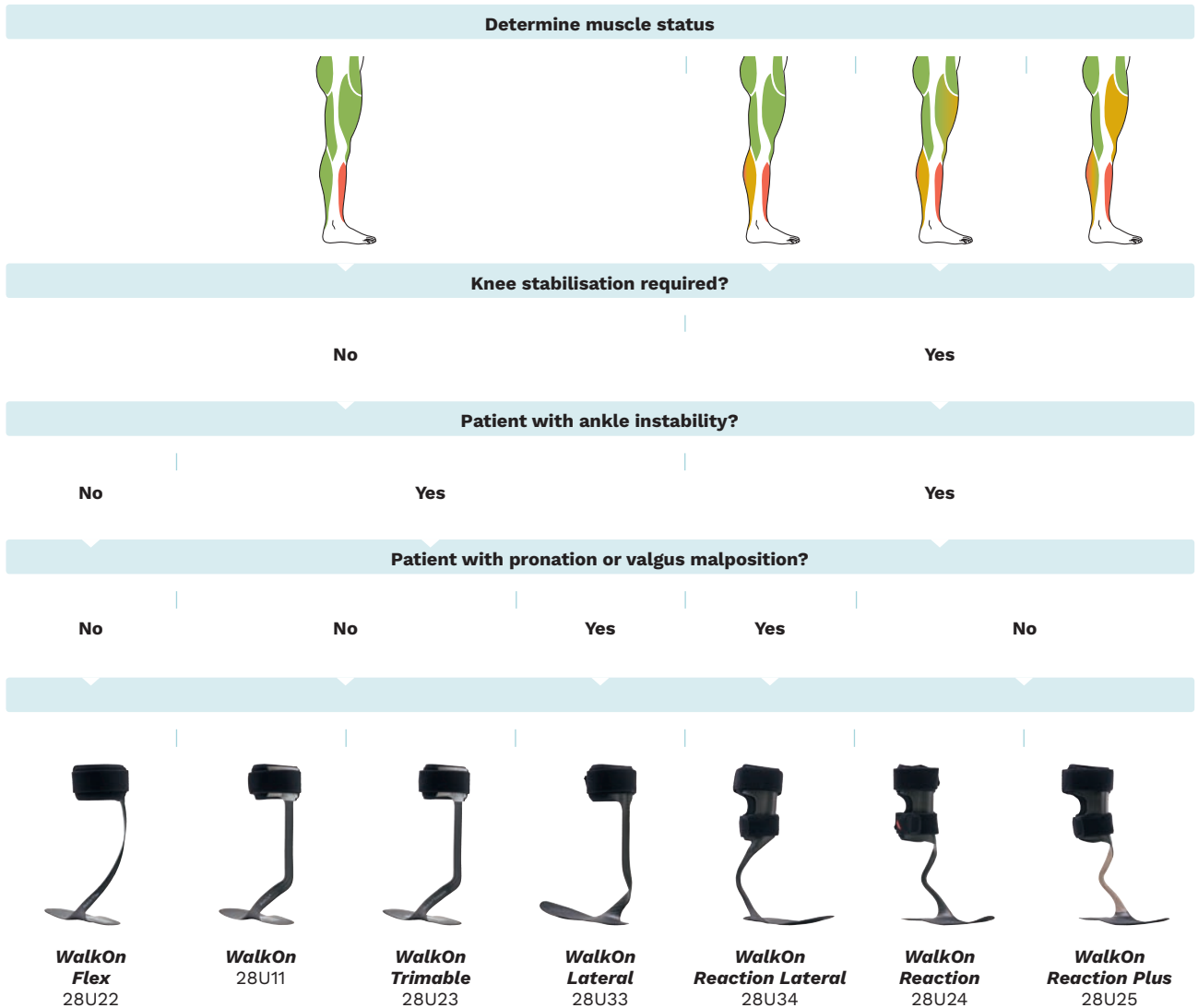



28U22 WalkOn Flex

Dynamic ankle-foot orthosis made of composite material, for lifting the foot and active energy return while walking.

Features and benefits

- Low weight
 - High acceptance
- Made of fibreglass prepreg
 - Easy energy storage and return during the gait cycle
- Medial guidance of the longitudinal arch by the pylon
 - Prevents supination in solid footwear
- Spiral-shaped spring to calf band
 - Greater flexibility at heel strike, natural external rotation of the foot, less stability during pronation and supination than WalkOn/WalkOn Trimable
- Slim design
 - Inconspicuous to wear
- Trimable sole
 - Straightforward adaptation
- Two comfortable calf bands
 - Skin-friendly padding, washable and replaceable

Indications

- Drop foot in case of:
 - Peroneal paralysis (paresis)
 - Stroke
 - Traumatic brain injury
 - Multiple sclerosis
 - Neural muscular atrophy

Modes of action

- Supports dorsiflexion
- Promotes dynamic rollover
- Increases the stride length by improving muscle dynamics
- Promotes external rotation of the foot at heel strike
- Promotes a physiological gait pattern
- Reduces the risk of falling



Technical data



Article number	Shoe size Europe	Side	Height
28U22=L24-27	24 - 27	left (L)	20.5 cm
28U22=R24-27	24 - 27	right (R)	20.5 cm
28U22=L27-30	27 - 30	left (L)	24 cm
28U22=R27-30	27 - 30	right (R)	24 cm
28U22=L30-33	30 - 33	left (L)	27 cm
28U22=R30-33	30 - 33	right (R)	27 cm
28U22=L33-36	33 - 36	left (L)	29.5 cm
28U22=R33-36	33 - 36	right (R)	29.5 cm
28U22=L36-39	36 - 39	left (L)	36 cm
28U22=R36-39	36 - 39	right (R)	36 cm
28U22=L39-42	39 - 42	left (L)	36 cm
28U22=R39-42	39 - 42	right (R)	36 cm
28U22=L42-45	42 - 45	left (L)	37 cm
28U22=R42-45	42 - 45	right (R)	37 cm
28U22=L45-48	45 - 48	left (L)	39 cm
28U22=R45-48	45 - 48	right (R)	39 cm

Spare parts for 28U22



29U39 Calf pad

Calf pad. Spare part.



Technical data

Article number	Spare part for	Side
29U39=24-30	28U22=L24-27 28U22=L27-30 28U22=R24-27 28U22=R27-30	both sides
29U39=30-36	28U22=L30-33 28U22=L33-36 28U22=R30-33 28U22=R33-36	both sides
29U39=36-42	28U22=L36-39 28U22=L39-42 28U22=R36-39 28U22=R39-42	both sides
29U39=42-48	28U22=L42-45 28U22=L45-48 28U22=R42-45 28U22=R45-48	both sides



29U25 Y-hook-and-loop

Y-hook-and-loop closure for pad. Spare part for dynamic ankle-foot orthoses in the WalkOn product range, for 28U70 GoOn and for 17AT1/17AT2 test orthoses.

Technical data

Article number	Size	For belt width	Quantity unit
29U25=1	1	58 mm	Piece
29U25=2	2	45 mm	Piece
29U25=3	3	35 mm	Piece

· Measure the belt width to select the appropriate closure size.

Accessory for 28U22



28Z10 Lateral pronation strap

A 28Z10 pronation strap can be used as an additional option to counteract spastic supination of the foot.

Technical data

Article number	Spare part/accessories for	Size
28Z10	28U11 28U22 28U23 28U24 28U25	36 - 48

· The lateral pronation strap is not part of the scope of delivery for 28U11, 28U22 and 28U23, but is included in the scope of delivery for 28U24 and 28U25.



28T2 WalkOn Flex FIT KIT

The WalkOn Flex FIT KIT can be used to test the function of the orthosis. It consists of four test orthoses including pads and a bag.

Technical data

Article number	Accessories for	Side	Shoe size Europe
28T2	28U22 WalkOn Flex	left (L), right (R)	36 - 48



28T9 WalkOn Flex Junior FIT KIT

The WalkOn Flex Junior FIT KIT can be used to test the function of the orthosis. It consists of eight interim orthoses including pads and bag.



Technical data

Article number	Accessories for	Side	Shoe size Europe
28T9	28U22 WalkOn Flex Junior	left (L), right (R)	24 - 36



28U11 WalkOn

Dynamic ankle-foot orthosis made of carbon, for lifting the foot and active energy return while walking.

Features and benefits

- Dorsal pylon/spring to calf band
 - Good control at heel strike and toe-off
- Low weight
 - High acceptance
- Made of carbon fibre prepreg
 - Energy is stored and returned during the gait cycle
- Medial guidance of the longitudinal arch by the pylon
 - Prevents supination in solid footwear
- Slim design
 - Inconspicuous to wear
- Two comfortable calf bands
 - Skin-friendly padding, washable and replaceable

Indications

- Drop foot in case of:
 - Peroneal paralysis (paresis)
 - Stroke
 - Traumatic brain injury
 - Multiple sclerosis
 - Neural muscular atrophy

Modes of action

- Supports dorsiflexion
- Promotes dynamic rollover
- Increases the stride length by improving muscle dynamics
- Promotes external rotation of the foot at heel strike
- Promotes a physiological gait pattern
- Reduces the risk of falling

Technical data



Article number	Shoe size Europe	Side	Height
28U11=L36-39	36 - 39	left (L)	36 cm
28U11=R36-39	36 - 39	right (R)	36 cm
28U11=L39-42	39 - 42	left (L)	36 cm
28U11=R39-42	39 - 42	right (R)	36 cm
28U11=L42-45	42 - 45	left (L)	37 cm
28U11=R42-45	42 - 45	right (R)	37 cm
28U11=L45-48	45 - 48	left (L)	39 cm
28U11=R45-48	45 - 48	right (R)	39 cm

Spare parts for 28U11



623Z39 Calf pad

Calf pad. Spare part.



Technical data

Article number	Spare part for	Side	Size
623Z39=L-N	28U11=L36-39 28U11=L39-42 28U11=L42-45 28U11=L45-48 28U23=L36-39 28U23=L39-42 28U23=L42-45 28U23=L45-48	left (L)	36 - 48
623Z39=R-N	28U11=R36-39 28U11=R39-42 28U11=R42-45 28U11=R45-48 28U23=R36-39 28U23=R39-42 28U23=R42-45 28U23=R45-48	right (R)	36 - 48

Accessory for 28U11



28Z10 Lateral pronation strap

A 28Z10 pronation strap can be used as an additional option to counteract spastic supination of the foot.

Technical data

Article number	Spare part/accessories for	Size
28Z10	28U11 28U22 28U23 28U24 28U25	36 - 48

· The lateral pronation strap is not part of the scope of delivery for 28U11, 28U22 and 28U23, but is included in the scope of delivery for 28U24 and 28U25.



28T1N WalkOn FIT KIT

The WalkOn FIT KIT can be used to test the function of the orthosis. It consists of four test orthoses including pads and bag. The FIT KIT can be used to test the function of both the 28U11 WalkOn and the 28U23 WalkOn Trimable, as the models differ only in terms of the processing of the sole (28U23 adaptation of the foot plate by trimming with scissors, 28U11 adaptation of the foot plate by sanding).

Technical data

Article number	Accessories for	Side	Shoe size Europe
28T1N	28U23 WalkOn Trimable 28U11 WalkOn	left (L), right (R)	36 - 48



28U23 WalkOn Trimable

Dynamic ankle-foot orthosis made of carbon, for lifting the foot and active energy return while walking.

Features and benefits

- Low weight
 - High acceptance
- Made of carbon fibre prepreg
 - Energy is stored and returned during the gait cycle
- Medial guidance of the longitudinal arch by the pylon
 - Prevents supination in solid footwear
- Slim design
 - Inconspicuous to wear
- Trimable sole
 - Straightforward adaptation
- Dorsal pylon/spring to calf band
 - Good control at heel strike and toe-off
- Two comfortable calf bands
 - Skin-friendly padding, washable and replaceable

Indications

- Drop foot in case of:
 - Peroneal paralysis (paresis)
 - Stroke
 - Traumatic brain injury
 - Multiple sclerosis
 - Neural muscular atrophy

Modes of action

- Supports dorsiflexion
- Promotes dynamic rollover
- Increases the stride length by improving muscle dynamics
- Promotes external rotation of the foot at heel strike
- Promotes a physiological gait pattern
- Reduces the risk of falling

Technical data



Article number	Shoe size Europe	Side	Height
28U23=L36-39	36 - 39	left (L)	36 cm
28U23=R36-39	36 - 39	right (R)	36 cm
28U23=L39-42	39 - 42	left (L)	36 cm
28U23=R39-42	39 - 42	right (R)	36 cm
28U23=L42-45	42 - 45	left (L)	37 cm
28U23=R42-45	42 - 45	right (R)	37 cm
28U23=L45-48	45 - 48	left (L)	39 cm
28U23=R45-48	45 - 48	right (R)	39 cm

Spare parts for 28U23



623Z39 Calf pad

Calf pad. Spare part.



Technical data

Article number	Spare part for	Side	Size
623Z39=L-N	28U11=L36-39	left (L)	36 - 48
	28U11=L39-42		
	28U11=L42-45		
	28U11=L45-48		
	28U23=L36-39		
	28U23=L39-42		
	28U23=L42-45		
623Z39=R-N	28U11=R36-39	right (R)	36 - 48
	28U11=R39-42		
	28U11=R42-45		
	28U11=R45-48		
	28U23=R36-39		
	28U23=R39-42		
	28U23=R42-45		
28U23=R45-48			

Accessory for 28U23



28Z10 Lateral pronation strap

A 28Z10 pronation strap can be used as an additional option to counteract spastic supination of the foot.

Technical data

Article number	Spare part/accessories for	Size
28Z10	28U11 28U22 28U23 28U24 28U25	36 - 48

· The lateral pronation strap is not part of the scope of delivery for 28U11, 28U22 and 28U23, but is included in the scope of delivery for 28U24 and 28U25.



28T1N WalkOn FIT KIT

The WalkOn FIT KIT can be used to test the function of the orthosis. It consists of four test orthoses including pads and bag. The FIT KIT can be used to test the function of both the 28U11 WalkOn and the 28U23 WalkOn Trimable, as the models differ only in terms of the processing of the sole (28U23 adaptation of the foot plate by trimming with scissors, 28U11 adaptation of the foot plate by sanding).

Technical data

Article number	Accessories for	Side	Shoe size Europe
28T1N	28U23 WalkOn Trimable 28U11 WalkOn	left (L), right (R)	36 - 48



28U33 WalkOn Lateral

Dynamic ankle-foot orthosis made of carbon with lateral guidance to elevate the foot and for active energy return while walking.

Features and benefits

- Effectively supports a physiological gait, even at different speeds and with different loads.
- High energy return of the orthosis
- Increases the stride length by improving muscle dynamics.
- Stabilises the ankle joint
- The orthosis permits forefoot loading for climbing stairs and squatting.
- Limits plantar flexion and supination when the orthosis is worn with a sturdy shoe.
- Easy to adjust thanks to a sole that can be trimmed to size
- Slim, lightweight design
- Optimised compliance thanks to a removable and washable pad/strap combination that can be aligned in the preferred direction for tightening the strap.
- The WalkOn lateral is available in adult and children's sizes (junior). The junior orthoses are delivered in a child-friendly dragon sports bag.
- For junior orthoses: the orthosis may be combined with other dynamic foot/ankle-foot orthoses (DAFOs) if the biomechanical requirements can be met more effectively as a result.

Indications

- Drop foot, with or without mild spasticity, e.g. caused by:
 - Peroneal paralysis (paresis)
 - Stroke
 - Multiple sclerosis
 - Neural muscular atrophy

Modes of action

- Supports dorsiflexion
- Promotes dynamic rollover
- Increases the stride length by improving muscle dynamics
- Promotes external rotation of the foot at heel strike
- Promotes a physiological gait pattern
- Reduces the risk of falling



Technical data

Article number	Shoe size Europe	Side	Height
28U33=L24-27	24 - 27	left (L)	20.5 cm
28U33=R24-27	24 - 27	right (R)	20.5 cm
28U33=L27-30	27 - 30	left (L)	24.0 cm
28U33=R27-30	27 - 30	right (R)	24.0 cm
28U33=L30-33	30 - 33	left (L)	27.0 cm
28U33=R30-33	30 - 33	right (R)	27.0 cm
28U33=L33-36	33 - 36	left (L)	29.5 cm
28U33=R33-36	33 - 36	right (R)	29.5 cm
28U33=L36-39	36 - 39	left (L)	32.5 cm
28U33=R36-39	36 - 39	right (R)	32.5 cm
28U33=L39-42	39 - 42	left (L)	35.0 cm
28U33=R39-42	39 - 42	right (R)	35.0 cm
28U33=L42-45	42 - 45	left (L)	37.0 cm
28U33=R42-45	42 - 45	right (R)	37.0 cm
28U33=L45-48	45 - 48	left (L)	39.0 cm
28U33=R45-48	45 - 48	right (R)	39.0 cm

Spare parts for 28U33



29U45 Calf pad

Calf pad. Spare part.



Technical data

Article number	Spare part for	Side	Size
29U45=24-30	28U33=L24-27 28U33=R24-27 28U33=L27-30 28U33=R27-30	both sides	24 - 30
29U45=30-36	28U33=L30-33 28U33=R30-33 28U33=L33-36 28U33=R33-36	both sides	30 - 36
29U45=36-48	28U33=L36-39 28U33=R36-39 28U33=L39-42 28U33=R39-42 28U33=L42-45 28U33=R42-45 28U33=L45-48 28U33=R45-48	both sides	36 - 48



29U25 Y-hook-and-loop

Y-hook-and-loop closure for pad. Spare part for dynamic ankle-foot orthoses in the WalkOn product range, for 28U70 GoOn and for 17AT1/17AT2 test orthoses.

Technical data

Article number	Size	For belt width	Quantity unit
29U25=1	1	58 mm	Piece
29U25=2	2	45 mm	Piece
29U25=3	3	35 mm	Piece

· Measure the belt width to select the appropriate closure size.

Accessory for 28U33



28T6 WalkOn Lateral FIT KIT

The WalkOn Lateral FIT KIT can be used to test the function of the orthosis. It consists of four test orthoses including pads and bag.

Technical data

Article number	Accessories for	Side	Shoe size Europe
28T6	28U33 WalkOn Lateral	left (L), right (R)	36 - 48



28T16 WalkOn Lateral Junior FIT KIT

The WalkOn Lateral Junior FIT KIT can be used to test the function of the orthosis. It consists of eight test orthoses including pads and bag.



Technical data

Article number	Accessories for	Side	Shoe size Europe
28T16	28U33 WalkOn Lateral Junior	left (L), right (R)	24 - 36



28U34 WalkOn Reaction lateral

Dynamic ankle-foot orthosis made of carbon with lateral guidance to elevate the foot and for active energy return while walking. A frontal support element provides light support for the knee joint.

Features and benefits

- The WalkOn Reaction lateral features highly dynamic properties and a high energy return.
- Stabilises the knee and ankle joint using ground reaction forces
- When standing, the alignment of the orthosis affects the statics in the frontal and sagittal plane.
- Easy to adjust thanks to a sole that can be trimmed to size
- Slim, lightweight design
- Optimised compliance thanks to removable and washable pad/strap combination.

Indications

- Drop foot without or with moderate spasticity
- Minor impairment of the foot lowering musculature and minor impairment of knee extension

Modes of action

- Promotes a largely symmetrical and fluid physiological gait with support for knee extension and flexion, depending on what is needed
- Its energy return supports toe-off and heel strike
- Prevents uncontrolled foot contact and foot slap at heel strike and supports knee extension during toe-off
- Influences the statics in the frontal and sagittal plane when standing due to the alignment of the orthosis



Technical data

Article number	Shoe size Europe	Side	Height
28U34=L24-27	24 - 27	left (L)	20.5 cm
28U34=R24-27	24 - 27	right (R)	20.5 cm
28U34=L27-30	27 - 30	left (L)	24.5 cm
28U34=R27-30	27 - 30	right (R)	24.5 cm
28U34=L30-33	30 - 33	left (L)	27.0 cm
28U34=R30-33	30 - 33	right (R)	27.0 cm
28U34=L33-36	33 - 36	left (L)	29.5 cm
28U34=R33-36	33 - 36	right (R)	29.5 cm
28U34=L36-39	36 - 39	left (L)	32.5 cm
28U34=R36-39	36 - 39	right (R)	32.5 cm
28U34=L39-42	39 - 42	left (L)	35.0 cm
28U34=R39-42	39 - 42	right (R)	35.0 cm
28U34=L42-45	42 - 45	left (L)	37.0 cm
28U34=R42-45	42 - 45	right (R)	37.0 cm
28U34=L45-48	45 - 48	left (L)	39.0 cm
28U34=R45-48	45 - 48	right (R)	39.0 cm

Spare parts for 28U34



29U46 Pad

Pad including hook-and-loop closures. Spare part.



Technical data

Article number	Spare part for	Side	Size
29U46=L24-27	28U34=L24-27	left (L)	24 - 27
29U46=R24-27	28U34=R24-27	right (R)	24 - 27
29U46=L27-30	28U34=L27-30	left (L)	27 - 30
29U46=R27-30	28U34=R27-30	right (R)	27 - 30
29U46=L30-33	28U34=L30-33	left (L)	30 - 33
29U46=R30-33	28U34=R30-33	right (R)	30 - 33
29U46=L33-36	28U34=L33-36	left (L)	33 - 36
29U46=R33-36	28U34=R33-36	right (R)	33 - 36
29U46=L36-39	28U34=L36-39	left (L)	36 - 39
29U46=R36-39	28U34=R36-39	right (R)	36 - 39
29U46=L39-42	28U34=L39-42	left (L)	39 - 42
29U46=R39-42	28U34=R39-42	right (R)	39 - 42
29U46=L42-45	28U34=L42-45	left (L)	42 - 45
29U46=R42-45	28U34=R42-45	right (R)	42 - 45
29U46=L45-48	28U34=L45-48	left (L)	45 - 48
29U46=R45-48	28U34=R45-48	right (R)	45 - 48



29U25 Y-hook-and-loop

Y-hook-and-loop closure for pad. Spare part for dynamic ankle-foot orthoses in the WalkOn product range, for 28U70 GoOn and for 17AT1/17AT2 test orthoses.

Technical data

Article number	Size	For belt width	Quantity unit
29U25=1	1	58 mm	Piece
29U25=2	2	45 mm	Piece
29U25=3	3	35 mm	Piece

· Measure the belt width to select the appropriate closure size.



29U22 Height adjustment part

Technical data

Article number	Side	Size
29U22	both sides	36 - 48
29U22=1	both sides	24 - 36



29U23 Shin pad

Technical data

Article number	Spare part for	Size
29U23	28U24 WalkOn Reaction 28U25 WalkOn Reaction plus 28U34 WalkOn Reaction lateral	36-48
29U23=1	28U25 WalkOn Reaction junior 28U34 WalkOn Reaction lateral	24-36

Accessory for 28U34



28T8 WalkOn Reaction Lateral FIT KIT

The WalkOn Reaction Lateral FIT KIT can be used to test the function of the orthosis. It consists of eight test orthoses including pads and bag.

Technical data

Article number	Accessories for	Side	Shoe size Europe
28T8	28U34 WalkOn Reaction Lateral	left (L), right (R)	36 - 48



28T7 WalkOn Reaction Lateral Junior FIT KIT

The WalkOn Reaction Lateral Junior FIT KIT can be used to test the function of the orthosis. It consists of eight test orthoses including pads and bag.



Technical data

Article number	Accessories for	Side	Shoe size Europe
28T7	28U34 WalkOn Reaction Lateral Junior	left (L), right (R)	24 - 36



28U24 WalkOn Reaction

Dynamic ankle-foot orthosis made of carbon, for lifting the foot with slight anterior support for the knee joint and for active energy return while walking.

Features and benefits

- Low weight
 - High acceptance
- Made of carbon fibre prepeg
 - Energy is stored and returned during the gait cycle
- Lateral pronation strap
 - In conjunction with the lateral pronation strap, it is possible to reduce varus deviation of the foot and ankle and supination of the forefoot. This should always be supported by a corrective insole (included in the scope of delivery).
- Shin pads with integrated closures
 - Skin-friendly padding, washable and replaceable
- Slim design
 - Inconspicuous to wear
- Anterior support
 - Good control at heel strike and toe-off
- Trimable sole
 - Straightforward adaptation

Indications

- Drop foot without or with moderate spasticity
- Minor impairment of the foot lowering musculature and minor impairment of knee extension

Modes of action

- Promotes a largely symmetrical and fluid physiological gait with support for knee extension and flexion, depending on what is needed
- Its energy return supports toe-off and heel strike
- Prevents uncontrolled foot contact and foot slap at heel strike and supports knee extension during toe-off
- Influences the statics in the frontal and sagittal plane when standing due to the alignment of the orthosis

Technical data



Article number	Shoe size Europe	Side	Height
28U24=L36-39	36 - 39	left (L)	33.3 cm
28U24=R36-39	36 - 39	right (R)	33.3 cm
28U24=L39-42	39 - 42	left (L)	35.5 cm
28U24=R39-42	39 - 42	right (R)	35.5 cm
28U24=L42-45	42 - 45	left (L)	37.7 cm
28U24=R42-45	42 - 45	right (R)	37.7 cm
28U24=L45-48	45 - 48	left (L)	40.0 cm
28U24=R45-48	45 - 48	right (R)	40.0 cm

Spare parts for 28U24



28Z10 Lateral pronation strap

A 28Z10 pronation strap can be used as an additional option to counteract spastic supination of the foot.

Technical data

Article number	Spare part/accessories for	Size
28Z10	28U11 28U22 28U23 28U24 28U25	36 - 48

- The lateral pronation strap is not part of the scope of delivery for 28U11, 28U22 and 28U23, but is included in the scope of delivery for 28U24 and 28U25.



29U23 Shin pad

Technical data

Article number	Spare part for	Size
29U23	28U24 WalkOn Reaction 28U25 WalkOn Reaction plus 28U34 WalkOn Reaction lateral	36 - 48
29U23=1	28U25 WalkOn Reaction junior 28U34 WalkOn Reaction lateral	24 - 36



29U24 Pad

Pad for 28U24 and 28U25 incl. hook-and-loop closures



Technical data

Article number	Spare part for	Side	Size
29U24=L36-39	28U25=L36-39 28U24=L36-39	left (L)	36 - 39
29U24=R36-39	28U25=R36-39 28U24=R36-39	right (R)	36 - 39
29U24=L39-42	28U25=L39-42 28U24=L39-42	left (L)	39 - 42
29U24=R39-42	28U25=R39-42 28U24=R39-42	right (R)	39 - 42
29U24=L42-45	28U25=L42-45 28U24=L42-45	left (L)	42 - 45
29U24=R42-45	28U25=R42-45 28U24=R42-45	right (R)	42 - 45
29U24=L45-48	28U25=L45-48 28U24=L45-48	left (L)	45 - 48
29U24=R45-48	28U25=R45-48 28U24=R45-48	right (R)	45 - 48



29U25 Y-hook-and-loop

Y-hook-and-loop closure for pad. Spare part for dynamic ankle-foot orthoses in the WalkOn product range, for 28U70 GoOn and for 17AT1/17AT2 test orthoses.

Technical data

Article number	Size	For belt width	Quantity unit
29U25=1	1	58 mm	Piece
29U25=2	2	45 mm	Piece
29U25=3	3	35 mm	Piece

· Measure the belt width to select the appropriate closure size.

Accessory for 28U24



28T3 WalkOn Reaction FIT KIT

A WalkOn Reaction FIT KIT can be used to test the function of the orthosis. This consists of eight test orthoses including pads and bags.

Technical data

Article number	Accessories for	Side	Shoe size Europe
28T3	28U24 WalkOn Reaction	left (L), right (R)	36 - 48



28U25 WalkOn Reaction plus

Dynamic ankle-foot orthosis made of carbon, for lifting the foot with anterior support for the knee joint and for active energy return while walking.

Features and benefits

- Dyneema-reinforced spring
 - Increases the resistance of the orthosis
- Low weight
 - Promotes high user acceptance
- Made of carbon fibre prepreg
 - Energy is stored and returned during the gait cycle
- Lateral pronation strap
 - In conjunction with the lateral pronation strap, it is possible to reduce varus deviation of the foot and ankle and supination of the forefoot. This should always be supported by a corrective insole (included in the scope of delivery).
- Shin pads with integrated closures
 - Skin-friendly padding, washable and replaceable
- Slim design
 - Discreet to wear
- Anterior support
 - Good control at heel strike and toe-off
- Trimable sole
 - Straightforward adaptation

Indications

- Drop foot, without or with mild to moderate spasticity
- Suitable in case of additional loss of the foot lowering musculature and/or slight to moderate weakness of the knee extensors (muscle strength level 3 according to Janda)
- Also suitable in case of foot deformities that can be corrected with the 28Z10 lateral pronation strap and insoles.

Modes of action

- Enables a largely physiological gait with higher stiffness than the familiar WalkOn Reaction. This means that even more effective support for knee extension and flexion can be provided thanks to the more powerful spring force
- Its energy return supports toe-off and heel strike
- Prevents uncontrolled foot contact and foot slap at heel strike and supports knee extension during toe-off
- Influences the statics in the frontal and sagittal plane when standing due to the alignment of the orthosis

Technical data



Article number	Shoe size Europe	Side	Height
28U25=L36-39	36 - 39	left (L)	33.3 cm
28U25=R36-39	36 - 39	right (R)	33.3 cm
28U25=L39-42	39 - 42	left (L)	35.5 cm
28U25=R39-42	39 - 42	right (R)	35.5 cm
28U25=L42-45	42 - 45	left (L)	37.7 cm
28U25=R42-45	42 - 45	right (R)	37.7 cm
28U25=L45-48	45 - 48	left (L)	40.0 cm
28U25=R45-48	45 - 48	right (R)	40.0 cm

Spare parts for 28U25



28Z10 Lateral pronation strap

A 28Z10 pronation strap can be used as an additional option to counteract spastic supination of the foot.

Technical data

Article number	Spare part/accessories for	Size
28Z10	28U11 28U22 28U23 28U24 28U25	36 - 48

- The lateral pronation strap is not part of the scope of delivery for 28U11, 28U22 and 28U23, but is included in the scope of delivery for 28U24 and 28U25.

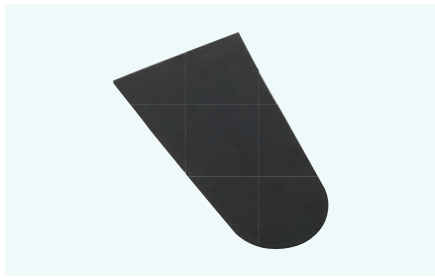

29U22 Height adjustment part

Technical data

Article number	Side	Size
29U22	both sides	36 - 48
29U22=1	both sides	24 - 36



29U23 Shin pad

Technical data

Article number	Spare part for	Size
29U23	28U24 WalkOn Reaction 28U25 WalkOn Reaction plus 28U34 WalkOn Reaction lateral	36 - 48



29U24 Pad

Pad for 28U24 and 28U25 incl. hook-and-loop closures



Technical data

Article number	Spare part for	Side	Size
29U24=L36-39	28U25=L36-39 28U24=L36-39	left (L)	36 - 39
29U24=R36-39	28U25=R36-39 28U24=R36-39	right (R)	36 - 39
29U24=L39-42	28U25=L39-42 28U24=L39-42	left (L)	39 - 42
29U24=R39-42	28U25=R39-42 28U24=R39-42	right (R)	39 - 42
29U24=L42-45	28U25=L42-45 28U24=L42-45	left (L)	42 - 45
29U24=R42-45	28U25=R42-45 28U24=R42-45	right (R)	42 - 45
29U24=L45-48	28U25=L45-48 28U24=L45-48	left (L)	45 - 48
29U24=R45-48	28U25=R45-48 28U24=R45-48	right (R)	45 - 48



29U25 Y-hook-and-loop

Y-hook-and-loop closure for pad. Spare part for dynamic ankle-foot orthoses in the WalkOn product range, for 28U70 GoOn and for 17AT1/17AT2 test orthoses.

Technical data

Article number	Size	For belt width	Quantity unit
29U25=1	1	58 mm	Piece
29U25=2	2	45 mm	Piece
29U25=3	3	35 mm	Piece

· Measure the belt width to select the appropriate closure size.

Accessory for 28U25



28T4 WalkOn Reaction plus FIT KIT

A WalkOn Reaction FIT KIT can be used to test the function of the orthosis. It consists of eight test orthoses including pads and a bag.

Technical data

Article number	Accessories for	Side	Shoe size Europe
28T4	28U25 WalkOn Reaction plus	left (L), right (R)	36 - 48



28U25 WalkOn Reaction junior

Dynamic ankle-foot orthosis made of carbon for children.

Features and benefits

- All fabric parts can be washed and replaced
 - Hygienic
- Low weight and open heel
 - High level of wearer comfort
- Highly dynamic characteristics
 - More control when walking
- Combination with additional dynamic ankle-foot orthoses (DAFOs) possible
 - Enhanced functions
- Open heel and anatomically designed frontal support element
 - No pressure points
- Shin pad
 - Better compliance

Indications

- Infantile cerebral palsy
- Drop foot, without or with mild to moderate spasticity
- Hemiparesis
- Diparesis

Modes of action

- Supports dorsiflexion
- Promotes dynamic rollover
- Increases the stride length by improving muscle dynamics
- Promotes external rotation of the foot at heel strike
- Promotes a physiological gait pattern
- Reduces the risk of falling



Technical data



Article number	Shoe size Europe	Side	Height
28U25=L24-27	24 - 27	left (L)	20.5 cm
28U25=R24-27	24 - 27	right (R)	20.5 cm
28U25=L27-30	27 - 30	left (L)	24.5 cm
28U25=R27-30	27 - 30	right (R)	24.5 cm
28U25=L30-33	30 - 33	left (L)	27.0 cm
28U25=R30-33	30 - 33	right (R)	27.0 cm
28U25=L33-36	33 - 36	left (L)	29.5 cm
28U25=R33-36	33 - 36	right (R)	29.5 cm

Spare parts for 28U25



29U22 Height adjustment part

Technical data

Article number	Side	Size
29U22	both sides	36 - 48
29U22=1	both sides	24 - 36



29U23 Shin pad

Technical data

Article number	Spare part for	Size
29U23	28U24 WalkOn Reaction 28U25 WalkOn Reaction plus 28U34 WalkOn Reaction lateral	36 - 48
29U23=1	28U25 WalkOn Reaction junior 28U34 WalkOn Reaction lateral	24 - 36



29U24 Pad

Y-hook-and-loop closure for pad. Spare part for dynamic ankle-foot orthoses in the WalkOn product range, for 28U70 GoOn and for 17AT1/17AT2 test orthoses.



Technical data

Article number	Spare part for	Side	Size
29U24=L24-27	28U25=L24-27	left (L)	24 - 27
29U24=R24-27	28U25=R24-27	right (R)	24 - 27
29U24=L27-30	28U25=L27-30	left (L)	27 - 30
29U24=R27-30	28U25=R27-30	right (R)	27 - 30
29U24=L30-33	28U25=L30-33	left (L)	30 - 33
29U24=R30-33	28U25=R30-33	right (R)	30 - 33
29U24=L33-36	28U25=L33-36	left (L)	33 - 36
29U24=R33-36	28U25=R33-36	right (R)	33 - 36



29U25 Y-hook-and-loop

Y-hook-and-loop closure for pad. Spare part for dynamic ankle-foot orthoses in the WalkOn product range, for 28U70 GoOn and for 17AT1/17AT2 test orthoses.

Technical data

Article number	Size	For belt width	Quantity unit
29U25=1	1	58 mm	Piece
29U25=2	2	45 mm	Piece
29U25=3	3	35 mm	Piece

· Measure the belt width to select the appropriate closure size.



28Z10 Lateral pronation strap

A 28Z10 pronation strap can be used as an additional option to counteract spastic supination of the foot.

Technical data

Article number	Spare part/accessories for	Size
28Z10=1	28U25 WalkOn Reaction junior	24 - 36

Accessory for 28U25



28T5 WalkOn Reaction junior FIT KIT

A WalkOn Reaction junior FIT KIT can be used to test the function of the orthosis. This consists of eight test orthoses including pads and bags.



Technical data

Article number	Accessories for	Side	Shoe size Europe
28T5	28U25 WalkOn Reaction junior	left (L), right (R)	24 - 36



28FS100 L100 Go System

The Bioness L100 Go was designed for users with drop foot and is based on the principle of functional electrical stimulation. Stimulation takes place via one channel. Ottobock is the exclusive distributor for Bioness.

Features and benefits

- User app for control and activity measurement
 - Easy handling
- 3D motion detection in real time
 - Reliable stimulation at the right time
- Easy to put on with one hand
 - Reliable application for the patient
- Electrode connections marked in colour
 - Reliable application for the technician/therapist and patient
- Textile electrodes for moistening
 - Easy handling and positioning
- Integrated 10 m walking test
 - Outcome and results can be analysed
- Intuitive fitting
 - Reliable application for the technician/therapist and patient

Indications

- Drop foot in case of:
 - Peroneal paralysis (paresis)
 - Stroke
 - Traumatic brain injury
 - Multiple sclerosis
 - Neural muscular atrophy

Modes of action

- An electrical stimulation impulse causes the dorsiflexion musculature to contract, lifting the foot during the swing phase

Technical data

Article number	Side	Lower leg circumference
28FS100=L	left (L)	29 - 51 cm
28FS100=R	right (R)	29 - 51 cm

- Certification is required for the Bioness L100 Go! Please contact your customer service representative or your regional contact person regarding this.

Spare parts for 28FS100



28FS100S L100 Go cuff

The cuff is a spare part for the L100 Go.

Technical data

Article number	Side
28FS100S=LG1-5X01	left (L)
28FS100S=LG1-5Y01	right (R)

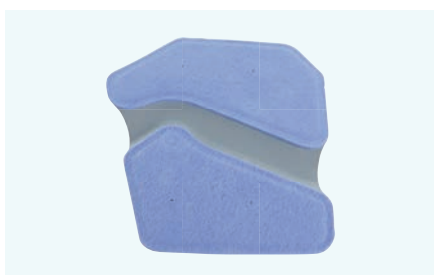

28FS300S Quick fit electrode

The quick fit electrode is used as a spare part for L300 Go and L100 Go.

Technical data

Article number	Side
28FS300S=LG4-1100	left (L)
28FS300S=LG4-1000	right (R)



28FS300S Round textile electrode

The round textile electrode is used as a spare part for the L300 Go and L100 Go.

Technical data

Article number	Size
28FS300S=LG3-6600	36 mm
28FS300S=LG3-4V00	45 mm



28FS300S Hydrogel electrode

The hydrogel electrode is used as a spare part for the L300 Go and L100 Go.

Technical data

Article number	Size
28FS300S=LG3-5F00	45 mm
28FS300S=LG3-6700	36 mm

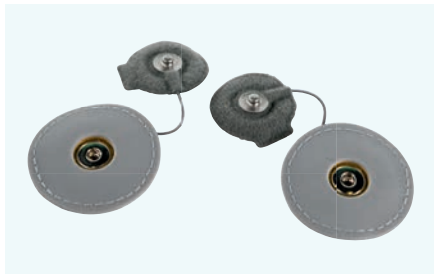

28FS300S=LG4-4U00 Textile electrode adapter set, 45 mm

The textile electrode adapter set is a spare part for the L300 Go and L100 Go.

Technical data

Article number
28FS300S=LG4-4U00



28FS300S=LG4-5E00 Hydrogel electrode adapter set, 45 mm

The hydrogel electrode adapter set is used as a spare part for the L300 Go and L100 Go.

Technical data

Article number
28FS300S=LG4-5E00



28FS300S=LG3-5L00 Cable cover (for adapter sets)

The cable cover for the adapter set is used as a spare part for the L300 Go and L100 Go.

Technical data

Article number
28FS300S=LG3-5L00



28FS300S=LG4-7100 **Magnetic charging cable**

The magnetic charging cable is used as a spare part for the L300 Go and L100 Go.

Technical data

Article number
28FS300S=LG4-7100



28FS300S=LG4-7200 **System charger with charging adapters**

The system charger with charging adapters is a spare part for the L300 Go and L100 Go.

Technical data

Article number
28FS300S=LG4-7200



28FS300S=LG4-5300 **Stimulator/EPG**

The stimulator/ EPG is a spare part for the L300 Go and L100 Go.

Technical data

Article number
28FS300S=LG4-5300



28FS300 L300 Go System

The Bioness L300 Go system is a multi-channel system. This version is a useful treatment option for users for whom adequate dorsiflexion is not possible with single-channel stimulation and who also have instability of the knee or weak thigh muscles. Ottobock is the exclusive distributor for Bioness.

Features and benefits

- User app for control and activity measurement
 - Remote control and heel switch are only required as an option
- 3D motion detection in real time
 - Reliable stimulation at the right time
- Easy to put on with one hand
 - Reliable application for the patient
- Electrode connections marked in colour
 - Safe and easy for patient to use
- Textile electrodes for moistening
 - Easy handling and positioning
- Integrated 10 m walking test
 - Outcome and results can be analysed
- Intuitive fitting
 - Reliable application for the technician/therapist and patient
- Thigh stimulator optionally available in two versions
 - Knee instabilities in the sagittal plane can be treated with or without the L300 Go
- Various electrode designs
 - Better results due to more precise stimulation

Indications

- Drop foot in case of:
 - Peroneal paralysis (paresis)
 - Stroke
 - Traumatic brain injury
 - Multiple sclerosis
 - Neural muscular atrophy

Modes of action

- An electrical stimulation impulse causes the dorsiflexion musculature to contract, lifting the foot during the swing phase

Technical data

Article number	Size	Side	Lower leg circumference
28FS300=L-S	S	left (L)	22 - 31 cm
28FS300=R-S	S	right (R)	22 - 31 cm
28FS300=L-L	L	left (L)	29 - 51 cm
28FS300=R-L	L	right (R)	29 - 51 cm

- Certification is required for the Bioness L300 Go! Please contact your customer service representative or your regional contact person regarding this.

Spare parts for 28FS300



28FS300S Lower leg cuff

The lower leg cuff is a spare part for the L300 Go.

Technical data

Article number	Side	Size
28FS300S=LG4-6200	left (L)	S
28FS300S=LG4-6100	right (R)	S
28FS300S=LG4-5800	left (L)	L
28FS300S=LG4-5700	right (R)	L

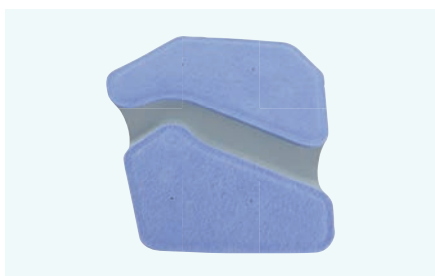

28FS300S Quick fit electrode

The quick fit electrode is used as a spare part for L300 Go and L100 Go.

Technical data

Article number	Side
28FS300S=LG4-1100	left (L)
28FS300S=LG4-1000	right (R)

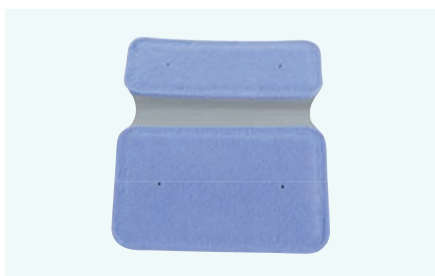

28FS300S Small quick fit electrode

The small Quick Fit electrode serves as a spare part for size S of the L300 Go.

Technical data

Article number	Description
28FS300S=LG3-6800	Small quick fit electrode A (standard)
28FS300S=LG3-6900	Small quick fit electrode B



28FS300S Steering electrode

The steering electrode is used as a spare part for the L300 Go.

Technical data

Article number	Side
28FS300S=SCE-1100	left (L)
28FS300S=SCE-1000	right (R)



28FS300S Round textile electrode

The round textile electrode is used as a spare part for the L300 Go and L100 Go.

Technical data

Article number	Size
28FS300S=LG3-6600	36 mm
28FS300S=LG3-4V00	45 mm



28FS300S Hydrogel electrode

The hydrogel electrode is used as a spare part for the L300 Go and L100 Go.

Technical data

Article number	Size
28FS300S=LG3-5F00	45 mm
28FS300S=LG3-6700	36 mm



28FS300S=LG4-5E00 Hydrogel electrode adapter set, 45 mm

The hydrogel electrode adapter set is used as a spare part for the L300 Go and L100 Go.

Technical data

Article number
28FS300S=LG4-5E00

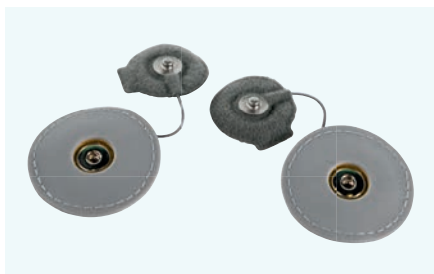

28FS300S=LG4-4U00 Textile electrode adapter set, 45 mm

The textile electrode adapter set is a spare part for the L300 Go and L100 Go.

Technical data

Article number
28FS300S=LG4-4U00



28FS300S=LG3-5L00 Cable cover (for adapter sets)

The cable cover for the adapter set is used as a spare part for the L300 Go and L100 Go.

Technical data

Article number
28FS300S=LG3-5L00



28FS300S=LG4-5300 Stimulator/EPG

The stimulator/ EPG is a spare part for the L300 Go and L100 Go.

Technical data

Article number
28FS300S=LG4-5300



28FS300S Lower leg FS strap

The lower leg strap is a used as a spare part for the L300 Go.

Technical data

Article number	Size
28FS300S=LG4-5S00	Universal
28FS300S=LG4-5900	S
28FS300S=LG4-5A00	M
28FS300S=LG4-5B00	L
28FS300S=LG4-6300	XS
28FS300S=LG4-6400	XXS



28FS300S=LG3-4A00 Strap cover, lower leg cuff

The strap covers for the lower leg cuff are accessories for the L100 Go and L300 Go.

Technical data

Article number	Package contents
28FS300S=LG3-4A00	20 piece(s)



28FS300S Inlays

The inlays are spare parts for the L300 Go and L100 Go.

Technical data

Article number	Size	Side
28FS300S=LG3-6A10	small	right (R)
28FS300S=LG3-6B10	small	left (L)
28FS300S=LG4-4R00	Standard	right (R)
28FS300S=LG4-4T00	Standard	left (L)

· The illustration shows the standard size.



28FS300S=LG4-7100 Magnetic charging cable

The magnetic charging cable is used as a spare part for the L300 Go and L100 Go.

Technical data

Article number
28FS300S=LG4-7100



28FS300S=20-0005 Carrying strap for remote control

The neck strap is used as a spare part for the remote control of the L300 Go.

Technical data

Article number
28FS300S=20-0005



28FS300S=LG4-7200 System charger with charging adapters

The system charger with charging adapters is a spare part for the L300 Go and L100 Go.

Technical data

Article number
28FS300S=LG4-7200

Accessory for 28FS300



28FS300A Foot sensor

The foot sensor is available in a standard and a long version, and serves as a spare part for the L300 Go.

Technical data

Article number	Size
28FS300A=LG4-5400	Standard
28FS300A=LG4-5500	Long



28FS300A=LG3-5K00 Adhesive pads for foot sensor

The adhesive pads for the foot sensor are a spare part for the L300 Go.

Technical data

Article number	Package contents
28FS300A=LG3-5K00	2 piece(s)



28FS300A=LG4-5200 Remote control

The remote control is an accessory for the L300 Go.

Technical data

Article number
28FS300A=LG4-5200



28FS300A-LG4-5201 Protective cover for remote control

The protective cover for the remote control serves as a spare part for the L300 Go.

Technical data

Article number
28FS300A=LG4-5201



28KS300 L300 Go System Plus Upgrade

The Bioness L300 Go Plus Upgrade is used in combination with the L300 Go and offers additional support for knee instability and weakness of the thigh muscles. Ottobock is the exclusive distributor for Bioness.

Features and benefits

- User app for control and activity measurement
 - Remote control and heel switch are only required as an option
- 3D motion detection in real time
 - Reliable stimulation at the right time
- Easy to put on with one hand
 - Reliable application for the patient
- Electrode connections marked in colour
 - Safe and easy for patient to use
- Textile electrodes for moistening
 - Easy handling and positioning
- Integrated 10 m walking test
 - Outcome and results can be analysed
- Intuitive fitting
 - Reliable application for the technician/therapist and patient
- Various electrode designs
 - Better results due to more precise stimulation

Indications

- Drop foot caused by
 - Stroke
 - Traumatic brain injury
 - Multiple sclerosis
 - Neural muscular atrophy

Modes of action

- An electrical stimulation impulse causes the knee-extending or knee-flexing musculature to contract, stabilising the knee

Technical data

Article number	Size	Side	Upper thigh circumference	Lower thigh circumference
28KS300=L-L	L	left (L)	53 - 85 cm	33 - 50 cm
28KS300=R-L	L	right (R)	53 - 85 cm	33 - 50 cm

· Certification is required for Bioness L300 Go System Plus Upgrade! Please contact your customer service representative or your regional contact person regarding this.

Spare parts for 28KS300



28KS300S Thigh cuff

The thigh cuff is used as a spare part for the L300 Go.

Technical data

Article number	Side
28KS300S=L4P-5400	left (L)
28KS300S=L4P-5500	right (R)



28KS300S=L3P-5D00 Textile electrode for thigh, offset

The offset textile electrodes are options for the L300 Go System Plus Upgrade and Stand Alone.

Technical data

Article number
28KS300S=L3P-5D00

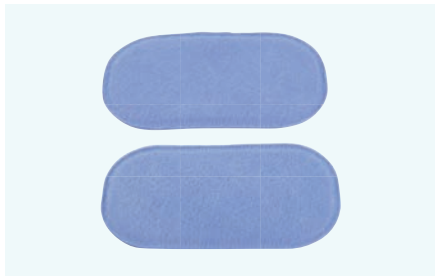

28KS300S=L4P-5D00 **Textile electrode for thigh, central**

The central textile electrode is an option for the L300 Go System Plus Upgrade and Stand Alone.

Technical data

Article number
28KS300S=L4P-5D00



28KS300S=L4P-4A00 **Strap cover, thigh cuff**

The strap covers for the thigh are used as spare parts for the L300 Go.

Technical data

Article number	Package contents
28KS300S=L4P-4A00	10 piece(s)



28KS300S=L4P-8200 **Strap holder for thigh cuff**

The strap holder for the thigh cuff is used as an option for the L300 Go System Plus Upgrade and Stand Alone.

Technical data

Article number
28KS300S=L4P-8200



28KS300S **Thigh strap incl. buckles**

The thigh strap set is used as a spare part for the L300 Go System Plus Upgrade and Stand Alone.

Technical data

Article number	Size
28KS300S=L4P-7000	small
28KS300S=L4P-7100	medium
28KS300S=L4P-7200	large



28KS300S=L4P-5300 **Stimulator/EPG, peripher**

The peripheral stimulator is a spare part for the 28KS300 L300 Go Upgrade system.

Technical data

Article number
28KS300S=L4P-5300



28FS300S=LG4-7100 **Magnetic charging cable**

The magnetic charging cable is used as a spare part for the L300 Go and L100 Go.

Technical data

Article number
28FS300S=LG4-7100



28KS310 L300 Go System Plus Stand Alone

The Bioness L300 Go System Plus Stand Alone consists of the thigh system. The system offers support for knee instability and weakness of the thigh muscles. Ottobock is the exclusive distributor for Bioness.

Features and benefits

- User app for control and activity measurement
 - Remote control and heel switch are only required as an option
- 3D motion detection in real time
 - Reliable stimulation at the right time
- Easy to put on with one hand
 - Reliable application for the patient
- Electrode connections marked in colour
 - Safe and easy for patient to use
- Textile electrodes for moistening
 - Easy handling and positioning
- Integrated 10 m walking test
 - Outcome and results can be analysed
- Intuitive fitting
 - Reliable application for the technician/therapist and patient
- Various electrode designs
 - Better results due to more precise stimulation

Indications

- Drop foot caused by
 - Stroke
 - Traumatic brain injury
 - Multiple sclerosis
 - Neural muscular atrophy

Modes of action

- An electrical stimulation impulse causes the knee-extending or knee-flexing musculature to contract, stabilising the knee

Technical data

Article number	Side
28KS310=L-L	left (L)
28KS310=R-L	right (R)

- Certification is required for Bioness L300 Go System Plus Stand Alone! Please contact your customer service representative or your regional contact person regarding this.

Spare parts for 28KS310



28KS300S Thigh cuff

The thigh cuff is used as a spare part for the L300 Go.

Technical data

Article number	Side
28KS300S=L4P-5400	left (L)
28KS300S=L4P-5500	right (R)

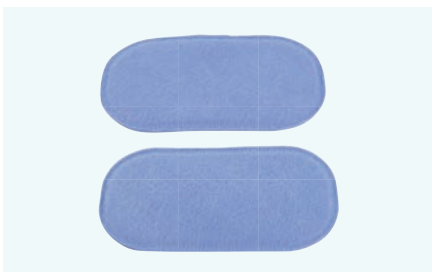

28KS300S=L3P-5D00 Textile electrode for thigh, offset

The offset textile electrodes are options for the L300 Go System Plus Upgrade and Stand Alone.

Technical data

Article number
28KS300S=L3P-5D00

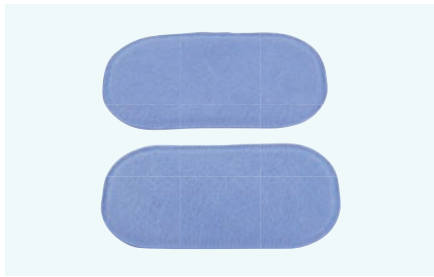

28KS300S=L4P-5D00 Textile electrode for thigh, central

The central textile electrode is an option for the L300 Go System Plus Upgrade and Stand Alone.

Technical data

Article number
28KS300S=L4P-5D00



28KS300S=L4P-4A00 Strap cover, thigh cuff

The strap covers for the thigh are used as spare parts for the L300 Go.

Technical data

Article number	Package contents
28KS300S=L4P-4A00	10 piece(s)

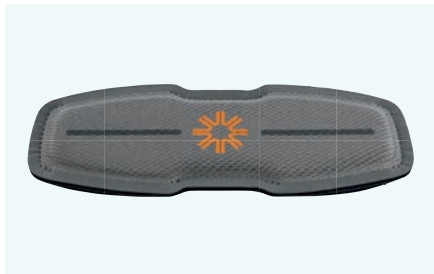

28KS300S=L4P-8200 Strap holder for thigh cuff

The strap holder for the thigh cuff is used as an option for the L300 Go System Plus Upgrade and Stand Alone.

Technical data

Article number
28KS300S=L4P-8200



28KS300S Thigh strap incl. buckles

The thigh strap set is used as a spare part for the L300 Go System Plus Upgrade and Stand Alone.

Technical data

Article number	Size
28KS300S=L4P-7000	small
28KS300S=L4P-7100	medium
28KS300S=L4P-7200	large



28FS300S=LG4-5300 Stimulator/EPG

The stimulator/ EPG is a spare part for the L300 Go and L100 Go.

Technical data

Article number
28FS300S=LG4-5300



28FS300S=LG4-7100 Magnetic charging cable

The magnetic charging cable is used as a spare part for the L300 Go and L100 Go.

Technical data

Article number
28FS300S=LG4-7100

Accessory for 28KS310



28FS300A **Foot sensor**

The foot sensor is available in a standard and a long version, and serves as a spare part for the L300 Go.

Technical data

Article number	Size
28FS300A=LG4-5400	Standard
28FS300A=LG4-5500	Long



28FS300A=LG3-5K00 **Adhesive pads for foot sensor**

The adhesive pads for the foot sensor are a spare part for the L300 Go.

Technical data

Article number	Package contents
28FS300A=LG3-5K00	2 piece(s)



28FS300=PROGRAMMER **Clinician's programmer kit**

The L300 Go clinician's programmer kit is used to carry out the individual L300 Go settings for the patient.

Technical data

Article number
28FS300=PROGRAMMER

Spare parts for 28FS300=PROGRAMMER



28FS300S=LG4-BT01 **Bluetooth dongle**

The Bluetooth dongle is used as a spare part for the L300 Go and L100 Go.

Technical data

Article number
28FS300S=LG4-BT01

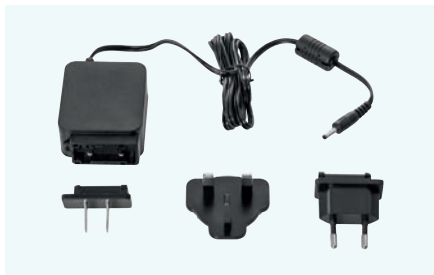

28PS200S=20-0014 **Clinician's programmer charger + adapter**

The charger and the adapter are spare parts for the clinician programmer.

Technical data

Article number
28PS200S=20-0014



28FS300=CLINICKIT **Clinical kit/basic equipment for professionals**

The clinical kit is used to identify patients for whom the L100 Go or L300 Go is a suitable fitting solution.

Technical data

Article number
28FS300=CLINICKIT

Spare parts for 28FS300=CLINICKIT



28FS300S=LG3-4900 **Fitting cable**

The fitting cable is a spare part for the L300 Go and L100 Go.

Technical data

Article number
28FS300S=LG3-4900

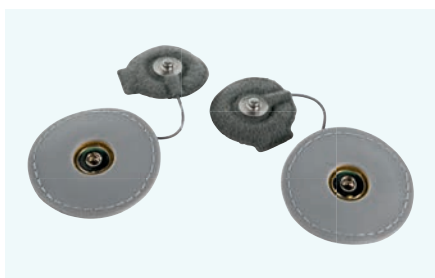

28FS300S=LG4-4U00 **Textile electrode adapter set, 45 mm**

The textile electrode adapter set is a spare part for the L300 Go and L100 Go.

Technical data

Article number
28FS300S=LG4-4U00



28FS300S=LG3-4A00 **Strap cover, lower leg cuff**

The strap covers for the lower leg cuff are accessories for the L100 Go and L300 Go.

Technical data

Article number	Package contents
28FS300S=LG3-4A00	20 piece(s)



28FS300S=LG4-5E00 **Hydrogel electrode adapter set, 45 mm**

The hydrogel electrode adapter set is used as a spare part for the L300 Go and L100 Go.

Technical data

Article number
28FS300S=LG4-5E00



28FS300S Inlays

The inlays are spare parts for the L300 Go and L100 Go.

Technical data

Article number	Size	Side
28FS300S=LG3-6A10	small	right (R)
28FS300S=LG3-6B10	small	left (L)
28FS300S=LG4-4R00	Standard	right (R)
28FS300S=LG4-4T00	Standard	left (L)

· The illustration shows the standard size.



28FS300S=LG3-5L00 Cable cover (for adapter sets)

The cable cover for the adapter set is used as a spare part for the L300 Go and L100 Go.

Technical data

Article number
28FS300S=LG3-5L00



28FS300S=LG3-6500 Small electrode adapter set, 36 mm

The small electrode adapter set is used as a spare part for the L300 Go and L100 Go.

Technical data

Article number
28FS300S=LG3-6500



28FS300S Small quick fit electrode

The small Quick Fit electrode serves as a spare part for size S of the L300 Go.

Technical data

Article number	Description
28FS300S=LG3-6800	Small quick fit electrode A (standard)
28FS300S=LG3-6900	Small quick fit electrode B

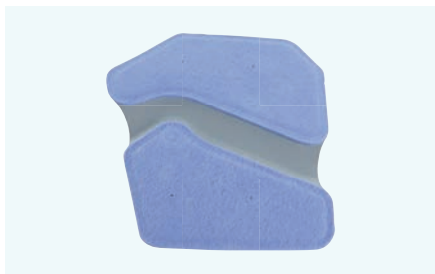

28FS300S Quick fit electrode

The quick fit electrode is used as a spare part for L300 Go and L100 Go.

Technical data

Article number	Side
28FS300S=LG4-1100	left (L)
28FS300S=LG4-1000	right (R)



28FS300S Round textile electrode

The round textile electrode is used as a spare part for the L300 Go and L100 Go.

Technical data

Article number	Size
28FS300S=LG3-6600	36 mm
28FS300S=LG3-4V00	45 mm

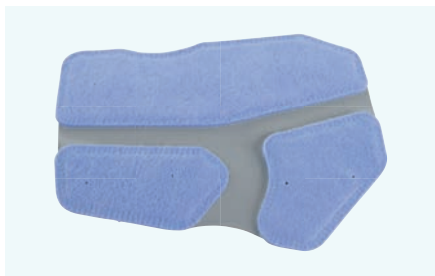

28FS300S Steering electrode

The steering electrode is used as a spare part for the L300 Go.

Technical data

Article number	Side
28FS300S=SCE-1100	left (L)
28FS300S=SCE-1000	right (R)



28FS300S=20-0004 Stimulation tester

The stimulation tester is a spare part for the L300 Go and L100 Go.

Technical data

Article number
28FS300S=20-0004



28KS300S Cover for thigh cuff

Cover as an option for the thigh cuff for the L300 Go Upgrade and Stand Alone

Technical data

Article number	Side
28KS300S=L4P-8100	left (L)
28KS300S=L4P-8000	right (R)



28KS300S=L3P-5D00 Textile electrode for thigh, offset

The offset textile electrodes are options for the L300 Go System Plus Upgrade and Stand Alone.

Technical data

Article number
28KS300S=L3P-5D00



28KS300S=L4P-4A00 Strap cover, thigh cuff

The strap covers for the thigh are used as spare parts for the L300 Go.

Technical data

Article number	Package contents
28KS300S=L4P-4A00	10 piece(s)



28KS300S=L4P-8200 Strap holder for thigh cuff

The strap holder for the thigh cuff is used as an option for the L300 Go System Plus Upgrade and Stand Alone.

Technical data

Article number
28KS300S=L4P-8200



8165 Genu Neurexa

Knee guiding orthosis for the prevention of hyperextension, primarily following a stroke.

Features and benefits

- Three-point principle, straps with guaranteed tensile strength, range of motion for splints can be limited, and/or continuously variable cross-strap against hyperextension
 - Counteracts hyperextension of the knee joint during the stance phase; hyperextension strap makes the brace suitable for gait training in therapy
- Orthotic bar joints adjustable in 10°/15° increments
 - Limits extension and flexion of the knee joint, resulting in pressure distribution, not limited to the hyperextension strap but can also be assumed by extension stops.
- Climate-regulating material
 - High acceptance and wearer comfort
- Front closure
 - Several alternatives for applying the brace
- Washable at 30 °C
 - Hygienic

Indications

- Paresis of leg muscles resulting in hyperextension of the knee following:
 - Stroke
 - Intervertebral disc prolapse in the lumbar spine
 - Peripheral nerve damage

Modes of action

- Supports and stabilises the knee joint
- Improves proprioception
- Supports sensorimotor function
- Prevents hyperextension
- Promotes the reduction of oedemas and haematomas
- Can relieve pain



Technical data

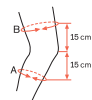

Article number	Size	Colour	Lower leg circumference A	Thigh circumference B
8165=XS-7	XS	Black	32 - 35	38 - 42
8165=S-7	S	Black	35 - 38	42 - 46
8165=M-7	M	Black	38 - 41	46 - 50
8165=L-7	L	Black	41 - 44	50 - 54
8165=XL-7	XL	Black	44 - 48	54 - 58

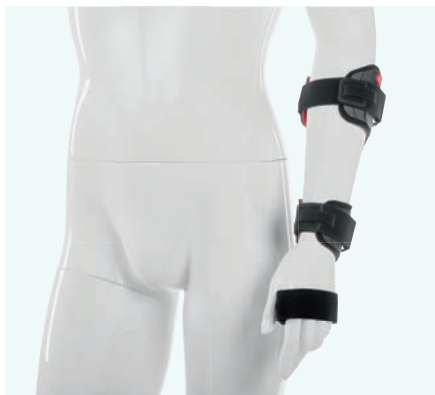

28P30 Manu Neurexa plus

Wrist stabilisation orthosis with adjustable wrist joint, can be combined with hand support rest and Omo Neurexa plus.

Features and benefits

- High-quality TriTech climate fabric
 - High level of wearer comfort
 - Flexible fitting
- Only one universal size and side
 - Easy to position and adapt
- Can be combined with the 28P31 hand support rest without using tools
 - Can also be worn as a positioning orthosis
- Can be combined with the 5065N=* Omo Neurexa plus without using tools
 - Improved effect

Indications

- Incomplete paralysis (paresis) of the forearm and hand musculature, for example due to hemiplegia following a stroke
- Intervertebral disc prolapse in the cervical spine
- Injury of the brachial plexus

Modes of action

- Relieves the wrist in a continuously variable functional position
- Limits the range of motion of the wrist in the palmar direction
- Holds the hand with either palmar or dorsal support
- Supports gripping ability
- Can prevent malpositions
- Suitable for overnight positioning in combination with the 28P31 hand support rest
- Increased effectiveness for repositioning of the shoulder in combination with the 5065N=* Omo Neurexa plus
- Can relieve pain

Technical data

Article number	Size
28P30	Universal

Accessory for 28P30

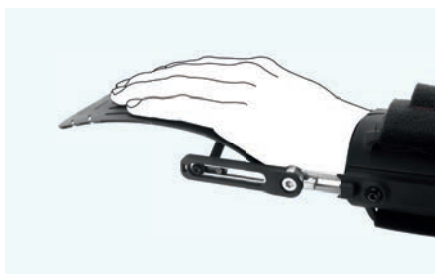

28P31 Hand support rest for the Manu Neurexa plus

The optional hand support rest provides support for the fingers and hand in addition to the fitting with the Manu Neurexa plus. Particularly intended for use during therapy or at night as a night positioning orthosis.

Technical data

Reference number	Size
28P31	Universal



29P32 Pad set for Manu Neurexa plus

Pad set for the Manu Neurexa plus

Technical data

Article number	Size
29P32	Universal

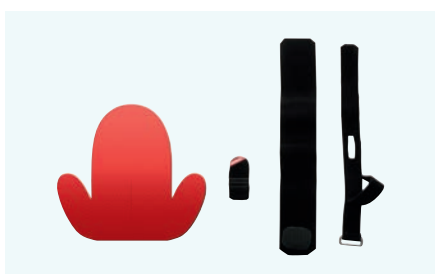

29P31 Pad set for hand support rest for 28P31

Pad set for the hand support rest for the Manu Neurexa plus

Technical data

Article number	Size
29P31	Universal



5065N Omo Neurexa plus

Shoulder orthosis, stabilises and relieves the paretic shoulder.

Features and benefits

- Special orthosis design
 - Can be put on independently with one hand
- TriTech climate-regulating material
 - High acceptance and wearer comfort
- Design permits re-alignment of the humeral head
 - Reduces pain; proven to improve gait pattern
- Machine washable at 40°
 - Hygienic
- Can be combined with the 28P30 Manu Neurexa plus without using tools
 - Improved effect
- Forearm and shoulder sections with silicone strips on the inside
 - Best possible positioning and firm fit, optimised transmission of tensile forces
- Various lengths of traction elements included in scope of delivery
 - Individual adaptation to various user heights

Indications

- Subluxation with neurological origin or painful restriction of movement in the shoulder and arm musculature, e.g. in case of:
 - Stroke
 - Intervertebral disc prolapse in the cervical spine
 - Injury of the brachial plexus
 - Peripheral nerve damage of the cervical spine

Modes of action

- Realigns the humeral head in the socket
- Improves body posture due to better sensorimotor control, resulting in a more physiological gait pattern
- Supports the arm position in extension with slight exterior rotation
- Reduces spasticity of the upper limbs
- Can relieve pain



Technical data



Article number	Size	Side	Colour	Chest circumference
5065N=L-XXS-7	XXS	left (L)	Black	73 - 78 cm
5065N=R-XXS-7	XXS	right (R)	Black	73 - 78 cm
5065N=L-XS-7	XS	left (L)	Black	79 - 86 cm
5065N=R-XS-7	XS	right (R)	Black	79 - 86 cm
5065N=L-S-7	S	left (L)	Black	87 - 94 cm
5065N=R-S-7	S	right (R)	Black	87 - 94 cm
5065N=L-M-7	M	left (L)	Black	95 - 102 cm
5065N=R-M-7	M	right (R)	Black	95 - 102 cm
5065N=L-L-7	L	left (L)	Black	103 - 110 cm
5065N=R-L-7	L	right (R)	Black	103 - 110 cm
5065N=L-XL-7	XL	left (L)	Black	111 - 118 cm
5065N=R-XL-7	XL	right (R)	Black	111 - 118 cm



28PS200 H200 Wireless

Based on functional electrical stimulation, the Bioness H200 Wireless can improve the hand's active range of motion and provide support for simple grasping movements in everyday life. Ottobock is the exclusive distributor for Bioness.

Features and benefits

- Easy one-hand operation
 - Independent use by the patient
- Remote control for selecting the stimulation program
 - Fast switching from functional hand mode to training mode
- Functional electrical stimulation of the hand
 - Improves and utilises hand function
- Regular training possible with training mode
 - Counteracts spasticity, rebuilds musculature
- Training mode
 - Expands active range of motion

Indications

- Stroke
- Brain injuries (craniocerebral trauma)
- Incomplete spinal cord injury
- Neurological disorders

Modes of action

- An electrical stimulation impulse causes the forearm musculature to contract, lifting or opening the hand

Technical data

Article number	Size	Side	A Wrist circumference (cm) distal to the ulnar styloid process	B Forearm circumference (cm) 8 cm distal from the lateral epicondyle	C Forearm length (cm) distal wrist fold to elbow fold
28PS200=L-S	S	left (L)	Approx. 14.5 - 20 cm	Approx. 17 - 20 cm	< 24 cm
28PS200=R-S	S	right (R)	Approx. 14.5 - 20 cm	Approx. 17 - 20 cm	< 24 cm
28PS200=L-M	M	left (L)	Approx. 14.5 - 20 cm	> 20 cm	< 24 cm
28PS200=R-M	M	right (R)	Approx. 14.5 - 20 cm	> 20 cm	< 24 cm
28PS200=L-L	L	left (L)	Approx. 17 - 25 cm	> 20 cm	> 24 cm
28PS200=R-L	L	right (R)	Approx. 17 - 25 cm	> 20 cm	> 24 cm

Spare parts for 28PS200



28PS200S H200 Wireless orthosis

The H200 Wireless orthosis is a spare part for the H200 Wireless.

Technical data

Article number	Size	Side
28PS200S=H2W-5700	S	left (L)
28PS200S=H2W-5800	S	right (R)
28PS200S=H2W-5900	M	left (L)
28PS200S=H2W-5A00	M	right (R)
28PS200S=H2W-5B00	L	left (L)
28PS200S=H2W-5C00	L	right (R)



28PS200S=H2W-5D00 H200 Wireless textile electrodes

Textile electrodes for the H200 Wireless

Technical data

Article number
28PS200S=H2W-5D00

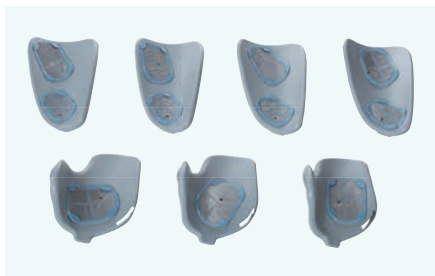

28PS200S Set of mounting plates

The set of mounting plates is a spare part for the H200 Wireless.

Technical data

Article number	Size	Side
28PS200S=HR2-4200	S/M	left (L)
28PS200S=HR2-4300	S/M	right (R)
28PS200S=HR2-4400	L	left (L)
28PS200S=HR2-4500	L	right (R)



28PS200S FPL panel

The electrode holder close to the wrist is a spare part for the H200 Wireless.

Technical data

Article number	Size	Side
28PS200S=H2W-6300	S/M	right (R)
28PS200S=H2W-6400	S/M	left (L)
28PS200S=H2W-6500	L	right (R)
28PS200S=H2W-6600	L	left (L)



28PS200S=HR2-5K00 Wrist loop

The wrist loop is a spare part for the H200 Wireless.

Technical data

Article number
28PS200S=HR2-5K00



28PS200S Wrist pad

Technical data

Article number	Size		Side
28PS200S=HR2-6J00	S/M	Thin	left (L)
28PS200S=HR2-6M00	S/M	Thin	right (R)
28PS200S=HR2-6H00	S/M	Medium	left (L)
28PS200S=HR2-6L00	S/M	Medium	right (R)
28PS200S=HR2-6G00	S/M	Thick	left (L)
28PS200S=HR2-6K00	S/M	Thick	right (R)
28PS200S=HR2-6600	L	Thin	left (L)
28PS200S=HR2-6900	L	Thin	right (R)
28PS200S=HR2-6500	L	Medium	left (L)
28PS200S=HR2-6800	L	Medium	right (R)
28PS200S=HR2-6400	L	Thick	left (L)
28PS200S=HR2-6700	L	Thick	right (R)

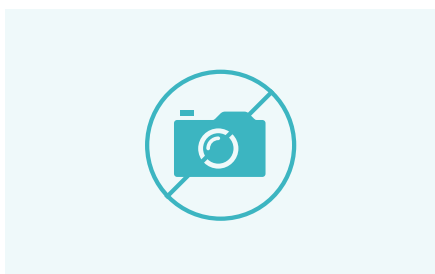

28PS200S Wrist pad covers

The wrist pad covers are spare parts for the H200 Wireless.

Technical data

Article number	Size
28PS200S=H2W-6A00	S/M
28PS200S=H2W-6B00	L



28PS200S Ball of thumb supports

The ball of thumb supports are spare parts for the H200 Wireless.

Technical data

Article number	Size		Side
28PS200S=HR2-6A00	S/M	medium	left (L)
28PS200S=HR2-6B00	S/M	large	left (L)
28PS200S=HR2-6C00	S/M	medium	right (R)
28PS200S=HR2-6D00	S/M	large	right (R)



28PS200S Screw for wrist pad

The screw for the wrist pad is a spare part for the H200 Wireless.

Technical data

Article number	Size
28PS200S=HR2-4A00	S/M
28PS200S=HR2-4B00	L



28PS200S=HR2-4C00 Screws for ball of thumb support

The screws for the ball of thumb support are a spare part for the H200 Wireless.

Technical data

Article number
28PS200S=HR2-4C00



28PS200S FPL panel screw

The FPL panel screw is a spare part for the H200 Wireless.

Technical data

Article number	Size
28PS200S=HR2-4900	S/M
28PS200S=HR2-4800	L



28PS200S Clinician programmer connection cable

Connection cable for H200 Wireless clinician programmer

Technical data

Article number
28PS200S=20-0013

Accessory for 28PS200



28PS200A=20-0007 **Belt pouch for remote control**

Belt pouch for the remote control of the H200 Wireless

Technical data

Article number

28PS200A=20-0007



28PS200A **Flexor attachment plate**

Flexor attachment plate for H200 Wireless

Technical data

Article number	Size	Side
28PS200A=HR2-7400	S/M	right (R)
28PS200A=HR2-7500	S/M	right (R)
28PS200A=HR2-7600	S/M	right (R)
28PS200A=HR2-7B00	S/M	left (L)
28PS200A=HR2-7C00	S/M	left (L)
28PS200A=HR2-7D00	S/M	left (L)
28PS200A=HR2-7J00	L	right (R)
28PS200A=HR2-7K00	L	right (R)
28PS200A=HR2-7L00	L	right (R)
28PS200A=HR2-7T00	L	left (L)
28PS200A=HR2-7U00	L	left (L)
28PS200A=HR2-7V00	L	left (L)



28PS200A=H2W-5600 **H200 Wireless remote control**

Remote control for the H200 Wireless

Technical data

Article number

28PS200A=H2W-5600



28PS200A=20-0005 **Carrying strap for remote control**

Neck strap for remote control for H200 Wireless

Technical data

Article number

28PS200A=20-0005



28PS200A=LG3-5H00 **Wrist loop for remote control**

Wrist loop for the remote control for the H200 Wireless

Technical data

Article number

28PS200A=LG3-5H00

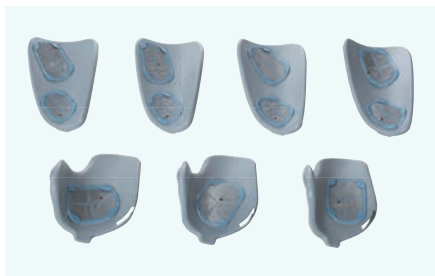

28PS200S Set of mounting plates

The set of mounting plates is a spare part for the H200 Wireless.

Technical data

Article number	Size	Side
28PS200S=HR2-4200	S/M	left (L)
28PS200S=HR2-4300	S/M	right (R)
28PS200S=HR2-4400	L	left (L)
28PS200S=HR2-4500	L	right (R)

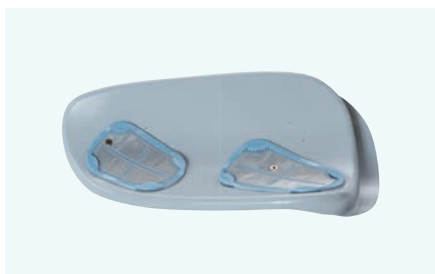

28PS200A Extensor attachment plate

The extensor attachment plate is a spare part for the H200 Wireless.

Technical data

Article number	Size	Side
28PS200A=HR2-7000	S/M	right (R)
28PS200A=HR2-7100	S/M	right (R)
28PS200A=HR2-7200	S/M	right (R)
28PS200A=HR2-7300	S/M	right (R)
28PS200A=HR2-7700	S/M	left (L)
28PS200A=HR2-7800	S/M	left (L)
28PS200A=HR2-7900	S/M	left (L)
28PS200A=HR2-7A00	S/M	right (R)
28PS200A=HR2-7E00	L	right (R)
28PS200A=HR2-7F00	L	right (R)
28PS200A=HR2-7G00	L	right (R)
28PS200A=HR2-7H00	L	right (R)
28PS200A=HR2-7M00	L	left (L)
28PS200A=HR2-7N00	L	left (L)
28PS200A=HR2-7P00	L	left (L)
28PS200A=HR2-7R00	L	right (R)

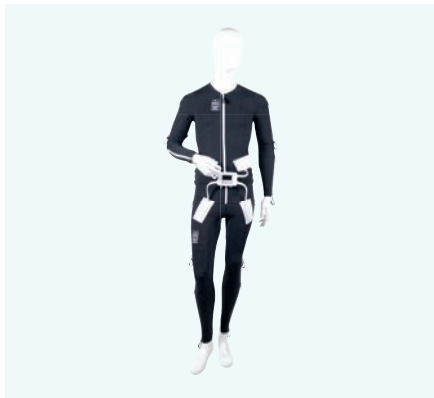

EXOPULSE Mollii Suit

The near full-body neuromodulation suit relaxing spastic and tense muscles, activating weak muscles, and relieving related pain: The Exopulse Mollii Suit fundamentally changes the treatment field of neurological disorders and related symptoms. It is a near full-body neuromodulation suit that makes use of a physiological reflex mechanism called reciprocal inhibition: By sending an electrical signal to an antagonistic muscle, the spastic muscle subsequently relaxes. The combined effect of relaxing tense muscles and enabling the activation of weak muscles allows its users to enjoy a more active and less painful daily life. It is a personal assistive medical device which is used for low-energy near full-body electrical stimulation, reducing the typical symptoms associated with neurological conditions such as cerebral palsy, multiple sclerosis, stroke and other neurological disorders with similar conditions.

Notification: The information contained in this document is only intended for an audience outside the United States. This product has not been listed, cleared, or approved by the FDA. Not all products and services are registered or available for sale in all countries.

- The Exopulse Mollii Suit requires certification! Please contact your customer service representative or your regional contact person.

Components for EXOPULSE Mollii Suit



28XP1 EXOPULSE Control unit

Control unit for the EXOPULSE Mollii Suit.

Technical data

Article number
28XP1=2

EXOPULSE Jackets



28XP2 EXOPULSE Jacket kids



Technical data

Article number	28XP2= 104	28XP2= 110	28XP2= 116	28XP2= 122	28XP2= 128	28XP2= 134	28XP2= 140	28XP2= 146	28XP2= 152
Size	104	110	116	122	128	134	140	146	152
Chest circumference	45,0 cm	47,0 cm	49,0 cm	50,0 cm	51,0 cm	53,0 cm	56,5 cm	60,0 cm	64,0 cm
Waist circumference	48,0 cm	49,5 cm	51,0 cm	52,0 cm	53,0 cm	54,5 cm	57,0 cm	60,0 cm	63,0 cm
Hip circumference	45,5 cm	47,5 cm	49,5 cm	51,5 cm	53,5 cm	55,5 cm	59,0 cm	63,0 cm	66,6 cm
Center back length	36,7 cm	38,1 cm	39,5 cm	40,9 cm	42,3 cm	43,7 cm	45,6 cm	47,5 cm	49,4 cm
Biceps circumference	22,0 cm	22,7 cm	23,4 cm	24,1 cm	24,8 cm	25,5 cm	26,3 cm	27,1 cm	27,9 cm
Wrist circumference	11,0 cm	11,5 cm	11,5 cm	12,0 cm	12,0 cm	12,0 cm	12,5 cm	12,5 cm	13,0 cm
Sleeve length	29,5 cm	31,5 cm	34,0 cm	36,0 cm	38,5 cm	40,5 cm	42,5 cm	44,6 cm	46,5 cm

Order example

Reference number	=	Size
28XP2	=	116



28XP4 EXOPULSE Jacket kids, wide



Technical data

Article number	28XP4=104	28XP4=110	28XP4=116	28XP4=122	28XP4=128	28XP4=134	28XP4=140	28XP4=146	28XP4=152
Size	104	110	116	122	128	134	140	146	152
Chest circumference	50,5 cm	52,5 cm	54,5 cm	55,5 cm	56,6 cm	58,5 cm	62,0 cm	65,5 cm	69,5 cm
Waist circumference	53,0 cm	54,5 cm	56,0 cm	57,0 cm	58,0 cm	59,5 cm	62,0 cm	65,0 cm	68,0 cm
Hip circumference	50,8 cm	52,8 cm	54,8 cm	56,8 cm	58,8 cm	60,8 cm	64,4 cm	68,0 cm	71,6 cm
Center back length	37,0 cm	38,4 cm	39,8 cm	41,2 cm	42,6 cm	44,0 cm	45,9 cm	47,8 cm	49,7 cm
Biceps circumference	23,2 cm	24,0 cm	24,8 cm	25,3 cm	25,9 cm	26,7 cm	28,2 cm	29,7 cm	31,2 cm
Wrist circumference	11,7 cm	11,9 cm	12,1 cm	12,3 cm	12,5 cm	12,8 cm	13,0 cm	13,2 cm	13,4 cm
Sleeve length	29,5 cm	31,5 cm	34,0 cm	36,0 cm	38,5 cm	40,5 cm	42,5 cm	44,5 cm	46,5 cm

Order example

Reference number	=	Size
28XP4	=	116

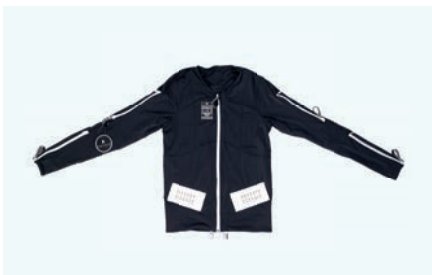

28XP6 EXOPULSE Jacket women

Technical data

Article number	28XP6=XS	28XP6=S	28XP6=M	28XP6=L	28XP6=XL	28XP6=XXL	28XP6=XXXL	28XP6=XXXXL	28XP6=XXXXXL
Size	XS	S	M	L	XL	XXL	XXXL	XXXXL	XXXXXL
Chest circumference	67,0 cm	73,0 cm	79,0 cm	85,6 cm	92,2 cm	98,8 cm	105,4 cm	112,0 cm	118,6 cm
Waist circumference	57,5 cm	63,5 cm	69,5 cm	76,1 cm	82,7 cm	89,3 cm	95,9 cm	102,5 cm	109,1 cm
Hip circumference	61,5 cm	67,5 cm	73,5 cm	80,1 cm	86,7 cm	93,3 cm	99,9 cm	106,5 cm	113,1 cm
Center back length	52,5 cm	54,5 cm	56,5 cm	58,5 cm	60,5 cm	62,5 cm	64,5 cm	65,5 cm	66,5 cm
Biceps circumference	30,0 cm	32,0 cm	34,0 cm	36,0 cm	38,0 cm	40,0 cm	41,0 cm	43,0 cm	45,0 cm
Wrist circumference	12,0 cm	13,0 cm	14,0 cm	14,5 cm	15,0 cm	16,0 cm	16,5 cm	17,0 cm	18,0 cm
Sleeve length	49,5 cm	52,0 cm	54,5 cm	57,0 cm	59,0 cm	61,0 cm	64,0 cm	65,0 cm	66,0 cm

Order example

Reference number	=	Size
28XP6	=	XL



28XP8 EXOPULSE Jacket men

Technical data

Article number	28XP8=XS	28XP8=S	28XP8=M	28XP8=L	28XP8=XL	28XP8=XXL	28XP8=XXXL	28XP8=XXXXL	28XP8=XXXXXL
Size	XS	S	M	L	XL	XXL	XXXL	XXXXL	XXXXXL
Chest circumference	73,0 cm	79,0 cm	85,0 cm	91,6 cm	98,2 cm	104,8 cm	111,4 cm	118,0 cm	124,6 cm
Waist circumference	63,5 cm	69,5 cm	75,5 cm	82,1 cm	88,7 cm	95,3 cm	101,9 cm	108,5 cm	115,1 cm
Hip circumference	65,0 cm	71,0 cm	77,0 cm	83,6 cm	90,2 cm	96,8 cm	103,4 cm	110,0 cm	116,6 cm
Center back length	55,5 cm	57,5 cm	59,5 cm	61,5 cm	63,5 cm	65,5 cm	67,5 cm	68,5 cm	69,5 cm
Biceps circumference	33,0 cm	35,0 cm	37,0 cm	39,0 cm	41,0 cm	43,0 cm	44,0 cm	46,0 cm	48,0 cm
Wrist circumference	13,0 cm	14,0 cm	15,0 cm	15,5 cm	16,0 cm	17,0 cm	17,5 cm	18,0 cm	19,0 cm
Sleeve length	52,2 cm	54,6 cm	57,0 cm	59,4 cm	61,8 cm	64,2 cm	66,6 cm	69,0 cm	71,4 cm

Order example

Reference number	=	Size
28XP8	=	XL



28XP10 EXOPULSE Jacket unisex, short

Technical data

Article number	28XP10=XL
Size	XL
Chest circumference	112,5 cm
Waist circumference	102,5 cm
Hip circumference	101,0 cm
Center back length	59,5 cm
Biceps circumference	44,0 cm
Wrist circumference	18,0 cm
Sleeve length	57,0 cm

EXOPULSE Pants

28XP3 EXOPULSE Pants kids

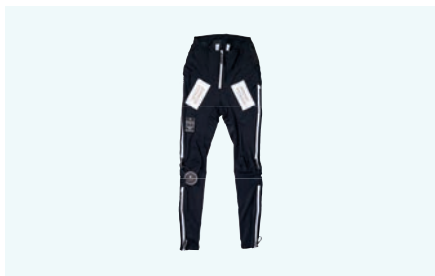

Technical data

Article number	28XP3=104	28XP3=110	28XP3=116	28XP3=122	28XP3=128	28XP3=134	28XP3=140	28XP3=146	28XP3=152
Size	104	110	116	122	128	134	140	146	152
Waist circumference	44,0 cm	45,5 cm	44,0 cm	45,0 cm	46,0 cm	47,0 cm	49,0 cm	51,5 cm	53,5 cm
Waist circumference (relaxed)	38,0 cm	40,5 cm	41,5 cm	42,5 cm	43,5 cm	44,5 cm	46,5 cm	49,0 cm	51,0 cm
Hip circumference	44,0 cm	46,0 cm	48,0 cm	49,5 cm	51,5 cm	53,0 cm	56,5 cm	59,5 cm	62,5 cm
Knee circumference	18,0 cm	18,8 cm	19,6 cm	20,4 cm	21,2 cm	22,0 cm	22,8 cm	23,6 cm	24,4 cm
Ankle circumference	15,0 cm	16,0 cm	17,0 cm	17,5 cm	18,5 cm	19,0 cm	20,0 cm	20,5 cm	21,5 cm
Inseam length	28,0 cm	30,0 cm	28,0 cm	30,0 cm	31,0 cm	33,0 cm	35,0 cm	37,0 cm	39,0 cm

Order example

Reference number	=	Size
28XP3	=	128



28XP5 EXOPULSE Pants kids, wide



Technical data

Article number	28XP5=104	28XP5=110	28XP5=116	28XP5=122	28XP5=128	28XP5=134	28XP5=140	28XP5=146	28XP5=152
Size	104	110	116	122	128	134	140	146	152
Waist circumference	47,7 cm	49,2 cm	47,7 cm	48,7 cm	49,7 cm	50,7 cm	52,7 cm	55,2 cm	57,2 cm
Waist circumference (relaxed)	41,7 cm	44,2 cm	45,2 cm	46,2 cm	47,2 cm	48,2 cm	50,2 cm	52,7 cm	54,7 cm
Hip circumference	48,5 cm	50,5 cm	52,5 cm	54,0 cm	56,0 cm	57,5 cm	61,0 cm	64,0 cm	67,0 cm
Knee circumference	19,6 cm	20,4 cm	21,2 cm	22,0 cm	22,8 cm	23,6 cm	24,4 cm	25,2 cm	26,0 cm
Ankle circumference	16,9 cm	17,7 cm	18,5 cm	19,3 cm	20,1 cm	20,9 cm	21,7 cm	22,5 cm	23,3 cm
Inseam length	28,0 cm	30,0 cm	28,0 cm	30,0 cm	31,0 cm	33,0 cm	35,0 cm	37,0 cm	39,0 cm

Order example

Reference number	=	Size
28XP5	=	128



28XP7 EXOPULSE Pants women

Technical data

Article number	28XP7=XS	28XP7=S	28XP7=M	28XP7=L	28XP7=XL	28XP7=XXL	28XP7=XXXL	28XP7=XXXXL	28XP7=XXXXXL
Size	XS	S	M	L	XL	XXL	XXXL	XXXXL	XXXXXL
Waist circumference	49,0 cm	55,0 cm	61,0 cm	67,0 cm	73,0 cm	79,0 cm	85,0 cm	91,0 cm	97,0 cm
Waist circumference (relaxed)	46,0 cm	52,0 cm	58,0 cm	64,0 cm	70,0 cm	76,0 cm	82,0 cm	88,0 cm	94,0 cm
Hip circumference	65,0 cm	71,0 cm	77,0 cm	83,0 cm	89,0 cm	95,0 cm	102,0 cm	108,0 cm	114,0 cm
Knee circumference	23,2 cm	24,8 cm	26,4 cm	28,0 cm	29,9 cm	31,8 cm	33,7 cm	35,3 cm	36,9 cm
Ankle circumference	15,5 cm	16,5 cm	17,5 cm	18,5 cm	19,5 cm	20,5 cm	21,5 cm	22,5 cm	23,5 cm
Inseam length	62,0 cm	64,0 cm	65,5 cm	68,0 cm	69,0 cm	71,0 cm	73,0 cm	74,0 cm	75,0 cm

Order example

Reference number	=	Size
28XP7	=	XL



28XP9 EXOPULSE Pants men

Technical data

Article number	28XP9= XS	28XP9= S	28XP9= M	28XP9= L	28XP9= XL	28XP9= XXL	28XP9= XXXL	28XP9= XXXXL	28XP9= XXXXXL
Size	XS	S	M	L	XL	XXL	XXXL	XXXXL	XXXXXL
Waist circumference	56,0 cm	62,0 cm	68,0 cm	74,0 cm	80,0 cm	86,0 cm	92,0 cm	98,0 cm	104,0 cm
Waist circumference (relaxed)	53,0 cm	59,0 cm	65,0 cm	71,0 cm	77,0 cm	83,0 cm	89,0 cm	95,0 cm	101,0 cm
Hip circumference	69,0 cm	75,0 cm	81,0 cm	87,0 cm	93,0 cm	99,0 cm	106,0 cm	112,0 cm	118,0 cm
Knee circumference	23,5 cm	25,0 cm	26,5 cm	28,0 cm	30,0 cm	31,0 cm	33,0 cm	34,5 cm	36,0 cm
Ankle circumference	17,0 cm	18,0 cm	19,0 cm	20,0 cm	21,0 cm	22,0 cm	23,0 cm	24,0 cm	25,0 cm
Inseam length	69,0 cm	70,0 cm	72,5 cm	74,0 cm	76,0 cm	78,0 cm	80,0 cm	81,0 cm	82,0 cm

Order example

Reference number	=	Size
28XP9	=	XL

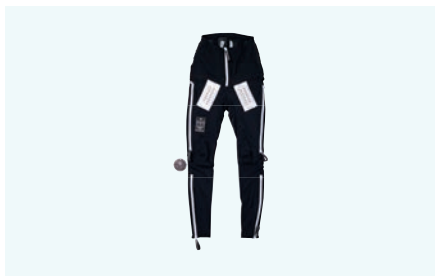

28XP11 EXOPULSE Pants unisex, short

Technical data

Article number	28XP11=XL
Size	XL
Waist circumference	92,0 cm
Waist circumference (relaxed)	89,0 cm
Hip circumference	106,0 cm
Knee circumference	33,0 cm
Ankle circumference	19,0 cm
Inseam length	72,5 cm

EXOPULSE Belt



29XP2 EXOPULSE Belt

Technical data

Article number	Length
29XP2=110	110 cm
29XP2=65	65 cm
29XP2=80	80 cm
29XP2=95	95 cm

Accessories for EXOPULSE Mollie Suit



29XP4 EXOPULSE Adjustment band

Technical data

Article number	Length
29XP4=1	short
29XP4=2	long



29XP5 EXOPULSE Laundry bag

Technical data

Article number
29XP5=U



654K1|654K2 MyActive

The MyActive product range includes individual compression clothing to achieve an improvement in movement and balance control for persons with neuromotor control deficits. For a positive influence on posture, sufficient support should be achieved without restricting movement and thereby muscle function.

Technical data

Article number	Description	Colour	Colour seam
654K1=1	MyActive Top, single layer, long, children	Grey/brown, Light blue	Grey/brown, Light blue, Telemagenta, Blue, Green
654K1=2	MyActive Top, double layer, long, children	Grey/brown, Light blue	Grey/brown, Light blue, Telemagenta, Blue, Green
654K1=3	MyActive Top, single layer, short, children	Grey/brown, Light blue	Grey/brown, Light blue, Telemagenta, Blue, Green
654K1=4	MyActive Top, double layer, short, children	Grey/brown, Light blue	Grey/brown, Light blue, Telemagenta, Blue, Green
654K1=5	MyActive Top, single layer, long, adults	Grey/brown, Light blue	Grey/brown, Light blue, Telemagenta, Blue, Green
654K1=6	MyActive Top, double layer, long, adults	Grey/brown, Light blue	Grey/brown, Light blue, Telemagenta, Blue, Green
654K1=7	MyActive Top, single layer, short, adults	Grey/brown, Light blue	Grey/brown, Light blue, Telemagenta, Blue, Green
654K1=8	MyActive Top, double layer, short, adults	Grey/brown, Light blue	Grey/brown, Light blue, Telemagenta, Blue, Green
654K2=1	MyActive Leggings, single layer, long, children	Grey/brown, Light blue	Grey/brown, Light blue, Telemagenta, Blue, Green
654K2=2	MyActive Leggings, double layer, long, children	Grey/brown, Light blue	Grey/brown, Light blue, Telemagenta, Blue, Green
654K2=3	MyActive Leggings, single layer, short, children	Grey/brown, Light blue	Grey/brown, Light blue, Telemagenta, Blue, Green
654K2=4	MyActive Leggings, double layer, short, children	Grey/brown, Light blue	Grey/brown, Light blue, Telemagenta, Blue, Green
654K2=5	MyActive Leggings, single layer, long, adults	Grey/brown, Light blue	Grey/brown, Light blue, Telemagenta, Blue, Green
654K2=6	MyActive Leggings, double layer, long, adults	Grey/brown, Light blue	Grey/brown, Light blue, Telemagenta, Blue, Green
654K2=7	MyActive Leggings, single layer, short, adults	Grey/brown, Light blue	Grey/brown, Light blue, Telemagenta, Blue, Green
654K2=8	MyActive Leggings, double layer, short, adults	Grey/brown, Light blue	Grey/brown, Light blue, Telemagenta, Blue, Green



Custom products from iFab

iFab offers flexible support for production bottlenecks and custom fitting solutions by taking over the time-consuming fabrication of devices and giving more freedom for core competencies. The iFab Customer Center (iCC) ensures efficient collaboration, where products can be configured and ordered in just a few clicks, order status and history can be assessed.

Accessory for MyActive

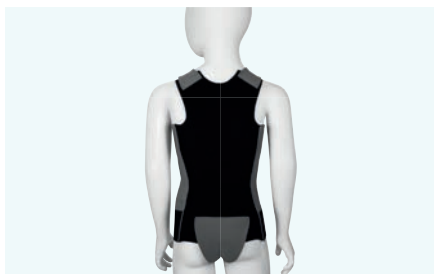

654K3 MyActive FIT KIT

It is not always clear whether compression garments have a positive effect on the user. For this purpose, we offer two-piece bodysuits that can be individually adjusted to the user's body using Velcro fasteners. This makes it possible to test whether compression on the torso and pelvis changes the user's clinical picture.

Technical data

Article number
654K3=4

• The 654K3 Fit Kit contains the bodies in three available sizes S, M and L.



AFO.

All ankle joints and dynamic components are presented in this section.

Bilateral



Hüftstrecker/
Hip extensor
5

Kniebeuger/
Knee flexor
5

Fußsenker/
Foot extensor
5

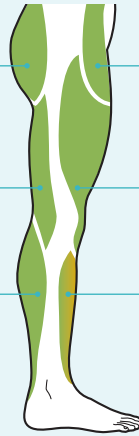

Hüftbeuger/
Hip flexor
5

Kniestrecker/
Knee extensor
5

Fußheber/
Dorsiflexion assist
3 – 5



17AF2

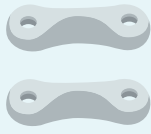

17AF10
X-ible



17B60
17B61
17B64
17B100
17F36



17B62



17A127
17Y129

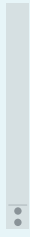

17B38
17B39

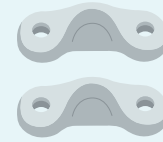

17AF10 X-ible
vorflektiert/with dorsal
assist

Bilateral

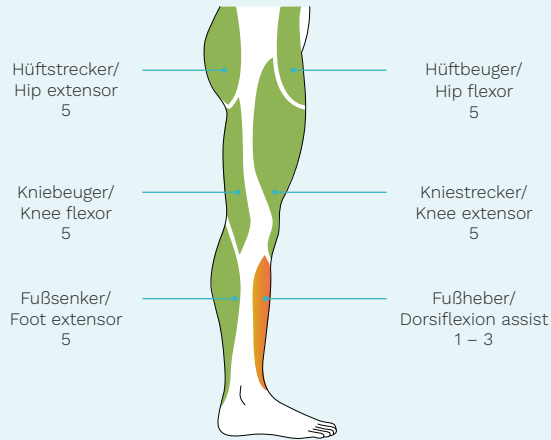

<p>17PA1</p>		<p>17AD1</p>		<p>17B63 17B99 17B101 17B107 17B108 17F70 17A127 17Y129 17B38 17B39</p>		<p>17AD200 17SL100 17SF200=OS 17SF200=FT 17SB100</p>	

Uni-/
Bilateral

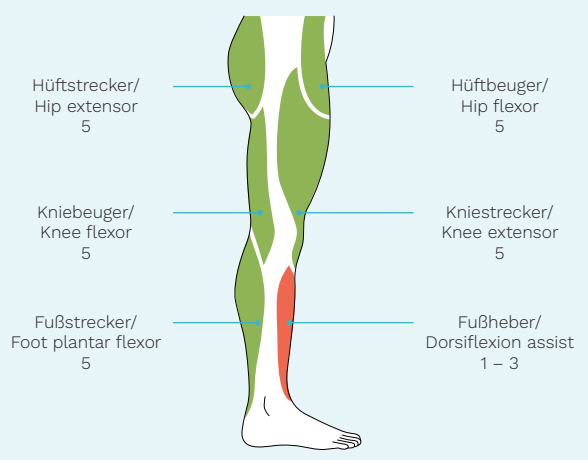

Unilateral
17LA3N

17LF31N

17LF3N 17LS3 17LV3

Unilateral
17AD300
17AD302
17AD301

17SF300=N 17LS3

Bilateral
17AD200

17SF200=FT

17SF200=OS 17SL100 17SB100

Bilateral
17AD300
17AD302
17AD301

17SF300=N 17LS3

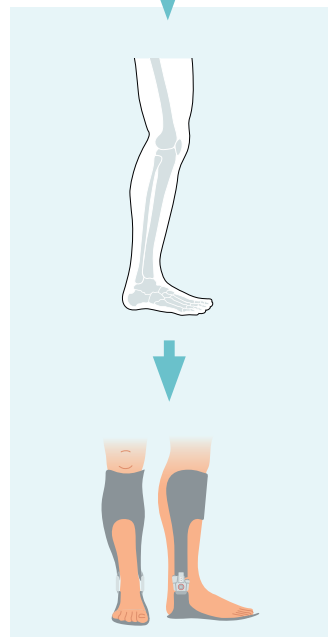
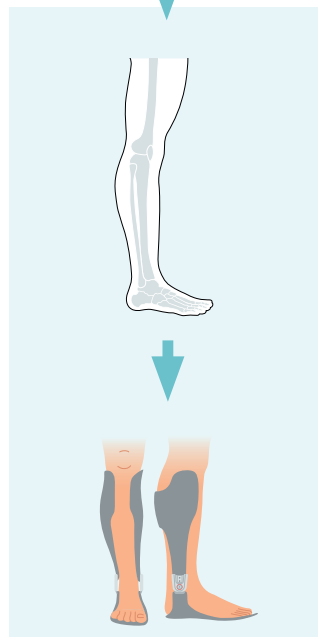
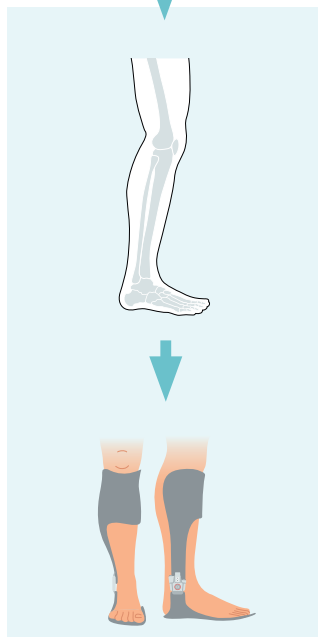
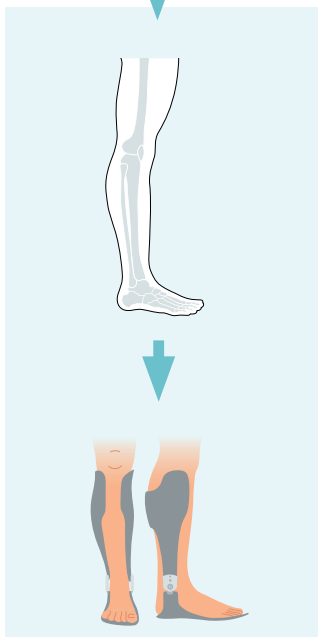

Uni-/
Bilateral

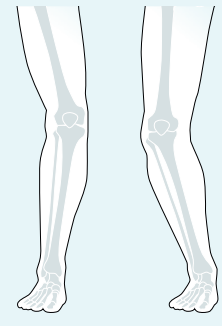
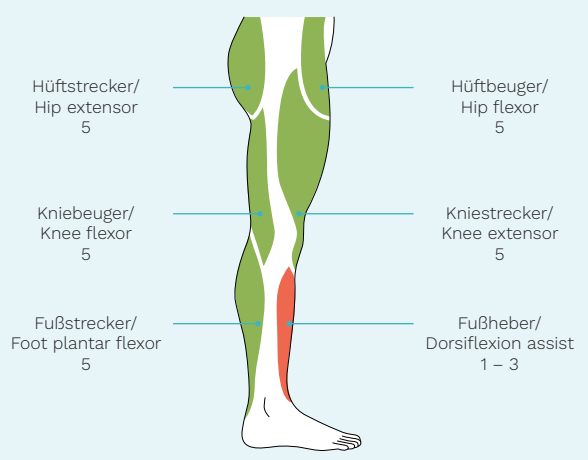

Unilateral
17LA3N

17LF31N

17LF3N 17LS3 17LV3

Unilateral
17AD300
17AD302
17AD301

17SF300=N 17LS3

Bilateral
17AD200

17SF200=FT

17SF200=OS 17SL100 17SB100

Bilateral
17AD300
17AD302
17AD301

17SF300=N 17LS3

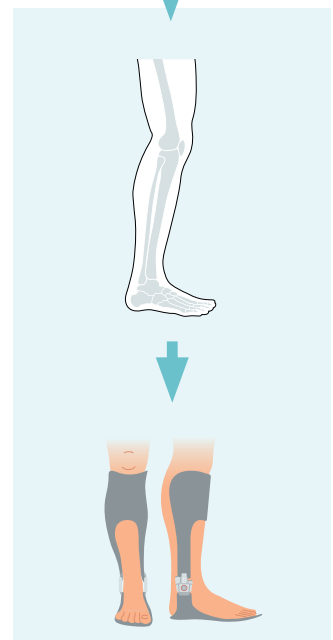
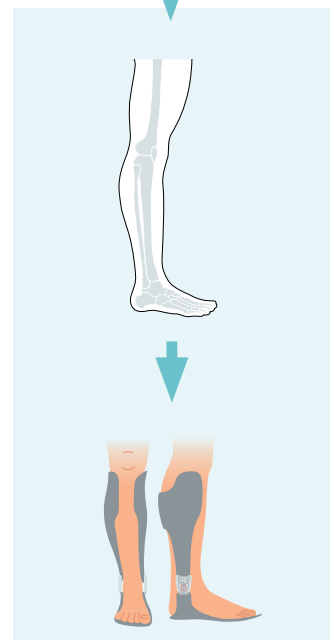
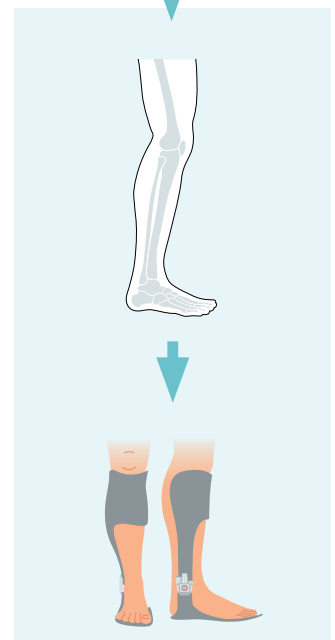
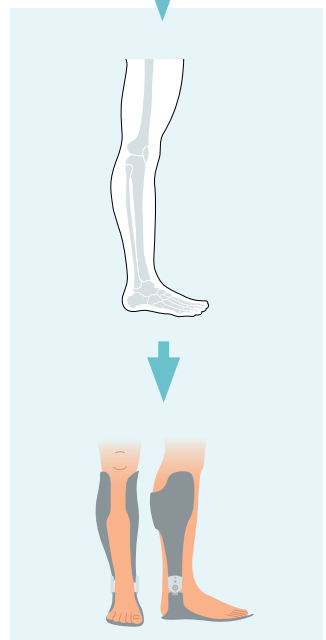



17AF10 X-ible

Stabilises the ankle joint in the frontal plane.



Technical data

Article number	Size	Length	Degree of hardness	Package contents
17AF10=S	S	3.2 cm	85	2 piece(s)
17AF10=M	M	3.8 cm	85	2 piece(s)
17AF10=L	L	4.5 cm	85	2 piece(s)
17AF10=S-PAC	S	3.2 cm	85	40 piece(s)
17AF10=M-PAC	M	3.8 cm	85	40 piece(s)
17AF10=L-PAC	L	4.5 cm	85	40 piece(s)



17AF10 X-ible

Pre-flexed to support dorsiflexion in the sagittal plane.



Technical data

Article number	Size	Length	Degree of hardness	Package contents
17AF10=S-DA-LT	S	3.2 cm	75	2 piece(s)
17AF10=S-DA-MD	S	3.2 cm	85	2 piece(s)
17AF10=S-DA-ST	S	3.2 cm	95	2 piece(s)
17AF10=S-DA-LT-PAC	S	3.2 cm	75	40 piece(s)
17AF10=S-DA-MD-PAC	S	3.2 cm	85	40 piece(s)
17AF10=S-DA-ST-PAC	S	3.2 cm	95	40 piece(s)
17AF10=M-DA-LT	M	3.8 cm	75	2 piece(s)
17AF10=M-DA-MD	M	3.8 cm	85	2 piece(s)
17AF10=M-DA-ST	M	3.8 cm	95	2 piece(s)
17AF10=M-DA-LT-PAC	M	3.8 cm	75	40 piece(s)
17AF10=M-DA-MD-PAC	M	3.8 cm	85	40 piece(s)
17AF10=M-DA-ST-PAC	M	3.8 cm	95	40 piece(s)
17AF10=L-DA-LT	L	4.5 cm	75	2 piece(s)
17AF10=L-DA-MD	L	4.5 cm	85	2 piece(s)
17AF10=L-DA-ST	L	4.5 cm	95	2 piece(s)
17AF10=L-DA-LT-PAC	L	4.5 cm	75	40 piece(s)
17AF10=L-DA-MD-PAC	L	4.5 cm	85	40 piece(s)
17AF10=L-DA-ST-PAC	L	4.5 cm	95	40 piece(s)

Spare parts for 17AF10



17AF10A Dummy for 17AF10

Dummy for 17AF10 X-ible

Technical data

Article number	Spare part for
17AF10A=DY-S	17AF10=S 17AF10=S-DA-LT 17AF10=S-DA-MD 17AF10=S-DA-ST
17AF10A=DY-M	17AF10=M 17AF10=M-DA-LT 17AF10=M-DA-MD 17AF10=M-DA-ST
17AF10A=DY-L	17AF10=L 17AF10=L-DA-LT 17AF10=L-DA-MD 17AF10=L-DA-ST



17AF2 Free motion ankle joint

For use in thermoplastic AFOs. No maintenance required. With parallel alignment tool.

Key features

- Includes parallel alignment tool
- New, modern design
- Available in adult and children's sizes
- Includes recommendations regarding weight classification and activity level



Technical data

Article number	Overall length upper section – foot stirrup	Material	Quantity unit
17AF2=63	63.5 mm	Stainless steel	Pair
17AF2=77	77.5 mm	Stainless steel	Pair

- Simple tool for parallel adjustment is included in the delivery



17F34 Ankle joint bar for children

Free-motion ankle joint bar

Range of motion of +/- 30° adjustable by filing upper section of ankle joint bar
Forged foot stirrup, flat bar profile, fixed joint, upper sections and foot stirrup

Key features

- Consists of an upper part and foot stirrup
- Forged foot stirrup
- Flat bar profile
- Fixed joint



Technical data

Article number	Bar length	Bar width	Bar thickness	Stirrup length from joint centre	Stirrup width	Joint head Ø	Material	Quantity unit
17F34=6	180 mm	12 mm	2 mm	115 mm	25 mm	16 mm	Stainless steel	Pair
17F34=5	240 mm	14 mm	2 mm	130 mm	30 mm	18 mm	Stainless steel	Pair

Spare parts for 17F34

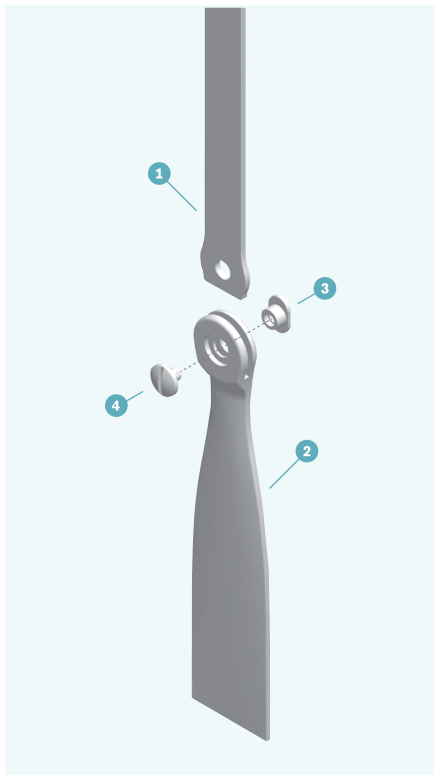

1) 17A4 Ankle joint bar, upper section

Technical data

Article number	Spare part for	Bar length	Bar width	Bar thickness	Material	Quantity unit
17A4=5	17F34=5	240 mm	14 mm	2 mm	Stainless steel	Piece
17A4=6	17F34=6	180 mm	12 mm	2 mm	Stainless steel	Piece

2) 17C4 Ankle stirrup

Technical data

Article number	Spare part for	Stirrup length	Joint head Ø	Material	Quantity unit
17C4=5	17F34=5	130 mm	18 mm	Stainless steel	Piece
17C4=6	17F34=6	115 mm	16 mm	Stainless steel	Piece

3) 17Y93 Bearing nut, hardened

Technical data

Article number	Spare part for	Insertion length	Profile length	Shank length	Thread	Shoulder Ø	Quantity unit
17Y93=6X4.75XM4	17F34=5 17F34=6	3.5 mm	12 mm	4.75 mm	M4	6 mm	Piece
17Y93=6.5X4.75XM4	17F34=5 17F34=6	3.5 mm	12 mm	4.75 mm	M4	6.5 mm	Piece
17Y93=7X4.75XM4	17F34=5 17F34=6	3.5 mm	12 mm	4.75 mm	M4	7 mm	Piece

4) 501S32 Slotted truss head screw

Technical data

Article number	Spare part for	Length	Head Ø	Thread	Material	Quantity unit
501S32=M4X10X7.5	17F34=5 17F34=6	7.5 mm	10 mm	M4	Stainless steel	Piece



17F24 Ankle joint bar for children

Free-motion ankle joint bar

Range of motion of +/- 30° adjustable by filing upper section of ankle joint bar
Forged foot stirrup, fixed joint, upper sections and foot stirrup

Key features

- Consists of an upper part and foot stirrup
- Forged foot stirrup
- Fixed joint



Technical data

Article number	Bar length	Bar width	Bar thickness	Stirrup length from joint centre	Stirrup width	Joint head Ø	Material	Quantity unit
17F24=5	300 mm	15 mm	3 mm	130 mm	40 mm	20 mm	Stainless steel	Pair
17F24=4	300 mm	15 mm	3 mm	130 mm	40 mm	22 mm	Stainless steel	Pair
17F24=2	390 mm	18 mm	3 mm	150 mm	40 mm	24 mm	Stainless steel	Pair

Spare parts for 17F24

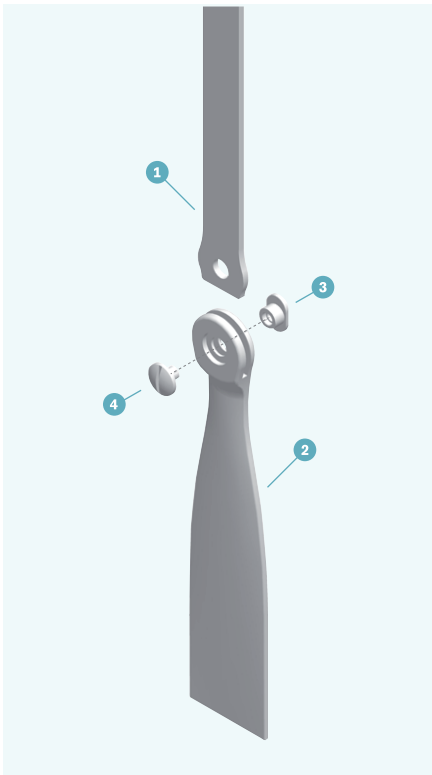

1) 17A3 Ankle joint bar, upper section

Technical data

Article number	Spare part for	Bar length	Bar width	Bar thickness	Material	Quantity unit
17A3=2	17F24=2	390 mm	18 mm	3 mm	Stainless steel	Piece
17A3=4	17F24=4	300 mm	15 mm	3 mm	Stainless steel	Piece
17A3=5	17F24=5	300 mm	15 mm	3 mm	Stainless steel	Piece

2) 17C3 Foot stirrup with bearing nut and truss head screw

Technical data

Article number	Spare part for	Stirrup length	Joint head Ø	Material	Quantity unit
17C3=2	17F24=2	150 mm	24 mm	Stainless steel	Piece
17C3=4	17F24=4	130 mm	22 mm	Stainless steel	Piece

3) 17Y93 Bearing nut, hardened

Technical data

Article number	Spare part for	Insertion length	Profile length	Shank length	Thread	Shoulder Ø	Quantity unit
17Y93=7X7XM5	17F24=2 17F24=4 17F24=5	5.5 mm	12 mm	7 mm	M5	7 mm	Piece
17Y93=7.5X7XM5	17F24=2 17F24=4 17F24=5	5.55 mm	12 mm	7 mm	M5	7.5 mm	Piece

4) 501S32 Slotted truss head screw

Technical data

Article number	Length	Head Ø	Thread	Material	Quantity unit
501S32=M5X12X9.5	9.5 mm	12 mm	M5	Stainless steel	Piece



17B62 System ankle joint

System ankle joint with range of motion of +/- 30°, to be established by filing the foot stirrup

Contoured medial joint, straight lateral joint



Technical data

Article number	System width	Joint head Ø	Slot width	Length from joint center	Material	Quantity unit
17B62=16	16 mm	22 mm	2.5 mm	41 mm	Stainless steel	Pair
17B62=20	20 mm	24.5 mm	3 mm	41 mm	Stainless steel	Pair



17B57 System ankle joint

System ankle joint with range of motion of +/- 30°, to be established by filing the foot stirrup

Straight medial and lateral joints



Technical data

Article number	System width	Joint head Ø	Slot width	Length from joint center	Quantity unit
17B57=16	16 mm	22 mm	2.5 mm	41 mm	Pair
17B57=20	20 mm	24 mm	3 mm	41 mm	Pair

- The joint can be ordered separately under article numbers 17A57=16 and 17A57=20.

Spare parts for 17B57, 17B62

2

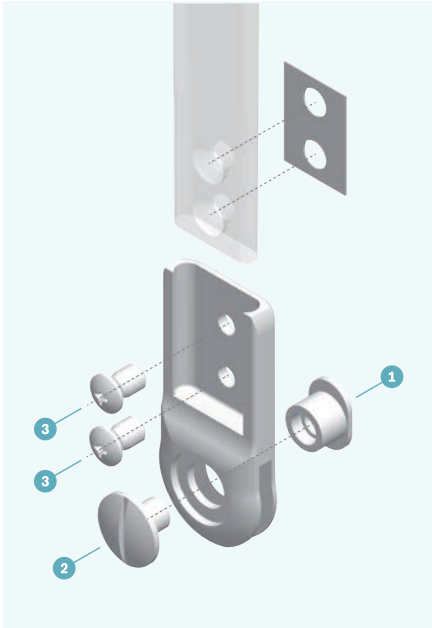

1) 17Y93 Bearing nut, hardened

Technical data

Article number	Spare part for	Insertion length	Profile length	Shank length	Thread	Shoulder Ø	Quantity unit
17Y93=9X7.2XM6	17B57=20 17B62=20	6 mm	14 mm	7.2 mm	M6	9 mm	Piece

2) 501S32 Slotted truss head screw

Technical data

Article number	System width	Length	Head Ø	Thread	Overall length	Material	Quantity unit
501S32=M6X14X10	16/ 20 mm	10 mm	14 mm	M6	10 mm	Stainless steel	Piece
501S32=M5X12X9.5	16 mm	9.5 mm	12 mm	M5	9.5 mm	Stainless steel	Piece

3) 501T7 Phillips oval countersunk head screw

Technical data

Article number	Spare part for	Length	Head Ø	Material	Quantity unit
501T7=7.5X9XM5	17B57=16 17B57=20 17B62=16 17B62=20	9 mm	7.5 mm	Stainless steel	Piece



17Y17 Brass bushing

Bearing bushing made of brass

Technical data

Article number	System width	Material	Quantity unit
17Y17=7X9X2.4	16 mm	Brass	Piece
17Y17=9X11X2.9	20 mm	Brass	Piece

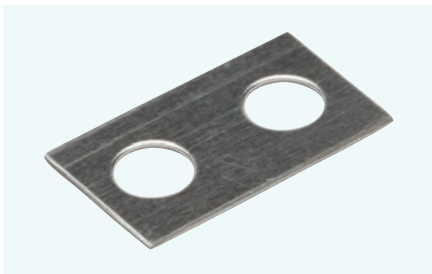

17Y42 Shim plate

To compensate for the difference in thickness between 4 mm thick side bars and 5 mm thick connections of the system joints

Technical data

Article number	For bar width	Plate width	Material
17Y42=12	16 mm	12 mm	Stainless steel
17Y42=15	20 mm	15 mm	Stainless steel



Accessory for 17B57, 17B62



17B55 System foot stirrup

with brass bushing



Technical data

Article number	System width	Thickness	Length from joint center	Material	Quantity unit
17B55=145X2.5	16 mm	2.5 mm	145 mm	Stainless steel	Piece
17B55=165X3	20 mm	3 mm	165 mm	Stainless steel	Piece



17B100 System lamination foot stirrup

with brass bushing



Technical data

Article number	System width	Thickness	Length from joint center	Material	Quantity unit
17B100=16	16 mm	2.5 mm	63 mm	Stainless steel	Piece
17B100=20	20 mm	3 mm	63 mm	Stainless steel	Piece



17B60 Forked system foot stirrup

forked, with brass bushing



Technical data

Article number	System width	Thickness	Caster fork width front/rear	Material	Quantity unit
17B60=205	20 mm	3 mm	205/190 mm	Stainless steel	Piece



17F36 System shoe stirrup

with brass bushing



Technical data

Article number	System width	Thickness	Length from joint center	Material	Quantity unit
17F36=200X2.5	16 mm	2.5 mm	200 mm	Stainless steel	Piece
17F36=220X2.5	16 mm	2.5 mm	220 mm	Stainless steel	Piece
17F36=240X2.5	16 mm	2.5 mm	240 mm	Stainless steel	Piece
17F36=260X2.5	16 mm	2.5 mm	260 mm	Stainless steel	Piece
17F36=280X2.5	16 mm	2.5 mm	280 mm	Stainless steel	Piece
17F36=300X2.5	16 mm	2.5 mm	300 mm	Stainless steel	Piece
17F36=200X3	20 mm	3 mm	200 mm	Stainless steel	Piece
17F36=220X3	20 mm	3 mm	220 mm	Stainless steel	Piece
17F36=240X3	20 mm	3 mm	240 mm	Stainless steel	Piece
17F36=260X3	20 mm	3 mm	260 mm	Stainless steel	Piece
17F36=280X3	20 mm	3 mm	280 mm	Stainless steel	Piece
17F36=300X3	20 mm	3 mm	300 mm	Stainless steel	Piece
17F36=320X3	20 mm	3 mm	320 mm	Stainless steel	Piece



17B64 System foot stirrup

with brass bushing



Technical data

Article number	System width	Thickness	Channel width	Head Ø	Length from joint center	Material	Quantity unit
17B64=165X3	20 mm	3 mm	22 mm	24 mm	165 mm	Stainless steel	Piece



17F35 System shoe plate, hardened

With insert piece

Technical data

Article number	Accessory for	Side	Length	Material	Quantity unit
17F35=L120	17B57=16 17B62=16	left (L)	120 mm	Stainless steel	Piece
17F35=R120	17B57=16 17B62=16	right (R)	120 mm	Stainless steel	Piece
17F35=L150	17B57=20 17B62=20	left (L)	150 mm	Stainless steel	Piece
17F35=R150	17B57=20 17B62=20	right (R)	150 mm	Stainless steel	Piece



17F31 Ankle joint bar

Ankle joint bar with dorsiflexion function made of stainless steel



Technical data

Article number	Side	Bar width	Joint head Ø	Slot width	Material	Quantity unit
17F31=L28X3	left (L)	16 mm	28 mm	3 mm	Stainless steel	Piece
17F31=L30X3	left (L)	17 mm	30 mm	3 mm	Stainless steel	Piece
17F31=R28X3	right (R)	16 mm	28 mm	3 mm	Stainless steel	Piece
17F31=R30X3	right (R)	17 mm	30 mm	3 mm	Stainless steel	Piece

Spare parts for 17F31

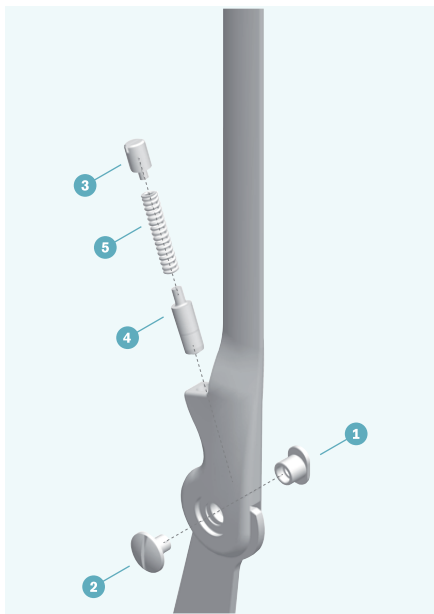

1) 17Y93 Bearing nut, hardened

Technical data

Article number	Spare part for	Insertion length	Profile length	Shank length	Thread	Shoulder Ø	Quantity unit
17Y93=9X7.2XM6	17F31=L28X3 17F31=R28X3 17F31=L30X3 17F31=R30X3	6 mm	14 mm	7.2 mm	M6	9 mm	Piece
17Y93=9.5X7.2XM6	17F31=L28X3 17F31=R28X3 17F31=L30X3 17F31=R30X3	6 mm	14 mm	7.2 mm	M6	9.5 mm	Piece

2) 501S32 Slotted truss head screw

Technical data

Article number	Spare part for	Length	Overall length	Thread	Head Ø	Material	Quantity unit
501S32=M6X14X10	17F31=L28X3 17F31=R28X3 17F31=L30X3 17F31=R30X3	10 mm	10 mm	M6	14 mm	Stainless steel	Piece

3) 17Y18 Set screw with slot

Technical data

Article number	Spare part for	System width	Thread	Thread length	Material	Quantity unit
17Y18=M7X13	17F31=L28X3 17F31=R28X3 17F31=L30X3 17F31=R30X3	20 mm	M7	13 mm	Stainless steel	Piece

4) 17Y80 Thrust piece with ball

Technical data

Article number	Spare part for	For system width	Quantity unit
17Y80	17F31=L28X3 17F31=R28X3 17F31=L30X3 17F31=R30X3	20 mm	Piece

5) 513D18 Compression spring

Technical data

Article number	Spare part for	Quantity unit
513D18=5.5X35	17F31=L28X3 17F31=R28X3	Piece
513D18=5.5X45	17F31=L30X3 17F31=R30X3	Piece

Accessory for 17F31



17B58 Ankle stirrup and shrink down tube

Foot stirrup for the 17F31 and 17F32 ankle joint bars

Technical data

Article number	Accessory for	Bar width	Thick-ness	Stirrup length	Head Ø	Material	Quantity unit
17B58=28X3X165	17F31=L28X3 17F31=R28X3	20 mm	3 mm	165 mm	28 mm	Stainless steel	Piece
17B58=30X3X165	17F31=L30X3 17F31=R30X3	20 mm	3 mm	165 mm	30 mm	Stainless steel	Piece



17F33 Shoe stirrup

Shoe stirrup for the 17F31 and 17F32 ankle joint bars

Technical data

Article number	Accessory for	Thick-ness	Head Ø	Length from joint centre to joint centre	Material	Quantity unit
17F33=200X3	17F31=L28X3 17F31=R28X3	3 mm	28 mm	200 mm	Stainless steel	Piece
17F33=220X3	17F31=L28X3 17F31=R28X3	3 mm	28 mm	220 mm	Stainless steel	Piece
17F33=240X3	17F31=L28X3 17F31=R28X3	3 mm	28 mm	240 mm	Stainless steel	Piece
17F33=260X3	17F31=L30X3 17F31=R30X3	3 mm	30 mm	260 mm	Stainless steel	Piece
17F33=280X3	17F31=L30X3 17F31=R30X3	3 mm	30 mm	280 mm	Stainless steel	Piece
17F33=300X3	17F31=L30X3 17F31=R30X3	3 mm	30 mm	300 mm	Stainless steel	Piece

· Up to 420 mm of extra length is available for an additional charge.



17B65 System foot stirrup

for 17F35 system shoe plate

Technical data

Article number	Accessory for	System width	Thick-ness	Channel width	Head Ø	Length from joint center	Material	Quantity unit
17B65=28X3X165	17F31=L28X3 17F31=R28X3	20 mm	3 mm	22 mm	28 mm	165 mm	Stainless steel	Piece
17B65=30X3X165	17F31=L30X3 17F31=R30X3	20 mm	3 mm	22 mm	30 mm	165 mm	Stainless steel	Piece



17F35 System shoe plate, hardened

With insert piece

Technical data

Article number	Accessory for	Side	Length	Channel width	Insertion depth	System width	Material	Quantity unit
17F35=L150	17F31=L28X3 17F31=R28X3 17F31=L30X3 17F31=R30X3	left (L)	150 mm	22 mm	80 mm	20 mm	Stainless steel	Piece
17F35=R150	17F31=L28X3 17F31=R28X3 17F31=L30X3 17F31=R30X3	right (R)	150 mm	22 mm	80 mm	20 mm	Stainless steel	Piece



17F32 Ankle joint bar

Ankle joint bar with dorsiflexion function made of aluminium



Technical data

Article number	Side	Bar width	Joint head Ø	Slot width	Material	Quantity unit
17F32=L28X3	left	16 mm	28 mm	3 mm	Aluminium	Piece
17F32=R28X3	right	16 mm	28 mm	3 mm	Aluminium	Piece
17F32=L30X3	left	17 mm	30 mm	3 mm	Aluminium	Piece
17F32=R30X3	right	17 mm	30 mm	3 mm	Aluminium	Piece

Spare parts for 17F32

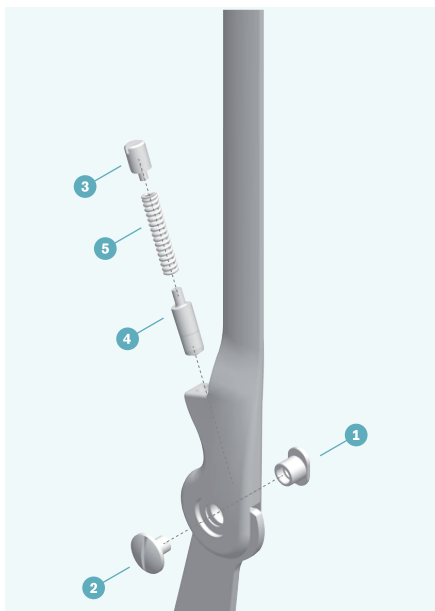

1) 17Y93 Bearing nut, hardened

Technical data

Article number	Spare part for	Insertion length	Profile length	Shank length	Thread	Shoulder Ø	Quantity unit
17Y93=9X7.2XM6	17F32=L28X3 17F32=R28X3 17F32=L30X3 17F32=R30X3	6 mm	14 mm	7.2 mm	M6	9 mm	Piece
17Y93=9.5X7.2XM6	17F32=L28X3 17F32=R28X3 17F32=L30X3 17F32=R30X3	6 mm	14 mm	7.2 mm	M6	9.5 mm	Piece

2) 501S32 Slotted truss head screw

Technical data

Article number	Spare part for	Length	Overall length	Thread	Head Ø	Material	Quantity unit
501S32=M6X14X10	17F32=L28X3 17F32=R28X3 17F32=L30X3 17F32=R30X3	10 mm	10 mm	M6	14 mm	Stainless steel	Piece

3) 17Y18 Set screw with slot

Technical data

Article number	Spare part for	System width	Thread	Thread length	Material	Quantity unit
17Y18=M6X11	17F32=L26X2.5 17F32=R26X2.5	16 mm	M6	11 mm	Stainless steel	Piece
17Y18=M7X13	17F32=L30X3 17F32=L28X3 17F32=R28X3 17F32=R30X3	20 mm	M7	13 mm	Stainless steel	Piece

4) 17Y80 Thrust piece with ball

Technical data

Article number	Spare part for	For system width	Quantity unit
17Y80	17F32=L28X3 17F32=R28X3 17F32=L30X3 17F32=R30X3	20 mm	Piece

5) 513D18 Compression spring

Technical data

Article number	Spare part for	Quantity unit
513D18=5.5X35	17F32=L28X3 17F32=R28X3	Piece
513D18=5.5X45	17F32=L30X3 17F32=R30X3	Piece

Accessory for 17F32



17B58 Ankle stirrup and shrink down tube

Foot stirrup for the 17F31 and 17F32 ankle joint bars

Technical data

Article number	Accessory for	Bar width	Thick-ness	Stirrup length	Head Ø	Material	Quantity unit
17B58=28X3X165	17F32=L28X3 17F32=R28X3	20 mm	3 mm	165 mm	28 mm	Stainless steel	Piece
17B58=30X3X165	17F32=L30X3 17F32=R30X3	20 mm	3 mm	165 mm	30 mm	Stainless steel	Piece



17F33 Shoe stirrup

Shoe stirrup for the 17F31 and 17F32 ankle joint bars

Technical data

Article number	Accessory for	Thickness	Head Ø	Length from joint centre to joint centre	Material	Quantity unit
17F33=200X3	17F32=L28X3 17F32=R28X3	3 mm	28 mm	200 mm	Stainless steel	Piece
17F33=220X3	17F32=L28X3 17F32=R28X3	3 mm	28 mm	220 mm	Stainless steel	Piece
17F33=240X3	17F32=L28X3 17F32=R28X3	3 mm	28 mm	240 mm	Stainless steel	Piece
17F33=260X3	17F32=L30X3 17F32=R30X3	3 mm	30 mm	260 mm	Stainless steel	Piece
17F33=280X3	17F32=L30X3 17F32=R30X3	3 mm	30 mm	280 mm	Stainless steel	Piece
17F33=300X3	17F32=L30X3 17F32=R30X3	3 mm	30 mm	300 mm	Stainless steel	Piece

· Up to 420 mm of extra length is available for an additional charge.



17B65 System foot stirrup

for 17F35 system shoe plate

Technical data

Article number	Accessory for	System width	Thick-ness	Channel width	Head Ø	Length from joint center	Material	Quantity unit
17B65=28X3X165	17F32=L28X3 17F32=R28X3	20 mm	3 mm	22 mm	28 mm	165 mm	Stainless steel	Piece
17B65=30X3X165	17F32=L30X3 17F32=R30X3	20 mm	3 mm	22 mm	30 mm	165 mm	Stainless steel	Piece



17F35 System shoe plate, hardened

With insert piece

Technical data

Article number	Accessory for	Side	Length	Material	Quantity unit
17F35=L150	17F32=L28X3 17F32=R28X3 17F32=L30X3 17F32=R30X3	left (L)	150 mm	Stainless steel	Piece
17F35=R150	17F32=L28X3 17F32=R28X3 17F32=L30X3 17F32=R30X3	right (R)	150 mm	Stainless steel	Piece



17B53 System ankle joint

Joint with dorsiflexion function and dorsal stop to be established by filing the foot stirrup

Contoured medial and lateral joints, with compression spring



Technical data

Article number	System width	Joint head Ø	Slot width	Length from joint center	Material	Quantity unit
17B53=16	16 mm	26 mm	2.5 mm	57 mm	Stainless steel	Pair
17B53=20	20 mm	28 mm	3 mm	66 mm	Stainless steel	Pair

i Practical recommendation

- Increased wear of the spring due to fully compressing it.
- We recommend using 636K8=20X2X10 Plastaband to isolate the joints for the lamination resin technique.



17B59 System ankle joint

Joint with dorsiflexion function and dorsal stop to be established by filing the foot stirrup

Straight medial and lateral joints, with compression spring



Technical data

Article number	System width	Joint head Ø	Slot width	Length from joint center	Material	Quantity unit
17B59=16	16 mm	26 mm	2.5 mm	57 mm	Stainless steel	Pair
17B59=20	20 mm	28 mm	3 mm	66 mm	Stainless steel	Pair

i Practical recommendation

- Increased wear of the spring due to fully compressing it.
- We recommend using 636K8=20X2X10 Plastaband to isolate the joints for the lamination resin technique.



17B63 System ankle joint

Joint with dorsiflexion function and dorsal stop to be established by filing the foot stirrup

Contoured medial joint, straight lateral joint, with compression spring



Technical data

Article number	System width	Side	Joint head Ø	Slot width	Length from joint center	Material	Quantity unit
17B63=L16	16 mm	left (L)	26 mm	2.5 mm	57 mm	Stainless steel	Pair
17B63=R16	16 mm	right (R)	26 mm	2.5 mm	57 mm	Stainless steel	Pair
17B63=L20	20 mm	left (L)	28 mm	3 mm	66 mm	Stainless steel	Pair
17B63=R20	20 mm	right (R)	28 mm	3 mm	66 mm	Stainless steel	Pair

i Practical recommendation

- Increased wear and tear to the spring due to fully compressing it.
- We recommend using 636K8=20X2X10 Plastaband to isolate the joints for the lamination resin technique.

Spare parts for 17B53, 17B59, 17B63

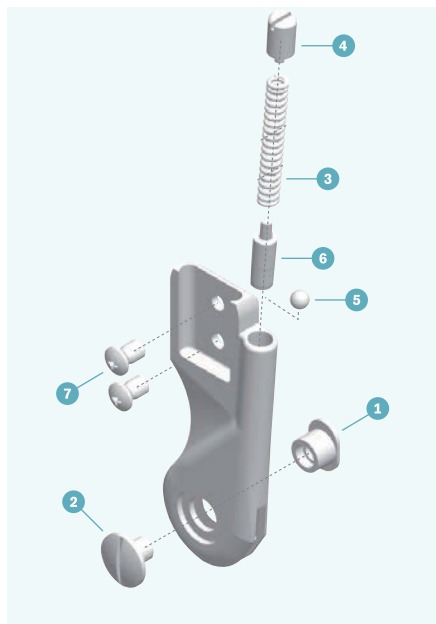

1) 17Y93 Bearing nut, hardened

Technical data

Article number	Spare part for	Insertion length	Profile length	Shank length	Thread	Shoulder Ø	Quantity unit
17Y93=9X7.2XM6	17B53=20 17B59=20 17B63=L20 17B63=R20	6 mm	14 mm	7.2 mm	M6	9 mm	Piece

2) 501S32 Slotted truss head screw

Technical data

Article number	System width	Head Ø	Thread	Overall length	Material	Quantity unit
501S32=M5X12X9.5	16 mm	12 mm	M5	9.5 mm	Stainless steel	Piece
501S32=M6X14X10	16/20 mm	14 mm	M6	10 mm	Stainless steel	Piece

3) 513D18 Compression spring

Technical data

Article number	System width	Length	Shoulder Ø	Quantity unit
513D18=4.7X31	16 mm	31 mm	4.7 mm	Piece
513D18=5.5X35	20 mm	35 mm	5.5 mm	Piece

4) 17Y18 Set screw with slot

Technical data

Article number	Spare part for	System width	Thread	Thread length	Material	Quantity unit
17Y18=M6X11	17B53=16 17B59=16 17B63=L16 17B63=R16	16 mm	M6	11 mm	Stainless steel	Piece
17Y18=M7X13	17B53=20 17B59=20 17B63=L20 17B63=R20	20 mm	M7	13 mm	Stainless steel	Piece

5) 509Y2 Bearing ball

Technical data

Article number	Spare part for	For system width	Material	Quantity unit
509Y2=3/16"	17B53=16 17B59=16 17B63=L16 17B63=R16	16 mm	Stainless steel	Piece

6) 17Y80 Thrust piece with ball

Technical data

Article number	Spare part for	For system width	Quantity unit
17Y80	17B53=20 17B59=20 17B63=L20 17B63=R20	20 mm	Piece

7) 501T7 Phillips oval countersunk head screw

Technical data

Article number	Head Ø	Length	Material	Quantity unit
501T7=7.5X9XM5	7.5 mm	9 mm	Stainless steel	Piece

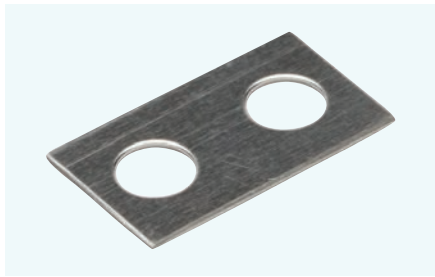

17Y42 Shim plate

To compensate for the difference in thickness between 4 mm thick side bars and 5 mm thick connections of the system joints

Technical data

Article number	For bar width	Plate width	Material
17Y42=12	16 mm	12 mm	Stainless steel
17Y42=15	20 mm	15 mm	Stainless steel



17Y17 Brass bushing

Bearing bushing made of brass

Technical data

Article number	System width	Material	Quantity unit
17Y17=7X9X2.4	16 mm	Brass	Piece
17Y17=9X11X2.9	20 mm	Brass	Piece

Accessory for 17B53, 17B59, 17B63



17B108 System foot stirrup

With brass bushing, dorsal stop that can be filed and 20° plantar flexion
Matching foot stirrups for 17B63, 17B59, 17B53



Technical data

Article number	System width	Thickness	Length from joint center	Material	Quantity unit
17B108=145X2.5	16 mm	2.5 mm	145 mm	Stainless steel	Piece
17B108=165X3	20 mm	3 mm	165 mm	Stainless steel	Piece



17B99 System lamination foot stirrup

Free motion up to 20° dorsal extension and 20° plantar flexion, with brass bushing



Technical data

Article number	System width	Thickness	Length from joint center	Material	Quantity unit
17B99=16	16 mm	2.5 mm	63 mm	Stainless steel	Piece
17B99=20	20 mm	3 mm	63 mm	Stainless steel	Piece



17B101 System lamination foot stirrup

With dorsal stop and 20° plantar flexion, with brass bushing



Technical data

Article number	System width	Thickness	Length from joint center	Material	Quantity unit
17B101=16	16 mm	2.5 mm	63 mm	Stainless steel	Piece
17B101=20	20 mm	3 mm	63 mm	Stainless steel	Piece



17B107 Ankle stirrup and shrink down tube

With dorsal stop that can be filed and 20° plantar flexion, with brass bushing
Matching foot stirrups for 17B63, 17B59, 17B53



Technical data

Article number	System width	Thick-ness	Stirrup length	Stirrup width	Length from joint center	Material	Quantity unit
17B107=145X2.5	16 mm	2.5 mm	145 mm	19 mm	145 mm	Stainless steel	Piece
17B107=165X3	20 mm	3 mm	165 mm	22 mm	165 mm	Stainless steel	Piece



17F35 System shoe plate, hardened

With insert piece

Technical data

Article number	Accessory for	Side	Length	Material	Quantity unit
17F35=L120	17B53=16 17B59=16 17B63=L16 17B63=R16	left (L)	120 mm	Stainless steel	Piece
17F35=L150	17B53=20 17B59=20 17B63=L20 17B63=R20	left (L)	150 mm	Stainless steel	Piece
17F35=R120	17B53=16 17B59=16 17B63=L16 17B63=R16	right (R)	120 mm	Stainless steel	Piece
17F35=R150	17B53=20 17B59=20 17B63=L20 17B63=R20	right (R)	150 mm	Stainless steel	Piece



17AD1 Multifunction orthotic ankle joint

For use in thermoplastic ankle-foot orthoses. Dorsal and plantar limitation or spring support. With parallel alignment tool.

Key features

- Includes parallel alignment tool
- New, modern design
- Available in adult and children's sizes
- Includes recommendations regarding weight classification and activity level



Technical data

Article number	Max. body weight	Overall length upper section – foot stirrup	Material	Quantity unit
17AD1=93	35 kg	93 mm	Stainless steel	Pair
17AD1=120	100 kg	120 mm	Stainless steel	Pair

Spare part for 17AD1



17AS=19 Service set

Service set for 17AD1

Technical data

Article number	Scope of delivery
17AS=19	Bearing nut, Compression spring, Flat round disk with slot, Red washer

Accessory for 17AD1



743Y57 Alignment insert set

Alignment insert set for conventional orthotic joints

Technical data

Article number	Accessory for
743Y57	17AD1=93 17AD1=120

- The 743Y57 is a set consisting of the alignment inserts in sizes 5 through 9.



17LA3N Unilateral system ankle joint

The 17LA3N unilateral ankle joint is a multifunction system ankle joint with a dorsiflexion effect.



Technical data

Article number	System width	Max. body weight	Material	Quantity unit
17LA3N=10	10 mm	15 kg (unilateral) / 25 kg (bilateral)	Steel	Piece
17LA3N=10-T	10 mm	15 kg (unilateral) / 25 kg (bilateral)	Titanium	Piece
17LA3N=12	12 mm	20 kg (unilateral) / 40 kg (bilateral)	Steel	Piece
17LA3N=12-T	12 mm	20 kg (unilateral) / 40 kg (bilateral)	Titanium	Piece
17LA3N=14	14 mm	50 kg (unilateral) / 80 kg (bilateral)	Steel	Piece
17LA3N=14-T	14 mm	50 kg (unilateral) / 80 kg (bilateral)	Titanium	Piece
17LA3N=16	16 mm	85 kg (unilateral) / 120 kg (bilateral)	Steel	Piece
17LA3N=16-T	16 mm	85 kg (unilateral) / 120 kg (bilateral)	Titanium	Piece
17LA3N=20	20 mm	110 kg (unilateral) / 160 kg (bilateral)	Steel	Piece
17LA3N=20-T	20 mm	110 kg (unilateral) / 160 kg (bilateral)	Titanium	Piece

- When using the product unilaterally, the next higher size must be used in cases where there is flexion contracture in the knee or hip greater than 10°; or distinct torsion or valgus/varus instabilities; or increased physical activity.
- Use the product bilaterally if there is any ischial support or valgus/varus malpositions greater than 10°

Spare parts for 17LA3N

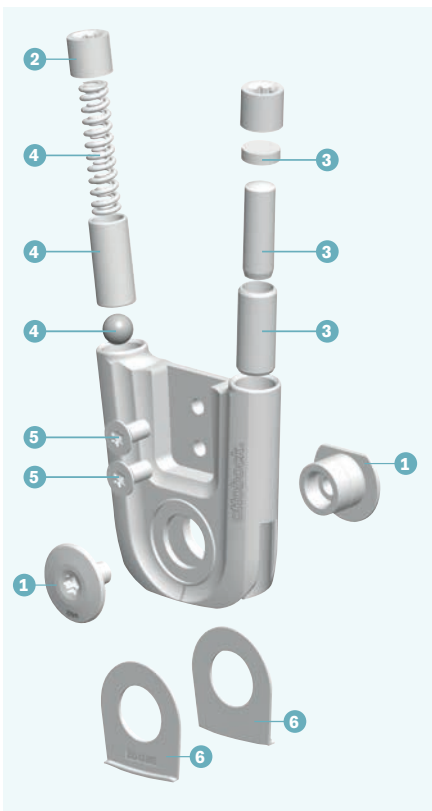

1) 17LA32N Spare part set screwing

Technical data

Article number	Spare part for	Quantity unit
17LA32N=10	17LA3N=10 17LA3N=10-T	Piece
17LA32N=12	17LA3N=12 17LA3N=12-T	Piece
17LA32N=14	17LA3N=14 17LA3N=14-T	Piece
17LA32N=16	17LA3N=16 17LA3N=16-T	Piece
17LA32N=20	17LA3N=20 17LA3N=20-T	Piece

2) 30Y309 Set screw

Technical data

Article number	Spare part for	Quantity unit
30Y309=12	17LA3N=14 17LA3N=14-T	Piece
30Y309=20	17LA3N=16 17LA3N=16-T 17LA3N=20 17LA3N=20-T	Piece

2) 30Y349 Set screw

Technical data

Article number	Spare part for	Quantity unit
30Y349=12	17LA3N=10 17LA3N=10-T 17LA3N=12 17LA3N=12-T	Piece

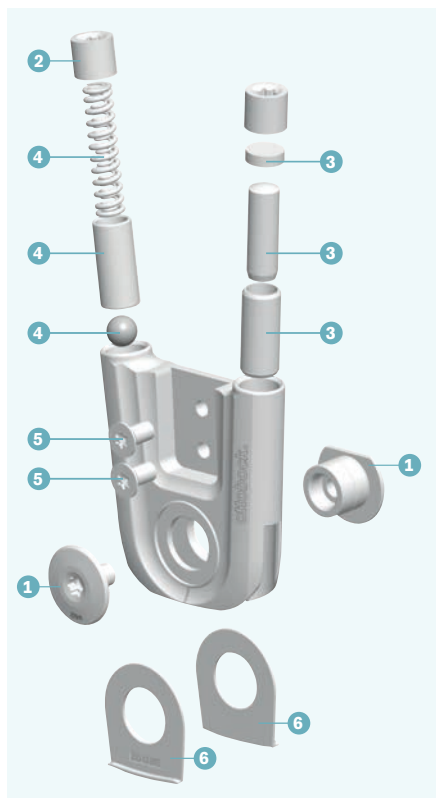

3) 17LA35N Adjustable stop

Technical data

Article number	for	Quantity unit
17LA35N=12	17LA3N=10 17LA3N=10-T 17LA3N=12 17LA3N=12-T	Piece
17LA35N=14	17LA3N=14 17LA3N=14-T	Piece
17LA35N=20	17LA3N=16 17LA3N=16-T 17LA3N=20 17LA3N=20-T	Piece

4) 17LA34N Compression spring set

Technical data

Article number	Spare part for	Quantity unit
17LA34N=12	17LA3N=10 17LA3N=10-T 17LA3N=12 17LA3N=12-T	Piece
17LA34N=14	17LA3N=14 17LA3N=14-T	Piece
17LA34N=16	17LA3N=16 17LA3N=16-T	Piece
17LA34N=20	17LA3N=20 17LA3N=20-T	Piece

5) 501S137 Countersunk head Torx screw

Technical data

Article number	Spare part for	Quantity unit
501S137=M4X8	17LA3N=10 17LA3N=10-T 17LA3N=12 17LA3N=12-T	Piece
501S137=M4X10-2	17LA3N=14 17LA3N=14-T	Piece
501S137=M5X10-1	17LA3N=16 17LA3N=16-T 17LA3N=20 17LA3N=20-T	Piece

6) 17LA33N Axial washers set

Technical data

Article number	Spare part for	Scope of delivery	Quantity unit
17LA33N=10	17LA3N=10 17LA3N=10-T	30Y344=10X0.70 30Y344=10X0.75 30Y344=10X0.80 30Y344=10X0.85 30Y344=10X0.90	Set
17LA33N=12	17LA3N=12 17LA3N=12-T	30Y305=12X0.70 30Y305=12X0.75 30Y305=12X0.80 30Y305=12X0.85 30Y305=12X0.90	Set
17LA33N=14	17LA3N=14 17LA3N=14-T	30Y305=14X0.85 30Y305=14X0.90 30Y305=14X0.95 30Y305=14X1.00 30Y305=14X1.05 30Y305=14X1.10	Set
17LA33N=16	17LA3N=16 17LA3N=16-T	30Y344=16X0.85 30Y344=16X0.90 30Y344=16X0.95 30Y344=16X1.00 30Y344=16X1.05 30Y344=16X1.10	Set
17LA33N=20	17LA3N=20 17LA3N=20-T	30Y305=20X0.85 30Y305=20X0.90 30Y305=20X0.95 30Y305=20X1.00 30Y305=20X1.05 30Y305=20X1.10	Set



17LD1N=*-P Dummy cover

Cover for 17LD1N lamination dummy

Technical data

Article number	Spare part for	Material	Quantity unit
17LD1N=10-P	17LA3N=10 17LA3N=10-T	Stainless steel	Piece
17LD1N=12-P	17LA3N=12 17LA3N=12-T	Stainless steel	Piece
17LD1N=14-P	17LA3N=14 17LA3N=14-T	Stainless steel	Piece
17LD1N=16-P	17LA3N=16 17LA3N=16-T	Stainless steel	Piece
17LD1N=20-P	17LA3N=20 17LA3N=20-T	Stainless steel	Piece

Accessory for 17LA3N



17LS3 Lamination bar

Lamination bar for unilateral and bilateral use for lamination resin or prepreg technique



Technical data

Article number	System width	Length	Thickness	Material	Quantity unit
17LS3=10	10 mm	80 mm	5 mm bottom/3 mm top	Stainless steel	Piece
17LS3=10-T	10 mm	80 mm	5 mm bottom/3 mm top	Titanium	Piece
17LS3=12	12 mm	80 mm	5 mm bottom/3 mm top	Stainless steel	Piece
17LS3=12-T	12 mm	80 mm	5 mm bottom/3 mm top	Titanium	Piece
17LS3=14	14 mm	100 mm	6 mm bottom/2.5 mm top	Stainless steel	Piece
17LS3=14-T	14 mm	100 mm	6 mm bottom/2.5 mm top	Titanium	Piece
17LS3=16	16 mm	130 mm	6 mm bottom/3 mm top	Stainless steel	Piece
17LS3=16-T	16 mm	130 mm	6 mm bottom/3 mm top	Titanium	Piece
17LS3=20	20 mm	130 mm	6 mm bottom/3 mm top	Stainless steel	Piece
17LS3=20-T	20 mm	130 mm	6 mm bottom, 3 mm top	Titanium	Piece

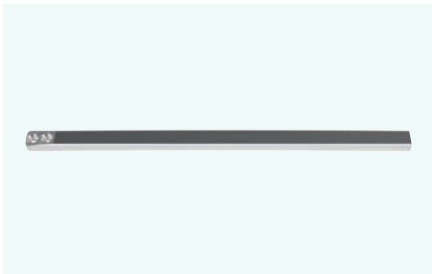

17LV3 Side bar

Side bar made of stainless steel for unilateral use for thermoplastic technique

Technical data

Article number	System width	Material	Quantity unit
17LV3=10	10 mm	Stainless steel	Piece
17LV3=12	12 mm	Stainless steel	Piece
17LV3=14	14 mm	Stainless steel	Piece
17LV3=16	16 mm	Stainless steel	Piece
17LV3=L-16	16 mm	Stainless steel	Piece
17LV3=R-16	16 mm	Stainless steel	Piece
17LV3=20	20 mm	Stainless steel	Piece
17LV3=L-20	20 mm	Stainless steel	Piece
17LV3=R-20	20 mm	Stainless steel	Piece



17LD1N Lamination dummy

Lamination dummy including shoulder screw for embedding the 17LA3N unilateral ankle joint.

Technical data

Article number	Accessory for	Material	Quantity unit
17LD1N=10	17LA3N=10 17LA3N=10-T	Stainless steel	Piece
17LD1N=12	17LA3N=12 17LA3N=12-T	Stainless steel	Piece
17LD1N=14	17LA3N=14 17LA3N=14-T	Stainless steel	Piece
17LD1N=16	17LA3N=16 17LA3N=16-T	Stainless steel	Piece
17LD1N=20	17LA3N=20 17LA3N=20-T	Stainless steel	Piece



702B11 Hole gauge

Hole gauge for 17LA3N and 17LK3

Technical data

Article number	Accessory for	Material
702B11	17LA3N=10 17LA3N=10-T 17LA3N=12 17LA3N=12-T 17LA3N=14 17LA3N=14-T 17LA3N=16 17LA3N=16-T 17LA3N=20 17LA3N=20-T	Tool steel



17LF3N Foot stirrup

Free motion up to 20° plantar flexion and 20° dorsal extension, only in combination with the 17LA3N=* orthotic ankle joint



Technical data

Article number	Accessory for	Material	Quantity unit
17LF3N=10	17LA3N=10 17LA3N=10-T	Stainless steel	Piece
17LF3N=12	17LA3N=12 17LA3N=12-T	Stainless steel	Piece
17LF3N=14	17LA3N=14 17LA3N=14-T	Stainless steel	Piece
17LF3N=16	17LA3N=16 17LA3N=16-T	Stainless steel	Piece
17LF3N=20	17LA3N=20 17LA3N=20-T	Stainless steel	Piece



17LF31N Foot stirrup thermoplastic for 17LA3N

Free motion up to 20° plantar flexion and 20° dorsal extension, only in combination with the 17LA3N=* orthotic ankle joint



Technical data

Article number	Accessory for	Material	Quantity unit
17LF31N=10	17LA3N=10 17LA3N=10-T	Stainless steel	Piece
17LF31N=12	17LA3N=12 17LA3N=12-T	Stainless steel	Piece
17LF31N=14	17LA3N=14 17LA3N=14-T	Stainless steel	Piece
17LF31N=16	17LA3N=16 17LA3N=16-T	Stainless steel	Piece
17LF31N=20	17LA3N=20 17LA3N=20-T	Stainless steel	Piece

Spare parts for 17LF3N, 17LF31N



30Y306 Plastic bushing

Bushing for 17LF3N, 17LF31N and 17SF100=OS foot stirrups

Technical data

Article number	Spare part for
30Y306=10	17LF3N=10 17LF31N=10
30Y306=12	17LF3N=12 17LF31N=12
30Y306=14	17LF3N=14 17LF31N=14
30Y306=16	17LF3N=16 17LF31N=16
30Y306=20	17LF3N=20 17LF31N=20

Unilateral Joint System. Order form.

Page 1/1

Contact person

Customer no.

Date

Customer

Company

Street

Postal code City

Email

Commision

Shipping address (if different from customer address)

Company

Street

Postal code City

Email

User information (optional)

Patient ID

Weight kg

Indication

Side Left Right

Maximum patient weight [kg]

	17LK3=10	17LK3=12	17LK3=14	17LK3=16	17LK3=20
Unilateral use (lateral or medial)	15	20	50	85	110
Bilateral use (lateral or medial)	25	40	80	120	160

The size chosen depends on the patient's weight and the conditions of use.

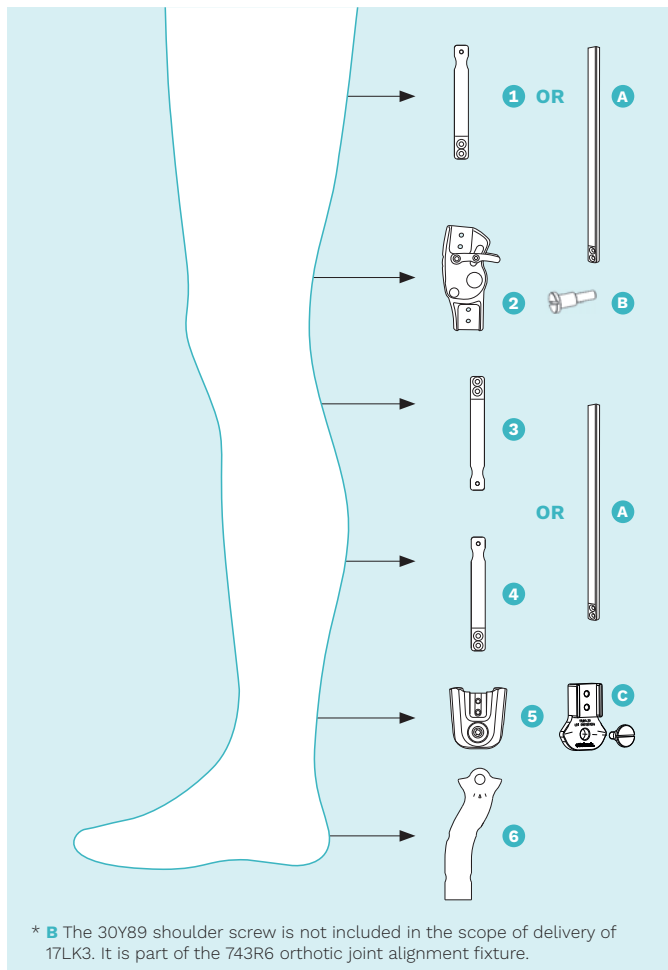

1 Lamination bar 17LS3=* OR

Steel version	Titanium version
<input type="radio"/> 17LS3=10	<input type="radio"/> 17LS3=10-T
<input type="radio"/> 17LS3=12	<input type="radio"/> 17LS3=12-T
<input type="radio"/> 17LS3=14	<input type="radio"/> 17LS3=14-T
<input type="radio"/> 17LS3=16	<input type="radio"/> 17LS3=16-T
<input type="radio"/> 17LS3=20	<input type="radio"/> 17LS3=20-T

A Extension bar 17LV3=* OR

Steel version
<input type="radio"/> 17LV3=10
<input type="radio"/> 17LV3=12
<input type="radio"/> 17LV3=14
<input type="radio"/> 17LV3=16
<input type="radio"/> 17LV3=20

2 Unilateral Knee Joint 17LK3=* OR

Steel version	Titanium version	Side	B Shoulder screw*
<input type="radio"/> 17LK3=12	<input type="radio"/> 17LK3=12-T	<input type="radio"/> L <input type="radio"/> R	<input type="radio"/> 30Y89
<input type="radio"/> 17LK3=14	<input type="radio"/> 17LK3=14-T	<input type="radio"/> L <input type="radio"/> R	<input type="radio"/> 30Y89
<input type="radio"/> 17LK3=16	<input type="radio"/> 17LK3=16-T	<input type="radio"/> L <input type="radio"/> R	<input type="radio"/> 30Y89
<input type="radio"/> 17LK3=20	<input type="radio"/> 17LK3=20-T	<input type="radio"/> L <input type="radio"/> R	<input type="radio"/> 30Y89

3, 4 Lamination bar 17LS3=* OR

Steel version	Titanium version
<input type="radio"/> 17LS3=10	<input type="radio"/> 17LS3=10-T
<input type="radio"/> 17LS3=12	<input type="radio"/> 17LS3=12-T
<input type="radio"/> 17LS3=14	<input type="radio"/> 17LS3=14-T
<input type="radio"/> 17LS3=16	<input type="radio"/> 17LS3=16-T
<input type="radio"/> 17LS3=20	<input type="radio"/> 17LS3=20-T

A Extension bar 17LV3=* OR

Steel version
<input type="radio"/> 17LV3=10
<input type="radio"/> 17LV3=12
<input type="radio"/> 17LV3=14
<input type="radio"/> 17LV3=16
<input type="radio"/> 17LV3=20

5 Unilateral Ankle Joint 17LA3N=* OR

Steel version	Titanium version
<input type="radio"/> 17LA3N=10	<input type="radio"/> 17LA3N=10-T
<input type="radio"/> 17LA3N=12	<input type="radio"/> 17LA3N=12-T
<input type="radio"/> 17LA3N=14	<input type="radio"/> 17LA3N=14-T
<input type="radio"/> 17LA3N=16	<input type="radio"/> 17LA3N=16-T
<input type="radio"/> 17LA3N=20	<input type="radio"/> 17LA3N=20-T

C Optional lamination dummy with shoulder screw

<input type="radio"/> 17LD1N=10
<input type="radio"/> 17LD1N=12
<input type="radio"/> 17LD1N=14
<input type="radio"/> 17LD1N=16
<input type="radio"/> 17LD1N=20

6 Foot stirrup (Steel) 17LF3N=* OR

<input type="radio"/> 17LF3N=10	<input type="radio"/> 17LF3N=14	<input type="radio"/> 17LF3N=20
<input type="radio"/> 17LF3N=12	<input type="radio"/> 17LF3N=16	

Date Place Signature



17AD200 Nexgear Sixty-six ankle

The multifunction system ankle joint has an impressive array of individual adjustment options. It supports the dorsiflexion function and can be locked on one or both sides and fitted as free-moving or spring-assisted.



Technical data

Article number	System width	Max. body weight	Material	Quantity unit
17AD200=10	10 mm	15 kg	Steel	Piece
17AD200=10-T	10 mm	15 kg	Titanium	Piece
17AD200=12	12 mm	20 kg	Steel	Piece
17AD200=12-T	12 mm	20 kg	Titanium	Piece
17AD200=14	14 mm	50 kg	Steel	Piece
17AD200=14-T	14 mm	50 kg	Titanium	Piece
17AD200=16	16 mm	85 kg	Steel	Piece
17AD200=16-T	16 mm	85 kg	Titanium	Piece
17AD200=20	20 mm	110 kg	Steel	Piece
17AD200=20-T	20 mm	110 kg	Titanium	Piece

- The 17AD200 Nexgear Sixty-six ankle is:
 - Only suitable for bilateral use (AFO/KAFO)
 - Only usable for orthoses without ischium bars
- It can be combined with:
 - 17KL100*, 17KF110*, 17KF210*, 17LK3*, 17B203*, 17B203* and 17B206* orthotic knee joints (note the instructions for use), 17SL100* lamination bars, 17SB100* side bars, 17SF200=OS-* and 17SF200=FT-* foot stirrups
- Only for processing with lamination technique when combined with the following orthotic joints:
 - 17LK3*, 17B203* E-MAG Active (with and without 17B206* support)
- The 17AD200 Nexgear Sixty-six ankle includes a compression spring, stops, spring stops and lamination dummy cover.
 - The following are not included in the scope of delivery and must be ordered separately:
 - 17SL100* lamination bars/17SB100* side bars and 17SF200=OS-* and 17SF200=FT-* foot stirrups
 - 17AD200A=DY-* lamination dummy set with dummy lower section and slotted oval head screw
 - 743R6 orthotic joint alignment set

Spare parts for 17AD200



17LA34N Compression spring set

Compression spring set for the 17LA3N unilateral joint system and the 17AD200 Nexgear Sixty-six ankle.

Technical data

Article number	Spare part for	Quantity unit
17LA34N=12	17AD200=10 17AD200=10-T 17AD200=12 17AD200=12-T 17AD200=14 17AD200=14-T	Piece
17LA34N=14	17AD200=16 17AD200=16-T 17AD200=20 17AD200=20-T	Piece

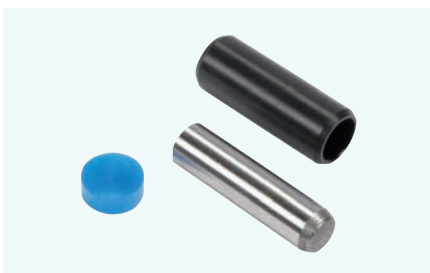

17LA35N Adjustable stop

Adjustable stop for the 17LA3N unilateral ankle joint and the 17AD200 Nexgear Sixty-six ankle.

Technical data

Article number	for	Quantity unit
17LA35N=12	17AD200=10 17AD200=10-T 17AD200=12 17AD200=12-T 17AD200=14 17AD200=14-T	Piece
17LA35N=14	17AD200=16 17AD200=16-T 17AD200=20 17AD200=20-T	Piece



17AD200S Lamination dummy cover

Spare part for 17AD200 Nexgear Sixty-six ankle. Lamination dummy cover with two blind caps.



Technical data

Article number	Spare part for	Quantity unit
17AD200S=DY-10-P	17AD200=10 17AD200=10-T	Piece
17AD200S=DY-12-P	17AD200=12 17AD200=12-T	Piece
17AD200S=DY-14-P	17AD200=14 17AD200=14-T	Piece
17AD200S=DY-16-P	17AD200=16 17AD200=16-T	Piece
17AD200S=DY-20-P	17AD200=20 17AD200=20-T	Piece

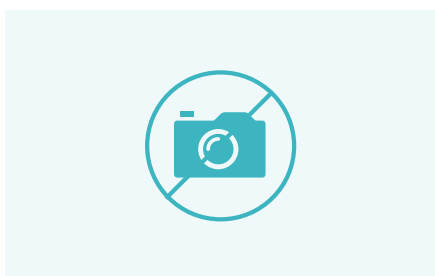

17AD200S Spare parts set screw connection

Spart parts set for 17AD200 Nexgear Sixty-six ankle including one joint screw and one bearing nut.

Technical data

Article number	Spare part for	Quantity unit
17AD200S=12	17AD200=10 17AD200=10-T 17AD200=12 17AD200=12-T 17AD200=14 17AD200=14-T	Piece
17AD200S=20	17AD200=16 17AD200=16-T 17AD200=20 17AD200=20-T	Piece

Accessory for 17AD200



17AD200A Dummy for 17AD200

Lamination dummy set for 17AD200 Nexgear Sixty-six ankle consisting of the lamination dummy lower section and slotted oval head screw.



Technical data

Article number	Accessory for	Quantity unit
17AD200A=DY-10	17AD200=10 17AD200=10-T	Piece
17AD200A=DY-12	17AD200=12 17AD200=12-T	Piece
17AD200A=DY-14	17AD200=14 17AD200=14-T	Piece
17AD200A=DY-16	17AD200=16 17AD200=16-T	Piece
17AD200A=DY-20	17AD200=20 17AD200=20-T	Piece



17SF200 Foot stirrup for 17AD200

Foot stirrup with bearing bush for the 17AD200 Nexgear Sixty-six ankle.



Technical data

Article number	System width	Length	Thickness	Material	Max. body weight	Side	Quantity unit
17SF200=FT-10	10 mm	57 mm	2,5 mm	Steel	15 kg	both sides	Piece
17SF200=FT-12	12 mm	60 mm	2,5 mm	Steel	20 kg	both sides	Piece
17SF200=FT-14	14 mm	62 mm	2,5 mm	Steel	50 kg	both sides	Piece
17SF200=FT-16	16 mm	65 mm	3 mm	Steel	85 kg	both sides	Piece
17SF200=FT-20	20 mm	65 mm	3 mm	Steel	110 kg	both sides	Piece
17SF200=OS-10	10 mm	80 mm	2,5 mm	Steel	15 kg	both sides	Piece
17SF200=OS-12	12 mm	85 mm	2,5 mm	Steel	20 kg	both sides	Piece
17SF200=OS-14	14 mm	85 mm	2,5 mm	Steel	50 kg	both sides	Piece
17SF200=OS-16	16 mm	100 mm	3 mm	Steel	85 kg	both sides	Piece
17SF200=OS-20	20 mm	120 mm	3 mm	Steel	110 kg	both sides	Piece

- Available versions: swung (OS) or forked (FT)
- Available sizes: 10, 12, 14, 16, 20
- Available sides: The foot stirrup can be used on the right or left side



17SL100 Nexgear lamination bars

The lamination bars are designed for combination with the 17AD200 Nexgear Sixty-six ankle and the 17KL100 Nexgear lock knee, 17KF110 Nexgear free knee and 17KF210 Nexgear posterior knee. They are intended exclusively for bilateral use and in the lamination or prepreg technique.



Technical data

Article number	Version	System width	Length	Thickness	Material	Max. body weight	Side	Quantity unit
17SL100=10	Without calf swing	10 mm	80 mm	3,5 mm	Steel	15 kg	both sides	Piece
17SL100=10-T	Without calf swing	10 mm	80 mm	3,5 mm	Titanium	15 kg	both sides	Piece
17SL100=12	Without calf swing	12 mm	80 mm	3,5 mm	Steel	20 kg	both sides	Piece
17SL100=12-T	Without calf swing	12 mm	80 mm	3,5 mm	Titanium	20 kg	both sides	Piece
17SL100=14	Without calf swing	14 mm	80 mm	3,5 mm	Steel	50 kg	both sides	Piece
17SL100=14-T	Without calf swing	14 mm	80 mm	3,5 mm	Titanium	50 kg	both sides	Piece
17SL100=16	Without calf swing	16 mm	100 mm	3,5 mm	Steel	85 kg	both sides	Piece
17SL100=16-T	Without calf swing	16 mm	100 mm	3,5 mm	Titanium	85 kg	both sides	Piece
17SL100=20	Without calf swing	20 mm	100 mm	3,5 mm	Steel	110 kg	both sides	Piece
17SL100=20-T	Without calf swing	20 mm	100 mm	3,5 mm	Titanium	110 kg	both sides	Piece
17SL100=10-*	With calf swing	10 mm	80 mm	3,5 mm	titanium (T), steel (-)	15 kg	left (L), right (R)	Piece
17SL100=12-*	With calf swing	12 mm	80 mm	3,5 mm	titanium (T), steel (-)	20 kg	left (L), right (R)	Piece
17SL100=14-*	With calf swing	14 mm	80 mm	3,5 mm	titanium (T), steel (-)	50 kg	left (L), right (R)	Piece
17SL100=16-*	With calf swing	16 mm	100 mm	3,5 mm	titanium (T), steel (-)	85 kg	left (L), right (R)	Piece
17SL100=20-*	With calf swing	20 mm	100 mm	3,5 mm	titanium (T), steel (-)	110 kg	left (L), right (R)	Piece

- Available versions: With or without calf swing
- Available sizes: 10, 12, 14, 16, 20
- Available materials: titanium (T), steel (-)
- Available sides (for variants with calf swing): right (R), left (L)
- The variants without calf swing can be used in a side-neutral way

Order example for lamination bar with calf swing

Reference number	System width	Side	Material
17SL100	= 12	- L	
Lamination bar with calf swing	12	left	steel
17SL100	= 16	- R	- T
Lamination bar with calf swing	16	right	titanium



17SB100 Nexgear side bars

The side bars are designed for combination with the 17AD200 Nexgear Sixty-six ankle and the 17KL100 Nexgear lock knee, 17KF110 Nexgear free knee and 17KF210 Nexgear posterior knee. They are intended exclusively for bilateral use and in the thermoplastic or bar-clamp technique.

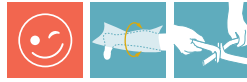

Technical data

Article number	Version	System width	Length	Thickness	Material	Max. body weight	Side	Quantity unit
17SB100=10	Without calf swing	10 mm	270 mm	3,5 mm	Steel	15 kg	both sides	Piece
17SB100=12	Without calf swing	12 mm	300 mm	3,5 mm	Steel	20 kg	both sides	Piece
17SB100=12-A	Without calf swing	12 mm	300 mm	5 mm	Aluminium	15 kg	both sides	Piece
17SB100=14	Without calf swing	14 mm	400 mm	3,5 mm	Steel	50 kg	both sides	Piece
17SB100=14-A	Without calf swing	14 mm	400 mm	6 mm	Aluminium	20 kg	both sides	Piece
17SB100=16	Without calf swing	16 mm	450 mm	3,5 mm	Steel	85 kg	both sides	Piece
17SB100=16-A	Without calf swing	16 mm	450 mm	6 mm	Aluminium	50 kg	both sides	Piece
17SB100=20	Without calf swing	20 mm	470 mm	3,5 mm	Steel	110 kg	both sides	Piece
17SB100=20-A	Without calf swing	20 mm	470 mm	6 mm	Aluminium	85 kg	both sides	Piece
17SB100=10-L	With calf swing	10 mm	270 mm	3,5 mm	Steel	15 kg	left	Piece
17SB100=10-R	With calf swing	10 mm	270 mm	3,5 mm	Steel	15 kg	right	Piece
17SB100=12-L	With calf swing	12 mm	300 mm	3,5 mm	Steel	20 kg	left	Piece
17SB100=12-R	With calf swing	12 mm	300 mm	3,5 mm	Steel	20 kg	right	Piece
17SB100=14-L	With calf swing	14 mm	400 mm	3,5 mm	Steel	50 kg	left	Piece
17SB100=14-R	With calf swing	14 mm	400 mm	3,5 mm	Steel	50 kg	right	Piece
17SB100=16-L	With calf swing	16 mm	450 mm	3,5 mm	Steel	85 kg	left	Piece
17SB100=16-R	With calf swing	16 mm	450 mm	3,5 mm	Steel	85 kg	right	Piece
17SB100=20-L	With calf swing	20 mm	470 mm	3,5 mm	Steel	110 kg	left	Piece
17SB100=20-R	With calf swing	20 mm	470 mm	3,5 mm	Steel	110 kg	right	Piece

- Available versions: With or without calf swing
- Available sizes: 10, 12, 14, 16, 20
- Variants without calf swing in aluminum not available in size 10. Note the deviating weight limits for sizes 12, 14, 16, 20.
- Available materials: Steel (-), Variants without calf swing: Steel (-), aluminium (A)
- Available sides (for variants with calf swing): right (R), left (L)
- Variants without calf swing can be used in a side-neutral way.



17AO100 Unilateral C-Brace ankle joint

The 17AO100 unilateral ankle joint is a multifunction system ankle joint with a dorsiflexion effect. It is approved only in combination with the C-Brace.



Technical data

Article number	Bar width	Max. body weight
17AO100=22-T	22 mm	110 kg

Scope of delivery

17AO100=22-T	Unilateral C-Brace ankle joint	1	Piece(s)
17S100=LB-22-T	C-Brace lamination bar	1	Piece(s)
17SF100=OS-22	Ankle stirrup	1	Piece(s)
17LD1N=22-P	Dummy cover	1	Piece(s)
17LA33N=20	Axial washers set	1	Piece(s)
17AO100S=22-1	Service set screw connection	1	Piece(s)
17AO100S=22-2	Service set spring	1	Piece(s)
17AO100S=22-3	Service set bumpers	1	Piece(s)
30Y450=22	Grub screw	1	Piece(s)
501S136=M6X12-1	Oval head Torx screw	1	Piece(s)

Spare parts for 17AO100



17LD1N Lamination dummy

Lamination dummy including shoulder screw for embedding the 17LA3N unilateral ankle joint.

Technical data

Article number	Spare part for	Material	Quantity unit
17LD1N=22	17AO100=22-T	Stainless steel	Piece



17LD1N=*-P Dummy cover

Cover for 17LD1N lamination dummy

Technical data

Article number	Spare part for	Material	Quantity unit
17LD1N=22-P	17AO100=22-T	Stainless steel	Piece



17S100 C-Brace lamination bar

Lamination bar for the 17AO100 C-Brace ankle joint

Technical data

Article number	Quantity unit
17S100=LB-22-T	Piece



17LA33N Axial washers set

Set of axial washers for the unilateral ankle joints 17LA3N and 17AO100

Technical data

Article number	Spare part for	Scope of delivery	Quantity unit
17LA33N=20	17AO100=22-T	1 × 30Y305=20X0.85 1 × 30Y305=20X0.90 1 × 30Y305=20X0.95 1 × 30Y305=20X1.00 1 × 30Y305=20X1.05 1 × 30Y305=20X1.10	Set



17AO100S Service set

Service sets for the unilateral 17AO100 C-Brace ankle joint

Technical data

Article image	Description	Article number
	Service set screw connection	17AO100S=22-1
	Service set spring	17AO100S=22-2
	Service set bumpers	17AO100S=22-3



17SF100=OS* Ankle stirrup

Foot stirrup for the 17AO100 C-Brace ankle joint

Technical data

Article number
17SF100=OS-22



501S136 Oval head Torx screw

Oval head Torx screw for unilateral 17AO100 C-Brace ankle joint

Technical data

Article number
501S136=M6X12-1



Unilateral
17AD300
17AD302
17AD303

Unilateral
17AD300
17AD302
17AD304

17SF300

17LS3

Bilateral
17AD300
17AD302
17AD303

Bilateral
17AD300
17AD302
17AD304

17SF300

17LS3

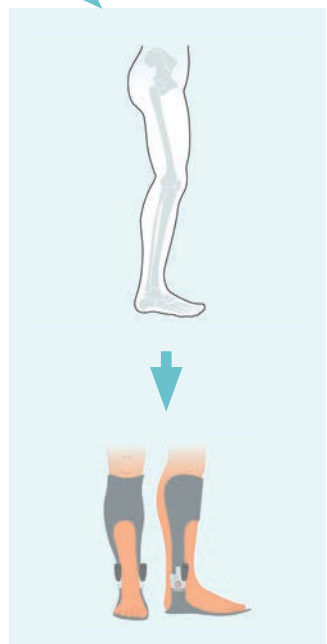
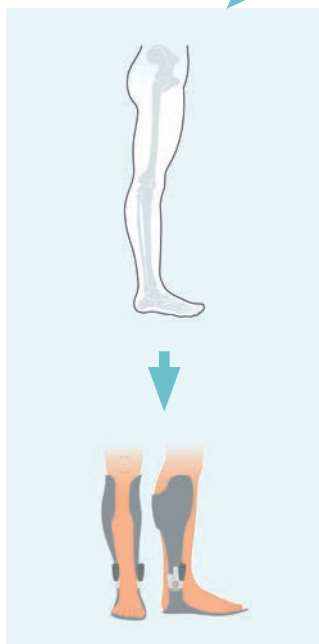
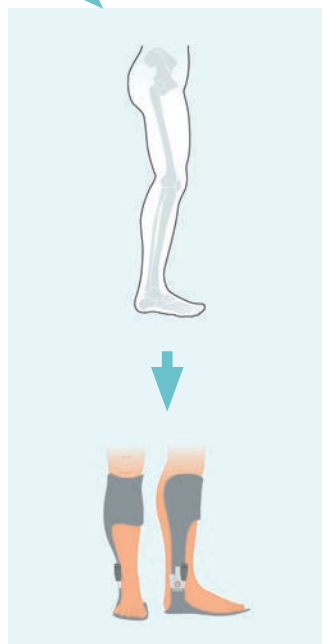
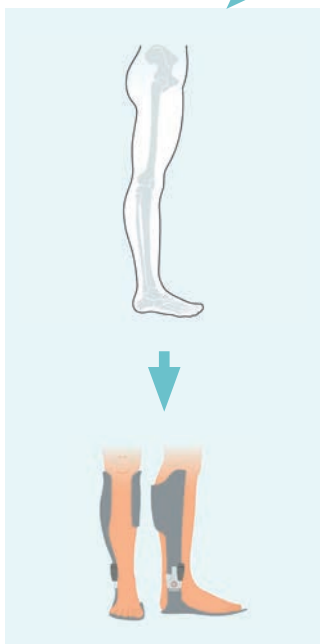

Selection guide Nexgear Tango ankle

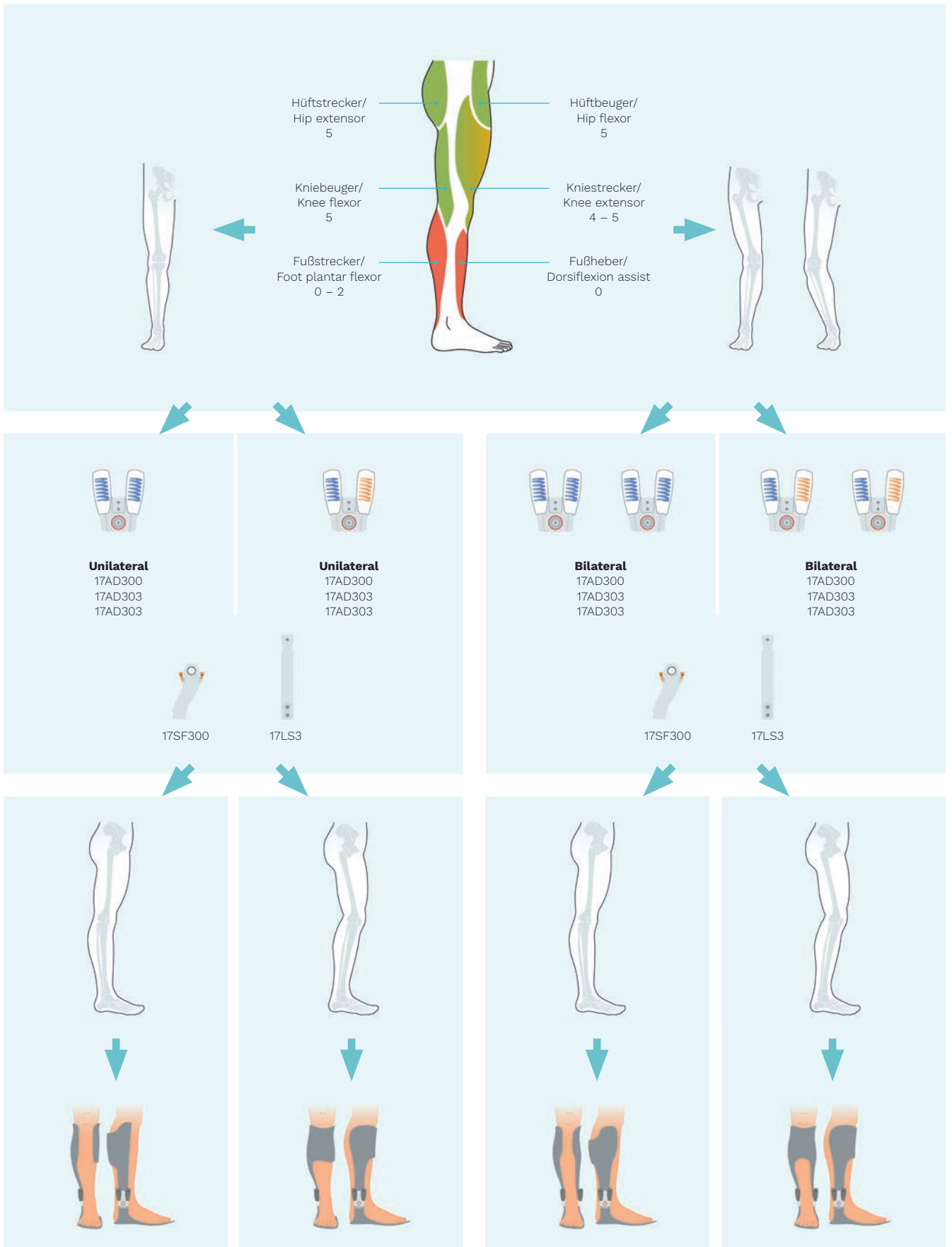

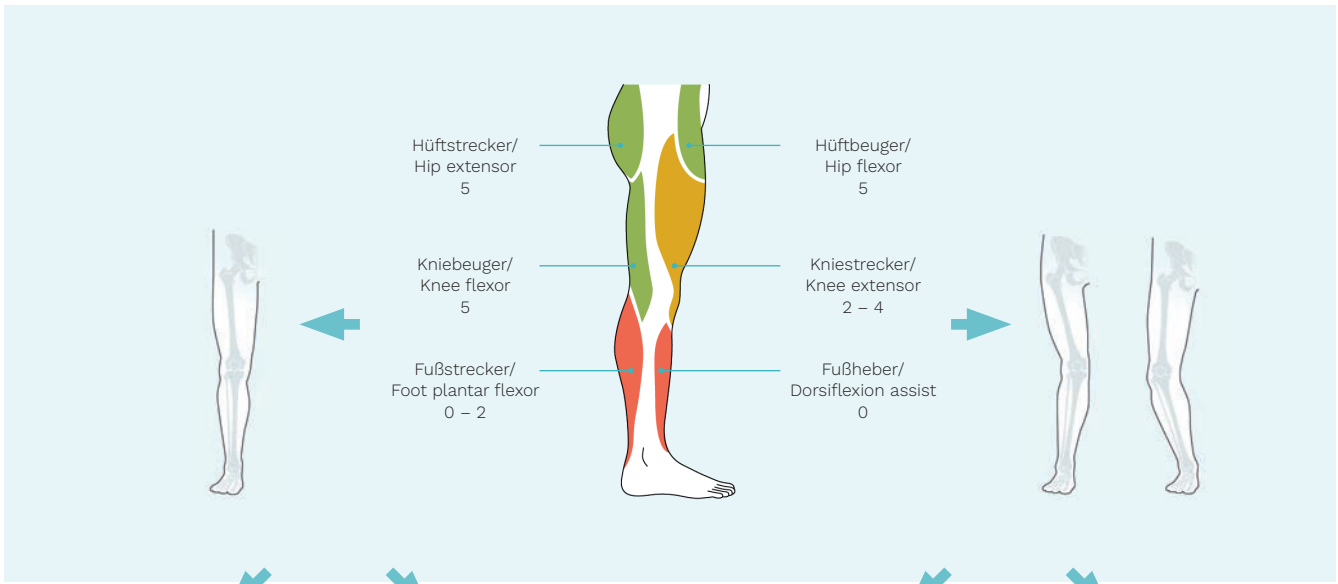

Unilateral
17AD300
17AD303
17AD303

Unilateral
17AD300
17AD303
17AD304

17SF300 17LS3

Bilateral
17AD300
17AD303
17AD303

Bilateral
17AD300
17AD303
17AD304

17SF300 17LS3

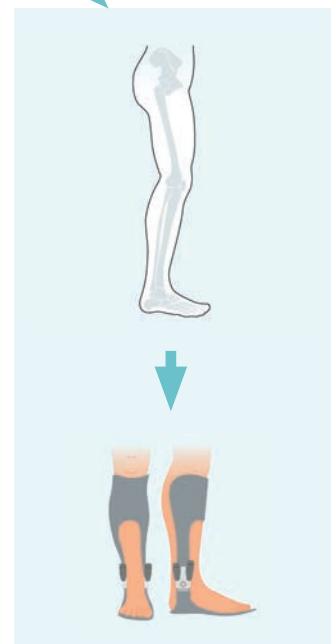
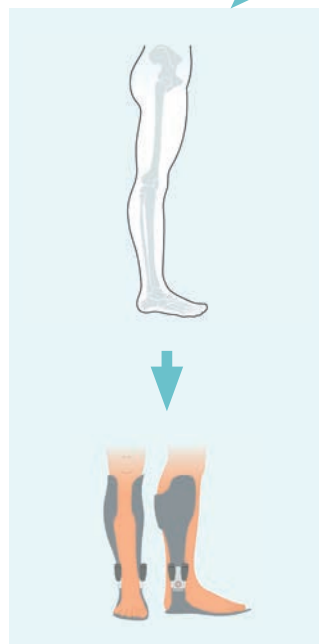
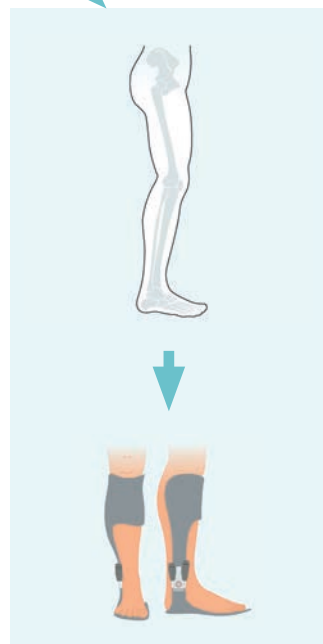
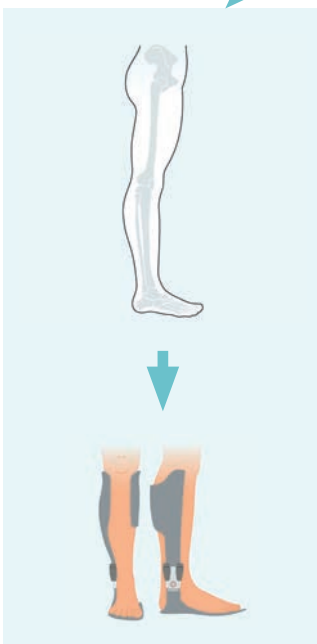



Nexgear Tango ankle

The Nexgear Tango is a modular system ankle joint with comparatively high energy return. The four function modules ensure the configuration is able to be adapted to the user's needs.

Features and benefits

- Double action ankle joint with four function modules (Stop-module, Spring-module, Reaction-module and Ultra-module) for dorsal and ventral use.
- For unilateral and bilateral fittings
- For adults and children, selection by weight classification
- Adaptability throughout the entire rehabilitation process thanks to modules that can be added and removed (modular design)
- Static alignment and dynamic adjustment (pretension) are carried out independently
- Serviceable stirrup thanks to replaceable shim plates
- A sustainable dummy concept with reusable steel dummies creates less waste
- Cushioning and a spring-mounted stop ensure that the joint stops silently
- Enables the patient to walk more smoothly and more physiologically
- Base body available in titanium and steel
- Making use of the titanium Tango joint reduces the weight of the orthosis

· Please order the separate components according to the individual needs of your patient.

Components for Nexgear Tango ankle



17AD300 Base body

Base body for Nexgear Tango ankle



Technical data

Article number	System width	Max. body weight	Side	Material	Quantity unit
17AD300=14-ST	14 mm	50 kg (unilateral) / 80 kg (bilateral)	both sides	Steel	Piece
17AD300=14-T	14 mm	50 kg (unilateral) / 80 kg (bilateral)	both sides	Titanium	Piece
17AD300=16-ST	16 mm	85 kg (unilateral) / 120 kg (bilateral)	both sides	Steel	Piece
17AD300=16-T	16 mm	85 kg (unilateral) / 120 kg (bilateral)	both sides	Titanium	Piece
17AD300=20-ST	20 mm	110 kg (unilateral) / 160 kg (bilateral)	both sides	Steel	Piece
17AD300=20-T	20 mm	110 kg (unilateral) / 160 kg (bilateral)	both sides	Titanium	Piece

- The weight classification permits unilateral use for a user body weight of up to 110 kg and bilateral use for up to 160 kg.
- The 17AD300 Nexgear Tango ankle joint can be combined with:
 - 17K01=* C-Brace
 - 17B203=* E-MAG Active
 - 17KF110=* Nexgear free knee
 - 17KF210=* Nexgear posterior knee
 - 17KL100=* Nexgear lock knee
 - 17LK3=* Unilateral knee joint
 - 17SF300=* Foot stirrup
 - 17LS3=* Lamination bar
- For unilateral use, the manufacturer recommends using the lamination or prepreg technique to process the orthotic joint.
- The joint is to be used bilaterally in orthoses with ischial support.
- Use the next size up for unilateral fitting in cases involving:
 - Flexion contracture in the knee or hip > 10°
 - Pronounced torsion
 - Varus/valgus instability
 - Intense physical activity
- The 17AD300 Nexgear Tango ankle joint includes the joint base body, the appropriate screws and blind caps, the axial washers and an upper (part) lamination dummy.
- The following are not included in the scope of delivery and must be ordered separately:
 - 17AD301=* Stop-module
 - 17AD302=* Spring-module
 - 17AD303=* Reaction-module
 - 17AD304=* Ultra-module (only available for sizes 16 and 20)
 - 17AD305=* Reaction-spring, blue (strong)
 - 17AD306=* Reaction-spring, yellow (extra strong)
 - 17AD307=* Ultra-spring, grey (ultra-strong, only available for sizes 16 and 20)
 - 17AD308=* Spring dummy set
 - 17AD310=* Shaping dummy set
 - 17AD312=* Assembly tool set for 17SF300
 - 17AD313=* Lamination dummy set
 - 17LS3=* Lamination bar
 - 17SF300=* Foot stirrup, straight
- Optional accessories:
 - 17AD309=* Tool set for dynamic adjustment of Reaction- and Ultra-modules
 - 17AT1=1 Test brace set (in combination with 17AT3=1 Fit Kit)
 - 17AT2=* Test braces (in combination with 17AT3=1 Fit Kit)
 - 17AT3=1 Fit Kit for 17AD300
 - 17AT4=1 Dummy kit for 17AD300 (also available in 17MK1=1 Nexgear set of dummies)

Spare parts for 17AD300



17AD314 Lamination dummy upper part

Lamination dummy upper section for 17AD300 Nexgear Tango ankle. Spare part.



Technical data

Article number	Side	Spare part for	Quantity unit
17AD314=14	both sides	17AD300=14-*	Piece
17AD314=16	both sides	17AD300=16-*	Piece
17AD314=20	both sides	17AD300=20-*	Piece

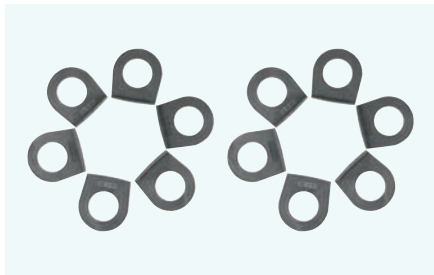

17AD315 Set axial washers for 17AD300

Axial washers set with twelve axial washers, six sizes each in two versions for 17AD300 Nexgear Tango ankle. Spare part.

Technical data

Article number	Side	Spare parts for	Quantity unit
17AD315=14	both sides	17AD300=14-*	Piece
17AD315=16	both sides	17AD300=16-*	Piece
17AD315=20	both sides	17AD300=20-*	Piece

Components for Nexgear Tango ankle



17AD301 Stop-module for 17AD300

Stop-module for the 17AD300 Nexgear Tango ankle. The set consists of stop pin, stop bolt, spring, screw-in sleeve and cover.

Technical data

Article number	System width	Max. body weight	Side	Component for	Quantity unit
17AD301=14	14 mm	50 kg (unilateral) / 80 kg (bilateral)	both sides	17AD300=14-*	Piece
17AD301=16	16 mm	85 kg (unilateral) / 120 kg (bilateral)	both sides	17AD300=16-*	Piece
17AD301=20	20 mm	110 kg (unilateral) / 160 kg (bilateral)	both sides	17AD300=20-*	Piece

* You can use the module for the adjustable stop to set a continuously variable dorsal or plantar stop.

Spare parts for 17AD301



17AD318 Service set for 17AD301

Service set for the 17AD301 Stop-module for 17AD300 Nexgear Tango ankle.

The set consists of spring, stop bolt and a sleeve for the stop pin.

Technical data

Article number	Side	Spare part for	Quantity unit
17AD318=14	both sides	17AD301=14	Piece
17AD318=20	both sides	17AD301=16 17AD301=20	Piece

Components for Nexgear Tango ankle



17AD302 Spring-module for 17AD300

Spring-module for the 17AD300 Nexgear Tango ankle. The set consists of compression spring, spring sleeve, ball, screw-in sleeve, set screw and cover.

Technical data

Article number	System width	Max. body weight	Side	Component for	Quantity unit
17AD302=14	14 mm	50 kg (unilateral) / 80 kg (bilateral)	both sides	17AD300=14-*	Piece
17AD302=16	16 mm	85 kg (unilateral) / 120 kg (bilateral)	both sides	17AD300=16-*	Piece
17AD302=20	20 mm	110 kg (unilateral) / 160 kg (bilateral)	both sides	17AD300=20-*	Piece



17AD303 Reaction-module for 17AD300

Reaction-module for the 17AD300 Nexgear Tango ankle. The set consists of cover and cover cap, spring, spring seat, spring and counter screw, screw-in sleeve and stop bolt.

Technical data

Article number	System width	Max. body weight	Side	Component for	Quantity unit
17AD303=14	14 mm	50 kg (unilateral) / 80 kg (bilateral)	both sides	17AD300=14-*	Piece
17AD303=16	16 mm	85 kg (unilateral) / 120 kg (bilateral)	both sides	17AD300=16-*	Piece
17AD303=20	20 mm	110 kg (unilateral) / 160 kg (bilateral)	both sides	17AD300=20-*	Piece

* The Reaction-springs 17AD305 (blue, strong) and 17AD306 (yellow, extra strong) are available as accessories and must be ordered separately.



17AD304 Ultra-module for 17AD300

Ultra-module for the 17AD300 Nexgear Tango ankle. The set consists of cover and cover cap, spring, spring seat, spring and counter screw, screw-in sleeve and stop bolt.

Technical data

Article number	System width	Max. body weight	Side	Component for	Quantity unit
17AD304=16	16 mm	85 kg (unilateral) / 120 kg (bilateral)	both sides	17AD300=16-*	Piece
17AD304=20	20 mm	110 kg (unilateral) / 160 kg (bilateral)	both sides	17AD300=20-*	Piece

* The Ultra-module is available exclusively for sizes 16 and 20 of the 17AD300 Nexgear Tango ankle.
* The Ultra-spring 17AD304 (grey, ultra strong) is available as an accessory and must be ordered separately.

Spare parts for 17AD303/17AD304



17AD317 Service set for 17AD303 and 17AD304

Service set for 17AD303 Reaction-module and 17AD304 Ultra-module for 17AD300 Nexgear Tango ankle.

The set consists of spring, sleeve for stop pin, stop bolt and counter screw.

Technical data

Article number	Side	Spare part for	Quantity unit
17AD317=14	both sides	17AD303=14 17AD304=14	Piece
17AD317=16	both sides	17AD303=16 17AD304=16	Piece
17AD317=20	both sides	17AD303=20 17AD304=20	Piece

Components for Nexgear Tango ankle



17AD305 Reaction-spring for 17AD300, strong

Reaction-spring, strong, for the 17AD303 Reaction-module. The Reaction-spring is available in sizes 14 and 20.

Technical data

Article number	Side	Component for	Quantity unit
17AD305=14	both sides	17AD303=14	Piece
17AD305=20	both sides	17AD303=16 17AD303=20	Piece



17AD306 Reaction-spring for 17AD300, extra strong

Reaction-spring, extra strong, for the 17AD303 Reaction-module. The Reaction-spring is available in sizes 14 and 20.

Technical data

Article number	Side	Component for	Quantity unit
17AD306=14	both sides	17AD303=14	Piece
17AD306=20	both sides	17AD303=16 17AD303=20	Piece



17AD307 Ultra-spring for 17AD300

Ultra-spring, ultra strong, for the 17AD304 Ultra-module. The Ultra-spring is available in size 20. It provides approximately double the spring rate as the yellow Reaction-spring (extra strong).

Technical data

Article number	Side	Component for	Quantity unit
17AD307=20	both sides	17AD304=16 17AD304=20	Piece



17AD308 Tool kit static alignment

Spring dummy set for the 17AD300 Nexgear Tango ankle. The set consists of a mounting adapter and a spring dummy for the Reaction-module as well as two guide screws. The size 20 version of the set also features a mounting adapter and a spring dummy for the Ultra-module.

Technical data

Article number	Side	Accessory for	Quantity unit
17AD308=14	both sides	17AD300=14-*	Piece
17AD308=20	both sides	17AD300=16-* 17AD300=20-*	Piece



17AD310 Shaping dummy set

Shaping dummy set for exact lamination on the modules of the 17AD300 Nexgear Tango ankle. The set contains: One lower section of shaping dummy, left and right upper section of the shaping dummy for the 17AD300 Nexgear Tango ankle (base body), two shaping dummy upper sections for the 17AD303 Reaction-module, two shaping dummy upper sections for the 17AD304 Ultra-module and countersunk screws.

Technical data

Article number	Side	Accessory for	Quantity unit
17AD310=14	both sides	17AD300=14-*	Piece
17AD310=16	both sides	17AD300=16-*	Piece
17AD310=20	both sides	17AD300=20-*	Piece

* Optional accessory. When the Reaction- and/or Ultra-module is used, the manufacturer recommends using the shaping dummy set for determining the space that the modules will require later and for shaping on the orthosis model.



17AD312 Assembly tool set for 17SF300

Assembly tool set for 17SF300 foot stirrup (sizes 14, 16 and 20) for 17AD300 Nexgear Tango ankle. The set consists of the upper and lower section of the tool, fixing screw for upper section with lower section, cotter pin drive for the roll pin and hex bit T8.

Technical data

Article number	Side	Accessory for	Quantity unit
17AD312=20	both sides	17SF300=* 17AD300=14-*	Piece



17AD313 Lamination dummy set for 17AD300

Lamination dummy set for the 17AD300 Nexgear Tango ankle. The set contains a lamination dummy lower section and slotted oval head screw. The set also includes an insertion aid for fitting the joint nut for the joint.



Technical data

Article number	Side	Accessory for	Quantity unit
17AD313=14	both sides	17AD300=14-*	Piece
17AD313=16	both sides	17AD300=16-*	Piece
17AD313=20	both sides	17AD300=20-*	Piece

- The lamination dummy set is an essential requirement for producing the orthosis.
- The lamination dummy upper section is not included, but contained in the scope of supply of the 17AD300.



17SF300 Foot stirrup for 17AD300

Foot stirrup with bearing bush for the 17AD300 Nexgear Tango ankle plus two wear plates, four dowel pins and two fixing screws.

Technical data

Article number	System width	Accessory for	Quantity unit
17SF300=N-14	14 mm	17AD300=14-*	Piece
17SF300=N-16	16 mm	17AD300=16-*	Piece
17SF300=N-20	20 mm	17AD300=20-*	Piece

Spare parts for 17SF300



17AD316 Service set for 17SF300

Service set for 17SF300 foot stirrup for 17AD300 Nexgear Tango ankle.

The set consists of two wear plates, four roll pins and two fixing screws for the wear plates and a bearing bush.

Technical data

Article number	Side	Accessory for	Quantity unit
17AD316=14	both sides	17SF300=N-14	Piece
17AD316=16	both sides	17SF300=N-16	Piece
17AD316=20	both sides	17SF300=N-20	Piece

Component for 17AD300



17LS3 Lamination bar

Lamination bar for unilateral and bilateral use for lamination resin or prepreg technique



Technical data

Article number	System width	Length	Thickness	Material	Quantity unit
17LS3=10	10 mm	80 mm	5 mm bottom/3 mm top	Stainless steel	Piece
17LS3=10-T	10 mm	80 mm	5 mm bottom/3 mm top	Titanium	Piece
17LS3=12	12 mm	80 mm	5 mm bottom/3 mm top	Stainless steel	Piece
17LS3=12-T	12 mm	80 mm	5 mm bottom/3 mm top	Titanium	Piece
17LS3=14	14 mm	100 mm	6 mm bottom/2.5 mm top	Stainless steel	Piece
17LS3=14-T	14 mm	100 mm	6 mm bottom/2.5 mm top	Titanium	Piece
17LS3=16	16 mm	130 mm	6 mm bottom/3 mm top	Stainless steel	Piece
17LS3=16-T	16 mm	130 mm	6 mm bottom/3 mm top	Titanium	Piece
17LS3=20	20 mm	130 mm	6 mm bottom/3 mm top	Stainless steel	Piece
17LS3=20-T	20 mm	130 mm	6 mm bottom, 3 mm top	Titanium	Piece

Accessories for Nexgear Tango ankle



17AD309 Tool set for dynamic adjustment

Tool set for the dynamic adjustment of the Reaction- and Ultra-modules in all sizes for the Nexgear Tango ankle. The set includes two socket wrench inserts (sizes 20 and 24), a 1/4 to 1/2 inch adapter, a Torx angle wrench (T50), two hexagon inserts (bits, 2.5 mm and 3 mm).

Technical data

Article number	Side	Accessory for	Quantity unit
17AD309=20	both sides	17AD303=* 17AD304=*	Piece



17AT1 Test brace set for 17AD300

Test brace set for 17AD300 consisting of 4 orthoses and 2 foot components. The 17AT1 test brace set contains various test braces and makes it possible to try out the 17AD300 Nexgear Tango ankle on the patient under professional supervision. Different configurations can be tested with additional use of the 17AT3 Fit-Kit, which contains all available modules for the Tango ankle joint (ultra, reaction, spring and stop modules) as well as the tools required to adjust them.

Technical data

Article number	Accessory for	Side	Shoe size Europe	Quantity unit
17AT1=1	17AD300	left, right	36-45	Piece

- The 17AT2* test braces included may only be used on the patient for test purposes and under the supervision of qualified personnel.
- They can be used for patients weighing up to 110 kg with shoe sizes 36-45. The selection is made based on shoe size and body weight. (see below)
- The scope of delivery includes:
 - Two 17AT2 test braces, left/right, equipped with the 17AD300 Nexgear Tango ankle in size 14 (Shoe size 36-41, maximum body weight 50 kg)
 - Two 17AT2 test braces, left/right, equipped with the 17AD300 Nexgear Tango ankle in size 20 (Shoe size 42-45, maximum body weight 110 kg)
 - Two smaller 29F209=L/R-20-2 foot components with integrated foot stirrup, which can be replaced with the larger foot components in the size 20 test braces if needed (shoe size 36-41, max. body weight 85 kg)
 - Four 29U91 pads (size 14 and 20)
- The following is not included in the scope of delivery and must be ordered separately:
 - 17AT3=1 Fit-Kit for 17AD300
- The foot component of the test braces in size 20 (17AT2=L-20-1 and 17AT2=R-20-1) can be replaced with the enclosed smaller foot component with integrated foot stirrup (29F209=L/R-20-2) depending on the shoe size and body weight of the patient.



17AT2 Test brace for 17AD300

The 17AT2 test brace makes it possible to try out the 17AD300 Nexgear Tango ankle on the patient under professional supervision. Different configurations can be tested with additional use of the 17AT3 Fit-Kit, which contains all available modules for the Tango ankle joint (ultra, reaction, spring and stop modules) as well as the tools required to adjust them.

Technical data

Article number	Accessory for	Side	Shoe size Europe	Max. body weight	Quantity unit
17AT2=L-14-1	17AD300	left (L)	36 - 41	50 kg	Piece
17AT2=R-14-1	17AD300	right (R)	36 - 41	50 kg	Piece
17AT2=L-20-2	17AD300	left (L)	36 - 41	85 kg	Piece
17AT2=R-20-2	17AD300	right (R)	36 - 41	85 kg	Piece
17AT2=L-20-1	17AD300	left (L)	42 - 45	110 kg	Piece
17AT2=R-20-1	17AD300	right (R)	42 - 45	110 kg	Piece

- The scope of delivery includes in each case:
 - 1 test brace
 - 1 compatible 29U91 pad
- The following is not included in the scope of delivery and must be ordered separately:
 - 17AT3=1 Fit-Kit for 17AD300

Spare parts for 17AT1/17AT2



29F209 Foot part

Foot component for 17AT2=* test brace for 17AD300 including axial washers set. Spare part.

Technical data

Article number	Spare part for	Quantity unit
29F209=L-14-1	17AT2=L-14-1	Piece
29F209=R-14-1	17AT2=R-14-1	Piece
29F209=L-20-1	17AT2=L-20-1	Piece
29F209=R-20-1	17AT2=R-20-1	Piece
29F209=L-20-2	17AT2=L-20-2	Piece
29F209=R-20-2	17AT2=R-20-2	Piece



29U91 Cover for 17AT2

Pad for 17AT2=* test orthosis for 17AD300. Spare part.

Technical data

Article number	Spare part for	Quantity unit
29U91=L-14	17AT2=L-14-1	Piece
29U91=R-14	17AT2=R-14-1	Piece
29U91=L-20	17AT2=L-20-1 17AT2=L-20-2	Piece
29U91=R-20	17AT2=R-20-1 17AT2=R-20-2	Piece



29U25 Y-hook-and-loop

Y-hook-and-loop closure for pad. Spare part for dynamic ankle-foot orthoses in the WalkOn product range, for 28U70 GoOn and for 17AT1/17AT2 test orthoses.

Technical data

Article number	Size	For belt width	Quantity unit
29U25=1	1	58 mm	Piece
29U25=2	2	45 mm	Piece
29U25=3	3	35 mm	Piece

· Measure the belt width to select the appropriate closure size.



17AT3 Fit-Kit for 17AD300

The 17AT3 Fit-Kit for the 17AD300 Nexgear Tango ankle and the 17AT2 Tango test braces are used to determine a patient-specific configuration of the joint. The Fit-Kit contains the modules (Ultra-, Reaction-, stop- and spring modules), and the tools required to adjust them.

Technical data

Article number	Accessories for	Quantity unit
17AT3=1	17AD300=*	Piece

- The scope of supply includes 2 of each module per size:
 - Stop-module 17AD301 (sizes 14, 16, 20)
 - Spring-module 17AD302 (sizes 14, 16, 20)
 - Reaction-module 17AD303 (sizes 14, 16, 20)
 - Ultra-module 17AD304 (sizes 16, 20)
 - Tool set 17AD309 for 17AD303 Reaction-modules and 17AD304 Ultra-modules
 - 16 compression springs 17AD305/17AD306/17AD307 (strong, extra-strong, ultra)
 - 10 spring dummies
 - 5 assembly aids
 - 10 knurled screws



17AT4 Dummy-Kit for 17AD300 Nexgear Tango ankle

Dummy-Kit for the 17AD300 Nexgear Tango ankle.

The tool case contains:

- 17AD310 Shaping dummies (sizes 14, 16 und 20)
- 17AD312 Assembly tool for foot stirrup 17SF300
- 17AD313 Lamination dummy set (sizes 14, 16 und 20)

Technical data

Article number	Accessory for	Quantity unit
17AT4=1	17AD300=*	Piece

17AD300 Nexgear Tango ankle. Order form.

Page 1/2

Contact person

Customer no.

Date

Customer

Company

Street

Postal code City

Email

Commision

Shipping address (if different from customer address)

Company

Street

Postal code City

Email

User information

Name

Weight

Age

Indication

Side Unilateral Bilateral

The size chosen depends on the patient's weight and the conditions of use. The 17AD300 Nexgear Tango ankle can be equipped with up to two modules. Please enter the required quantity in the field provided.

System width	Max. body weight in kg (lbs)	
	Unilateral fitting	Bilateral fitting
14	50 (110)	80 (176)
16	85 (187)	120 (264.5)
20	110 (242.5)	160 (352.5)

17AD300 Nexgear Tango ankle.

Page 2/2

Customer no.



1 Lamination bar

pc(s) 17LS3=14	pc(s) 17LS3=14-T
pc(s) 17LS3=16	pc(s) 17LS3=16-T
pc(s) 17LS3=20	pc(s) 17LS3=20-T

2 Base body

pc(s) 17AD300=14-ST	pc(s) 17AD300=14-T
pc(s) 17AD300=16-ST	pc(s) 17AD300=16-T
pc(s) 17AD300=20-ST	pc(s) 17AD300=20-T

3 Stop-module

pc(s) 17AD301=14
pc(s) 17AD301=16
pc(s) 17AD301=20

4 Spring-module

pc(s) 17AD302=14
pc(s) 17AD302=16
pc(s) 17AD302=20

5 Reaction-module

pc(s) 17AD303=14

5a Reaction spring, strong

pc(s) 17AD305=14

5b Reaction spring, extra strong

pc(s) 17AD306=14

5a Reaction spring, strong

pc(s) 17AD303=16

5a Reaction spring, strong

pc(s) 17AD305=20

5b Reaction spring, extra strong

pc(s) 17AD303=20

5b Reaction spring, extra strong

pc(s) 17AD306=20

6 Ultra-module

pc(s) 17AD304=16
pc(s) 17AD304=20

6c Ultra spring

pc(s) 17AD307=20

7 Foot stirrup

pc(s) 17SF300=N-14
pc(s) 17SF300=N-16
pc(s) 17SF300=N-20

Date Place Signature



17B66 Multifunction system ankle joint

Multifunction system ankle joint with up to nine setting options (spring, fixed stop or spring stop)

Key features

- Nine functional versions are possible thanks to the combination of springs, stops and spring stops in the dorsal and plantar joint channel.
- The ankle joint permits an angle adjustment of 50 degrees. The orthotic joint can be continuously adjusted within this angle.
- On the one hand, it is suitable for limiting movement, for example in case of ICP or spina bifida. On the other hand, it can be used to support dorsal extension in case of lower leg muscle weakness, to prevent hyperextension of the knee joint or for energy return during toe-off.
- It is also possible to use the 17B66 for dorsal and plantar support or as a dorsiflexion assist with an adjustable dorsal stop in case of peroneal palsy with or without a knee joint lock.
- Four foot stirrups are available for constructing various types of orthoses.



Technical data

Article number	System width	Slot width	Material	Quantity unit
17B66=16	16 mm	3 mm	Stainless steel	Pair with screws
17B66=20	20 mm	3 mm	Stainless steel	Pair with screws
17B66=A-16	16 mm	3 mm	Stainless steel	Pair with screws
17B66=A-20	20 mm	3 mm	Stainless steel	Pair with screws

• With the 17B66=A-16 and 17B66=A-20 versions, the medial and lateral joint are straight, and the bar connection is lateral.

i Practical recommendation

- Increased wear of the spring due to fully compressing it.
- The cylinder pin is located inside the spring. Using the cylinder pin can extend the life of the spring.

Spare parts for 17B66

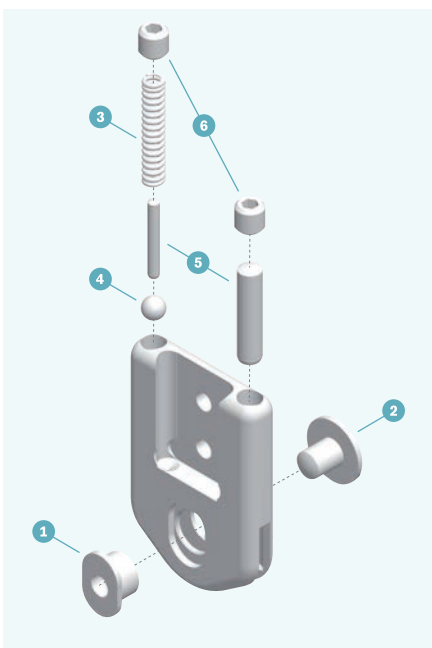

1) 17Y93 Bearing nut, hardened

Technical data

Article number	Spare part for	Shank length	Thread	Shoulder Ø	Quantity unit
17Y93=9X6.25XM6	17B66=16 17B66=A-16 17B66=20 17B66=A-20	6.25 mm	M6	9 mm	Piece

2) 501S32 Slotted truss head screw

Technical data

Article number	System width	Head Ø	Thread	Overall length	Material	Quantity unit
501S32=M6X14X10	16/20 mm	14 mm	M6	10 mm	Stainless steel	Piece

* when using 17Y84

3) 513D18 Compression spring

Technical data

Article number	Shoulder Ø	Quantity unit
513D18=4.7X31	4.7 mm	Piece

4) 509Y1 Bearing ball

Technical data

Article number	Quantity unit
509Y1=5.0	Piece

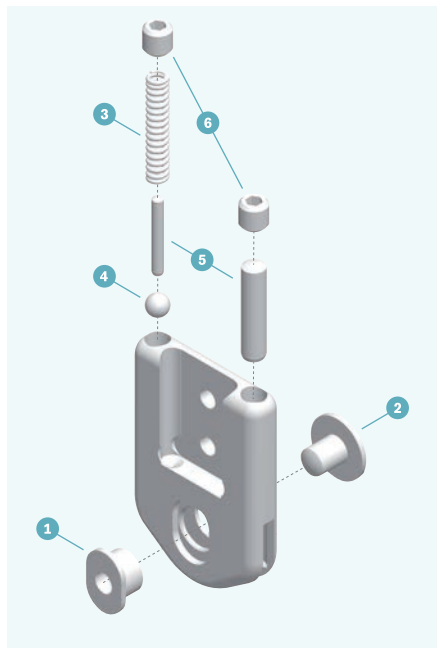

5) 506A8 Straight Pin

Technical data

Article number	Quantity unit
506A8=2.5X18	Piece
506A8=5X22	Piece

6) 506G3 Set screw

Technical data

Article number	Quantity unit
506G3=M6X6	Piece



17Y17 Brass bushing

Bearing bushing made of brass

Technical data

Article number	Material	Quantity unit
17Y17=9X11X2.9	Brass	Piece



17B66=S Service set for 17B66

Service set consisting of different service parts for the 17B66 multifunction system ankle joint

Technical data

Article number	Quantity unit
17B66=S	Set



Practical recommendation

- The cylinder pin is located inside the spring. Using the cylinder pin can extend the life of the spring.

Accessory for 17B66



17B113 System foot stirrup

Free motion up to 25° plantar flexion and 25° dorsal extension, with brass bushing



Technical data

Article number	Material	Quantity unit
17B113	Stainless steel	Piece



Practical recommendation

- Also suitable for prepreg, in addition to lamination resin and thermoplastic technique!



17B114 System foot stirrup

Free motion up to 25° plantar flexion and 25° dorsal extension, with brass bushing



Technical data

Article number	Material	Quantity unit
17B114	Stainless steel	Piece



Practical recommendation

- Also suitable for prepreg, in addition to lamination resin technique!



17B115 System foot stirrup

For 17F35=L/R150 system shoe plate, 25° plantar flexion and 25° dorsal extension, with brass bushing



Technical data

Article number	Material	Quantity unit
17B115	Stainless steel	Piece



17B116 System foot stirrup, double-sided shoe stirrup

Free motion up to 25° plantar flexion and 25° dorsal extension, with brass bushing



Technical data

Article number	System width	Thickness	Length from joint center	Material	Quantity unit
17B116=180	20 mm	3 mm	180 mm	Stainless steel	Piece
17B116=200	20 mm	3 mm	200 mm	Stainless steel	Piece
17B116=220	20 mm	3 mm	220 mm	Stainless steel	Piece
17B116=240	20 mm	3 mm	240 mm	Stainless steel	Piece
17B116=260	20 mm	3 mm	260 mm	Stainless steel	Piece
17B116=280	20 mm	3 mm	280 mm	Stainless steel	Piece
17B116=300	20 mm	3 mm	300 mm	Stainless steel	Piece



17F35 System shoe plate, hardened

With insert piece

Technical data

Article number	Side	Length	Material	Quantity unit
17F35=L120	left (L)	120 mm	Stainless steel	Piece
17F35=R120	right (R)	120 mm	Stainless steel	Piece
17F35=L150	left (L)	150 mm	Stainless steel	Piece
17F35=R150	right (R)	150 mm	Stainless steel	Piece



17PA1 CarbonIQ orthotic ankle joint

The 17PA1 ankle joint is a double-action joint based on Ottobock's 17B66 ankle joint. This type of joint offers the most versatile fitting by far. The different possibilities for settings and combinations allow the functions of this type of joint to be adapted to the user's requirements at any time, even if these change over the course of the fitting. Different versions to influence plantar flexion and dorsal extension are available.



Technical data

Article number	Side	Max. body weight	Material	Quantity unit
17PA1=14	left, right	45 kg	Plastic reinforced with carbon fibre	Pair
17PA1=20	left, right	100 kg	Plastic reinforced with carbon fibre	Pair

· Attention: For waterproof walking aids, use the waterproof versions of the CarbonIQ joints (see Waterproof walking aids section).

Spare parts for 17PA1=14

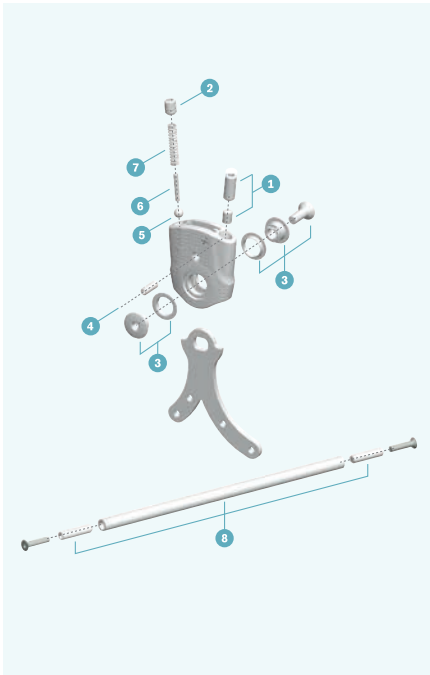

1) 30G79 Set of Stops

Technical data

Article number	Scope of delivery	Quantity unit
30G79	1x set screw, 1x cylinder Pin	Set

2) 30Y289 Set screw with end bore

Technical data

Article number	Quantity unit
30Y289	Piece

3) 29PA1 Service set

Technical data

Article number	Scope of delivery	Quantity unit
29PA1=14	1x Joint nut, 1x Joint bolt, 1x Bearing bushing, 1x Countersunk screw	Set

4) 506G21 Grub screw

Technical data

Article number	Quantity unit
506G21=M4X12	Piece

5) 509Y1 Bearing ball

Technical data

Article number	Quantity unit
509Y1=5.0	Piece

6) 506A8 Cylinder Pin

Technical data

Article number	Quantity unit
506A8=2X16	Piece

7) 513D87 Compression spring

Technical data

Article number	Quantity unit
513D87=0.75X2.95X2	Piece

8) 29PK4 Adjustment aid

Technical data

Article number	Scope of delivery	Quantity unit
29PK4=14	1x flat head screw, 1x paralleling tool, 1x parallel retainer adapter	Set

Spare parts for 17PA1=20

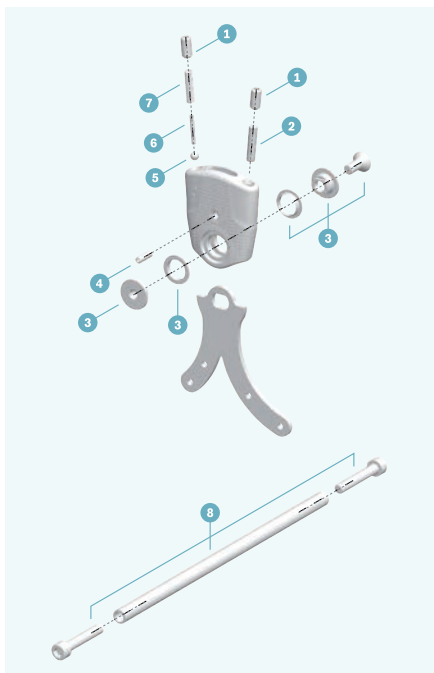

1) 506G36 Grub screw

Technical data

Article number	Quantity unit
506G36=M6X14	Piece

2) 506A8 Straight Pin

Technical data

Article number	Quantity unit
506A8=5X20	Piece

3) 29PA1 Service set

Technical data

Article number	Scope of delivery	Quantity unit
29PA1	1x Countersunk screw, 1x Joint bolt, 1x Joint nut, 1x Bearing bushing	Set

4) 506G3 Set screw

Technical data

Article number	Quantity unit
506G3=M4X12	Piece

5) 509Y1 Bearing ball

Technical data

Article number	Quantity unit
509Y1=5.0	Piece

6) 506A8 Straight Pin

Technical data

Article number	Quantity unit
506A8=2.5X18	Piece

7) 513D18 Compression spring

Technical data

Article number	Quantity unit
513D18=4.7X31-1	Piece

8) 29PK4 Adjustment aid

Technical data

Article number	Scope of delivery	Quantity unit
29PK4	1x cap screw, 1x paralleling tool	Set

Accessory for 17PA1



17PF1 Foot stirrup

Foot stirrup for 17PA1 and 17PA1=*-WR

Technical data

Article number	Accessory for	Material	Quantity unit
17PF1	17PA1=20 17PA1=20-WR	Stainless steel	Pair
17PF1=14	17PA1=14 17PA1=14-WR	Stainless steel	Pair

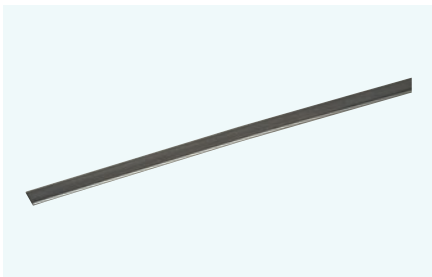

651P4 Stainless steel profile bar

Suitable for fabricating system bars, with rounded edges, strength of approx. 800–950 N/mm², spot weldable

Technical data

Article number	Length	Width	Thickness
651P4=16	2000 mm	16 mm	4 mm
651P4=20	2000 mm	20 mm	4 mm



605P8 Light metal profile bar

Suitable for fabricating system splints, with rounded edges, strength approx. 400 N/mm²

Technical data

Article number	Length	Width	Thickness
605P8=14	1000 mm	14 mm	5 mm
605P8=20	2000 mm	20 mm	5 mm



17CF1 Carbon Ankle seven

Carbon Ankle seven carbon springs make it possible to construct especially lightweight ankle-foot orthoses which are also able to withstand high dynamic loads.

Features and benefits

- Positive influence on the gait pattern
- Very lightweight design
- Classification makes it easy to select the right product
- Suitable for thermoplastic and laminated orthoses

Indications

- Paralysis or weakness of the foot lifting and lowering musculature and/or the knee extensors. Examples of typical underlying diseases include
 - Spina bifida Poliomyelitis

Modes of action

The carbon springs are designed to initiate extension moments of the hip and knee during walking and thus achieve extension and knee stability in the lower limbs. The energy generated during heel strike is stored in the carbon matrix and returned at toe-off. In contrast to conventional ankle joint orthoses, the limits in the plantar and dorsal direction are dynamic and are not subject to static restriction.

Selecting and ordering

- The Carbon Ankle seven is selected on the basis of the user's body weight and activity level.

Normal activity level

- A normally active user participates in all everyday activities independently and also performs relatively easy tasks.

High activity level

- A highly active user is unrestricted in everyday life. The orthosis has to support quick changes in walking and running speeds, e.g. for people who do sports or for children.



Technical data

Article number	Side	Max. body weight (normal activity)	Max. body weight (high activity)	Spring width	Quantity unit
17CF1=L1	left (L)	100 kg	100 kg	30 mm	Piece
17CF1=R1	right (R)	100 kg	100 kg	30 mm	Piece
17CF1=L2	left (L)	90 kg	80 kg	30 mm	Piece
17CF1=R2	right (R)	90 kg	80 kg	30 mm	Piece
17CF1=L3	left (L)	80 kg	70 kg	30 mm	Piece
17CF1=R3	right (R)	80 kg	70 kg	30 mm	Piece
17CF1=L4	left (L)	70 kg	60 kg	30 mm	Piece
17CF1=R4	right (R)	70 kg	60 kg	30 mm	Piece
17CF1=L5	left (L)	60 kg	50 kg	30 mm	Piece
17CF1=R5	right (R)	60 kg	50 kg	30 mm	Piece
17CF1=L6	left (L)	50 kg		25/30 mm	Piece
17CF1=R6	right (R)	50 kg		25/30 mm	Piece
17CF1=L7	left (L)		40 kg	25 mm	Piece
17CF1=R7	right (R)		40 kg	25 mm	Piece
17CF1=L8	left (L)	40 kg	30 kg	25 mm	Piece
17CF1=R8	right (R)	40 kg	30 kg	25 mm	Piece
17CF1=L9	left (L)	30 kg		25 mm	Piece
17CF1=R9	right (R)	30 kg		25 mm	Piece
17CF1=L10	left (L)		20 kg	25 mm	Piece
17CF1=R10	right (R)		20 kg	25 mm	Piece
17CF1=L11	left (L)	20 kg	10 kg	22 mm	Piece
17CF1=R11	right (R)	20 kg	10 kg	22 mm	Piece
17CF1=L12	left (L)	10 kg		22 mm	Piece
17CF1=R12	right (R)	10 kg		22 mm	Piece

- The specified weights are important for functionality, not durability.
- The classification applies to AFOs that are intended to influence the knee joint.
- The use of the Carbon Ankle seven carbon spring for KAFOs may require a deviation from the classification.

Components of 17CF1



502E3 Welding nut

Technical data

Article number	Quantity unit
502E3=M5X7.5	Piece
502E3=M4X6	Piece



501S86 Phillips oval countersunk head screw

Phillips oval countersunk screw made of steel

Technical data

Article number	Quantity unit
501S86=M5X14	Piece
501S86=M4X12	Piece



507U9 Rosette washer

Technical data

Article number	Quantity unit
507U9=M5	Piece
507U9=M4	Piece



SL=F Carbon fibre foot plate

Carbon fibre foot plate, flat

Technical data

Article number	Size	Stiffness (SL)	Version
SL=F16S	16 cm	Soft	Flat
SL=F16M	16 cm	Medium	Flat
SL=F16F	16 cm	Stiff	Flat
SL=F16XF	16 cm	Very stiff	Flat
SL=F16XXF	16 cm	Extra stiff	Flat
SL=F19S	19 cm	Soft	Flat
SL=F19M	19 cm	Medium	Flat
SL=F19F	19 cm	Stiff	Flat
SL=F19XF	19 cm	Very stiff	Flat
SL=F19XXF	19 cm	Extra stiff	Flat
SL=F22S	22 cm	Soft	Flat
SL=F22M	22 cm	Medium	Flat
SL=F22F	22 cm	Stiff	Flat
SL=F22XF	22 cm	Very stiff	Flat
SL=F22XXF	22 cm	Extra stiff	Flat
SL=F25S	25 cm	Soft	Flat
SL=F25M	25 cm	Medium	Flat
SL=F25F	25 cm	Stiff	Flat
SL=F25XF	25 cm	Very stiff	Flat
SL=F25XXF	25 cm	Extra stiff	Flat
SL=F28S	28 cm	Soft	Flat
SL=F28M	28 cm	Medium	Flat
SL=F28F	28 cm	Stiff	Flat
SL=F28XF	28 cm	Very stiff	Flat
SL=F28XXF	28 cm	Extra stiff	Flat
SL=F31S	31 cm	Soft	Flat
SL=F31M	31 cm	Medium	Flat
SL=F31F	31 cm	Stiff	Flat
SL=F31XF	31 cm	Very stiff	Flat
SL=F31XXF	31 cm	Extra stiff	Flat



SL=AL Carbon fibre foot plate

Carbon fibre foot plate, curved left

Technical data

Article number	Size	Stiffness (SL)	Version
SL=AL16S	16 cm	Soft	arched on the left
SL=AL16M	16 cm	Medium	arched on the left
SL=AL16F	16 cm	Stiff	arched on the left
SL=AL16XF	16 cm	Very stiff	arched on the left
SL=AL16XXF	16 cm	Extra stiff	arched on the left
SL=AL19S	19 cm	Soft	arched on the left
SL=AL19M	19 cm	Medium	arched on the left
SL=AL19F	19 cm	Stiff	arched on the left
SL=AL19XF	19 cm	Very stiff	arched on the left
SL=AL19XXF	19 cm	Extra stiff	arched on the left
SL=AL22S	22 cm	Soft	arched on the left
SL=AL22M	22 cm	Medium	arched on the left
SL=AL22F	22 cm	Stiff	arched on the left
SL=AL22XF	22 cm	Very stiff	arched on the left
SL=AL22XXF	22 cm	Extra stiff	arched on the left
SL=AL25S	25 cm	Soft	arched on the left
SL=AL25M	25 cm	Medium	arched on the left
SL=AL25F	25 cm	Stiff	arched on the left
SL=AL25XF	25 cm	Very stiff	arched on the left
SL=AL25XXF	25 cm	Extra stiff	arched on the left
SL=AL28S	28 cm	Soft	arched on the left
SL=AL28M	28 cm	Medium	arched on the left
SL=AL28F	28 cm	Stiff	arched on the left
SL=AL28XF	28 cm	Very stiff	arched on the left
SL=AL28XXF	28 cm	Extra stiff	arched on the left
SL=AL31S	31 cm	Soft	arched on the left
SL=AL31M	31 cm	Medium	arched on the left
SL=AL31F	31 cm	Stiff	arched on the left
SL=AL31XF	31 cm	Very stiff	arched on the left
SL=AL31XXF	31 cm	Extra stiff	arched on the left



SL=AR Carbon fibre foot plate

Carbon fibre foot plate, curved right

Technical data

Article number	Size	Stiffness (SL)	Version
SL=AR16S	16 cm	Soft	arched on the right
SL=AR16M	16 cm	Medium	arched on the right
SL=AR16F	16 cm	Stiff	arched on the right
SL=AR16XF	16 cm	Very stiff	arched on the right
SL=AR16XXF	16 cm	Extra stiff	arched on the right
SL=AR19S	19 cm	Soft	arched on the right
SL=AR19M	19 cm	Medium	arched on the right
SL=AR19F	19 cm	Stiff	arched on the right
SL=AR19XF	19 cm	Very stiff	arched on the right
SL=AR19XXF	19 cm	Extra stiff	arched on the right
SL=AR22S	22 cm	Soft	arched on the right
SL=AR22M	22 cm	Medium	arched on the right
SL=AR22F	22 cm	Stiff	arched on the right
SL=AR22XF	22 cm	Very stiff	arched on the right
SL=AR22XXF	22 cm	Extra stiff	arched on the right
SL=AR25S	25 cm	Soft	arched on the right
SL=AR25M	25 cm	Medium	arched on the right
SL=AR25F	25 cm	Stiff	arched on the right
SL=AR25XF	25 cm	Very stiff	arched on the right
SL=AR25XXF	25 cm	Extra stiff	arched on the right
SL=AR28S	28 cm	Soft	arched on the right
SL=AR28M	28 cm	Medium	arched on the right
SL=AR28M	28 cm	Medium	arched on the right
SL=AR28F	28 cm	Stiff	arched on the right
SL=AR28XF	28 cm	Very stiff	arched on the right
SL=AR28XXF	28 cm	Extra stiff	arched on the right
SL=AR31S	31 cm	Soft	arched on the right
SL=AR31M	31 cm	Medium	arched on the right
SL=AR31XF	31 cm	Very stiff	arched on the right
SL=AR31XXF	31 cm	Extra stiff	arched on the right



SL=HAL Carbon fibre foot plate

Carbon fibre foot plate, 13 mm heel, curved left

Technical data

Article number	Size	Stiffness (SL)	Version
SL=HAL16S	16 cm	Soft	13 mm heel, arched on the left
SL=HAL16M	16 cm	Medium	13 mm heel, arched on the left
SL=HAL16F	16 cm	Stiff	13 mm heel, arched on the left
SL=HAL16XF	16 cm	Very stiff	13 mm heel, arched on the left
SL=HAL16XXF	16 cm	Extra stiff	13 mm heel, arched on the left
SL=HAL19S	19 cm	Soft	13 mm heel, arched on the left
SL=HAL19M	19 cm	Medium	13 mm heel, arched on the left
SL=HAL19F	19 cm	Stiff	13 mm heel, arched on the left
SL=HAL19XF	19 cm	Very stiff	13 mm heel, arched on the left
SL=HAL19XXF	19 cm	Extra stiff	13 mm heel, arched on the left
SL=HAL22S	22 cm	Soft	13 mm heel, arched on the left
SL=HAL22M	22 cm	Medium	13 mm heel, arched on the left
SL=HAL22F	22 cm	Stiff	13 mm heel, arched on the left
SL=HAL22XF	22 cm	Very stiff	13 mm heel, arched on the left
SL=HAL22XXF	22 cm	Extra stiff	13 mm heel, arched on the left
SL=HAL25S	25 cm	Soft	13 mm heel, arched on the left
SL=HAL25M	25 cm	Medium	13 mm heel, arched on the left
SL=HAL25F	25 cm	Stiff	13 mm heel, arched on the left
SL=HAL25XF	25 cm	Very stiff	13 mm heel, arched on the left
SL=HAL25XXF	25 cm	Extra stiff	13 mm heel, arched on the left
SL=HAL28S	28 cm	Soft	13 mm heel, arched on the left
SL=HAL28M	28 cm	Medium	13 mm heel, arched on the left
SL=HAL28F	28 cm	Stiff	13 mm heel, arched on the left
SL=HAL28XF	28 cm	Very stiff	13 mm heel, arched on the left
SL=HAL28XXF	28 cm	Extra stiff	13 mm heel, arched on the left
SL=HAL31S	31 cm	Soft	13 mm heel, arched on the left
SL=HAL31M	31 cm	Medium	13 mm heel, arched on the left
SL=HAL31F	31 cm	Stiff	13 mm heel, arched on the left
SL=HAL31XF	31 cm	Very stiff	13 mm heel, arched on the left
SL=HAL31XXF	31 cm	Extra stiff	13 mm heel, arched on the left
SL=HAL31XXF	31 cm	Extra stiff	13 mm heel, arched on the left



SL=HAR Carbon fibre foot plate

Carbon fibre foot plate, 13 mm heel, curved right

Technical data

Article number	Size	Stiffness (SL)	Version
SL=HAR16S	16 cm	Soft	13 mm heel, arched on the right
SL=HAR16M	16 cm	Medium	13 mm heel, arched on the right
SL=HAR16F	16 cm	Stiff	13 mm heel, arched on the right
SL=HAR16XF	16 cm	Very stiff	13 mm heel, arched on the right
SL=HAR16XXF	16 cm	Extra stiff	13 mm heel, arched on the right
SL=HAR19S	19 cm	Soft	13 mm heel, arched on the right
SL=HAR19M	19 cm	Medium	13 mm heel, arched on the right
SL=HAR19F	19 cm	Stiff	13 mm heel, arched on the right
SL=HAR19XF	19 cm	Very stiff	13 mm heel, arched on the right
SL=HAR19XXF	19 cm	Extra stiff	13 mm heel, arched on the right
SL=HAR22S	22 cm	Soft	13 mm heel, arched on the right
SL=HAR22M	22 cm	Medium	13 mm heel, arched on the right
SL=HAR22F	22 cm	Stiff	13 mm heel, arched on the right
SL=HAR22XF	22 cm	Very stiff	13 mm heel, arched on the right
SL=HAR22XXF	22 cm	Extra stiff	13 mm heel, arched on the right
SL=HAR25S	25 cm	Soft	13 mm heel, arched on the right
SL=HAR25M	25 cm	Medium	13 mm heel, arched on the right
SL=HAR25F	25 cm	Stiff	13 mm heel, arched on the right
SL=HAR25XF	25 cm	Very stiff	13 mm heel, arched on the right
SL=HAR25XXF	25 cm	Extra stiff	13 mm heel, arched on the right
SL=HAR28S	28 cm	Soft	13 mm heel, arched on the right
SL=HAR28M	28 cm	Medium	13 mm heel, arched on the right
SL=HAR28F	28 cm	Stiff	13 mm heel, arched on the right
SL=HAR28XF	28 cm	Very stiff	13 mm heel, arched on the right
SL=HAR28XXF	28 cm	Extra stiff	13 mm heel, arched on the right
SL=HAR31S	31 cm	Soft	13 mm heel, arched on the right
SL=HAR31M	31 cm	Medium	13 mm heel, arched on the right
SL=HAR31F	31 cm	Stiff	13 mm heel, arched on the right
SL=HAR31XF	31 cm	Very stiff	13 mm heel, arched on the right



SL=CFP Carbon fibre foot plate

Carbon fibre foot plate, contoured

Technical data

Article number	Size	Stiffness (SL)	Version
SL=CFP22S	22 cm	Soft	contoured
SL=CFP22M	22 cm	Medium	contoured
SL=CFP22F	22 cm	Stiff	contoured
SL=CFP22XF	22 cm	Very stiff	contoured
SL=CFP22XXF	22 cm	Extra stiff	contoured
SL=CFP25S	25 cm	Soft	contoured
SL=CFP25M	25 cm	Medium	contoured
SL=CFP25F	25 cm	Stiff	contoured
SL=CFP25XF	25 cm	Very stiff	contoured
SL=CFP25XXF	25 cm	Extra stiff	contoured
SL=CFP28S	28 cm	Soft	contoured
SL=CFP28M	28 cm	Medium	contoured
SL=CFP28F	28 cm	Stiff	contoured
SL=CFP28XF	28 cm	Very stiff	contoured
SL=CFP28XXF	28 cm	Extra stiff	contoured
SL=CFP31S	31 cm	Soft	contoured
SL=CFP31M	31 cm	Medium	contoured
SL=CFP31F	31 cm	Stiff	contoured
SL=CFP31XF	31 cm	Very stiff	contoured
SL=CFP31XXF	31 cm	Extra stiff	contoured

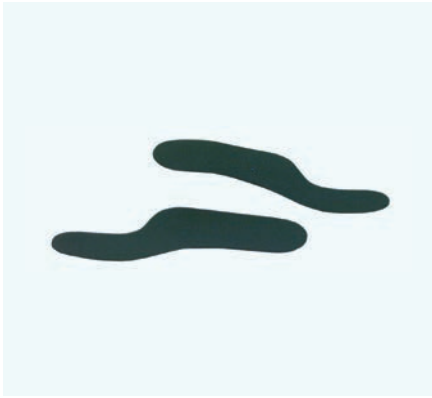

SL=ME Morton's extension

Morton's extension, standard (20 cm) Flat or contoured versions

Technical data

Article number	Side	Stiffness (SL)	Version
SL=ME-F-M		Medium	Standard (20 cm) + flat
SL=ME-F-F		Stiff	Standard (20 cm) + flat
SL=ME-CR-M	right	Medium	Standard (20 cm) + contoured
SL=ME-CL-M	left	Medium	Standard (20 cm) + contoured
SL=ME-CR-F	right	Stiff	Standard (20 cm) + contoured
SL=ME-CL-F	left	Stiff	Standard (20 cm) + contoured



SL=MEL Morton's extension

Morton's extension, long (25.5 cm) Flat or contoured versions

Technical data

Article number	Side	Stiffness (SL)	Version
SL=MEL-F-M		Medium	Long (25.5 cm) + flat
SL=MEL-F-F		Stiff	Long (25.5 cm) + flat
SL=MEL-CR-M	right	Medium	Long (25.5 cm) + contoured
SL=MEL-CL-M	left	Medium	Long (25.5 cm) + contoured
SL=MEL-CR-F	right	Stiff	Long (25.5 cm) + contoured
SL=MEL-CL-F	left	Stiff	Long (25.5 cm) + contoured



KAFO/KO.

All knee joints and knee joint systems, including traditional mechanical and mechatronic, are presented in this section.



17KO1000=0_B C-Brace KAFO

The C-Brace supports the user during the gait cycle and adapts to any everyday situation in real time. Flexion under load, walking over uneven terrain and on slopes or going down stairs step-over-step: all this defines a new level of mobility.

Key features

- Unique SSCO® system (Stance and Swing Phase Control Orthosis)
- Microprocessor-controlled stance and swing phase
- Entire gait cycle can be controlled dynamically and in real time
- System responds quickly to any everyday situation

Indications

- Unilateral or bilateral flaccid leg paresis or paralysis
- Physical prerequisites such as muscle status, joint mobility and possible axis deviations are crucial, as they must guarantee proper control of the orthosis.
- The user must fulfil the physical and mental requirements for perceiving optical/ acoustic signals and/or mechanical vibrations.
- The existing muscle strength of the hip extensors and flexors must permit the controlled swing-through of the limb

Contraindications

- Flexion contracture in the knee and/or hip joint > 10°
- Varus malposition > 10° or valgus malposition > 10°
- Severe spasticity
- Body weight > 125 kg

Relative contraindications

- Spasticity

· Certification is required for the C-Brace! Please contact your customer service representative or your regional contact person regarding this.

C-Brace.



1 Custom KAFO

Made of fibre composite material (Prepreg or wet lamination).

2 C-Brace joint unit

The microprocessor receives and processes sensor signals and controls the hydraulic dampening for each situation in real time.

C-Brace Setup App

Individual settings for the user on the tablet.

Available for Android and iOS devices.



3 LED Display

Shows system status and battery charge level.

4 Knee support option

The unilateral adapter plate (17KF300=*) for the lateral side or the medial support (17KF100-2=*) are available in four versions each.

5 Ankle options

Bilateral fitting:

17LA3N=16-T (< 85 kg)
17LA3N = 20-T (< 110 kg)
17AD300=16-T (< 85 kg)
17AD300=20-T (< 110 kg)
17AO100=22-T (< 125 kg)

Unilateral fitting:

17AO100=22-T (< 110 kg)



C-Brace Cover

131X1=L/R-7

Components of 17KO1000=0_B



17KO1 C-Brace joint unit

The C-Brace joint unit contains a 3D sensor in the joint axis, which measures the current position of the joint every 0.01 seconds. A microprocessor receives and processes the sensor signals and controls walking with the C-Brace in real time.



Technical data

Article number	Side	Max. body weight
17KO1=L	left (L)	125 kg
17KO1=R	right (R)	125 kg



17KF102 Dummy-set for 17KF100-2

Technical data

Article number
17KF102=16



17KF300 C-Brace unilateral adapter plate

The 17KF300=* adapter joint permits unilateral use of the C-Brace joint unit in the orthosis. The joint is laminated in and is available in 0°, 3°, 6° and 9° angles.

Technical data

Article number	Max. body weight	Angle	Quantity unit
17KF300=0	110 kg	0 °	Piece
17KF300=3	110 kg	3 °	Piece
17KF300=6	110 kg	6 °	Piece
17KF300=9	110 kg	9 °	Piece



17AO100 Unilateral C-Brace ankle joint

The 17AO100 unilateral ankle joint is a multifunction system ankle joint with a dorsiflexion effect. It is approved only in combination with the C-Brace.



Technical data

Article number	Bar width	Max. body weight
17AO100=22-T	22 mm	110 kg



17LA3N Unilateral system ankle joint

The 17LA3N unilateral ankle joint is a multifunction system ankle joint with a dorsiflexion effect.



Technical data

Article number	System width	Max. body weight	Material	Quantity unit
17LA3N=16-T	16 mm	85 kg (bilateral)	Titanium	Piece
17LA3N=20-T	20 mm	110 kg (bilateral)	Titanium	Piece

Spare parts for 17KO1000=0_B

3



17KO1A=*-SET1- Mounting set for C-Brace

Mounting set for fabrication of a C-Brace interim orthosis with loaner joint unit.

Technical data

Article number	Side
17KO1A=L-SET-1	left (L)
17KO1A=R-SET-1	right (R)

• All mounting components required to fabricate a C-Brace orthotronic mobility system are already included in the scope of delivery of the 17KO1* C-Brace joint unit.



17KO1A=SET-2 Fabrication set for C-Brace

Positioning and connection elements for subsequent attachment of the C-Brace joint unit.

Technical data

Article number
17KO1A=SET-2



17KO1A=SET-1 Screw set for C-Brace joint connection

Mounting screws for connection of the C-Brace joint unit

Technical data

Article number
17KO1A=SET-1

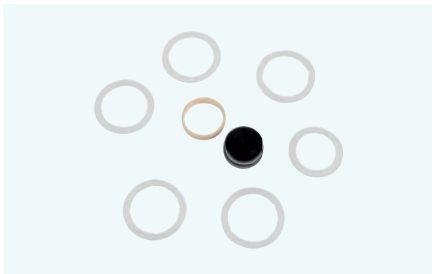

17KF103 Service-set for 17KF100-2 and 17KF300

Technical data

Article number
17KF103=16



17KO1A=SET Correction adapter set for C-Brace

Sliding adapter for interim orthoses (optional)

Technical data

Article number
17KO1A=SET



Practical recommendation

• For use with the 17B44 orthotic knee joint

Accessory for 17K01000=0_B



131X1 C-Brace Cover

Cover for C-Brace joint unit 17K01*

Technical data

Article number	Side	Quantity unit
131X1=L-7	left (L)	Piece
131X1=R-7	right (R)	Piece



799A1 C-Brace fabrication dummy

Fabrication dummy for the correct positioning of the 17K01 C-Brace joint unit.

Technical data

Article number
799A1



799Y17 Positioning template for C-Brace fabrication dummy

Positioning template for the C-Brace joint unit

Technical data

Article number
799Y17



17KF301 Dummy-Set for 17KF300

Dummy set for selecting the appropriate 17KF300=* unilateral adapter plate for fabricating a C-Brace orthosis.

Technical data

Article number
17KF301=1



4E50-3 Battery charger

Technical data

Article number
4E50-3



757L16-4 Power supply unit

The power supply for electronic prosthetic components and orthoses from Ottobock. Adapters for the EU and US are included in the scope of delivery. Additional adapters can be ordered under the following article numbers:

- Great Britain: 757S1=GB-4
- Australia: 757S1=AUS-4
- Argentina: 757S1=ARG-4

Technical data

Article number
757L16-4

- Adapters for the EU and US are included in the scope of delivery.



17KT1 Diagnostic trial orthosis for C-Brace

The diagnostic trial orthosis allows you to test the treatment of a patient with the C-Brace in advance to verify function and patient acceptance.

Technical data

Article number	Side	Max. body weight	for
17KT1=L-S	left (L)	125 kg	Patients with a body height of between 1.50 m and 2.00 m
17KT1=R-S	right (R)	125 kg	Patients with a body height of between 1.50 m and 2.00 m

· The DTO is a loaner unit (17KT1=*-S). Please contact your local contact person if you would like to purchase a DTO (17KT1=*).



17KO1 C-Brace joint unit

The C-Brace joint unit contains a 3D sensor in the joint axis, which measures the current position of the joint every 0.01 seconds. A microprocessor receives and processes the sensor signals and controls walking with the C-Brace in real time.



Technical data

Article number	Side	Max. body weight
17KO1=L-S	left (L)	125 kg
17KO1=R-S	right (R)	125 kg

· These are loaner joints (17KO1=*-S) that can be obtained from the MASC (Manufacturer's After-Sales Service Center). If you want to purchase a joint, please use article number 17KO1=*.

Spare parts for 17K01

3

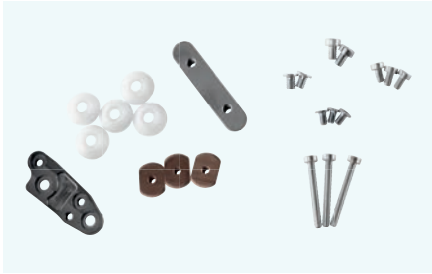

17K01A=*-SET1- Mounting set for C-Brace

Mounting set for fabrication of a C-Brace interim orthosis with loaner joint unit.

Technical data

Article number	Side
17K01A=L-SET-1	left (L)
17K01A=R-SET-1	right (R)

· All mounting components required to fabricate a C-Brace orthotronic mobility system are already included in the scope of delivery of the 17K01* C-Brace joint unit.



17K01A=SET-2 Fabrication set for C-Brace

Positioning and connection elements for subsequent attachment of the C-Brace joint unit.

Technical data

Article number
17K01A=SET-2



17K01A=SET-1 Screw set for C-Brace joint connection

Mounting screws for connection of the C-Brace joint unit

Technical data

Article number
17K01A=SET-1



17K01A=SET Correction adapter set for C-Brace

Sliding adapter for interim orthoses (optional)

Technical data

Article number
17K01A=SET

i **Practical recommendation**
 · For use with the 17B44 orthotic knee joint

C-Brace.
Order form

Page 1/2

Contact person

Customer no.

Date

Customer

Company

Street

Postal code City

Email

Commision

Shipping address (if different from customer address)

Company

Street

Postal code City

Email

● **Initial orthotic fitting with C-Brace**

● **Follow-up fitting**

Previously fitted with

● 17KO1=R C-Brace Serial number

● 17KO1=L C-Brace Serial number

● **Treatment** after trial fitting with loaner joints (no selection of further components necessary)

Orthosis user

Weight kg

Height cm

Affected side ● left ● right

For bilateral patients, please fill out one order sheet each for the right and the left leg!

C-Brace. Order form

Page 2/2

Orthotic design

C-Brace follower options	Bilateral (125 kg/275 lbs max)		Unilateral (110 kg/242 lbs max)	
	Art. no.	Description	Art. no.	Description
C-Brace ankle options	Medial support (selection required)		Unilateral support (selection required)	
	<input type="radio"/> 17KF100-2=16-1-T	Proximal and distal straight (R and L)	<input type="radio"/> 17KF300=0	C-Brace unilateral adapter plate 0°
	<input type="radio"/> 17KF100-2=16-2-T	Proximal straight, distal angled (L)	<input type="radio"/> 17KF300=3	C-Brace unilateral adapter plate 3°
	<input type="radio"/> 17KF100-2=16-3-T	Proximal straight, distal angled (R)	<input type="radio"/> 17KF300=6	C-Brace unilateral adapter plate 6°
	<input type="radio"/> 17KF100-2=16-4-T	Proximal and distal angled (R and L)	<input type="radio"/> 17KF300=9	C-Brace unilateral adapter plate 9°
	▶ Note: Delivered with two 17LS3=16-T lamination bars invoiced separately.			
	Ankle joint (selection required)		Ankle joint (selection required)	
	<input type="radio"/> none (fitting with custom spring – < 125 kg/275 lbs)		<input type="radio"/> none (fitting with custom spring – < 125 kg/275 lbs)	
	Unilateral (one joint)		Unilateral (one joint)	
	<input type="radio"/> 17AO100=22-T (up to 110 kg/242 lbs)		<input type="radio"/> 17AO100=22-T (up to 110 kg/242 lbs)	
	Bilateral (two joints)			
	<input type="radio"/> 17LA3N=16-T (< 85 kg/187 lbs)*			
	<input type="radio"/> 17LA3N=20-T (< 110 kg/242 lbs)*			
	<input type="radio"/> 17AD300=16-T (< 85 kg/187 lbs)*/**			
	<input type="radio"/> 17AD300=20-T (< 110 kg/242 lbs)*/**			
	<input type="radio"/> 17AO100=22-T (< 125 kg/275 lbs)			
	* Delivered with foot stirrup and lamination bars invoiced separately.			
	** To configure the Nexgear Tango ankle joint, please use the selection guide.			

Warranty option

Art. no.	Description
<input type="radio"/> SP-17KO1=3+3	Extension of warranty to six years

▶ **Note:** We offer the option of extending the warranty to six years. This makes it even easier for you to keep track of the costs incurred and minimises the effort on your part. You can take advantage of this option up to 36 months after the delivery date.

Accessories

Art. no.	Description
<input type="radio"/> 131X1=L-7	C-Brace Cover (left)
<input type="radio"/> 131X1=R-7	C-Brace Cover (right)
<input type="radio"/> 757L43	USB-Adapter for charging

Subject to the general business terms and conditions of Ottobock SE & Co. KGaA. Errors and price changes reserved.

Desired shipping date

(generally delivered one to two working days after shipping)

Date Place Signature

C-Brace.

Send order to ifab@ottobock.com

Page 1/3

Contact person

Customer no.

Date

Customer

Company

Street

Postal code

City

Email

Commision

Shipping address (if different from customer address)

Company

Street

Postal code

City

Email

● Initial orthotic fitting with C-Brace

● Follow-up fitting

Previously fitted with

● 17KO1=R C-Brace Serial number

● 17KO1=L C-Brace Serial number

● **Treatment** after trial fitting with loaner joints (no selection of further components necessary)

Orthosis user

Weight

kg

Height

cm

Affected side

● left

● right

For bilateral patients, please fill out one order sheet each for the right and the left leg!

C-Brace.

Send order to ifab@ottobock.com

Orthotic design

C-Brace follower options	Bilateral (125 kg/275 lbs max)		Unilateral (110 kg/242 lbs max)	
	Art. no.	Description	Art. no.	Description
	Medial support (selection required)		Unilateral support (selection required)	
	<input type="radio"/> 17KF100-2=16-1-T	Proximal and distal straight (R and L)	<input type="radio"/> 17KF300=0	C-Brace unilateral adapter plate 0°
	<input type="radio"/> 17KF100-2=16-2-T	Proximal straight, distal angled (L)	<input type="radio"/> 17KF300=3	C-Brace unilateral adapter plate 3°
	<input type="radio"/> 17KF100-2=16-3-T	Proximal straight, distal angled (R)	<input type="radio"/> 17KF300=6	C-Brace unilateral adapter plate 6°
	<input type="radio"/> 17KF100-2=16-4-T	Proximal and distal angled (R and L)	<input type="radio"/> 17KF300=9	C-Brace unilateral adapter plate 9°
	▶ Note: Delivered with two 17LS3=16-T lamination bars invoiced separately.			
C-Brace ankle options	Ankle joint (selection required)		Ankle joint (selection required)	
	<input type="radio"/> none (fitting with custom spring – < 125 kg/275 lbs)		<input type="radio"/> none (fitting with custom spring – < 125 kg/275 lbs)	
	Unilateral (one joint)		Unilateral (one joint)	
	<input type="radio"/> 17AO100=22-T (up to 110 kg/242 lbs)		<input type="radio"/> 17AO100=22-T (up to 110 kg/242 lbs)	
	Bilateral (two joints)			
	<input type="radio"/> 17LA3N=16-T (< 85 kg/187 lbs)*			
	<input type="radio"/> 17LA3N=20-T (< 110 kg/242 lbs)*			
	<input type="radio"/> 17AD300=16-T (< 85 kg/187 lbs)*/**			
	<input type="radio"/> 17AD300=20-T (< 110 kg/242 lbs)*/**			
	<input type="radio"/> 17AO100=22-T (< 125 kg/275 lbs)			
	* Delivered with foot stirrup and lamination bars invoiced separately.			
	** To configure the Nexgear Tango ankle joint, please use the selection guide.			

Warranty option

Art. no.	Description
<input type="radio"/> SP-17KO1=3+3	Extension of warranty to six years

▶ **Note:** We offer the option of extending the warranty to six years. This makes it even easier for you to keep track of the costs incurred and minimises the effort on your part. You can take advantage of this option up to 36 months after the delivery date.

Accessories

Art. no.	Description
<input type="radio"/> 131X1=L-7	C-Brace Cover (left)
<input type="radio"/> 131X1=R-7	C-Brace Cover (right)
<input type="radio"/> 757L43	USB-Adapter for charging

Subject to the general business terms and conditions of Ottobock SE & Co. KGaA. Errors and price changes reserved.

Desired shipping date

(generally delivered one to two working days after shipping)

Date Place Signature



C-Brace.

Send order to ifab@ottobock.com

Ordering options

- IP3141=* mill foam model**, the following options may also apply¹
 - IP8010=1 milling job (convert .cxp to .stl)
 - IP8010=2 conversion
 - IP3180=1 glue metal cores in place
 - IP3180=3 square box spanner for alignment axis
- SF28=T4 thermoplastic test orthosis (to check the fit and static alignment)**
- SF5712=O Scan of test orthosis and manufacturing of a 3D-model**
- SF28K=L/R-KAFO-4 prepreg frame (incl. hook-and-loop pocket, unfinished carbon fibre look)²**
- SF28=F2 fabrication – padding and closures³**
- SF28=C1 surface design (finished glossy carbon look)**

¹ Sub-options deviate as specified

² Please mark the position, size and thickness of the hook-and-loop pockets

³ If the "Fabrication" ordering option is selected, straps and padding are included as specified

Padding dummy

- Prepare the orthosis directly on the cast, **without** allowing for any padding distance
- The cast is shaped without padding distance. Please allow a padding distance for the:

<input type="radio"/> Thigh	of	<input style="width: 90%;" type="text"/>	mm
<input type="radio"/> Lower leg	of	<input style="width: 90%;" type="text"/>	mm
<input type="radio"/> Foot	of	<input style="width: 90%;" type="text"/>	mm

Padding

Thigh and lower leg

- 623F109=* ComforTex soft, 4 mm
- 623F110=* ComforTex smooth, 4 mm
- 623F112=* ComforTex grippy, 4 mm
- 623F62=* ComforTex air, 3 mm

Foot

- 617S90=2 Dino foam, black/white, 2 mm
- 617S3=W2 Pedilin, white, 2 mm
- 617S3=W3 Pedilin, white, 3 mm

Closures

If the "Fabrication" ordering option is selected, straps and padding are included as specified. Otherwise only closure pockets are considered.

<input style="width: 90%;" type="text"/> Thigh strap(s)	<input style="width: 90%;" type="text"/> Lower leg strap(s)
Side for strap guide loop	Side for strap guide loop
<input type="radio"/> Medial <input type="radio"/> Lateral	<input type="radio"/> Medial <input type="radio"/> Lateral
Strap width	Strap width
<input type="radio"/> 40 mm <input type="radio"/> 50 mm	<input type="radio"/> 40 mm <input type="radio"/> 50 mm

Strap material

- 21Y75N hook-and-loop closure, carbon fibre look
- 21Y78 hook-and-loop closure with weld seams, black

i A carbon anterior tibial shell must be provided if the lower leg frame is in the posterior position.

Sole

	Rollover without resistance	Dynamic	Spring stiffness	Stiff		
Forefoot characteristics	<input type="radio"/> 1 Soft	<input type="radio"/> 2	<input type="radio"/> 3	<input type="radio"/> 4	<input type="radio"/> 5	<input type="radio"/> Stiff
Heel	<input type="radio"/> 1 Soft	<input type="radio"/> 3	<input type="radio"/> 5	<input type="radio"/> Stiff		

Date Place Signature

Patient selection aid for the C-Brace.

The selection aid helps to determine whether a patient is suitable for a C-Brace. However, this document should be considered only an aid. For the final decision, please fit the patient with a diagnostic trial orthosis (DTO).

Cognitive requirements

The patient must be capable of ensuring the proper handling, care and use of the orthosis (e.g. hearing acoustic signals).

Functional deficit

Neuromuscular instability of the knee joint in the sagittal plane
Diagnosis (by the physician):

Exclusion criteria

If any of the following apply to your patient, he or she cannot be fitted with a C-Brace at this time:

- **Swing phase initiation from a standing position is not possible**
- **Weight over 125 kg**
- **Severe spasticity**
- **Leg shortened more than 15 cm**
- **Knee and hip flexion contracture more than 10°**
- **Insufficient neuromuscular trunk stability for the trial phase**
- **Diseases that preclude the use of an orthosis (e.g. oedema, extensive skin irritation)**
- **Orthoprosthesis**

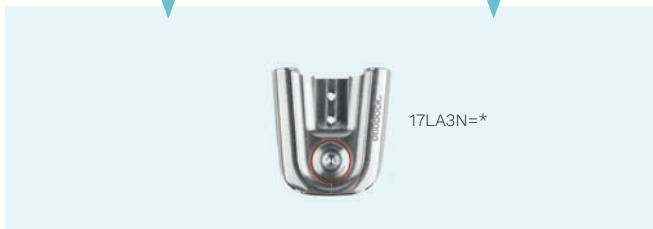
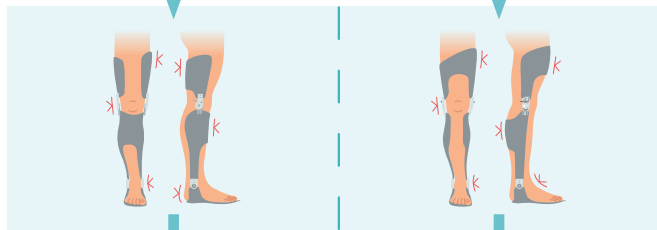
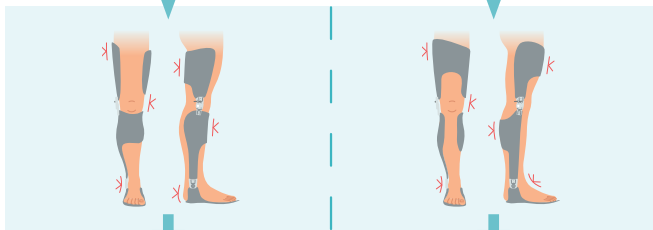
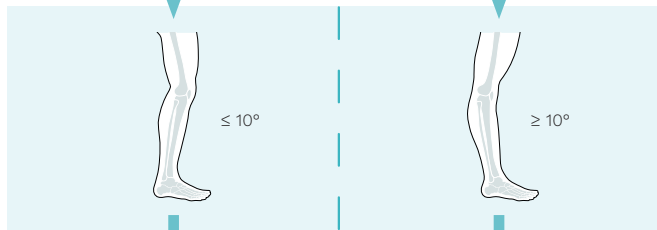
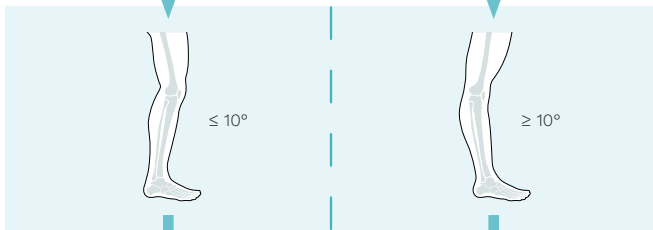
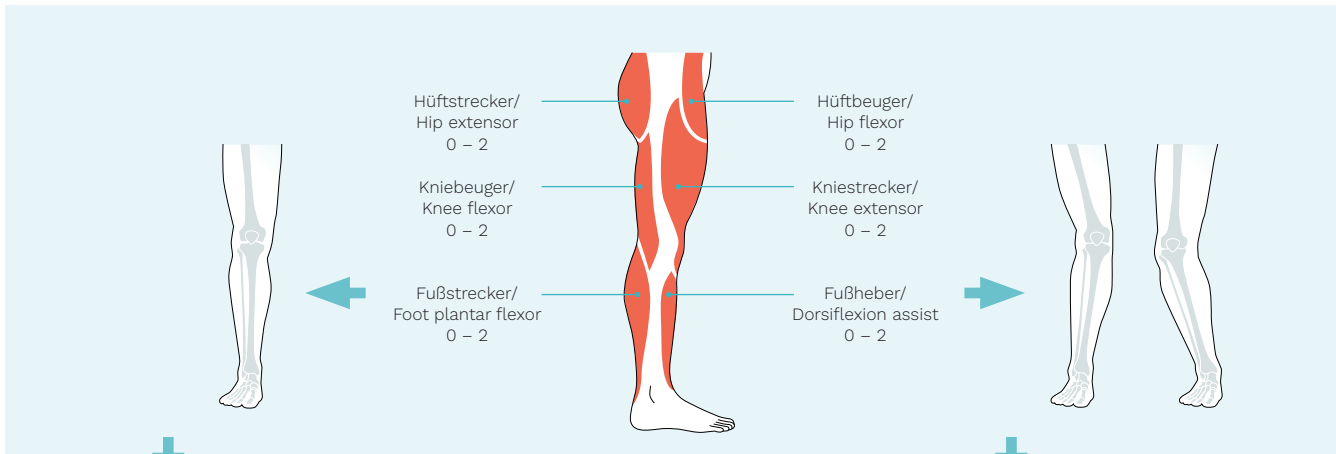

ODER/OR

ODER/OR

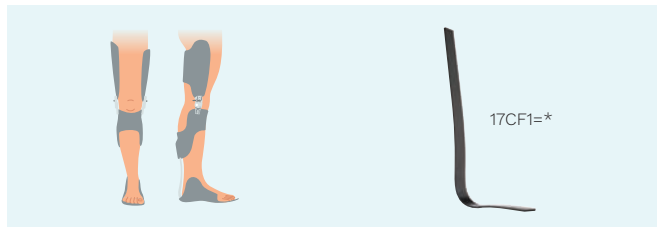
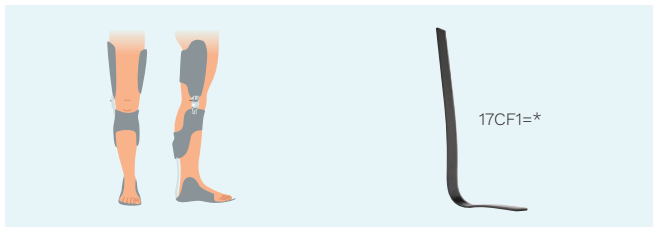

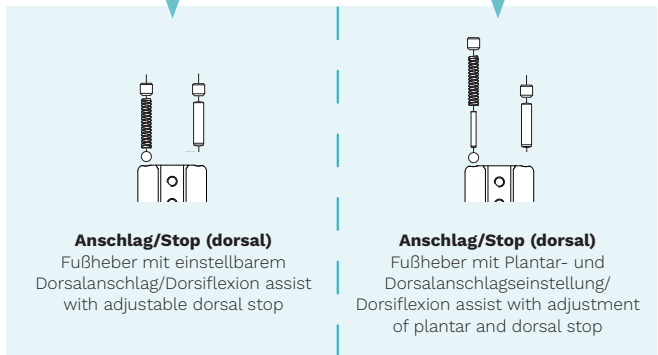
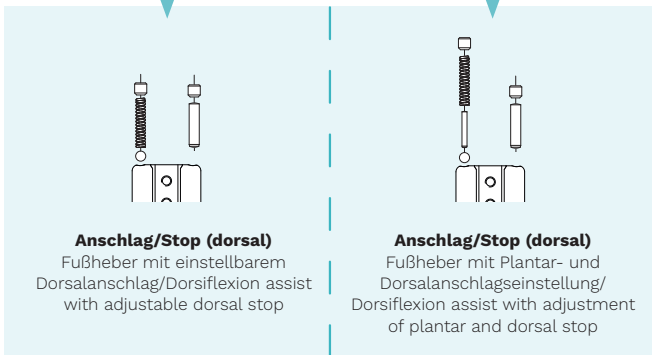
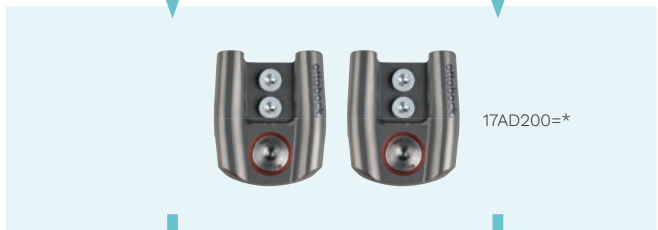
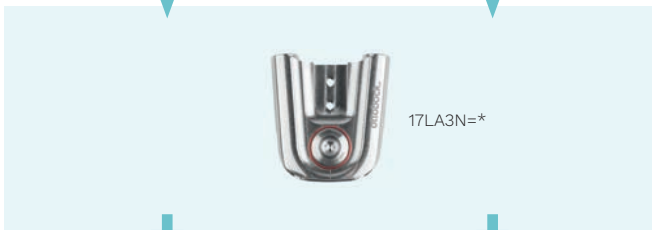
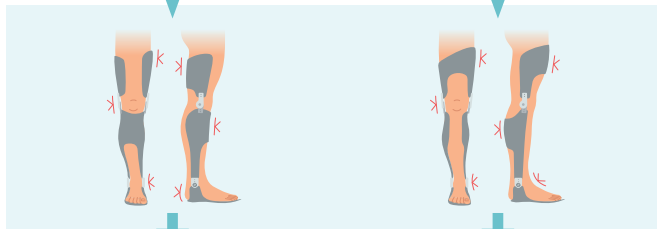
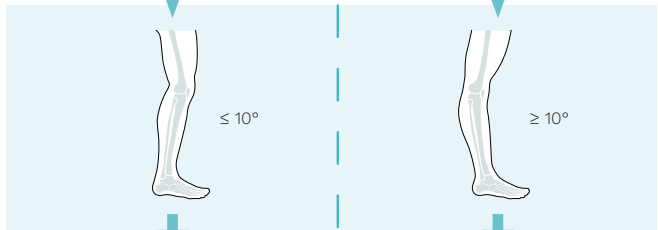
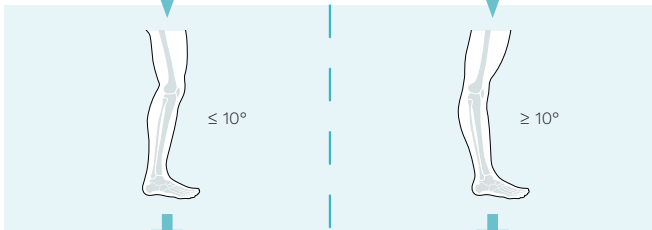
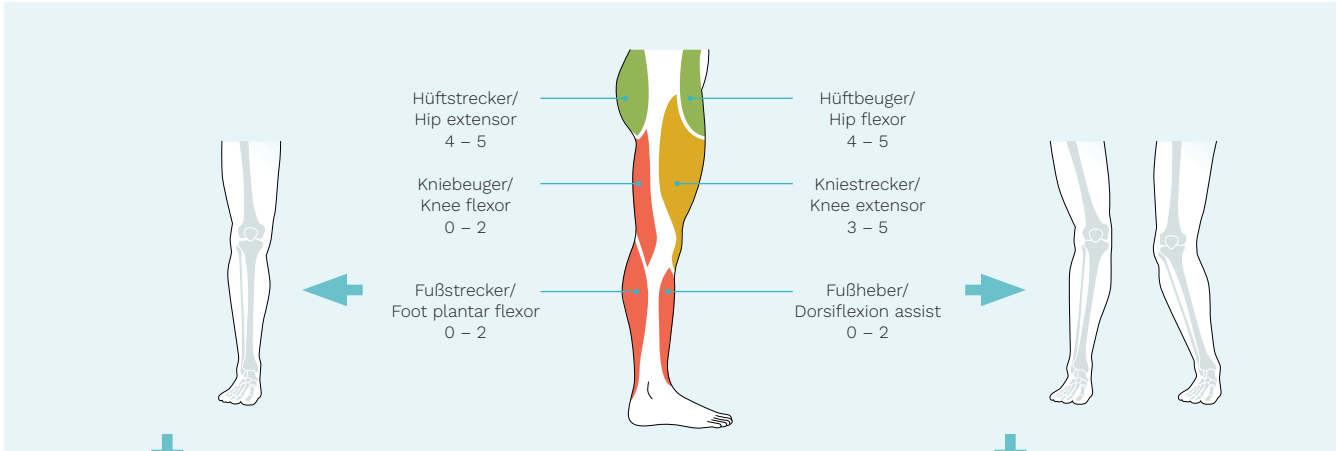



17K32 Knee joint bar for children

Knee joint extension stop can be adjusted by filing, flat bar profile, no posterior placement



Technical data

Article number	Upper/lower bar length	Bar width	Bar thickness	Joint head Ø	Material	Quantity unit
17K32=6	220 / 250 mm	12 mm	3 mm	16 mm	Stainless steel	Pair
17K32=5	300 / 320 mm	14 mm	3 mm	18 mm	Stainless steel	Pair
17K32=4	410 / 390 mm	16 mm	3 mm	20 mm	Stainless steel	Pair

i Practical recommendation

- On worn joints, the tolerance can be reduced with the repair bolts. A suitable reamer is usually used for adaptation.
- The following shoulder screws can be used with the 17K29/32/33/34/42 joint bars for children: 501A1=12x6xM4



17K33 Knee joint bar for children

Joints not filed out, joint centre 15 mm to the posterior



Technical data

Article number	Upper/lower bar length	Bar width	Bar thickness	Joint head Ø	Material	Quantity unit
17K33=6	220 / 250 mm	12 mm	3 mm	16 mm	Stainless steel	Pair
17K33=5	220 / 250 mm	14 mm	3 mm	18 mm	Stainless steel	Pair
17K33=4	220 / 250 mm	16 mm	3 mm	20 mm	Stainless steel	Pair

i Practical recommendation

- On worn joints, the tolerance can be reduced with the repair bolts. A suitable reamer is usually used for adaptation.
- The following shoulder screws can be used with the 17K29/32/33/34/42 joint bars for children: 501A1=12x6xM4



17KF10 Free motion knee joint, posterior offset

Adjustable extension stop, posterior placement of 19 mm

Key features

- Adjustable extension stop
- Posterior placement of 19 mm
- Available in stainless steel and aluminium



Technical data

Article number	Upper/lower bar length	Bar width	Bar thickness	Version	Material	Quantity unit
17KF10=16	390 / 570 mm	16 mm	5 mm	Straight	Stainless steel	Pair
17KF10=16-A	390 / 570 mm	16 mm	5 mm	Straight	Aluminium	Pair

Spare parts for 17KF10



17KS=11 Service set

Service set for the 17KF10 knee joint

Technical data

Article number	Spare part for	Scope of delivery
17KS=11	17KF10=16-A 17KF10=16	Bearing nut Bushing Truss head screw with slot Red washer

Accessory for 17KF10



743Y57 Alignment insert set

Alignment insert set for conventional orthotic joints

Technical data

Article number	Accessory for
743Y57	17KF10=16 17KF10=16-A

- The 743Y57 is a set consisting of the alignment inserts in sizes 5 through 9.



17KF1 Free motion knee joint

Free motion knee joint



Technical data

Article number	Upper/lower bar length	Bar width	Bar thickness	Bar material	Quantity unit
17KF1=13-A	300 / 560 mm	13 mm	5 mm	Aluminium	Pair
17KF1=13-CS	300 / 560 mm	13 mm	5 mm	Steel	Pair
17KF1=16-A	400 / 570 mm	16 mm	6.35 mm	Aluminium	Pair
17KF1=16-CS	400 / 570 mm	16 mm	5 mm	Steel	Pair

Spare parts for 17KF1



17KS=18 Service set

Service set for size 13 (aluminium) 17KF1 knee joint

Technical data

Article number	Spare part for	Scope of delivery
17KS=18	17KF1=13-A	Flat round disk with slot Red Washer Bearing nut Bushing Face plate



17KHS=3 Service set

Service set for size 13 (steel) 17KF1, 17KL6 and 17KL7 knee joints as well as the 17HF1, 17HL1, 17HL4 and 17HL5 hip joints

Technical data

Article number	Spare part for	Scope of delivery
17KHS=3	17HF1=13-CS 17HL1=13-CS 17HL4=13-CS 17HL5=13-CS 17KF1=13-CS 17KL6=13-CS 17KL7=13-CS	Bearing nut Bushing Flat round disk with slot Red washer Compression spring Truss head screw with slot Spring-loaded thrust piece



17KS=16 Service set

Service set for size 16 (aluminium) 17KF1 knee joint

Technical data

Article number	Spare part for	Scope of delivery
17KS=16	17KF1=16-A	Flat round disk with slot Red washer Bearing nut Bushing Face plate



17KHS=2 Service set

Service set for size 16 (steel) 17KF1, 17KL6 and 17KL7 knee joints as well as the 17HF1, 17HL1 and 17HL4 hip joints

Technical data

Article number	Spare part for	Scope of delivery
17KHS=2	17HF1=16-CS 17KF1=16-CS	Bearing nut Bushing Flat round disk with slot Red washer Compression spring Truss head screw with slot pring-loaded thrust piece

Accessory for 17KF1



743Y57 Alignment insert set

Alignment insert set for conventional orthotic joints

Technical data

Article number	Accessory for
743Y57	17KF1=13-A 17KF1=13-CS 17KF1=16-A 17KF1=16-CS

· The 743Y57 is a set consisting of the alignment inserts in sizes 5 through 9.



17KF110 Nexgear free knee

The 17KF110 is a free motion orthotic knee joint.

Key features

- The 17KF110 Nexgear free knee is remarkably easy to handle for processing and maintenance.
- The joint is low-noise. This is ensured by the integrated damper at the end stop in the terminal stance phase.
- The joint has a ball bearing and runs smoothly. It has remarkably low flexion resistance.
- A sustainable dummy concept with reusable steel dummies creates less waste.



Technical data

Article number	System width	Max. body weight	Length from joint centre upper	Length from joint centre lower	Posterior offset	Quantity unit
17KF110=*-10-*-*	10 mm	15 kg	~ 31 mm	~ 32 mm	5 mm	Piece
17KF110=*-12-*-*	12 mm	20 kg	~ 32 mm	~ 33 mm	6 mm	Piece
17KF110=*-14-*-*	14 mm	50 kg	~ 34 mm	~ 35 mm	7 mm	Piece
17KF110=*-16-*-*	16 mm	85 kg	~ 38 mm	~ 39 mm	8 mm	Piece
17KF110=*-20-*-*	20 mm	110 kg	~ 41 mm	~ 42 mm	10 mm	Piece

- The 17KF110 Nexgear free knee is:
 - Only suitable for bilateral use
 - Combinable with the following orthotic ankle joints:
 - 17AD200*
 - 17AD300*
 - 17LA3N*
 - Combinable with the following bars
 - 17SL100=* lamination bar (lamination and prepreg technique)
 - 17SB100=* side bar (thermoplastic technique and bar-clamp device)
 - Available sides: right (R), left (L)
 - Available sizes: 10, 12, 14, 16, 20
 - Available materials: titanium (T), steel (ST)
 - Available contours:
 - straight lower section, straight upper section (1)
 - contoured lower section, straight upper section (2)
 - straight lower section, contoured upper section (3)
 - contoured lower section, contoured upper section (4)
- The following are not included in the scope of delivery and must be ordered separately:
 - * 17KF113=* ball bearing pressing tool (optional)
 - * 17KF112=* dummy set (making an orthosis requires two dummy sets)
 - * 17SL100* lamination bars/17SB100* side bars

Order example

Reference number	Side	System width	Contour	Material
17KF110	= R	- 10	- 1	- T
Nexgear free knee	right	10	straight lower section, straight upper section	titanium
17KF110	= L	- 14	- 3	- ST
Nexgear free knee	left	14	straight lower section, contoured upper section	steel

Spare parts for 17KF110

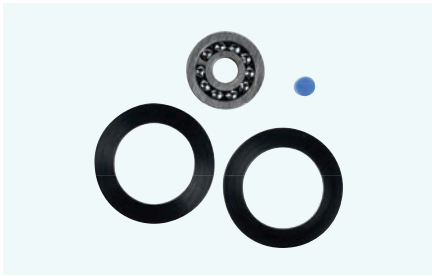

17KF111 Service set for 17KF110

Service set for the 17KF110 Nexgear free knee.

Technical data

Article number	spare part for	Scope of delivery
17KF111=10	17KF110=*-10-*-*	1 x Ball bearing, 1 x Stop buffer, 2 x Thrust washer
17KF111=12	17KF110=*-12-*-*	1 x Ball bearing, 1 x Stop buffer, 2 x Thrust washer
17KF111=14	17KF110=*-14-*-*	1 x Ball bearing, 1 x Stop buffer, 2 x Thrust washer
17KF111=16	17KF110=*-16-*-*	1 x Ball bearing, 1 x Stop buffer, 2 x Thrust washer
17KF111=20	17KF110=*-20-*-*	1 x Ball bearing, 1 x Stop buffer, 2 x Thrust washer

Accessories for 17KF110



17KF112 Dummy set for 17KF110

The dummy set is available for building an orthosis with the 17KF110 Nexgear free knee. It contains a lamination dummy upper and lower section, each in straight and contoured designs, as well as the head screw required to connect the two sections.



Technical data

Article number	for
17KF112=10	17KF110=*-10-*-*
17KF112=12	17KF110=*-12-*-*
17KF112=14	17KF110=*-14-*-*
17KF112=16	17KF110=*-16-*-*
17KF112=20	17KF110=*-20-*-*

* Making an orthosis requires two dummy sets



17KF113 Ball-bearing tool

The press-in and press-out tool is intended for maintenance work on the 17KF110 Nexgear free knee and 17KF210 Nexgear posterior knee, making it easier to insert and to remove the ball bearing.

Technical data

Article number	Accessories for
17KF113=2	17KF110=*-14-*-* 17KF110=*-16-*-* 17KF110=*-20-*-* 17KF210=*-14-*-* 17KF210=*-16-*-* 17KF210=*-20-*-*
17KF113=1	17KF110=*-10-*-* 17KF110=*-12-*-* 17KF210=*-10-*-* 17KF210=*-12-*-*

17KF110 Nexgear free knee. Order form.

Notice: This order form is only for sizes 10, 12.
Please use one form per orthosis.

Contact person		Customer number	Date
Customer		Shipping address (if different from customer address)	
Customer number		Customer number	
Company		Company	
Street		Street	
Postcode	Town/City	Postcode	Town/City
User data (optional)		Indication	
Patient ID		Side <input type="radio"/> Left <input type="radio"/> Right	
Weight			

Notice: When specifying quantities, please note that the quantity unit for all articles is "piece".

System size based on maximum body weight

System size	Max. body weight (kg)
<input type="radio"/> 10	0 - 15
<input type="radio"/> 12	16 - 20

Nexgear bilateral joint system

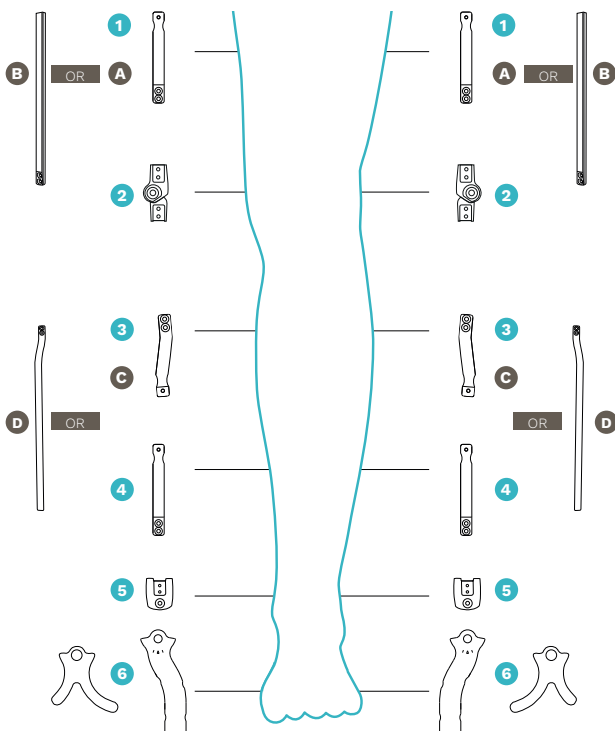

1 Bar

(A) 17SL100 lamination bar

Pc.	Titanium	Pc.	Steel
	17SL100=10-T		17SL100=10
	17SL100=12-T		17SL100=12

(B) 17SB100 side bar

Pc.	Steel	Pc.	Aluminium
	17SB100=10		17SB100=12-A
	17SB100=12		

4 Bar





17SL100 lamination bar

Pc.	Titanium	Pc.	Steel
	17SL100=10-T		17SL100=10
	17SL100=12-T		17SL100=12

2 Bilateral orthotic knee joint

17KF110 Nexgear free knee

Titanium				Steel			
Left		Right		Left		Right	
Pc.	Article number	Size	V*	Pc.	Article number	Size	V*
	17KF110=L-10-1-T	10	1		17KF110=R-10-1-T	10	1
	17KF110=L-10-2-T	10	2		17KF110=R-10-2-T	10	2
	17KF110=L-10-3-T	10	3		17KF110=R-10-3-T	10	3
	17KF110=L-10-4-T	10	4		17KF110=R-10-4-T	10	4
	17KF110=L-12-1-T	12	1		17KF110=R-12-1-T	12	1
	17KF110=L-12-2-T	12	2		17KF110=R-12-2-T	12	2
	17KF110=L-12-3-T	12	3		17KF110=R-12-3-T	12	3
	17KF110=L-12-4-T	12	4		17KF110=R-12-4-T	12	4

*Variant	1	2	3	4
Version upper section/lower section	Straight/straight (left/right)	Straight/contoured	Contoured/straight	Contoured/contoured
Notice: The variants are shown in the left lateral frontal version.				

3 Bar

(C) 17SL100 lamination bar

Titanium		Steel	
Pc.	Straight	Pc.	Straight
	17SL100=10-T		17SL100=10
	17SL100=12-T		17SL100=12
Pc.	With contoured calf	Pc.	With contoured calf
	17SL100=10-L-T		17SL100=10-L
	17SL100=10-R-T		17SL100=10-R
	17SL100=12-L-T		17SL100=12-L
	17SL100=12-R-T		17SL100=12-R

(D) 17SB100 side bar

Steel		Aluminium	
Pc.	Straight	Pc.	
	17SB100=10		17SB100=12-A
	17SB100=12		
Pc.	With contoured calf		
	17SB100=10-L		
	17SB100=10-R		
	17SB100=12-L		
	17SB100=12-R		

5 Orthotic ankle joint

17AD200 Nexgear Sixty-six ankle

Pc.	Titanium	Pc.	Steel
	17AD200=10-T		17AD200=10
	17AD200=12-T		17AD200=12

6 Foot stirrup

17SF200 foot stirrup for 17AD200

Pc.	Straight	Pc.	Forked
	17SF200=OS-10		17SF200=FT-10
	17SF200=OS-12		17SF200=FT-12



17KF210 Nexgear posterior knee

The 17KF210 is a free motion orthotic knee joint with a posterior location.

Key features

- The 17KF210 Nexgear posterior knee is remarkably easy to handle for processing and maintenance.
- The 17KF213 extension wedge set can be used to adjust the extension stop on the Nexgear posterior knee simply and conveniently to 5°, 10°, 15° and even -5°.
- In factory condition, the joint contains a 0° stop.
- A sustainable dummy concept with reusable steel dummies creates less waste.
- The joint has a ball bearing and runs smoothly. It has remarkably low flexion resistance.
- The joint is low-noise. At the end stop in the terminal stance phase this is achieved thanks to the integrated damper.



Technical data

Article number	System width	Max. body weight	Length from joint centre upper	Posterior offset	Quantity unit
17KF210=*-10-*-*	10 mm	15 kg	~ 31 mm	10 mm	Piece
17KF210=*-12-*-*	12 mm	20 kg	~ 32 mm	12 mm	Piece
17KF210=*-14-*-*	14 mm	50 kg	~ 34 mm	14 mm	Piece
17KF210=*-16-*-*	16 mm	85 kg	~ 38 mm	16 mm	Piece
17KF210=*-20-*-*	20 mm	110 kg	~ 41 mm	20 mm	Piece

• The 17KF210 Nexgear posterior knee is:

- Only suitable for bilateral use
- Combinable with the following orthotic ankle joints:
 - 17AD200*
 - 17AD300*
 - 17LA3N*
- Combinable with the following bars:
 - 17SL100=* lamination bar (lamination and prepreg technique)
 - 17SB100=* side bar (thermoplastic technique and bar-clamp device)
- Available sides: right (R), left (L)
- Available sizes: 10, 12, 14, 16, 20
- Available materials: titanium (T), steel (ST)
- Available contours:
 - straight lower section, straight upper section (1)
 - contoured lower section, straight upper section (2)
 - straight lower section, contoured upper section (3)
 - contoured lower section, contoured upper section (4)

• The following are not included in the scope of delivery and must be ordered separately:

- 17KF113=* ball bearing pressing tool (optional)
- 17KF212=* dummy set (making an orthosis requires two dummy sets)
- 17KF213=* extension wedge set (optional)
- 17SL100* lamination bars/17SB100* side bars

Order example

Reference number	Side	System width	Contour	Material
17KF210	= R	- 10	- 1	- T
Nexgear posterior knee	right	10	straight lower section, straight upper section	titanium
17KF210	= L	- 14	- 3	- ST
Nexgear posterior knee	left	14	straight lower section, contoured upper section	steel

Spare parts for 17KF210

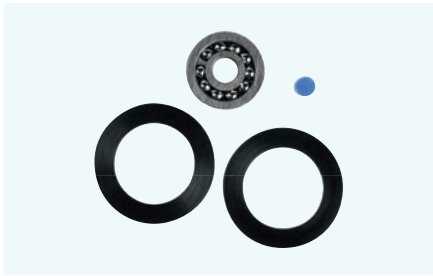

17KF211 Service set for 17KF210

Service set for the 17KF210 Nexgear posterior knee.

Technical data

Article number	spare part for
17KF211=10	17KF210=*-10-*-*
17KF211=12	17KF210=*-12-*-*
17KF211=14	17KF210=*-14-*-*
17KF211=16	17KF210=*-16-*-*
17KF211=20	17KF210=*-20-*-*

Accessories for 17KF210



17KF212 Dummy set for 17KF210

The dummy set is available for building an orthosis with the 17KF210 Nexgear posterior knee. It contains a lamination dummy upper and lower section, each in straight and contoured designs, as well as the head screw and clamping screw required to connect the two sections.



Technical data

Article number	Accessories for
17KF212=10	17KF210=*-10-*-*
17KF212=12	17KF210=*-12-*-*
17KF212=14	17KF210=*-14-*-*
17KF212=16	17KF210=*-16-*-*
17KF212=20	17KF210=*-20-*-*

* Making an orthosis requires two dummy sets



17KF113 Ball-bearing tool

The press-in and press-out tool is intended for maintenance work on the 17KF110 Nexgear free knee and 17KF210 Nexgear posterior knee, making it easier to insert and to remove the ball bearing.

Technical data

Article number	Accessories for
17KF113=2	17KF110=*-14-*-*
	17KF110=*-16-*-*
	17KF110=*-20-*-*
	17KF210=*-14-*-*
	17KF210=*-16-*-*
17KF113=1	17KF210=*-20-*-*
	17KF110=*-10-*-*
	17KF110=*-12-*-*
	17KF210=*-10-*-*
17KF210=*-12-*-*	

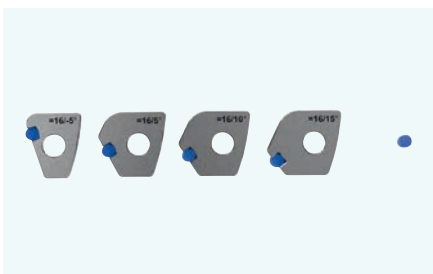

17KF213 Extension wedge set for 17KF210

The extension wedge set is available for orthosis fabrication with the 17KF210 Nexgear posterior knee. It includes four extension stops which can be used to set the extension stop to 5°, 10°, 15° and even -5° in an uncomplicated straightforward manner.

Technical data

Article number	Accessories for
17KF213=10	17KF210=*-10-*-*
17KF213=12	17KF210=*-12-*-*
17KF213=14	17KF210=*-14-*-*
17KF213=16	17KF210=*-16-*-*
17KF213=20	17KF210=*-20-*-*

17KF210 Nexgear posterior knee. Order form.

Notice: This order form is only for sizes 10, 12.
Please use one form per orthosis.

Contact person		Customer number	Date
Customer		Shipping address (if different from customer address)	
Customer number		Customer number	
Company		Company	
Street		Street	
Postcode	Town/City	Postcode	Town/City
User data (optional)		Indication	
Patient ID		Side <input type="radio"/> Left <input type="radio"/> Right	
Weight			

Notice: When specifying quantities, please note that the quantity unit for all articles is "piece".

System size based on maximum body weight

System size	Max. body weight (kg)
<input type="radio"/> 10	0 - 15
<input type="radio"/> 12	16 - 20

Nexgear bilateral joint system

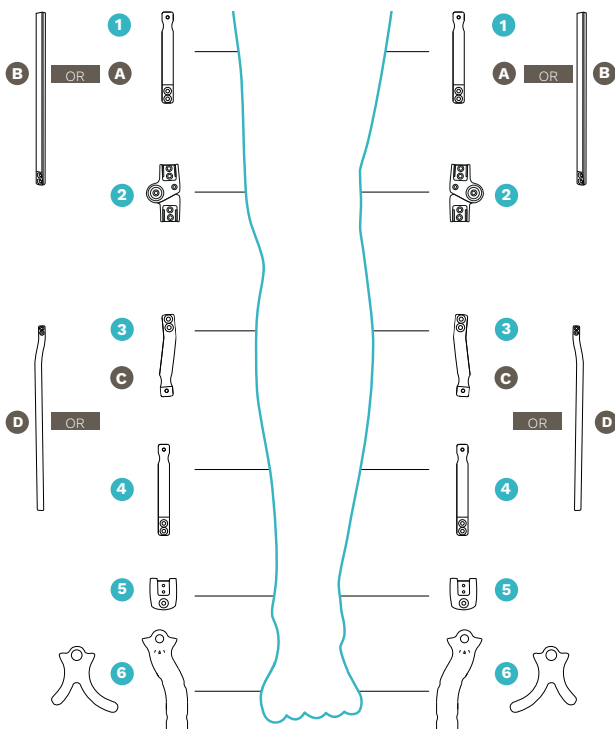

1 Bar

(A) 17SL100 lamination bar

Pc.	Titanium	Pc.	Steel
	17SL100=10-T		17SL100=10
	17SL100=12-T		17SL100=12

(B) 17SB100 side bar

Pc.	Steel	Pc.	Aluminium
	17SB100=10		17SB100=12-A
	17SB100=12		

4 Bar





17SL100 lamination bar

Pc.	Titanium	Pc.	Steel
	17SL100=10-T		17SL100=10
	17SL100=12-T		17SL100=12

2 Bilateral orthotic knee joint

17KF210 Nexgear posterior knee

Titanium				Steel			
Left		Right		Left		Right	
Pc.	Article number	Size	V*	Pc.	Article number	Size	V*
	17KF210=L-10-1-T	10	1		17KF210=R-10-1-T	10	1
	17KF210=L-10-2-T	10	2		17KF210=R-10-2-T	10	2
	17KF210=L-10-3-T	10	3		17KF210=R-10-3-T	10	3
	17KF210=L-10-4-T	10	4		17KF210=R-10-4-T	10	4
	17KF210=L-12-1-T	12	1		17KF210=R-12-1-T	12	1
	17KF210=L-12-2-T	12	2		17KF210=R-12-2-T	12	2
	17KF210=L-12-3-T	12	3		17KF210=R-12-3-T	12	3
	17KF210=L-12-4-T	12	4		17KF210=R-12-4-T	12	4

*Variant	1	2	3	4
Version upper section/lower section	Straight/straight (left/right)	Straight/contoured	Contoured/straight	Contoured/contoured
Notice: The variants are shown in the left lateral frontal version.				

3 Bar

(C) 17SL100 lamination bar

Titanium		Steel	
Pc.	Straight	Pc.	Straight
	17SL100=10-T		17SL100=10
	17SL100=12-T		17SL100=12
Pc.	With contoured calf	Pc.	With contoured calf
	17SL100=10-L-T		17SL100=10-L
	17SL100=10-R-T		17SL100=10-R
	17SL100=12-L-T		17SL100=12-L
	17SL100=12-R-T		17SL100=12-R

(D) 17SB100 side bar

Steel		Aluminium	
Pc.	Straight	Pc.	
	17SB100=10		17SB100=12-A
	17SB100=12		
Pc.	With contoured calf		
	17SB100=10-L		
	17SB100=10-R		
	17SB100=12-L		
	17SB100=12-R		

5 Orthotic ankle joint

17AD200 Nexgear Sixty-six ankle

Pc.	Titanium	Pc.	Steel
	17AD200=10-T		17AD200=10
	17AD200=12-T		17AD200=12

6 Foot stirrup

17SF200 foot stirrup for 17AD200

Pc.	Straight	Pc.	Forked
	17SF200=OS-10		17SF200=FT-10
	17SF200=OS-12		17SF200=FT-12

7 Extension wedge set (optional)

17KF213 extension wedge set for 17KF210

Pc.	
	17KF213=10
	17KF213=12

17KF210 Nexgear posterior knee. Order form.

Notice: This order form is only for sizes 14, 16, 20.
Please use one form per orthosis.

Contact person		Customer number	Date
Customer		Shipping address (if different from customer address)	
Customer number		Customer number	
Company		Company	
Street		Street	
Postcode	Town/City	Postcode	Town/City
User data (optional)		Indication	
Patient ID		Side <input type="radio"/> Left <input type="radio"/> Right	
Weight			

Notice: When specifying quantities, please note that the quantity unit for all articles is "piece".

System size based on maximum body weight

System size	Max. body weight (kg)
<input type="radio"/> 14	21 - 50
<input type="radio"/> 16	51 - 85
<input type="radio"/> 20	86 - 110

Nexgear bilateral joint system

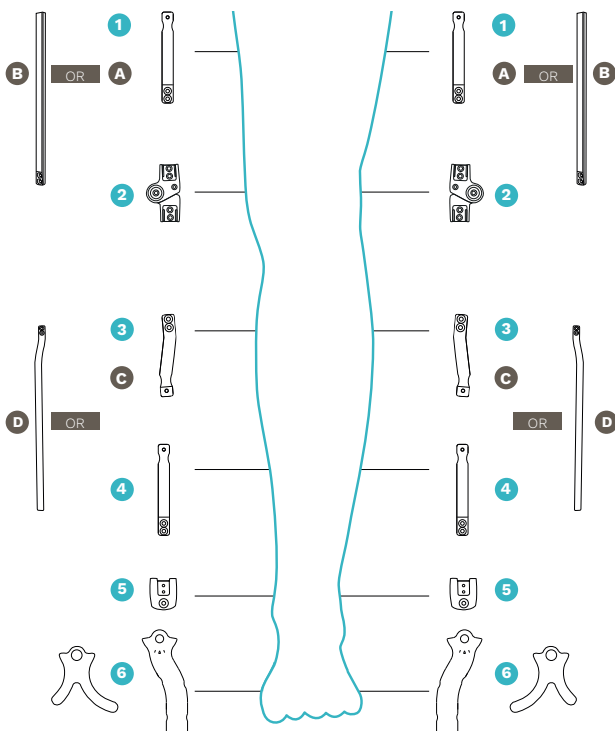

1 Bar

(A) 17SL100 lamination bar

Pc.	Titanium	Pc.	Steel
	17SL100=14-T		17SL100=14
	17SL100=16-T		17SL100=16
	17SL100=20-T		17SL100=20

(B) 17SB100 side bar

Pc.	Steel	Pc.	Aluminium
	17SB100=14		17SB100=14-A
	17SB100=16		17SB100=16-A
	17SB100=20		17SB100=20-A

4 Bar





17SL100 lamination bar

Pc.	Titanium	Pc.	Steel
	17SL100=14-T		17SL100=14
	17SL100=16-T		17SL100=16
	17SL100=20-T		17SL100=20

2 Bilateral orthotic knee joint

17KF210 Nexgear posterior knee

Titanium								Steel							
Left				Right				Left				Right			
Pc.	Article number	Size	V*	Pc.	Article number	Size	V*	Pc.	Article number	Size	V*	Pc.	Article number	Size	V*
	17KF210=L-14-1-T	14	1		17KF210=R-14-1-T	14	1		17KF210=L-14-1-ST	14	1		17KF210=R-14-1-ST	14	1
	17KF210=L-14-2-T	14	2		17KF210=R-14-2-T	14	2		17KF210=L-14-2-ST	14	2		17KF210=R-14-2-ST	14	2
	17KF210=L-14-3-T	14	3		17KF210=R-14-3-T	14	3		17KF210=L-14-3-ST	14	3		17KF210=R-14-3-ST	14	3
	17KF210=L-14-4-T	14	4		17KF210=R-14-4-T	14	4		17KF210=L-14-4-ST	14	4		17KF210=R-14-4-ST	14	4
	17KF210=L-16-1-T	16	1		17KF210=R-16-1-T	16	1		17KF210=L-16-1-ST	16	1		17KF210=R-16-1-ST	16	1
	17KF210=L-16-2-T	16	2		17KF210=R-16-2-T	16	2		17KF210=L-16-2-ST	16	2		17KF210=R-16-2-ST	16	2
	17KF210=L-16-3-T	16	3		17KF210=R-16-3-T	16	3		17KF210=L-16-3-ST	16	3		17KF210=R-16-3-ST	16	3
	17KF210=L-16-4-T	16	4		17KF210=R-16-4-T	16	4		17KF210=L-16-4-ST	16	4		17KF210=R-16-4-ST	16	4
	17KF210=L-20-1-T	20	1		17KF210=R-20-1-T	20	1		17KF210=L-20-1-ST	20	1		17KF210=R-20-1-ST	20	1
	17KF210=L-20-2-T	20	2		17KF210=R-20-2-T	20	2		17KF210=L-20-2-ST	20	2		17KF210=R-20-2-ST	20	2
	17KF210=L-20-3-T	20	3		17KF210=R-20-3-T	20	3		17KF210=L-20-3-ST	20	3		17KF210=R-20-3-ST	20	3
	17KF210=L-20-4-T	20	4		17KF210=R-20-4-T	20	4		17KF210=L-20-4-ST	20	4		17KF210=R-20-4-ST	20	4

*Variant	1	2	3	4
Version upper section/lower section	Straight/straight (left/right)	Straight/contoured	Contoured/straight	Contoured/contoured
Notice: The variants are shown in the left lateral frontal version.				

3 Bar

(C) 17SL100 lamination bar

Titanium		Steel	
Pc.	Straight	Pc.	Straight
	17SL100=14-T		17SL100=14
	17SL100=16-T		17SL100=16
	17SL100=20-T		17SL100=20
Pc.	With contoured calf	Pc.	With contoured calf
	17SL100=14-L-T		17SL100=14-L
	17SL100=14-R-T		17SL100=14-R
	17SL100=16-L-T		17SL100=16-L
	17SL100=16-R-T		17SL100=16-R
	17SL100=20-L-T		17SL100=20-L
	17SL100=20-R-T		17SL100=20-R

(D) 17SB100 side bar

Steel		Aluminium	
Pc.	Straight	Pc.	
	17SB100=14		17SB100=14-A
	17SB100=16		17SB100=16-A
	17SB100=20		17SB100=20-A
Pc.	With contoured calf		
	17SB100=14-L		
	17SB100=14-R		
	17SB100=16-L		
	17SB100=16-R		
	17SB100=20-L		
	17SB100=20-R		

5 Orthotic ankle joint

17AD200 Nexgear Sixty-six ankle

Pc.	Titanium	Pc.	Steel
	17AD200=14-T		17AD200=14
	17AD200=16-T		17AD200=16
	17AD200=20-T		17AD200=20

6 Foot stirrup

17SF200 foot stirrup for 17AD200

Pc.	Straight	Pc.	Forked
	17SF200=OS-14		17SF200=FT-14
	17SF200=OS-16		17SF200=FT-16
	17SF200=OS-20		17SF200=FT-20

7 Extension wedge set (optional)

17KF213 extension wedge set for 17KF210

Pc.	
	17KF213=14
	17KF213=16
	17KF213=20

Accessories for 17KF110, 17KF210



17SL100 Nexgear lamination bars

The lamination bars are designed for combination with the 17AD200 Nexgear Sixty-six ankle and the 17KL100 Nexgear lock knee, 17KF110 Nexgear free knee and 17KF210 Nexgear posterior knee. They are intended exclusively for bilateral use and in the lamination or prepreg technique.

Technical data

Article number	Version	System width	Length	Thickness	Material	Max. body weight	Side	Quantity unit
17SL100=10	Without calf swing	10 mm	80 mm	3,5 mm	Steel	15 kg	both sides	Piece
17SL100=10-T	Without calf swing	10 mm	80 mm	3,5 mm	Titanium	15 kg	both sides	Piece
17SL100=12	Without calf swing	12 mm	80 mm	3,5 mm	Steel	20 kg	both sides	Piece
17SL100=12-T	Without calf swing	12 mm	80 mm	3,5 mm	Titanium	20 kg	both sides	Piece
17SL100=14	Without calf swing	14 mm	80 mm	3,5 mm	Steel	50 kg	both sides	Piece
17SL100=14-T	Without calf swing	14 mm	80 mm	3,5 mm	Titanium	50 kg	both sides	Piece
17SL100=16	Without calf swing	16 mm	100 mm	3,5 mm	Steel	85 kg	both sides	Piece
17SL100=16-T	Without calf swing	16 mm	100 mm	3,5 mm	Titanium	85 kg	both sides	Piece
17SL100=20	Without calf swing	20 mm	100 mm	3,5 mm	Steel	110 kg	both sides	Piece
17SL100=20-T	Without calf swing	20 mm	100 mm	3,5 mm	Titanium	110 kg	both sides	Piece
17SL100=10-*	With calf swing	10 mm	80 mm	3,5 mm	titanium (T), steel (-)	15 kg	left (L), right (R)	Piece
17SL100=12-*	With calf swing	12 mm	80 mm	3,5 mm	titanium (T), steel (-)	20 kg	left (L), right (R)	Piece
17SL100=14-*	With calf swing	14 mm	80 mm	3,5 mm	titanium (T), steel (-)	50 kg	left (L), right (R)	Piece
17SL100=16-*	With calf swing	16 mm	100 mm	3,5 mm	titanium (T), steel (-)	85 kg	left (L), right (R)	Piece
17SL100=20-*	With calf swing	20 mm	100 mm	3,5 mm	titanium (T), steel (-)	110 kg	left (L), right (R)	Piece

- Available versions: With or without calf swing
- Available sizes: 10, 12, 14, 16, 20
- Available materials: titanium (T), steel (-)
- Available sides (for variants with calf swing): right (R), left (L)
- The variants without calf swing can be used in a side-neutral way

Order example for bars with calf swing

Reference number	System width	Side	Material
17SL100	= 12	- L	
Lamination bar with calf swing	12	left	steel
17SL100	= 16	- R	- T
Lamination bar with calf swing	16	right	titanium



17SB100 Nexgear side bars

The extension bars are designed for combination with the 17AD200 Nexgear Sixty-six ankle and the 17KL100 Nexgear lock knee, 17KF110 Nexgear free knee and 17KF210 Nexgear posterior knee. They are intended exclusively for bilateral use and in the thermoplastic or bar-clamp technique.

Technical data

Article number	Version	System width	Length	Thick-ness	Material	Max. body weight	Side	Quan-tity unit
17SB100=10	Without calf swing	10 mm	270 mm	3,5 mm	Steel	15 kg	both sides	Piece
17SB100=10-L	With calf swing	10 mm	270 mm	3,5 mm	Steel	15 kg	left	Piece
17SB100=10-R	With calf swing	10 mm	270 mm	3,5 mm	Steel	15 kg	right	Piece
17SB100=12	Without calf swing	12 mm	300 mm	3,5 mm	Steel	20 kg	both sides	Piece
17SB100=12-A	Without calf swing	12 mm	300 mm	5 mm	Aluminium	15 kg	both sides	Piece
17SB100=12-L	With calf swing	12 mm	300 mm	3,5 mm	Steel	20 kg	left	Piece
17SB100=12-R	With calf swing	12 mm	300 mm	3,5 mm	Steel	20 kg	right	Piece
17SB100=14	Without calf swing	14 mm	400 mm	3,5 mm	Steel	50 kg	both sides	Piece
17SB100=14-A	Without calf swing	14 mm	400 mm	6 mm	Aluminium	20 kg	both sides	Piece
17SB100=14-L	With calf swing	14 mm	400 mm	3,5 mm	Steel	50 kg	left	Piece
17SB100=14-R	With calf swing	14 mm	400 mm	3,5 mm	Steel	50 kg	right	Piece
17SB100=16	Without calf swing	16 mm	450 mm	3,5 mm	Steel	85 kg	both sides	Piece
17SB100=16-A	Without calf swing	16 mm	450 mm	6 mm	Aluminium	50 kg	both sides	Piece
17SB100=16-L	With calf swing	16 mm	450 mm	3,5 mm	Steel	85 kg	left	Piece
17SB100=16-R	With calf swing	16 mm	450 mm	3,5 mm	Steel	85 kg	right	Piece
17SB100=20	Without calf swing	20 mm	470 mm	3,5 mm	Steel	110 kg	both sides	Piece
17SB100=20-A	Without calf swing	20 mm	470 mm	6 mm	Aluminium	85 kg	both sides	Piece
17SB100=20-L	With calf swing	20 mm	470 mm	3,5 mm	Steel	110 kg	left	Piece
17SB100=20-R	With calf swing	20 mm	470 mm	3,5 mm	Steel	110 kg	right	Piece

- Available versions: With or without calf swing
- Available sizes: 10, 12, 14, 16, 20
- Variants without calf swing in aluminium not available in size 10.
- Note the deviating weight limits for sizes 12, 14, 16, 20.
- Available materials: Steel (-), Variants without calf swing: Steel (-), aluminium (A)
- Available sides (for variants with calf swing): right (R), left (L)
- Variants without calf swing can be used in a side-neutral way.



17B26 System knee joint

Medial joint has contoured bottom and straight top, straight lateral joint, free motion, with ball bearing, joint centre shifted 16 mm in posterior direction



Technical data

Article number	Side	System width	Length from joint centre upper	Length from joint centre lower	Material	Quantity unit
17B26=L16	left (L)	16 mm	33 mm	38 mm	Stainless steel	Pair
17B26=R16	right (R)	16 mm	33 mm	38 mm	Stainless steel	Pair
17B26=L20	left (L)	20 mm	33 mm	38 mm	Stainless steel	Pair
17B26=R20	right (R)	20 mm	33 mm	38 mm	Stainless steel	Pair



17B47 System knee joint

Medial and lateral joint are straight, free motion, with ball bearing, joint centre shifted 16 mm in posterior direction



Technical data

Article number	System width	Length from joint centre upper	Length from joint centre lower	Material	Quantity unit
17B47=16	16 mm	33 mm	38 mm	Stainless steel	Pair
17B47=20	20 mm	33 mm	38 mm	Stainless steel	Pair



17B3 System knee joint

Medial joint has contoured bottom and straight top, straight lateral joint, free motion, with ball bearing, joint centre shifted 22 mm in posterior direction



Technical data

Article number	Side	System width	Length from joint centre upper	Length from joint centre lower	Material	Quantity unit
17B3=L16	left (L)	16 mm	33 mm	38 mm	Stainless steel	Pair
17B3=R16	right (R)	16 mm	33 mm	38 mm	Stainless steel	Pair
17B3=L20	left (L)	20 mm	33 mm	38 mm	Stainless steel	Pair
17B3=R20	right (R)	20 mm	33 mm	38 mm	Stainless steel	Pair



17B43 System knee joint

Medial and lateral joint are straight, free motion, with ball bearing, joint centre shifted 22 mm in posterior direction



Technical data

Article number	System width	Length from joint centre upper	Length from joint centre lower	Material	Quantity unit
17B43=16	16 mm	33 mm	38 mm	Stainless steel	Pair
17B43=20	20 mm	33 mm	38 mm	Stainless steel	Pair

Spare parts for 17B26, 17B47, 17B3, 17B43

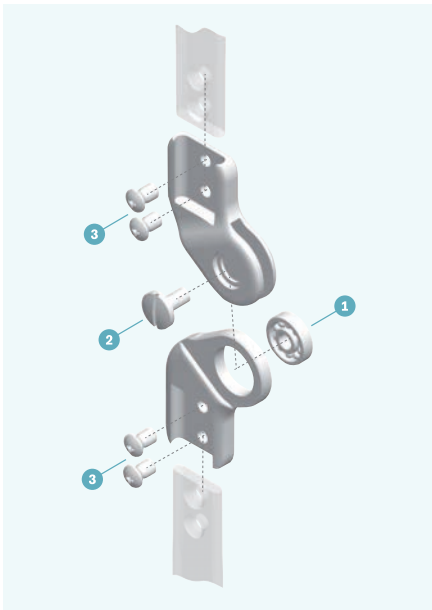

1) 509K11 Ball bearing

Technical data

Article number	Quantity unit
509K11=5X16X4	Piece

2) 501A6 Oval head screw, slotted and partially threaded

Technical data

Article number	Material	Quantity unit
501A6=4X5XM5	Stainless steel	Piece

3) 501T7 Phillips oval countersunk head screw

Technical data

Article number	Head Ø	Length	Material	Quantity unit
501T7=7.5X9XM5	7.5 mm	9 mm	Stainless steel	Piece

Accessory for 17B26, 17B47, 17B3, 17B43



17Y32 System extension assist

with two rubber rings

Technical data

Article number	Quantity unit
17Y32	Piece



17Y35 System extension assist

with two rubber rings

Technical data

Article number	Quantity unit
17Y35	Piece

Spare parts for 17Y32, 17Y35



18Z1 Rubber ring

Service parts for 17Y32 and 17Y35

Technical data

Article number	Outside Ø	Inner Ø
18Z1=20.8X14.5	20.8 mm	14.5 mm
18Z1=24.6X18.3	24.6 mm	18.3 mm



18Z2 Rubber ring

Service parts for 17Y32 and 17Y35

Technical data

Article number	Outside Ø	Inner Ø
18Z2=26.8X17.7	26.8 mm	17.7 mm
18Z2=21X12.9	21 mm	12.9 mm



501S43 Flat head screw

Technical data

Article number
501S43=M3X4

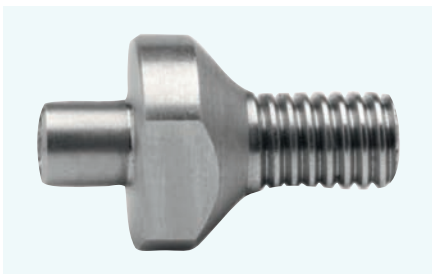

501S79 Special screw

To attach the extension assist

Technical data

Article number
501S79=M5X4.1X16.1
501S79=M5X5.1X17.1



507S11 Serrated lock washer

Technical data

Article number
507S11=5.3



17B46 System knee joint

Contoured medial joint, straight lateral joint, double joints with gear drive and ball bearings



Technical data

Article number	System width	Length from joint centre upper	Posterior offset	Material	Quantity unit
17B46=20	20 mm	38 mm	18 mm	Stainless steel	Pair



17B71 System knee joint

Polycentric system knee joint

Straight medial and lateral joints, polycentric with gear drive and ball bearings



Technical data

Article number	System width	Length from joint centre upper	Posterior offset	Material	Quantity unit
17B71=16	16 mm	38 mm	18 mm	Stainless steel	Pair

Spare parts for 17B46, 17B71

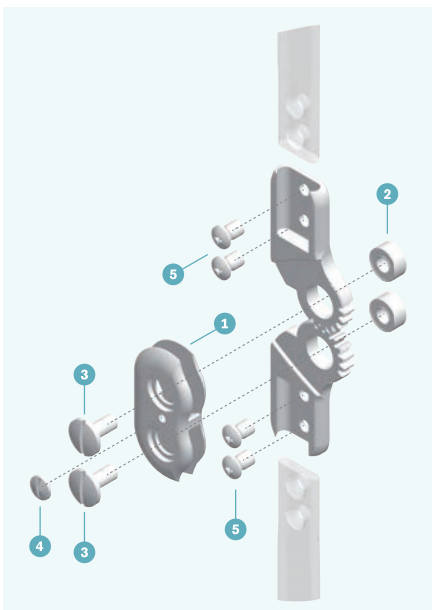

1) 7Y19 Medial joint piece

Technical data

Article number	Quantity unit
7Y19	Piece

2) 509K12 Ball bearing

Technical data

Article number	Quantity unit
509K12	Piece

3) 501A6 Oval head screw, slotted and partially threaded

Technical data

Article number	Material	Quantity unit
501A6=5X5XM5	Stainless steel	Piece

4) 501S22 Slotted oval head screw (lock screw)

Technical data

Article number	Material	Quantity unit
501S22=8XM3.5	Stainless steel	Piece

5) 501T7 Phillips oval countersunk head screw

Technical data

Article number	Head Ø	Length	Material	Quantity unit
501T7=7.5X9XM5	7.5 mm	9 mm	Stainless steel	Piece

Selection guide SCO*

*Stance phase controlled orthosis systems.

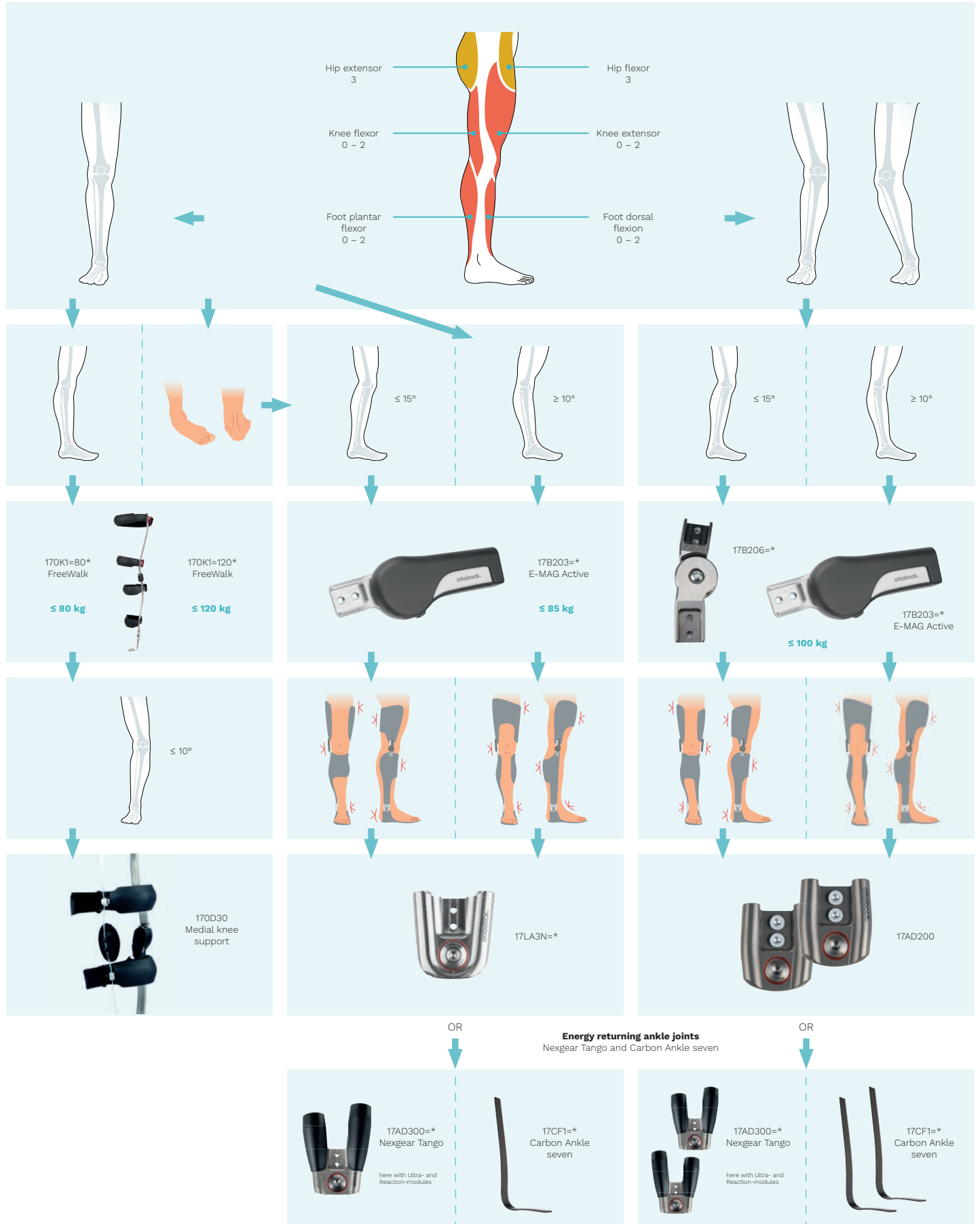



170K1 FreeWalk orthotic system

The FreeWalk permits a virtually natural gait as well as more safety and stability for patients with complete or partial paralysis of one leg.

The FreeWalk orthosis is pre-fabricated for the first fitting according to your specifications. The tool kit and datasheets are required to record the measurements needed for the fabrication of the orthosis.

Technical data

Article number	Side	for patient weight up to	Colour
170K1=L-80-0	left (L)	80 kg	Beige
170K1=R-80-0	right (R)	80 kg	Beige
170K1=L-80-7	left (L)	80 kg	Black
170K1=R-80-7	right (R)	80 kg	Black
170K1=L-120-0	left (L)	120 kg	Beige
170K1=R-120-0	right (R)	120 kg	Beige
170K1=L-120-7	left (L)	120 kg	Black
170K1=R-120-7	right (R)	120 kg	Black

- With height-adjustable pad retainers
- On request, you can order a test orthosis on loan in order to carry out a functional test with your patient. Please contact your customer service representative or regional contact person regarding this!
- Please note that the insole must also be sent to us.



Practical recommendation

- We recommend using micro hook-and-loop on velour and hook on loop.

Secure stance phase – light and inconspicuous

Slim-line design padding

Attractive new padding design ensures that the orthosis has an optimal, slim-line fit to the contours of the leg.

Knee joint

By securing the leg in the stance phase and unlocking the knee joint in the swing phase, the connection with the ankle joint enables a smooth and virtually physiological gait pattern for the user. The enclosed knee joint design provides secure protection against external impacts. Clothing cannot get caught either.

Ankle joint

The ankle joint has been optimised to allow it to be easily fine-tuned to user. The freely adjustable angle between the ankle joint and foot stirrup makes it simple to optimise the functionality of the FreeWalk. A graduated measuring scale allows settings to be easily reproduced. The height of the foot stirrup can also be adjusted. The increased number of setting options on the foot section is a new feature. This makes it possible to attain a lower structural height, so the orthosis can also be adapted to shorter users. The ankle screw is now made of a non-corrosive material.



Closures

Red closures are now also available as a new, attractive colour option (article no.: 170D20=2).

Clamp adapters

The new FreeWalk features new sliding and rotating clamp adapters. In contrast to the previous model, where the clamp adapters were bonded with adhesives, the screws can now be loosened. This allows the straps to be better adjusted to users and their individual requirements.

Three-way switch

A three-way switch now comes standard on the new FreeWalk (Reference number 170D71). This allows the user to choose between the “free-moving”, “locked” and “FreeWalk mode” settings. Older FreeWalk orthoses can be retrofitted with the new three-way switch.

Accessory for 170K1



170D30 Medial knee guide

Guiding the knee in the medial direction allows treatment for 5° more valgus deformity.

Technical data

Article number	for patient weight up to	Colour	Quantity unit
170D30=120-7	120 kg	Black	Set
170D30=80-7	80 kg	Black	Set



170W23 Calibration set

The calibration set makes it possible to order the FreeWalk orthosis using a photo

Technical data

Article number
170W23



170W4 Tension band

The tension band is also part of the 170W23 calibration set

Technical data

Article number
170W4



743B4 Spring-tensioned measuring tape

The Ottobock measuring tape is a double-sided measuring tape with a spring balance and cm/cm graduation.

Technical data

Article number	743B4
Product features	Double-sided cm/cm
Length	1,500 mm

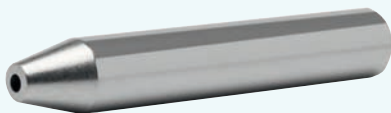

170W14 Mounting aid

Assembly aid for roll pin

Technical data

Article number
170W14



170W12 Pad retainer bending tool

Bending tool for the FreeWalk orthosis

Technical data

Article number
170W12=1
170W12=2

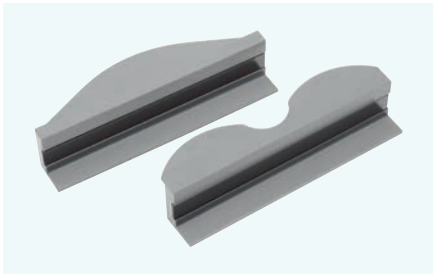

170W11 Frontal contour bending tool

Bending tool for the FreeWalk orthosis

Technical data

Article number
170W11



170W13 Aluminium threaded jaws

Threaded jaws made of aluminium for the FreeWalk orthosis

Technical data

Article number
170W13

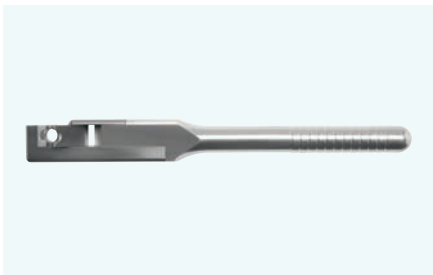

170W18 Bending iron

Tools for bending lamination and side bars

Technical data

Article number
170W18

Spare parts for 170K1



170D69 Pad button

Pad button for the FreeWalk orthosis

Technical data

Article number	Spare part for	Thread	Quantity unit
170D69	170K1=L-80-0	M4	Piece
	170K1=R-80-0		
	170K1=L-80-7		
	170K1=R-80-7		
	170K1=L-120-0		
	170K1=R-120-0		
	170K1=L-120-7		
	170K1=R-120-7		

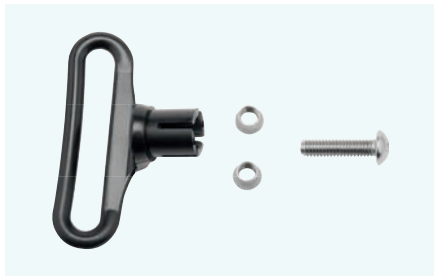

170D18 Strap guide loop with tube connection

Strap guide loop for attaching the hook-and-loop straps at the medial end of the support tube, beige

Technical data

Article number	Spare part for	Colour	Quantity unit
170D18=120-7	170K1=L-120-7 170K1=R-120-7	Black	Piece
170D18=80-7	170K1=L-80-7 170K1=R-80-7	Black	Piece
170D18=80-0	170K1=L-80-0 170K1=R-80-0	Beige	Piece
170D18=120-0	170K1=L-120-0 170K1=R-120-0	Beige	Piece

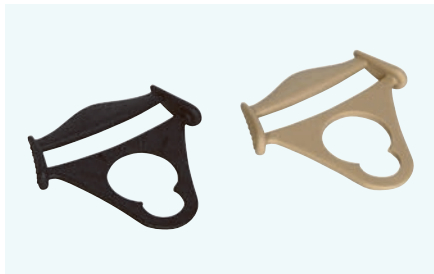

170D20 Strap guide loop for pad button

The strap guide loop is used with the 170D17 pad button and prevents the loops from twisting.

Technical data

Article number	Spare part for	Colour	Order unit
170D20=0	170K1=L-80-0 170K1=R-80-0 170K1=L-120-0 170K1=R-120-0	Beige	Piece(s)
170D20=7	170K1=L-80-7 170K1=R-80-7 170K1=L-120-7 170K1=R-120-7	Black	Piece(s)



170D29 Y-hook-and-loop with PU coating

Y-hook-and-loop for the FreeWalk orthosis and the silicone ankle foot orthosis

Technical data

Article number	Spare part for	Width	Colour	Quantity unit
170D29=38-0	170K1=L-80-0 170K1=R-80-0 170K1=L-120-0 170K1=R-120-0	38 mm	Beige	Piece
170D29=38-7	170K1=L-80-7 170K1=R-80-7 170K1=L-120-7 170K1=R-120-7	38 mm	Black	Piece

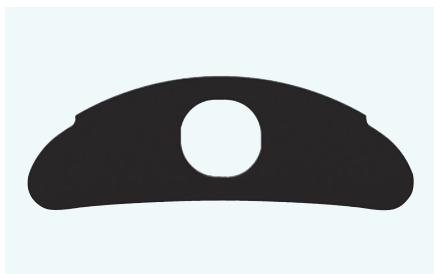

170D100 Foam pads

Foam pads for FreeWalk

Technical data

Article number	Spare part for	Length	Colour	Quantity unit
170D100=1-0	170K1=L-80-0 170K1=R-80-0 170K1=L-120-0 170K1=R-120-0	large	Beige	Piece
170D100=2-0	170K1=L-80-0 170K1=R-80-0 170K1=L-120-0 170K1=R-120-0	large	Beige	Piece
170D100=1-7	170K1=L-80-7 170K1=R-80-7 170K1=L-120-7 170K1=R-120-7	large	Black	Piece
170D100=2-7	170K1=L-80-7 170K1=R-80-7 170K1=L-120-7 170K1=R-120-7	large	Black	Piece

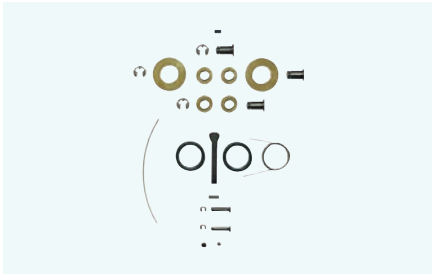

170X18 Maintenance set for FreeWalk

For the maintenance of the FreeWalk orthosis

Technical data

Article number	Spare part for	Quantity unit
170X18	170K1=L-80-0 170K1=R-80-0 170K1=L-80-7 170K1=R-80-7 170K1=L-120-0 170K1=R-120-0 170K1=L-120-7 170K1=R-120-7	Set



170Z120 Joint protector

For the protection of the knee joint of the FreeWalk orthosis

Technical data

Article number	Spare part for	Colour	Quantity unit
170Z120=0	170K1=L-80-0 170K1=R-80-0 170K1=L-120-0 170K1=R-120-0	Beige	Set
170Z120=7	170K1=L-80-7 170K1=R-80-7 170K1=L-120-7 170K1=R-120-7	Black	Set



170Z4 Hook-and-loop strap

Made especially for FreeWalk orthosis

Technical data

Article number	Spare part for	Length	Width	Colour	Quantity unit
170Z4=400-0	170K1=L-80-0 170K1=R-80-0 170K1=L-120-0 170K1=R-120-0	400 mm	40 mm	Beige	Piece
170Z4=400-7	170K1=L-80-7 170K1=R-80-7 170K1=L-120-7 170K1=R-120-7	400 mm	40 mm	Black	Piece
170Z4=600-0	170K1=L-80-0 170K1=R-80-0 170K1=L-120-0 170K1=R-120-0	600 mm	40 mm	Beige	Piece
170Z4=600-7	170K1=L-80-7 170K1=R-80-7 170K1=L-120-7 170K1=R-120-7	600 mm	40 mm	Black	Piece



Practical recommendation

- Close before washing to protect the closure and/or other items in the wash.



170Z99 Locks, Complete (Knee Lock)

Maintenance set for FreeWalk lock

Technical data

Article number	Spare part for	Quantity unit
170Z99=2	170K1=L-80-0 170K1=R-80-0 170K1=L-80-7 170K1=R-80-7 170K1=L-120-0 170K1=R-120-0 170K1=L-120-7 170K1=R-120-7	Set



170D71 Triple control

For switching the knee joint between the locked, free-moving and stance phase control functions.

Technical data

Article number	Spare part for	for patient weight up to	Colour	Quantity unit
170D71=0	170K1=L-80-0 170K1=R-80-0 170K1=L-120-0 170K1=R-120-0	80/ 120 kg	Beige	Piece
170D71=7	170K1=R-80-7 170K1=L-80-7 170K1=L-120-7 170K1=R-120-7	80/ 120 kg	Black	Piece



170D83 Cap screw, glass bead blasted

Glass bead blasted cap screw for the FreeWalk orthosis

Technical data

Article number	Spare part for
170D83=M4X12-TX20	170K1=L-80-0 170K1=R-80-0 170K1=L-80-7 170K1=R-80-7 170K1=L-120-0 170K1=R-120-0 170K1=L-120-7 170K1=R-120-7



501F9 Screw with flattened half-round head

Dummy screw for 17AD100A=DY*

Technical data

Article number	Spare part for	Quantity unit
501F9=M6X10-1	170K1=L-80-0 170K1=R-80-0 170K1=L-80-7 170K1=R-80-7 170K1=L-120-0 170K1=R-120-0 170K1=L-120-7 170K1=R-120-7	Piece



170D73 Wedge

Wedge for the FreeWalk orthosis

Technical data

Article number	Spare part for
170D73=120	170K1=L-80-0 170K1=R-80-0 170K1=L-80-7 170K1=R-80-7 170K1=L-120-0 170K1=R-120-0 170K1=L-120-7 170K1=R-120-7

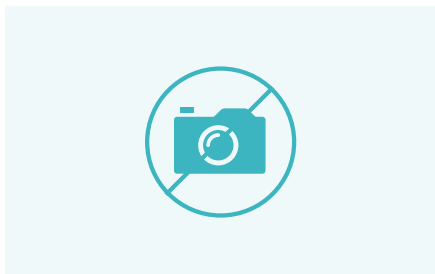

170Z96 Steel cable for lock

Diameter: 0.36 mm, strength: 1570 N/mm², 49-core

Technical data

Article number	Spare part for
170Z96	170K1=L-80-0 170K1=R-80-0 170K1=L-80-7 170K1=R-80-7 170K1=L-120-0 170K1=R-120-0 170K1=L-120-7 170K1=R-120-7



170X17N Adjustable ankle joint

Ankle joint for the FreeWalk orthosis

Technical data

Article number	Spare part for
170X17N=L	170K1=L-80-0 170K1=L-80-7 170K1=L-120-0 170K1=L-120-7
170X17N=R	170K1=R-80-0 170K1=R-80-7 170K1=R-120-0 170K1=R-120-7

Spare parts for 170X17N



170D33 Ankle setting nut

Ankle setting nut for the 170X17N adjustable ankle joint

Technical data

Article number
170D33



170D28 Threaded plate

Threaded plate for 170X17N adjustable ankle joint

Technical data

Article number	Quantity unit
170D28	Piece

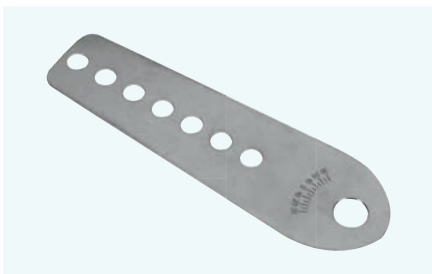

170F14 Foot stirrup, upper section

Foot stirrup upper section for the 170X17N adjustable ankle joint

Technical data

Article number
170F14



501F9 Screw with flattened half-round head

Dummy screw for 17AD100A=DY*

Technical data

Article number	Spare part for	Quantity unit
501F9=M6X10-1	170X17=L 170X17=R 170X17N=L 170X17N=R	Piece



170F15 Foot stirrup, lower section

Foot stirrup lower section for the 170X17N adjustable ankle joint

Technical data

Article number
170F15



501F9 Screw with flattened half-round head

Dummy screw for 17AD100A=DY*

Technical data

Article number	Spare part for	Quantity unit
501F9=M4X4	170X17N=L 170X17N=R	Piece



17B203 E-MAG Active

Launched in 2008, the E-MAG Active has proven to be a groundbreaking innovation in the development of orthotic knee joint systems. It has defined new standards in dynamics and mobility.

Key features

- The PreLock function secures the user's knee joint even before full, maximum extension is achieved.
- A sensor system measures the leg position during walking and controls the orthotic joint
- The user can benefit from the functionality of the orthotic joint even if they have no function in their ankle
- It is suitable for users with a greater need for mobility who were previously unable to obtain an adequate orthotic treatment
- Using the E-MAG Active can prevent contractures and joint damage caused by immobilisation, reduce muscular atrophy and build up existing muscles
- It provides relief for the contralateral side and helps the user avoid making compensatory movements
- Less energy is required for walking, and users benefit from increased mobility



Scope of delivery

30G70	E-MAG Active knee joint	1	Piece(s)
317B3	Control electronics	1	Piece(s)
317B20	E-Mag battery	2	Piece(s)
317E20	Battery connection cable	1	Piece(s)
317R20	Lock unit for battery	1	Piece(s)
30Y140	Cable dummy	1	Piece(s)
21A45=0.60	Perlon cable, 0.60 m long	1	Piece(s)
317X203	Dummy for knee joint	1	Piece(s)
317Z21	Akkumulator mounting frame-SET	1	Piece(s)
317Z13	Electronic mounting frame-SET	1	Piece(s)
317E2	Electronics cable	1	Piece(s)
30G72	E-MAG case with inlays	1	Piece(s)
646H17=ALL_INT	Quick start guide for E-MAG Active user	1	Piece(s)
647G1165=ALL_INT	Instructions for use (qualified personnel) 17B203=* E-MAG Active	1	Piece(s)
647H648=ALL_INT	Instructions for use (user) 17B203=* E-MAG Active	1	Piece(s)

Technical data

Article number	Side	Flexion angle
17B203=L	left (L)	5 °
17B203=R	right (R)	5 °
17B203=L-7.5	left (L)	7.5 °
17B203=R-7.5	right (R)	7.5 °

- Certification of competence is recommended for the E-MAG Active and can be obtained using an e-learning tool.
- Caution! Please always indicate the serial number of the entire E-MAG Active package when ordering spare parts, especially when ordering electronic components.

Greater mobility in everyday life

3

Control electronics

The control electronics process all data and control the knee joint functions.

Rechargeable battery

The battery can be removed for recharging.

PreLock function

The PreLock function already secures the knee joint at 15° of flexion and then locks it for the stance phase prior to full extension.

Switching mode

The switch allows the user to change to cycling mode.

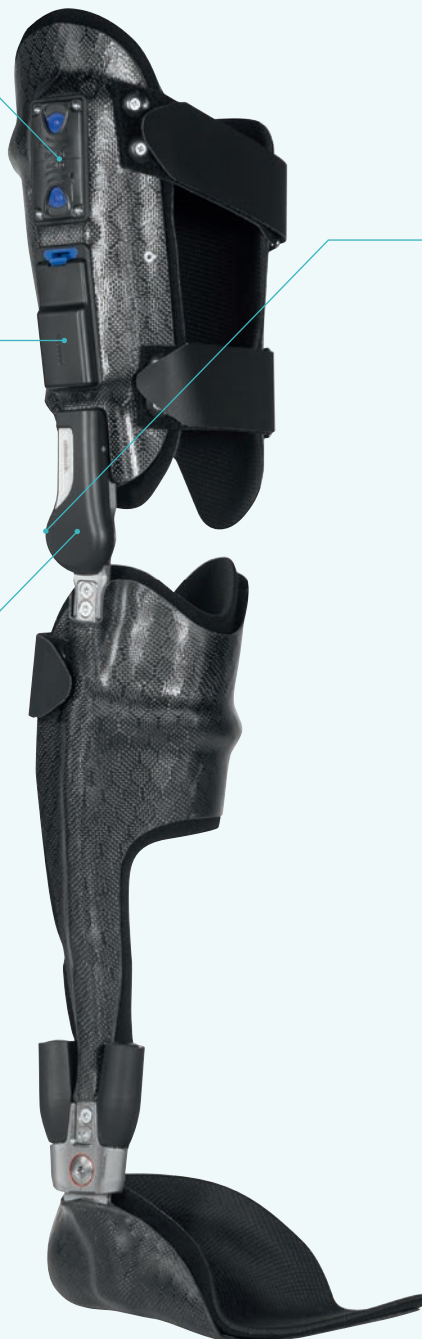

Spare parts for 17B203



317X203 Dummy for knee joint

Technical data

Article number	Spare part for
317X203=L	17B203=L
317X203=R	17B203=R
317X203=L7.5	17B203=L-7.5
317X203=R7.5	17B203=R-7.5

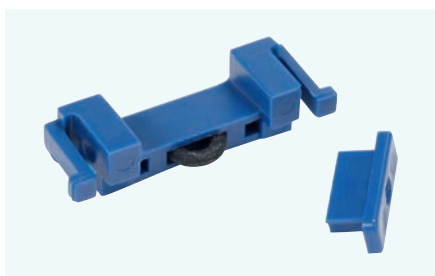

317R20 Lock unit for battery

Lock unit for E-MAG Active battery

Technical data

Article number	Spare part for
317R20	17B203=L 17B203=R 17B203=L-7.5 17B203=R-7.5



317E20 Connecting cable

Connecting cable for battery

Technical data

Article number	Spare part for	Quantity unit
317E20	17B203=L 17B203=R 17B203=L-7.5 17B203=R-7.5	Piece



317B20 Replaceable battery

Battery for use in E-MAG Active. The battery is used as a replacement in the course of treatment and is already included in the original scope of delivery for the joint.

Technical data

Article number	Spare part for	Quantity unit
317B20	17B203=L 17B203=R 17B203=L-7.5 17B203=R-7.5	Piece



317B3 Control electronics

Control electronics unit for the E-MAG Active

Technical data

Article number	Spare part for
317B3	17B203=L 17B203=R 17B203=L-7.5 17B203=R-7.5



30G70 E-MAG Active knee joint

Technical data

Article number	Spare part for
30G70=L	17B203=L
30G70=R	17B203=R
30G70=L7.5	17B203=L-7.5
30G70=R7.5	17B203=R-7.5



317L20 Battery charger

Charger for E-MAG Active rechargeable battery.

Technical data

Article number	Accessories for	Quantity unit
317L20	17B203=L 17B203=R 17B203=L-7.5 17B203=R-7.5	Piece



317E2 Electronics cable

Electronics cable for E-MAG Active

Technical data

Article number	Spare part for	Quantity unit
317E2	17B203=L 17B203=R 17B203=L-7.5 17B203=R-7.5	Piece

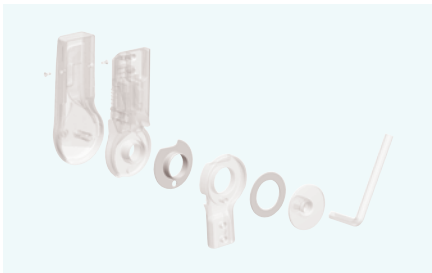

17BS203 Service set

Service set for the E-MAG Active orthotic knee joint (17B203)
Service set for maintenance of the joint bearing

Technical data

Article number	Spare part for	Quantity unit
17BS203	17B203=L 17B203=R 17B203=L-7.5 17B203=R-7.5	Piece



30Y438 Drive ring

Drive ring for the E-MAG Active

Technical data

Article number	Spare part for
30Y438	17B203=L 17B203=R 17B203=L-7.5 17B203=R-7.5



30Y140 Cable dummy

Cable dummy for the E-MAG Active

Technical data

Article number	Spare part for
30Y140	17B203=L 17B203=R 17B203=L-7.5 17B203=R-7.5



317Z13 Receptacle set (electronics)

Receptacle set (electronics), consisting of: electronics receptacle, dummy for receptacle, dummy for electronics

Technical data

Article number	Spare part for
317Z13	17B203=L 17B203=R 17B203=L-7.5 17B203=R-7.5



317Z21 Receptacle set

Receptacle set, consisting of battery receptacle, dummy for receptacle, dummy for battery

Technical data

Article number	Spare part for	Quantity unit
317Z21	17B203=L 17B203=R 17B203=L-7.5 17B203=R-7.5	Piece

· Caution! Please always indicate the serial number of the entire E-MAG when ordering spare parts, especially when ordering electronic components.



501S21 Countersunk screw

Phillips countersunk screw made of steel

Technical data

Article number	Spare part for	Thread
501S21=M2X5	17B203=L 17B203=R 17B203=L-7.5 17B203=R-7.5	M2



501S72 Oval head screw

Oval head screw with flat Allen head

Technical data

Article number	Spare part for	Thread
501S72=M3X12	17B203=L 17B203=R 17B203=L-7.5 17B203=R-7.5	M3



502S27 Hexagon nut

Technical data

Article number	Spare part for
502S27=M3	17B203=L 17B203=R 17B203=L-7.5 17B203=R-7.5



757L16-4 Power supply unit

The power supply for electronic prosthetic components and orthoses from Ottobock. Adapters for the EU and US are included in the scope of delivery. Additional adapters can be ordered under the following article numbers:

- Great Britain: 757S1=GB-4
- Australia: 757S1=AUS-4
- Argentina: 757S1=ARG-4

Technical data

Article number
757L16-4

- Adapters for the EU and US are included in the scope of delivery.



501S137 Countersunk head Torx screw

Countersunk screw with Torx head, galvanised, standard fracture torque of 7.6 Nm

Technical data

Article number	Spare part for	Quantity unit
501S137=M5X10	17B203=L 17B203=R 17B203=L-7.5 17B203=R-7.5	Piece

Accessory for 17B203



17B206 Medial support

Includes lamination dummy

Technical data

Article number	Max. body weight	Quantity unit
17B206	100 kg	Piece
17B206=7.5	100 kg	Piece



17LS3 Lamination bar

Lamination bar for unilateral and bilateral use for lamination resin or prepreg technique



Technical data

Article number	Length	Width	Thickness	Material	Quantity unit
17LS3=16	130 mm	16 mm	6 mm bottom/3 mm top	Stainless steel	Piece



17KL40 Knee joint with 4-in-1 option ring lock

Four options in one knee joint • Automatic ring lock • Manual ring lock • Ring lock with lever (17KL19=2 Duchenne bow kit) • Free motion

Key features

- Automatic ring lock
- Manual ring lock
- Ring lock with lever via the combination with the 17KL19=2 Duchenne bow kit: the ring lock connection with the bow ensures that the joint is easy to release, even under heavy flexion load, but is secure under load when closed.
- Free motion

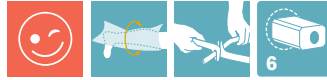

Technical data

Article number	Upper/lower bar length	Bar width	Bar thickness	Bar material	Quantity unit
17KL40=13	310/480 mm	13 mm	5 mm	Stainless steel	Pair
17KL40=13-A	310/ 480 mm	13 mm	5 mm	Aluminium	Pair
17KL40=16	400/ 560 mm	16 mm	5 mm	Stainless steel	Pair
17KL40=16-A	400/ 560 mm	16 mm	5 mm	Aluminium	Pair
17KL40=20	400/ 560 mm	20 mm	5 mm	Stainless steel	Pair
17KL40=20-A	400/ 560 mm	20 mm	5 mm	Aluminium	Pair

- Automatic = a spring presses the ring lock into the locked position
- Manual = the ring lock must be manually moved into the locked position

Spare parts for 17KL40



17KS=8 Service set

Service set for 17KL40

Technical data

Article number	Scope of delivery
17KS=8	Bearing nut Bushing Flat round disk with slot Truss head screw with slot Red washer Spring tappe Compression spring Face plate

Accessory for 17KL40



17KL19 Duchenne bow kit

Named after Duchenne muscular dystrophy, because flexion contractures occur at an early stage with patients affected by this disease. The ring lock connection with the bow ensures that the joint is easy to release, even under heavy flexion load, but is secure under load when closed.

Technical data

Article number	Accessory for
17KL19=2	17KL40=13 17KL40=13-A 17KL40=16 17KL40=16-A 17KL40=20 17KL40=20-A



743Y57 Alignment insert set

Alignment insert set for conventional orthotic joints

Technical data

Article number	Accessory for
743Y57	17KL40=13 17KL40=13-A 17KL40=16 17KL40=16-A 17KL40=20 17KL40=20-A

- The 743Y57 is a set consisting of the alignment inserts in sizes 5 through 9.



17K29 Knee joint bar for children

Locked joint bar with manual ring lock, flat bar profile



Technical data

Article number	Milled head Ø	Upper/lower bar length	Bar width	Bar thickness	Material	Quantity unit
17K29=4	20 mm	410 / 390 mm	16 mm	3 mm	Stainless steel	Pair
17K29=5	18 mm	300 / 320 mm	14 mm	3 mm	Stainless steel	Pair
17K29=6	16 mm	220 / 250 mm	12 mm	3 mm	Stainless steel	Pair



Practical recommendation

- The following shoulder screws can be used with the 17K29/32/33/34/42 joint bars for children: 501A1=12x6xM4

Spare parts for 17K29

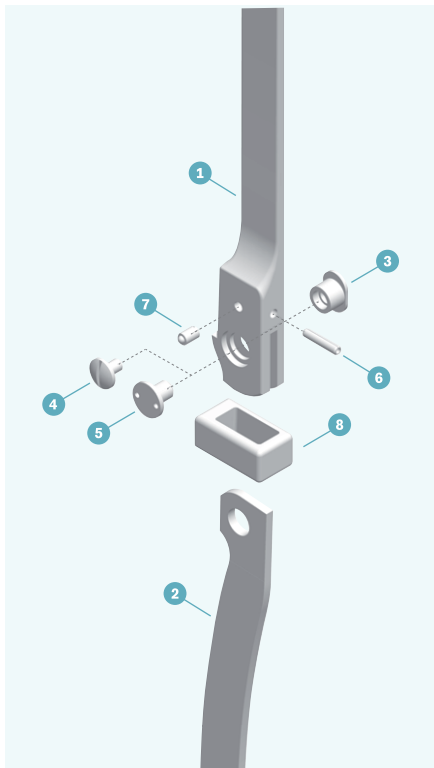

1) 17X7 Knee joint bar, upper section

Technical data

Article number	Spare part for	Side	Material	Quantity unit
17X7=L4	17K29=4	left	Stainless steel	Piece
17X7=R4	17K29=4	right	Stainless steel	Piece
17X7=L5	17K29=5	left	Stainless steel	Piece
17X7=R5	17K29=5	right	Stainless steel	Piece
17X7=L6	17K29=6	left	Stainless steel	Piece
17X7=R6	17K29=6	right	Stainless steel	Piece

2) 17U7 Knee joint bar, lower section

Technical data

Article number	Spare part for	Material	Quantity unit
17U7=4	17K29=4	Stainless steel	Piece
17U7=5	17K29=5	Stainless steel	Piece
17U7=6	17K29=6	Stainless steel	Piece

3) 17Y93 Bearing nut, hardened

Technical data

Article number	Spare part for	Insertion length	Profile length	Shank length	Thread	Shoulder Ø	Quantity unit
17Y93=6X6.7XM4	17K29=5 17K29=6	5.45 mm	12 mm	6.7 mm	M4	6 mm	Piece
17Y93=6.5X6.7XM4	17K29=5 17K29=6	5.45 mm	12 mm	6.7 mm	M4	6.5 mm	Piece
17Y93=7X6.7XM4	17K29=5 17K29=6	5.45 mm	12 mm	6.7 mm	M4	7 mm	Piece
17Y93=9X7.2XM6	17K29=4	6 mm	14 mm	7.2 mm	M6	9 mm	Piece
17Y93=9X9.2XM6		8 mm	14 mm	9.2 mm	M6	9 mm	Piece
17Y93=9.5X7.2XM6	17K29=4	6 mm	14 mm	7.2 mm	M6	9.5 mm	Piece
17Y93=10X7.2XM6	17K29=4	6 mm	14 mm	7.2 mm	M6	10 mm	Piece

4) 501S32 Slotted truss head screw

Technical data

Article number	Spare part for	Head Ø	Length	Thread	Material	Quantity unit
501S32=M4X10X9.5	17K29=5 17K29=6	10 mm	9.5 mm	M4	Stainless steel	Piece

5) 501S34 Joint Screw

Technical data

Article number	Spare part for	Material	Quantity unit
501S34=M6	17K29=4	Stainless steel	Piece

6) 506S1 Clamping sleeve

Technical data

Article number	Quantity unit
506S1=3X14	Piece

7) 501D1 Spring-loaded thrust piece

Technical data

Article number	Spare part for	Material	Quantity unit
501D1	17K29=4 17K29=5 17K29=6	Stainless steel	Piece

8) 17Y13 Ring lock

Technical data

Article number	Spare part for	Material	Quantity unit
17Y13=4	17K29=4	Stainless steel	Piece
17Y13=5	17K29=5 17K29=6	Stainless steel	Piece



17KL6 Knee joint with ring lock

Straight medial and lateral joints, with automatic ring lock

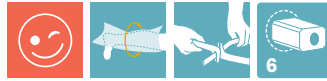

Technical data

Article number	Upper/lower bar length	Bar width	Bar thickness	Bar material	Quantity unit
17KL6=13-A	300 / 500 mm	13 mm	5 mm	Aluminium	Pair
17KL6=13-CS	300 / 500 mm	13 mm	5 mm	Steel	Pair
17KL6=16-A	400 / 570 mm	16 mm	6.35 mm	Aluminium	Pair
17KL6=16-CS	400 / 570 mm	16 mm	5 mm	Steel	Pair

· Automatic = a spring presses the ring lock into the locked position

Spare parts for 17KL6



17KS=6 Service set

Service set for size 13 (aluminium) 17KL6 and 17KL7 knee joints

Technical data

Article number	Spare part for	Scope of delivery
17KS=6	17KL6=13-A 17KL7=13-A	Bearing nut Bushing Face plate Flat round disk with slot Red washer Compression spring Truss head screw with slot Spring-loaded thrust piece



17KHS=3 Service set

Service set for size 13 (steel) 17KF1, 17KL6 and 17KL7 knee joints as well as the 17HF1, 17HL1, 17HL4 and 17HL5 hip joints

Technical data

Article number	Spare part for	Scope of delivery
17KHS=3	17KL6=13-CS	Bearing nut Bushing Flat round disk with slot Red washer Compression spring Truss head screw with slot Spring-loaded thrust piece



17KS=4 Service set

Service set for size 16 (aluminium) 17KL6 and 17KL7 knee joints

Technical data

Article number	Spare part for	Scope of delivery
17KS=4	17KL6=16-A	Bearing nut Bushing Face plate Flat round disk with slot Red washer Compression spring Truss head screw with slot Spring-loaded thrust piece



17KHS=2 Service set

Service set for size 16 (steel) 17KF1, 17KL6 and 17KL7 knee joints as well as the 17HF1, 17HL1 and 17HL4 hip joints

Technical data

Article number	Spare part for	Scope of delivery
17KHS=2	17KL6=16-CS	Bearing nut Bushing Flat round disk with slot Red washer Compression spring Truss head screw with slot Spring-loaded thrust piece

Accessory for 17KL6



743Y57 Alignment insert set

Alignment insert set for conventional orthotic joints

Technical data

Article number	Accessory for
743Y57	17KL6=13-A 17KL6=13-CS 17KL6=16-A 17KL6=16-CS

· The 743Y57 is a set consisting of the alignment inserts in sizes 5 through 9.



17KL19 Chailey kit

Bow for unlocking the 17KL6=* ring lock joints

Technical data

Article number	Accessory for
17KL19=3	17KL6=16-A 17KL6=16-CS
17KL19=5	17KL6=13-A 17KL6=13-CS



17KL7 Knee joint with ring lock

Straight medial and lateral joints, with manual ring lock

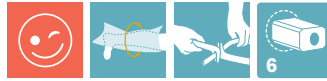

Technical data

Article number	Upper/lower bar length	Bar width	Bar thickness	Bar material	Quantity unit
17KL7=13-A	300 / 500 mm	13 mm	5 mm	Aluminium	Pair
17KL7=13-CS	300 / 500 mm	13 mm	5 mm	Steel	Pair
17KL7=16-A	400 / 570 mm	16 mm	6.35 mm	Aluminium	Pair
17KL7=16-CS	400 / 570 mm	16 mm	5 mm	Steel	Pair

· Manual = the ring lock must be manually moved into the locked position

Spare parts for 17KL7



17KS=6 Service set

Service set for size 13 (aluminium) 17KL6 and 17KL7 knee joints

Technical data

Article number	Spare part for	Scope of delivery
17KS=6	17KL7=13-A	Bearing nut Bushing Face plate Flat round disk with slot Red washer Compression spring Truss head screw with slot Spring-loaded thrust piece



17KHS=3 Service set

Service set for size 13 (steel) 17KF1, 17KL6 and 17KL7 knee joints as well as the 17HF1, 17HL1, 17HL4 and 17HL5 hip joints

Technical data

Article number	Spare part for	Scope of delivery
17KHS=3	17KL7=13-CS	Bearing nut Bushing Flat round disk with slot Red washer Compression spring Truss head screw with slot Spring-loaded thrust piece



17KS=4 Service set

Service set for size 16 (aluminium) 17KL6 and 17KL7 knee joints

Technical data

Article number	Spare part for	Scope of delivery
17KS=4	17KL7=16-A	Bearing nut Bushing Face plate Flat round disk with slot Red washer Compression spring Truss head screw with slot Spring-loaded thrust piece



17KHS=2 Service set

Service set for size 16 (steel) 17KF1, 17KL6 and 17KL7 knee joints as well as the 17HF1, 17HL1 and 17HL4 hip joints

Technical data

Article number	Spare part for	Scope of delivery
17KHS=2	17KL7=16-CS	Bearing nut Bushing Flat round disk with slot Red washer Compression spring Truss head screw with slot Spring-loaded thrust piece

Accessory for 17KL7



743Y57 Alignment insert set

Alignment insert set for conventional orthotic joints

Technical data

Article number	Accessory for
743Y57	17KL7=13-A 17KL7=13-CS 17KL7=16-A 17KL7=16-CS

· The 743Y57 is a set consisting of the alignment inserts in sizes 5 through 9.



17KL8 Knee joint with ring lock

Straight medial and lateral joints, with automatic ring lock, reinforced version of the 17KL6 knee joint



Technical data

Article number	Upper/lower bar length	Bar width	Bar thickness	Bar material	Quantity unit
17KL8=16-CS	400 / 570 mm	16 mm	6.35 mm	Steel	Pair
17KL8=20-CS	400 / 570 mm	20 mm	7 mm	Steel	Pair

· Automatic = a spring presses the ring lock into the locked position



17KL9 Knee joint with ring lock

Straight medial and lateral joints, with manual ring lock, reinforced version of the 17KL7 knee joint



Technical data

Article number	Upper/lower bar length	Bar width	Bar thickness	Bar material	Quantity unit
17KL9=16-CS	400 / 570 mm	16 mm	6.35 mm	Steel	Pair
17KL9=20-CS	400 / 570 mm	20 mm	7 mm	Steel	Pair

· Manual = the ring lock must be manually moved into the locked position

Spare parts for 17KL8, 17KL9

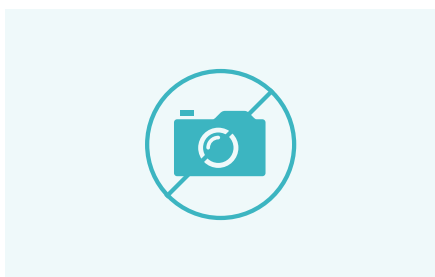

17KS=1 Service set

Service set for size 16 (steel) 17KL8 and 17KL9 knee joints

Technical data

Article number	Spare part for	Scope of delivery
17KS=1	17KL8=16-CS 17KL9=16-CS	Bearing nut Bushing Flat round disk with slot Red washer Compression spring Truss head screw with slot Spring-loaded thrust piece



17KS=7 Service set

Service set for size 20 (steel) 17KL6 and 17KL7 knee joints

Technical data

Article number	Spare part for	Scope of delivery
17KS=7	17KL8=20-CS 17KL9=20-CS	Bearing nut Bushing Flat round disk with slot Red washer Compression spring Truss head screw with slot

Accessory for 17KL8, 17KL9



743Y57 Alignment insert set

Alignment insert set for conventional orthotic joints

Technical data

Article number	Accessory for
743Y57	17KL8=16-CS 17KL8=20-CS 17KL9=16-CS 17KL9=20-CS

· The 743Y57 is a set consisting of the alignment inserts in sizes 5 through 9.



17KL30 Knee joint with open Swiss lock

Straight medial and lateral joints, with open Swiss lock

- Easy to unlock
- Lever included



Technical data

Article number	Upper/lower bar length	Bar width	Bar thickness	Bar material	Quantity unit
17KL30=16-CS	400 / 570 mm	16 mm	5 mm	Steel	Pair
17KL30=20-A	400 / 570 mm	20 mm	5 mm	Aluminium	Pair

Spare parts for 17KL30

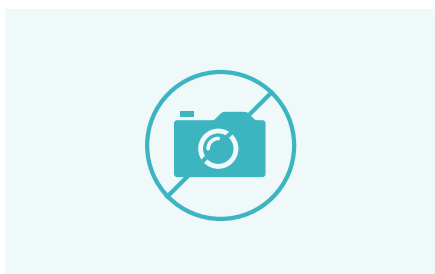

17KS=14 Service set

Service set for the 17KL30 knee joint

Technical data

Article number	Spare part for	Scope of delivery
17KS=14	17KL30=16-CS 17KL30=20-A	Flat round disk with slot Red washer Bearing nut Bushing Face plate

Accessory for 17KL30



743Y57 Alignment insert set

Alignment insert set for conventional orthotic joints

Technical data

Article number	Accessory for
743Y57	17KL30=16-CS 17KL30=20-A

· The 743Y57 is a set consisting of the alignment inserts in sizes 5 through 9.



17KL20 Knee joint with covered Swiss lock

Straight medial and lateral joints, with covered Swiss lock



Technical data

Article number	Upper/lower bar length	Bar width	Bar thickness	Version	Bar material	Quantity unit
17KL20=13	300 / 490 mm	13 mm	5 mm	Straight	Stainless steel	Pair
17KL20=13-A	300 / 490 mm	13 mm	5 mm	Straight	Aluminium	Pair
17KL20=20	400 / 560 mm	20 mm	5 mm	Straight	Stainless steel	Pair
17KL20=20-A	400 / 560 mm	20 mm	5 mm	Straight	Aluminium	Pair

Spare parts for 17KL20



17KS=9 Service set

Service set for size 13 17KL20 knee joint

Technical data

Article number	Spare part for	Scope of delivery
17KS=9	17KL20=13-A 17KL20=13	Bearing nut Flat round disk with slot Red washer Lock washer Washer Bale pin Compression spring

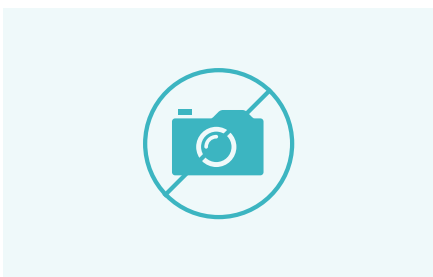

17KS=10 Service set

Service set for size 20 17KL20 knee joint

Technical data

Article number	Spare part for	Scope of delivery
17KS=10	17KL20=20-A 17KL20=20	Bearing nut Flat round disk with slot Red washer Lock washer Washer Bale pin Compression spring

Accessory for 17KL20



743Y57 Alignment insert set

Alignment insert set for conventional orthotic joints

Technical data

Article number	Accessory for
743Y57	17KL20=13 17KL20=13-A 17KL20=20 17KL20=20-A

- The 743Y57 is a set consisting of the alignment inserts in sizes 5 through 9.



17MS30 Pull-release cable

The pull-release cable can be positioned anterior or posterior. Thanks to the change of direction, less force is required for pulling.

Technical data

Article number	Accessory for	Quantity unit
17MS30=A	17KL20=13 17KL20=13-A 17KL20=20 17KL20=20-A	Pair

- Thanks to the change of direction, less force is required for pulling.
- The pull-release cable can be installed in the anterior or posterior position.
- Side bars must be ordered separately.



17B42 Modular system knee joint

Locked knee joint with ring lock; straight medial and lateral joints



Technical data

Article number	System width	Milled head	Length from joint centre upper	Length from joint centre lower	Material	Quantity unit
17B42=16	16 mm	25x4 mm	56 mm	38 mm	Stainless steel	Pair
17B42=20	20 mm	25x4 mm	56 mm	38 mm	Stainless steel	Pair

Practical recommendation

- On worn joints, the tolerance can be reduced with the repair bolts. A suitable reamer is usually used for adaptation.



17B20 Modular system knee joint

Locked knee joint with ring lock; contoured medial joint, straight lateral joint



Technical data

Article number	Side	System width	Milled head	Length from joint centre upper	Length from joint centre lower	Material	Quantity unit
17B20=L16	left (L)	16 mm	25x4 mm	56 mm	38 mm	Stainless steel	Pair
17B20=R16	right (R)	16 mm	25x4 mm	56 mm	38 mm	Stainless steel	Pair
17B20=L20	left (L)	20 mm	25x4 mm	56 mm	38 mm	Stainless steel	Pair
17B20=R20	right (R)	20 mm	25x4 mm	56 mm	38 mm	Stainless steel	Pair

Practical recommendation

- On worn joints, the tolerance can be reduced with the repair bolts. A suitable reamer is usually used for adaptation.



17B21 Modular system knee joint

Locked knee joint with ring lock; contoured lower segment of medial joint, straight upper segment, straight lateral joint



Technical data

Article number	Side	System width	Milled head	Length from joint centre upper	Length from joint centre lower	Material	Quantity unit
17B21=L16	left (L)	16 mm	25x4 mm	56 mm	38 mm	Stainless steel	Pair
17B21=R16	right (R)	16 mm	25x4 mm	56 mm	38 mm	Stainless steel	Pair
17B21=L20	left (L)	20 mm	25x4 mm	56 mm	38 mm	Stainless steel	Pair
17B21=R20	right (R)	20 mm	25x4 mm	56 mm	38 mm	Stainless steel	Pair

Practical recommendation

- On worn joints, the tolerance can be reduced with the repair bolts. A suitable reamer is usually used for adaptation.

Spare parts for 17B42, 17B20, 17B21

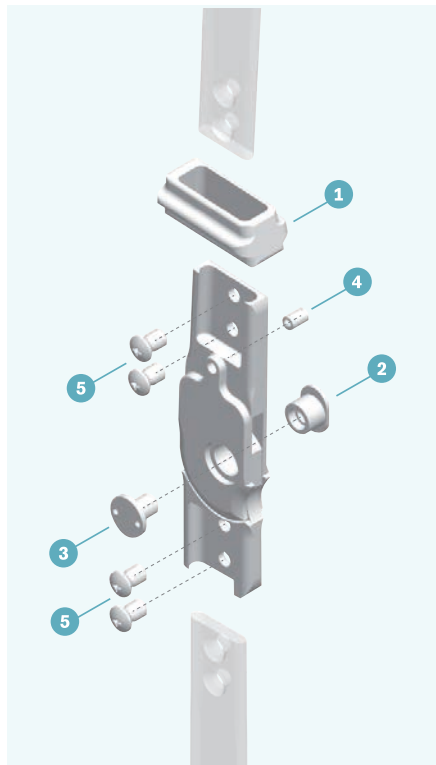

1) 17Y31 Ring lock

Technical data

Article number	Material	Quantity unit
17Y31=25X9.5	Stainless steel	Piece

2) 17Y93 Bearing nut, hardened

Technical data

Article number	Spare part for	Insertion length	Profile length	Shank length	Thread	Shoulder Ø	Quantity unit
17Y93=9X7.2XM6	17B20=L16 17B20=R16 17B20=L20 17B20=R20 17B21=L16 17B21=R16 17B21=L20 17B21=R20 17B42=16 17B42=20	6 mm	14 mm	7.2 mm	M6	9 mm	Piece
17Y93=9.5X7.2XM6	17B20=L16 17B20=R16 17B20=L20 17B20=R20 17B21=L16 17B21=R16 17B21=L20 17B21=R20 17B42=16 17B42=20	6 mm	14 mm	7.2 mm	M6	9.5 mm	Piece

3) 501S34 Joint Screw

Technical data

Article number	Spare part for	Material	Quantity unit
501S34=M6	17B20=L16 17B20=R16 17B20=L20 17B20=R20 17B21=L16 17B21=R16 17B21=L20 17B21=R20 17B42=16 17B42=20 17K42=4	Stainless steel	Piece

4) 501D1 Spring-loaded thrust piece

Technical data

Article number	Spare part for	Material	Quantity unit
501D1	17B20=L16 17B20=R16 17B20=L20 17B20=R20 17B21=L16 17B21=R16 17B21=L20 17B21=R20 17B42=16 17B42=20	Stainless steel	Piece

5) 501T7 Phillips oval countersunk head screw

Technical data

Article number	for	Head Ø	Length	Material	Quantity unit
501T7=7.5X9XM5	System side bars	7.5 mm	9 mm	Stainless steel	Piece



17B105 System knee joint

Locked knee joint with wedge lock and pull-release cable

Medial joint contoured at the bottom, straight at the top, straight lateral joint with wedge lock and pull-release cable



Technical data

Article number	Side	System width	Length from joint centre upper	Length from joint centre lower	Material	Quantity unit
17B105=L16	left (L)	16 mm	45 mm	41 mm	Titanium	Pair
17B105=R16	right (R)	16 mm	45 mm	41 mm	Titanium	Pair
17B105=L20	left (L)	20 mm	45 mm	41 mm	Titanium	Pair
17B105=R20	right (R)	20 mm	45 mm	41 mm	Titanium	Pair

· Patent: WO 99/11206, EP 936891

Spare parts for 17B105

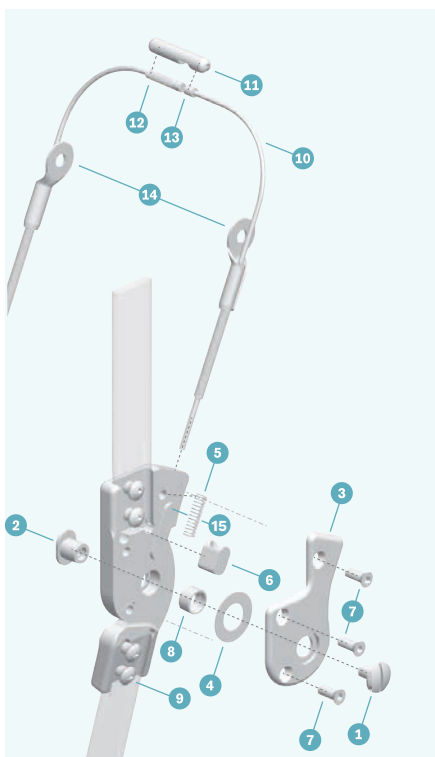

1) 501S32 Slotted truss head screw

Technical data

Article number	Head Ø	Length	Thread	For system width	Material	Quantity unit
501S32=M5X10X10	10 mm	10 mm	M5	16 mm	Stainless steel	Piece
501S32=M5X12X11	12 mm	11 mm	M5	20 mm	Stainless steel	Piece

2) 17Y93 Bearing nut, hardened

Technical data

Article number	Spare part for	Insertion length	Profile length	Shank length	Thread	Shoulder Ø	Quantity unit
17Y93=7X8.85XM5	17B105=L16 17B105=R16	7.6 mm	12.0 mm	8.85 mm	M5	7 mm	Piece
17Y93=8X9XM5	17B105=L20 17B105=R20	7.6 mm	14 mm	9 mm	M5	8 mm	Piece

3) 17Y121 Cover

Cover for 17B105/17B106

Technical data

Article number	Side	System width	Material	Quantity unit
17Y121=L16	left (L)	16 mm	Titanium	Piece
17Y121=R16	right (R)	16 mm	Titanium	Piece
17Y121=L20	left (L)	20 mm	Titanium	Piece
17Y121=R20	right (R)	20 mm	Titanium	Piece

4) 4Z80 Bearing washer

Technical data

Article number	For system width	Material	Quantity unit
4Z80=9.2X16X0.2	16 mm	Polyamide	Piece
4Z80=10.2X20X0.2	20 mm	Polyamide	Piece

5) 513D19 Compression spring

Technical data

Article number	For system width	Quantity unit
513D19=0.63X4X20	20 mm	Piece

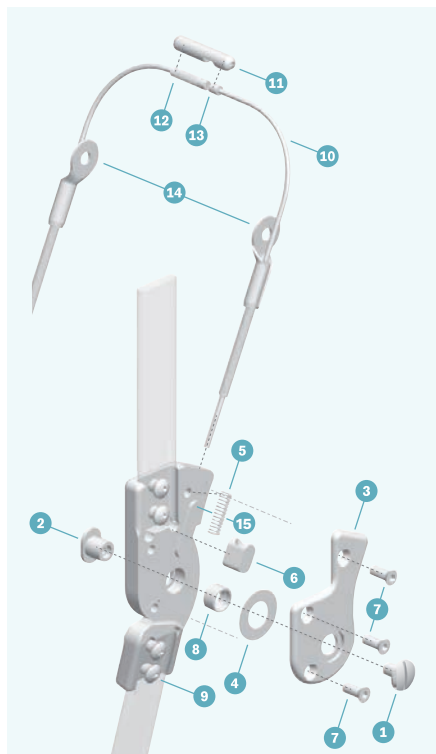

6) 17Y122 Wedge lock, hardened

Technical data

Article number	Quantity unit
17Y122	Piece

7) 17Y123 Flat head screw

Technical data

Article number	Quantity unit
17Y123=M4X10	Piece

8) 17Y17 Brass bushing

Technical data

Article number	For system width	Material	Quantity unit
17Y17=7X9X5.4	16 mm	Brass	Piece
17Y17=8X10X5.4	20 mm	Brass	Piece

9) 501T7 Phillips oval countersunk head screw

Technical data

Article number	Head Ø	Thread	Length	Material	Quantity unit
501T7=7.5X9XM5	7.5 mm	M5	9 mm	Stainless steel	Piece

10) 21A18 Perlon cable

Technical data

Article number	Diameter	Length	Order unit
21A18=2X1	2 mm	1 m	linear metres
21A18=2X5	2 mm	5 m	linear metres
21A18=2X10	2 mm	10 m	linear metres
21A18=2X25	2 mm	25 m	linear metres

11) 21A7 Coupling piece

Technical data

Article number	Quantity unit
21A7	Piece

12) 21A25 Spring

Technical data

Article number	Quantity unit
21A25	Piece

13) 21A12 Threaded sleeve

Technical data

Article number	Package contents	Quantity unit
21A12	2 piece(s)	Piece

14) 21A5 Eyelet cable anchor, large

Technical data

Article number	Contents	Width	Length	Clear width	Weight
21A5	1 Piece(s)	15 mm	35 mm	5 mm	4 g

15) 17Y126 Lamination dummy

Technical data

Article number	For system width	Quantity unit
17Y126=16	16 mm	Piece
17Y126=20	20 mm	Piece

· Please order side bars separately

Accessory for 17B105



17Y128 System lamination bar

The system lamination bars are glued with Ottobock special adhesive.

Technical data

Article number	System width	Length	Thickness	Material	Quantity unit
17Y128=16X80	16 mm	80 mm	4 mm	Stainless steel	Piece
17Y128=20X80	20 mm	80 mm	4 mm	Stainless steel	Piece
17Y128=16X100	16 mm	100 mm	4 mm	Stainless steel	Piece
17Y128=20X100	20 mm	100 mm	4 mm	Stainless steel	Piece

· Caution! The system lamination bars always have to be used in pairs in the leg orthosis. Unilateral use can cause the lamination bar to break due to overloading.



17Y129 System lamination bar with contoured calf

The system lamination bars are glued with Ottobock special adhesive.

Technical data

Article number	Side	System width	Length	Thickness	Material	Quantity unit
17Y129=L16	left (L)	16 mm	100 mm	4 mm	Stainless steel	Piece
17Y129=R16	right (R)	16 mm	100 mm	4 mm	Stainless steel	Piece
17Y129=L20	left (L)	20 mm	100 mm	4 mm	Stainless steel	Piece
17Y129=R20	right (R)	20 mm	100 mm	4 mm	Stainless steel	Piece

· Caution! The system lamination bars always have to be used in pairs in the leg orthosis. Unilateral use can cause the lamination bar to break due to overloading.



17B38 System side bar set

Flat, set consisting of two 17B4 Thigh side bars and one each, left and right, 17B5 Lower leg side bars.

Technical data

Article number	System width	Thickness	Material	Quantity unit
17B38=16	16 mm	4 mm	Stainless steel	Set
17B38=16-T	16 mm	4 mm	Titanium	Set
17B38=20	20 mm	4 mm	Stainless steel	Set
17B38=20-T	20 mm	4 mm	Titanium	Set



17B39 System side bar set

Flat, set consisting of two 17B6 Thigh side bars and one each, left and right, 17B7 Lower leg side bars.

Technical data

Article number	System width	Thickness	Material	Quantity unit
17B39=16	16 mm	5 mm	Aluminium	Set
17B39=20	20 mm	5 mm	Aluminium	Set



17B85 System side bar set

Concave, consisting of two 17B88 upper side bars and one left and one right 17B89 lower side bar.

Technical data

Article number	System width	Thickness	Material	Quantity unit
17B85=16	16 mm	5 mm	Aluminium	Set
17B85=20	20 mm	5 mm	Aluminium	Set

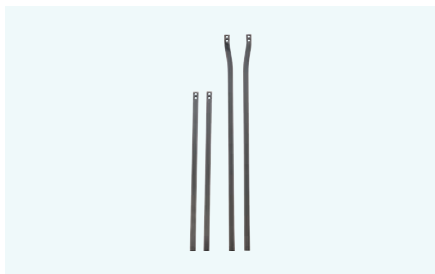

17B40 System side bar set

Flat, extra-long, set consisting of two 17B4 Thigh side bars and one each, left and right, 17B102 Lower leg side bars.

Technical data

Article number	System width	Thickness	Material	Quantity unit
17B40=16	16 mm	4 mm	Stainless steel	Set
17B40=20	20 mm	4 mm	Stainless steel	Set



17B84 System side bar set

Concave, set consisting of two 17B86 Thigh side bars and one each, left and right, 17B87 Lower leg side bars.

Technical data

Article number	System width	Thickness	Material	Quantity unit
17B84=16	16 mm	4 mm	Steel	Set
17B84=20	20 mm	4 mm	Steel	Set



17B41 System side bar set, extra long

Flat, extra-long, set consisting of two 17B6 Thigh side bars and one each, left and right, 17B104 Lower leg side bars.

Technical data

Article number	System width	Thickness	Material	Quantity unit
17B41=16	16 mm	5 mm	Aluminium	Set
17B41=20	20 mm	5 mm	Aluminium	Set

· To process the bars, order also 636W28 (special adhesive and hardener).



17B95 System knee joint

Locked knee joint with wedge lock and pull-release cable

With 16 mm system width: suitable for body weight up to 50 kg

Medial joint contoured at the bottom and straight at the top, straight lateral joint



Technical data

Article number	Side	System width	Milled head	Length from joint centre upper	Length from joint centre lower	Material	Quantity unit
17B95=L16	left (L)	16 mm	23x4 mm	50 mm	40 mm	Stainless steel	Pair
17B95=R16	right (R)	16 mm	23x4 mm	50 mm	40 mm	Stainless steel	Pair
17B95=L20	left (L)	20 mm	30x5 mm	58 mm	42 mm	Stainless steel	Pair
17B95=R20	right (R)	20 mm	30x5 mm	58 mm	42 mm	Stainless steel	Pair

i Practical recommendation

- On worn joints, the tolerance can be reduced with the repair bolts. A suitable reamer is usually used for adaptation.



17B96 System knee joint

Locked knee joint with wedge lock and pull-release cable

With 16 mm system width: suitable for body weight up to 50 kg

Straight medial and lateral joints



Technical data

Article number	System width	Milled head	Length from joint centre upper	Length from joint centre lower	Material	Quantity unit
17B96=16	16 mm	23x4 mm	50 mm	40 mm	Stainless steel	Pair
17B96=20	20 mm	30x5 mm	58 mm	42 mm	Stainless steel	Pair

i Practical recommendation

- On worn joints, the tolerance can be reduced with the repair bolts. A suitable reamer is usually used for adaptation.

Spare parts for 17B95, 17B96

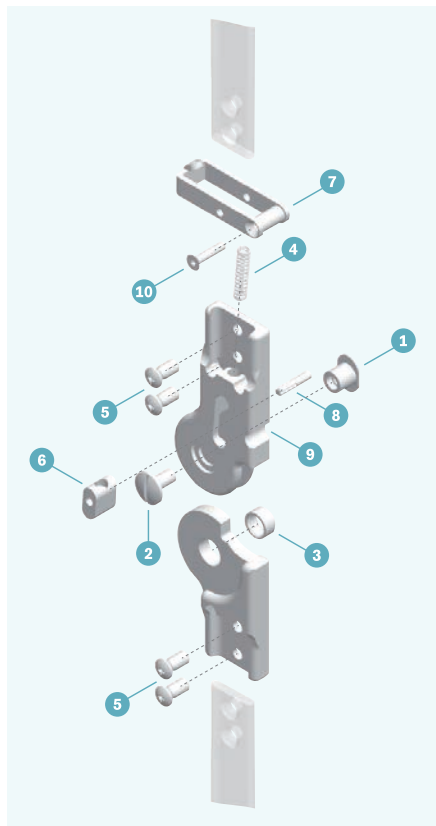

1) 17Y93 Bearing nut, hardened

Technical data

Article number	Spare part for	Insertion length	Profile length	Shank length	Thread	Shoulder Ø	Quantity unit
17Y93=6X7.7XM4	17B95=L16	6.45 mm	12 mm	7.7 mm	M4	6 mm	Piece
	17B95=R16						
	17B95=L20						
	17B95=R20						
	17B96=16						
17Y93=6.5X7.7XM4	17B95=L16	6.45 mm	12 mm	7.7 mm	M4	6.5 mm	Piece
	17B95=R16						
	17B96=16						
17Y93=8X8.5XM5	17B95=L20	7.4 mm	12 mm	8.5 mm	M5	8 mm	Piece
	17B95=R20						
	17B96=20						

2) 501S32 Slotted truss head screw

Technical data

Article number	Head Ø	Length	For system width	Thread	Material	Quantity unit
501S32=M4X10X9.5	10 mm	9.5 mm	16 mm	M4	Stainless steel	Piece
501S32=M5X12X11	12 mm	11 mm	20 mm	M5	Stainless steel	Piece

3) 17Y17 Brass bushing

Technical data

Article number	Material	Quantity unit
17Y17=8X10X4.8	Brass	Piece

4) 513D19 Compression spring

Technical data

Article number	For system width	Quantity unit
513D19=0.5X3.3X14	16 mm	Piece
513D19=0.63X4X20	20 mm	Piece

5) 501S41 Countersunk head screw (allen screw)

Technical data

Article number	For system width	Quantity unit
501S41=M3X12	16 mm	Piece
501S41=M3X14	20 mm	Piece

6) 17Y88 Wedge lock, hardened

Technical data

Article number	For system width	Quantity unit
17Y88=16	16 mm	Piece
17Y88=20	20 mm	Piece

7) 30Z22 Locking rocker

Technical data

Article number	For system width	Material	Quantity unit
30Z22=L16	16 mm	Stainless steel	Piece
30Z22=R16	16 mm	Stainless steel	Piece
30Z22=L20	20 mm	Stainless steel	Piece
30Z22=R20	20 mm	Stainless steel	Piece

8) 506K2 Notch pin for rocking locker**Technical data**

Article number	For system width	Material	Quantity unit
506K2=3X12	16 mm	Stainless steel	Piece
506K2=3X14	20 mm	Stainless steel	Piece

9) 17Y89 Bushing for rocking locker**Technical data**

Article number	For system width	Material	Quantity unit
17Y89=16	16 mm	Brass	Piece

10) 501T7 Phillips oval countersunk head screw**Technical data**

Article number	Head Ø	Length	Material	Quantity unit
501T7=7,5X9XM5	7.5 mm	9 mm	Stainless steel	Piece

Spare parts for pull-release cable



21A18 Perlon cable

The perlon cable is an accessory for the triple-control upper arm harness (article number 21A35=1) and the below-elbow harness (article number 21A36=1).

Technical data

Article number	Diameter	Length	Order unit
21A18=2X1	2 mm	1 m	linear metres
21A18=2X5	2 mm	5 m	linear metres
21A18=2X10	2 mm	10 m	linear metres
21A18=2X25	2 mm	25 m	linear metres



21A7 Coupling piece

The coupling piece is used in combination with the Perlon cord.

Technical data

Article number	Quantity unit
21A7	Piece

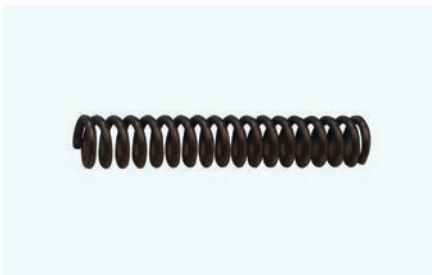

21A25 Spring

The spring is used for the coupling piece.

Technical data

Article number	Quantity unit
21A25	Piece



21A12 Threaded sleeve

The short threaded sleeve is screwed on the 21A18=2 perlon cable (contents: two pieces).

Technical data

Article number	Package contents	Quantity unit
21A12	2 piece(s)	Piece

Accessory for 17B95, 17B96



17Y128 System lamination bar

The system lamination bars are glued with Ottobock special adhesive.

Technical data

Article number	System width	Length	Thickness	Material	Quantity unit
17Y128=16X80	16 mm	80 mm	4 mm	Stainless steel	Piece
17Y128=20X80	20 mm	80 mm	4 mm	Stainless steel	Piece
17Y128=16X100	16 mm	100 mm	4 mm	Stainless steel	Piece
17Y128=20X100	20 mm	100 mm	4 mm	Stainless steel	Piece

· Caution! The system lamination bars always have to be used in pairs in the leg orthosis. Unilateral use can cause the lamination bar to break due to overloading.



17Y129 System lamination bar with contoured calf

The system lamination bars are glued with Ottobock special adhesive.

Technical data

Article number	Side	System width	Length	Thickness	Material	Quantity unit
17Y129=L16	left (L)	16 mm	100 mm	4 mm	Stainless steel	Piece
17Y129=R16	right (R)	16 mm	100 mm	4 mm	Stainless steel	Piece
17Y129=L20	left (L)	20 mm	100 mm	4 mm	Stainless steel	Piece
17Y129=R20	right (R)	20 mm	100 mm	4 mm	Stainless steel	Piece

· Caution! The system lamination bars always have to be used in pairs in the leg orthosis. Unilateral use can cause the lamination bar to break due to overloading.



17B38 System side bar set

Flat, set consisting of two 17B4 Thigh side bars and one each, left and right, 17B5 Lower leg side bars.

Technical data

Article number	System width	Thickness	Material	Quantity unit
17B38=16	16 mm	4 mm	Stainless steel	Set
17B38=16-T	16 mm	4 mm	Titanium	Set
17B38=20	20 mm	4 mm	Stainless steel	Set
17B38=20-T	20 mm	4 mm	Titanium	Set



17B39 System side bar set

Flat, set consisting of two 17B6 Thigh side bars and one each, left and right, 17B7 Lower leg side bars.

Technical data

Article number	System width	Thickness	Material	Quantity unit
17B39=16	16 mm	5 mm	Aluminium	Set
17B39=20	20 mm	5 mm	Aluminium	Set



17B85 System side bar set

Concave, consisting of two 17B88 upper side bars and one left and one right 17B89 lower side bar.

Technical data

Article number	System width	Thickness	Material	Quantity unit
17B85=16	16 mm	5 mm	Aluminium	Set
17B85=20	20 mm	5 mm	Aluminium	Set

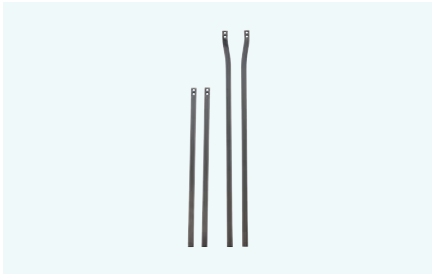

17B40 System side bar set

Flat, extra-long, set consisting of two 17B4 Thigh side bars and one each, left and right, 17B102 Lower leg side bars.

Technical data

Article number	System width	Thickness	Material	Quantity unit
17B40=16	16 mm	4 mm	Stainless steel	Set
17B40=20	20 mm	4 mm	Stainless steel	Set

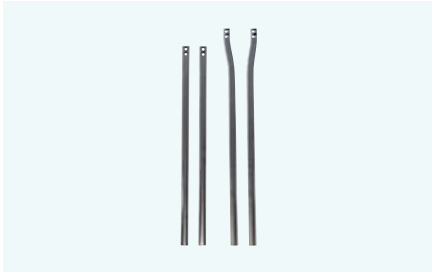

17B84 System side bar set

Concave, set consisting of two 17B86 Thigh side bars and one each, left and right, 17B87 Lower leg side bars.

Technical data

Article number	System width	Thickness	Material	Quantity unit
17B84=16	16 mm	4 mm	Steel	Set
17B84=20	20 mm	4 mm	Steel	Set



17B41 System side bar set, extra long

Flat, extra-long, set consisting of two 17B6 Thigh side bars and one each, left and right, 17B104 Lower leg side bars.

Technical data

Article number	System width	Thickness	Material	Quantity unit
17B41=16	16 mm	5 mm	Aluminium	Set
17B41=20	20 mm	5 mm	Aluminium	Set

• To process the bars, order also 636W28 (special adhesive and hardener).



17LK3 Unilateral knee joint

System knee joint with wedge lock



Technical data

Article number	Side	System width	Max. body weight	Material	Quantity unit
17LK3=L10	left (L)	10 mm	15 / 25* kg	Stainless steel	Piece
17LK3=R10	right (R)	10 mm	15 / 25* kg	Stainless steel	Piece
17LK3=L10-T	left (L)	10 mm	15 / 25* kg	Titanium	Piece
17LK3=R10-T	right (R)	10 mm	15 / 25* kg	Titanium	Piece
17LK3=L12	left (L)	12 mm	20 / 40* kg	Stainless steel	Piece
17LK3=R12	right (R)	12 mm	20 / 40* kg	Stainless steel	Piece
17LK3=L12-T	left (L)	12 mm	20 / 40* kg	Titanium	Piece
17LK3=R12-T	right (R)	12 mm	20 / 40* kg	Titanium	Piece
17LK3=L14	left (L)	14 mm	50 / 80* kg	Stainless steel	Piece
17LK3=R14	right (R)	14 mm	50 / 80* kg	Stainless steel	Piece
17LK3=L14-T	left (L)	14 mm	50 / 80* kg	Titanium	Piece
17LK3=R14-T	right (R)	14 mm	50 / 80* kg	Titanium	Piece
17LK3=L16	left (L)	16 mm	85 / 120* kg	Stainless steel	Piece
17LK3=R16	right (R)	16 mm	85 / 120* kg	Stainless steel	Piece
17LK3=L16-T	left (L)	16 mm	85 / 120* kg	Titanium	Piece
17LK3=R16-T	right (R)	16 mm	85 / 120* kg	Titanium	Piece
17LK3=L20	left (L)	20 mm	110 / 160* kg	Stainless steel	Piece
17LK3=R20	right (R)	20 mm	110 / 160* kg	Stainless steel	Piece
17LK3=L20-T	left (L)	20 mm	110 / 160* kg	Titanium	Piece
17LK3=R20-T	right (R)	20 mm	110 / 160* kg	Titanium	Piece

- When using the product unilaterally, and in case of flexion contracture in the knee or hip > 10°, or distinct torsion or valgus/varus instabilities, or valgus/varus malpositions, or increased physical activity, the next higher size must be used!
- * with bilateral use
- Use the product bilaterally if there is any ischial support

Spare parts for 17LK3

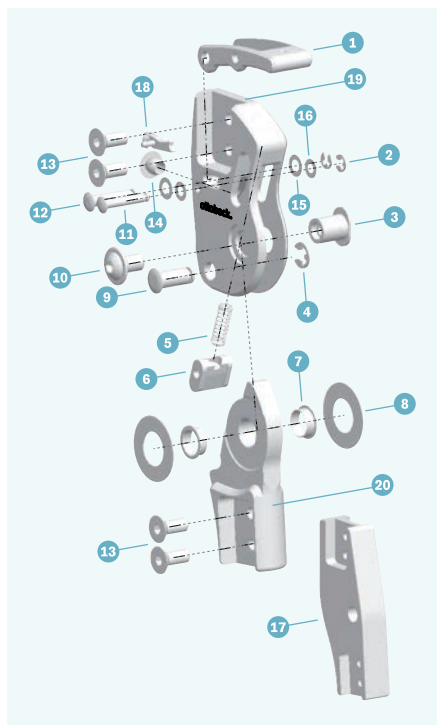

1) 30Y265 Knee lever

Technical data

Article number	Spare part for	Quantity unit
30Y265=12-A	17LK3=L10 17LK3=R10 17LK3=L10-T 17LK3=R10-T 17LK3=L12 17LK3=R12 17LK3=L12-T 17LK3=R12-T	Piece
30Y265=14-A	17LK3=L14 17LK3=R14 17LK3=L14-T 17LK3=R14-T	Piece
30Y265=16-A	17LK3=L16 17LK3=R16 17LK3=L16-T 17LK3=R16-T	Piece
30Y265=20-A	17LK3=L20 17LK3=R20 17LK3=L20-T 17LK3=R20-T	Piece

2) 507S96 Lock washer

Technical data

Article number	Spare part for	Quantity unit
507S96=2.3	17LK3=L10 17LK3=R10 17LK3=L10-T 17LK3=R10-T 17LK3=L12 17LK3=R12 17LK3=L12-T 17LK3=R12-T 17LK3=L14 17LK3=R14 17LK3=L14-T 17LK3=R14-T 17LK3=L16 17LK3=R16 17LK3=L16-T 17LK3=R16-T 17LK3=L20 17LK3=R20 17LK3=L20-T 17LK3=R20-T	Piece

3) 17Y93 Bearing nut, hardened

Technical data

Article number	Spare part for	Shank length	Thread	Shoulder Ø	Quantity unit
17Y93=9X9.2XM6	17LK3=L10 17LK3=R10 17LK3=L10-T 17LK3=R10-T 17LK3=L12 17LK3=R12 17LK3=L12-T 17LK3=R12-T 17LK3=L14 17LK3=R14 17LK3=L14-T 17LK3=R14-T	9.2 mm	M6	9 mm	Piece
17Y93=9X10.75XM6	17LK3=L16 17LK3=R16 17LK3=L16-T 17LK3=R16-T	10.75 mm	M6	9 mm	Piece
17Y93=9X11.75XM6	17LK3=L20 17LK3=R20 17LK3=L20-T 17LK3=R20-T	11.75 mm	M6	9 mm	Piece

4) 507S96 Lock washer

Technical data

Article number	Spare part for	Quantity unit
507S96=3.2	17LK3=L10 17LK3=R10 17LK3=L10-T 17LK3=R10-T 17LK3=L12 17LK3=R12 17LK3=L12-T 17LK3=R12-T 17LK3=L14 17LK3=R14 17LK3=L14-T 17LK3=R14-T	Piece
507S96=4	17LK3=L16 17LK3=R16 17LK3=L16-T 17LK3=R16-T 17LK3=L20 17LK3=R20 17LK3=L20-T 17LK3=R20-T	Piece

5) 513D83 Compression spring

Technical data

Article number	Spare part for	Quantity unit
513D83=0.7X4.3X19	17LK3=L10 17LK3=L10-T 17LK3=L12 17LK3=L12-T 17LK3=R10 17LK3=R10-T 17LK3=R12 17LK3=R12-T	Piece
513D83=0.75X4.6X20	17LK3=L14 17LK3=L14-T 17LK3=L16 17LK3=L16-T 17LK3=L20 17LK3=L20-T 17LK3=R14 17LK3=R14-T 17LK3=R16 17LK3=R16-T 17LK3=R20 17LK3=R20-T	Piece

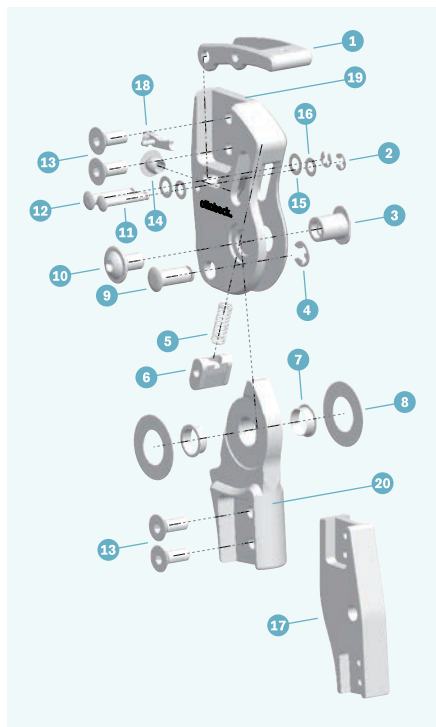

6) 17Y156 Lock wedge

Technical data

Article number	Spare part for	Quantity unit
17Y156=1	17LK3=L10 17LK3=R10 17LK3=L10-T 17LK3=R10-T 17LK3=L12 17LK3=R12 17LK3=L12-T 17LK3=R12-T 17LK3=L14 17LK3=R14 17LK3=L14-T 17LK3=R14-T	Piece
17Y156=2	17LK3=L10 17LK3=R10 17LK3=L10-T 17LK3=R10-T 17LK3=L12 17LK3=R12 17LK3=L12-T 17LK3=R12-T 17LK3=L14 17LK3=R14 17LK3=L14-T 17LK3=R14-T	Piece
17Y156=3	17LK3=L10 17LK3=R10 17LK3=L10-T 17LK3=R10-T 17LK3=L12 17LK3=R12 17LK3=L12-T 17LK3=R12-T 17LK3=L14 17LK3=R14 17LK3=L14-T 17LK3=R14-T	Piece

· Lock wedges must always be replaced with identical lock wedges (=1, =2 or =3)

6) 17Y157 Lock wedge

Technical data

Article number	Spare part for	Quantity unit
17Y157=1	17LK3=L16 17LK3=R16 17LK3=L16-T 17LK3=R16-T	Piece
17Y157=2	17LK3=L16 17LK3=R16 17LK3=L16-T 17LK3=R16-T	Piece
17Y157=3	17LK3=L16 17LK3=R16 17LK3=L16-T 17LK3=R16-T	Piece

· Lock wedges must always be replaced with identical lock wedges (=1, =2 or =3)

6) 17Y158 Lock wedge

Technical data

Article number	Spare part for	Quantity unit
17Y158=1	17LK3=L20 17LK3=R20 17LK3=L20-T 17LK3=R20-T	Piece
17Y158=2	17LK3=L20 17LK3=R20 17LK3=L20-T 17LK3=R20-T	Piece
17Y158=3	17LK3=L20 17LK3=R20 17LK3=L20-T 17LK3=R20-T	Piece

· Lock wedges must always be replaced with identical lock wedges (=1, =2 or =3)

7) 30Y87 Bushing

Technical data

Article number	Spare part for	Quantity unit
30Y87=1	17LK3=L20 17LK3=R20 17LK3=L20-T 17LK3=R20-T	Piece
30Y87=2	17LK3=L16 17LK3=R16 17LK3=L16-T 17LK3=R16-T	Piece
30Y87=3	17LK3=L10 17LK3=R10 17LK3=L10-T 17LK3=R10-T 17LK3=L12 17LK3=R12 17LK3=L12-T 17LK3=R12-T 17LK3=L14 17LK3=R14 17LK3=L14-T 17LK3=R14-T	Piece

8) 170Z93 Bearing washers

Technical data

Article number	Spare part for	Quantity unit
170Z93=1	17LK3=L16 17LK3=R16 17LK3=L16-T 17LK3=R16-T 17LK3=L20 17LK3=R20 17LK3=L20-T 17LK3=R20-T	Set

9) 4A101 Axis Pin

Technical data

Article number	Spare part for	Quantity unit
4A101=5X10.6	17LK3=L10 17LK3=R10 17LK3=L10-T 17LK3=R10-T 17LK3=L12 17LK3=R12 17LK3=L12-T 17LK3=R12-T 17LK3=L14 17LK3=R14 17LK3=L14-T 17LK3=R14-T	Piece
4A101=6X12.7	17LK3=L16 17LK3=R16 17LK3=L16-T 17LK3=R16-T	Piece
4A101=6X13.7	17LK3=L20 17LK3=R20 17LK3=L20-T 17LK3=R20-T	Piece

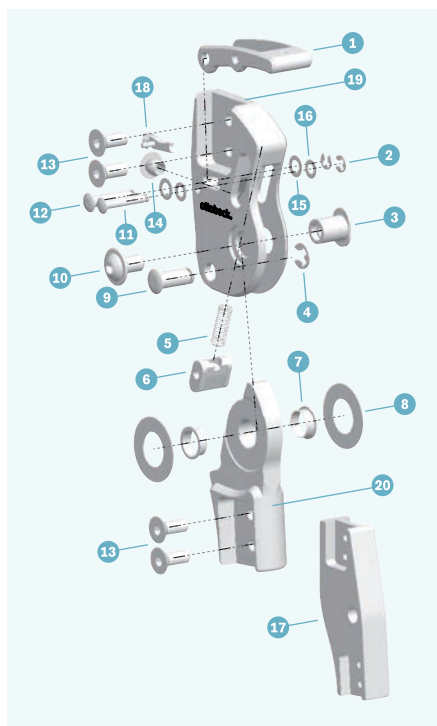

9) 4A101 Axis Pin

Technical data

Article number	Spare part for	Quantity unit
4A101=3.2X15.1	17LK3=L10 17LK3=R10 17LK3=L10-T 17LK3=R10-T 17LK3=L12 17LK3=R12 17LK3=L12-T 17LK3=R12-T 17LK3=L14 17LK3=R14 17LK3=L14-T 17LK3=R14-T	Piece
4A101=3.2X17.1	17LK3=L16 17LK3=R16 17LK3=L16-T 17LK3=R16-T	Piece
4A101=3.2X18.1	17LK3=L20 17LK3=R20 17LK3=L20-T 17LK3=R20-T	Piece

10) 501F9 Screw with flattened half-round head

Technical data

Article number	Spare part for	Quantity unit
501F9=M6X8	17LK3=L10 17LK3=R10 17LK3=L10-T 17LK3=R10-T 17LK3=L12 17LK3=R12 17LK3=L12-T 17LK3=R12-T 17LK3=L14 17LK3=R14 17LK3=L14-T 17LK3=R14-T 17LK3=L16 17LK3=R16 17LK3=L16-T 17LK3=R16-T 17LK3=L20 17LK3=R20 17LK3=L20-T 17LK3=R20-T	Piece

11) 4A101 Axis Pin

Technical data

Article number	Spare part for	Quantity unit
4A101=4X15.1	17LK3=L10 17LK3=R10 17LK3=L10-T 17LK3=R10-T 17LK3=L12 17LK3=R12 17LK3=L12-T 17LK3=R12-T 17LK3=L14 17LK3=R14 17LK3=L14-T 17LK3=R14-T	Piece
4A101=4X17.1	17LK3=L16 17LK3=R16 17LK3=L16-T 17LK3=R16-T	Piece
4A101=4X18.1	17LK3=L20 17LK3=R20 17LK3=L20-T 17LK3=R20-T	Piece

13) 501S137 Countersunk head Torx screw**Technical data**

Article number	Spare part for	Quantity unit
501S137=M4X8	17LK3=L10 17LK3=R10 17LK3=L10-T 17LK3=R10-T 17LK3=L12 17LK3=R12 17LK3=L12-T 17LK3=R12-T	Piece
501S137=M4X10-2	17LK3=L14 17LK3=L14-T 17LK3=R14 17LK3=R14-T	Piece
501S137=M5X10-1	17LK3=L16 17LK3=R16 17LK3=L16-T 17LK3=R16-T 17LK3=L20 17LK3=R20 17LK3=L20-T 17LK3=R20-T	Piece

14) 30Y91 Protective plug**Technical data**

Article number	Spare part for	Quantity unit
30Y91=1	17LK3=L16 17LK3=R16 17LK3=L16-T 17LK3=R16-T 17LK3=L20 17LK3=R20 17LK3=L20-T 17LK3=R20-T	Piece
30Y91=3	17LK3=L10 17LK3=R10 17LK3=L10-T 17LK3=R10-T 17LK3=L12 17LK3=R12 17LK3=L12-T 17LK3=R12-T 17LK3=L14 17LK3=R14 17LK3=L14-T 17LK3=R14-T	Piece

17) 30Y268 Joint dummy**Technical data**

Article number	Spare part for	Quantity unit
30Y268=10	17LK3=L10 17LK3=R10 17LK3=L10-T 17LK3=R10-T	Piece
30Y268=12	17LK3=L12 17LK3=R12 17LK3=L12-T 17LK3=R12-T	Piece
30Y268=14	17LK3=L14 17LK3=R14 17LK3=L14-T 17LK3=R14-T	Piece
30Y268=16	17LK3=L16 17LK3=R16 17LK3=L16-T 17LK3=R16-T	Piece
30Y268=20	17LK3=L20 17LK3=R20 17LK3=L20-T 17LK3=R20-T	Piece

- The article number of the appropriate shoulder screw for the joint dummy is 30Y89.

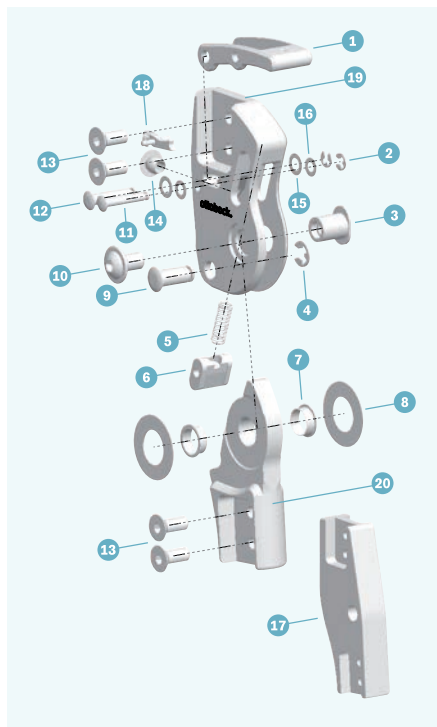

18) 17Y162 Temporary switch

Technical data

Article number	Spare part for	Quantity unit
17Y162=3	17LK3=L10 17LK3=R10 17LK3=L10-T 17LK3=R10-T 17LK3=L12 17LK3=R12 17LK3=L12-T 17LK3=R12-T 17LK3=L14 17LK3=R14 17LK3=L14-T 17LK3=R14-T	Piece
17Y162=2	17LK3=L16 17LK3=R16 17LK3=L16-T 17LK3=R16-T	Piece
17Y162=1	17LK3=L20 17LK3=R20 17LK3=L20-T 17LK3=R20-T	Piece

· Is an additional option that can be installed later in the orthotic knee joint. Enables the orthotic knee joint to be set to a temporary, open position. For example, for cycling on a therapy bike.

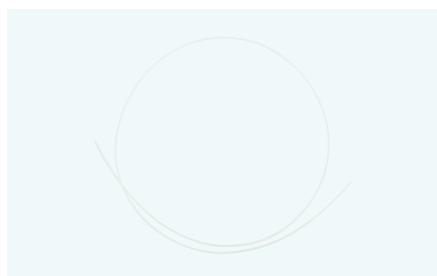

21A45 Perlon cable, 0.60 m long

Technical data

Article number	Spare part for
21A45=0.60	17LK3=L10 17LK3=R10 17LK3=L10-T 17LK3=R10-T 17LK3=L12 17LK3=R12 17LK3=L12-T 17LK3=R12-T 17LK3=L14 17LK3=R14 17LK3=L14-T 17LK3=R14-T 17LK3=L16 17LK3=R16 17LK3=L16-T 17LK3=R16-T 17LK3=L20 17LK3=R20 17LK3=L20-T 17LK3=R20-T



21A12 Threaded sleeve

The short threaded sleeve is screwed on the 21A18=2 perlon cable (contents: two pieces).

Technical data

Article number	Package contents	Quantity unit
21A12	2 piece(s)	Piece

Accessory for 17LK3



17LS3 Lamination bar

Lamination bar for unilateral and bilateral use for lamination resin or prepreg technique



Technical data

Article number	System width	Length	Thickness	Material	Quantity unit
17LS3=10	10 mm	80 mm	5 mm bottom/3 mm top	Stainless steel	Piece
17LS3=10-T	10 mm	80 mm	5 mm bottom/3 mm top	Titanium	Piece
17LS3=12	12 mm	80 mm	5 mm bottom/3 mm top	Stainless steel	Piece
17LS3=12-T	12 mm	80 mm	5 mm bottom/3 mm top	Titanium	Piece
17LS3=14	14 mm	100 mm	6 mm bottom/2.5 mm top	Stainless steel	Piece
17LS3=14-T	14 mm	100 mm	6 mm bottom/2.5 mm top	Titanium	Piece
17LS3=16	16 mm	130 mm	6 mm bottom/3 mm top	Stainless steel	Piece
17LS3=16-T	16 mm	130 mm	6 mm bottom/3 mm top	Titanium	Piece
17LS3=20	20 mm	130 mm	6 mm bottom/3 mm top	Stainless steel	Piece
17LS3=20-T	20 mm	130 mm	6 mm bottom, 3 mm top	Titanium	Piece

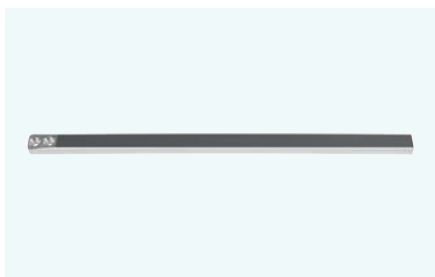

17LV3 Side bar

Side bar made of stainless steel for unilateral use for thermoplastic technique

Technical data

Article number	System width	Material	Quantity unit
17LV3=10	10 mm	Stainless steel	Piece
17LV3=12	12 mm	Stainless steel	Piece
17LV3=14	14 mm	Stainless steel	Piece
17LV3=16	16 mm	Stainless steel	Piece
17LV3=20	20 mm	Stainless steel	Piece
17LV3=L-16	16 mm	Stainless steel	Piece
17LV3=L-20	20 mm	Stainless steel	Piece
17LV3=R-16	16 mm	Stainless steel	Piece
17LV3=R-20	20 mm	Stainless steel	Piece

Unilateral Joint System. Order form.

Page 1/1

Contact person

Customer no.

Date

Customer

Company

Street

Postal code City

Email

Commision

Shipping address (if different from customer address)

Company

Street

Postal code City

Email

User information (optional)

Patient ID

Weight kg

Indication

Side Left Right

Maximum patient weight [kg]

	17LK3=10	17LK3=12	17LK3=14	17LK3=16	17LK3=20
Unilateral use (lateral or medial)	15	20	50	85	110
Bilateral use (lateral or medial)	25	40	80	120	160

The size chosen depends on the patient's weight and the conditions of use.

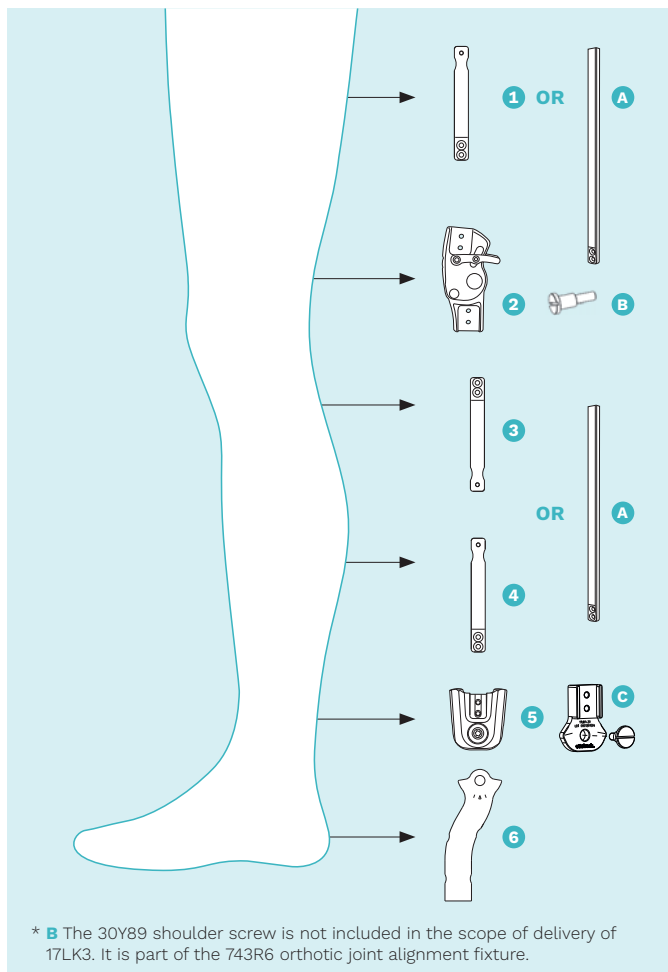

* B The 30Y89 shoulder screw is not included in the scope of delivery of 17LK3. It is part of the 743R6 orthotic joint alignment fixture.

1 Lamination bar 17LS3=* OR

Steel version	Titanium version
<input type="radio"/> 17LS3=10	<input type="radio"/> 17LS3=10-T
<input type="radio"/> 17LS3=12	<input type="radio"/> 17LS3=12-T
<input type="radio"/> 17LS3=14	<input type="radio"/> 17LS3=14-T
<input type="radio"/> 17LS3=16	<input type="radio"/> 17LS3=16-T
<input type="radio"/> 17LS3=20	<input type="radio"/> 17LS3=20-T

A Extension bar 17LV3=* OR

Steel version
<input type="radio"/> 17LV3=10
<input type="radio"/> 17LV3=12
<input type="radio"/> 17LV3=14
<input type="radio"/> 17LV3=16
<input type="radio"/> 17LV3=20

2 Unilateral Knee Joint 17LK3=* OR

Steel version	Titanium version	Side	B Shoulder screw*
<input type="radio"/> 17LK3=12	<input type="radio"/> 17LK3=12-T	<input type="radio"/> L <input type="radio"/> R	<input type="radio"/> 30Y89
<input type="radio"/> 17LK3=14	<input type="radio"/> 17LK3=14-T	<input type="radio"/> L <input type="radio"/> R	<input type="radio"/> 30Y89
<input type="radio"/> 17LK3=16	<input type="radio"/> 17LK3=16-T	<input type="radio"/> L <input type="radio"/> R	<input type="radio"/> 30Y89
<input type="radio"/> 17LK3=20	<input type="radio"/> 17LK3=20-T	<input type="radio"/> L <input type="radio"/> R	<input type="radio"/> 30Y89

3, 4 Lamination bar 17LS3=* OR

Steel version	Titanium version
<input type="radio"/> 17LS3=10	<input type="radio"/> 17LS3=10-T
<input type="radio"/> 17LS3=12	<input type="radio"/> 17LS3=12-T
<input type="radio"/> 17LS3=14	<input type="radio"/> 17LS3=14-T
<input type="radio"/> 17LS3=16	<input type="radio"/> 17LS3=16-T
<input type="radio"/> 17LS3=20	<input type="radio"/> 17LS3=20-T

A Extension bar 17LV3=* OR

Steel version
<input type="radio"/> 17LV3=10
<input type="radio"/> 17LV3=12
<input type="radio"/> 17LV3=14
<input type="radio"/> 17LV3=16
<input type="radio"/> 17LV3=20

5 Unilateral Ankle Joint 17LA3N=* OR

Steel version	Titanium version
<input type="radio"/> 17LA3N=10	<input type="radio"/> 17LA3N=10-T
<input type="radio"/> 17LA3N=12	<input type="radio"/> 17LA3N=12-T
<input type="radio"/> 17LA3N=14	<input type="radio"/> 17LA3N=14-T
<input type="radio"/> 17LA3N=16	<input type="radio"/> 17LA3N=16-T
<input type="radio"/> 17LA3N=20	<input type="radio"/> 17LA3N=20-T

C Optional lamination dummy with shoulder screw

<input type="radio"/> 17LD1N=10
<input type="radio"/> 17LD1N=12
<input type="radio"/> 17LD1N=14
<input type="radio"/> 17LD1N=16
<input type="radio"/> 17LD1N=20

6 Foot stirrup (Steel) 17LF3N=* OR

<input type="radio"/> 17LF3N=10	<input type="radio"/> 17LF3N=14
<input type="radio"/> 17LF3N=12	<input type="radio"/> 17LF3N=16

<input type="radio"/> 17LF3N=20

Date Place Signature



17KL100 Nexgear lock knee

The 17KL100 is an orthotic knee joint with integrated locking function.

Technical data

Article number	System width	Max. body weight	Length from joint centre upper	Length from joint centre lower	Posterior offset	Quantity unit
17KL100=*-10-*-*	10 mm	15 kg	~ 43 mm	~ 35 mm	5 mm	Piece
17KL100=*-12-*-*	12 mm	20 kg	~ 46 mm	~ 36 mm	6 mm	Piece
17KL100=*-14-*-*	14 mm	50 kg	~ 48 mm	~ 39 mm	7 mm	Piece
17KL100=*-16-*-*	16 mm	85 kg	~ 54 mm	~ 46 mm	8 mm	Piece
17KL100=*-20-*-*	20 mm	110 kg	~ 57 mm	~ 48 mm	10 mm	Piece

- The 17KL100 Nexgear lock knee is:
 - Only suitable for bilateral use
 - Combinable with the following orthotic ankle joints:
 - 17AD200*
 - 17AD300*
 - 17LA3N*
 - Combinable with the following bars:
 - 17SL100=* lamination bar (lamination and prepreg technique)
 - 17SB100=* side bar (thermoplastic technique and bar-clamp device)
- Available sides: right (R), left (L)
- Available sizes: 10, 12, 14, 16, 20
- Available materials: titanium (T), steel (ST)
- Available contours:
 - straight lower section, straight upper section (1)
 - contoured lower section, straight upper section (2)
 - straight lower section, contoured upper section (3)
 - contoured lower section, contoured upper section (4)
- The following are not included in the scope of delivery and must be ordered separately:
 - 17KL103=* long lock lever (optional)
 - 17MA1=1 Nexgear function switch (optional)
 - 17KL102=* dummy set
 - 17SL100* lamination bars/17SB100* side bars

Order example

Reference Number	Side	System width	Contour	Material
17KL100	= R	- 10	- 1	- T
Nexgear lock knee	right	10	straight lower section, straight upper section	titanium
17KL100	= L	- 14	- 3	- ST
Nexgear lock knee	left	14	straight lower section, contoured upper section	steel

Spare parts for 17KL100



17KL101 Service set for 17KL100

Service set for 17KL100 Nexgear lock knee consisting of two bushings and two sliding washers.

Technical data

Article number	Spare part of	Quantity unit
17KL101=10	17KL100=*-10-*-*	Piece
17KL101=12	17KL100=*-12-*-*	Piece
17KL101=14	17KL100=*-14-*-*	Piece
17KL101=16	17KL100=*-16-*-*	Piece
17KL101=20	17KL100=*-20-*-*	Piece

Accessories for 17KL100



17KL102 Dummy-set for 17KL100

The dummy set is available for building an orthosis with the 17KL100 Nexgear lock knee orthotic knee joint. It contains the lamination dummy upper section and the slotted oval head screw required to connect to the lower joint section. The set is available for each size in straight and contoured, right and left designs. The scope of delivery of the knee joint includes a cover for the lower joint section to protect it during the lamination process.

Technical data

Article number	Accessories for	Quantity unit
17KL102=L-10-1	17KL100=L-10-1-*	Piece
17KL102=L-10-2	17KL100=L-10-2-*	Piece
17KL102=L-12-1	17KL100=L-12-1-*	Piece
17KL102=L-12-2	17KL100=L-12-2-*	Piece
17KL102=L-14-1	17KL100=L-14-1-*	Piece
17KL102=L-14-2	17KL100=L-14-2-*	Piece
17KL102=L-16-1	17KL100=L-16-1-*	Piece
17KL102=L-16-2	17KL100=L-16-2-*	Piece
17KL102=L-20-1	17KL100=L-20-1-*	Piece
17KL102=L-20-2	17KL100=L-20-2-*	Piece
17KL102=R-10-1	17KL100=R-10-1-*	Piece
17KL102=R-10-2	17KL100=R-10-2-*	Piece
17KL102=R-12-1	17KL100=R-12-1-*	Piece
17KL102=R-12-2	17KL100=R-12-2-*	Piece
17KL102=R-14-1	17KR100=R-14-1-*	Piece
17KL102=R-14-2	17KR100=R-14-2-*	Piece
17KL102=R-16-1	17KL100=R-16-1-*	Piece
17KL102=R-16-2	17KL100=R-16-2-*	Piece
17KL102=R-20-1	17KL100=R-20-1-*	Piece
17KL102=R-20-2	17KL100=R-20-2-*	Piece

- Available sides: right (R), left (L)
- Available sizes: 10, 12, 14, 16, 20
- Available contours: straight (1), contoured (2)



17KL103 Long lock lever for 17KL100

Long lock lever for 17KL100 Nexgear lock knee.

Technical data

Article number	Accessories for	Quantity unit
17KL103=10	17KL100=*-10-*-*	Piece
17KL103=12	17KL100=*-12-*-*	Piece
17KL103=14	17KL100=*-14-*-*	Piece
17KL103=16	17KL100=*-16-*-*	Piece
17KL103=20	17KL100=*-20-*-*	Piece



17SL100 Nexgear lamination bars

The lamination bars are designed for combination with the 17AD200 Nexgear Sixty-six ankle and the 17KL100 Nexgear lock knee, 17KF110 Nexgear free knee and 17KF210 Nexgear posterior knee. They are intended exclusively for bilateral use and in the lamination or prepreg technique.

Technical data

Article number	Version	System width	Length	Thick-ness	Material	Max. body weight	Side	Quantity unit
17SL100=10	Without calf swing	10 mm	80 mm	3,5 mm	Steel	15 kg	both sides	Piece
17SL100=10-T	Without calf swing	10 mm	80 mm	3,5 mm	Titanium	15 kg	both sides	Piece
17SL100=12	Without calf swing	12 mm	80 mm	3,5 mm	Steel	20 kg	both sides	Piece
17SL100=12-T	Without calf swing	12 mm	80 mm	3,5 mm	Titanium	20 kg	both sides	Piece
17SL100=14	Without calf swing	14 mm	80 mm	3,5 mm	Steel	50 kg	both sides	Piece
17SL100=14-T	Without calf swing	14 mm	80 mm	3,5 mm	Titanium	50 kg	both sides	Piece
17SL100=16	Without calf swing	16 mm	100 mm	3,5 mm	Steel	85 kg	both sides	Piece
17SL100=16-T	Without calf swing	16 mm	100 mm	3,5 mm	Titanium	85 kg	both sides	Piece
17SL100=20	Without calf swing	20 mm	100 mm	3,5 mm	Steel	110 kg	both sides	Piece
17SL100=20-T	Without calf swing	20 mm	100 mm	3,5 mm	Titanium	110 kg	both sides	Piece
17SL100=10-*	With calf swing	10 mm	80 mm	3,5 mm	titanium (T), steel (-)	15 kg	left (L), right (R)	Piece
17SL100=12-*	With calf swing	12 mm	80 mm	3,5 mm	titanium (T), steel (-)	20 kg	left (L), right (R)	Piece
17SL100=14-*	With calf swing	14 mm	80 mm	3,5 mm	titanium (T), steel (-)	50 kg	left (L), right (R)	Piece
17SL100=16-*	With calf swing	16 mm	100 mm	3,5 mm	titanium (T), steel (-)	85 kg	left (L), right (R)	Piece
17SL100=20-*	With calf swing	20 mm	100 mm	3,5 mm	titanium (T), steel (-)	110 kg	left (L), right (R)	Piece

- Available versions: With or without calf swing
- Available sizes: 10, 12, 14, 16, 20
- Available materials: titanium (T), steel (-)
- Available sides (for variants with calf swing): right (R), left (L)
- The variants without calf swing can be used in a side-neutral way

Order example for bars with calf swing

Reference number	System width	Side	Material
17SL100	= 12	- L	
Lamination bar with calf swing	12	left	steel
17SL100	= 16	- R	- T
Lamination bar with calf swing	16	right	titanium



17SB100 Nexgear side bars

The side bars are designed for combination with the 17AD200 Nexgear Sixty-six ankle and the 17KL100 Nexgear lock knee, 17KF110 Nexgear free knee and 17KF210 Nexgear posterior knee. They are intended exclusively for bilateral use and in the thermoplastic or bar-clamp technique.

Technical data

Article number	Version	System width	Length	Thickness	Material	Max. body weight	Side	Quantity unit
17SB100=10	Without calf swing	10 mm	270 mm	3,5 mm	Steel	15 kg	both sides	Piece
17SB100=10-L	With calf swing	10 mm	270 mm	3,5 mm	Steel	15 kg	left	Piece
17SB100=10-R	With calf swing	10 mm	270 mm	3,5 mm	Steel	15 kg	right	Piece
17SB100=12	Without calf swing	12 mm	300 mm	3,5 mm	Steel	20 kg	both sides	Piece
17SB100=12-A	Without calf swing	12 mm	300 mm	5 mm	Aluminium	15 kg	both sides	Piece
17SB100=12-L	With calf swing	12 mm	300 mm	3,5 mm	Steel	20 kg	left	Piece
17SB100=12-R	With calf swing	12 mm	300 mm	3,5 mm	Steel	20 kg	right	Piece
17SB100=14	Without calf swing	14 mm	400 mm	3,5 mm	Steel	50 kg	both sides	Piece
17SB100=14-A	Without calf swing	14 mm	400 mm	6 mm	Aluminium	20 kg	both sides	Piece
17SB100=14-L	With calf swing	14 mm	400 mm	3,5 mm	Steel	50 kg	left	Piece
17SB100=14-R	With calf swing	14 mm	400 mm	3,5 mm	Steel	50 kg	right	Piece
17SB100=16	Without calf swing	16 mm	450 mm	3,5 mm	Steel	85 kg	both sides	Piece
17SB100=16-A	Without calf swing	16 mm	450 mm	6 mm	Aluminium	50 kg	both sides	Piece
17SB100=16-L	With calf swing	16 mm	450 mm	3,5 mm	Steel	85 kg	left	Piece
17SB100=16-R	With calf swing	16 mm	450 mm	3,5 mm	Steel	85 kg	right	Piece
17SB100=20	Without calf swing	20 mm	470 mm	3,5 mm	Steel	110 kg	both sides	Piece
17SB100=20-A	Without calf swing	20 mm	470 mm	6 mm	Aluminium	85 kg	both sides	Piece
17SB100=20-L	With calf swing	20 mm	470 mm	3,5 mm	Steel	110 kg	left	Piece
17SB100=20-R	With calf swing	20 mm	470 mm	3,5 mm	Steel	110 kg	right	Piece

- Available versions: With or without calf swing
- Available sizes: 10, 12, 14, 16, 20
- Variants without calf swing in aluminium not available in size 10.
- Note the deviating weight limits for sizes 12, 14, 16, 20.
- Available materials: Steel (-), Variants without calf swing: Steel (-), aluminium (A)
- Available sides (for variants with calf swing): right (R), left (L)
- Variants without calf swing can be used in a side-neutral way.



17MA1 Nexgear function switch

The 17MA1 Nexgear function switch is a switch for unlocking the 17KL100 Nexgear lock knee that also enables unlocking for long periods for riding an indoor bicycle.

Technical data

spare part for	Accessory for
17MA1=1	17KL100=*

- The 17MA1 Nexgear function switch is intended for use with the 17KL100 Nexgear lock knee.
- The following is not included in the scope of delivery and must be ordered separately: 17MA4=1 Perlon cable (optional)

Spare parts for 17MA1



17MA2 Spare part set with screws

Service set for the 17MA1=1 Nexgear function switch. The set includes insert nuts, cap screws and other screws.

Technical data

Article number	Spare part for
17MA2=1	17MA1=1



17MA3 Spare part set bowden cable

Service set for the 17MA1=1 Nexgear function switch. The set includes retaining clamps, pull cable, cable guide, protective caps and shrinkable tubing.

Technical data

Article number	Spare part for
17MA3=1	17MA1=1

Accessory for 17MA1



17MA4 Perlon cable

Accessory set for the 17MA1=1 Nexgear function switch. It includes a perlon cable, a ferrule and two threaded sleeves. Optionally, the handle of the function switch can be replaced with the perlon cable, so that the perlon cable can be used to unlock the locking mechanism.

Technical data

Article number	Accessory for
17MA4=1	17MA1=1

17KL100 Nexgear lock knee. Order form.

Notice: This order form is only for sizes 10, 12.
Please use one form per orthosis.

Contact person		Customer number	Date
Customer		Shipping address (if different from customer address)	
Customer number		Customer number	
Company		Company	
Street		Street	
Postcode	Town/City	Postcode	Town/City
User data (optional)		Indication	
Patient ID		Side <input type="radio"/> Left <input type="radio"/> Right	
Weight			

Notice: When specifying quantities, please note that the quantity unit for all articles is "piece".

System size based on maximum body weight

System size	Max. body weight (kg)
<input type="radio"/> 10	0 - 15
<input type="radio"/> 12	16 - 20

Nexgear bilateral joint system

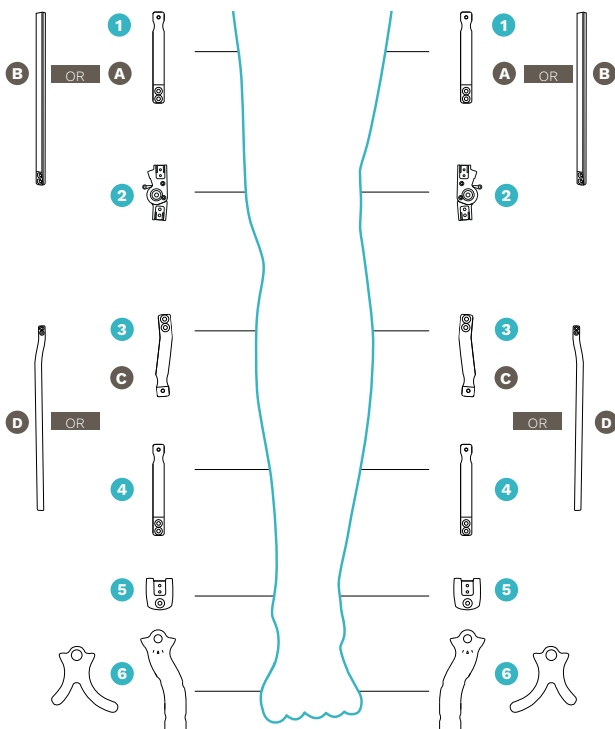

1 Bar

(A) 17SL100 lamination bar

Pc.	Titanium	Pc.	Steel
	17SL100=10-T		17SL100=10
	17SL100=12-T		17SL100=12

(B) 17SB100 side bar

Pc.	Steel	Pc.	Aluminium
	17SB100=10		17SB100=12-A
	17SB100=12		

4 Bar





17SL100 lamination bar

Pc.	Titanium	Pc.	Steel
	17SL100=10-T		17SL100=10
	17SL100=12-T		17SL100=12

2 Bilateral orthotic knee joint

17KL100 Nexgear lock knee

Titanium				Steel											
Left		Right		Left		Right									
Pc.	Article number	Size	V*	Pc.	Article number	Size	V*	Pc.	Article number	Size	V*	Pc.	Article number	Size	V*
	17KL100=L-10-1-T	10	1		17KL100=R-10-1-T	10	1		17KL100=L-10-1-ST	10	1		17KL100=R-10-1-ST	10	1
	17KL100=L-10-2-T	10	2		17KL100=R-10-2-T	10	2		17KL100=L-10-2-ST	10	2		17KL100=R-10-2-ST	10	2
	17KL100=L-10-3-T	10	3		17KL100=R-10-3-T	10	3		17KL100=L-10-3-ST	10	3		17KL100=R-10-3-ST	10	3
	17KL100=L-10-4-T	10	4		17KL100=R-10-4-T	10	4		17KL100=L-10-4-ST	10	4		17KL100=R-10-4-ST	10	4
	17KL100=L-12-1-T	12	1		17KL100=R-12-1-T	12	1		17KL100=L-12-1-ST	12	1		17KL100=R-12-1-ST	12	1
	17KL100=L-12-2-T	12	2		17KL100=R-12-2-T	12	2		17KL100=L-12-2-ST	12	2		17KL100=R-12-2-ST	12	2
	17KL100=L-12-3-T	12	3		17KL100=R-12-3-T	12	3		17KL100=L-12-3-ST	12	3		17KL100=R-12-3-ST	12	3
	17KL100=L-12-4-T	12	4		17KL100=R-12-4-T	12	4		17KL100=L-12-4-ST	12	4		17KL100=R-12-4-ST	12	4

*Variant	1	2	3	4
Version upper section/lower section	Straight/straight (left/right)	Straight/contoured	Contoured/straight	Contoured/contoured
Notice: The variants are shown in the left lateral frontal version.				

3 Bar

(C) 17SL100 lamination bar

Titanium		Steel	
Pc.	Straight	Pc.	Straight
	17SL100=10-T		17SL100=10
	17SL100=12-T		17SL100=12
With contoured calf		With contoured calf	
	17SL100=10-L-T		17SL100=10-L
	17SL100=10-R-T		17SL100=10-R
	17SL100=12-L-T		17SL100=12-L
	17SL100=12-R-T		17SL100=12-R

(D) 17SB100 side bar

Steel		Aluminium	
Pc.	Straight	Pc.	
	17SB100=10		17SB100=12-A
	17SB100=12		
With contoured calf			
	17SB100=10-L		
	17SB100=10-R		
	17SB100=12-L		
	17SB100=12-R		

5 Orthotic ankle joint

17AD200 Nexgear Sixty-six ankle

Pc.	Titanium	Pc.	Steel
	17AD200=10-T		17AD200=10
	17AD200=12-T		17AD200=12

6 Foot stirrup

17SF200 foot stirrup for 17AD200

Pc.	Straight	Pc.	Forked
	17SF200=OS-10		17SF200=FT-10
	17SF200=OS-12		17SF200=FT-12

7 Lock lever (optional)

17KL103 lock lever, long, for 17KL100

Pc.	
	17KL103=10
	17KL103=12

8 Function switch (optional)

17MA1 Nexgear function switch

Pc.	
	17MA1=1 Nexgear function switch
	17MA4=1 perlon cable for 17MA1

17KL100 Nexgear lock knee. Order form.

Notice: This order form is only for sizes 14, 16, 20.
Please use one form per orthosis.

Contact person		Customer number	Date
Customer		Shipping address (if different from customer address)	
Customer number		Customer number	
Company		Company	
Street		Street	
Postcode	Town/City	Postcode	Town/City
User data (optional)		Indication	
Patient ID		Side <input type="radio"/> Left <input type="radio"/> Right	
Weight			

Notice: When specifying quantities, please note that the quantity unit for all articles is "piece".

System size based on maximum body weight

System size	Max. body weight (kg)
<input type="radio"/> 14	21 - 50
<input type="radio"/> 16	51 - 85
<input type="radio"/> 20	86 - 110

Nexgear bilateral joint system

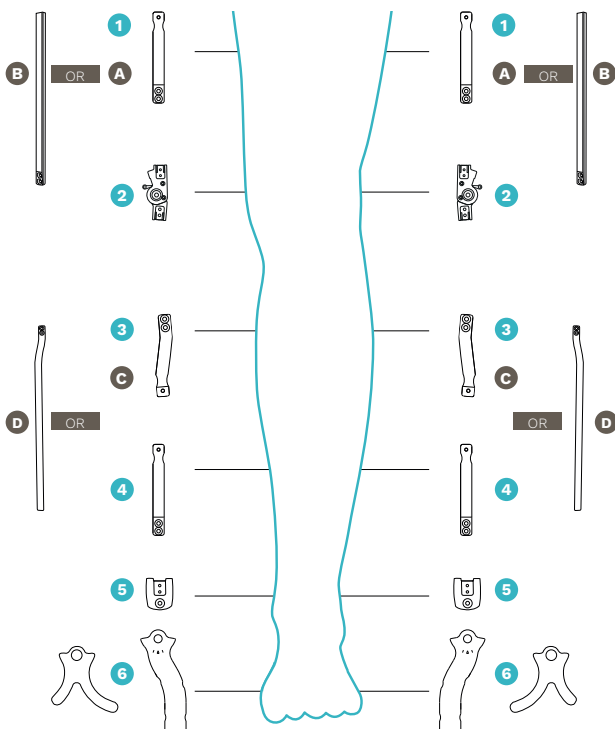

1 Bar

(A) 17SL100 lamination bar

Pc.	Titanium	Pc.	Steel
	17SL100=14-T		17SL100=14
	17SL100=16-T		17SL100=16
	17SL100=20-T		17SL100=20

(B) 17SB100 side bar

Pc.	Steel	Pc.	Aluminium
	17SB100=14		17SB100=14-A
	17SB100=16		17SB100=16-A
	17SB100=20		17SB100=20-A

4 Bar





17SL100 lamination bar

Pc.	Titanium	Pc.	Steel
	17SL100=14-T		17SL100=14
	17SL100=16-T		17SL100=16
	17SL100=20-T		17SL100=20

2 Bilateral orthotic knee joint

17KL100 Nexgear lock knee

Titanium								Steel							
Left				Right				Left				Right			
Pc.	Article number	Size	V*	Pc.	Article number	Size	V*	Pc.	Article number	Size	V*	Pc.	Article number	Size	V*
	17KL100=L-14-1-T	14	1		17KL100=R-14-1-T	14	1		17KL100=L-14-1-ST	14	1		17KL100=R-14-1-ST	14	1
	17KL100=L-14-2-T	14	2		17KL100=R-14-2-T	14	2		17KL100=L-14-2-ST	14	2		17KL100=R-14-2-ST	14	2
	17KL100=L-14-3-T	14	3		17KL100=R-14-3-T	14	3		17KL100=L-14-3-ST	14	3		17KL100=R-14-3-ST	14	3
	17KL100=L-14-4-T	14	4		17KL100=R-14-4-T	14	4		17KL100=L-14-4-ST	14	4		17KL100=R-14-4-ST	14	4
	17KL100=L-16-1-T	16	1		17KL100=R-16-1-T	16	1		17KL100=L-16-1-ST	16	1		17KL100=R-16-1-ST	16	1
	17KL100=L-16-2-T	16	2		17KL100=R-16-2-T	16	2		17KL100=L-16-2-ST	16	2		17KL100=R-16-2-ST	16	2
	17KL100=L-16-3-T	16	3		17KL100=R-16-3-T	16	3		17KL100=L-16-3-ST	16	3		17KL100=R-16-3-ST	16	3
	17KL100=L-16-4-T	16	4		17KL100=R-16-4-T	16	4		17KL100=L-16-4-ST	16	4		17KL100=R-16-4-ST	16	4
	17KL100=L-20-1-T	20	1		17KL100=R-20-1-T	20	1		17KL100=L-20-1-ST	20	1		17KL100=R-20-1-ST	20	1
	17KL100=L-20-2-T	20	2		17KL100=R-20-2-T	20	2		17KL100=L-20-2-ST	20	2		17KL100=R-20-2-ST	20	2
	17KL100=L-20-3-T	20	3		17KL100=R-20-3-T	20	3		17KL100=L-20-3-ST	20	3		17KL100=R-20-3-ST	20	3
	17KL100=L-20-4-T	20	4		17KL100=R-20-4-T	20	4		17KL100=L-20-4-ST	20	4		17KL100=R-20-4-ST	20	4

*Variant	1	2	3	4
Version upper section/lower section	Straight/straight (left/right)	Straight/contoured	Contoured/straight	Contoured/contoured
Notice: The variants are shown in the left lateral frontal version.				

3 Bar

(C) 17SL100 lamination bar

Titanium		Steel	
Pc.	Straight	Pc.	Straight
	17SL100=14-T		17SL100=14
	17SL100=16-T		17SL100=16
	17SL100=20-T		17SL100=20
Pc.	With contoured calf	Pc.	With contoured calf
	17SL100=14-L-T		17SL100=14-L
	17SL100=14-R-T		17SL100=14-R
	17SL100=16-L-T		17SL100=16-L
	17SL100=16-R-T		17SL100=16-R
	17SL100=20-L-T		17SL100=20-L
	17SL100=20-R-T		17SL100=20-R

(D) 17SB100 side bar

Steel		Aluminium	
Pc.	Straight	Pc.	
	17SB100=14		17SB100=14-A
	17SB100=16		17SB100=16-A
	17SB100=20		17SB100=20-A
Pc.	With contoured calf		
	17SB100=14-L		
	17SB100=14-R		
	17SB100=16-L		
	17SB100=16-R		
	17SB100=20-L		
	17SB100=20-R		

5 Orthotic ankle joint

17AD200 Nexgear Sixty-six ankle

Pc.	Titanium	Pc.	Steel
	17AD200=14-T		17AD200=14
	17AD200=16-T		17AD200=16
	17AD200=20-T		17AD200=20

6 Foot stirrup

17SF200 foot stirrup for 17AD200

Pc.	Straight	Pc.	Forked
	17SF200=OS-14		17SF200=FT-14
	17SF200=OS-16		17SF200=FT-16
	17SF200=OS-20		17SF200=FT-20

7 Lock lever (optional)

17KL103 lock lever, long, for 17KL100

Pc.	
	17KL103=14
	17KL103=16
	17KL103=20

8 Function switch (optional)

17MA1 Nexgear function switch

Pc.	
	17MA1=1 Nexgear function switch
	17MA4=1 perlon cable for 17MA1



17PK1 CarbonIQ knee joint

The 17PK1=* knee joint is a locked joint made of fibre-reinforced plastic with a pull-release cable. The locking system uses the latest technology for locked joints and offers a high level of security. It can be unlocked with one hand using the pull-release cable, making it very simple to use. The lock in the joint clicks into place automatically when standing up, without the risk of trapping clothes. Medial and lateral joints are straight.



Technical data

Article number	Side	Max. body weight	Quantity unit
17PK1=14	left, right	45 kg	Pair
17PK1=20	left, right	100 kg	Pair

· Attention: For waterproof walking aids, use the waterproof versions of the CarbonIQ joints (see Waterproof walking aids section).

Spare parts for 17PK1=14

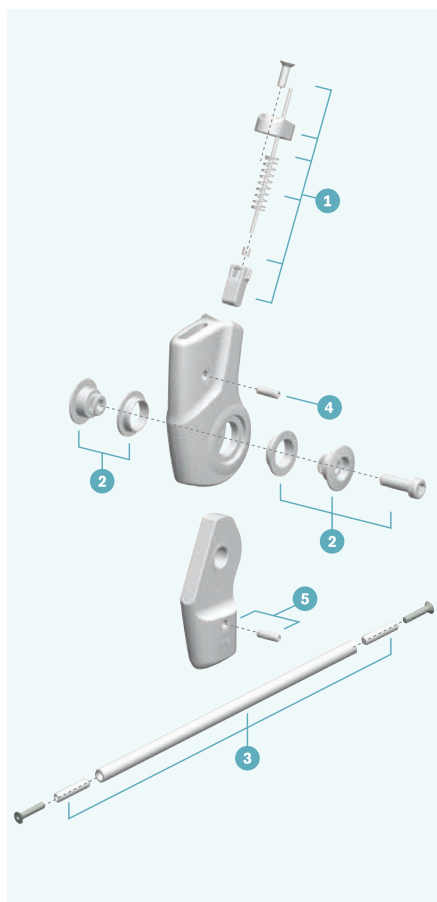

1) 29PK1 Service set

Technical data

Article number	Scope of delivery	Quantity unit
29PK1=14	21A18=2 21A12 30Y286 30Y287 513D30=0.53X4.97X2 501S146=3.0X12	Set

2) 29PK2 Service set

Technical data

Article number	Scope of delivery	Quantity unit
29PK2=14	501S84=M5X20 509G10=14X16X4.7 30Y288 30Y285	Set

3) 29PK4 Adjustment aid

Technical data

Article number	Scope of delivery	Quantity unit
29PK4=14	1× flat head screw 1× paralleling tool 1× parallel retainer adapter	Set

4, 5) 506G21 Set screw

Technical data

Article number	Quantity unit
506G21=M4X12	Piece

Spare parts for 17PK1=20

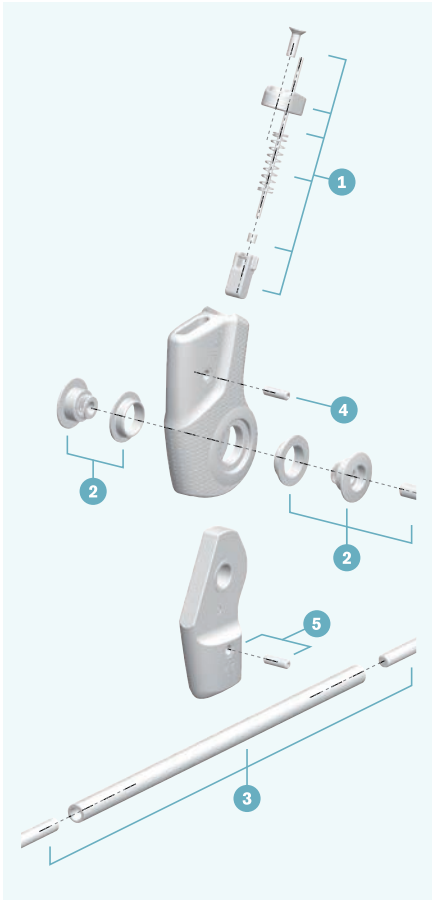

1) 29PK1 Service set

Technical data

Article number	Scope of delivery	Quantity unit
29PK1	21A18=2 513D52=1 21A12 30Y206 30Y207 501S146=4.0X12	Set

2) 29PK2 Service set

Technical data

Article number	Scope of delivery	Quantity unit
29PK2	501T39=M6X18 509G10=14X16X5 30Y209 30Y210	Set

3) 29PK4 Adjustment aid

Technical data

Article number	Scope of delivery	Quantity unit
29PK4	1× cap screw 1× paralleling tool	Set

4, 5) 506G3 Set screw

Technical data

Article number	Quantity unit
506G3=M4X12	Piece

Accessory for 17PK1



651P4 Stainless steel profile bar

Suitable for fabricating system bars, with rounded edges, strength of approx. 800–950 N/mm², spot weldable

Technical data

Article number	Length	Width	Thickness
651P4=14	2000 mm	14 mm	4 mm
651P4=20	2000 mm	20 mm	4 mm

· To process the bars, order also 636W28 (special adhesive and hardener). Please refer to the 646K1 materials catalogue for further information on these products.



605P8 Light metal profile bar

Suitable for fabricating system splints, with rounded edges, strength approx. 400 N/mm²

Technical data

Article number	Length	Width
605P8=14	1000 mm	14 mm
605P8=20	2000 mm	20 mm

· To process the bars, order also 636W28 (special adhesive and hardener). Please refer to the 646K1 materials catalogue for further information on these products.



17B44 System knee joint

Locked knee joint with adjustable Swiss lock for positioning orthoses

Flexion angle adjustment up to max. 16° knee flexion and 100 kg body weight possible in gait orthoses

Contoured medial joint, straight lateral joint, Swiss lock with flexion adjustment



Technical data

Article number	Side	System width	Length from joint centre upper	Length from joint centre lower	Material	Quantity unit
17B44=L16	left (L)	16 mm	56 mm	38 mm	Stainless steel	Pair
17B44=R16	right (R)	16 mm	56 mm	38 mm	Stainless steel	Pair
17B44=L20	left (L)	20 mm	56 mm	38 mm	Stainless steel	Pair
17B44=R20	right (R)	20 mm	56 mm	38 mm	Stainless steel	Pair

Spare parts for 17B44

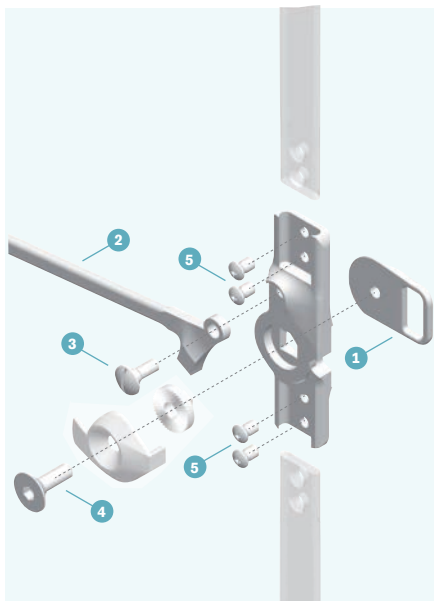

1) 17Y56 Knee cap ring plate

Technical data

Article number	Side	For system width	Material	Quantity unit
17Y56=L	left (L)	16 and 20 mm	Stainless steel	Piece
17Y56=R	right (R)	16 and 20 mm	Stainless steel	Piece

2) 17Y57 Lock lever

Technical data

Article number	Side	For system width	Material	Quantity unit
17Y57=L	left (L)	16 and 20 mm	Stainless steel	Piece
17Y57=R	right (R)	16 and 20 mm	Stainless steel	Piece

3) 501A23 Oval head screw

Technical data

Article number	Material	Quantity unit
501A23	Stainless steel	Piece

4) 501S55 Countersunk allen head screw

Technical data

Article number	Quantity unit
501S55=M6X20X16	Piece

5) 501T7 Phillips oval countersunk head screw

Technical data

Article number	for	Head Ø	Length	Material	Quantity unit
501T7=7.5X9XM5	System side bars	7.5 mm	9 mm	Stainless steel	Piece



17B23 System knee joint

Contoured medial joint, straight lateral joint, with centrally* fitted covered lock, lock lever points upwards



Technical data

Article number	Side	System width	Length from joint centre upper	Length from joint centre lower	Material	Quantity unit
17B23=L16	left (L)	16 mm	56 mm	38 mm	Stainless steel	Pair
17B23=R16	right (R)	16 mm	56 mm	38 mm	Stainless steel	Pair
17B23=L20	left (L)	20 mm	56 mm	38 mm	Stainless steel	Pair
17B23=R20	right (R)	20 mm	56 mm	38 mm	Stainless steel	Pair

* Attention: Eccentric and centric lock lever assemblies must not be interchanged; otherwise, the reliability of the locking function cannot be guaranteed!



17B23K System knee joint

Contoured medial joint, straight lateral joint, with eccentrically* fitted covered lock, self-adjusting, short lock lever, with pull-release cable



Technical data

Article number	Side	System width	Length from joint centre upper	Length from joint centre lower	Material	Quantity unit
17B23=L16K	left (L)	16 mm	56 mm	38 mm	Stainless steel	Pair
17B23=R16K	right (R)	16 mm	56 mm	38 mm	Stainless steel	Pair
17B23=L20K	left (L)	20 mm	56 mm	38 mm	Stainless steel	Pair
17B23=R20K	right (R)	20 mm	56 mm	38 mm	Stainless steel	Pair

* Attention: Eccentric and centric lock lever assemblies must not be interchanged; otherwise, the reliability of the locking function cannot be guaranteed!



17B45 System knee joint

Medial and lateral joint are straight, with centrally* fitted covered lock, lock lever points upwards



Technical data

Article number	System width	Length from joint centre upper	Length from joint centre lower	Material	Quantity unit
17B45=16	16 mm	56 mm	38 mm	Stainless steel	Pair
17B45=20	20 mm	56 mm	38 mm	Stainless steel	Pair

* Attention: Eccentric and centric lock lever assemblies must not be interchanged; otherwise, the reliability of the locking function cannot be guaranteed!



17B92 System knee joints

Medial joint is contoured at the bottom and straight at the top, lateral joint is straight, with centrally* fitted covered lock, lock lever points upwards



Technical data

Article number	Side	System width	Length from joint centre upper	Length from joint centre lower	Material	Quantity unit
17B92=L16	left (L)	16 mm	56 mm	38 mm	Stainless steel	Pair
17B92=L20	left (L)	20 mm	56 mm	38 mm	Stainless steel	Pair
17B92=R16	right (R)	16 mm	56 mm	38 mm	Stainless steel	Pair
17B92=R20	right (R)	20 mm	56 mm	38 mm	Stainless steel	Pair

* Attention: Eccentric and centric lock lever assemblies must not be interchanged; otherwise, the reliability of the locking function cannot be guaranteed!

Spare parts for 17B23, 17B23K, 17B45, 17B92

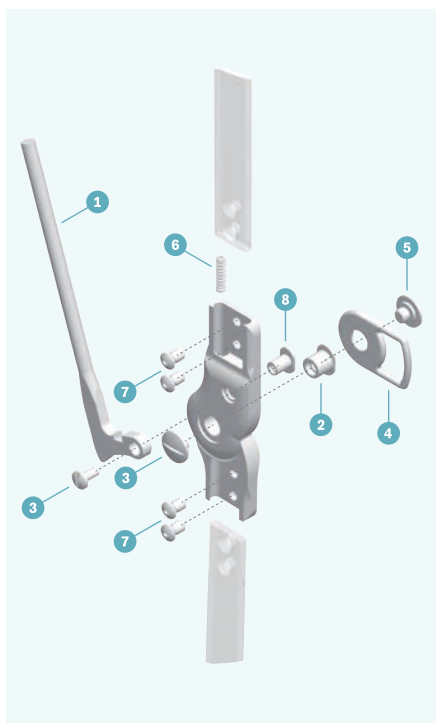

1) 17Y104 Short lock lever

Technical data

Article number	Material	Quantity unit
17Y104	Stainless steel	Piece

1) 17Y20 Lock lever

Technical data

Article number	Material	Quantity unit
17Y20	Stainless steel	Piece

2, 8) 17Y93 Bearing nut, hardened

Technical data

Article number	Spare part for	Insertion length	Profile length	Shank length	Thread	Shoulder Ø	Quantity unit
17Y93=6X9.15XM4	17B23=L16 17B23=R16 17B23=L16K 17B23=R16K 17B23=L20 17B23=R20 17B23=L20K 17B23=R20K 17B45=16 17B45=20 17B92=L16 17B92=R16 17B92=L20 17B92=R20	7.9 mm	12 mm	9.15 mm	M4	6 mm	Piece
17Y93=6.5X9.15XM4	17B23=L16 17B23=R16 17B23=L16K 17B23=R16K 17B23=L20 17B23=R20 17B23=L20K 17B23=R20K 17B45=16 17B45=20 17B92=L16 17B92=R16 17B92=L20 17B92=R20	7.9 mm	12 mm	9.15 mm	M4	6.5 mm	Piece
17Y93=9X9.2XM6	17B23=L16 17B23=R16 17B23=L16K 17B23=R16K 17B23=L20 17B23=R20 17B23=L20K 17B23=R20K 17B45=16 17B45=20 17B92=L16 17B92=R16 17B92=L20 17B92=R20	8 mm	14 mm	9.2 mm	M6	9 mm	Piece
17Y93=9.5X9.2XM6	17B23=L16 17B23=R16 17B23=L16K 17B23=R16K 17B23=L20 17B23=R20 17B23=L20K 17B23=R20K 17B45=16 17B45=20 17B92=L16 17B92=R16 17B92=L20 17B92=R20	8 mm	14 mm	9.2 mm	M6	9.5 mm	Piece

3) 501S32 Slotted truss head screw

Technical data

Article number	For system width	Head Ø	Length	Thread	Material	Quantity unit
501S32=M4X8X11.5	16 and 20 mm	8 mm	11.5 mm	M4	Stainless steel	Piece
501S32=M6X14X7.5	16 and 20 mm	14 mm	7.5 mm	M6	Stainless steel	Piece
501S32=M6X14X12	16 and 20 mm	14 mm	12 mm	M6	Stainless steel	Piece

4) 17Y84 Knee cap ring plate

Technical data

Article number	Accessory for	Quantity unit
17Y84	17B33=L16 17B33=R16 17B33=L20 17B33=R20 17B91=L16 17B91=R16 17B91=L20 17B91=R20	Piece

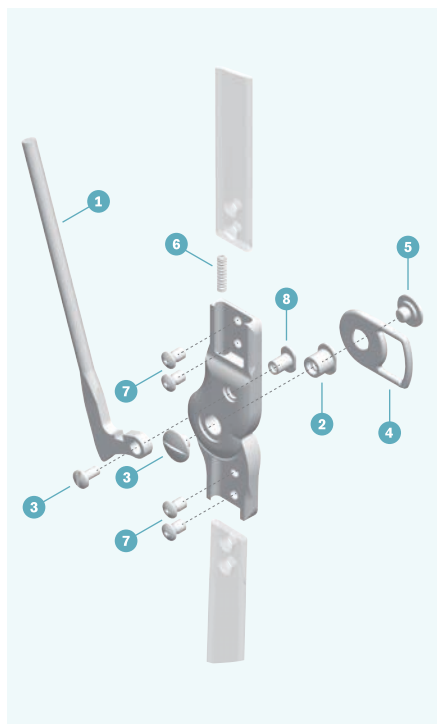

5) 501A11 Oval head screw, slotted and partially threaded

Technical data

Article number	Spare part for	Thread	Shoulder Ø	Head Ø	Material	Quantity unit
501A11=14X9XM6	17B23=L16 17B23=R16 17B23=L16K 17B23=R16K 17B23=L20 17B23=R20 17B23=L20K 17B23=R20K 17B45=16 17B45=20 17B92=L16 17B92=R16 17B92=L20 17B92=R20	M6	9 mm	14 mm	Stainless steel	Piece

6) 513D19 Compression spring

Technical data

Article number	Spare part for	Quantity unit
513D19=3.8X16	17B23=L16 17B23=R16 17B23=L16K 17B23=R16K 17B23=L20 17B23=R20 17B23=L20K 17B23=R20K 17B45=16 17B45=20 17B92=L16 17B92=R16 17B92=L20 17B92=R20	Piece

7) 501T7 Phillips oval countersunk head screw

Technical data

Article number	for	Head Ø	Length	Material	Quantity unit
501T7=7.5X9XM5	System side bars	7.5 mm	9 mm	Stainless steel	Piece



17MS30 Pull-release cable

The pull-release cable can be positioned anterior or posterior. Thanks to the change of direction, less force is required for pulling.

Technical data

Article number	Accessory for	Quantity unit
17MS30=A	17KL20=13 17KL20=13-A 17KL20=20 17KL20=20-A	Pair

- Thanks to the change of direction, less force is required for pulling.
- The pull-release cable can be installed in the anterior or posterior position.
- Side bars must be ordered separately.



17B91 System knee joint

Medial joint is contoured at the bottom and straight at the top, lateral joint is straight, with centrally* fitted covered lock, lock lever points downwards



Technical data

Article number	Side	System width	Material	Quantity unit
17B91=L16	left (L)	16 mm	Stainless steel	Pair
17B91=R16	right (R)	16 mm	Stainless steel	Pair
17B91=L20	left (L)	20 mm	Stainless steel	Pair
17B91=R20	right (R)	20 mm	Stainless steel	Pair



Practical recommendation

- Lamination dummy for lamination resin technique: 17Y103



17B33 System knee joint

Medial joint is contoured, lateral joint is straight, with covered lock, lock lever points downward



Technical data

Article number	Side	System width	Material	Quantity unit
17B33=L16	left (L)	16 mm	Stainless steel	Pair
17B33=L20	left (L)	20 mm	Stainless steel	Pair
17B33=R16	right (R)	16 mm	Stainless steel	Pair
17B33=R20	right (R)	20 mm	Stainless steel	Pair



Practical recommendation

- Lamination dummy for lamination resin technique: 17Y103

Spare parts for 17B91, 17B33

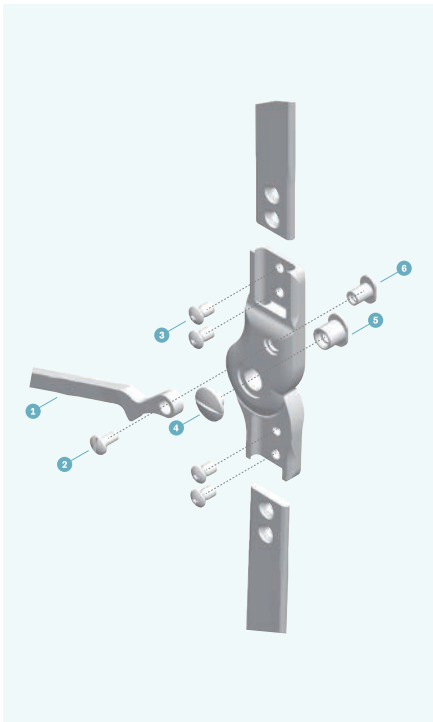

1) 17Y34 Lock lever

Technical data

Article number	Spare part for	Material	Quantity unit
17Y34	17B33=L16 17B33=L20 17B33=R16 17B33=R20 17B91=L16 17B91=L20 17B91=R16 17B91=R20	Stainless steel	Piece

2) 501S32 Slotted truss head screw

Technical data

Article number	Spare part for	Thread	Length	Material	Quantity unit
501S32=M4X8X11.5	17B33=L16 17B33=L20 17B33=R16 17B33=R20 17B91=L16 17B91=L20 17B91=R16 17B91=R20	M4	11.5 mm	Stainless steel	Piece

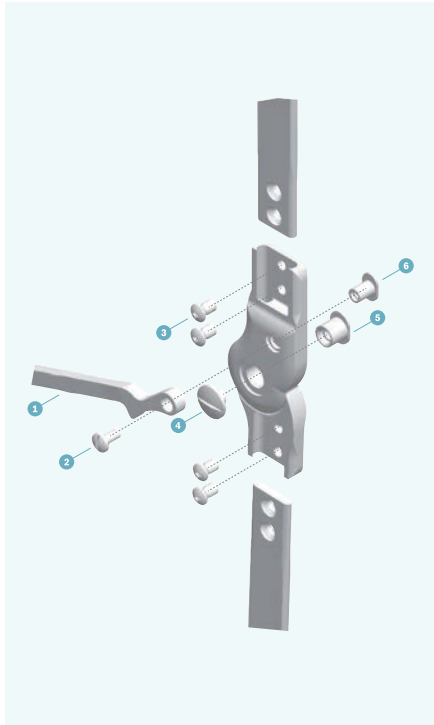

3) 17Y97 Screw set, Phillips

Technical data

Article number	Spare part for	Quantity unit
17Y97	17B33=L16 17B33=R16 17B33=L20 17B33=R20 17B91=L16 17B91=R16 17B91=L20 17B91=R20	Set

4) 501S32 Slotted truss head screw

Technical data

Article number	Spare part for	Thread	Length	Material	Quantity unit
501S32=M6X14X12	17B33=L16 17B33=R16 17B33=L20 17B33=R20 17B91=L16 17B91=R16 17B91=L20 17B91=R20	M6	12 mm	Stainless steel	Piece

5) 17Y93 Bearing nut, hardened

Technical data

Article number	Spare part for	Thread	Shank length	Shoulder Ø	Quantity unit
17Y93=9X9.2XM6	17B33=L16 17B33=R16 17B33=L20 17B33=R20 17B91=L16 17B91=R16 17B91=L20 17B91=R20	M6	9.2 mm	9 mm	Piece

6) 17Y93 Bearing nut, hardened

Technical data

Article number	Spare part for	Thread	Shank length	Shoulder Ø	Quantity unit
17Y93=6X9.15XM4	17B33=L16 17B33=R16 17B33=L20 17B33=R20 17B91=L16 17B91=R16 17B91=L20 17B91=R20	M4	9.15 mm	6 mm	Piece

Accessory for 17B91, 17B33



17Y84 Knee cap ring plate

Knee cap ring plate made of stainless steel for system knee joints

Technical data

Article number	Accessory for	Quantity unit
17Y84	17B33=L16 17B33=R16 17B33=L20 17B33=R20 17B91=L16 17B91=R16 17B91=L20 17B91=R20	Piece



501A11 Oval head screw, slotted and partially threaded

Technical data

Article number	Accessory for	Thread	Shoulder Ø	Head Ø	Material	Quantity unit
501A11=14X9XM6	17B33=L16 17B33=R16 17B33=L20 17B33=R20 17B91=L16 17B91=R16 17B91=L20 17B91=R20	M6	9 mm	14 mm	Stainless steel	Piece



501S32 Slotted truss head screw

Slotted truss head screw made of stainless steel

Technical data

Article number	Accessory for	Thread	Length	Material	Quantity unit
501S32=M6X14X7.5	17B33=L16 17B33=R16 17B33=L20 17B33=R20 17B91=L16 17B91=R16 17B91=L20 17B91=R20	M6	7.5 mm	Stainless steel	Piece



Aqualine orthotic system

The Aqualine orthotic system is a waterproof walking aid for orthosis wearers which offers the user the greatest possible safety with simultaneous freedom of movement.

Key features

- All of its components are specially designed for contact with water
- The orthosis is lightweight thanks to its high-quality carbon material
- The orthosis is easy to clean



Information for specialist dealers

- *All components in a waterproof walking aid should be waterproof and easy to wash.*
- *The waterproof walking aid should have minimal contact with the skin.*
- *We recommend the use of antibacterial materials.*
- *We generally recommend the use of a full-surface non-skid sole or a bathing shoe, as well as the use of a knee joint with lock.*

Aqualine

The solution for wet areas

3

Loop strap

The loop strap is comfortable to wear and can be removed for drying.

Waterproof CarbonIQ knee joint

The waterproof versions of the CarbonIQ knee and ankle joints form the heart of the Aqualine orthotic system. The knee joint is equipped with a covered lock and can be easily unlocked using a pull-release cable. The high-performance plastic material is reinforced with carbon fibres.

ThermoLyn

ThermoLyn is antibacterial and has ideal hygienic properties.

Waterproof CarbonIQ ankle joint

The waterproof versions of the CarbonIQ knee and ankle joints form the heart of the Aqualine orthotic system. With nine different setting and combination options, the strength and angle of the ankle joint can be individually adjusted.

Foot component

Double vacuum-formed foot component with sole.



Components of the Aqualine orthotic systems



17PK1=*-WR Waterproof CarbonIQ knee joint

The 17PK1=*-WR knee joint is the waterproof version of the 17PK1 CarbonIQ knee joint. It is a locked joint made of fibre-reinforced plastic with a pull-release cable. The locking system uses the latest technology for locked joints and offers a high level of security. It can be unlocked with one hand using the pull-release cable, making it very simple to use. The lock in the joint clicks into place automatically when standing up, without the risk of trapping clothes. Contoured medial joint, straight lateral joint



Technical data

Article number	Side	Max. body weight	Material	Quantity unit
17PK1=L14-WR	left (L)	45 kg	Plastic reinforced with carbon fibre	Pair
17PK1=R14-WR	right (R)	45 kg	Plastic reinforced with carbon fibre	Pair
17PK1=L20-WR	left (L)	100 kg	Plastic reinforced with carbon fibre	Pair
17PK1=R20-WR	right (R)	100 kg	Plastic reinforced with carbon fibre	Pair



17PA1=*-WR Waterproof CarbonIQ orthotic ankle joint

The 17PA1=*-WR ankle joint is the waterproof version of the 17PA1 CarbonIQ ankle joint. The double-action joint offers the most versatile fitting by far. Various possibilities for settings and combinations allow the functions of this type of joint to be adapted to the user's requirements at any time, even if these change over the course of the fitting. Different versions to influence plantar flexion and dorsal extension are available.



Technical data

Article number	Max. body weight	Material	Quantity unit
17PA1=14-WR	45 kg	Plastic reinforced with carbon fibre	Pair
17PA1=20-WR	100 kg	Plastic reinforced with carbon fibre	Pair



17PF1 Foot stirrup

Foot stirrup for 17PA1 and 17PA1=*-WR

Technical data

Article number	Accessory for	Material	Quantity unit
17PF1	17PA1=20 17PA1=20-WR	Stainless steel	Pair
17PF1=14	17PA1=14 17PA1=14-WR	Stainless steel	Pair



605P8 Light metal profile bar

Suitable for fabricating system splints, with rounded edges, strength approx. 400 N/mm²

Technical data

Article number	Length	Width	Thickness	Quantity unit
605P8=14	1000 mm	14 mm	5 mm	Piece
605P8=20	2000 mm	20 mm	5 mm	Piece

· To process the bars, order also 636W28 (special adhesive and hardener). Please refer to the 646K1 materials catalogue for further information on these products.



170Z4 Hook-and-loop strap

Technical data

Article number	Length	Width	Material	Colour	Quantity unit
170Z4=400-7	400 mm	40 mm	Polyamide	Black	Piece
170Z4=600-7	600 mm	40 mm	Polyamide	Black	Piece



616T* ThermoLyn PP-H

Technical data

Article number	Length	Width	Thickness	Colour
616T20=2000X5	2000 mm	1,000 mm	5 mm	Natural colour
616T20=2000X6	2000 mm	1,000 mm	6 mm	Natural colour



501S84 Flat head screw

Technical data

Article number	Quantity unit
501S84=M4X8	Piece

Spare parts for 17PA1=14-WR

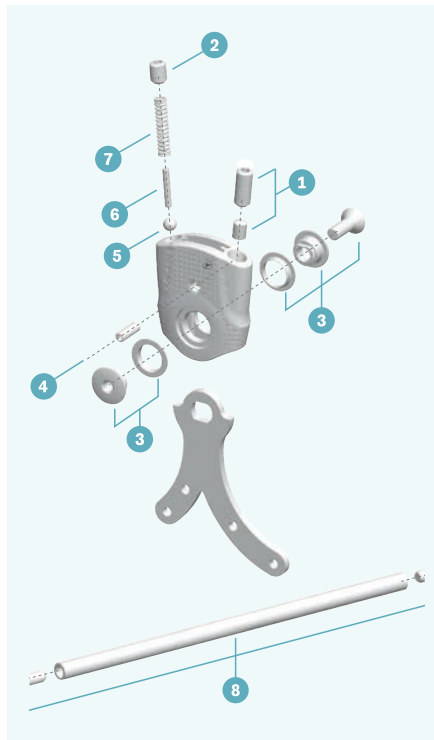

1) 30G79 Set of Stops

Technical data

Article number	Scope of delivery	Quantity unit
30G79	1x set screw 1x cylinder Pin	Set

2) 30Y289 Set screw with end bore

Technical data

Article number	Quantity unit
30Y289	Piece

3) 29PA1 Service set

Technical data

Article number	Scope of delivery	Quantity unit
29PA1=14	1 x Joint nut 1 x Joint bolt 1 x Bearing bushing 1 x Countersunk screw	Set

4) 506G21 Grub screw

Technical data

Article number	Quantity unit
506G21=M4X12	Piece

5) 509Y1 Bearing ball

Technical data

Article number	Quantity unit
509Y1=5.0	Piece

6) 506A8 Cylinder Pin

Technical data

Article number	Quantity unit
506A8=2X16	Piece

7) 513D87 Compression spring

Technical data

Article number	Quantity unit
513D87=0.75X2.95X2	Piece

8) 29PK4 Adjustment aid

Technical data

Article number	Scope of delivery	Quantity unit
29PK4=14	1x flat head screw 1x paralleling tool 1x parallel retainer adapter	Set

Spare parts for 17PA1=20-WR

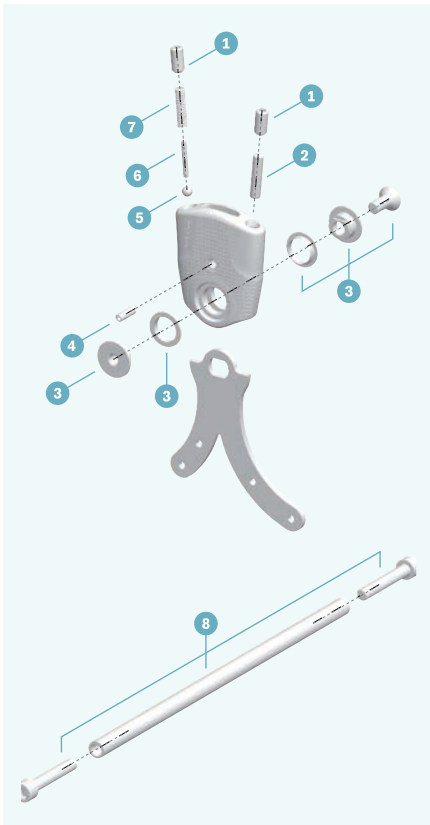

1) 506G21 Grub screw

Technical data

Article number	Quantity unit
506G21=M6X14	Piece

2) 506A27 Stop pin

Technical data

Article number	Quantity unit
506A27=5M6X20	Piece

3) 29PA1 Service set

Technical data

Article number	Scope of delivery	Quantity unit
29PA1	1 x Countersunk screw 1 x Joint bolt 1 x Joint nut 1 x Bearing bushing	Set

4) 506G21 Grub screw

Technical data

Article number	Quantity unit
506G21=M4X12	Piece

5) 509Y1 Bearing ball

Technical data

Article number	Quantity unit
509Y1=5.0	Piece

6) 506A5 Stop pin (small)

Technical data

Article number	Quantity unit
506A5=2.5M6X18	Piece

7) 513D18 Compression spring

Technical data

Article number	Quantity unit
513D18=4.7X31-2	Piece

8) 29PK4 Adjustment aid

Technical data

Article number	Scope of delivery	Quantity unit
29PK4	1x cap screw 1x paralleling tool	Set

Spare parts for 17PK1=L/R14-WR

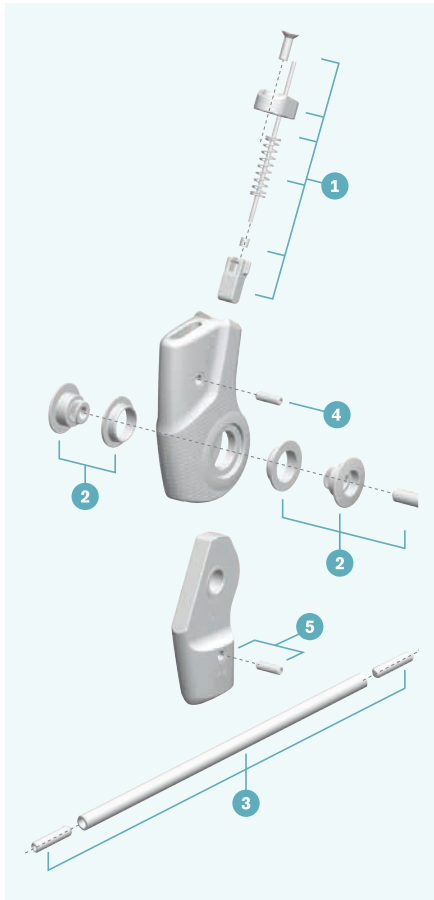

1) 29PK1 Service set

Technical data

Article number	Scope of delivery	Quantity unit
29PK1=14	21A18=2 21A12 30Y286 30Y287 513D30=0.53X4.97X2 501S146=3.0X12	Set

2) 29PK2 Service set

Technical data

Article number	Scope of delivery	Quantity unit
29PK2=14	501S84=M5X20 509G10=14X16X4.7 30Y288 30Y285	Set

3) 29PK4 Adjustment aid

Technical data

Article number	Scope of delivery	Quantity unit
29PK4=14	1× flat head screw 1× paralleling tool 1× parallel retainer adapter	Set

4, 5) 506G21 Grub screw

Technical data

Article number	Quantity unit
506G21=M4X12	Piece

Spare parts for 17PK1=L/R20-WR

3

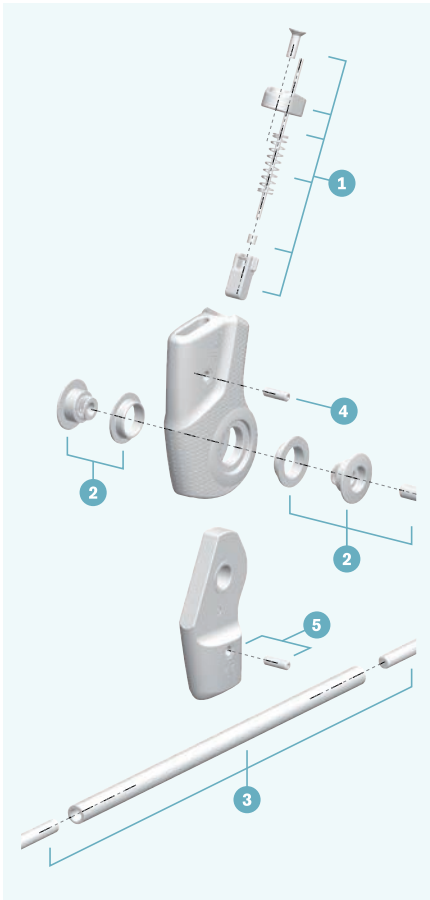

1) 29PK1 Service set

Technical data

Article number	Scope of delivery	Quantity unit
29PK1	21A18=2 513D52=1 21A12 30Y206 30Y207 501S146=4.0X12	Set

2) 29PK2 Service Set

Technical data

Article number	Scope of delivery	Quantity unit
29PK2	501T39=M6X18 509G10=14X16X5 30Y209 30Y210	Set

3) 29PK4 Adjustment aid

Technical data

Article number	Scope of delivery	Quantity unit
29PK4	1× cap screw 1× paralleling tool	Set

4, 5) 506G3 Set screw

Technical data

Article number	Quantity unit
506G3=M4X12	Piece

Fax order form for *Aqualine* orthosis system.

Page 1/1

Contact person

Customer no.

Date

Customer

Company

Street

Postal code City

Email

Commision

Shipping address (if different from customer address)

Company

Street

Postal code City

Email

Components for modular design	Quantity	Designation	Article number	Delivery unit
		Loop strap	170Z4= ● 600-7 ● 400-7	600 mm / piece 400 mm / piece
		Self-adhesive loop strap	623Z7=20-6-SA3	1 m
		Y-hook-and-loop	170D21=38-7	Piece
	1	Aluminium bar	605P8=20 605P8=14	2 m bar profile 1 m bar profile
		Sintering powder	618T40=S	4 kg
	2	Waterproof CarbonIQ knee joints	17PK1= ● L20-WR ● R20-WR ● L14-WR ● R14-WR	Pair
	3	Antibacterial ThermoLyn® (PPH)	616T420= ● 5mm thick ● 6mm thick	2 x 1 m sheet
		Flat head screw	501S84=M4x8	Piece
	4	Waterproof CarbonIQ ankle joints	17PA1= ● 20-WR ● 14-WR	Pair
	5	Foot stirrup	17PF1 (for size =20) 17PF1=14	Pair
		Non-skid sole	29F18= ● left ● 37-40 ● right ● 40-43 ● 43-46	Piece
		Ottobock special adhesive	636W18 636W19	Piece

Date Place Signature



7U56 Polycentric knee joint bars with gear drive

Joints with interchangeable stops to limit extension as well as flexion, concave half-round bar profile, joint bars of thermoplastic synthetic material, forming temperature of 150 °C/302 °F



Technical data

Article number	Length from joint centre upper	Posterior offset	Bar width	Bar thickness	Colour	Quantity unit
7U56=S	270 mm	16 mm	25 mm	5.5 mm	Black	Pair

Practical recommendation

- The 743Y56=1 size 1 alignment insert is aligned with the compromise pivot point in order to align the orthotic knee joints with the compromise pivot point according to Nietert. The compromise pivot point of the polycentric gear drive joints is therefore centred between the two joint screws.

Spare parts for 7U56

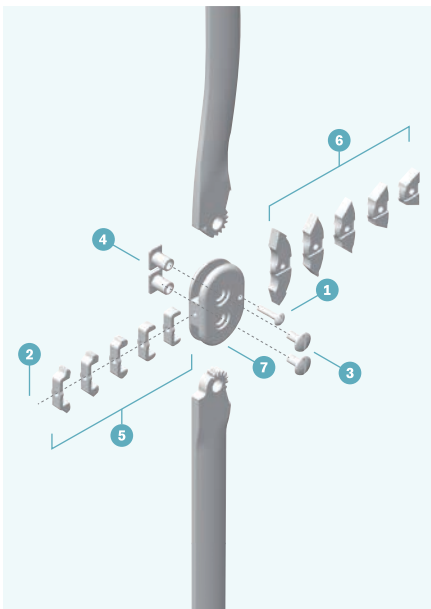

1) 501A11 Oval head screw, slotted and partially threaded

Technical data

Article number	Thread	Shoulder Ø	Head Ø	Material	Quantity unit
501A11=8X3.5XM3.5	M3.5	3.5 mm	8 mm	Stainless steel	Piece

2) 501B5 Slotted sheet metal cap screw

Technical data

Article number	Quantity unit
501B5=3.5X9.5	Piece

3) 501S32 Slotted truss head screw

Technical data

Article number	Head Ø	Length	Thread	Material	Quantity unit
501S32=M5X12X13	12 mm	13 mm	M5	Stainless steel	Piece

4) 17Y67 Bearing nut

Technical data

Article number	Material	Quantity unit
17Y67	Plastic	Piece

5) 17Y74 Extension stop

Technical data

Article number	Range	Material	Colour	Quantity unit
17Y74=6	6 °	Plastic	White	Piece
17Y74=10	10 °	Plastic	Green	Piece
17Y74=20	20 °	Plastic	Yellow	Piece
17Y74=30	30 °	Plastic	Red	Piece
17Y74=40	40 °	Plastic	Brown	Piece

- The colour white is the factory standard

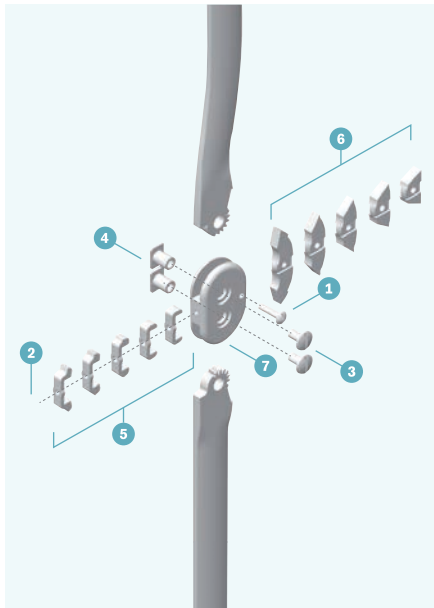

6) 17Y78 Flexion stop

Technical data

Article number	Range	Material	Colour	Quantity unit
17Y78=0	0 °	Plastic	Blue	Piece
17Y78=40	40 °	Plastic	Brown	Piece
17Y78=60	60 °	Plastic	Red	Piece
17Y78=80	80 °	Plastic	Yellow	Piece
17Y78=100	100 °	Plastic	Green	Piece

· The colour brown is the factory standard

7) 17Y63 Joint centre piece

Technical data

Article number	Colour	Quantity unit
17Y63=52-S	Black	Piece



17K43 Polycentric knee joint bars

With gear drive, free motion joints, concave half-round bar profile, interchangeable stops to limit extension



Technical data

Article number	Length from joint centre upper	Length from joint centre lower	Posterior offset	Bar width	Bar thickness	Joint thickness	Material	Quantity unit
17K43	340 mm	300 mm	16 mm	21 mm	2 mm	6 mm	Stainless steel	Pair

i Practical recommendation

- The 743Y56=1 size 1 alignment insert is aligned with the compromise pivot point in order to align the orthotic knee joints with the compromise pivot point according to Nietert. The compromise pivot point of the polycentric gear drive joints is therefore centred between the two joint screws.

Spare parts for 17K43

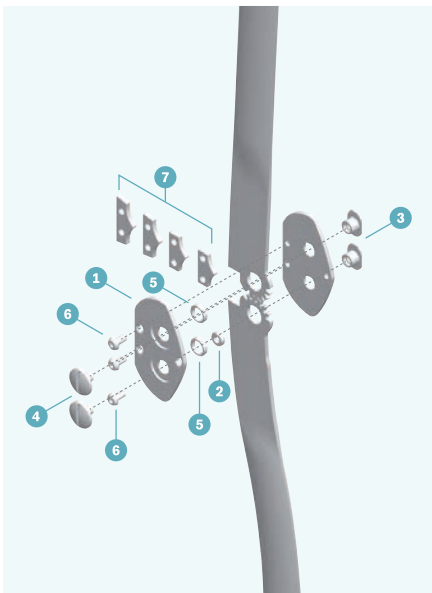

1) 17Y127 Joint centre piece

Technical data

Reference number	Quantity unit
17Y127	Piece

2) 17Y17 Brass bushing

Technical data

Article number	Material	Quantity unit
17Y17=3.1X6X2.1	Brass	Piece
17Y17=6X8X2	Brass	Piece

3) 17Y93 Bearing nut, hardened

Technical data

Article number	Spare part for	Insertion length	Profile length	Shank length	Thread	Shoulder Ø	Quantity unit
17Y93=6X5XM4	17K43 17K45 17K46 17K47	4.1 mm	12 mm	5 mm	M4	6 mm	Piece

4) 501S32 Slotted truss head screw

Technical data

Article number	Head Ø	Length	Thread	Material	Quantity unit
501S32=M4X12X8	12 mm	8 mm	M4	Stainless steel	Piece

5) 501S42 Oval head screw

Technical data

Article number
501S42=M6X18

6) 17Y90 Extension stop

Technical data

Article number	Range	Material	Quantity unit
17Y90=6	6 °	Stainless steel	Piece
17Y90=10	10 °	Stainless steel	Piece
17Y90=20	20 °	Stainless steel	Piece
17Y90=30	30 °	Stainless steel	Piece

· The 6° extension angle is the factory standard



17K45 Polycentric knee joint bars

With gear drive, joints with interchangeable stops to limit extension as well as flexion, concave half-round bar profile



Technical data

Article number	Length from joint centre upper	Length from joint centre lower	Posterior offset	Bar width	Bar thickness	Joint thickness	Material	Quantity unit
17K45	340 mm	300 mm	16 mm	21 mm	2 mm	6 mm	Stainless steel	Pair

i Practical recommendation

- The 743Y56=1 size 1 alignment insert is aligned with the compromise pivot point in order to align the orthotic knee joints with the compromise pivot point according to Nietert. The compromise pivot point of the polycentric gear drive joints is therefore centred between the two joint screws.

Spare parts for 17K45

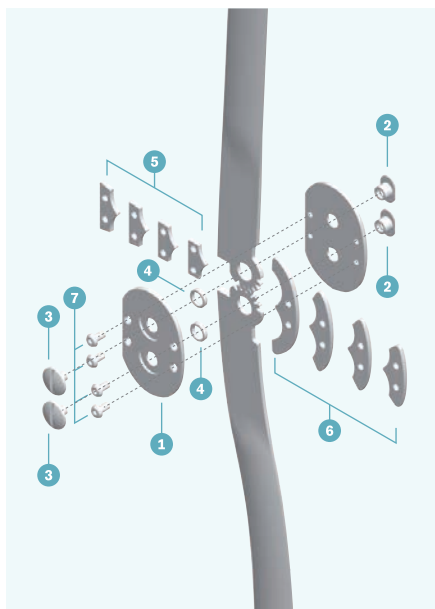

1) 17Y92 Joint centre piece

Technical data

Reference number	Quantity unit
17Y92	Piece

2) 17Y93 Bearing nut, hardened

Technical data

Article number	Spare part for	Insertion length	Profile length	Shank length	Thread	Shoulder Ø	Quantity unit
17Y93=6X5XM4	17K43 17K45 17K46 17K47	4,1 mm	12 mm	5 mm	M4	6 mm	Piece

3) 501S32 Slotted truss head screw

Technical data

Article number	Head Ø	Material	Quantity unit
501S32=M4X12X8	12 mm	Stainless steel	Piece

4) 17Y17 Bushing

Technical data

Article number	Quantity unit
17Y17=6X8X2	Piece

5) 17Y90 Extension stop

Technical data

Article number	Range	Material	Quantity unit
17Y90=6	6 °	Stainless steel	Piece
17Y90=10	10 °	Stainless steel	Piece
17Y90=20	20 °	Stainless steel	Piece
17Y90=30	30 °	Stainless steel	Piece

- The 6° extension angle is the factory standard

6) 17Y91 Flexion stop

Technical data

Article number	Range	Material	Quantity unit
17Y91=0	0 °	Stainless steel	Piece
17Y91=60	60	Stainless steel	Piece
17Y91=80	80 °	Stainless steel	Piece
17Y91=100	100 °	Stainless steel	Piece

· The 100° flexion angle is the factory standard

7) 501S42 Oval head screw

Technical data

Article number
501S42=M6X18



17K46 Polycentric knee joint bars, short

With gear drive, joints with interchangeable stops to limit extension as well as flexion, upper and lower bars are curved and notched, for embedding into laminates and thermo-plastic synthetic materials



Technical data

Article number	Length from joint centre upper	Length from joint centre lower	Posterior offset	Bar width	Bar thickness	Joint thickness	Material	Quantity unit
17K46	340 mm	300 mm	16 mm	21 mm	2 mm	6 mm	Stainless steel	Pair

Practical recommendation

- The 743Y56=1 size 1 alignment insert is aligned with the compromise pivot point in order to align the orthotic knee joints with the compromise pivot point according to Nietert. The compromise pivot point of the polycentric gear drive joints is therefore centred between the two joint screws.

Spare parts for 17K46

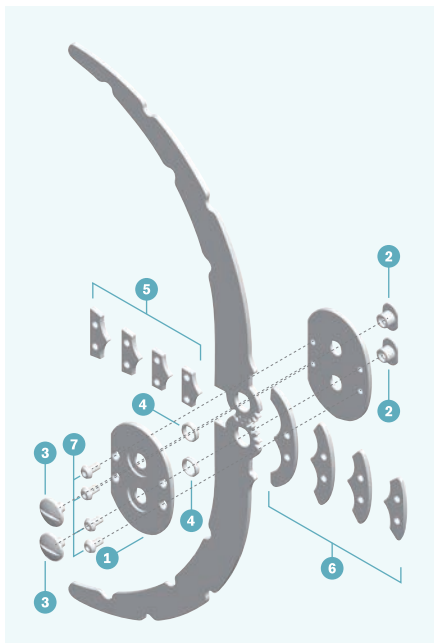

1) 17Y92 Joint centre piece

Technical data

Reference number	Quantity unit
17Y92	Piece

2) 17Y93 Bearing nut, hardened

Technical data

Article number	Spare part for	Insertion length	Profile length	Shank length	Thread	Shoulder Ø	Quantity unit
17Y93=6X5XM4	17K46	4.1 mm	12 mm	5 mm	M4	6 mm	Piece

3) 501S32 Slotted truss head screw

Technical data

Article number	Head Ø	Material	Quantity unit
501S32=M4X12X8	12 mm	Stainless steel	Piece

4) 17Y17 Bushing

Technical data

Article number	Quantity unit
17Y17=6X8X2	Piece

5) 17Y90 Extension stop

Technical data

Article number	Range	Material	Quantity unit
17Y90=6	6 °	Stainless steel	Piece
17Y90=10	10 °	Stainless steel	Piece
17Y90=20	20 °	Stainless steel	Piece
17Y90=30	30 °	Stainless steel	Piece

- The 6° extension angle is the factory standard

6) 17Y91 Flexion stop

Technical data

Article number	Range	Material	Quantity unit
17Y91=0	0 °	Stainless steel	Piece
17Y91=60	60	Stainless steel	Piece
17Y91=80	80 °	Stainless steel	Piece
17Y91=100	100 °	Stainless steel	Piece

· The 100° flexion angle is the factory standard

7) 501S42 Oval head screw

Technical data

Article number
501S42=M6X18



17K47 Polycentric knee joint bars, short

With gear drive, free motion joints, upper and lower bars are curved and notched, for embedding into laminate and thermoplastic synthetic materials, interchangeable stops to limit extension



Technical data

Article number	Length from joint centre upper	Length from joint centre lower	Posterior offset	Bar width	Bar thickness	Joint thickness	Material	Quantity unit
17K47	340 mm	300 mm	16 mm	21 mm	2 mm	6 mm	Stainless steel	Pair

Practical recommendation

- The 743Y56=1 size 1 alignment insert is aligned with the compromise pivot point in order to align the orthotic knee joints with the compromise pivot point according to Nietert. The compromise pivot point of the polycentric gear drive joints is therefore centred between the two joint screws.

Spare parts for 17K47

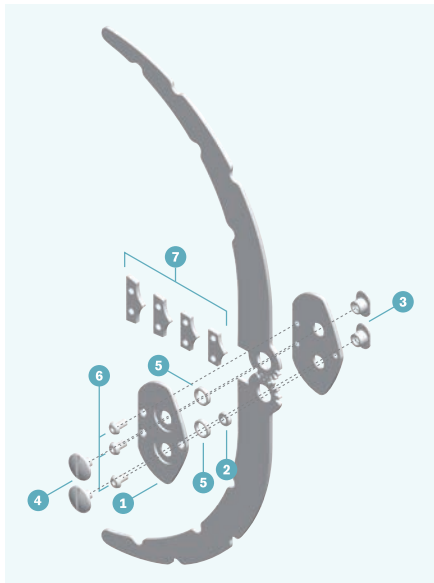

1) 17Y127 Joint centre piece

Technical data

Reference number	Quantity unit
17Y127	Piece

2) 17Y17 Brass bushing

Technical data

Article number	Material	Quantity unit
17Y17=3.1X6X2.1	Brass	Piece
17Y17=6X8X2	Brass	Piece

3) 17Y93 Bearing nut, hardened

Technical data

Article number	Spare part for	Insertion length	Profile length	Shank length	Thread	Shoulder Ø	Quantity unit
17Y93=6X5XM4	17K43 17K45 17K46 17K47	4.1 mm	12 mm	5 mm	M4	6 mm	Piece

4) 501S32 Slotted truss head screw

Technical data

Article number	Head Ø	Material	Quantity unit
501S32=M4X12X8	12 mm	Stainless steel	Piece

6) 501S42 Oval head screw

Technical data

Article number
501S42=M6X18

7) 17Y90 Extension stop

Technical data

Article number	Range	Material	Quantity unit
17Y90=6	6 °	Stainless steel	Piece
17Y90=10	10 °	Stainless steel	Piece
17Y90=20	20 °	Stainless steel	Piece
17Y90=30	30 °	Stainless steel	Piece

- The 6° extension angle is the factory standard



7U30 Lower leg joint bars, light duty

Joints with ball bearing, concave half-round bar profile, forged upper and lower joint bars

The head of the inner joint bar is offset to the outside, the head of the outer joint bar to the inside

Technical data

Article number	Side	Milled head	Upper section length	Lower section length	Bar width	Bar thickness	Material	Quantity unit
7U30=L	left (L)	24x4 mm	340 mm	150 mm	20 mm	2.3 mm	Stainless steel	Pair
7U30=R	right (R)	24x4 mm	340 mm	150 mm	20 mm	2.3 mm	Stainless steel	Pair



7U33 Lower leg joint bars, light duty

Joints with ball bearing, concave half-round bar profile, forged upper and lower joint bars

Similar to 7U30 design, but with heads of both bars offset outside

Technical data

Article number	Milled head	Upper section length	Lower section length	Bar width	Bar thickness	Material	Quantity unit
7U33	24x4 mm	340 mm	150 mm	20 mm	2.3 mm	Stainless steel	Pair

Spare parts for 7U30, 7U33

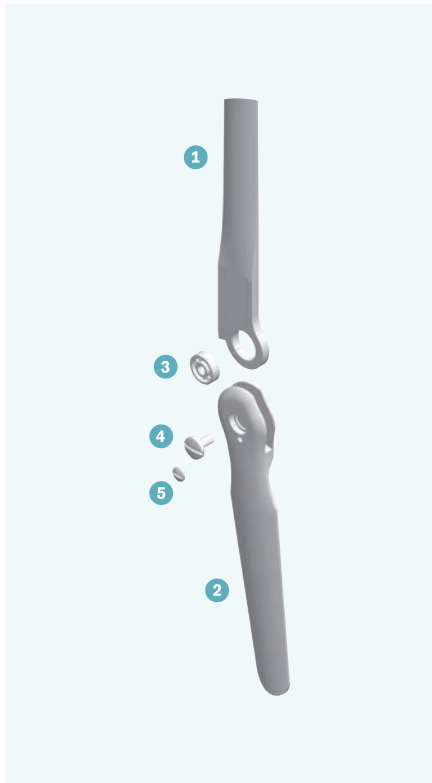

1) 7A5 Knee joint bar upper part

Technical data

Article number	Spare part for	Material	Quantity unit
7A5=L	7U30=R 7U30=L 7U33	Stainless steel	Piece
7A5=R	7U30=L 7U30=R 7U33	Stainless steel	Piece

2) 7B5 Leg joint bar, lower section

Technical data

Article number	Spare part for	Material	Quantity unit
7B5=LA	7U30=L	Stainless steel	Piece
7B5=LI	7U30=L 7U33	Stainless steel	Piece
7B5=RA	7U30=R	Stainless steel	Piece
7B5=RI	7U30=R	Stainless steel	Piece

3) 509K11 Ball bearing

Technical data

Article number	Quantity unit
509K11=5X16X4	Piece

4) 501A6 Oval head screw, slotted and partially threaded

Technical data

Article number	Material	Quantity unit
501A6=4X5XM5	Stainless steel	Piece

5) 501S22 Lock screw

Technical data

Article number	Spare part for	Material	Quantity unit
501S22=8XM3.5	7U33	Stainless steel	Piece



7U32 Lower leg joint bars, light duty

Joints with ball bearing, joint centre shifted in the posterior direction, concave half-round bar profile, forged upper and lower joint bars

The head of the inner joint bar is offset to the outside, the head of the outer joint bar to the inside

Technical data

Article number	Side	Milled head	Upper section length	Lower section length	Bar width	Bar thickness	Material	Quantity unit
7U32=L	left (L)	24x4 mm	340 mm	150 mm	20 mm	2.3 mm	Stainless steel	Pair
7U32=R	right (R)	24x4 mm	340 mm	150 mm	20 mm	2.3 mm	Stainless steel	Pair



7U42 Lower leg joint bars, light duty

Joints with ball bearing, joint centre shifted in the posterior direction, concave half-round bar profile, forged upper and lower joint bars

Similar to 7U32 design, but with heads of both bars offset outside

Technical data

Article number	Milled head	Upper section length	Lower section length	Bar width	Bar thickness	Material	Quantity unit
7U42	24x4 mm	340 mm	150 mm	20 mm	2.3 mm	Stainless steel	Pair

Spare parts for 7U32, 7U42

3

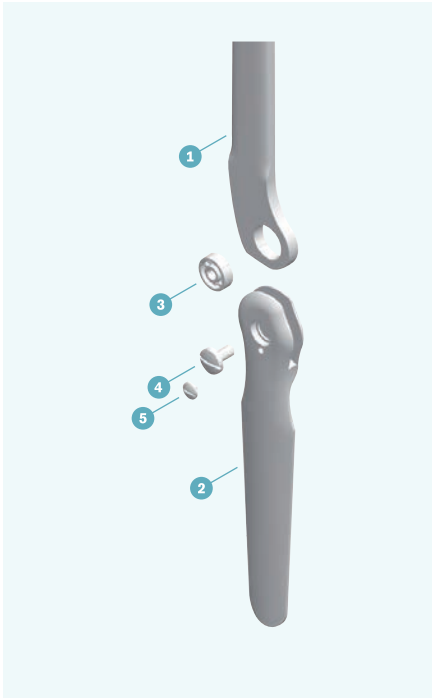

1) 7A6 Leg joint bar, upper section

Technical data

Article number	Spare part for	Material	Quantity unit
7A6=L	7U32=L 7U42	Stainless steel	Piece
7A6=R	7U32=R 7U42	Stainless steel	Piece

2) 7B5 Leg joint bar, lower section

Technical data

Article number	Spare part for	Material	Quantity unit
7B5=LA	7U32=L	Stainless steel	Piece
7B5=LI	7U32=L 7U42	Stainless steel	Piece
7B5=RA	7U32=R	Stainless steel	Piece
7B5=RI	7U32=R 7U42	Stainless steel	Piece

3) 509K11 Ball bearing

Technical data

Article number	Quantity unit
509K11=5X16X4	Piece

4) 501A6 Oval head screw, slotted and partially threaded

Technical data

Article number	Material	Quantity unit
501A6=4X5XM5	Stainless steel	Piece

5) 501S22 Lock screw

Technical data

Article number	Spare part for	Material	Quantity unit
501S22=8XM3.5	7U32=L 7U32=R 7U42	Stainless steel	Piece



7U43 Lower leg joint bars, light duty

Joint with ball bearing, concave half-round bar profile, forged upper and lower joint bar sections

Heads of inner and outer joint bars are offset outside

Technical data

Article number	Milled head	Upper section length	Lower section length	Bar width	Bar thickness	Material	Quantity unit
7U43	24x5 mm	410 mm	150 mm	22 mm	2.5 mm	Orthopaedic steel	Pair

Spare parts for 7U43



1) 7A3 Leg joint bar, upper section

Technical data

Article number	Spare part for	Material	Quantity unit
7A3=L	7U43	Orthopaedic steel	Piece
7A3=R	7U43	Orthopaedic steel	Piece

2) 7B4 Knee joint bar lower part

Technical data

Article number	Spare part for	Material	Quantity unit
7B4=LI	7U43	Orthopaedic steel	Piece
7B4=RI	7U43	Orthopaedic steel	Piece

3) 509K11 Ball bearing

Technical data

Article number	Spare part for	Quantity unit
509K11=5X16X5	7U43	Piece

4) 501A25 Slotted oval head screw, partially threaded (ball bearing screw)

Technical data

Article number	Quantity unit
501A25	Piece

5) 501S22 Lock screw

Technical data

Article number	Spare part for	Material	Quantity unit
501S22=8XM3.5	7U43	Stainless steel	Piece



7U46 Lower leg joint bars, light duty

Joints with ball bearing, joint centre shifted in the posterior direction, centred joint head, concave half-round bar profile, forged upper and lower joint bars, for swimming prostheses

Technical data

Article number	Milled head	Upper section length	Lower section length	Bar width	Bar thickness	Material	Quantity unit
7U46	18x4 mm	270 mm	125 mm	20 mm	1.75 mm	Stainless steel	Pair

Spare parts for 7U46

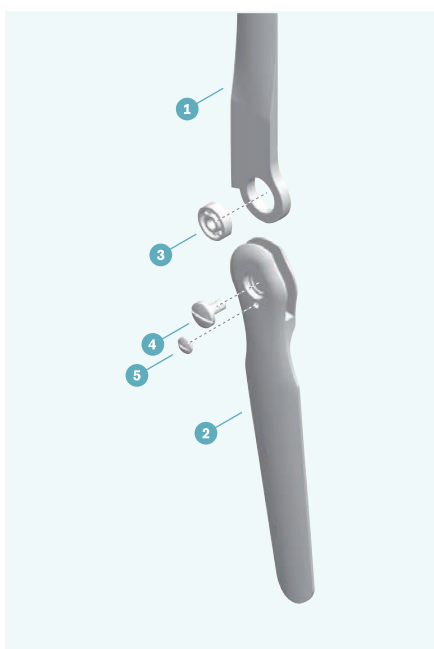

1) 7A14 Leg joint bar, upper section

Technical data

Article number	Spare part for	Material	Quantity unit
7A14=L	7U46	Stainless steel	Piece
7A14=R	7U46	Stainless steel	Piece

2) 7B7 Knee joint bar lower part

Technical data

Article number	Spare part for	Material	Quantity unit
7B7=L	7U46	Stainless steel	Piece
7B7=R	7U46	Stainless steel	Piece

3) 509K15 Ball bearing

Technical data

Reference number	Spare part for
509K15	7U46

4) 501A12 Shoulder screw

Technical data

Article number	Material	Quantity unit
501A12=2	Stainless steel	Piece

5) 501S22 Lock screw

Technical data

Article number	Spare part for	Material	Quantity unit
501S22=6XM3	7U46	Stainless steel	Piece



7U27 Lower leg joint bars, light duty

Joints with gear drive and bushing, centred joint head, concave half-round bar profile, forged upper and lower joint bars

Technical data

Article number	Length from joint centre upper	Length from joint centre lower	Posterior offset	Bar width	Bar thickness	Material	Quantity unit
7U27	340 mm	150 mm	18 mm	20 mm	3 mm	Stainless steel	Pair

Spare parts for 7U27

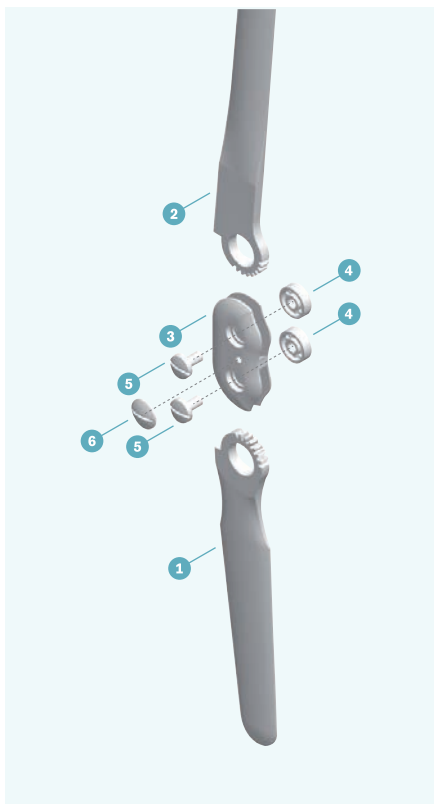

1) 7B10 Leg joint bar, lower section

Technical data

Article number	Spare part for	Material	Quantity unit
7B10=L	7U27	Stainless steel	Piece
7B10=R	7U27	Stainless steel	Piece

2) 7A10 Leg joint bar, upper section

Technical data

Article number	Spare part for	Material	Quantity unit
7A10=L	7U27	Stainless steel	Piece
7A10=R	7U27	Stainless steel	Piece

3) 7Y13 Joint piece

Technical data

Article number	Material	Quantity unit
7Y13	Stainless steel	Piece

4) 501A32 Joint screw

Technical data

Article number	Quantity unit
501A32	Piece

5) 501S22 Lock screw

Technical data

Article number	Spare part for	Material	Quantity unit
501S22=8XM3.5	7U27	Stainless steel	Piece



7U2 Lower leg joint bars, medium duty

Joints with ball bearing, medial joint head offset to the outside, lateral joint head offset to the inside, concave half-round bar profile, forged upper and lower joint bars

Technical data

Article number	Side	Upper section length	Lower section length	Bar width	Bar thickness	Material	Quantity unit
7U2=L	left (L)	410 mm	150 mm	24 mm	3 mm	Orthopaedic steel	Pair
7U2=R	right (R)	410 mm	150 mm	24 mm	3 mm	Orthopaedic steel	Pair

Spare parts for 7U2

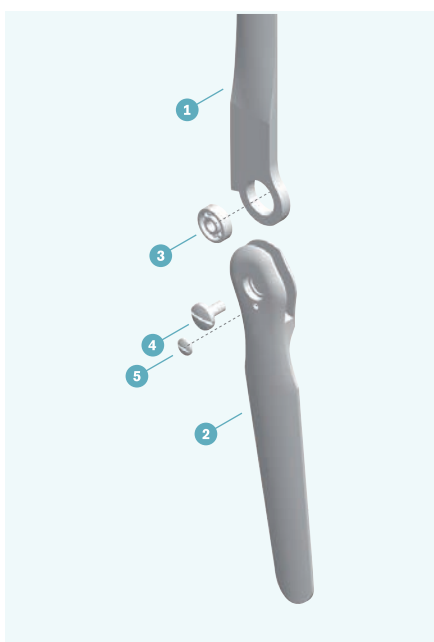

1) 7A1 Knee joint bar upper part

Technical data

Article number	Spare part for	Material	Quantity unit
7A1=L	7U2=L 7U2=R	Orthopaedic steel	Piece
7A1=R	7U2=L 7U2=R	Orthopaedic steel	Piece

2) 7B3 Knee joint bar lower part

Technical data

Article number	Spare part for	Material	Quantity unit
7B3=LA	7U2=L	Orthopaedic steel	Piece
7B3=LI	7U2=L	Orthopaedic steel	Piece
7B3=RA	7U2=R	Orthopaedic steel	Piece
7B3=RI	7U2=R	Orthopaedic steel	Piece

3) 509K11 Ball bearing

Technical data

Article number	Spare part for	Quantity unit
509K11=5X16X5	7U2=L 7U2=R	Piece

4) 501A25 Slotted oval head screw, partially threaded (ball bearing screw)

Technical data

Article number	Quantity unit
501A25	Piece

5) 501S22 Lock screw

Technical data

Article number	Spare part for	Material	Quantity unit
501S22=8XM3.5	7U2=L 7U2=R	Stainless steel	Piece



7U15 Lower leg joint bars, medium duty

Joints with ball bearing, joint centre placed to the posterior, concave half-round bar profile, forged nickel-plated upper and lower joint bar sections

The head of the inner joint bar is offset to the outside, the head of the outer joint bar to the inside

Technical data

Article number	Side	Milled head	Upper section length	Lower section length	Bar width	Bar thickness	Quantity unit
7U15=L	left	26x5 mm	410 mm	150 mm	24 mm	3 mm	Pair
7U15=R	right	26x5 mm	410 mm	150 mm	24 mm	3 mm	Pair



7U15 Lower leg joint bars, medium duty

Joints with ball bearing, joint centre placed to the posterior, concave half-round bar profile, forged nickel-plated upper and lower joint bar sections

Similar to 7U15 version, but with heads of both bars offset inside

Technical data

Article number	Milled head	Upper section length	Lower section length	Bar width	Bar thickness	Quantity unit
7U15=K	26x5 mm	410 mm	150 mm	24 mm	3 mm	Pair



7U25 Lower leg joint bars, medium duty

Joints with ball bearing, joint centre placed to the posterior, concave half-round bar profile, forged nickel-plated upper and lower joint bar sections

Similar to 7U15 design, but with heads of both bars offset outside

Technical data

Article number	Milled head	Upper section length	Lower section length	Bar width	Bar thickness	Quantity unit
7U25	26 x 5 mm	410 mm	150 mm	24 mm	3 mm	Pair

Spare parts for 7U15, 7U25

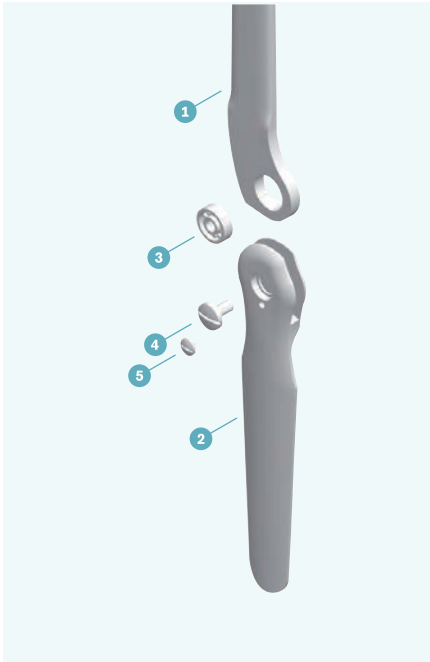

1) 7A11 Leg joint bar, upper section, nickel-plated

Technical data

Article number	Spare part for	Quantity unit
7A11=L	7U15=L 7U15=R 7U15=K 7U25	Piece
7A11=R	7U15=L 7U15=R 7U15=K 7U25	Piece

2) 7B13 Leg joint bar, lower section, nickel-plated

Technical data

Article number	Spare part for	Quantity unit
7B13=LA	7U15=L 7U15=K	Piece
7B13=LI	7U15=L 7U25	Piece
7B13=RA	7U15=R 7U15=K	Piece
7B13=RI	7U15=R 7U25	Piece

3) 509K11 Ball bearing

Technical data

Article number	Spare part for	Quantity unit
509K11=5X16X5	7U15=L 7U15=R 7U15=K 7U25	Piece

4) 501A22 Slotted oval head screw, partially threaded

Technical data

Article number	Quantity unit
501A22	Piece

5) 501S6 Lock screw

Technical data

Article number
501S6=8XM3.5



7U10 Lower leg joint bars, medium duty

Joints with gear drive and ball bearings, centred joint head, concave half-round bar profile, forged upper and lower joint bars

Technical data

Article number	Length from joint centre upper	Length from joint centre lower	Posterior offset	Bar thickness	Material
7U10	410 mm	130 mm	24 mm	3 mm	Orthopaedic steel

Spare parts for 7U10

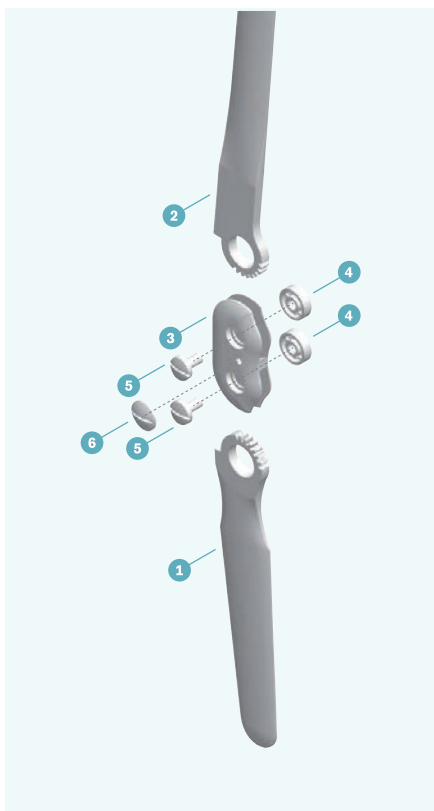

1) 7B8 Leg joint bar, lower section

Technical data

Article number	Spare part for	Quantity unit
7B8=L	7U10	Piece
7B8=R	7U10	Piece

2) 7A9 Leg joint bar, upper section

Technical data

Article number	Spare part for	Quantity unit
7A9=L	7U10	Piece
7A9=R	7U10	Piece

3) 7Y12 Joint piece

Technical data

Article number	Quantity unit
7Y12	Piece

4) 509K11 Ball bearing

Technical data

Article number	Spare part for	Quantity unit
509K11=5X16X5	7U10	Piece

5) 501A24 Slotted flat head screw, partially threaded

Technical data

Article number	Spare part for	Quantity unit
501A24	7U10	Piece

6) 501S10 Slotted oval head screw, nickel-plated lock screw

Technical data

Article number	Quantity unit
501S10	Piece



7G3 Thigh bars

Joints with ball bearings, both joint heads offset outside, concave half-round bar profile, forged nickel-plated upper and lower joint bars

Technical data

Article number	Milled head	Length from joint centre upper	Length from joint centre lower	Bar width	Bar thickness	Quantity unit
7G3	26 x 5 mm	410 mm	150 mm	24 mm	3 mm	Pair

3

Spare parts for 7G3

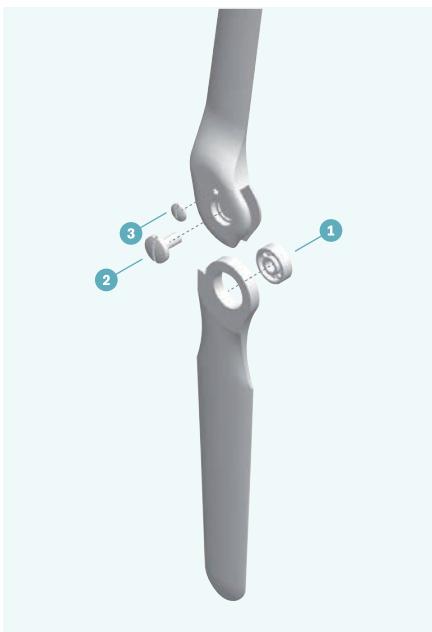

1) 509K11 Ball bearing

Technical data

Article number	Spare part for	Quantity unit
509K11=5X16X5	7G3	Piece

2) 501A22 Slotted oval head screw, partially threaded

Technical data

Article number	Quantity unit
501A22	Piece

3) 501S6 Lock screw

Technical data

Article number
501S6=8XM3.5



HKAFO/HO.

All hip joint systems, classic components for hip rotation orthoses and reciprocal systems as well as hip abduction orthoses are presented in this section.



28L100 Cosa Junior

The Cosa Active/Junior hip abduction orthosis uses pads between the legs to reduce the scissor gait which occurs in various forms of infantile cerebral palsy. Reducing hip adduction improves the overall gait pattern and control of the trunk in addition to stabilising the basis for standing and sitting.

The Cosa Active/Junior is generally delivered in a 28L101=* / 28L100=* starter set. It contains 2 pairs of 29L101=* / 29L100=* pants to change and wash and 1 29L102=* pad set.

Benefits

- Minimisation of scissor gait enhances mobility (more freedom for knee, improved gait pattern)
- Improved torso control
- More stable base for sitting and standing
- Can be combined with additional orthoses
- Can be worn day and night
- Easy to customise
- Easy care, machine washable (in a laundry bag) at 40 °C
- High level of wearer comfort

Indications

- Diparesis
- Hip dysplasia
- Hip joint subluxation, congenital
- Hypotonicity
- Tetraparesis

Contraindications

- Hip joint dislocation



Technical data

Article number	Standard sizing	Body height	Hip circumference	Pad number	Thigh circumference
28L100=80	80	74-86 cm	57-59 cm	1	26-32 cm
28L100=92	92	86-98 cm	59-62 cm	1	26-32 cm
28L100=104	125	98-110 cm	62-64 cm	2	32-36 cm
28L100=116	116	110-122 cm	64-68 cm	2	32-36 cm



28L101 Cosa Active

The Cosa Active/Junior hip abduction orthosis uses pads between the legs to reduce the scissor gait which occurs in various forms of infantile cerebral palsy. Reducing hip adduction improves the overall gait pattern and control of the trunk in addition to stabilising the basis for standing and sitting.

The Cosa Active/Junior is generally delivered in a 28L101=*/28L100=* starter set. It contains 2 pairs of 29L101=*/29L100=* pants to change and wash and 1 29L102=* pad set.

Benefits

- Minimisation of scissor gait enhances mobility (more freedom for knee, improved gait pattern)
- Easy to customise
- Easy care, machine washable (in a laundry bag) at 40 °C
- High level of wearer comfort
- More stable base for sitting and standing
- Can be worn day and night
- Improved torso control

Indications

- Diparesis
- Hip dysplasia
- Hip joint subluxation, congenital
- Hypotonicity
- Tetraparesis

Contraindications

- Hip joint dislocation



Technical data

Article number	Standard sizing	Body height	Hip circumference	Pad number	Thigh circumference
28L101=128	128	122-134 cm	68-72 cm	3	36-44 cm
28L101=140	140	134-146 cm	72-78 cm	3	36-44 cm
28L101=152	152	146-158 cm	78-86 cm	4	44-54 cm
28L101=S	164/ women 34-38/ men 42-46	158-170 cm	86-96 cm	4	44-54 cm
28L101=M	Women 40, 42/ men 48, 50	from 170 cm	96-105 cm	5	54-62 cm
28L101=L	Women 44, 46/ men 52, 54	from 170 cm	105-109 cm	5	54-62 cm

Spare parts for 28L100, 28L101



29L100 Cosa Junior shorts

Shorts as replacement for the 28L100 Cosa Junior



Technical data

Article number	for
29L100=80	Cosa Junior
29L100=92	Cosa Junior
29L100=104	Cosa Junior
29L100=116	Cosa Junior



29L101 Cosa Active shorts

Shorts as replacement for the 28L101 Cosa Active



Technical data

Article number	for
29L101=128	Cosa Active
29L101=140	Cosa Active
29L101=152	Cosa Active
29L101=M	Cosa Active
29L101=L	Cosa Active



29L102 Pad

Pads as replacement for the 28L100 Cosa Junior/ 28L101 Cosa Active

Technical data

Article number	for
29L102=1	Cosa Junior
29L102=2	Cosa Junior
29L102=3	Cosa Active
29L102=4	Cosa Active
29L102=5	Cosa Active

Fit Kit for 28L100, 28L101



28LT1 Cosa FIT KIT

The Cosa Active FIT KIT is used to determine the size of the shorts. The pads can also be used to check the proper functionality for a patient.



Technical data

Article number	Scope of delivery
28LT1	10 test shorts in 10 sizes 5 test pads in 5 sizes 4 suspender clips with connecting strap 1 carrier bag



17H100 RGO hip joint system

The connection between the knee joint bars and the pelvic module is especially important for fittings with reciprocating gait orthoses. Our RGO (reciprocating gait orthosis) hip joint system helps users achieve pelvic rotation that imitates physiological rotation during walking. Thanks to the development of a bi-axial joint construction, pelvic rotation of 15° is possible without having to change the walking direction. The result: less effort, more effective gait pattern.

Key features

- Easy to use due to modular connection between joint components
- Individual components can be replaced so the orthosis “grows” with the user
- A push-pull cable system transmits forces smoothly and requires zero maintenance
- Sitting joint lock release with pre-release of the locking mechanism; locking button for re-locking
- Integration of a customised pelvic module (thermoplastic or laminate materials)
- Easy disassembly and adjustment of the torso bars for hip flexion up to 10°
- Prefabricated lightweight alloy thigh bars with 0 mm, 5 mm or 10 mm offset available



Technical data

Article number	Max. body weight	Pelvic width	Age	Quantity unit
17H100=0	up to 65 kg	340 - 380 mm	9 years and up	Set
17H100=1	up to 65 kg	270 - 330 mm	9 years and up	Set
17H100=2	up to 34 kg	200 - 260 mm	4-8 years	Set

· Please note that the pelvic tube is not included in the scope of delivery and therefore has to be ordered separately.

Spare parts for 17H100

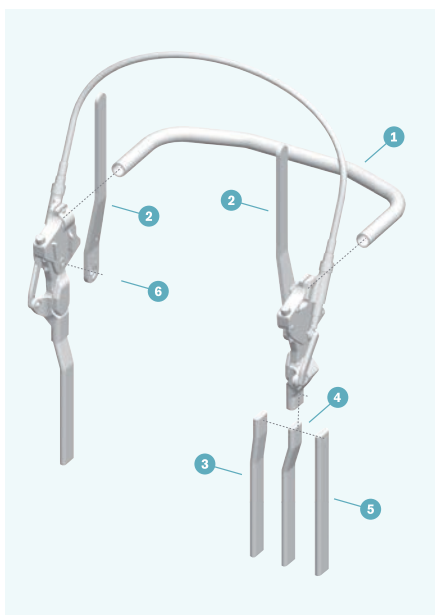

1) 17Y130 Pelvic tube

Technical data

Article number	Spare part for	Material	Quantity unit
17Y130=270	17H100=1	Aluminium	Piece
17Y130=280	17H100=1	Aluminium	Piece
17Y130=290	17H100=1	Aluminium	Piece
17Y130=320	17H100=1	Aluminium	Piece
17Y130=330	17H100=1	Aluminium	Piece
17Y130=340	17H100=1	Aluminium	Piece
17Y130=350	17H100=0	Aluminium	Piece
17Y130=360	17H100=0	Aluminium	Piece
17Y130=370	17H100=0	Aluminium	Piece
17Y130=380	17H100=0	Aluminium	Piece

1) 17Y140 Pelvic tube

Technical data

Article number	Spare part for	Material	Quantity unit
17Y140=200	17H100=2	Aluminium	Piece
17Y140=210	17H100=2	Aluminium	Piece
17Y140=220	17H100=2	Aluminium	Piece
17Y140=230	17H100=2	Aluminium	Piece
17Y140=240	17H100=2	Aluminium	Piece
17Y140=250	17H100=2	Aluminium	Piece
17Y140=260	17H100=2	Aluminium	Piece

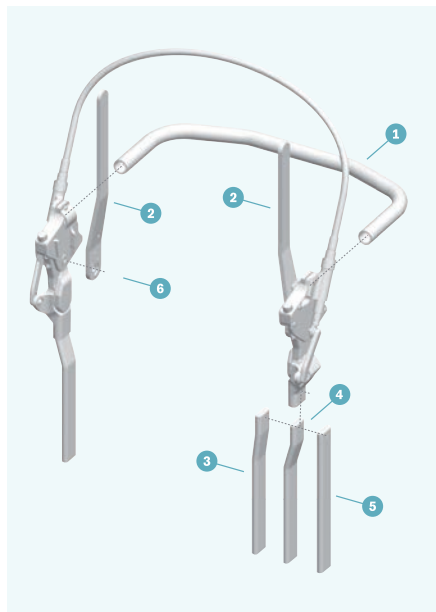

2) 17Y132 Torso bar

Technical data

Article number	Spare part for	Side	Material	Quantity unit
17Y132=L	17H100=0 17H100=1	left (L)	Aluminium	Piece
17Y132=R	17H100=0 17H100=1	right (R)	Aluminium	Piece

2) 17Y142 Torso bar

Technical data

Article number	Spare part for	Side	Material	Quantity unit
17Y142=L	17H100=2	left (L)	Aluminium	Piece
17Y142=R	17H100=2	right (R)	Aluminium	Piece

3, 4, 5) 17Y131 Thigh bar

Technical data

Article number	Spare part for	Frame offset	Material	Quantity unit
17Y131=0	17H100=0 17H100=1	0 mm	Aluminium	Piece
17Y131=5	17H100=0 17H100=1	5 mm	Aluminium	Piece
17Y131=10	17H100=0 17H100=1	10 mm	Aluminium	Piece

3, 4, 5) 17Y143 Thigh bar

Technical data

Article number	Spare part for	Frame offset	Material	Quantity unit
17Y143=0	17H100=2	0 mm	Aluminium	Piece
17Y143=5	17H100=2	5 mm	Aluminium	Piece
17Y143=10	17H100=2	10 mm	Aluminium	Piece

6) 501S32 Slotted truss head screw

Technical data

Article number	Spare part for	Thread	Length	Material	Quantity unit
501S32=M4X10X9.5	17H100=0 17H100=2 17H100=1	M4	9.5 mm	Stainless steel	Piece

Accessory for 17H100



616Z9 Shrinkable tubing

This plastic hose with rounded edges is suitable for covering products such as orthotic joints or bars, for example. It offers good insulation, good protection against corrosion and good resistance to liquids.

Technical data

Article number	Diameter	Length	Colour
616Z9=19X61	19 mm	50 m	Black
616Z9=25.4X30	25.4 mm	50 m	Black

RGO hip joint system. Order form.

Page 1/1

Contact person

Customer no.

Date

Customer

Company

Street

Postal code City

Email

Commision

Shipping address (if different from customer address)

Company

Street

Postal code City

Email

General information:

The *RGO hip joint system* is suitable for patients up to 65 kg. The system is available in three different versions. 17H100=2 for ages 4–8, up to a body weight of 34 kg. 17H100=1/0 for ages 9 and up, up to a body weight of 65 kg. Pelvic tubes are available in 1 cm increments for clear pelvic widths of 200 mm to 380 mm.

The pelvic width must be measured between the two trochanters in both the sitting and prone position. When selecting the pelvic tube, also take into account the wall thickness of the pelvic module to be fabricated including the padding!

Please check the desired combination!

Combination	17H100=2 up to 34 kg (75 lbs)	17H100=1 up to 65 kg (143.3 lbs)	17H100=0 up to 65 kg (143.3 lbs)
17Y140=200	●		
17Y140=210	●		
17Y140=220	●		
17Y140=230	●		
17Y140=240	●		
17Y140=250	●		
17Y140=260	●		
17Y130=270		●	
17Y130=280		●	
17Y130=290		●	
17Y130=300		●	
17Y130=310		●	
17Y130=320		●	
17Y130=330		●	
17Y130=340			●
17Y130=350			●
17Y130=360			●
17Y130=370			●
17Y130=380			●

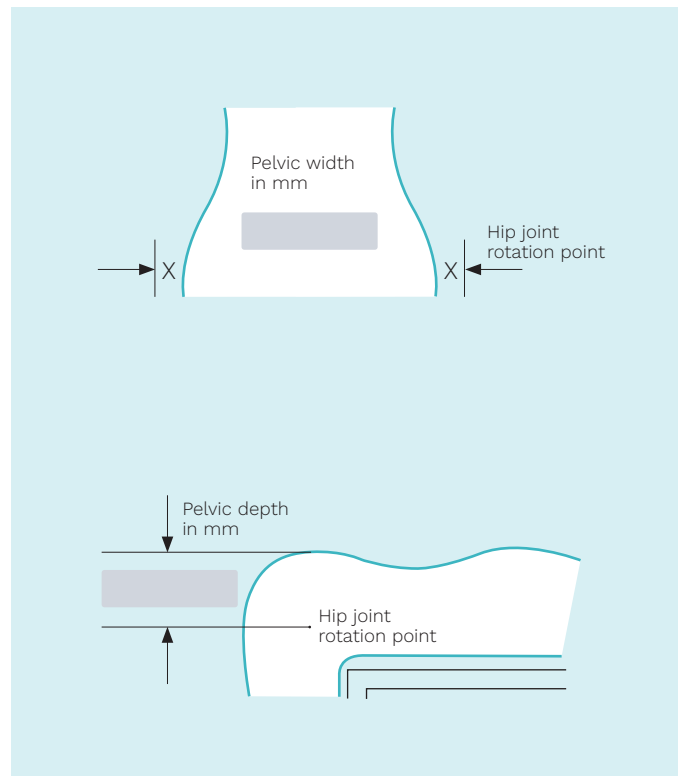

Date Place Signature



17H23 Hip joint bar

Free motion joint, without stop, with thrust needle bearing, flat bar profile, for rotation orthosis, Annastift model; hip rotation orthosis



Technical data

Article number	Side	Thick-ness	Milled head Ø	Upper/lower bar length	Bar width	Joint head Ø	Material
17H23=L	left (L)	2 mm	20 mm	75 / 450 mm	24 mm	30 mm	Stainless steel
17H23=R	right (R)	2 mm	20 mm	75 / 450 mm	24 mm	30 mm	Stainless steel

Spare parts for 17H23

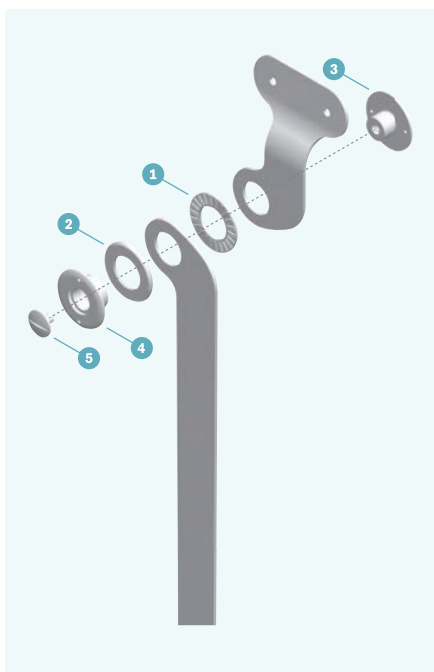

1) 509N3 Thrust needle bearing

Technical data

Article number	Quantity unit
509N3	Piece

2) 509N4 Retainer ring for thrust needle bearing

Technical data

Article number	Quantity unit
509N4	Piece

3) 17Z49 Two-hole screw

Technical data

Article number	Material	Quantity unit
17Z49	Stainless steel	Piece

4) 17Y50 Two-hole nut

Technical data

Article number	Material	Quantity unit
17Y50	Stainless steel	Piece

5) 501S47 Slotted oval head screw

Technical data

Article number
501S47



17HF1 Hip joint bar

Free motion hip joint



Technical data

Article number	Upper/lower bar length	Bar width top/bottom	Bar thickness top/bottom	Material	Quantity unit
17HF1=13-CS	300 / 195 mm	12.7 / 14.28 mm	4.75 / 4.75 mm	Steel	Pair
17HF1=16-CS	400 / 270 mm	15.87 / 19 mm	6.35 / 4.75 mm	Steel	Pair

Spare parts for 17HF1

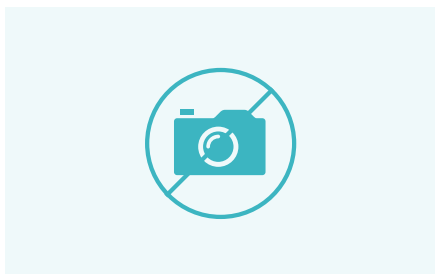

17KHS=3 Service set

Service set for size 13 (steel) 17KF1, 17KL6 and 17KL7 knee joints as well as the 17HF1, 17HL1, 17HL4 and 17HL5 hip joints

Technical data

Article number	Spare part for	Scope of delivery
17KHS=3	17HF1=13-CS	Bearing nut Bushing Flat round disk with slot Red washer Compression spring Truss head screw with slot Spring-loaded thrust piece



17KHS=2 Service set

Service set for size 16 (steel) 17KF1, 17KL6 and 17KL7 knee joints as well as the 17HF1, 17HL1 and 17HL4 hip joints

Technical data

Article number	Spare part for	Scope of delivery
17KHS=2	17HF1=16-CS	Bearing nut Bushing Flat round disk with slot Red washer Compression spring Truss head screw with slot Spring-loaded thrust piece

Accessory for 17HF1



743Y57 Alignment insert set

Alignment insert set for conventional orthotic joints

Technical data

Article number	Accessory for
743Y57	17HF1=13-CS 17HF1=16-CS

- The 743Y57 is a set consisting of the alignment inserts in sizes 5 through 9.



17B82 System hip joint

Contoured upper joint section, free motion, with ball bearing



Technical data

Article number	Side	System width	Milled head	Length from joint centre upper	Length from joint centre lower	Material	Quantity unit
17B82=L16	left (L)	16 mm	25x5 mm	44 mm	42 mm	Stainless steel	Piece
17B82=R16	right (R)	16 mm	25x5 mm	44 mm	42 mm	Stainless steel	Piece
17B82=L20	left (L)	20 mm	25x5 mm	44 mm	42 mm	Stainless steel	Piece
17B82=R20	right (R)	20 mm	25x5 mm	44 mm	42 mm	Stainless steel	Piece

Spare parts for 17B82

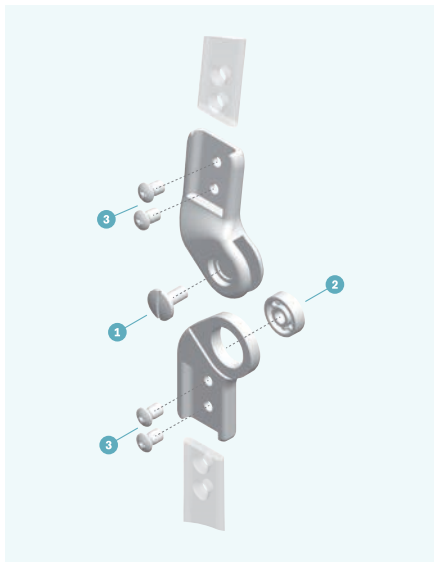

1) 501A6 Oval Head Screw -St.Steel-

Technical data

Article number	Material	Quantity unit
501A6=5X5XM5	Stainless steel	Piece

2) 509K11 Ball bearing

Technical data

Article number	Spare part for	Quantity unit
509K11=5X16X5	17B82=L16 17B82=R16 17B82=L20 17B82=R20	Piece

3) 501T7 Oval head screw, Phillips

Technical data

Article number	Spare part for	Length	Head Ø	Material	Quantity unit
501T7=7.5X9XM5	17B82=L16 17B82=R16 17B82=L20 17B82=R20	9 mm	7.5 mm	Stainless steel	Piece



17HL5 Hip joint bar with double lock

With double ring lock for locking at 90° and 180°, supplied in pairs, supports: • Locking for stable standing (180°) • Locking for stable sitting (90°)

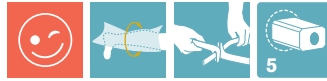

Technical data

Article number	Upper/lower bar length	Bar width top/ bottom	Bar thickness top/ bottom	Material	Quantity unit
17HL5=13-CS	300 / 250 mm	12.7 / 12.7 mm	4.76 / 4.76 mm	Steel	Pair

Spare parts for 17HL5

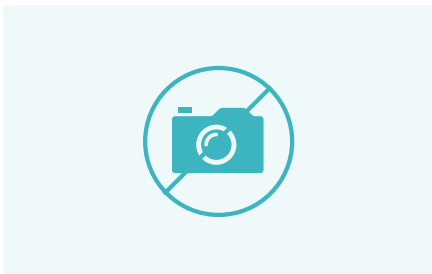

17KHS=3 Service set

Service set for size 13 (steel) 17KF1, 17KL6 and 17KL7 knee joints as well as the 17HF1, 17HL1, 17HL4 and 17HL5 hip joints

Technical data

Article number	Spare part for	Scope of delivery
17KHS=3	17HL5=13-CS	Bearing nut Bushing Flat round disk with slot Red washer Compression spring Truss head screw with slot Spring-loaded thrust piece

Accessory for 17HL5

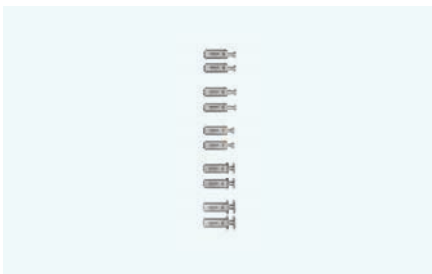

743Y57 Alignment insert set

Alignment insert set for conventional orthotic joints

Technical data

Article number	Accessory for
743Y57	17HL5=13-CS

· The 743Y57 is a set consisting of the alignment inserts in sizes 5 through 9.



17HL1 Locked hip joint bar

With manual ring lock

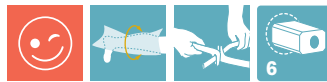

Technical data

Article number	Upper/lower bar length	Bar width top/bottom	Bar thickness top/bottom	Material	Quantity unit
17HL1=13-CS	300 / 200 mm	12.7 / 14.28 mm	4.75 / 4.75 mm	Steel	Pair
17HL1=16-CS	400 / 270 mm	15.87 / 19 mm	6.35 / 4.75 mm	Steel	Pair

· Manual = the ring lock must be manually moved into the locked position

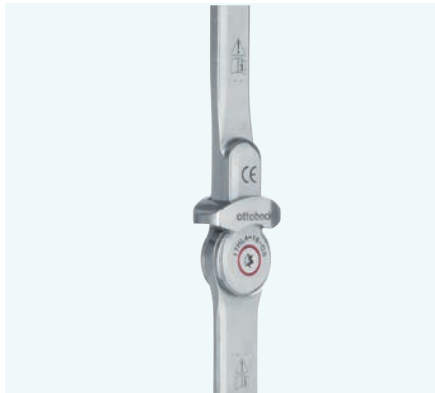

17HL4 Locked hip joint bar

With automatic ring lock

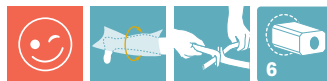

Technical data

Article number	Upper/lower bar length	Bar width top/bottom	Bar thickness top/bottom	Material	Quantity unit
17HL4=13-CS	300 / 200 mm	12.7 / 14.28 mm	4.75 / 4.75 mm	Steel	Pair
17HL4=16-CS	400 / 270 mm	15.87 / 19 mm	6.35 / 4.75 mm	Steel	Pair

· Automatic = a spring presses the ring lock into the locked position

Spare parts for 17HL1, 17HL4



17KHS=3 Service set

Service set for size 13 (steel) 17KF1, 17KL6 and 17KL7 knee joints as well as the 17HF1, 17HL1, 17HL4 and 17HL5 hip joints

Technical data

Article number	Spare part for	Scope of delivery
17KHS=3	17HL1=13-CS 17HL4=13-CS	Bearing nut Bushing Flat round disk with slot Red washer Compression spring Truss head screw with slot Spring-loaded thrust piece



17KHS=2 Service set

Service set for size 16 (steel) 17KF1, 17KL6 and 17KL7 knee joints as well as the 17HF1, 17HL1 and 17HL4 hip joints

Technical data

Article number	Spare part for	Scope of delivery
17KHS=2	17HL1=16-CS 17HL4=16-CS	Bearing nut Bushing Flat round disk with slot Red washer Compression spring Truss head screw with slot Spring-loaded thrust piece

Accessory for 17HL1, 17HL4



743Y57 Alignment insert set

Alignment insert set for conventional orthotic joints

Technical data

Article number	Accessory for
743Y57	17HL1=13-CS 17HL1=16-CS 17HL4=13-CS 17HL4=16-CS

· The 743Y57 is a set consisting of the alignment inserts in sizes 5 through 9.



17H34 Hip joint bar

Locked hip joint with ring lock and abduction joint, flat bar profile

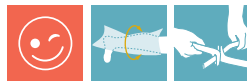

Technical data

Article number	Side	Thick-ness	Width	Milled head Ø	Upper/lower bar length	Material	Quantity unit
17H34=L	left (L)	5 mm	19 mm	30 mm	360 / 250 mm	Stainless steel	Piece
17H34=R	right (R)	5 mm	19 mm	30 mm	360 / 250 mm	Stainless steel	Piece

Spare parts for 17H34

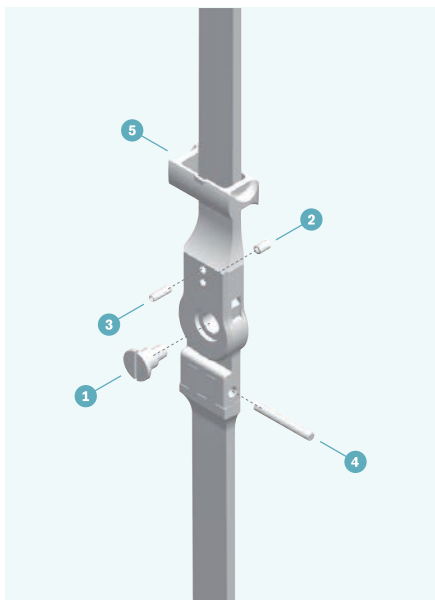

1) 501A21 Oval head screw, slotted and partially threaded

Technical data

Article number	Spare part for	Material	Quantity unit
501A21	17H28=L5 17H28=R5	Stainless steel	Piece

1) 501A29 Oval head screw, slotted and partially threaded

Technical data

Article number	Spare part for	Material	Quantity unit
501A29=14X9X6.5XM6	17H34=R 17H34=L	Stainless steel	Piece

2) 501D1 Spring-loaded thrust piece

Technical data

Article number	Spare part for	Material	Quantity unit
501D1	17H34=R 17H34=L	Stainless steel	Piece

3) 506S1 Clamping sleeve

Technical data

Article number	Spare part for	Material	Quantity unit
506S1=3.5X10	17H34=L 17H34=R	Stainless steel	Piece

4) 506A12 Rivet pin

Technical data

Article number	Quantity unit
506A12=4X22	Piece

5) 17Y31 Lock Ring -Stainless Steel

Technical data

Article number	Spare part for	Material	Quantity unit
17Y31=14X10	17H34=L 17H34=R	Stainless steel	Piece



17H28 Hip joint bar

With ring lock, flat bar profile

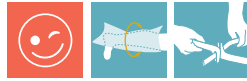

Technical data

Article number	Side	Width	Thick-ness	Milled head Ø	Upper/lower bar length	Material	Quantity unit
17H28=L5	left (L)	14 mm	4 mm	20 mm	320 / 250 mm	Stainless steel	Piece
17H28=R5	right (R)	14 mm	4 mm	20 mm	320 / 250 mm	Stainless steel	Piece

Spare parts for 17H28

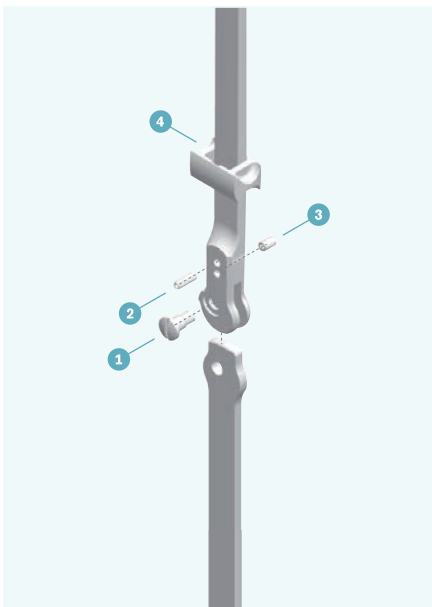

1) 501A21 Oval head screw, slotted and partially threaded

Technical data

Article number	Spare part for	Material	Quantity unit
501A21	17H28=L5 17H28=R5	Stainless steel	Piece

2) 506S1 Clamping sleeve

Technical data

Article number	Spare part for	Material	Quantity unit
506S1=3.5X10	17H28=L5 17H28=R5	Stainless steel	Piece

3) 501D1 Spring-loaded thrust piece

Technical data

Article number	Spare part for	Material	Quantity unit
501D1	17H28=L5 17H28=R5	Stainless steel	Piece

4) 17Y31 Lock Ring -Stainless Steel

Technical data

Article number	Spare part for	Material	Quantity unit
17Y31=14X10	17H28=L5 17H28=R5	Stainless steel	Piece



ottobock.
17LS3=20-T
LOT 0001201912

Bars/bar accessories.

This section contains all bars made of aluminium, steel and titanium.



17B39 System side bar set

Flat, set consisting of two 17B6 Thigh side bars and one each, left and right, 17B7 Lower leg side bars.

Technical data

Article number	System width	Thickness	Material	Quantity unit
17B39=16	16 mm	5 mm	Aluminium	Set
17B39=20	20 mm	5 mm	Aluminium	Set

To process the bars, order also 636W28 (special adhesive and hardener). Please refer to the 646K1 materials catalogue for further information on these products.

Components of 17B39



17B6 Thigh side bar

Thigh side bar for the 17B39 and 17B41 system side bar sets

Technical data

Article number	System width	Length	Thickness	Material	Quantity unit
17B6=16	16 mm	410 mm	5 mm	Aluminium	Piece
17B6=20	20 mm	410 mm	5 mm	Aluminium	Piece



17B7 Lower leg side bar

Lower side bar for all system bars

Technical data

Article number	Side	System width	Length	Thickness	Material	Quantity unit
17B7=L16	left (L)	16 mm	450 mm	5 mm	Aluminium	Piece
17B7=R16	right (R)	16 mm	450 mm	5 mm	Aluminium	Piece
17B7=L20	left (L)	20 mm	450 mm	5 mm	Aluminium	Piece
17B7=R20	right (R)	20 mm	450 mm	5 mm	Aluminium	Piece



17B38 System side bar set

Flat, set consisting of two 17B4 Thigh side bars and one each, left and right, 17B5 Lower leg side bars.

Technical data

Article number	System width	Thickness	Material	Quantity unit
17B38=16	16 mm	4 mm	Stainless steel	Set
17B38=16-T	16 mm	4 mm	Titanium	Set
17B38=20	20 mm	4 mm	Stainless steel	Set
17B38=20-T	20 mm	4 mm	Titanium	Set

• To process the bars, order also 636W28 (special adhesive and hardener). Please refer to the 646K1 materials catalogue for further information on these products.

Components of 17B38



17B4 Thigh side bar

Upper side bar

Technical data

Article number	System width	Length	Thickness	Material	Quantity unit
17B4=16	16 mm	410 mm	4 mm	Stainless steel	Piece
17B4=20	20 mm	410 mm	4 mm	Stainless steel	Piece



17B5 Lower leg side bar

Lower side bar for all system bars

Technical data

Article number	Side	System width	Length	Thickness	Material	Quantity unit
17B5=L16	left (L)	16 mm	450 mm	4 mm	Stainless steel	Piece
17B5=R16	right (R)	16 mm	450 mm	4 mm	Stainless steel	Piece
17B5=L20	left (L)	20 mm	450 mm	4 mm	Stainless steel	Piece
17B5=R20	right (R)	20 mm	450 mm	4 mm	Stainless steel	Piece



17B41 System side bar set, extra long

Flat, extra-long, set consisting of two 17B6 Thigh side bars and one each, left and right, 17B104 Lower leg side bars.

Technical data

Article number	System width	Thickness	Material	Quantity unit
17B41=16	16 mm	5 mm	Aluminium	Set
17B41=20	20 mm	5 mm	Aluminium	Set

To process the bars, order also 636W28 (special adhesive and hardener). Please refer to the 646K1 materials catalogue for further information on these products.

Components of 17B41



17B6 Thigh side bar

Thigh side bar for the 17B39 and 17B41 system side bar sets

Technical data

Article number	System width	Length	Thickness	Material	Quantity unit
17B6=16	16 mm	410 mm	5 mm	Aluminium	Piece
17B6=20	20 mm	410 mm	5 mm	Aluminium	Piece



17B104 Lower leg side bar

Lower leg side bar from the 17B41 side bar set

Technical data

Article number	Side	System width	Length	Thickness	Material	Quantity unit
17B104=L16	left (L)	16 mm	560 mm	5 mm	Aluminium	Piece
17B104=R16	right (R)	16 mm	560 mm	5 mm	Aluminium	Piece
17B104=L20	left (L)	20 mm	560 mm	5 mm	Aluminium	Piece
17B104=R20	right (R)	20 mm	560 mm	5 mm	Aluminium	Piece

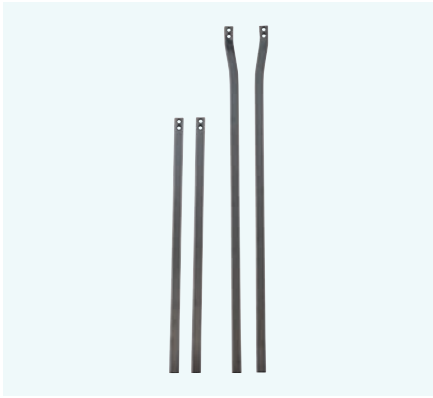

17B40 System side bar set

Flat, extra-long, set consisting of two 17B4 Thigh side bars and one each, left and right, 17B102 Lower leg side bars.

Technical data

Article number	System width	Thickness	Material	Quantity unit
17B40=16	16 mm	4 mm	Stainless steel	Set
17B40=20	20 mm	4 mm	Stainless steel	Set

To process the bars, order also 636W28 (special adhesive and hardener). Please refer to the 646K1 materials catalogue for further information on these products.

Components of 17B40



17B4 Thigh side bar

Upper side bar

Technical data

Article number	System width	Length	Thickness	Material	Quantity unit
17B4=16	16 mm	410 mm	4 mm	Stainless steel	Piece
17B4=20	20 mm	410 mm	4 mm	Stainless steel	Piece



17B102 Lower leg side bar

Lower leg side bar made of stainless steel

Technical data

Article number	Side	System width	Length	Thickness	Material	Quantity unit
17B102=L16	left (L)	16 mm	560 mm	4 mm	Stainless steel	Piece
17B102=R16	right (R)	16 mm	560 mm	4 mm	Stainless steel	Piece
17B102=L20	left (L)	20 mm	560 mm	4 mm	Stainless steel	Piece
17B102=R20	right (R)	20 mm	560 mm	4 mm	Stainless steel	Piece



17B85 System side bar set

Concave, consisting of two 17B88 upper side bars and one left and one right 17B89 lower side bar.

Technical data

Article number	System width	Thickness	Material	Quantity unit
17B85=16	16 mm	5 mm	Aluminium	Set
17B85=20	20 mm	5 mm	Aluminium	Set

To process the bars, order also 636W28 (special adhesive and hardener). Please refer to the 646K1 materials catalogue for further information on these products.

Components of 17B85



17B88 Thigh side bar

Thigh side bar for 17B85

Technical data

Article number	System width	Length	Thickness	Material	Quantity unit
17B88=16	16 mm	410 mm	5 mm	Aluminium	Piece
17B88=20	20 mm	410 mm	5 mm	Aluminium	Piece



17B89 Lower leg side bar

Lower leg side bar for 17B85

Technical data

Article number	Side	System width	Length	Thickness	Material	Quantity unit
17B89=L16	left (L)	16 mm	450 mm	5 mm	Aluminium	Piece
17B89=R16	right (R)	16 mm	450 mm	5 mm	Aluminium	Piece
17B89=L20	left (L)	20 mm	450 mm	5 mm	Aluminium	Piece
17B89=R20	right (R)	20 mm	450 mm	5 mm	Aluminium	Piece



17B84 System side bar set

Concave, set consisting of two 17B86 Thigh side bars and one each, left and right, 17B87 Lower leg side bars.

Technical data

Article number	System width	Thickness	Material	Quantity unit
17B84=16	16 mm	4 mm	Steel	Set
17B84=20	20 mm	4 mm	Steel	Set

To process the bars, order also 636W28 (special adhesive and hardener). Please refer to the 646K1 materials catalogue for further information on these products.

Components of 17B84



17B86 Thigh side bar

Thigh side bar for the 17B84 system side bar set

Technical data

Article number	System width	Length	Thickness	Material	Quantity unit
17B86=16	16 mm	410 mm	4 mm	Steel	Piece
17B86=20	20 mm	410 mm	4 mm	Steel	Piece



17B87 Lower leg side bar

Lower leg side bar for the 17B84 system side bar set

Technical data

Article number	Side	System width	Length	Thickness	Material	Quantity unit
17B87=L16	left (L)	16 mm	450 mm	4 mm	Steel	Piece
17B87=R16	right (R)	16 mm	450 mm	4 mm	Steel	Piece
17B87=L20	left (L)	20 mm	450 mm	4 mm	Steel	Piece
17B87=R20	right (R)	20 mm	450 mm	4 mm	Steel	Piece



17SB100 Nexgear side bars

The side bars are designed for combination with the 17AD200 Nexgear Sixty-six ankle and the 17KL100 Nexgear lock knee, 17KF110 Nexgear free knee and 17KF210 Nexgear posterior knee. They are intended exclusively for bilateral use and in the thermoplastic or bar-clip technique.

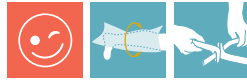

Technical data

Article number	Version	System width	Length	Thickness	Material	Max. body weight	Side	Quantity unit
17SB100=10	Without calf swing	10 mm	270 mm	3,5 mm	Steel	15 kg	both sides	Piece
17SB100=10-L	With calf swing	10 mm	270 mm	3,5 mm	Steel	15 kg	left	Piece
17SB100=10-R	With calf swing	10 mm	270 mm	3,5 mm	Steel	15 kg	right	Piece
17SB100=12	Without calf swing	12 mm	300 mm	3,5 mm	Steel	20 kg	both sides	Piece
17SB100=12-A	Without calf swing	12 mm	300 mm	5 mm	Aluminium	15 kg	both sides	Piece
17SB100=12-L	With calf swing	12 mm	300 mm	3,5 mm	Steel	20 kg	left	Piece
17SB100=12-R	With calf swing	12 mm	300 mm	3,5 mm	Steel	20 kg	right	Piece
17SB100=14	Without calf swing	14 mm	400 mm	3,5 mm	Steel	50 kg	both sides	Piece
17SB100=14-A	Without calf swing	14 mm	400 mm	6 mm	Aluminium	20 kg	both sides	Piece
17SB100=14-L	With calf swing	14 mm	400 mm	3,5 mm	Steel	50 kg	left	Piece
17SB100=14-R	With calf swing	14 mm	400 mm	3,5 mm	Steel	50 kg	right	Piece
17SB100=16	Without calf swing	16 mm	450 mm	3,5 mm	Steel	85 kg	both sides	Piece
17SB100=16-A	Without calf swing	16 mm	450 mm	6 mm	Aluminium	50 kg	both sides	Piece
17SB100=16-L	With calf swing	16 mm	450 mm	3,5 mm	Steel	85 kg	left	Piece
17SB100=16-R	With calf swing	16 mm	450 mm	3,5 mm	Steel	85 kg	right	Piece
17SB100=20	Without calf swing	20 mm	470 mm	3,5 mm	Steel	110 kg	both sides	Piece
17SB100=20-A	Without calf swing	20 mm	470 mm	6 mm	Aluminium	85 kg	both sides	Piece
17SB100=20-L	With calf swing	20 mm	470 mm	3,5 mm	Steel	110 kg	left	Piece
17SB100=20-R	With calf swing	20 mm	470 mm	3,5 mm	Steel	110 kg	right	Piece

- Available versions: With or without calf swing
- Available sizes: 10, 12, 14, 16, 20
- Variants without calf swing in aluminium not available in size 10.
- Note the deviating weight limits for sizes 12, 14, 16, 20.
- Available materials: Steel (-), Variants without calf swing: Steel (-), aluminium (A)
- Available sides (for variants with calf swing): right (R), left (L)
- Variants without calf swing can be used in a side-neutral way.



17SL100 Nexgear lamination bars

The lamination bars are designed for combination with the 17AD200 Nexgear Sixty-six ankle and the 17KL100 Nexgear lock knee, 17KF110 Nexgear free knee and 17KF210 Nexgear posterior knee. They are intended exclusively for bilateral use and in the lamination or prepreg technique.



Technical data

Article number	Version	System width	Length	Thickness	Material	Max. body weight	Side
17SL100=10	Without calf swing	10 mm	80 mm	3,5 mm	Steel	15 kg	both sides
17SL100=10-T	Without calf swing	10 mm	80 mm	3,5 mm	Titanium	15 kg	both sides
17SL100=12	Without calf swing	12 mm	80 mm	3,5 mm	Steel	20 kg	both sides
17SL100=12-T	Without calf swing	12 mm	80 mm	3,5 mm	Titanium	20 kg	both sides
17SL100=14	Without calf swing	14 mm	80 mm	3,5 mm	Steel	50 kg	both sides
17SL100=14-T	Without calf swing	14 mm	80 mm	3,5 mm	Titanium	50 kg	both sides
17SL100=16	Without calf swing	16 mm	100 mm	3,5 mm	Steel	85 kg	both sides
17SL100=16-T	Without calf swing	16 mm	100 mm	3,5 mm	Titanium	85 kg	both sides
17SL100=20	Without calf swing	20 mm	100 mm	3,5 mm	Steel	110 kg	both sides
17SL100=20-T	Without calf swing	20 mm	100 mm	3,5 mm	Titanium	110 kg	both sides
17SL100=10-*	With calf swing	10 mm	80 mm	3,5 mm	Steel (-) Titanium (T)	15 kg	left (L), right (R)
17SL100=12-*	With calf swing	12 mm	80 mm	3,5 mm	Steel (-) Titanium (T)	20 kg	left (L), right (R)
17SL100=14-*	With calf swing	14 mm	80 mm	3,5 mm	Steel (-) Titanium (T)	50 kg	left (L), right (R)
17SL100=16-*	With calf swing	16 mm	100 mm	3,5 mm	Steel (-) Titanium (T)	85 kg	left (L), right (R)
17SL100=20-*	With calf swing	20 mm	100 mm	3,5 mm	Steel (-) Titanium (T)	110 kg	left (L), right (R)

- Available versions: With or without calf swing
- Available sizes: 10, 12, 14, 16, 20
- Available materials: titanium (T), steel (-)
- Available sides (for variants with calf swing): right (R), left (L)
- The variants without calf swing can be used in a side-neutral way

Order example for lamination bar with calf swing

Reference number	System width	Side	Material
17SL100	= 12	- L	
Lamination bar with calf swing	12	left	steel
17SL100	= 16	- R	- T
Lamination bar with calf swing	16	right	titanium



17Y128 System lamination bar

The system lamination bars are glued with Ottobock special adhesive.

Technical data

Article number	System width	Length	Thickness	Material	Quantity unit
17Y128=16X80	16 mm	80 mm	4 mm	Stainless steel	Piece
17Y128=20X80	20 mm	80 mm	4 mm	Stainless steel	Piece
17Y128=16X100	16 mm	100 mm	4 mm	Stainless steel	Piece
17Y128=20X100	20 mm	100 mm	4 mm	Stainless steel	Piece

- Caution! The system lamination bars always have to be used in pairs in the leg orthosis. Unilateral use can cause the lamination bar to break due to overloading.



17Y129 System lamination bar with contoured calf

The system lamination bars are glued with Ottobock special adhesive.

Technical data

Article number	Side	System width	Length	Thickness	Material	Quantity unit
17Y129=L16	left (L)	16 mm	100 mm	4 mm	Stainless steel	Piece
17Y129=R16	right (R)	16 mm	100 mm	4 mm	Stainless steel	Piece
17Y129=L20	left (L)	20 mm	100 mm	4 mm	Stainless steel	Piece
17Y129=R20	right (R)	20 mm	100 mm	4 mm	Stainless steel	Piece

- Caution! The system lamination bars always have to be used in pairs in the leg orthosis. Unilateral use can cause the lamination bar to break due to overloading.

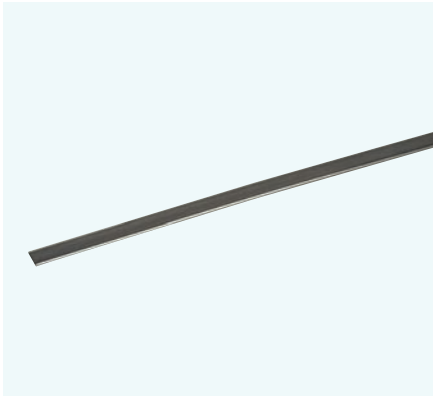

651P4 **Stainless steel profile bar**

Suitable for fabricating system bars, with rounded edges, strength of approx. 800–950 N/mm², spot weldable

Technical data

Article number	Length	Width	Thickness	Material	Order unit
651P4=16	2000 mm	16 mm	4 mm	Stainless steel	Piece(s)
651P4=20	2000 mm	20 mm	4 mm	Stainless steel	Piece(s)



605P8 **Light metal profile bar**

Suitable for fabricating system splints, with rounded edges, strength approx. 400 N/mm²

Technical data

Article number	Length	Width	Thickness	Material	Order unit
605P8=14	1000 mm	14 mm	5 mm	Aluminium	Piece(s)
605P8=16	2000 mm	16 mm	5 mm	Aluminium	Piece(s)
605P8=20	2000 mm	20 mm	5 mm	Aluminium	Piece(s)
605P8=20-12	305 mm	20 mm	5 mm	Aluminium	Piece(s)



17LV3 Side bar

Side bar made of stainless steel for unilateral use for thermoplastic technique

Technical data

Article number	System width	Material	Quantity unit
17LV3=10	10 mm	Stainless steel	Piece
17LV3=12	12 mm	Stainless steel	Piece
17LV3=14	14 mm	Stainless steel	Piece
17LV3=16	16 mm	Stainless steel	Piece
17LV3=20	20 mm	Stainless steel	Piece
17LV3=L-16	16 mm	Stainless steel	Piece
17LV3=L-20	20 mm	Stainless steel	Piece
17LV3=R-16	16 mm	Stainless steel	Piece
17LV3=R-20	20 mm	Stainless steel	Piece



17LS3 Lamination bar

Lamination bar for unilateral and bilateral use for lamination resin or prepreg technique



Technical data

Article number	System width	Length	Thickness	Material	Quantity unit
17LS3=10	10 mm	80 mm	5 mm bottom/3 mm top	Stainless steel	Piece
17LS3=10-T	10 mm	80 mm	5 mm bottom/3 mm top	Titanium	Piece
17LS3=12	12 mm	80 mm	5 mm bottom/3 mm top	Stainless steel	Piece
17LS3=12-T	12 mm	80 mm	5 mm bottom/3 mm top	Titanium	Piece
17LS3=14	14 mm	100 mm	6 mm bottom/2.5 mm top	Stainless steel	Piece
17LS3=14-T	14 mm	100 mm	6 mm bottom/2.5 mm top	Titanium	Piece
17LS3=16	16 mm	130 mm	6 mm bottom/3 mm top	Stainless steel	Piece
17LS3=16-T	16 mm	130 mm	6 mm bottom/3 mm top	Titanium	Piece
17LS3=20	20 mm	130 mm	6 mm bottom/3 mm top	Stainless steel	Piece
17LS3=20-T	20 mm	130 mm	6 mm bottom/3 mm top	Titanium	Piece

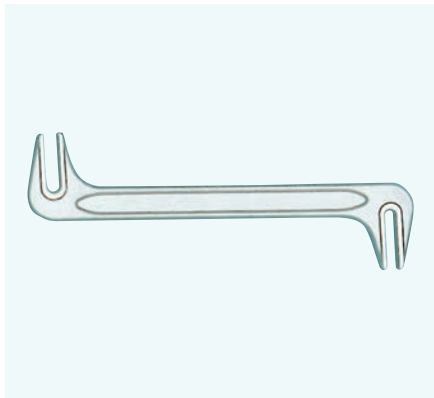

711S1 Bending iron

Bending irons with straight jaws for bending orthotic bars.

Technical data

Article number	711S1=6X4	711S1=8X6	711S1=9X7
Product features	Straight jaws		
Length	245 mm		
Jaw opening	4 und 6 mm	6 und 8 mm	7 and 9 mm
Weight	0.35 kg	0.33 kg	0.325 kg
Material	CV steel		



711S2 Bending pusher set

Bending fixture set for mounting in the vice.

Technical data

Article number	711S2
Package contents	3 piece(s)
Weight	0.245 kg
Material	Steel



711S3 Bending iron

Bending irons for bending over the upper edge of system side bars and knee joint bars.
Bending iron for horizontal bending of the 17Y128, 17Y129, 17B39, 17B41, 17B85, 17B38, 17B40, 17B84 bilateral lamination and side bars

Technical data

Article number	711S3
Product features	Concave half-round, Moulded jaws
Length	500 mm
For bar width	16 and 20 mm
Weight	1.42 kg
Material	Tool steel, high-alloyed

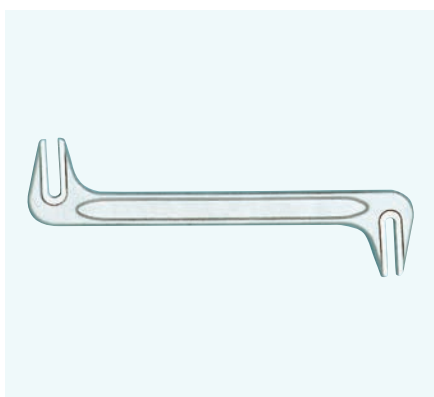

711S4 Bending iron

Bending irons with rounded jaws for bending orthotic bars.

Technical data

Article number	711S4=3X3.5	711S4=6X4	711S4=8X6
Product features	Rounded jaws		
Length	245 mm		
Jaw opening	3 and 3.5 mm	4 and 6 mm	6 and 8 mm
Weight	0.35 kg		
Material	CV steel		



711S5 Bending iron

Bending irons with round jaws for bending orthotic bars.

Technical data

Article number	711S5
Product features	Round jaws
Length	310 mm
Jaw opening	4 and 6 mm
Weight	0.55 kg
Material	CV steel



711S13 Bending iron set

The set contains two bending irons for bending the 17SL100, 17SB100, 17LS3 and 17LV3 bars in sizes 16 and 20.

Technical data

Article number	711S13
Product features	Set of two bending irons for bilateral and unilateral system bars
For bar width	16 und 20
Length	700 mm
Weight	4,8 kg
Material	Tool steel, high-alloyed



711S14 Bending iron set small

The set contains two bending irons for bending the 17SL100, 17SB100, 17LS3 and 17LV3 bars in sizes 10, 12 and 14.

Technical data

Article number	711S14
Product features	Set of two bending irons for bilateral and unilateral system bars
For bar width	10, 12 und 14
Length	500 mm
Weight	3,5 kg
Material	Tool steel, high-alloyed



702B9 Hole gauge

Drilling jig for perfect-fit bore hole for oval head Philips screws (501T7=7.5X9XM5) for Otto-bock system bars.

Technical data

Article number	702B9
Weight	0.21 kg
Material	Tool steel



702B13 Hole gauge

Hole gauge for 17SB100 and 17LV3 side bars.

Technical data

Article number	702B13
Size (W x D x H)	57 mm x 52 mm x 29 mm
Weight	0,46 kg
Material	Tool steel



Other.

All other components, from arm bars to correction joint systems, are presented in this section.



17BK1 Correction system joints

Static joints for positioning orthoses

Key features

- Improved rest position
- Protection, safety and the possibility of step-by-step joint mobilisation during the rehabilitation phase
- Promotes the growth of truncated tissue and/or reshaping of changed tissue, resulting in increased joint activity
- Prevention of malformations and restoration of joint functions

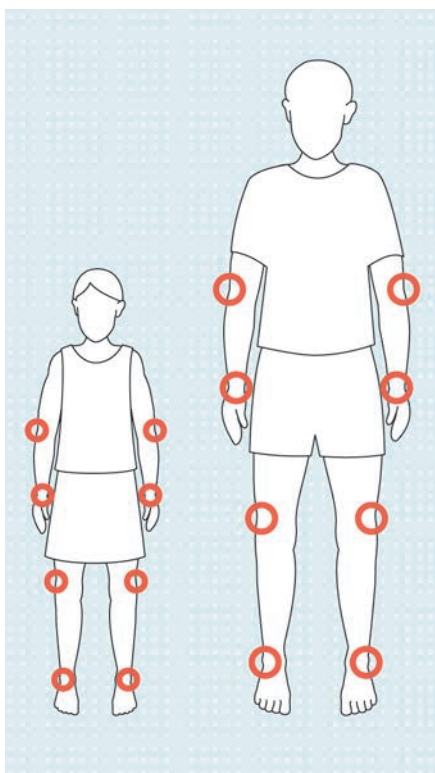
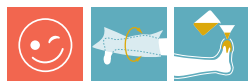

Technical data

Article number	Medial support	Side	System width	Material	Quantity unit
17BK1=L1	17BK3=18	left (L)	20 mm	Aluminium	Piece
17BK1=R1	17BK3=18	right (R)	20 mm	Aluminium	Piece
17BK1=L2	17BK3=18	left (L)	16 mm	Aluminium	Piece
17BK1=R2	17BK3=18	right (R)	16 mm	Aluminium	Piece
17BK1=L3	17BK3=14	left (L)	14 mm	Aluminium	Piece
17BK1=R3	17BK3=14	right (R)	14 mm	Aluminium	Piece
17BK1=L4	17BK3=14	left (L)	12 mm	Aluminium	Piece
17BK1=R4	17BK3=14	right (R)	12 mm	Aluminium	Piece
User height		Wrist		Elbow joint	
Child up to 1 m		=L/R4		=L/R4	
Child 1 to 1.40 m		=L/R4		=L/R3	
Adults up to 1.60 m		=L/R4		=L/R3	
Adults 1.60 to 1.90 m		=L/R3		=L/R2	

i Practical recommendation

- Attention: This information is only a recommendation. The correct size for the respective patient must be determined and specified by the O&P professional in each case. The joints are used individually or in pairs depending on the application. We recommend always using a medial support, e.g., an integrated plastic joint. The produce must be used bilaterally (in pairs) for the knee and ankle joints. The left/right side indications refer to application of the joints on the wrist, knee joint or ankle joint. The sides must be reversed for elbow applications to accommodate the anatomical shape of the elbow (right to left and left to right).

Spare parts for 17BK1

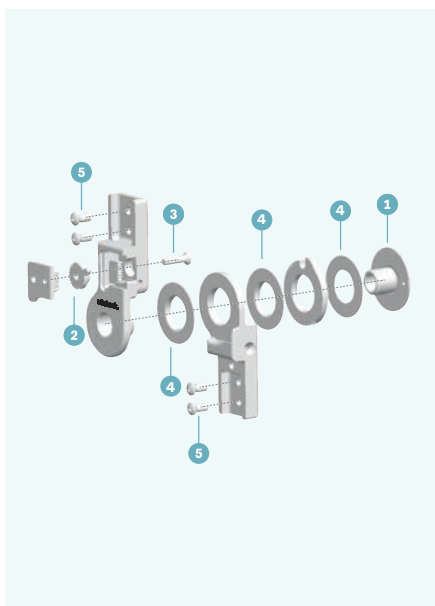

1) 30Y156 Joint nut

Technical data

Article number	Spare part for	Quantity unit
30Y156=1	17BK1=L1 17BK1=R1	Piece
30Y156=2	17BK1=L2 17BK1=R2	Piece
30Y156=3	17BK1=L3 17BK1=R3	Piece
30Y156=4	17BK1=L4 17BK1=R4	Piece

2) 30Y212 Set wheel with lever

Technical data

Article number	Spare part for	Quantity unit
30Y212=1	17BK1=L1 17BK1=R1 17BK1=L2 17BK1=R2 17BK1=L3 17BK1=R3	Piece
30Y212=2	17BK1=L4 17BK1=R4	Piece

3) 501T19 Phillips countersunk head screw

Technical data

Article number	Spare part for	Thread	Length	Material
501T19=M3X12-1	17BK1=L4 17BK1=R4	M3	12 mm	Stainless steel
501T19=M4X14-1	17BK1=L2 17BK1=R2 17BK1=L3 17BK1=R3	M4	14 mm	Stainless steel
501T19=M4X16-1	17BK1=L1 17BK1=R1	M4	16 mm	Stainless steel

4) 17BK1=S Washer set

Technical data

Article number	Spare part for	Quantity unit
17BK1=S-1	17BK1=L1 17BK1=R1	Piece
17BK1=S-2	17BK1=L2 17BK1=R2	Piece
17BK1=S-3	17BK1=L3 17BK1=R3	Piece
17BK1=S-4	17BK1=L4 17BK1=R4	Piece

5) 501S86 Phillips oval countersunk head screw

Technical data

Article number	Spare part for	Quantity unit
501S86=M4X8	17BK1=L3 17BK1=R3 17BK1=L4 17BK1=R4	Piece

5) 501T7 Phillips oval countersunk head screw

Technical data

Article number	Spare part for	Head Ø	Length	Material	Quantity unit
501T7=7.5X11XM5	17BK1=L1 17BK1=R1 17BK1=L2 17BK1=R2	7.5 mm	11 mm	Stainless steel	Piece



710H10 Allen wrench

The Allen wrench with wing handle is available as a spare part and is used for adjusting various modular knee joints and modular hip joints.

Technical data

Article number
710H10=2X3

Accessory for 17BK1



17BK2 Dynamic unit for correction system joint

The 17BK2 dynamic unit is available for all four sizes of the 17BK1 static correction system joint and, depending on the joint size, offers a maximum spring force of approx. 10 Nm. Using the 17BK2 dynamic unit allows for extension or flexion yielding, depending on the joint and indications. Spring force is used to slowly bring the joint back into the desired position. The spring force is continuously adjustable, allowing for individual dynamic treatment of contractures.



Technical data

Article number	Accessory for	Spring tension	Quantity unit
17BK2=L1	17BK1=L1	~ 10 Nm	Piece
17BK2=R1	17BK1=R1	~ 10 Nm	Piece
17BK2=L2	17BK1=L2	~ 6 Nm	Piece
17BK2=R2	17BK1=R2	~ 6 Nm	Piece
17BK2=L3	17BK1=L3	~ 6 Nm	Piece
17BK2=L4	17BK1=L4	~ 3 Nm	Piece
17BK2=R4	17BK1=R4	~ 3 Nm	Piece
17BK2=R4	17BK1=R4	~ 3 Nm	Piece

· Please note that the size and side of the static and dynamic units have to be identical.

Spare parts for 17BK2



1) 30Y183 Cover

Technical data

Article number	Quantity unit
30Y183=1	Piece
30Y183=2	Piece
30Y183=4	Piece

2) 30Y192 Locating bolt

Technical data

Article number	Quantity unit
30Y192=1	Piece
30Y192=2	Piece
30Y192=4	Piece

3) 501S84 Flat head screw

Technical data

Article number	Quantity unit
501S84=M3X14	Piece
501S84=M4X17	Piece
501S84=M4X18	Piece
501S84=M5X22	Piece



29Y27 Phillips head screw

The Phillips head screw is suitable for fastening straps.

Technical data

Article number	Accessory for	Thread	Length	Colour
29Y27=M4X20-6	17BK1=L4 17BK1=R4	M4	20 mm	White

Accessory for 17BK1

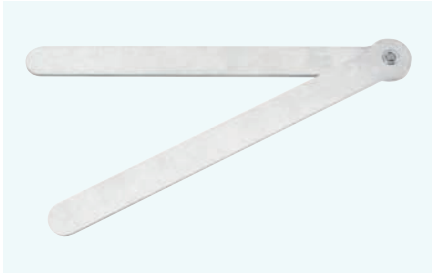

17BK3 Medial support for correction system joint

Medial support for correction system joint

Technical data

Article number	Material	Quantity unit
17BK3=14	Aluminium	Piece
17BK3=18	Aluminium	Piece

· Please note that the size and side of the static and dynamic units have to be identical.



17F52 Side bar

Side bar for joints

Technical data

Article number	Length	Width	Thickness	Material	Quantity unit
17F52=12X3X220	220 mm	12 mm	3 mm	Aluminium	Piece
17F52=14X3X220	220 mm	14 mm	3 mm	Aluminium	Piece



605P8 Light metal profile bar

Suitable for fabricating system splints, with rounded edges, strength approx. 400 N/mm²

Technical data

Article number	Accessory for	Length	Width	Thickness	Material	Quantity unit
605P8=16	17BK1=L2 17BK1=R2	2000 mm	16 mm	5 mm	Aluminium	Piece
605P8=20	17BK1=L1 17BK1=R1	2000 mm	20 mm	5 mm	Aluminium	Piece

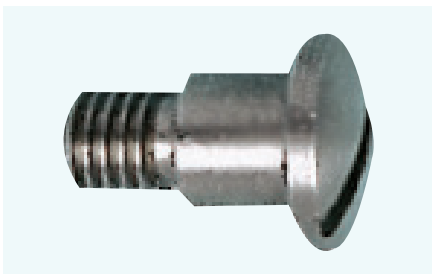

501A29 Oval head screw, slotted and partially threaded

Technical data

Article number	Accessory for	Material	Quantity unit
501A29=12X7XM4	17BK1=L2 17BK1=R2 17BK1=L3 17BK1=R3	Stainless steel	Piece
501A29=14X9.5XM6	17BK1=L1 17BK1=R1	Stainless steel	Piece



16X12 Elbow joint bars

Two joint bars for arm prostheses, usable on both sides. One joint bar has a swivelling cable lock and 18 locking positions in 7.2° increments. The other joint bar has a flat bar profile and no lock.

Technical data

Article number	Head Ø	Material	Quantity unit
16X12	30 mm	Stainless steel	Pair

Components of 16X12



16X13 Elbow joint bar with cable lock

Joint with swivelling cable lock, 18 locking positions in 7.2° increments, flat bar profile, suitable for both sides, for arm prostheses. Head diameter of 30 mm, joint bar length of 320 mm (top and bottom), joint bar width/thickness: 14 / 2 mm.

Technical data

Article number	Head Ø	Material	Quantity unit
16X13	30 mm	Stainless steel	Piece



16X14 Elbow joint bar without lock

The joint is freely moveable with a flat joint bar profile. Head diameter of 30 mm, joint bar length of 320 mm (top and bottom), joint bar width/thickness: 14 / 2 mm.

Technical data

Article number	Head Ø	Material	Quantity unit
16X14	30 mm	Stainless steel	Piece

Spare parts for 16X12



16Y27 Joint Piece with Cable Lock

Joint piece with cable lock. 18 locking positions in 7.2° increments, suitable for both sides. With joint bracket and socket screws (oval head screws). Compatible with 12K27, 16X12 and 16X13.

Technical data

Article number	Quantity unit
16Y27	Piece



16Y31 Joint Piece without Lock

Joint piece without lock, compatible with 16X12 and 16X14. With joint bracket and socket screws.

Technical data

Article number	Quantity unit
16Y31=N	Piece



16Y26 Pull cable

The pull cable with threaded connection is a spare part for the 12K27 elbow component and the 16X12 and 16X13 elbow joint bars.

Technical data

Article number	Quantity unit
16Y26	Piece



21Y79 Stirrup with wedge lock

Belt flap with wedge lock, compatible with 16X12 and 16X13 models.

Technical data

Article number	Quantity unit
21Y79	Piece



16X4 Arm bars

Joints with automatic ratchet lock, locks only in extension direction, releases at a max. flexion of approx. 135°, concave half-round bar profile

Technical data

Article number	Bar width	Bar thickness	Head Ø	Material	Quantity unit
16X4	14 mm	2 mm	26 mm	Stainless steel	Piece

Spare parts for 16X4

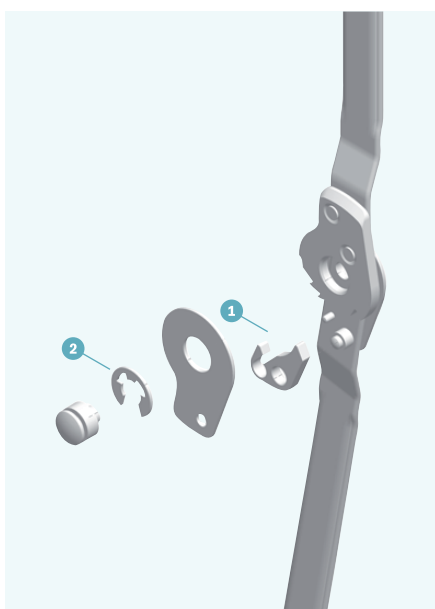

1) 16Y7 Lock latch

Technical data

Article number	Material	Quantity unit
16Y7	Stainless steel	Piece

2) 16Y8 Lock washer

Technical data

Article number	Material	Quantity unit
16Y8	Stainless steel	Piece



17B70 Positioning joint

Adjustable in 8° increments, used with adjustable positioning splints and static correction orthoses

Technical data

Article number	For system width	Material	Quantity unit
17B70=12	12 mm	Stainless steel	Piece

Spare parts for 17B70

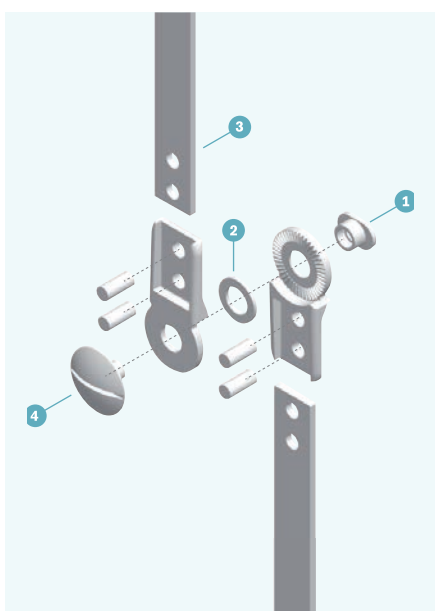

1) 17Y93 Bearing nut, hardened

Technical data

Article number	Spare part for	Insertion length	Profile length	Shank length	Thread	Shoulder Ø	Quantity unit
17Y93=7X4.8XM5	17B70=12	3.55 mm	12 mm	4.8 mm	M5	7 mm	Piece

2) 18Z3 Ring

Technical data

Article number	Quantity unit
18Z3	Piece

3) 651B1 Spring band steel profile bar

Technical data

Article number	Length	Width	Thickness	Quantity unit
651B1=12	2000 mm	12 mm	2 mm	Piece

4) 501S57 Slotted truss head screw

Technical data

Article number	Quantity unit
501S57	Piece

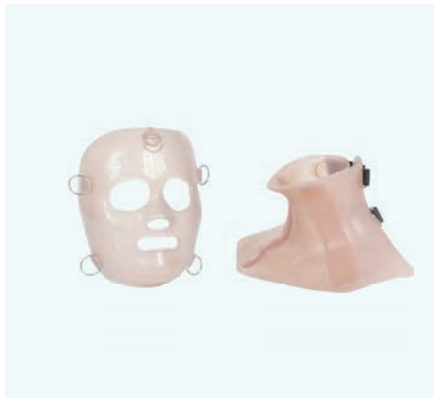

88M2 Silicone scar compression mask and collar

Clinical studies have shown that compression and occlusion are two treatment options which have a positive influence on scar healing. The scar tissue is enclosed by the silicone compression products and, at the same time, controlled pressure is exerted. Silicone retains the moisture in the skin and the irritated scar tissue areas can regain their elasticity and flexibility without the use of additional creams. The material also retains its form and flexibility independent of any strain placed on it.

Key features

- Facilitates healing
- Reduces scar formation
- Prevents the scar area from drying out
- Protects the scar against dirt penetration
- Easy to clean with pH-neutral soap and water

Technical data

Article number	Description
88M1=A	Silicone partial face mask without Thermolyn clear mask
88M1=B	Silicone face mask without Thermolyn clear mask
88M1=P	Thermolyn clear check mask for silicone scar compression mask
88M1=P1	FFF check mask for silicone scar compression mask
88M2=A	Silicone partial face mask with Thermolyn clear mask
88M2=B	Silicone face mask with Thermolyn clear mask
88M2=C	Silicone collar with lower jaw support



Custom products from iFab

iFab offers flexible support for production bottlenecks and custom fitting solutions by taking over the time-consuming fabrication of devices and giving more freedom for core competencies. The iFab Customer Center (iCC) ensures efficient collaboration, where products can be configured and ordered in just a few clicks, order status and history can be assessed.

Ordering options for 88M2

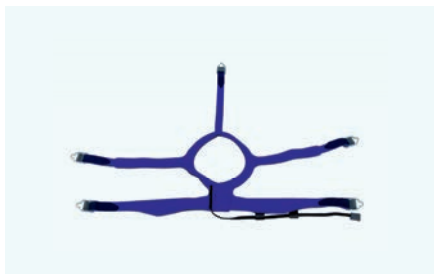

88M10 Mask fixation

The mask fixation is used for the fixation of scar compression masks for the face. It is made of leather lined with felt and has elastic hook-and-loop closures.

Technical data

Article number	Fixing straps	Order unit
88M10=5	5 hook-and-loop closures	Piece(s)



88BH1 Silicone scar compression glove

The custom-made silicone glove exerts controlled pressure on the scar tissue, also in critical areas such as the area between the fingers. Contracture of the fingers can be prevented by incorporating silicone strips with a higher Shore hardness. In addition, it does not lose compression due to material fatigue and the translucent material makes it possible to visually check the scar tissue during the therapy.

Key features

- Facilitates healing
- Maximum compression effect even during extended use
- Reduces scar formation
- Protects the scar against dirt penetration
- Easy to clean with pH-neutral soap and water

Technical data

Article number	Description
88BH1=A	Compression glove without fingers
88BH1=A1	Compression glove with 1 fingers
88BH1=A2	Compression glove with 2 fingers
88BH1=A3	Compression glove with 3 fingers
88BH1=A4	Compression glove with 4 fingers
88BH1=A5	Compression glove with 5 fingers



Custom products from iFab

iFab offers flexible support for production bottlenecks and custom fitting solutions by taking over the time-consuming fabrication of devices and giving more freedom for core competencies. The iFab Customer Center (iCC) ensures efficient collaboration, where products can be configured and ordered in just a few clicks, order status and history can be assessed.

Accessory for 88BH1

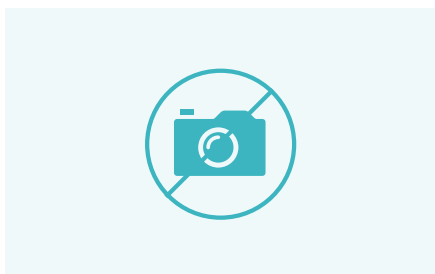

88BH1=AH Donning aid

The donning aid makes it easier for the patient to put on the silicone scar compression glove.

Technical data

Article number
88BH1=AH

Ordering options for 88BH1



88BH1=B Forearm cuff

The forearm cuff is used to compress scar tissue on the forearm. This can be incorporated as a fixed element of the silicone compression glove or ordered as a separate device.

Technical data

Article number
88BH1=B



88BH1=E Extension strip

To prevent contractures after burn injuries, an extension strip can be incorporated in the silicone compression glove as a reinforcing element.

Technical data

Article number
88BH1=E



24H1 MyCRO Band

The MyCRO Band from Ottobock is a temporary orthosis for the correction of positional cranial deformities. The orthosis guides the growth of the head through contact zones and growth zones and is custom-made for each child. Ottobock uses precise scanning and 3D printing processes to produce a customized, extremely thin orthosis. The innovative MySize Closure System™ adapts to the baby's cranial growth, while the open-air design ensures optimal comfort and hygiene.

Features and benefits

- MySize Closure System
- Breathable open-air design
- Lightweight low-profile 3D Printed Thermoplastic Material
- Icon design
- High Resolution 3D scan design
- Flexible material and large opening for easy donning
- Soft Inner fabric lining that is removable and washable

Indications

- For use on infants from 3 to 18 month with positional head deformation (Plagiocephaly, Brachycephaly)

Contraindications

- Not for use on infants with pre-surgical craniosynostosis or hydrocephalus.



Custom products from iFab

iFab offers flexible support for production bottlenecks and custom fitting solutions by taking over the time-consuming fabrication of devices and giving more freedom for core competencies. The iFab Customer Center (iCC) ensures efficient collaboration, where products can be configured and ordered in just a few clicks, order status and history can be assessed.



130M1 3D AFO model

The 3D AFO models set new standards in orthopaedic industry. By using the latest FDM printing technology, we offer positive models that are unrivaled in terms of detail accuracy and edge definition. The models are particularly impressive in the treatment of children due to their hardness and precision – properties that are sometimes lost with conventional milled models.

Key features

- Outstanding level of detail
- Harder than milled models
- Optimized use of material
- Uncomplicated ordering

Technical data

Article number	Side	Height
130M1=L-250-1	left	250 mm
130M1=R-250-1	right	250 mm
130M1=L-250-2	left	250 mm
130M1=R-250-2	right	250 mm
130M1=L-550-1	left	550 mm
130M1=R-550-1	right	550 mm
130M1=L-550-2	left	550 mm
130M1=R-550-2	right	550 mm
130M1=L-750-1	left	750 mm
130M1=R-750-1	right	750 mm
130M1=L-750-2	left	750 mm
130M1=R-750-2	right	750 mm



Custom products from iFab

iFab offers flexible support for production bottlenecks and custom fitting solutions by taking over the time-consuming fabrication of devices and giving more freedom for core competencies. The iFab Customer Center (iCC) ensures efficient collaboration, where products can be configured and ordered in just a few clicks, order status and history can be assessed.



IP3121 AFO model

The foam model made of bubble-free rigid foam can be ordered in various size gradations. A distinction is made between models up to 550 mm, models measuring 550–750 mm and models starting from 750 mm.

Technical data

Article number	Height	Density
IP3121=550-60	550 mm	60 kg/m ³
IP3121=550-100	550 mm	100 kg/m ³
IP3121=550-200	550 mm	200 kg/m ³
IP3121=750-60	750 mm	60 kg/m ³
IP3121=750-100	750 mm	100 kg/m ³
IP3121=750-200	750 mm	200 kg/m ³
IP3121=MAX-60	oversize	60 kg/m ³
IP3121=MAX-100	oversize	100 kg/m ³
IP3121=MAX-200	oversize	200 kg/m ³



Custom products from iFab

iFab offers flexible support for production bottlenecks and custom fitting solutions by taking over the time-consuming fabrication of devices and giving more freedom for core competencies. The iFab Customer Center (iCC) ensures efficient collaboration, where products can be configured and ordered in just a few clicks, order status and history can be assessed.



IP3131 KO model

The foam model is made of bubble-free rigid foam. The models can be ordered in various size gradations. A distinction is made between models up to 550 mm, models measuring 550–750 mm and models starting from 750 mm.

Technical data

Article number	Height	Density
IP3131=550-60	550 mm	60 kg/m ³
IP3131=550-100	550 mm	100 kg/m ³
IP3131=550-200	550 mm	200 kg/m ³
IP3131=750-60	750 mm	60 kg/m ³
IP3131=750-100	750 mm	100 kg/m ³
IP3131=750-200	750 mm	200 kg/m ³
IP3131=MAX-60	oversize	60 kg/m ³
IP3131=MAX-100	oversize	100 kg/m ³
IP3131=MAX-200	oversize	200 kg/m ³



Custom products from iFab

iFab offers flexible support for production bottlenecks and custom fitting solutions by taking over the time-consuming fabrication of devices and giving more freedom for core competencies. The iFab Customer Center (iCC) ensures efficient collaboration, where products can be configured and ordered in just a few clicks, order status and history can be assessed.



IP3141 KAFO model

The foam model, which is made of bubble-free rigid foam, is available in a single or two-part version. As a result, models up to 750 mm, models from 750 to 1100 mm or models from 1100 mm upwards can be ordered based on the size gradations. Additional services can be added as an option: joint support surfaces*, markings for joint axes, gluing in the metal core, drill hole to accommodate the alignment axis (per axis).

* The design is specified by the customer

Technical data

Article number	Height	Density	Product features
IP3141=750-60	750 mm	60 kg/m ³	1-piece
IP3141=750-100	750 mm	100 kg/m ³	1-piece
IP3141=750-200	750 mm	200 kg/m ³	1-piece
IP3141=1100-60-2	1100 mm	60 kg/m ³	opt. 2-piece
IP3141=1100-100-2	1100 mm	100 kg/m ³	opt. 2-piece
IP3141=1100-200-2	1100 mm	200 kg/m ³	opt. 2-piece
IP3141=MAX-60-2	oversize	60 kg/m ³	2-piece
IP3141=MAX-100-2	oversize	100 kg/m ³	2-piece
IP3141=MAX-200-2	oversize	200 kg/m ³	2-piece



Custom products from iFab

iFab offers flexible support for production bottlenecks and custom fitting solutions by taking over the time-consuming fabrication of devices and giving more freedom for core competencies. The iFab Customer Center (iCC) ensures efficient collaboration, where products can be configured and ordered in just a few clicks, order status and history can be assessed.



IP3211 Torso model

3D positive model of a torso made from bubble-free rigid foam. The torso model is part of the 3D design product range.

Key features

- Foam models made from bubble-free rigid foam in different densities
- Depending on the respective density of the rigid foam, the models can be used for different subsequent fabrication processes
- The density has an influence on the edge definition and temperature stability of the model
- Various sizes available

Technical data

Article number	Height	Density
IP3211=350-60	350 mm	60 kg/m ³
IP3211=350-100	350 mm	100 kg/m ³
IP3211=350-200	350 mm	200 kg/m ³
IP3211=800-60	800 mm	60 kg/m ³
IP3211=800-100	800 mm	100 kg/m ³
IP3211=800-200	800 mm	200 kg/m ³
IP3211=MAX-60	oversize	60 kg/m ³
IP3211=MAX-100	oversize	100 kg/m ³
IP3211=MAX-200	oversize	200 kg/m ³



Custom products from iFab

iFab offers flexible support for production bottlenecks and custom fitting solutions by taking over the time-consuming fabrication of devices and giving more freedom for core competencies. The iFab Customer Center (iCC) ensures efficient collaboration, where products can be configured and ordered in just a few clicks, order status and history can be assessed.



IP3221 Head model

The foam model made of bubble-free hard foam can be ordered according to different size gradations. A distinction is made between models up to 400 mm and models from 400 mm.

Technical data

Article number	Height	Density
IP3221=400-60	400 mm	60 kg/m ³
IP3221=400-100	400 mm	100 kg/m ³
IP3221=400-145	400 mm	145 kg/m ³
IP3221=400-200	400 mm	200 kg/m ³
IP3221=MAX-60	oversize	60 kg/m ³
IP3221=MAX-100	oversize	100 kg/m ³
IP3221=MAX-145	oversize	145 kg/m ³
IP3221=MAX-200	oversize	200 kg/m ³



Custom products from iFab

iFab offers flexible support for production bottlenecks and custom fitting solutions by taking over the time-consuming fabrication of devices and giving more freedom for core competencies. The iFab Customer Center (iCC) ensures efficient collaboration, where products can be configured and ordered in just a few clicks, order status and history can be assessed.



17MK1=2 Workshop trolley

Mobile workshop trolley from the OrthoLean concept.

Width 80 cm x depth 40 cm x height 86 cm

Includes lamination dummies and tools for the products in the Nexgear family in sizes 14, 16 and 20.

Scope of delivery

17AD310=14	Shaping dummy set	2	Piece(s)
17AD310=16	Shaping dummy set	2	Piece(s)
17AD310=20	Shaping dummy set	2	Piece(s)
17AD312=20	Assembly tool set for 17SF300	1	Piece(s)
17AD313=14	Lamination dummy set for 17AD300	2	Piece(s)
17AD313=16	Lamination dummy set for 17AD300	2	Piece(s)
17AD200A=DY-14	Dummy for 17AD200	2	Piece(s)
17AD200A=DY-16	Dummy for 17AD200	2	Piece(s)
17AD200A=DY-20	Dummy for 17AD200	2	Piece(s)
17KF112=14	Dummy set for 17KF110	2	Piece(s)
17KF112=16	Dummy set for 17KF110	2	Piece(s)
17KF112=20	Dummy set for 17KF110	2	Piece(s)
17KF113=1	Ball-bearing tool	1	Piece(s)
17KF113=2	Ball-bearing tool	1	Piece(s)
17KF212=14	Dummy set for 17KF210	2	Piece(s)
17KF212=16	Dummy set for 17KF210	2	Piece(s)
17KF212=20	Dummy set for 17KF210	2	Piece(s)
17KL102=L-14-1	Dummy-set for 17KL100	1	Piece(s)
17KL102=L-14-2	Dummy-set for 17KL100	1	Piece(s)
17KL102=R-14-1	Dummy-set for 17KL100	1	Piece(s)
17KL102=R-14-2	Dummy-set for 17KL100	1	Piece(s)
17KL102=L-16-1	Dummy-set for 17KL100	1	Piece(s)
17KL102=L-16-2	Dummy-set for 17KL100	1	Piece(s)
17KL102=R-16-1	Dummy-set for 17KL100	1	Piece(s)
17KL102=R-16-2	Dummy-set for 17KL100	1	Piece(s)
17KL102=L-20-1	Dummy-set for 17KL100	1	Piece(s)
17KL102=L-20-2	Dummy-set for 17KL100	1	Piece(s)
17KL102=R-20-1	Dummy-set for 17KL100	1	Piece(s)
17KL102=R-20-2	Dummy-set for 17KL100	1	Piece(s)
702B13	Hole gauge	1	Piece(s)

3

3D AFO model.....322

A

Adhesive pads for foot sensor.....44, 49
 Adjustable ankle joint181
 Adjustable stop.....94, 99
 Adjustment aid...123-124, 234-235, 248-251
 AFO model.....322
 Alignment insert set... 92, 151, 153, 191, 195, 197, 199-200, 202, 283, 285, 287
 Allen wrench.....311
 Aluminium threaded jaws177
 Ankle joint bar.....84, 86
 Ankle joint bar for children.....78-79
 Ankle joint bar, upper section.....78-79
 Ankle setting nut.....181
 Ankle stirrup.....78, 104
 Ankle stirrup and shrink down tube.....85, 87, 91
 Ankle-foot orthosis14
 Aqualine orthotic system.....244
 Arm bars316
 Assembly tool set for 17SF300.....113
 Axial washers set94, 104
 Axis Pin.....219-220

B

Ball bearing169, 171, 263, 265-267, 269, 271-273, 284
 Ball of thumb supports59
 Ball-bearing tool.....155, 161
 Base body.....109
 Battery charger138, 187
 Bearing ball.....89, 119, 123-124, 248-249
 Bearing nut.....253
 Bearing nut, hardened.....78-79, 81, 84, 86, 89, 119, 192, 204-205, 210, 216, 239, 242, 255-256, 258, 260, 317
 Bearing washer.....205
 Bearing washers.....219
 Belt pouch for remote control.....60
 Bending iron.....177, 304-305
 Bending iron set.....305
 Bending iron set small305
 Bending pusher set.....304
 Bluetooth dongle50
 Brass bushing.....81, 90, 120, 206, 210, 255, 260
 Bushing.....219, 256, 258
 Bushing for rocking locker211

C

C-Brace Cover138
 C-Brace fabrication dummy138
 C-Brace joint unit.....136, 140
 C-Brace KAFO.....134
 C-Brace lamination bar104
 C-Brace unilateral adapter plate136
 Cable cover (for adapter sets).....38, 42, 52
 Cable dummy.....187
 Calf pad.....17, 20, 22, 24, 27
 Calf pad with strap.....15
 Calibration set.....176
 Cap screw, glass bead blasted.....180
 Carbon Ankle seven.....126
 Carbon fibre foot plate.....128-130
 CarbonIQ knee joint.....234
 CarbonIQ orthotic ankle joint122
 Carrying strap for remote control43, 60

Chailey kit.....195
 Clamping sleeve.....193, 288-289
 Clinical kit/basic equipment for professionals51
 Clinician programmer connection cable.....59
 Clinician's programmer charger + adapter.....50
 Clinician's programmer kit.....50
 Component set17
 Compression spring.....84, 86, 89, 119, 123-124, 205, 210, 217, 240, 248-249
 Compression spring set.....94, 99
 Connecting cable.....186
 Control electronics186
 Correction adapter set for C-Brace137, 141
 Correction system joints310
 Cosa Active277
 Cosa Active shorts.....278
 Cosa FIT KIT.....278
 Cosa Junior276
 Cosa Junior shorts.....278
 Countersunk allen head screw236
 Countersunk head screw (allen screw)210
 Countersunk head Torx screw94, 189, 221
 Countersunk screw.....188
 Coupling piece.....206, 212
 Cover.....205, 312
 Cover for 17AT2116
 Cover for thigh cuff53
 Cylinder Pin.....123, 248

D

Diagnostic trial orthosis for C-Brace.....140
 Donning aid319
 Drive ring.....187
 Duchenne bow kit190
 Dummy cover.....95, 103
 Dummy for 17AD200100
 Dummy for 17AF10.....76
 Dummy for knee joint.....186
 Dummy set for 17KF110.....155
 Dummy set for 17KF210161
 Dummy-Kit for 17AD300 Nexgear Tango ankle.....116
 Dummy-set for 17KF100-2136
 Dummy-Set for 17KF300138
 Dummy-set for 17KL100.....226
 Dynamic unit for correction system joint312

E

E-MAG Active.....184
 E-MAG Active knee joint.....187
 Elbow joint bar with cable lock.....314
 Elbow joint bar without lock.....314
 Elbow joint bars.....314
 Electronics cable.....187
 EXOPULSE Adjustment band.....67
 EXOPULSE Belt.....66
 EXOPULSE Control unit62
 EXOPULSE Jacket kids.....62
 EXOPULSE Jacket kids, wide.....63
 EXOPULSE Jacket men64
 EXOPULSE Jacket unisex, short.....64
 EXOPULSE Jacket women.....63
 EXOPULSE Laundry bag.....67
 EXOPULSE Mollii Suit.....62
 EXOPULSE Pants kids.....64

EXOPULSE Pants kids, wide65
 EXOPULSE Pants men.....66
 EXOPULSE Pants unisex, short.....66
 EXOPULSE Pants women.....65
 Extension stop253, 255-256, 258, 261
 Extension strip.....320
 Extension wedge set for 17KF210161
 Extensor attachment plate61
 Eyelet cable anchor, large.....207

F

Fabrication set for C-Brace.....137, 141
 Fit-Kit for 17AD300116
 Fitting cable.....51
 Flat head screw170, 206, 247, 312
 Flexion stop254, 257, 259
 Flexor attachment plate.....60
 Foam pads.....178
 Foot part.....115
 Foot sensor44, 49
 Foot stirrup.....96, 125, 246
 Foot stirrup for 17AD200101
 Foot stirrup for 17AD300113
 Foot stirrup thermoplastic for 17LA3N ...96
 Foot stirrup with bearing nut and truss head screw79
 Foot stirrup, lower section182
 Foot stirrup, upper section.....181
 Forearm cuff.....320
 Forked system foot stirrup.....82
 FPL panel.....58
 FPL panel screw.....59
 Free motion ankle joint.....77
 Free motion knee joint.....152
 Free motion knee joint, posterior offset.....151
 FreeWalk orthotic system.....174
 Frontal contour bending tool177

G

Genu Neurexa54
 GoOn13
 Grub screw123-124, 234, 248-250

H

H200 Wireless57
 H200 Wireless orthosis.....57
 H200 Wireless remote control.....60
 H200 Wireless textile electrodes.....57
 Hand support rest for the Manu Neurexa plus55
 Head model.....324
 Height adjustment part29, 34-35
 Hexagon nut.....188
 Hip joint bar282-283, 288-289
 Hip joint bar with double lock285
 Hole gauge.....96, 306
 Hook-and-loop closure.....17
 Hook-and-loop strap.....179, 247
 Hydrogel electrode.....38, 42
 Hydrogel electrode adapter set, 45 mm38, 42, 51

I

Inlays.....43, 52

J

Joint centre piece254-256, 258, 260
 Joint dummy.....221

Joint nut 310
 Joint piece 268, 272
 Joint Piece with Cable Lock 315
 Joint Piece without Lock 315
 Joint protector 179
 Joint Screw 193, 204, 268

K

KAFO model 323
 Knee cap ring plate 236, 239, 243
 Knee joint bar for children 150, 192
 Knee joint bar lower part 266-267, 269
 Knee joint bar upper part 263, 269
 Knee joint bar, lower section 192
 Knee joint bar, upper section 192
 Knee joint with 4-in-1 option
 ring lock 190
 Knee joint with covered Swiss lock 201
 Knee joint with open Swiss lock 200
 Knee joint with ring lock 194, 196, 198
 Knee lever 216
 KO model 323

L

L100 Go cuff 37
 L100 Go System 37
 L300 Go System 40
 L300 Go System Plus Stand Alone 47
 L300 Go System Plus Upgrade 45
 Lamination bar 95, 114, 189, 223, 303
 Lamination dummy 95, 103, 207
 Lamination dummy cover 100
 Lamination dummy set for 17AD300 113
 Lamination dummy upper part 110
 Lateral pronation strap 21, 23, 25, 31, 33, 36
 Leg joint bar, lower section .. 263, 265, 268, 272
 Leg joint bar, lower section,
 nickel-plated 271
 Leg joint bar, upper section 265-268, 272
 Leg joint bar, upper section,
 nickel-plated 271
 Light metal profile bar 125, 235, 247, 301, 313
 Locating bolt 312
 Lock latch 316
 Lock lever 236, 238, 241
 Lock Ring -Stainless Steel 288-289
 Lock screw 263, 265-269, 271, 273
 Lock unit for battery 186
 Lock washer 216-217, 316
 Lock wedge 218
 Locked hip joint bar 286
 Locking rocker 210
 Locks, Complete (Knee Lock) 179
 Long lock lever for 17KL100 226
 Lower leg cuff 41
 Lower leg FS strap 42
 Lower leg joint bars, light duty 262, 264, 266-268
 Lower leg joint bars, medium duty 269-270, 272
 Lower leg side bar 292-297

M

Magnetic charging cable 39, 43, 46, 48
 Maintenance set for FreeWalk 179
 Malleo Neurexa pro 16
 Manu Neurexa plus 55
 Mask fixation 318

Medial joint piece 171
 Medial knee guide 176
 Medial support 189
 Medial support for correction
 system joint 313
 Modular system knee joint 203
 Morton's extension 131
 Mounting aid 176
 Mounting set for C-Brace 137, 141
 Multifunction orthotic ankle joint 92
 Multifunction system ankle joint 119
 MyActive 68
 MyActive FIT KIT 68
 MyCRO Band 321

N

Nexgear free knee 154
 Nexgear function switch 228
 Nexgear lamination bars.. 101, 166, 227, 299
 Nexgear lock knee 225
 Nexgear posterior knee 160
 Nexgear side bars 102, 167, 228, 298
 Nexgear Sixty-six ankle 99
 Nexgear Tango ankle
 Notch pin for rocking locker 211

O

Omo Neurexa plus 56
 Oval head screw 188, 236, 255, 257, 259, 261
 Oval Head Screw -St.Steel- 284
 Oval head screw, Phillips 284
 Oval head screw, slotted and partially
 threaded...169, 171, 240, 243, 253, 263, 265, 288-289, 313
 Oval head Torx screw 104

P

Pad 29, 32, 34, 36, 278
 Pad button 177
 Pad retainer bending tool 177
 Pad set for hand support rest
 for 28P31 55
 Pad set for Manu Neurexa plus 55
 Pelvic tube 279
 Perlon cable 206, 212
 Perlon cable for 17MA1 229
 Perlon cable, 0.60 m long 222
 Phillips countersunk head screw 311
 Phillips head screw 312
 Phillips oval countersunk head screw 81, 89, 127, 169, 171, 204, 206, 211, 236, 240, 311
 Plastic bushing 97
 Polycentric knee joint bars 255-256
 Polycentric knee joint bars with
 gear drive 253
 Polycentric knee joint bars,
 short 258, 260
 Positioning joint 317
 Positioning template for C-Brace
 fabrication dummy 138
 Power supply unit 139, 189
 Protective cover for remote control 44
 Protective plug 221
 Pull cable 315
 Pull-release cable 202, 240

Q

Quick fit electrode 37, 41, 52

R

Reaction-module for 17AD300 111
 Reaction-spring for 17AD300,
 extra strong 112
 Reaction-spring for 17AD300,
 strong 112
 Receptacle set 188
 Receptacle set (electronics) 188
 Remote control 44
 Replaceable battery 186
 Retainer ring for
 thrust needle bearing 282
 RGO hip joint system 279
 Ring 317
 Ring lock 193, 204
 Rivet pin 288
 Rosette washer 127
 Round textile electrode 38, 41, 52
 Rubber ring 170

S

Screw for wrist pad 59
 Screw set for C-Brace joint
 connection 137, 141
 Screw set, Phillips 242
 Screw with flattened half-round
 head 180-182, 220
 Screws for ball of thumb support 59
 Serrated lock washer 170
 Service set 92, 104, 123-124, 151-152, 187, 190, 194-198, 200-201, 234-235, 248-251, 283, 285, 287
 Service set for 17B66 120
 Service set for 17KF110 155
 Service set for 17KF210 161
 Service set for 17KL100 225
 Service set for 17SF300 113
 Service-set for 17KF100-2 and
 17KF300 137
 Serviceset for 17AD301 110
 Serviceset for 17AD303 and
 17AD304 111
 Set axial washers for 17AD300 110
 Set of mounting plates 58, 61
 Set of Stops 123, 248
 Set screw 93, 120, 124, 235, 251
 Set screw with end bore 123, 248
 Set screw with slot 84, 86, 89
 Set wheel with lever 311
 Shaping dummy set 112
 Shim plate 81, 90
 Shin pad 29, 32, 34-35
 Shoe stirrup 85, 87
 Short lock lever 238
 Shoulder screw 267
 Shrinkable tubing 280
 Side bar 95, 223, 302, 313
 Silicone scar compression glove 319
 Silicone scar compression mask and
 collar 318
 Slotted flat head screw, partially
 threaded 272
 Slotted oval head screw 282
 Slotted oval head screw
 (lock screw) 171
 Slotted oval head screw, nickel-plated
 lock screw 272
 Slotted oval head screw, partially
 threaded 271, 273
 Slotted oval head screw, partially
 threaded (ball bearing screw) 266, 269
 Slotted sheet metal cap screw 253

Slotted truss head screw..... 78-79, 81, 84, 86, 89, 119, 192, 205, 210, 239, 241-243, 253, 255-256, 258, 260, 280, 317

Small electrode adapter set, 36 mm..... 52

Small quick fit electrode..... 41, 52

Spare part set bowden cable for 17MA1.....229

Spare part set screwing93

Spare part set with screws for 17MA1.....229

Spare parts set screw connection..... 100

Special screw170

Spring..... 206, 212

Spring band steel profile bar317

Spring-loaded thrust piece.....193, 204, 288-289

Spring-module for 17AD300..... 111

Spring-tensioned measuring tape176

Stainless steel profile bar.....125, 235, 301

Standing orthosis 180

Steel cable for lock 180

Steering electrode..... 41, 53

Stimulation tester..... 53

Stimulator/EPG 39, 42, 48

Stimulator/EPG, peripher 46

Stirrup with wedge lock315

Stop pin.....249

Stop pin (small).....249

Stop-module for 17AD300..... 110

Straight Pin 120, 124

Strap cover, lower leg cuff.....43, 51

Strap cover, thigh cuff 46, 48, 53

Strap guide loop for pad button178

Strap guide loop with tube connection..178

Strap holder for thigh cuff 46, 48, 53

Strap piece.....17

System ankle joint 80, 88

System charger with charging adapters..... 39, 43

System extension assist..... 169

System foot stirrup82-83, 85, 87, 90, 120-121

System foot stirrup, double-sided shoe stirrup..... 121

System hip joint.....284

System knee joint..... 168, 171, 205, 209, 236-237, 241

System knee joints238

System lamination bar..... 207, 213, 300

System lamination bar with contoured calf..... 207, 213, 300

System lamination foot stirrup..... 82, 90-91

System shoe plate, hardened..... 83, 85, 87, 91, 121

System shoe stirrup 82

System side bar set.....207-208, 213-214, 292-293, 295-297

System side bar set, extra long.....208, 214, 294

T

Temporary switch..... 222

Tension band.....176

Test brace for 17AD300..... 115

Test brace set for 17AD300..... 115

Textile electrode adapter set, 45 mm 38, 42, 51

Textile electrode for thigh, central.....46, 48

Textile electrode for thigh, offset45, 47, 53

ThermoLyn PP-H..... 247

Thigh bar.....280

Thigh bars..... 273

Thigh cuff..... 45, 47

Thigh side bar 292-297

Thigh strap incl. buckles.....46, 48

Threaded plate..... 181

Threaded sleeve..... 206, 212, 222

Thrust needle bearing.....282

Thrust piece with ball.....84, 86, 89

Tool kit static alignment 112

Tool set for dynamic adjustment..... 114

Torso bar.....280

Torso model324

Triple control 180

Two-hole nut.....282

Two-hole screw282

U

Ultra-module for 17AD300 111

Ultra-spring for 17AD300..... 112

Unilateral C-Brace ankle joint103, 136

Unilateral knee joint215

Unilateral system ankle joint.....93, 136

W

WalkOn 22

WalkOn FIT KIT..... 23, 25

WalkOn Flex.....19

WalkOn Flex FIT KIT.....21

WalkOn Flex Junior FIT KIT.....21

WalkOn Lateral26

WalkOn Lateral FIT KIT 27

WalkOn Lateral Junior FIT KIT 27

WalkOn Reaction31

WalkOn Reaction FIT KIT 32

WalkOn Reaction junior 35

WalkOn Reaction junior FIT KIT36

WalkOn Reaction lateral..... 28

WalkOn Reaction Lateral FIT KIT 30

WalkOn Reaction Lateral Junior FIT KIT 30

WalkOn Reaction plus..... 33

WalkOn Reaction plus FIT KIT.....34

WalkOn Trimable 24

Washer set 311

Waterproof CarbonIQ knee joint246

Waterproof CarbonIQ orthotic ankle joint246

Wedge..... 180

Wedge lock, hardened.....206, 210

Welding nut.....127

Workshop trolley325

Wrist loop 58

Wrist loop for remote control..... 60

Wrist pad 58

Wrist pad covers..... 58

X

X-ible..... 76

Y

Y-hook-and-loop13, 20, 27, 29, 32, 34, 36, 116

Y-hook-and-loop with PU coating178

1–10

4A101.....	219-220
4E50-3.....	138, 187
4Z80.....	205
7A1.....	263, 269
7A10.....	265-268, 272
7A11.....	271
7A14.....	265-268, 272
7A3.....	265-268, 272
7A5.....	263, 269
7A6.....	265-268, 272
7A9.....	265-268, 272
7B10.....	263, 265, 268, 272
7B13.....	271
7B3.....	266-267, 269
7B4.....	266-267, 269
7B5.....	263, 265, 268, 272
7B7.....	266-267, 269
7B8.....	263, 265, 268, 272
7G3.....	273
7U10.....	269-270, 272
7U15.....	269-270, 272
7U2.....	269-270, 272
7U25.....	269-270, 272
7U27.....	262, 264, 266-268
7U30.....	262, 264, 266-268
7U32.....	262, 264, 266-268
7U33.....	262, 264, 266-268
7U42.....	262, 264, 266-268
7U43.....	262, 264, 266-268
7U46.....	262, 264, 266-268
7U56.....	253
7Y12.....	268, 272
7Y13.....	268, 272
7Y19.....	171

11–20

16X12.....	314
16X13.....	314
16X14.....	314
16X4.....	316
16Y26.....	315
16Y27.....	315
16Y31.....	315
16Y7.....	316
16Y8.....	216-217, 316
17A3.....	78-79
17A4.....	78-79
17AD1.....	92
17AD200.....	99
17AD200A.....	100
17AD200S.....	100
17AD300.....	109
17AD301.....	110
17AD302.....	111
17AD303.....	111
17AD304.....	111
17AD305.....	112
17AD306.....	112
17AD307.....	112
17AD308.....	112
17AD309.....	114
17AD310.....	112
17AD312.....	113
17AD313.....	113
17AD314.....	110
17AD315.....	110
17AD316.....	113
17AD317.....	111
17AD318.....	110
17AF10.....	76
17AF10A.....	76

17AF2.....	77
17AO100.....	103, 136
17AO100S92, 104, 123-124, 151-152, 187, 190, 194-198, 200-201, 234-235, 248-251, 283, 285, 287	
17AS=19...92, 104, 123-124, 151-152, 187, 190, 194-198, 200-201, 234-235, 248-251, 283, 285, 287	
17AT1.....	115
17AT2.....	115
17AT3.....	116
17AT4.....	116
17B100.....	82, 90-91
17B101.....	82, 90-91
17B102.....	292-297
17B104.....	292-297
17B105.....	168, 171, 205, 209, 236-237, 241
17B107.....	85, 87, 91
17B108.....	82-83, 85, 87, 90, 120-121
17B113.....	82-83, 85, 87, 90, 120-121
17B114.....	82-83, 85, 87, 90, 120-121
17B115.....	82-83, 85, 87, 90, 120-121
17B116.....	121
17B20.....	203
17B203.....	184
17B206.....	189
17B21.....	203
17B23.....	168, 171, 205, 209, 236-237, 241
17B23K.....	168, 171, 205, 209, 236-237, 241
17B26.....	168, 171, 205, 209, 236-237, 241
17B3.....	168, 171, 205, 209, 236-237, 241
17B33.....	168, 171, 205, 209, 236-237, 241
17B38..	207-208, 213-214, 292-293, 295-297
17B39..	207-208, 213-214, 292-293, 295-297
17B4.....	292-297
17B40..	207-208, 213-214, 292-293, 295-297
17B41.....	208, 214, 294
17B42.....	203
17B43.....	168, 171, 205, 209, 236-237, 241
17B44.....	168, 171, 205, 209, 236-237, 241
17B45.....	168, 171, 205, 209, 236-237, 241
17B46.....	168, 171, 205, 209, 236-237, 241
17B47.....	168, 171, 205, 209, 236-237, 241
17B5.....	292-297
17B53.....	80, 88
17B55.....	82-83, 85, 87, 90, 120-121
17B57.....	80, 88
17B58.....	85, 87, 91
17B59.....	80, 88
17B6.....	292-297
17B60.....	82
17B62.....	80, 88
17B63.....	80, 88
17B64.....	82-83, 85, 87, 90, 120-121
17B65.....	82-83, 85, 87, 90, 120-121
17B66.....	119
17B66=S.....	120
17B7.....	292-297
17B70.....	317
17B71.....	168, 171, 205, 209, 236-237, 241
17B82.....	284
17B84.....	207-208, 213-214, 292-293, 295-297
17B85.....	207-208, 213-214, 292-293, 295-297
17B86.....	292-297
17B87.....	292-297
17B88.....	292-297
17B89.....	292-297
17B91.....	168, 171, 205, 209, 236-237, 241
17B92.....	238
17B95.....	168, 171, 205, 209, 236-237, 241
17B96.....	168, 171, 205, 209, 236-237, 241
17B99.....	82, 90-91

17BK1.....	310
17BK1=S.....	311
17BK2.....	312
17BK3.....	313
17BS203.....	92, 104, 123-124, 151-152, 187, 190, 194-198, 200-201, 234-235, 248-251, 283, 285, 287
17C3.....	79
17C4.....	78, 104
17CF1.....	126
17F24.....	78-79
17F31.....	84, 86
17F32.....	84, 86
17F33.....	85, 87
17F34.....	78-79
17F35.....	83, 85, 87, 91, 121
17F36.....	82
17F52.....	95, 223, 302, 313
17H100.....	279
17H23.....	282-283, 288-289
17H28.....	282-283, 288-289
17H34.....	282-283, 288-289
17HF1.....	282-283, 288-289
17HL1.....	286
17HL4.....	286
17HL5.....	285
17K29.....	150, 192
17K32.....	150, 192
17K33.....	150, 192
17K43.....	255-256
17K45.....	255-256
17K46.....	258, 260
17K47.....	258, 260
17KF1.....	152
17KF10.....	151
17KF102.....	136
17KF103.....	137
17KF110.....	154
17KF111.....	155
17KF112.....	155
17KF113.....	155, 161
17KF210.....	160
17KF211.....	161
17KF212.....	161
17KF213.....	161
17KF300.....	136
17KF301.....	138
17KHS=2.....	92, 104, 123-124, 151-152, 187, 190, 194-198, 200-201, 234-235, 248-251, 283, 285, 287
17KHS=3.....	92, 104, 123-124, 151-152, 187, 190, 194-198, 200-201, 234-235, 248-251, 283, 285, 287
17KL100.....	225
17KL101.....	225
17KL102.....	226
17KL103.....	226
17KL19.....	190
17KL20.....	201
17KL30.....	200
17KL40.....	190
17KL6.....	194, 196, 198
17KL7.....	194, 196, 198
17KL8.....	194, 196, 198
17KL9.....	194, 196, 198
17KO1.....	136, 140
17KO1000=0_B.....	134
17KO1A=*-SET1-.....	137, 141
17KO1A=SET.....	137, 141
17KO1A=SET-1.....	137, 141
17KO1A=SET-2.....	137, 141
17KS=1.....	92, 104, 123-124, 151-152, 187, 190, 194-198, 200-201, 234-235, 248-251, 283, 285, 287

17KS=10	92, 104, 123-124, 151-152, 187, 190, 194-198, 200-201, 234-235, 248-251, 283, 285, 287
17KS=11	92, 104, 123-124, 151-152, 187, 190, 194-198, 200-201, 234-235, 248-251, 283, 285, 287
17KS=14	92, 104, 123-124, 151-152, 187, 190, 194-198, 200-201, 234-235, 248-251, 283, 285, 287
17KS=16	92, 104, 123-124, 151-152, 187, 190, 194-198, 200-201, 234-235, 248-251, 283, 285, 287
17KS=18	92, 104, 123-124, 151-152, 187, 190, 194-198, 200-201, 234-235, 248-251, 283, 285, 287
17KS=4	92, 104, 123-124, 151-152, 187, 190, 194-198, 200-201, 234-235, 248-251, 283, 285, 287
17KS=6	92, 104, 123-124, 151-152, 187, 190, 194-198, 200-201, 234-235, 248-251, 283, 285, 287
17KS=7	92, 104, 123-124, 151-152, 187, 190, 194-198, 200-201, 234-235, 248-251, 283, 285, 287
17KS=8	92, 104, 123-124, 151-152, 187, 190, 194-198, 200-201, 234-235, 248-251, 283, 285, 287
17KS=9	92, 104, 123-124, 151-152, 187, 190, 194-198, 200-201, 234-235, 248-251, 283, 285, 287
17KT1	140
17LA32N	93
17LA33N	94, 104
17LA34N	94, 99
17LA35N	94, 99
17LA3N	93, 136
17LD1N	95, 103, 207
17LD1N=*-P	95, 103
17LF31N	96
17LF3N	96, 125, 246
17LK3	215
17LS3	95, 114, 189, 223, 303
17LV3	95, 223, 302, 313
17MA1	228
17MA2	229
17MA3	229
17MA4	229
17MK1=2	325
17MS30	202, 240
17PA1	122
17PA1=*-WR	246
17PF1	96, 125, 246
17PK1	234
17PK1=*-WR	246
17S100	104
17SB100	102, 167, 228, 298
17SF100=OS*	78, 104
17SF200	101
17SF300	113
17SL100	101, 166, 227, 299
17U7	192
17X7	192
17Y104	238
17Y121	205, 312
17Y122	206, 210
17Y123	170, 206, 247, 312
17Y126	95, 103, 207
17Y127	254-256, 258, 260
17Y128	207, 213, 300
17Y129	207, 213, 300
17Y13	193, 204
17Y130	279
17Y131	280
17Y132	280
17Y140	279
17Y142	280
17Y143	280
17Y156	218
17Y157	218
17Y158	218
17Y162	222
17Y17	81, 90, 120, 206, 210, 255, 260
17Y18	84, 86, 89
17Y20	236, 238, 241
17Y31	193, 204
17Y32	169
17Y34	236, 238, 241
17Y35	169
17Y42	81, 90
17Y50	282
17Y56	236, 239, 243
17Y57	236, 238, 241
17Y63	254-256, 258, 260
17Y67	253
17Y74	253, 255-256, 258, 261
17Y78	254, 257, 259
17Y80	84, 86, 89
17Y84	236, 239, 243
17Y88	206, 210
17Y89	211
17Y90	253, 255-256, 258, 261
17Y91	254, 257, 259
17Y92	254-256, 258, 260
17Y93	78-79, 81, 84, 86, 89, 119, 192, 204-205, 210, 216, 239, 242, 255-256, 258, 260, 317
17Y97	242
17Z49	282
18Z1	170
18Z2	170
18Z3	317
21-35	
21A12	206, 212, 222
21A18	206, 212
21A25	206, 212
21A45	222
21A5	207
21A7	206, 212
21Y79	315
24H1	321
28FS100	37
28FS100S	37
28FS300	40
28FS300=CLINICKIT	51
28FS300=PROGRAMMER	50
28FS300A	44, 49
28FS300A-LG4-5201	44
28FS300A=LG3-5K00	44, 49
28FS300A=LG4-5200	44
28FS300S	37, 41, 52
28FS300S=20-0004	53
28FS300S=20-0005	43, 60
28FS300S=LG3-4900	51
28FS300S=LG3-4A00	43, 51
28FS300S=LG3-5L00	38, 42, 52
28FS300S=LG3-6500	52
28FS300S=LG4-4U00	38, 42, 51
28FS300S=LG4-5300	39, 42, 48
28FS300S=LG4-5E00	38, 42, 51
28FS300S=LG4-7100	39, 43, 46, 48
28FS300S=LG4-7200	39, 43
28FS300S=LG4-BT01	50
28KS300	45
28KS300S	45, 47
28KS300S=L3P-5D00	45, 47, 53
28KS300S=L4P-4A00	46, 48, 53
28KS300S=L4P-5300	46
28KS300S=L4P-5D00	46, 48
28KS300S=L4P-8200	46, 48, 53
28KS310	47
28L100	276
28L101	277
28LT1	278
28P30	55
28P31	55
28PS200	57
28PS200A	60
28PS200A=20-0005	43, 60
28PS200A=20-0007	60
28PS200A=H2W-5600	60
28PS200A=LG3-5H00	60
28PS200S	57
28PS200S=20-0014	50
28PS200S=H2W-5D00	57
28PS200S=HR2-4C00	59
28PS200S=HR2-5K00	58
28T16	27
28T1N	23, 25
28T2	21
28T3	32
28T4	34
28T5	36
28T6	27
28T7	30
28T8	30
28T9	21
28U11	22
28U22	19
28U23	24
28U24	31
28U25	33
28U33	26
28U34	28
28U50	16
28U70	13
28U90	14
28XP1	62
28XP10	64
28XP11	66
28XP2	62
28XP3	64
28XP4	63
28XP5	65
28XP6	63
28XP7	65
28XP8	64
28XP9	66
28Z10	21, 23, 25, 31, 33, 36
29F209	115
29L100	278
29L101	278
29L102	29, 32, 34, 36, 278
29P31	55
29P32	55
29PA1	92, 104, 123-124, 151-152, 187, 190, 194-198, 200-201, 234-235, 248-251, 283, 285, 287
29PK1	92, 104, 123-124, 151-152, 187, 190, 194-198, 200-201, 234-235, 248-251, 283, 285, 287
29PK2	92, 104, 123-124, 151-152, 187, 190, 194-198, 200-201, 234-235, 248-251, 283, 285, 287
29PK4	123-124, 234-235, 248-251
29S1	17
29S2	17
29S24	17, 20, 22, 24, 27
29U22	29, 34-35
29U23	29, 32, 34-35
29U24	29, 32, 34, 36, 278

29U25.....	13, 20, 27, 29, 32, 34, 36, 116
29U34.....	17
29U39.....	17, 20, 22, 24, 27
29U45.....	17, 20, 22, 24, 27
29U46.....	29, 32, 34, 36, 278
29U90.....	15
29U91.....	116
29XP2.....	66
29XP4.....	67
29XP5.....	67
29Y27.....	312
30G70.....	187
30G79.....	123, 248
30Y140.....	187
30Y156.....	310
30Y183.....	205, 312
30Y192.....	312
30Y212.....	311
30Y265.....	216
30Y268.....	221
30Y289.....	123, 248
30Y306.....	97
30Y309.....	93, 120, 124, 235, 251
30Y349.....	93, 120, 124, 235, 251
30Y438.....	187
30Y87.....	219, 256, 258
30Y91.....	221
30Z22.....	210

36–89

8165.....	54
88BH1.....	319
88BH1=AH.....	319
88BH1=B.....	320
88BH1=E.....	320
88M10.....	318
88M2.....	318

100–499

130M1.....	322
131X1.....	138
170D100.....	178
170D18.....	178
170D20.....	178
170D28.....	181
170D29.....	178
170D30.....	176
170D33.....	181
170D69.....	177
170D71.....	180
170D73.....	180
170D83.....	180
170F14.....	181
170F15.....	182
170K1.....	174
170W11.....	177
170W12.....	177
170W13.....	177
170W14.....	176
170W18.....	177, 304–305
170W23.....	176
170W4.....	176
170X17N.....	181
170X18.....	179
170Z120.....	179
170Z4.....	179, 247
170Z93.....	219
170Z96.....	180
170Z99.....	179
317B20.....	186
317B3.....	186
317E2.....	187

317E20.....	186
317L20.....	138, 187
317R20.....	186
317X203.....	186
317Z13.....	188
317Z21.....	188

500–599

501A11.....	169, 171, 240, 243, 253, 263, 265, 288–289, 313
501A12.....	267
501A21.....	169, 171, 240, 243, 253, 263, 265, 288–289, 313
501A22.....	271, 273
501A23.....	188, 236, 255, 257, 259, 261
501A24.....	272
501A25.....	266, 269
501A29.....	169, 171, 240, 243, 253, 263, 265, 288–289, 313
501A32.....	193, 204, 268
501A6.....	169, 171, 240, 243, 253, 263, 265, 288–289, 313
501B5.....	253
501D1.....	193, 204, 288–289
501F9.....	180–182, 220
501S10.....	272
501S136.....	104
501S137.....	94, 189, 221
501S21.....	188
501S22.....	171
501S32.....	78–79, 81, 84, 86, 89, 119, 192, 205, 210, 239, 241–243, 253, 255–256, 258, 260, 280, 317
501S34.....	193, 204, 268
501S41.....	210
501S42.....	188, 236, 255, 257, 259, 261
501S43.....	170, 206, 247, 312
501S47.....	282
501S55.....	236
501S57.....	78–79, 81, 84, 86, 89, 119, 192, 205, 210, 239, 241–243, 253, 255–256, 258, 260, 280, 317
501S6.....	263, 265–269, 271, 273
501S72.....	188, 236, 255, 257, 259, 261
501S79.....	170
501S84.....	170, 206, 247, 312
501S86.....	81, 89, 127, 169, 171, 204, 206, 211, 236, 240, 311
501T19.....	311
501T7.....	81, 89, 127, 169, 171, 204, 206, 211, 236, 240, 311
502E3.....	127
502S27.....	188
5065N.....	56
506A12.....	288
506A27.....	249
506A5.....	249
506A8.....	120, 124
506G21.....	123–124, 234, 248–250
506G3.....	93, 120, 124, 235, 251
506G36.....	123–124, 234, 248–250
506K2.....	211
506S1.....	193, 288–289
507S11.....	170
507S96.....	216–217, 316
507U9.....	127
509K11.....	169, 171, 263, 265–267, 269, 271–273, 284
509K12.....	169, 171, 263, 265–267, 269, 271–273, 284
509K15.....	169, 171, 263, 265–267, 269, 271–273, 284
509N3.....	282

509N4.....	282
509Y1.....	89, 119, 123–124, 248–249
509Y2.....	89, 119, 123–124, 248–249
513D18.....	84, 86, 89, 119, 123–124, 205, 210, 217, 240, 248–249
513D19.....	84, 86, 89, 119, 123–124, 205, 210, 217, 240, 248–249
513D83.....	84, 86, 89, 119, 123–124, 205, 210, 217, 240, 248–249
513D87.....	84, 86, 89, 119, 123–124, 205, 210, 217, 240, 248–249

600–699

605P8.....	125, 235, 247, 301, 313
616T*.....	247
616Z9.....	280
623Z39.....	17, 20, 22, 24, 27
651B1.....	317
651P4.....	125, 235, 301
654K1 654K2.....	68
654K3.....	68

700–799

702B11.....	96, 306
702B13.....	96, 306
702B9.....	96, 306
710H10.....	311
711S1.....	177, 304–305
711S13.....	305
711S14.....	305
711S2.....	304
711S3.....	177, 304–305
711S4.....	177, 304–305
711S5.....	177, 304–305
743B4.....	176
743Y57.....	92, 151, 153, 191, 195, 197, 199–200, 202, 283, 285, 287
757L16–4.....	139, 189
799A1.....	138
799Y17.....	138

A–Z

IP3121.....	322
IP3131.....	323
IP3141.....	323
IP3211.....	324
IP3221.....	324
SL=AL.....	128–130
SL=AR.....	128–130
SL=CFP.....	128–130
SL=F.....	128–130
SL=HAL.....	128–130
SL=HAR.....	128–130
SL=ME.....	131
SL=MEL.....	131

