

Service Fabrication

Customized Solutions

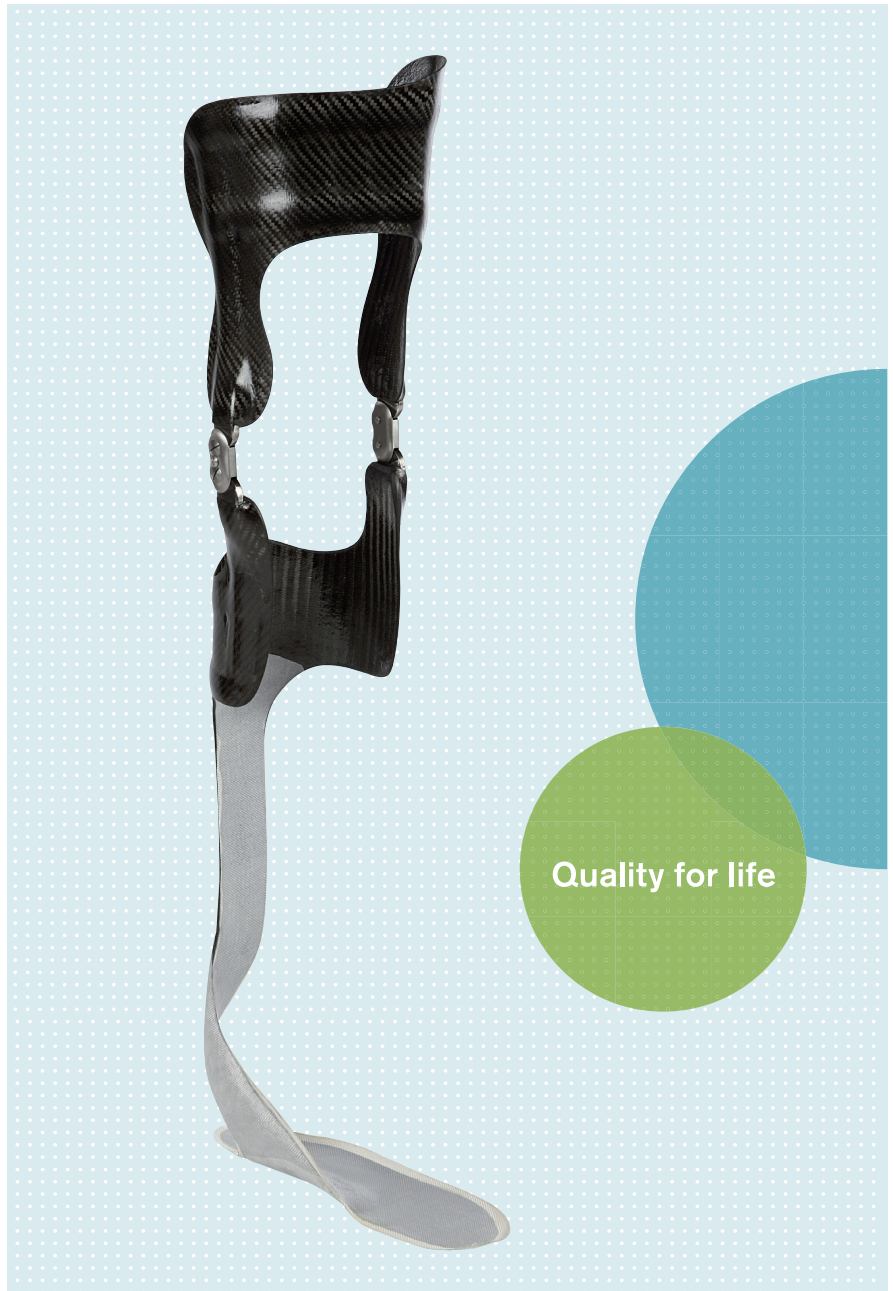

Service Fabrication

Customized Solutions

1	1 About this Catalogue	4
	1.1 Ottobock Today: A Changing Company	4
	1.2 Ottobock Service Fabrication	5
	1.3 Customer Service	6
	1.4 Quality Assurance	7
	1.5 Explanation of Symbols	8
2	2 Prosthetics – Lower Limbs	10
	2.1 TF Design Sockets	12
	2.2 TT Design Sockets	24
	2.3 SiOCX TF Socket for Transfemoral Amputations	32
	2.4 Definitive Sockets for the Lower Limbs	42
	2.5 Copying Prosthetic Sockets in Wood	48
	2.6 Customised Silicone Liners for the Lower Limbs	54
	2.7 Custom Silicone Gel Liner for the Lower Limbs	62
	2.8 Polyurethane Custom Liner for the Lower Limbs	68
	2.9 Aqualine Cover	76
	2.10 Cosmetic Foam Covers	82
	2.11 Coating with SuperSkin	88
	2.12 Customised Silicone Covers for the Lower Limbs	94
	2.13 Silicone Forefoot Prostheses	106
	2.14 Silicone Toe Prostheses	118

1

2

3

4

3	Prosthetics - Upper Limbs	130
3.1	PAULA Check Sockets for Transradial Amputations	132
3.2	SiOCX TR Socket for Transradial Amputations	138
3.3	Customised Silicone Liners for the Upper Limb	146
3.4	Custom Silicone Covers for Passive Hand Systems	154
3.5	Silicone Partial Hand Prostheses	166
3.6	Silicone Finger Prostheses	178
4	Orthotics	190
4.1	Malmö Orthoses	192
4.2	Free Walk Orthoses	202
4.3	Silicone Orthoses for the Upper Limbs	212
4.4	Custom Joint Bars	218

1

2

3

4

1



"Our objective is to offer maximum mobility, independence and normality to people with physical disabilities. User functionality is therefore the most important criterion standard for our products."

Prof. H. G. Näder,
President and CEO

2

A Changing Company

The name Ottobock has stood for technology, innovation, quality and customer orientation for more than 90 years. Driven by a pioneering spirit, courage and decisiveness, the prosthetist Otto Bock founded Otto Bock Orthopädische Industrie GmbH in Berlin in 1919. He had the courage to break new ground and set higher standards which would revolutionise an entire industry. Under the leadership of Dr. Max Näder, Ottobock became a company of international standing. Thanks to his creativity and inventive talent, Max Näder continued to set standards in orthopaedic technology with the development of products such as the modular leg prosthesis system or myoelectric arm prosthesis. The company began to establish an international sales structure in 1958, when the first foreign subsidiary was founded. After years of consistent and dynamic expansion, Ottobock is now a true global player and a strong corporate brand. Today our name stands for high-quality, functional and technologically outstanding products and services in orthopaedic and rehabilitation technology around the world. Whatever we do, people are always our number one priority; we are committed to helping them achieve maximum mobility, independence and normality.

Ottobock HealthCare is a modern, customer and success-oriented company with a long-standing tradition – a global player with local roots. With 45 sales and service companies and export activities in over 140 countries around the world, we are constantly in close contact with our customers. Thanks to this intimate relationship with the market, we understand user needs and customer requirements and integrate them into the products we develop. While we are confident that we have created a sustainable organisation with our global network of development, manufacturing and production sites, we remain committed to Germany and the local roots of our company. Duderstadt, located in Germany's Eichsfeld region, is not only where our largest development and production sites are situated, it is also home to the Ottobock HealthCare headquarters.

We will continue to use our experience and expertise responsibly to improve the quality of life of disabled people by providing functional and technologically outstanding solutions in the future. "Quality for life – made by Ottobock".

3

4

Ottobock Service Fabrication

The cornerstones of our success are close, friendly relations with our customers and the continuous search for new and better ways to improve patients' quality of life. Products today are manufactured, maintained or adjusted to the needs of the patient with the aid of computers. However, these added options also increase the complexity of the products and therefore the demands placed on technicians. Moreover, the demands made on technicians are increasing due to changing market situations. Increasing competition, the growing effort required for documentation and pressure to reduce costs are only some of the current buzzwords used to describe the market.

You as a prosthetist or orthotist are being increasingly confronted by demands extending beyond immediate patient care. Ottobock would like to support you with innovative and customised solutions. Ottobock offers services that allow you to once again focus on your work – providing direct patient fittings and care.

In Service Fabrication, we offer customised products and services from the following segments:

- Prosthetics
- Orthotics
- Seating Shell Fittings (see Custom Seating catalogue: 646K29=GB)

Simple ordering procedures as well as prompt, reliable and speedy delivery are the prerequisites for a trouble-free, on-site fitting and thus important facets of our work. Exact measurement procedures and intelligent ordering systems ensure the efficient and quick exchange of information and data. The application of these intelligent technologies combined with the use of new and proven materials mark the quality of our services.

Take advantage of the experience of our prosthetists/orthotists and our staff in R&D, manufacturing and sales locations worldwide and reap the benefits of our services. With our help, focus once again on your core competence – providing fittings and patient care.

We give you the support you need so we can accomplish our common vision: Quality for Life.



We give you the support you need so we can accomplish our common vision: Quality for Life.

1

2

3

4

Customer Service



At Ottobock, we place great emphasis on CUSTOMER SERVICE. Our competent partners assist you with their comprehensive technical expertise, inform you about the latest developments and consult you in all matters concerning our products. For more complex enquiries, our product experts and specialists in fabrication are there to help you. Our highly qualified team of field service employees can assist with special technical solutions and their on-site implementation. We also offer comprehensive service concepts.

Visit www.ottobock.com to obtain up-to-date product information at any time.

1

2

3

4

Quality Assurance

Quality products are the hallmark of Ottobock. In an effort to not only maintain but also continuously improve our quality standards, we have implemented a process for quality improvement based on a written Quality Management System (QMS).

The QMS covers much more than the fabrication of individual products. It also serves as the foundation for all phases of research and development, design, production and customer service.

This is especially important for prosthesis components. After all, quality is strongly associated with trust, safety and reliability.

Ottobock's high quality level has been tested and certified according to the international DIN EN ISO 13485 standard by the "Deutsche Gesellschaft zur Zertifizierung von Qualitäts-Management-Systemen" (German Association for the Certification of Quality Management Systems). This certification is internationally recognised.

Ottobock Service Fabrication has also earned the QVH seal of approval.



1

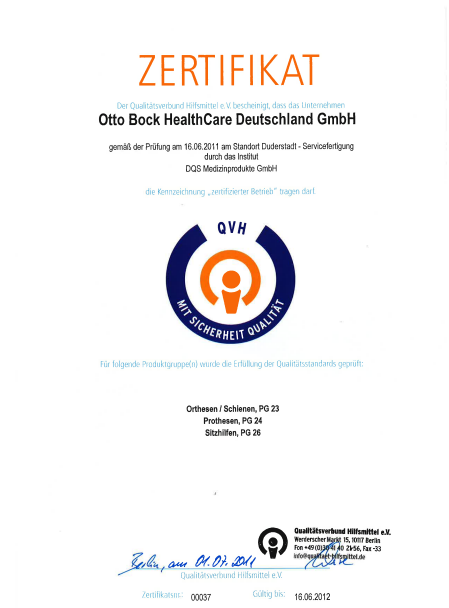

2

3

4



Take measurements



Determine colours

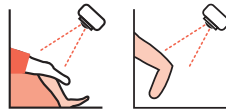

Take photos of the patient



Fill in the measurement
or order form



Enter data into the computer



Transfer data by e-mail

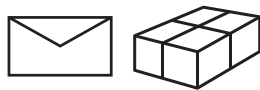

Send orders by mail, fax
or parcel post

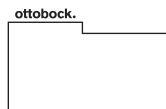

Service at Ottobock



Shipment to customers

1

2

3

4

A large grid of dots for taking notes, consisting of approximately 30 columns and 40 rows of small, evenly spaced dots.

1

2

3

4

1

2

3

4



1

Prosthetics – Lower Limbs

2

3

4

1

2

3

4



TF Design Sockets

TF Design is a modern application technique for the individual fabrication of check sockets and transfemoral interim prostheses. It represents an outstanding alternative to the classic plaster casting technique.

Ottobock TF Design offers the prosthetist two options for socket design and ordering. For one, the check socket can be ordered using the measurement form or TF Design software can also be used.

The advantage of the software is that the prosthetist can edit and visualise all data for a check socket or interim socket in a single process. After the modifications are complete, the data are saved and sent directly to Ottobock Service Fabrication by e-mail. A socket made of ThermoLyn is fabricated by Ottobock according to the data specified by the prosthetist. If ordered, the selected components will be pre-assembled and sent to the prosthetist for trial fitting.

Description of Socket Shapes

1



SIT-Cast contoured

Pronounced oval socket shape with steep ischial containment.

2



SIT-Cast medium

Characteristic, oval socket shape. Compared to the SIT-Cast contoured, the ischial containment is somewhat more exposed here.

3



SIT-Cast feminine contoured

Characteristic, high oval contour adapted to the larger female pubic bone angle.

4

Anatomica

Compared with the conventional high oval socket shape, the lower front and rear socket brim offer greater freedom of movement with enhanced wearing and sitting comfort. The ischial containment is positioned further anterior, with the dorsal end at the ischial tuberosity.

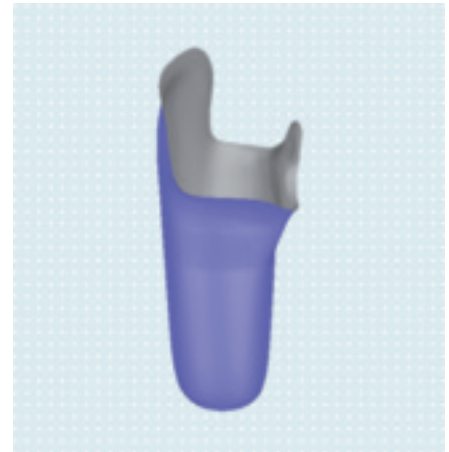

1

Quadrilateral contoured

Pronounced quadrilateral socket shape. The ischium is supported and the frontal pad serves as a counter-support.

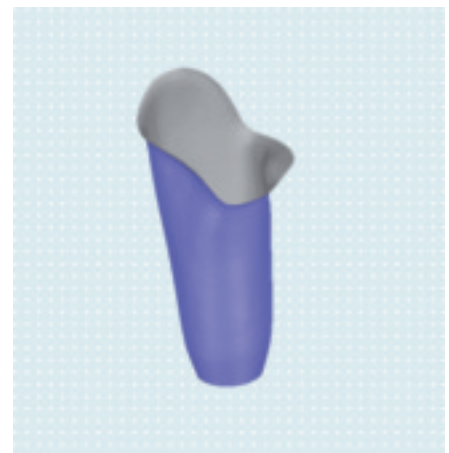

2

Quadrilateral medium

Quadrilateral socket shape with ischium support. Compared to the contoured quadrilateral shape, the frontal pad and ischium support are significantly less contoured. This socket shape was optimised for quadrilateral liner fittings.

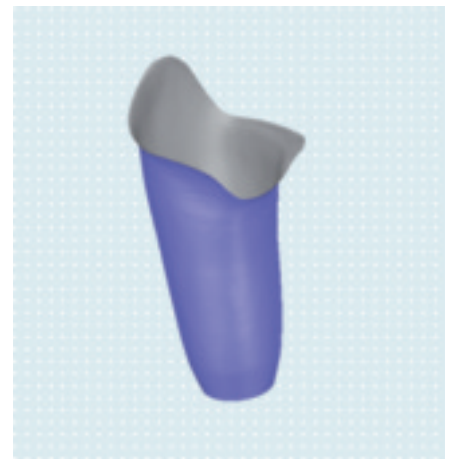

3

4

1



Quadrilateral feminine contoured

Pronounced quadrilateral socket shape. Compared with the contoured quadrilateral shape, the frontal pad and ischium support are somewhat less contoured in the feminine form.

2



Hybrid

Mixed form of the ischial containment and quadrilateral socket principles. The basic shape is high oval. However, the medial socket brim provides ischial support for partial load transfer in addition to medial support.

3

4

Description of the SF Adapters and Shuttle Locks

SF5R10 Vacuum forming adapter

The SF5R10 socket adapter is intended for check sockets made of ThermoLyn clear and ThermoLyn rigid. It is suitable for fittings without a liner, or fittings with a liner but without a connection.



1

SF5R11 Vacuum forming adapter with receiver for shuttle lock

The SF5R11 socket adapter is intended for check sockets made of ThermoLyn clear and ThermoLyn rigid. It is suitable for fittings with a liner and a pin. It is combined with the 6A20=* ratchet unit. Use the 4Y380 adapter for the connection to the prosthesis.



2

SF6A60 Vacuum forming adapter with ratchet unit

The SF6A60 socket adapter is intended for check sockets made of ThermoLyn clear and ThermoLyn rigid. It is suitable for fittings with a liner and a pin. Unlike the SF5R11, the ratchet unit is integrated.



3

6A30=10 Shuttle Lock

- Coartier aluminium housing
- Easy to unlock ratchet unit, even under tensile load
- Continuously variable locking mechanism for secure support
- Adjustable: engages silently or audibly



6A30=20 Shuttle Lock

- Serrated pin
- Lightweight plastic housing, therefore suitable for use in bathing prostheses
- Easy to unlock ratchet unit, even under tensile load
- Continuously variable locking mechanism for secure support
- Adjustable: engages silently or audibly



4

To take the residual limb measurements, you require the 743S10 Calliper and the 743B4 Spring-Loaded Measuring Tape. More information on using the tools is found on the back of the measurement form for a customised transfemoral check socket. If you want to use the Ottobock TF Design software instead of the measurement form, you can order it under reference number 647X6.

When purchasing the TF and TT design case (743R9), the tools mentioned here and the software are included in addition to other tools.

1

Tools

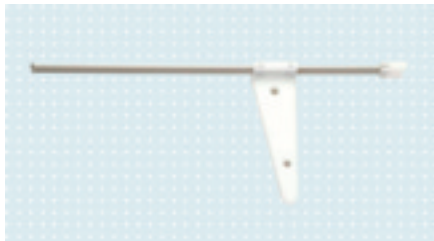

743S10 Callipers

2



743S20 Callipers

3



743B4 Spring-tensioned measuring tape

Measuring tape with spring balance

4



647X6 Ottobock TF Design software

743R9 TF and TT Design case

- 2 residual limb socks
- 1 calibrator for TT Design
- 1 knee angle
- 1 TT design software
- 1 TF design software
- 1 calliper for TF design
- 1 spring-tensioned measuring tape
- 1 calliper
- 1 digital camera
- 1 black photo background
- 1 red felt-tip pen
- 100 adhesive hook and loop dots
- 1 angle gauge



1

2

3

4

Information on the Ordering Process

1

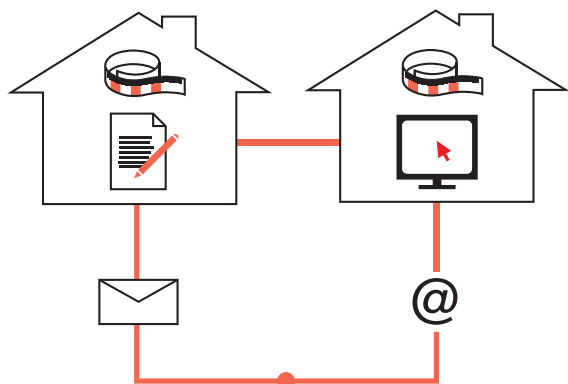

Measure the patient's residual limb (please note the information on the back of the measurement form or the corresponding section in the 647H374 Instructions for Use of the 647X6 Ottobock TF Design Software). Then enter the measurements on the measurement form or in the software, specifying the socket shape and design which you can verify and, if required, modify on the 3D model in the software.

Please save the order and send the data to Ottobock Service Fabrication by e-mail. When using the measurement form, it is best to send it to us by fax. You may order any prosthesis components and additional services you need at the same time.

2

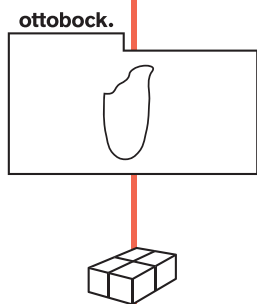

Ottobock Service Fabrication will fabricate the TF Design socket for you, and usually ships it within 1 working day. If the data are received by 12 noon, shipment is on the same working day.

3

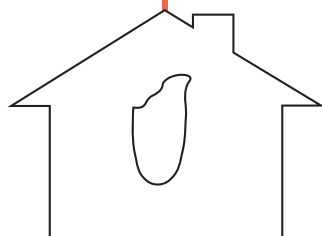

You receive a check socket which meets your specifications precisely thanks to highly modern software.

 646D329 (Information for Practitioners "TF Design Check Sockets")

 647H374 (Instructions for Use
647X6 Ottobock TF Design Software)

4

When working on jobs using the Ottobock TF Design software (647X6), you go through three program stages, each of which has a tab in the TF Design processing window:

1. Order Details

Selection of the socket-specific data and entry of the patient measurements.



1

2. Socket Design

Three-dimensional view of the prosthetic socket, with the option to make corrections.

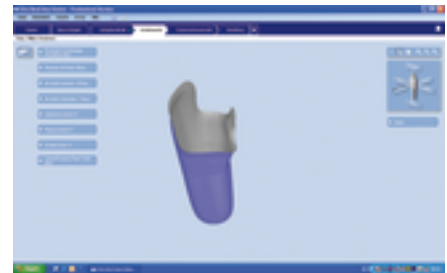

2

3. Order

Display and processing of the purchase order for the current job.



3

4

TF Design Check Socket

Measurement form

1

Contact	Customer number	Date
Customer		Shipping address (if different from customer address)
Company	Company	
Street	Street	
Postal code/city	Postal code/city	
Email	Phone	
Patient ID		

2

Side: Left Right

Configuration

Socket type:

SIT-Cast contoured Crosswise oval contoured

SIT-Cast medium Crosswise oval contoured medium

SIT-Cast feminine contoured Crosswise oval feminine contoured

ICS Anatomica Hybrid

Socket:

Check socket Thermolyn, clear

Check socket Thermolyn, rigid

Positive model

Fabrication instructions

Valve:

Medial Lateral Without valve

21Y

Socket adapter:

SF5R10 Vacuum Forming Adapter without liner connection

5R6=*

SF5R11 Vacuum Forming Adapter with receiver for shuttle lock

SF6A60 Vacuum Forming Adapter

with locking mechanism Medial Lateral

6A30=10N Medial Lateral

6A30=20N Medial Lateral

4R160=..... Frontal Lateral

452A1=* ProSeal Ring

3

Indications for the socket design

Distal end

Preparation for liner:

6Y80 Silicone Gel Liner Size

Size

4

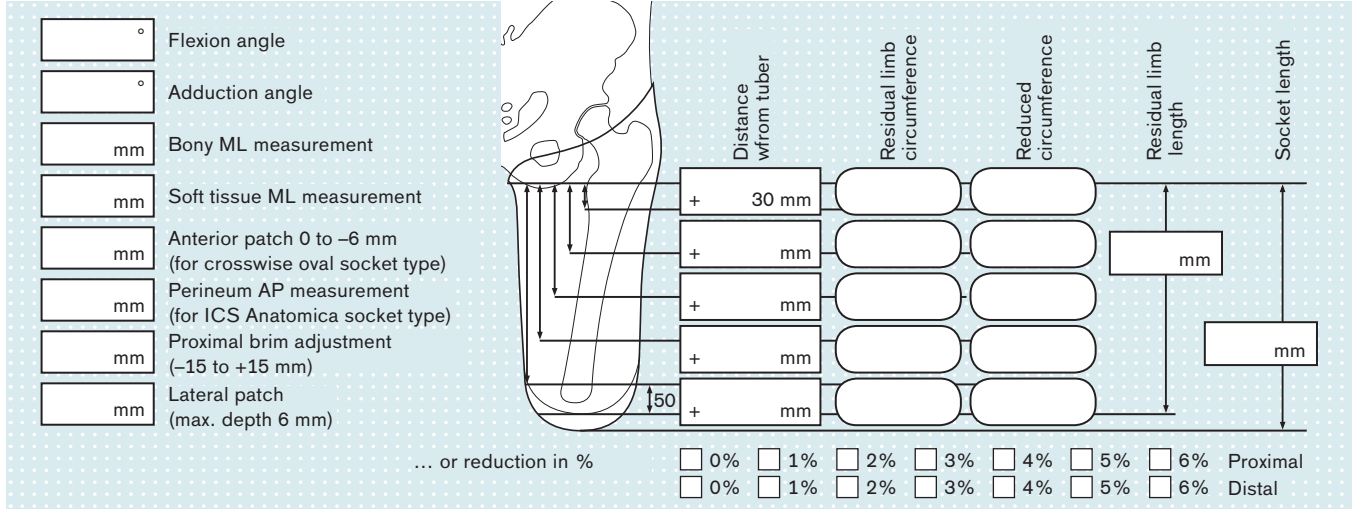

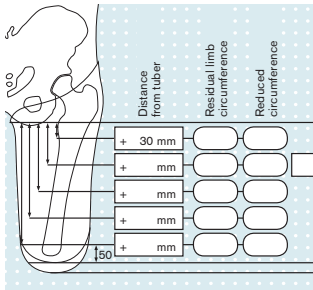

Required measurements:

Circumferences

- 30 mm below ischial tuberosity (entrance measurement)
- 1–3 circumference measurements (distance from ischial tuberosity can be freely chosen)
- Distance 50 mm from

Residual limb end

Residual limb length

Socket length

Reduction

- Indication of percentage or
- Reduced circumference



Flexion angle
 Adduction angle

Bony ML measurement
 Perineum AP measurement (for ICS Anatomica socket type)
 Lateral patch (max. depth 6 mm)

Measuring the residual limb dimensions:

Length of the residual limb from ischial tuberosity to distal end (Fig. 1). Use the Ottobock body calliper (743S10). Take the measurement along the residual limb axis. If the residual limb is in a highly abducted position, tilt the callipers accordingly.

- Palpate the skin in order to place the body calliper against the ischial tuberosity. The residual limb musculature must be relaxed when doing so, in order to keep the callipers from slipping off.
- Apply only minimal pressure at the distal end when determining the length of the residual limb.

Enter this measurement in the residual limb length box. The required socket length may be greater, as for example when only little soft tissue covers the distal end of the femur. In this case, enter the required socket length into the socket length box.

Measuring the circumferences of the residual limb

The most proximal circumference is measured 30 mm below the level of the ischial tuberosity (Fig. 2). This is the so-called entrance measurement. Use the callipers, which are still set to the residual limb length, to determine the heights for measuring the circumferences. Apply the callipers laterally to the residual limb; once again, only exert slight pressure on the residual limb end. Mark the position of the first circumference measurement on the residual limb (30 mm below the ischial tuberosity, i.e. lower edge of the calliper edge (Fig. 2)).

- The final distal measurement should be taken at least 50 mm from the residual limb end. At the chosen distal height, make a second mark on the lateral side of the residual limb. Make two more marks (max. three) for circumference measurements between these two proximal and distal marks (Fig. 3; circumferences at right angles to the residual limb axis). The measurement levels must be a minimum of 30 mm apart. As a result, you will have a maximum of five measurements including the entrance measurement and the last distal measurement (50 mm from the end of the residual limb). Read these measurement levels (below ischial tuberosity) from the callipers and enter the values on the measurement form.
- When using 743B1 Measuring Tape, try to keep the tension constant while measuring or use the 743B4 Spring-Loaded Measuring Tape. Ensure that the measuring tape is at the correct level and is aligned at right angles to the residual limb axis, so that it passes straight around the residual limb. Ask the patient to tighten the residual limb muscles to see the effect on the measured circumference. If the measurement changes significantly upon muscle contraction, enter the average of the measurements with the musculature tense and relaxed.

Taking the bony ML measurement

From behind, at the level of the fold of the buttock, push the body calliper upward with slight pressure until the medial, smaller, angled arm of the calliper reaches the bony structure of the ischial ramus. The body calliper must be held so that it is exactly horizontal. Exert slight pressure on the lateral arm of the calliper and read the measurement.

Indicating the reduction:

The reduction can be indicated in two ways.

- Determine the reduction value by selecting a percentage. The reduction is then applied at all circumference measurements using the percentage you have chosen.
- Enter the desired circumference measurement in the "Reduced circumference" column.

Indications for the socket design:

Distal socket end

The distal socket end can be made flatter or more tapered as desired. If you don't select the desired shape, the distal end will be fabricated with an intermediate shape.

Flexion and adduction angle (Fig. 4)

Angles can be entered in the range between 0° and 15°. If no angle values are entered, you will automatically get a socket with a 5° flexion angle. The flexion angle is measured from the centre of the vertical socket plumb line to the corresponding socket position.

SIT-Cast: At the level of the entry measurement, the socket is segmented in 50-50 proportions with the ML measurement. The distal end automatically aligns itself so it is centred on the plumb line of the previously mentioned proportion. The adduction angle is then calculated by applying the vertical plumb line to the trochanter major and measuring the angle to the lateral socket length.

Crosswise oval: for crosswise oval sockets, the ML measurement proportion is 60-40 (medial-lateral).

The bony ML measurement (Fig. 5) is calculated according to the drawing. Attention: the ML measurement can only be altered by ±10 mm as any change is nevertheless also based on the entrance measurement (30 mm below ischial tuberosity). When the ML measurement is modified, the AP measurement also changes in proportion to the ML measurement and vice versa.

The perineum AP measurement (medial socket width; Fig. 6 left) is the distance from the perineum to the ventral stop. It is measured from the adductor tendon to the ischial tuberosity. It is important that the patient is seated on a hard base for taking this measurement. Then measure the distance from the base to the adductor tendon.

A lateral-posterior patch (Fig. 6, right) is a pressure pad. The thickness is dependent on the residual limb conditions.

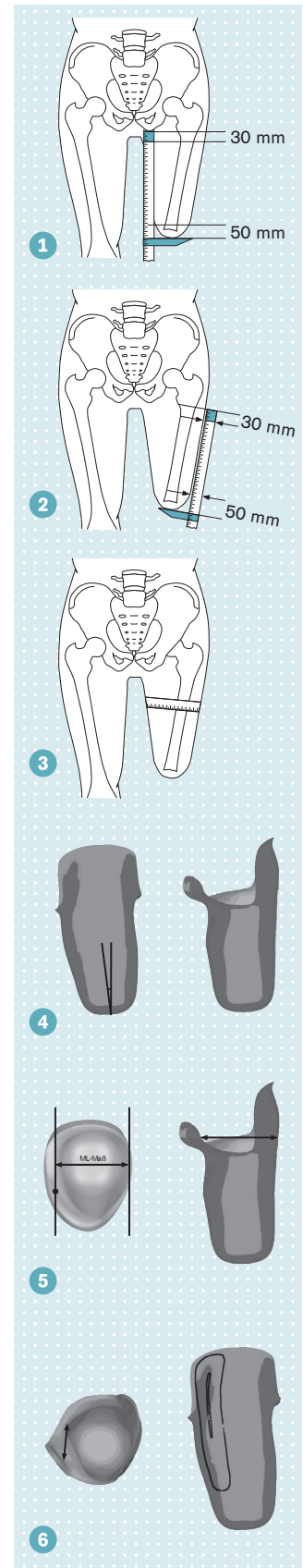

1

2

3

4

1

2

3

4



TT Design Sockets

Ottobock TT Design is a modern computer-assisted technique for the individual fabrication of check sockets and transtibial interim prostheses. A photometric method makes it possible to digitalise the residual limb data and visualise a 3-dimensional model of the socket on a PC. Ottobock Service Fabrication uses the submitted data to fabricate a thermoplastic check or interim socket. Ottobock TT Design – a quick and effective way of fabricating check sockets and transtibial interim prostheses.

1

2

3

4

Description of Socket Shapes

1



PTB* Anatomica

Socket shape with support and load relief surfaces characteristic for transtibial residual limbs. A closed or open patella can be specified on the order. With the Anatomica model, the flexor tendon opening is highly contoured.

2



PTB* Standard

Socket shape with support and load relief surfaces characteristic for transtibial residual limbs. A closed or open patella can be specified on the order. With the standard model, the flexor tendon opening is only slightly contoured.

3



CBM** Anatomica

Transtibial socket shape with the characteristic weight bearing and pressure relief surfaces and a supracondylar brim suspension on medial condyle. A closed or open patella can be specified on the order. With the Anatomica model, the flexor tendon opening is highly contoured.

4

* Patella tendon bearing
** Condyle Bedding Münster

CBM** Standard

Transtibial socket shape with the characteristic weight bearing and pressure relief surfaces and a supracondylar brim suspension on medial condyle. A closed or open patella can be specified on the order. With the standard model, the flexor tendon opening is only slightly contoured.



1

Contact adhesion socket

With the contact adhesion socket, the entire residual limb surface supports the load. A liner, vacuum system and sealing sleeve are needed to seal the system with this socket principle. The contact adhesion socket is also the standard socket type for transtibial fittings with the Harmony system.

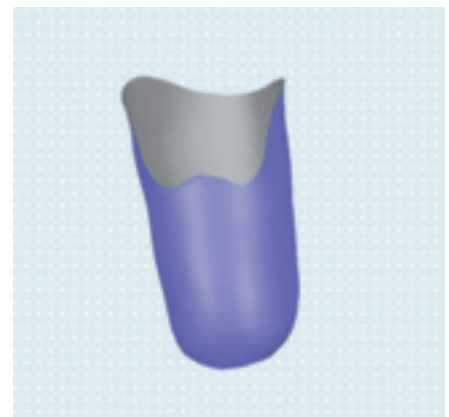

2

PTS***

Transtibial socket shape with the characteristic weight bearing and pressure relief surfaces and a supracondylar brim suspension on medial condyle. With the PTS model, the patella is closed and there is an additional support above the patella, which makes this socket shape an alternative, e.g. for very short residual limbs. The flexor tendon opening is slightly contoured. A soft inner socket is required.



3

4

** Condyle Bedding Münster

*** Prothèse Tibiale Supracondylienne

Description of the SF Adapters and Shuttle Locks

1



SF5R10 Vacuum forming adapter

The SF5R10 socket adapter is intended for check sockets made of ThermoLyn clear and ThermoLyn rigid. It is suitable for fittings without a liner, or fittings with a liner but without a connection.

2



SF5R11 Vacuum forming adapter with receiver for shuttle lock

The SF5R11 socket adapter is intended for check sockets made of ThermoLyn clear and ThermoLyn rigid. It is suitable for fittings with a liner and a pin. It is combined with the 6A20=* ratchet unit. Use the 4Y380 adapter for the connection to the prosthesis.

3



SF6A60 Vacuum forming adapter with ratchet unit

The SF6A60 socket adapter is intended for check sockets made of ThermoLyn clear and ThermoLyn rigid. It is suitable for fittings with a liner and a pin. Unlike the SF5R11, the ratchet unit is integrated.

4



6A30=10 Shuttle Lock

- Coartier aluminium housing
- Easy to unlock ratchet unit, even under tensile load
- Continuously variable locking mechanism for secure support
- Adjustable: engages silently or audibly



6A30=20 Shuttle Lock

- Serrated pin
- Lightweight plastic housing, therefore suitable for use in bathing prostheses
- Easy to unlock ratchet unit, even under tensile load
- Continuously variable locking mechanism for secure support
- Adjustable: engages silently or audibly

The purchase of the 743R9 Ottobock TF and TT Design Case includes all required tools as well as the 647X6 and 647X11 Ottobock TF & TT Design software.

Tools

743R9 TF and TT Design case

- 2 residual limb socks
- 1 calibrator for TT Design
- 1 knee angle
- 1 TT design software
- 1 TF design software
- 1 calliper for TF design
- 1 spring-tensioned measuring tape
- 1 calliper
- 1 digital camera
- 1 black photo background
- 1 red felt-tip pen
- 100 adhesive hook and loop dots
- 1 angle gauge



743S20 Callipers



99B90=2 Residual limb sock

- 6 per package



1

2

3

4

Information on the Ordering Process

1

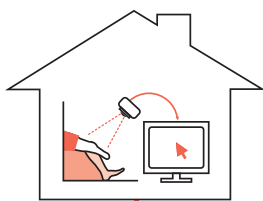

Take lateral and frontal photos of the patient's residual limb in front of a black background. After entering the data, the photos can be edited using the software. The socket shape can be specified, and may be checked and modified using the 3D model.

2

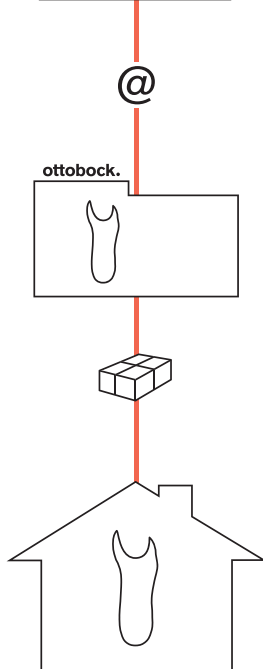



Once you have selected the prosthesis components and services, save the order and send the data to Ottobock Service Fabrication by e-mail.

Ottobock Service Fabrication will fabricate the TT Design socket for you, and usually ships it within 1 working day. If the data are received by 12 noon, shipment is on the same working day.

3

- In order to work with the 647X11 Ottobock TT Design Software, you require the 743R9 Ottobock TF & TT Design Case and must first complete a corresponding Ottobock TT Design training course.

 646D330=GB (Information for Practitioners "TT Design Check Sockets")

 647H406 (Instructions for Use, 647X11 Otto Bock TT Design Software)

4

Socket design with the help of the 647X11 Ottobock TT Design Software is done in four steps:

1. Order Details

The patient measurements are entered and the desired socket shape is established in the first step.



1

2. Photo View

In the second step, socket modification can be performed visually with patches.



2

3. Socket View

In the third step, the TT socket can be visually inspected and the shape adjusted as necessary.



3

4. Ordering from Ottobock Service Fabrication

In the final step, the chosen TT socket, components and services are displayed and explained one more time in a product description. Then the selected articles can be ordered in this step. The data are sent to Ottobock Service Fabrication by e-mail.



4

1

2

3

4



SiOCX TF Socket for Transfemoral Amputations

In the SiOCX TF and the new SiOCX TF Pro, Ottobock combines innovations with proven strengths.

The inner socket is made of medical-grade silicone that reduces perspiration and is easy to clean. It can also be sterilised and is non-allergenic and especially skin-friendly. Thanks to its flexible silicone edges and optimised socket brim line, the SiOCX Socket provides a high degree of mobility. Silicone gel pads protect and relieve sensitive areas of the residual limb. Good adhesion on the residual limb and a stable connection between the outer and inner sockets allow for effective prosthesis control and give the user a sense of security. The outer socket made of carbon prepreg features stability and low weight.

As an alternative to the proven closed carbon outer socket, a frame socket was developed that is also made of carbon – the SiOCX TF Pro. Given its optimal design, the SiOCX TF Pro provides more flexibility and an improved sense of the environment. With the windows in the frame socket and the flexible dorsal section in the closed outer socket version, the residual limb can better adapt its shape to a sitting position. This makes sitting more comfortable, even on hard surfaces and over extended periods of time.

1

2

3

4

1



7T450=1 SiOCX TF

- Inner socket made of HTV medical-grade silicone (incl. perineum pad, distal integrated clip and anti-stick coating in the proximal area)
- Carbon prepreg outer socket (incl. flexible socket regions)
- Incl. thermoplastic diagnostic socket

2



7T451=1 SiOCX TF Pro

- Inner socket made of HTV medical-grade silicone (incl. perineum pad, distal integrated clip and anti-stick coating in the proximal area)
- Frame socket made of carbon prepreg (incl. flexible socket regions)

3



7T431=4 SiOCX TF Inner Socket

- Inner socket made of HTV medical-grade silicone (incl. perineum pad, distal integrated clip and anti-stick coating in the proximal area)
- Incl. thermoplastic diagnostic socket

4



7T431=3 HTV Silicone Inner Socket

- Thermoplastic diagnostic socket, gel pads, distal integrated clip and proximal anti-stick coating available at an extra charge

 646D437=GB (Information for Practitioners "SiOCX TF Sockets")
646D559=GB (Patient Information "SiOCX TF Sockets")

Information about the 2-stage Ordering Process for the SiOCX TF with Diagnostic Socket

When ordering, please send the following to Service Fabrication:

- The completed order form
- A plaster positive of a well-fitting check or definitive socket, or
- The well-fitting check or definitive socket itself

The socket should be worn until the residual limb volume fluctuations are minimised. In the time between ordering and delivery of the definitive SiOCX TF socket, the patient should wear a correspondingly fitting socket to minimise changes in residual limb shape and volume.

Please label the socket or plaster positive with the following information:

- Position, size and strength of the soft padding in the perineal region and any additional soft padding
- The positions of connections between inner socket and outer socket (recommendation: two medial, three lateral and one frontal)
- The valve position

Within 10 working days you will receive the following:

- The definitive silicone inner socket connected to a thermoplastic outer socket without positioned adapter.

This outer socket serves as a diagnostic socket on which changes in shape, socket brim line and adapter position can be made.

For fitting step 2, please send the following to Service Fabrication:

- The completed order form
- The definitive silicone inner socket delivered in fitting step 1
- The thermoplastic diagnostic socket modified by you with:
 - Trimmed and, if necessary, flared socket brim
 - Marked flexible seat region cut-out (seating band)
 - Definitively positioned adapter

Within 7 working days you will receive the following:

- The definitive SiOCX TF socket comprising a silicone inner socket and a carbon prepreg outer socket.

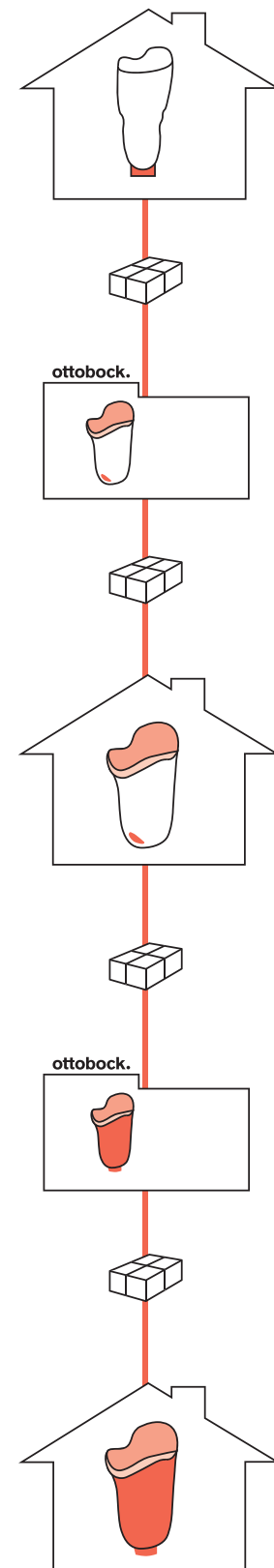

Information about the 1-stage Ordering Process for the SiOCX TF without Diagnostic Socket

1

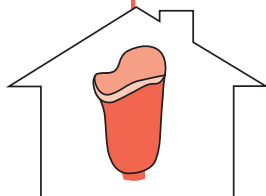
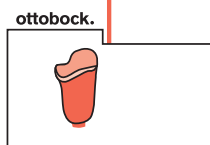
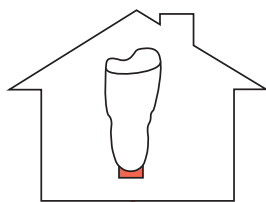

2

3

4

When ordering, please send the following to Service Fabrication:

- The completed order form
- A well-fitting check or definitive socket with correct adapter position.

Please note that the socket should be worn until the residual limb volume fluctuations are minimised. In the time between ordering and delivery of the definitive SiOCX TF socket, the patient should wear a correspondingly fitting socket to minimise changes in residual limb shape and volume.

Please label the socket with the following information:

- Position, size and strength of the soft padding in the perineal region and any additional soft padding
- The position of connections between the inner and outer sockets (recommendation: two medial, three lateral and one frontal)
- The valve position
- The desired outer socket brim line

Within 15 working days you will receive the following:

- The definitive SiOCX TF socket comprising a silicone inner socket and a carbon prepreg outer socket.

SiOCX TF

Order form

Contact	<input type="text"/>	Customer number	<input type="text"/>	Date	<input type="text"/>
Customer			Shipping address (if different from customer address)		
Company	<input type="text"/>		Company	<input type="text"/>	
Street	<input type="text"/>		Street	<input type="text"/>	
Postal code/city	<input type="text"/>		Postal code/city	<input type="text"/>	
Email	<input type="text"/>		Phone	<input type="text"/>	
Patient ID	<input type="text"/>				

Patient weight: Mobility grade: 1 2 3 4
 Overall residual limb length: Affected side: Left Right
 Bony residual limb length:



Your SiOCX socket system includes the diagnosis socket, the HTV silicone inner socket, a perineum pad, a distal integrated clip and the definitive prepreg outer socket.

- With diagnosis socket (2-step ordering process) Without diagnosis socket (1-step ordering process) for SiOCX follow-up fittings

Silicone inner socket

SiliconeGel padding

- No perineum pad
 (additional pads requested)

Mark the position and size of the pads on the check socket.

Colour

- Skin colour
 Uni

Valve*

- 21Y12
 21Y14
 21Y21

- No anti-stick coating

Thermoplastic diagnosis outer socket

Material

- 616T52 Rigid
 616T83 Clear

Adapter

- Without adapter
 Include adapter: art. no.

Prepreg outer socket

- Flexible seating tape

Surface design

- Finished carbon design
 Untreated carbon design
 Water transfer printing (special order form)

Adapter*

- 5R2=C 4R89 4R41
 4R111 4R116 4R119

- Same adapter position
 Position adapter as close as possible to the distal residual limb end

* Surcharge

Comments:

.....

1

2

3

4

Information on the Ordering Process for the SiOCX TF Pro

1

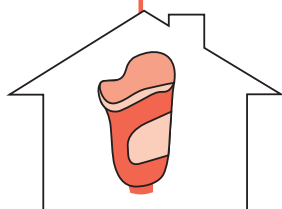
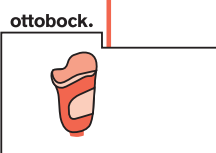
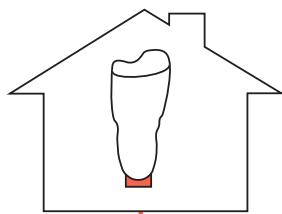

2

3

4

When ordering, please send the following to Service Fabrication:

- The completed order form
- A well-fitting check or definitive socket with correct adapter position.

Please note that the socket should be worn until the residual limb volume fluctuations are minimised. In the time between ordering and delivery of the definitive SiOCX TF Pro socket, the patient should wear a correspondingly fitting socket to minimise changes in residual limb shape and volume.

Please label the socket with the following information:

- Position, size and strength of the soft padding in the perineal region and any additional soft padding
- The position of the connections between the inner and outer sockets (recommendation: three medial and four lateral)
- The valve position
- The medial and lateral frame arms
- The desired outer socket brim line

Within 15 working days you will receive the following:

- The definitive SiOCX TF Pro socket comprising a silicone inner socket and carbon prepreg frame socket.

SiOCX TF Pro

Order form

Contact	<input type="text"/>	Customer number	<input type="text"/>	Date	<input type="text"/>
Customer			Shipping address (if different from customer address)		
Company	<input type="text"/>		Company	<input type="text"/>	
Street	<input type="text"/>		Street	<input type="text"/>	
Postal code/city	<input type="text"/>		Postal code/city	<input type="text"/>	
Email	<input type="text"/>		Phone	<input type="text"/>	
Patient ID	<input type="text"/>				

Patient weight: Mobility grade: 1 2 3 4
 Overall residual limb length: Affected side: Left Right
 Bony residual limb length:



Your SiOCX socket system includes the HTV silicone inner socket, a perineum pad, a distal integrated clip and the definitive prepreg frame socket.

To order the frame socket, **all** of the following criteria have to be met (please check):

- Socket type is crosswise oval, SIT-Cast, Anatomica or MAS No residual limb volume fluctuations
 Residual limb is at least 20 cm long

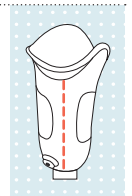

On the socket you are sending in, please mark the course of the axis for the medial and lateral frame bar.

Silicone inner socket

SiliconeGel padding

- No perineum pad
 (additional pads requested)

Mark the position and size of the pads on the check socket.

Colour

- Skin colour
 Uni

Valve*

- 21Y12
 21Y14
 21Y21

- No anti-stick coating

Prepreg outer socket (frame socket)

Surface design

- Finished carbon design
 Untreated carbon design
 Water transfer printing (special order form)

Adapter*

- 5R2=C 4R89 4R41
 4R111 4R116 4R119

- Same adapter position
 Position adapter as close as possible to the distal residual limb end

* Surcharge

Comments:

1
2
3
4

Information on the Ordering Process for the HTV Silicone TF Inner Socket

1

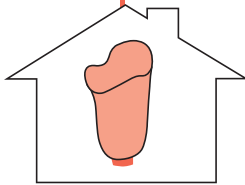
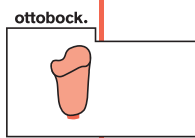
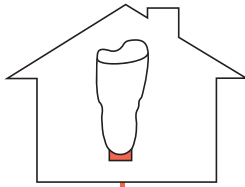

When ordering, please send the following to Service Fabrication:

- The completed order form
- A plaster positive of a well-fitting check or definitive socket, or
- The well-fitting check or definitive socket itself

Please note that the socket should be worn until the residual limb volume fluctuations are minimised. In the time between ordering and delivery of the HTV silicone inner socket, the patient should wear a correspondingly fitting socket to minimise changes in residual limb shape and volume.

2

Please label the socket with the following information:

- If desired, the position, size and thickness of the soft padding in the perineal region and any additional soft padding
- The position of connections between the inner and outer sockets (recommendation: two medial, three lateral and one frontal)
- The valve position

3

Within 10 working days you will receive the following:

- The definitive HTV silicone inner socket

4

SiOCX TF Inner Socket

Order form

Contact		Customer number		Date	
Customer			Shipping address (if different from customer address)		
Company			Company		
Street			Street		
Postal code/city			Postal code/city		
Email			Phone		
Patient ID					

Patient weight: Mobility grade: 1 2 3 4
 Overall residual limb length: Affected side: Left Right
 Bony residual limb length:



SiOCX TF inner socket

Colour

Skin colour Uni

Your SiOCX TF inner socket includes the diagnosis socket, the HTV silicone inner socket, a perineum pad and a distal integrated clip.

HTV silicone inner socket TF

Colour

Skin colour Uni

Additional options (surcharge)

For technical reasons, the inner socket includes the distal integrated clip subject to surcharge.

SiliconeGel padding

- Perineum pad
- (additional pads requested)

Mark the position and size of the pads on the check socket.

Valve

- 21Y12 21Y14 21Y21

Anti-stick coating

Thermoplastic diagnosis outer socket

- Material
- 616T52 Rigid
 - 616T83 Clear

Adapter

- Without adapter
- Include adapter: art. no.

Comments:

.....

1
2
3
4

1

2

3

4



Definitive Sockets for the Lower Limbs

Ottobock offers closed laminated resin sockets and prepreg frame sockets for transfemoral and transtibial amputations. The shape of the socket is established and designed by the prosthetist. Service Fabrication produces a definitive socket based on the check or definitive socket sent in by the prosthetist.

Definitive sockets from Ottobock feature dermatological compatibility, proven structural durability and an optimum weight/durability ratio. The entire prosthesis can be supplied pre-assembled upon request.

1

2

3

4

Ottobock offers several ordering options to meet the individual needs of your patient.

The following ordering options may be selected for transtibial as well as transfemoral definitive sockets.

1



Prepeg frame socket

- Particularly efficient gait thanks to low weight
- Pleasant to wear due to flexible socket brim design

2

3

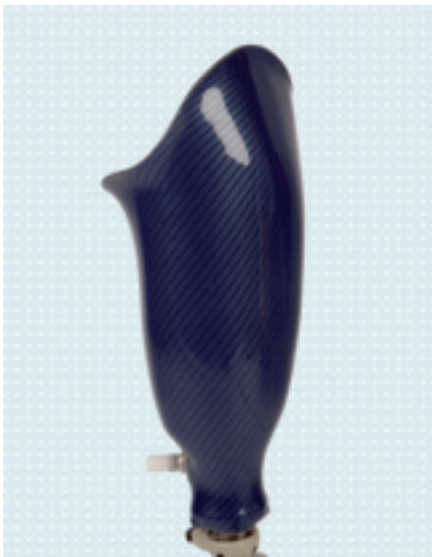

Enclosed laminated resin socket

- Optimised weight/durability ratio

4

Information on the Ordering Process

You already have a trial fitted and possibly adapted check socket, or a definitive socket that fits the patient well.

Please submit the check or definitive socket along with the completed order form to Ottobock Service Fabrication.

Ottobock Service Fabrication will fabricate the individual definitive socket according to your specifications and ship it within 10 working days – by request also as a fully preassembled prosthesis.

The socket allows you to provide an optimised and individual definitive fitting to the patient.

 646D318 (Information for Practitioners "Definitive Sockets")

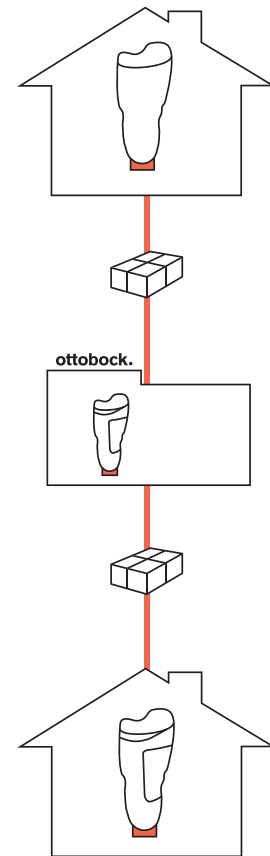

Definitive Socket

Order form

1

Contact	Customer number	Date
Customer		Shipping address (if different from customer address)
Company	Company	
Street	Street	
Postal code/city	Postal code/city	
Email	Phone	
Patient ID		

2

Patient weight:

Mobility grade: 1 2 3 4

Affected side: Left Right



Transfemoral socket (TF)

Transtibial socket (TT)

Prepreg frame socket (please mark course of frame)

Prepreg socket closed

- Untreated carbon design
- Finished carbon design
- Finished carbon-Kevlar design

- Decor fabric art. no.:
- Water transfer printing (special order form)

Foam connecting cap (Pedilen)

- Thermolyn soft
- Thermolyn flexible

Thermolyn SilverShield

Lamination resin socket closed

- Skin colour
- Uni colour

- Water transfer printing (special order form)
- Decor fabric art. no.:

Foam connecting cap (Pedilen)

Lamination resin

Pedilen

Inner socket

PETG inner socket (without quality certificate)

Soft inner socket (Pedilen)

Adapter

- Without adapter
- Use supplied adapters

- Adapter art.no.
- Same adapter position

Valve

- Without valve

Valve art. no.

Valve position

- Same position
- Lateral

Medial

4

Configuration (please complete definitive socket measurement form)

- Include components in delivery Complete assembly
- Definitive cosmetic cover (an outline drawing is required for a TT cosmetic cover)

Definitive Socket Measurement form

Contact	Customer number	Date
---------	-----------------	------

Patient name:

Include components in delivery **Complete assembly** **Additional components:**

(Any component entry produces an order.)

Please specify the structural heights if the prosthesis is to be delivered pre-assembled.

Valve	Socket adapter
Sliding adapter	Rotation adapter
Knee joint	Tube adapter
Tube	Foot

Cosmetic cover pre-milled

Fully adapted Interior bore Interior bore conically enlarged

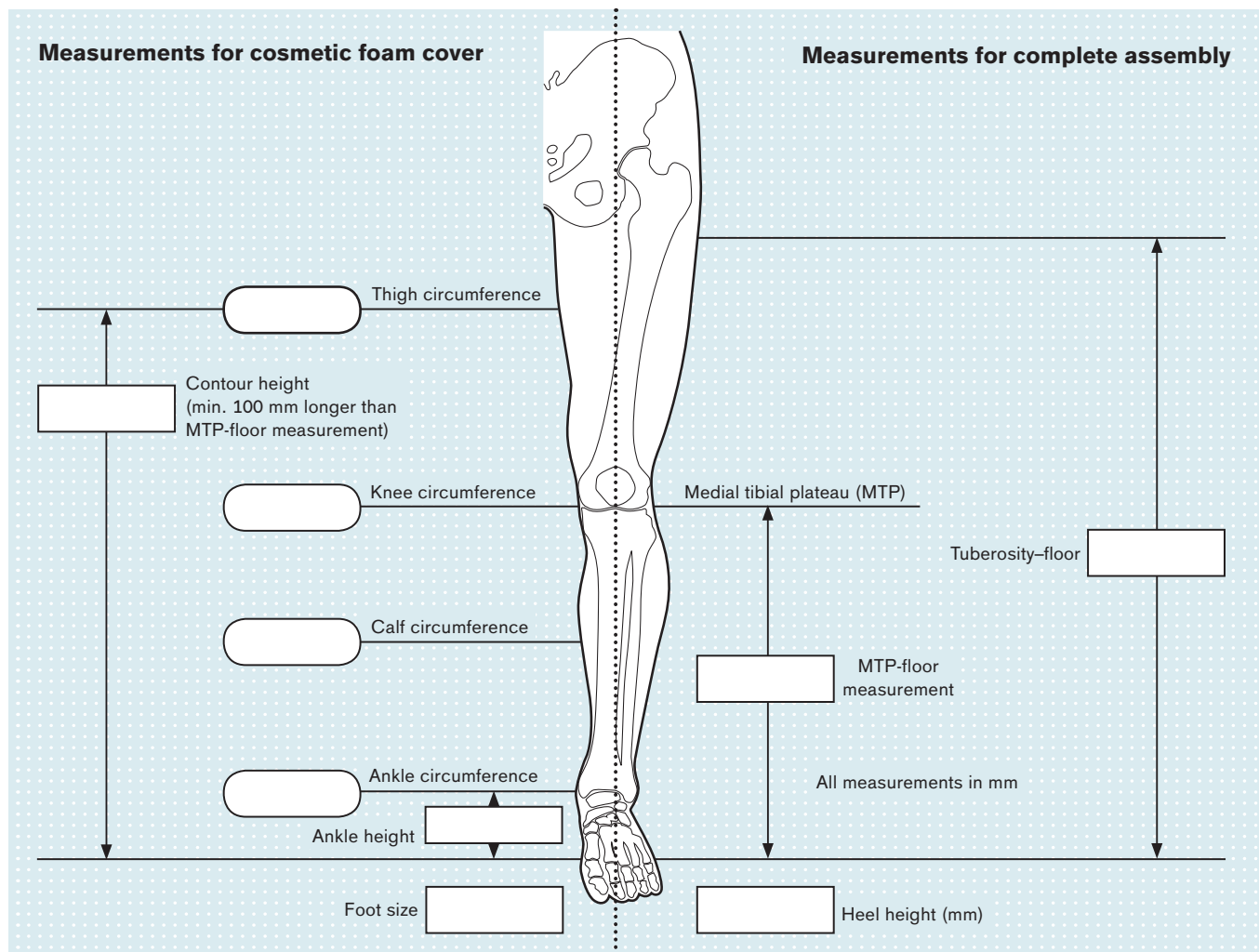

1

2

3

4

1

2

3

4



Copying Prosthetic Sockets in Wood

Although the wooden socket has been largely replaced by modern materials, there are still undisputable indications for the use of wooden sockets even today. Ottobock simplifies the time-consuming manufacturing process required for wooden sockets, offering a service for elaborate process steps such as copying the socket interior.

1

2

3

4

Ottobock offers several ordering options to meet the individual needs of your patient.

1

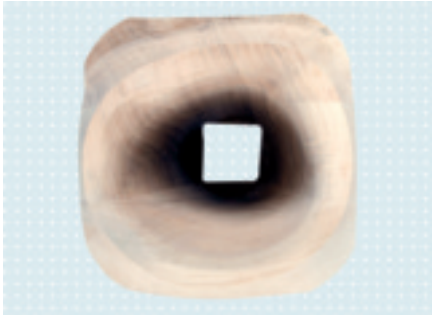

SF5P1=1000 Copying the socket

2

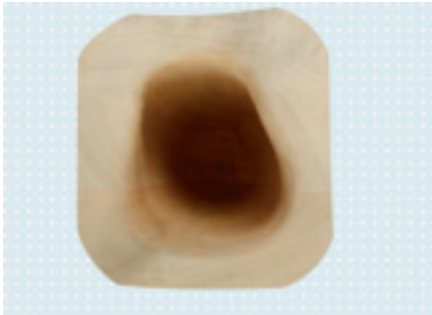

SF5P1=020 Copying the socket with bottom

3



SF5P1=030 Copying the outer brim

4



SF5P1=010 Smoothing the socket after copying

Information on the Ordering Process

You have a model or the current socket and you complete the order form.

Send the model or socket along with the order form to Ottobock Service Fabrication.

Ottobock Service Fabrication mills and, if needed, smooths the socket interior (the bottom and outer brim can also be copied) and ships the prosthetic socket within 5 working days.

You receive an exact copy of the existing socket.

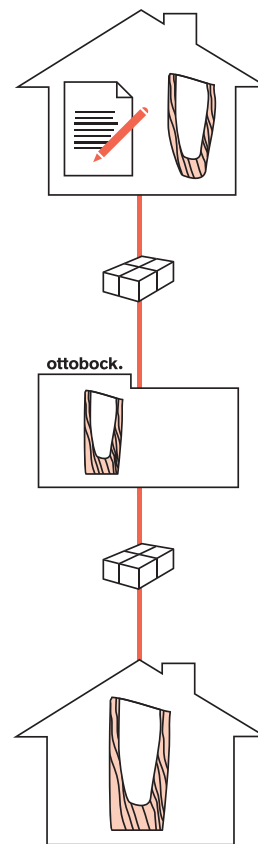

Copy of a Prosthetic Socket in Wood

Order form

1

Contact		Customer number		Date	
Customer			Shipping address (if different from customer address)		
Company			Company		
Street			Street		
Postal code/city			Postal code/city		
Email			Phone		
Patient ID					

2

- (SF5P1)** **Copy TF socket inside**
Using a 5P1 transfemoral socket block (poplar wood)

Master

- According to original socket
or for a surcharge
- (SF5P1=M1)** According to plaster negative or check socket
- (SF5P1=M2)** According to Pedilin cast or plaster positive

Extra process steps when copying the socket (for a surcharge)

- (SF5P1=010)** Smooth socket interior after copying (unsmoothed interior is 1 cm smaller in circumference)
- (SF5P1=020)** Copy socket with bottom
- (SF5P1=030)** Copy outer edge

3

- Copy socket to actual size
- Reduction/increase in circumference
- 3 cm
 - 2 cm
 - 1 cm
 - +1 cm
 - +2 cm
 - +3 cm

Comments:

.....

.....

.....

.....

.....

4

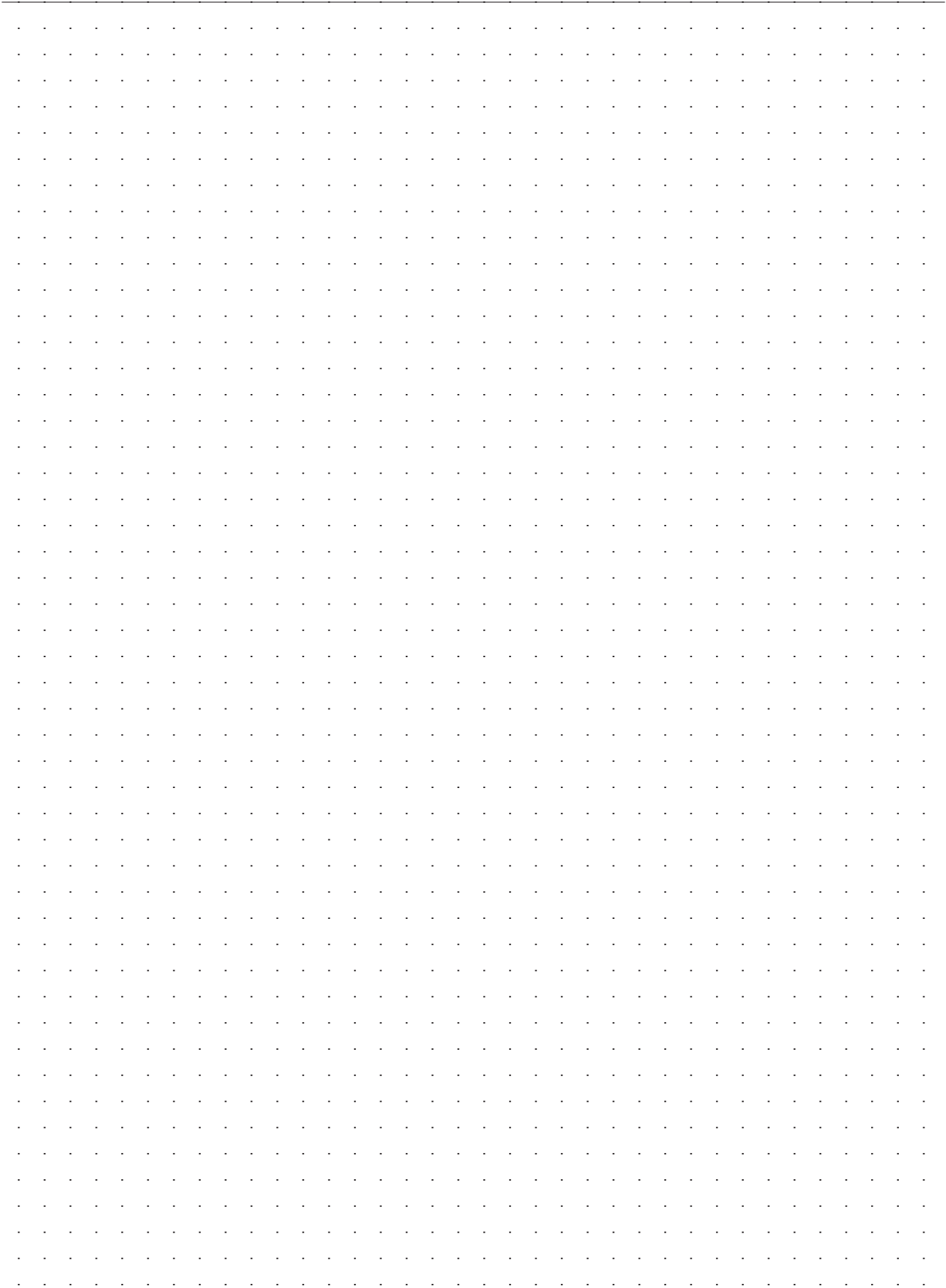

1

2

3

4

1

2

3

4

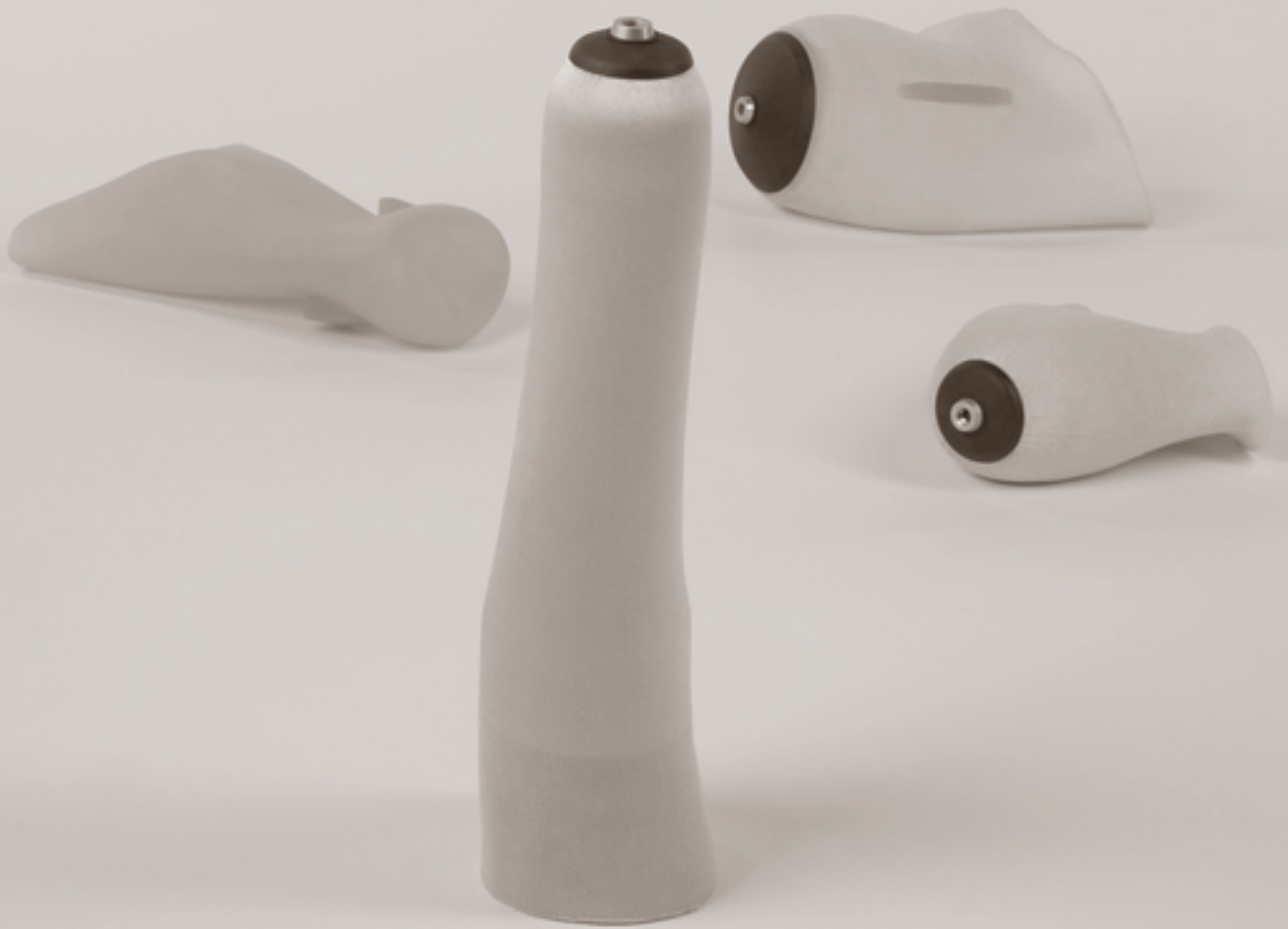

Customised Silicone Liners for the Lower Limbs

Fittings with customised silicone liners facilitate optimal contact between the skin and liner, even for highly unusual residual limb shapes. Patient-specific customisation based on a plaster model makes it possible to accommodate the patient's individual residual limb situation and to fit even extraordinary, extremely conical or scarred residual limbs with a liner. Various degrees of hardness, undercuts and varying lengths and thicknesses can be realised as well.

1

2

3

4

Ottobock offers several ordering options to meet the individual needs of your patient.

1

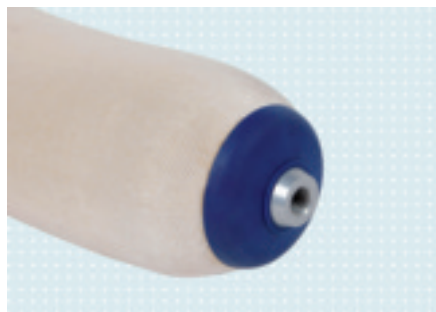

Liner with pin receiver

- For fixation in the socket
- M10 thread

2



Liner with silicone wedge

Instead of a pin, two silicone wedges may be used to hold the liner in place. Silicone wedges do not change the structural height, making them particularly well suited for long residual limbs.

3



Extension strips

The integration of extension strips reduces the elasticity of the liner, thus reducing pistoning.

4



Anti-rotation wedge

To reduce rotation between the socket and liner, the anti-rotation wedge can also be integrated into the silicone socket.

Textile cover

Grey and skin-coloured textile covers are available for the liner.



Additional Options:

- Shore hardness: different degrees of silicone hardness are available for various residual limb situations. The higher the silicone hardness, the less yielding the silicone liner will be.
- Silicone thickness: the thickness of the silicone can be chosen according to various levels of activity.
- Silicone gel coating: this is a coating on the inner wall of the liner that increases adhesion of the liner on the skin. The gel coating helps create maximum adhesion on a minimal residual limb.
- Residual limb end pad – this is a soft silicone cushion integrated into the liner. It serves as padding for points that are sensitive to pressure and pain.
- With a textile-coated silicone liner, it is easier for the patient to slip into the prosthesis. This eliminates the need for donning spray.

Colour:

- The patient can normally choose between a skin-coloured or translucent silicone liner.
- Furthermore, the individual colour wishes of the patient can be taken into account.

1

2

3

4

Information on the Ordering Process

1



Prepare a reduced plaster positive (the circular reduction should be 5% to 10%, depending on the soft tissue situation) and measure the patient's residual limb.



Send the reduced plaster positive along with the measurement form to Ottobock Service Fabrication.

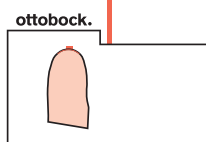

Ottobock Service Fabrication will fabricate the silicone liner for you and ship it within 10 working days.

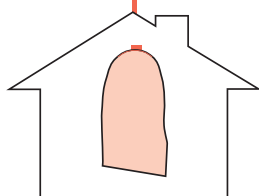

Now you can fit patients with an unusual residual limb shape or complex residual limb situation with an optimised, custom silicone liner.

2

3

4

Transfemoral Silicone Custom Liner from Plaster Cast Measurement form

1

Contact		Customer number		Date	
Customer			Shipping address (if different from customer address)		
Company			Company		
Street			Street		
Postal code/city			Postal code/city		
Email			Phone		
Patient ID					

2

88L2=BB TF Silicone Liner from plaster cast (Chlorosil)
 88L3=G Fabrication from plaster negative
 SF6Y=GN1 Copy in porous plaster

Trial liner Affected side: Left Right
 Definitive liner

Colour

Skin colour Translucent Uni colour

Fixation

With receiver for pin (M10) Silicone wedge None

Add-ons

Silicone gel coating Extension strip (matrix) to minimise pistoning
 Anti-rotation wedge mm length from residual limb end
 Custom residual limb end pads mm Number of matrix fingers
 SKINGUARD Technology
 With textile coating Skin colour Grey Anti-stick coating 88L3=B

3

Mark the course of the residual limb and limits of the liner.

Custom pads/scar compensation: please mark size and length on the plaster model.

Mark pin positions and plumb lines frontally and laterally on the plaster model with a soft pencil.

Comments:

.....

.....

.....

4

Customised Silicone Liners for the Lower Limbs
Measurement Form – Transfemoral Custom Silicone Liner from Plaster Cast

A large grid of small dots for taking measurements, consisting of 20 columns and 40 rows of dots.

1

2

3

4

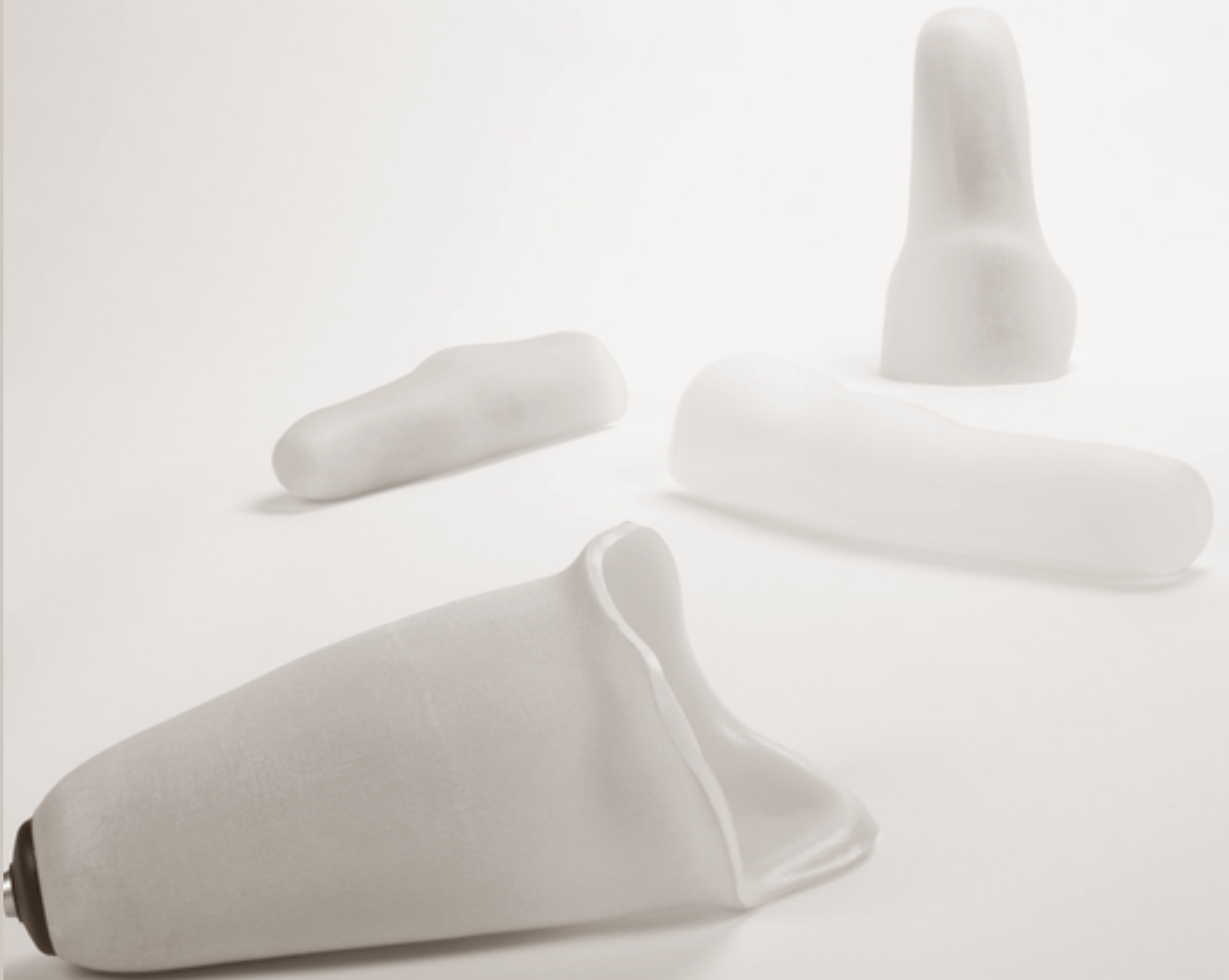

Custom Silicone Gel Liner for the Lower Limbs

Individual silicone gel liners combine the positive material properties of silicone with the advantages of a gel, and are suitable for transfemoral and transtibial amputees. The liner offers good adhesion to the residual limb as well as shock absorption and wearer comfort. Even patients with residual limb sizes and shapes outside the standard product range are assured comfortable and safe walking and standing.

Ottobock offers several ordering options to meet the individual needs of your patient. The individual silicone gel liner can be ordered based on a plaster cast or measurement form. In case of an unusual residual limb shape, please order according to a plaster cast.

1

Transfemoral Custom Liner



Article number	Connection
6Y80=M	with distal connection
6Y81=M	without distal connection (with blind cap)
6Y81=M-1	without distal connection (without blind cap)
6Y81=M-2	without distal connection (without blind cap)

2

Skinguard TF Custom Liner

Article number	Connection
6Y85=M	with connection
6Y86=M	without distal connection (with blind cap)
6Y86=M-1	without distal connection (without blind cap)

3

Transtibial Custom Liner



Silicone Gel Custom Liner

Article number	Connection
6Y70=M	with distal connection
6Y71=M-1	without distal connection (without blind cap)
6Y71=M	without distal connection (with blind cap)

4

Skinguard TT Custom Liner

Article number	Connection
6Y75=M	with connection
6Y76=M	without distal connection (with blind cap)
6Y76=M-1	without distal connection (without blind cap)

Information on the Ordering Process

Measure the patient's residual limb and complete the measurement form. In case of an unusual residual limb shape, please also prepare a plaster cast of the residual limb.

Send the measurement form as well as the plaster cast, where applicable, to Ottobock Service Fabrication.

Ottobock Service Fabrication will fabricate the custom silicone liner for you and ship it within 10 working days.

Now you can also fit patients with a complicated residual limb situation with an individual silicone gel liner, which combines good residual limb adhesion, shock absorption and wearer comfort.

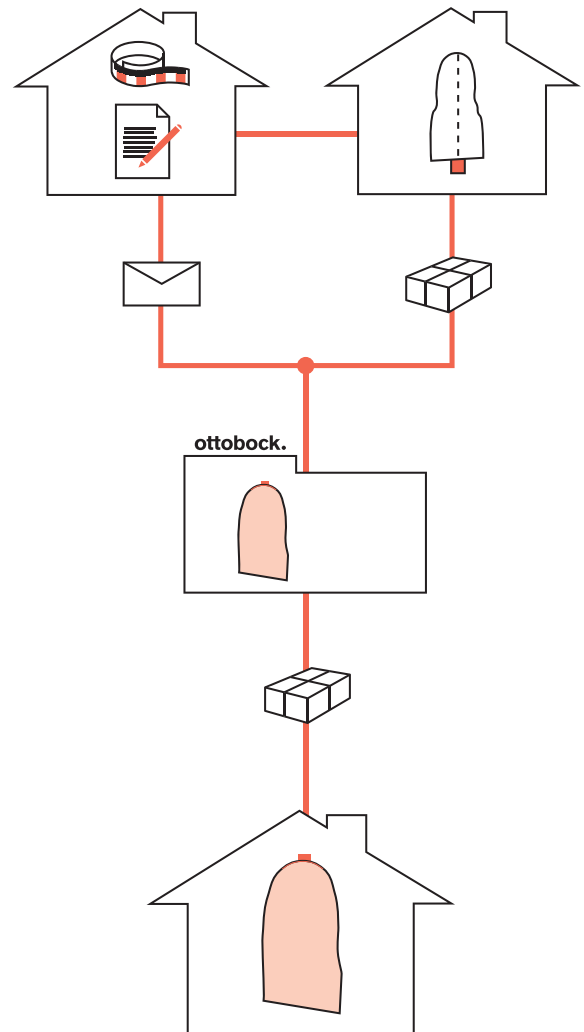

Transtibial SiliconeGel Custom Liner from Measurement Form

Measurement form

1

Contact	<input type="text"/>	Customer number	<input type="text"/>	Date	<input type="text"/>
Customer			Shipping address (if different from customer address)		
Company	<input type="text"/>		Company	<input type="text"/>	
Street	<input type="text"/>		Street	<input type="text"/>	
Postal code/city	<input type="text"/>		Postal code/city	<input type="text"/>	
Email	<input type="text"/>		Phone	<input type="text"/>	
Patient ID	<input type="text"/>				

2

Affected side: Left Right
 Wall thickness: 4 mm 5 mm 6 mm

Distal residual limb end thickness:

New order
 Re-order, previous ML no.:

- 6Y70=M** SiliconeGel liner with textile coating, with distal connector
- 6Y71=M** SiliconeGel liner with textile coating, without distal connector (with blind cap)
- 6Y71=M-1** SiliconeGel liner with textile coating, without distal connector (without blind cap)
- 6Y75=M** Skinguard TT custom liner with textile coating, with connector
- 6Y76=M** Skinguard TT custom liner with textile coating, without distal connector (blind cap)
- 6Y76=M-1** Skinguard TT custom liner with textile coating, without distal connector (without blind cap)

• Wall thickness tolerances of ±10% are possible on subsequent orders.

- Extension strip (matrix) to minimise pistoning**
 - mm length from residual limb end
 - Number of matrix fingers
 - Matrix circular closed

Textile colour: Skin colour
 Grey (with skin colour seam)
 SKINGUARD Technology

3

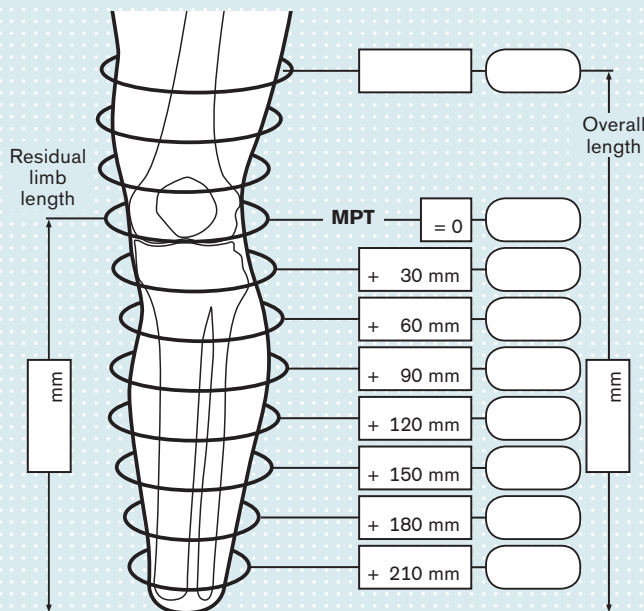

4

Comments:

Transfemoral SiliconeGel Custom Liner from Measurement Form

Measurement form

Contact		Customer number		Date	
Customer			Shipping address (if different from customer address)		
Company			Company		
Street			Street		
Postal code/city			Postal code/city		
Email			Phone		
Patient ID					

Affected side: Left Right
 Wall thickness: 4 mm 5 mm 6 mm
 Distal residual limb end thickness:

New order
 Re-order, previous ML no.:

<input type="checkbox"/> 6Y80=M TF SiliconeGel-Adapt-Liner with textile coating, with distal connector	<input type="checkbox"/> SIT-Cast contoured	<input type="checkbox"/> Crosswise oval contoured
<input type="checkbox"/> 6Y81=M TF SiliconeGel-Adapt-Liner with textile coating, without distal connector (with blind cap)	<input type="checkbox"/> SIT-Cast medium	<input type="checkbox"/> Crosswise oval medium
<input type="checkbox"/> 6Y81=M-1 TF SiliconeGel-Adapt-Liner with textile coating, without distal connector (without blind cap)	<input type="checkbox"/> SIT-Cast feminine contoured	<input type="checkbox"/> Crosswise oval feminine contoured
<input type="checkbox"/> 6Y85=M Skinguard TF custom liner with textile coating, with connector	<input type="checkbox"/> Hybrid	<input type="checkbox"/> Conical (without socket type)
<input type="checkbox"/> 6Y86=M Skinguard TF custom liner with textile coating, without distal connector (with blind cap)	<input type="checkbox"/> Contour cut	<input type="checkbox"/> Diagonal cut
<input type="checkbox"/> 6Y86=M-1 Skinguard TF custom liner with textile coating, without distal connector (without blind cap)	<input type="checkbox"/> Extension strip (matrix) to minimise pistoning mm length from residual limb end number of matrix fingers	
<input type="checkbox"/> 6Y81=M-2 ProSeal custom liner	Textile colour: <input type="checkbox"/> Skin colour <input type="checkbox"/> Grey (with skin colour seam) <input type="checkbox"/> SKINGUARD Technology	

Thigh measurements
Important: Extend measurement sections if necessary.

Distal end

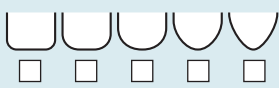

Notes
 Wall thickness tolerances of ±0.8 mm are possible on subsequent orders.
 Length of the matrix: 4 cm below the medial liner edge.

Comments:

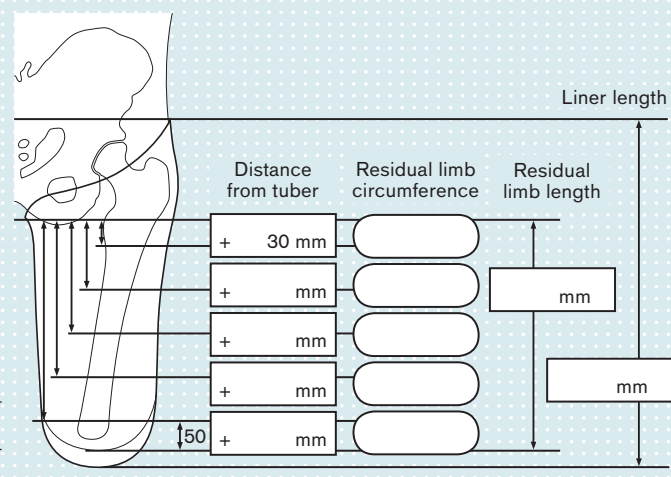

1

2

3

4



Polyurethane Custom Liner for the Lower Limbs

Due to the special properties of polyurethane gel, PUR custom liners offer good pressure distribution, high shock absorption and elasticity for the patient in addition to being flexible and non-irritating to the skin. Its material properties make the individual PUR custom liner well suited for scarred, bony and especially sensitive residual limbs. These benefits may be very important, especially for patients suffering from diabetes mellitus.

1

2

3

4

Ottobock offers several ordering options to meet the individual needs of your patient. Custom polyurethane liners are ordered according to a plaster cast. For straightforward residual limbs, you can also order the PUR custom liner for transtibial amputations (6Y400=M) using the measurement form.

1

Syme's and Transmalleolar Amputations

According to plaster cast and measurement form



6Y416 ShapePlus Custom PUR Liner

ShapePlus custom PUR liner – for challenging shapes and sizes, such as scarring, undercuts, knee flexion 15 – 35°, large circumferences ($\geq 80\text{cm}$) or long lengths (MPT to distal end $\geq 30\text{cm}$), i.e. Symes, knee disarticulations, etc. Fabricated according to a plaster cast.

2

Transtibial Amputations

According to plaster cast and measurement form



6Y400 PUR Custom Liner

Custom PUR liner from cast and measurement form

3

4

6Y416 ShapePlus Custom PUR Liner

ShapePlus custom PUR liner – for challenging shapes and sizes, such as scarring, undercuts, knee flexion 15 – 35°, large circumferences (≥80cm) or long lengths (MPT to distal end ≥ 30cm), i.e. Symes, knee disarticulations, etc. Fabricated according to a plaster cast.



1

According to Measurement Form

6Y400=M PUR custom liner

Custom PUR liner from measurements only



2

Knee Disarticulation and Transfemoral Amputations

According to Plaster Cast and Measurement Form

6Y416 ShapePlus Custom PUR Liner

ShapePlus custom PUR liner – for challenging shapes and sizes, such as scarring, undercuts, knee flexion 15 – 35°, large circumferences (≥80cm) or long lengths (MPT to distal end ≥ 30cm), i.e. Symes, knee disarticulations, etc. Fabricated according to a plaster cast.



4

Information on the Ordering Process

1

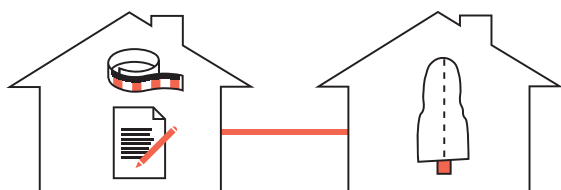

Measure the patient's residual limb and complete the measurement form. In case of an unusual residual limb shape, please also prepare a plaster cast of the residual limb.



Send the measurement form as well as the plaster cast, where applicable, to Ottobock Service Fabrication.

2

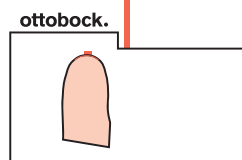

Ottobock Service Fabrication will fabricate the custom polyurethane liner for you and ship it within 15 working days.

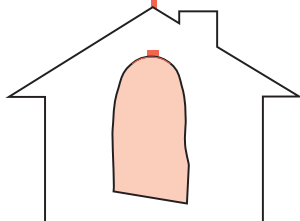

Now you can fit your patient with an individual polyurethane custom liner featuring good pressure distribution with excellent shock absorption and elasticity.

3

4

Measurement Form for Polyurethane (PUR) Liner Transtibial and Syme amputations

Contact		Customer number		Date	
Customer			Shipping address (if different from customer address)		
Company			Company		
Street			Street		
Postal code/city			Postal code/city		
Email			Phone		
Patient ID					

Affected side: Left Right

- 6Y400** PUR custom liner from plaster cast and measurement form
- 6Y400=M** PUR custom liner from measurement form
- 6Y416** Shape Plus PUR custom liner from plaster cast and measurement form

⦿ If the plaster cast has complex features such as knee flexion >15°, a bulging, eccentric or concave residual limb end, pronounced invaginated scar tissue or excess size (length >50 cm, circumference >50.5 cm), a 6Y416 Shape Plus Liner is required.

Replacement custom liner: please contact customer service.

- ⦿ Wall thickness tolerances of ±10% are possible on subsequent orders.
- ⦿ Ottobock stores the plaster cast data as a file for two years after the most recent order.

Wall thickness

- Uniform** (with 13 mm distal cushion)
(Wall thickness: 4 mm 5 mm 6 mm)
- Tapered** (6 mm wall thickness at knee centre tapering to 3 mm [± 1 mm] with 13 mm distal cushion)
- Width of the distal residual limb end mm
(if deviating from 13 mm)

Distal connector

- Without**
- With** (requires the selection of a textile coating)

Exterior coating

- With textile coating**
 - 1.6 mm, colour: Skin colour or Black
 - 0.6 mm, colour: Skin colour or Black
 - 1.0 mm, colour: Silver
- Without textile coating** (requires a non-adhesive coating)
- SKINGUARD TECHNOLOGY**

Lower leg measurements

⦿ Extend the measurement sections if necessary.

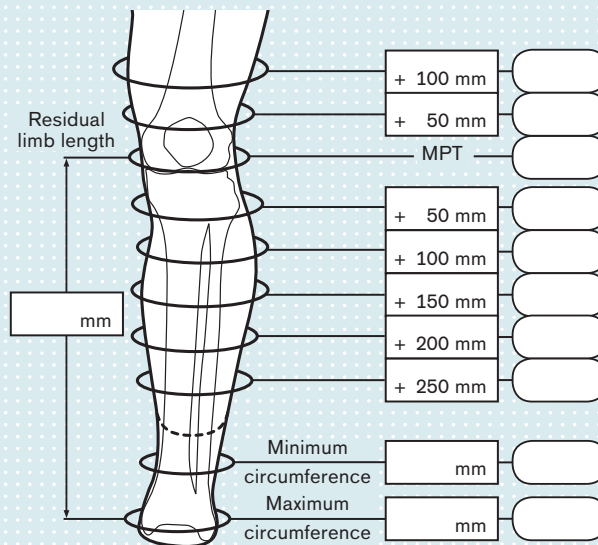

Comments:

.....

.....

1
2
3
4

Measurement Form for Polyurethane (PUR) Liner

Knee disarticulation and transfemoral amputations

1

Contact		Customer number		Date	
Customer			Shipping address (if different from customer address)		
Company			Company		
Street			Street		
Postal code/city			Postal code/city		
Email			Phone		
Patient ID					

2

Affected side: Left Right

6Y416 Shape Plus PUR custom liner from plaster cast and measurement form

• If the plaster cast has complex features such as knee flexion > 15°, a bulging, eccentric or concave residual limb end, pronounced invaginated scar tissue or excess size (length > 50 cm, circumference > 50.5 cm), a 6Y416 Shape Plus Liner is required.

Replacement custom liner: please contact customer service.

• Wall thickness tolerances of ±10% are possible on subsequent orders.
 • Ottobock stores the plaster cast data as a file for two years after the most recent order.

Exterior coating

With textile coating

- 1.6 mm, colour: Skin colour or Black
- 0.6 mm, colour: Skin colour or Black
- 1.0 mm, colour: Silver

Without textile coating (requires a non-adhesive coating)

SKINGUARD TECHNOLOGY

3

Wall thickness

Uniform (with 13 mm distal cushion)

Wall thickness: 4 mm 5 mm 6 mm

Tapered (wall thickness tapering from 6 mm to 3 mm, 13 mm distal cushion)

Harmony Style (wall thickness tapering from 6 mm to 3 mm, 7 mm distal cushion)

Distal connector

Without

With (requires the selection of a textile coating)

Thigh measurements

• Extend the measurement sections if necessary.

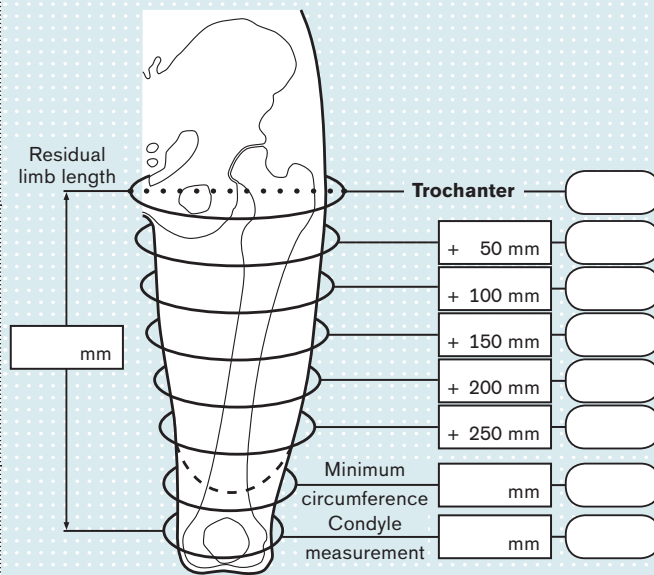

4

Comments:

.....

.....

Polyurethane Custom Liner for the Lower Limbs
Order Form for Knee Disarticulation and Transfemoral Amputations

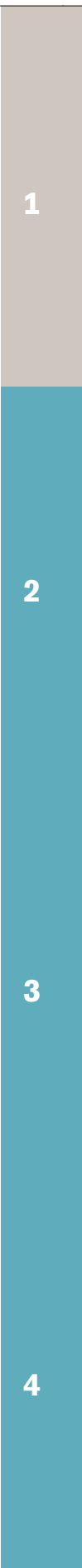
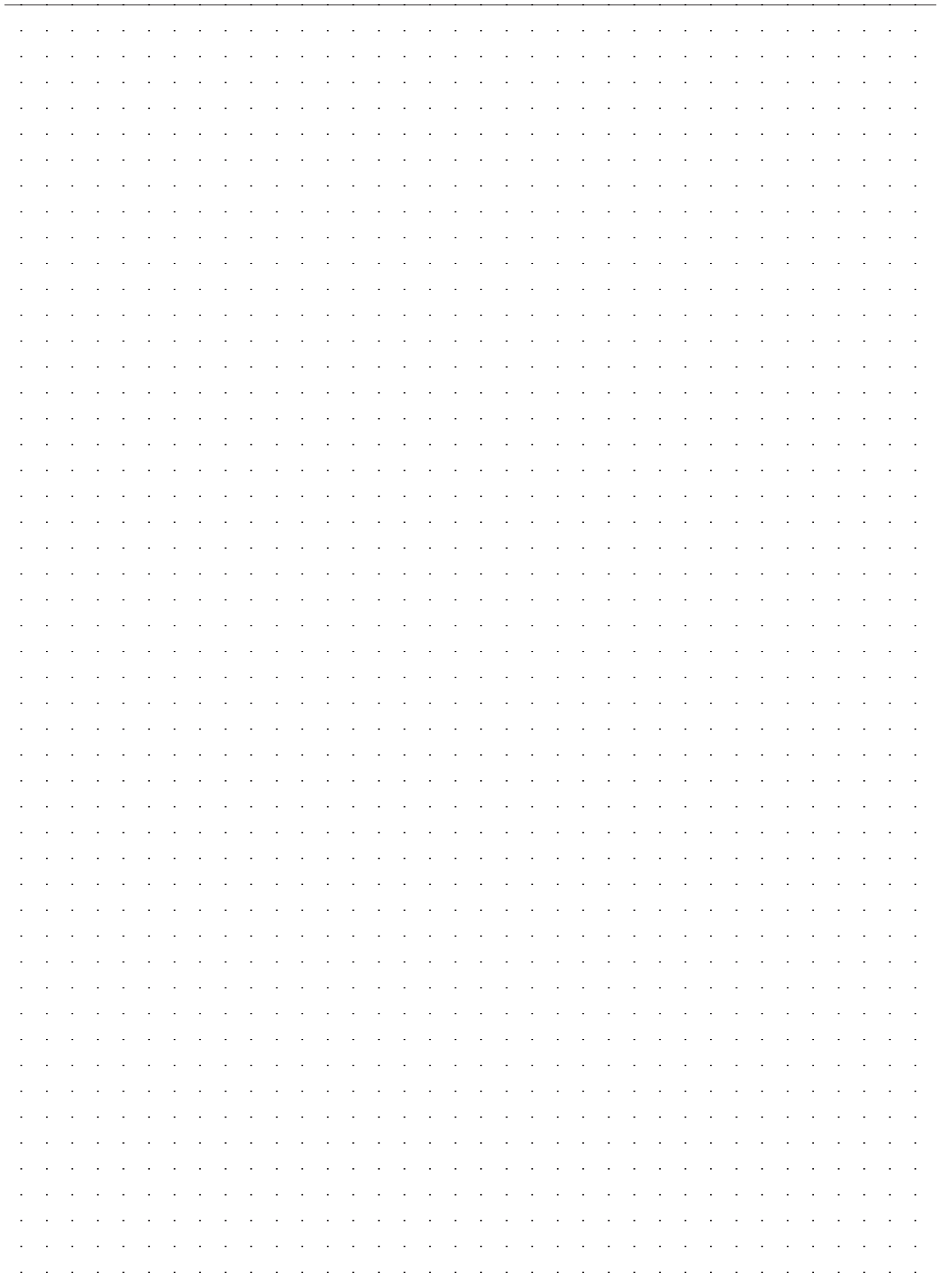

1

2

3

4

1

2

3

4

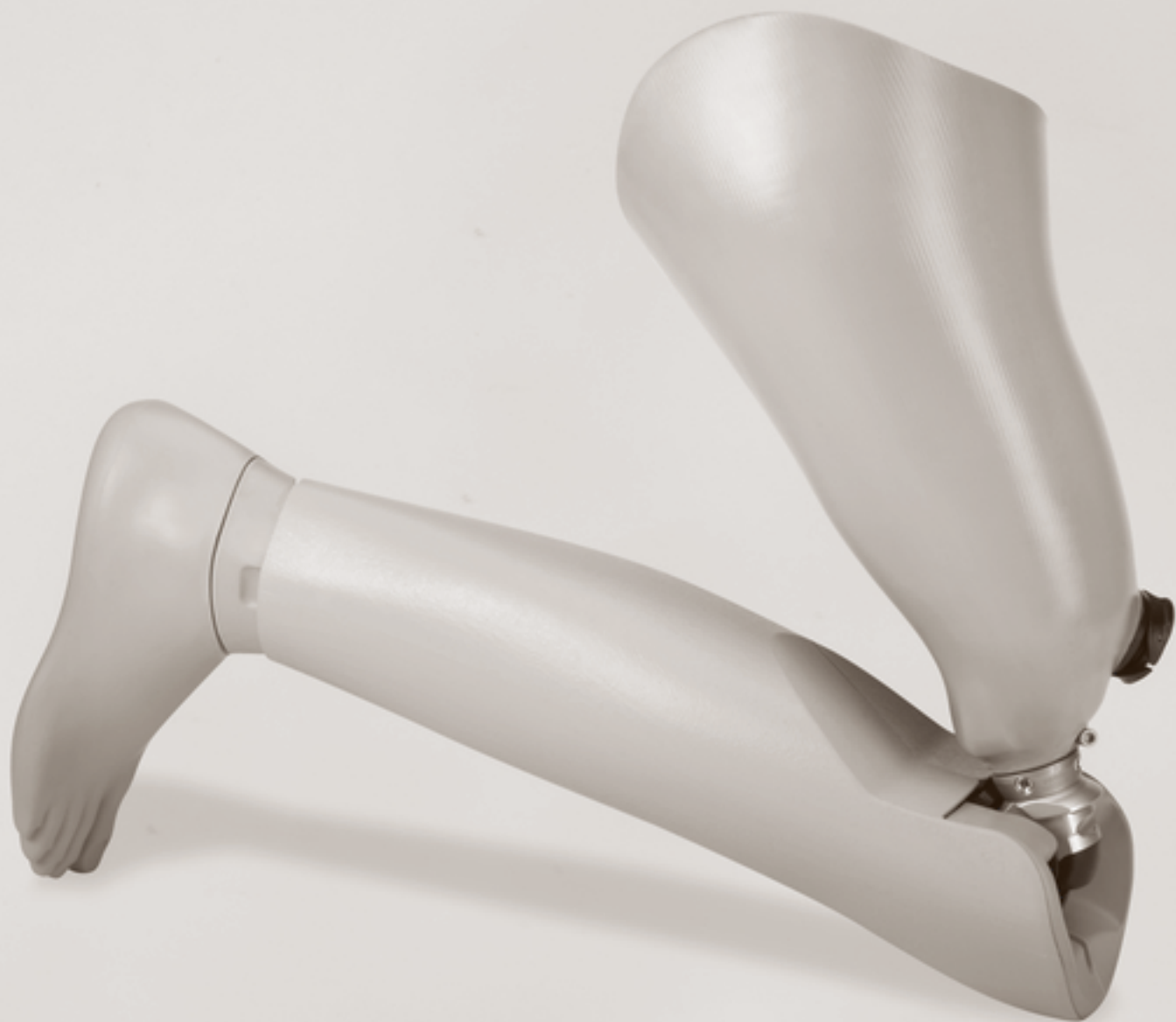

Aqualine Cover

Waterproof walking aids from Ottobock allow many amputees to use their prosthesis instead of crutches in wet areas. After functionality, the restoration of outward appearance is the most important factor for the prosthesis wearer.

Ottobock meets this need for a natural appearance with the new Aqualine Cover for waterproof modular transfemoral prostheses. It was designed especially for use with the 3WR95 Aqua Knee and the 1WR95 Aqua Foot, and for contact with water.

The Aqualine Cover is available exclusively from Ottobock Service Fabrication. It is customised for each patient and coated with skin-coloured SuperSkin matching the Aqua Foot, creating a harmonious appearance and pleasant surface.

1

2

3

4

1



Aqualine Cover

The cover features especially aesthetic contours and an appealing natural look. Thanks to modern, innovative fabrication processes and materials, it is extremely robust and assures high functionality – for example when kneeling safely.

The easy-to-use locking mechanism allows the amputee to put on, take off and clean the cover easily as required.

In addition, the Aqualine cover can be flooded to eliminate buoyancy in the water. When leaving the water, it drains quickly and unobtrusively through the interior openings in the distal connector.

2

3

4

Information on the Ordering Process

Take measurements on the patient and prosthesis and complete the measurement form.

Please send the measurement form to Ottobock Service Fabrication.

Ottobock Service Fabrication will fabricate and coat the individual Aqualine cover for you and ship it within 5 working days.

Now you can offer a natural and functional form of the waterproof walking aid, thereby helping to restore your patient's outward appearance.

 646D445 (Information for Practitioners "Ottobock Aqualine")
646D629 (Patient Information "Ottobock Aqualine")

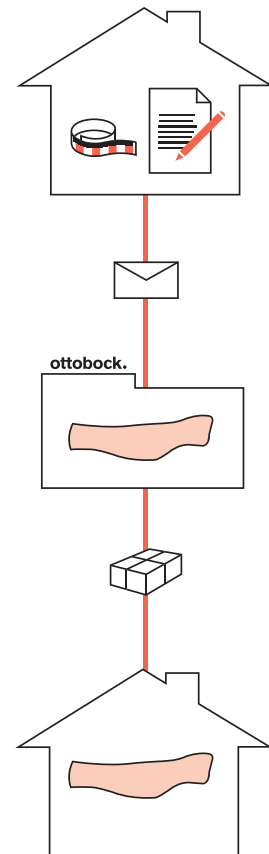

1

2

3

4

Aqualine Cover

Measurement form

1

Contact		Customer number		Date	
Customer			Shipping address (if different from customer address)		
Company			Company		
Street			Street		
Postal code/city			Postal code/city		
Email			Phone		
Patient ID					

2

Patient information

Side: Left Right

Mobility grade: _____

Weight: _____

	Foot size	Calf circumference	Allowable knee axis-heel measurement	Measured knee axis-heel measurement
<input type="checkbox"/>	24	S (330 mm)	460 – 510 mm	_____ mm
<input type="checkbox"/>	24	M (370 mm)	500 – 560 mm	_____ mm
<input type="checkbox"/>	25	S (330 mm)	460 – 510 mm	_____ mm
<input type="checkbox"/>	25	M (370 mm)	500 – 560 mm	_____ mm
<input type="checkbox"/>	26	M (370 mm)	460 – 560 mm	_____ mm
<input type="checkbox"/>	26	L (410 mm)	510 – 560 mm	_____ mm
<input type="checkbox"/>	27	M (370 mm)	460 – 560 mm	_____ mm
<input type="checkbox"/>	27	L (410 mm)	510 – 560 mm	_____ mm
<input type="checkbox"/>	28	M (370 mm)	460 – 560 mm	_____ mm
<input type="checkbox"/>	28	L (410 mm)	510 – 560 mm	_____ mm

Prosthesis data

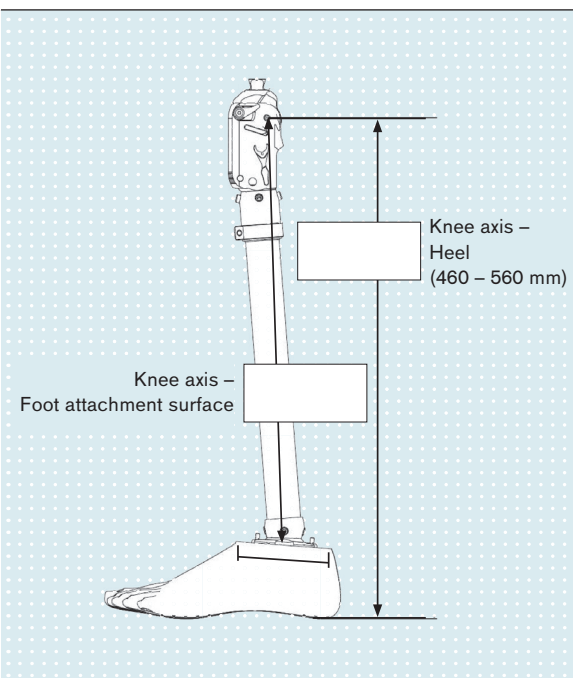

3

Further Aqualine components (modular design)

- Include components in delivery
- Complete assembly
- 635Z56 Superskin Repair Kit
- Silicone Liner 6Y40= _____ (size)
- or 21Y14 Push Valve
- 21Y21 ClickValve
- 6A30=20 Shuttle Lock
- Lamination Anchor with Pyramid Receiver 4WR95=1
- Lamination Anchor with Pyramid Adapter 4WR95=2
- 3WR95 Aqua-Knee
- 4WR95=3 Tube Clamp Adapter
- 2WR95 Tube Adapter
- 2WR95=1 Tube Adapter, angled
- Aqua-Foot (with pyramid connector) 1WR95=
- side: Left Right
- Foot size: _____

4

Brief Instructions for Taking Measurements

The Aqualine Cover is only suitable for use in combination with TF prostheses.

Ideally you should take the measurements from the finished, adjusted, definitive Aqualine prosthesis. This allows us to ensure that the calf component is shortened to precisely the right length. Furthermore, please lay the prosthesis down to take measurements.

In addition to the knee axis-heel measurement of the Aqualine prosthesis, we require the distance between the knee axis and the sagittal centre (at the level of the screw) of the foot attachment surface in order to precisely adapt the calf component.

Please consult the following illustrations for this measurement.

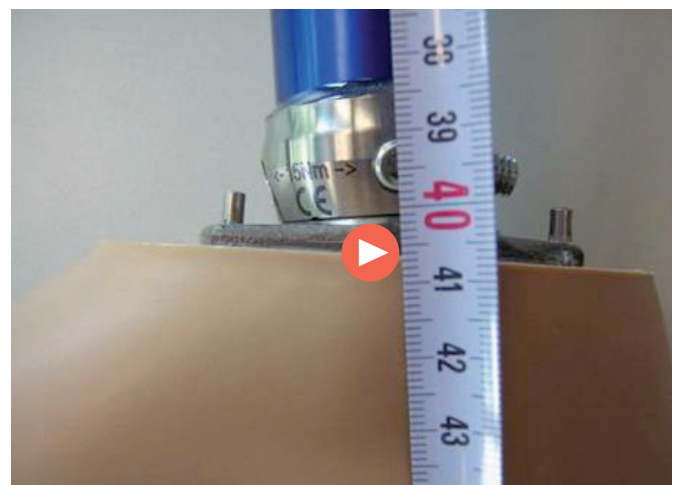
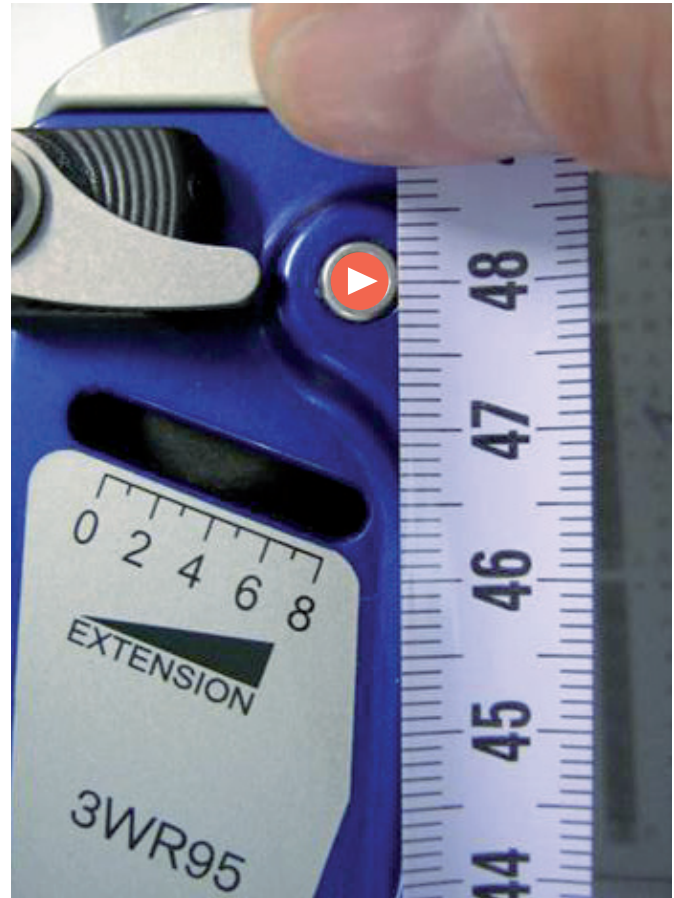
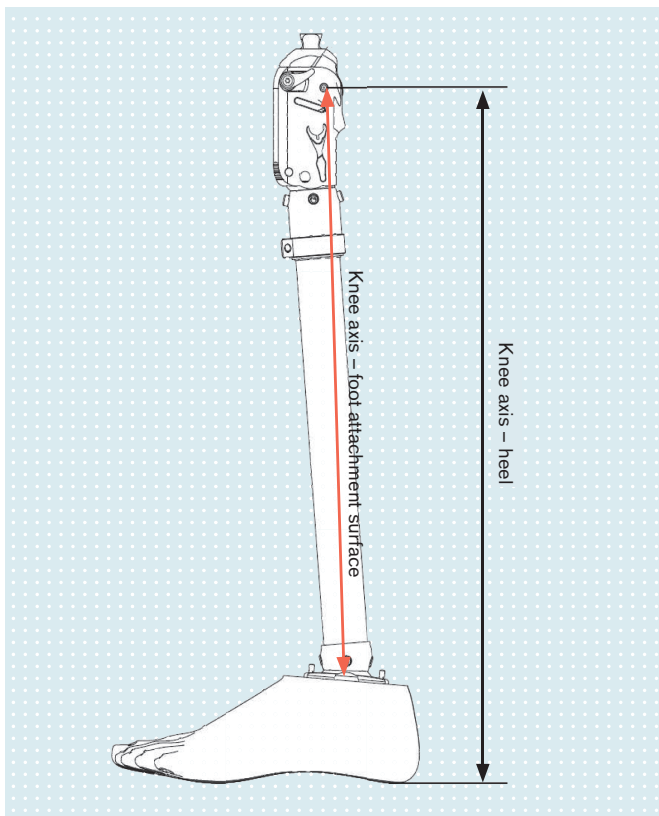

1

2

3

4



Cosmetic Foam Covers

After functionality, restoring the outward appearance is the most important factor for a prosthesis wearer. The cosmetic foam cover provides the prosthesis with an individual and natural shape.

Shaping the foam cover requires high technical skill. Ottobock has developed a process that makes work in the orthopaedic workshop far easier and significantly reduces the milling volume. Based on your data, the cosmetic foam cover is pre-milled by service fabrication according to your individual patient's needs.

Ottobock offers several ordering options to meet the individual needs of your patient.

1

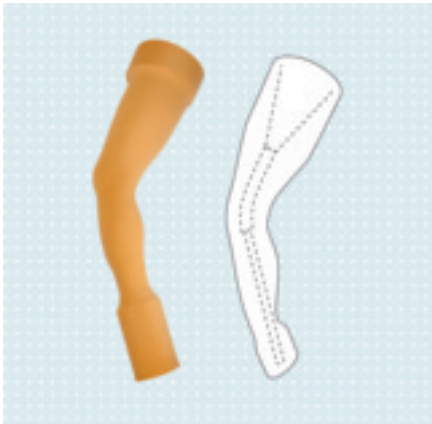

Cosmetic foam cover with conical inner bore

2



3

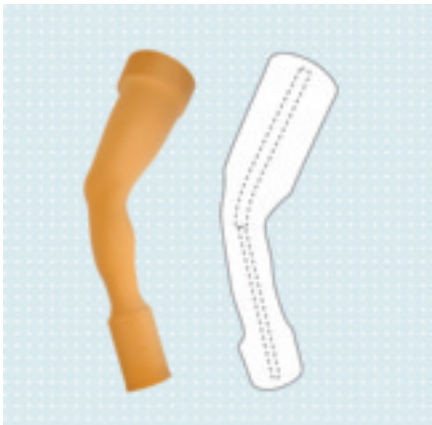

Cosmetic foam cover without conical inner bore

4

Information on the Ordering Process

Take the patient's measurements and complete the measurement form.

Please send the measurement form to Ottobock Service Fabrication.

Ottobock Service Fabrication will fabricate the individual cosmetic foam cover for you and ship it within 1 working day.

Now you can offer an individual, natural form of the prosthesis, thereby helping to restore your patient's outward appearance.

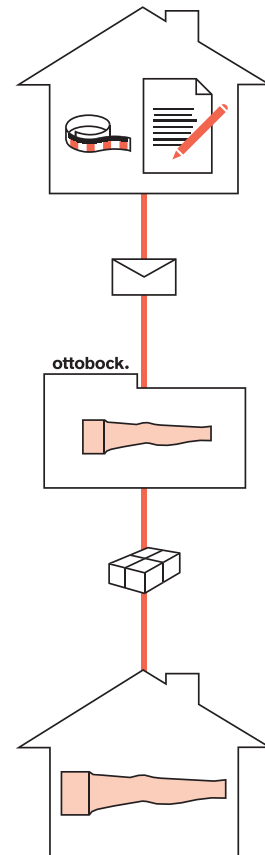

1

2

3

4

Custom Cosmetic Foam Covers

Measurement form

1

Contact	<input type="text"/>	Customer number	<input type="text"/>	Date	<input type="text"/>
Customer			Shipping address (if different from customer address)		
Company	<input type="text"/>		Company	<input type="text"/>	
Street	<input type="text"/>		Street	<input type="text"/>	
Postal code/city	<input type="text"/>		Postal code/city	<input type="text"/>	
Email	<input type="text"/>		Phone	<input type="text"/>	
Patient ID	<input type="text"/>				

Affected side: Left Right Knee type:

2

Interior bore conically enlarged

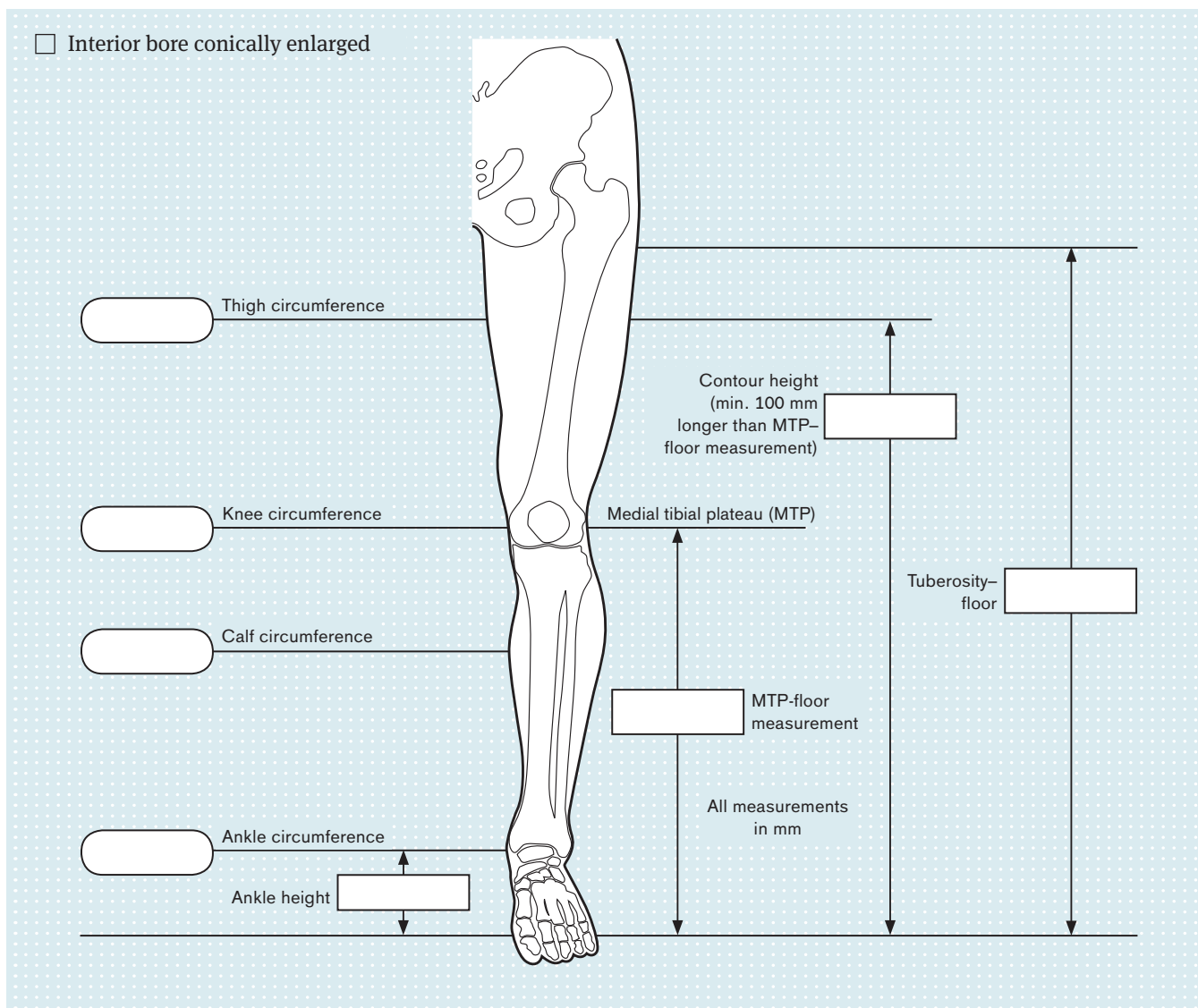

3

4

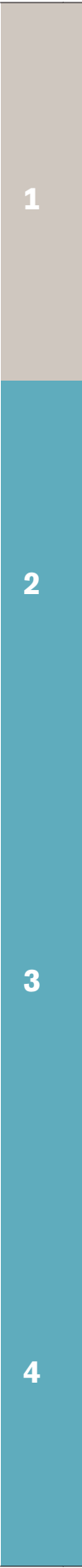
A large grid of small dots, arranged in approximately 30 rows and 30 columns, covering most of the page. This grid is used for taking measurements of cosmetic foam covers.

1

2

3

4



Coating with SuperSkin

SuperSkin coating technology provides a high-quality PUR coating and refinement for cosmetic foam covers based on PUR or PE or on laminated resin materials. 18 skin tones allow the colour to be individually adjusted. With the SuperSkin coating, an appealing appearance is achieved which increases the quality of the fitting. The SuperSkin coating protects the underlying materials against contamination and moisture. It is easy to clean with a damp cloth and soap. SuperSkin is skin-friendly and UV-resistant.

1

2

3

4

Ottobock offers several ordering options to meet the individual needs of your patient.

1

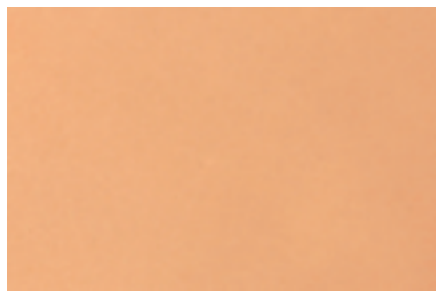

Visual effect: base colour

2

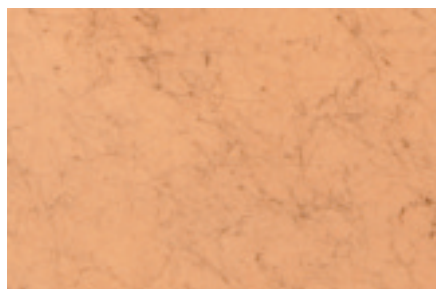

Visual effect: hair

3

4

Tools

646M13 SuperSkin Sampler Ring

The sampler ring is used for the visual and haptic demonstration of the various colour samples. It supports choosing the desired hue.



1

2

3

4

Information on the Ordering Process

1

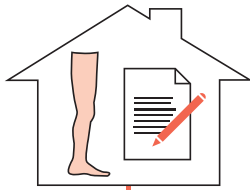

You already have a cosmetic foam cover or lamination resin prosthesis and enter the desired colour on the order form.



Send the prosthesis along with the order form to Ottobock Service Fabrication.

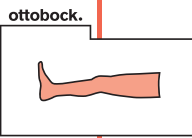

Ottobock Service Fabrication will coat the prosthesis/cosmetic foam cover with SuperSkin and send it back to you within 4 working days.

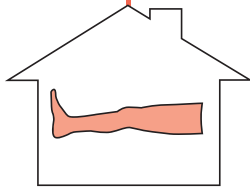

You receive a prosthesis/cosmetic foam cover with a visually appealing coating that protects against dirt and moisture.

2

3

4

SuperSkin Coating

Order form

Contact		Customer number		Date	
Customer			Shipping address (if different from customer address)		
Company			Company		
Street			Street		
Postal code/city			Postal code/city		
Email			Phone		
Patient ID					

- Skin colour no.** (see 646M13 Colour Sample Set)
 Visual effect hair

- | | |
|---|--|
| <input type="checkbox"/> Brown (14) | <input type="checkbox"/> Signal violet (4008) |
| <input type="checkbox"/> Dark red (18) | <input type="checkbox"/> Gentian blue (5010) |
| <input type="checkbox"/> Pure white (9010) | <input type="checkbox"/> Pastel turquoise (6034) |
| <input type="checkbox"/> Bright yellow (1026) | <input type="checkbox"/> Light grey (7035) |
| <input type="checkbox"/> Purple red (3001) | <input type="checkbox"/> Black (9011) |
| <input type="checkbox"/> Traffic red (3020) | <input type="checkbox"/> Gold (1050) |

Comments:

.....
.....
.....
.....
.....
.....
.....

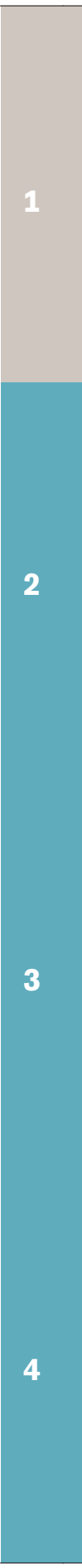

1

2

3

4



Customised Silicone Covers for the Lower Limbs

The fitting with a silicone cover for lower limb prostheses helps restore a deceptively genuine outward appearance. Individual Silicone Covers for the lower limbs can be used with the feet: 1C30, 1C40 and 1E56. Silicone products are hygienic and easy to clean.

Ottobock offers several ordering options to meet the individual needs of your patient.



"Natural" Silicone Cover

- Anatomical shape
- 8 to 10-colour silicone cover
- Anatomical surface structure
- Multicoloured toenails made of silicone or acrylic

For this version, the patient must visit an Ottobock Competence Centre. Prior to final finishing, the patient may come for a follow-up appointment in order to optimise the aesthetic appearance.

Hair

Individually matched to the contralateral side, colour, length, shape and density of hair can be realised by request.



1

"Classic" and "Natural" silicone nails

- Customised 5-colour silicone toenails



2

"Classic" and "Natural" acrylic nails

- Customised 5-colour acrylic toenails
 - Deceptively realistic surface characteristics
 - Suitable for nail polish

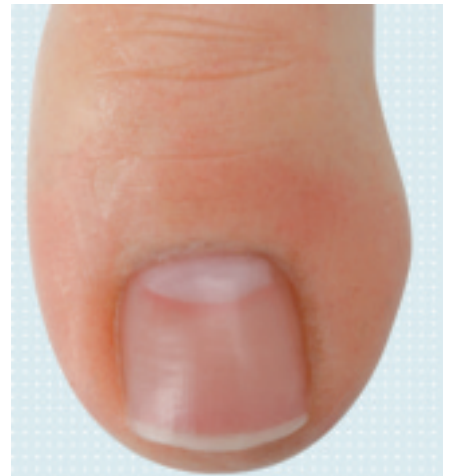

3

4

Ottobock offers several accessories for taking impressions and determining the colour of a Silicone Cover. An overview of the available options is found on this page.

Tools

1



89D4 Colour ring

The colour ring helps you determine your patient's basic skin tone. In doing so, you provide the service fabrication technicians with additional information so that they can make the prosthesis as realistic as possible.

2



647F285=GB Colour sheet

The colour sheet facilitates determining the individual colour for the "Classic" version. Four photos of the affected and contralateral sides are taken on the colour sheet and sent to Ottobock Service Fabrication.

3

4

Information on the Ordering Process

Measure the patient's contralateral side and complete the measurement form. Also please take an impression and photo of the contralateral side, and determine the colour depending on the type of prosthesis with the help of the colour sheet (647F285=GB).

Please send the prosthesis to be coated, along with

- the measurement form,
- the colour determination documents,
- the impression of the contralateral side, and
- the photos

to Ottobock Service Fabrication.

Ottobock Service Fabrication will fabricate the definitive Silicone Cover for you and ship it within 20 working days.

You receive an easy to clean, functional Silicone Cover that helps restore the outward appearance of your patient.

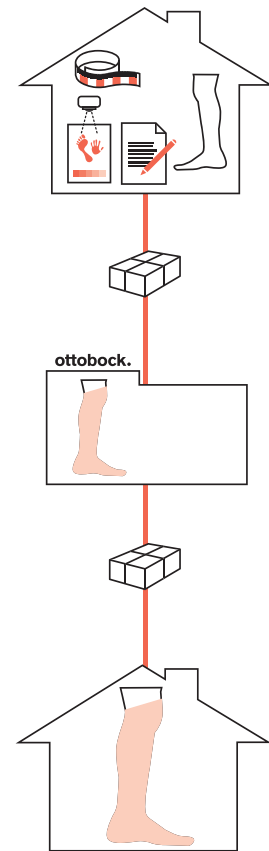

1

2

3

4

Lower Limb Silicone Cover

Order form

1

Contact	Customer number	Date
Customer		Shipping address (if different from customer address)
Company	Company	
Street	Street	
Postal code/city	Postal code/city	
Email	Phone	
Patient ID		

2

Age:

Gender: Female Male

Affected side: Left Right

Size:

Weight:

Mobility grade: 1 2 3 4



Configuration

- 88A20** "Natural" silicone cover
- 88A32=S** Silicone Nails (multicoloured)
- 88A32=A** Acrylic Nails (multicoloured)
- Colour determination as per colour determination sheet
- 88A20=H** Genuine Leg Hair (from contralateral side)

Prosthetic feet*

- 1C30
- 1C40
- 1E56

Prosthetic foot length in cm:

Heel height in mm:

3

Scope of delivery:

- Complete checklist
- Assembled prosthesis
- Cast of the contralateral side
- Photos

* Hallux separation impossible.

4

Comments:

.....

.....

.....

.....

.....

.....

.....

Lower Limb Silicone Cover

Measurement form

Contact		Customer number		Date	
---------	--	-----------------	--	------	--

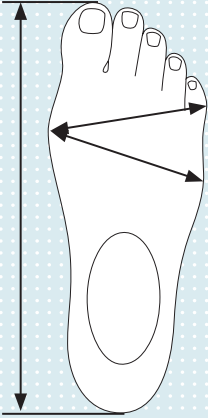
	Circumference (mm)	Foot	Plaster	Model
			To be filled out by prosthetist	To be filled out by Ottobock
Little toe – Ball of big toe
Ball of little toe – Ball of big toe
Overall foot length (in mm)
Ball width (in mm)
Little toe – ball width (in mm)
Bony width below lateral ankle (in mm)

Comments:

.....

.....

.....

.....

.....

.....

.....

.....

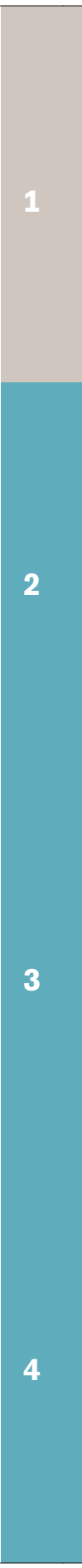

Lower Limb Silicone Cover

Measurement form

1

Contact	Customer number	Date
---------	-----------------	------

2

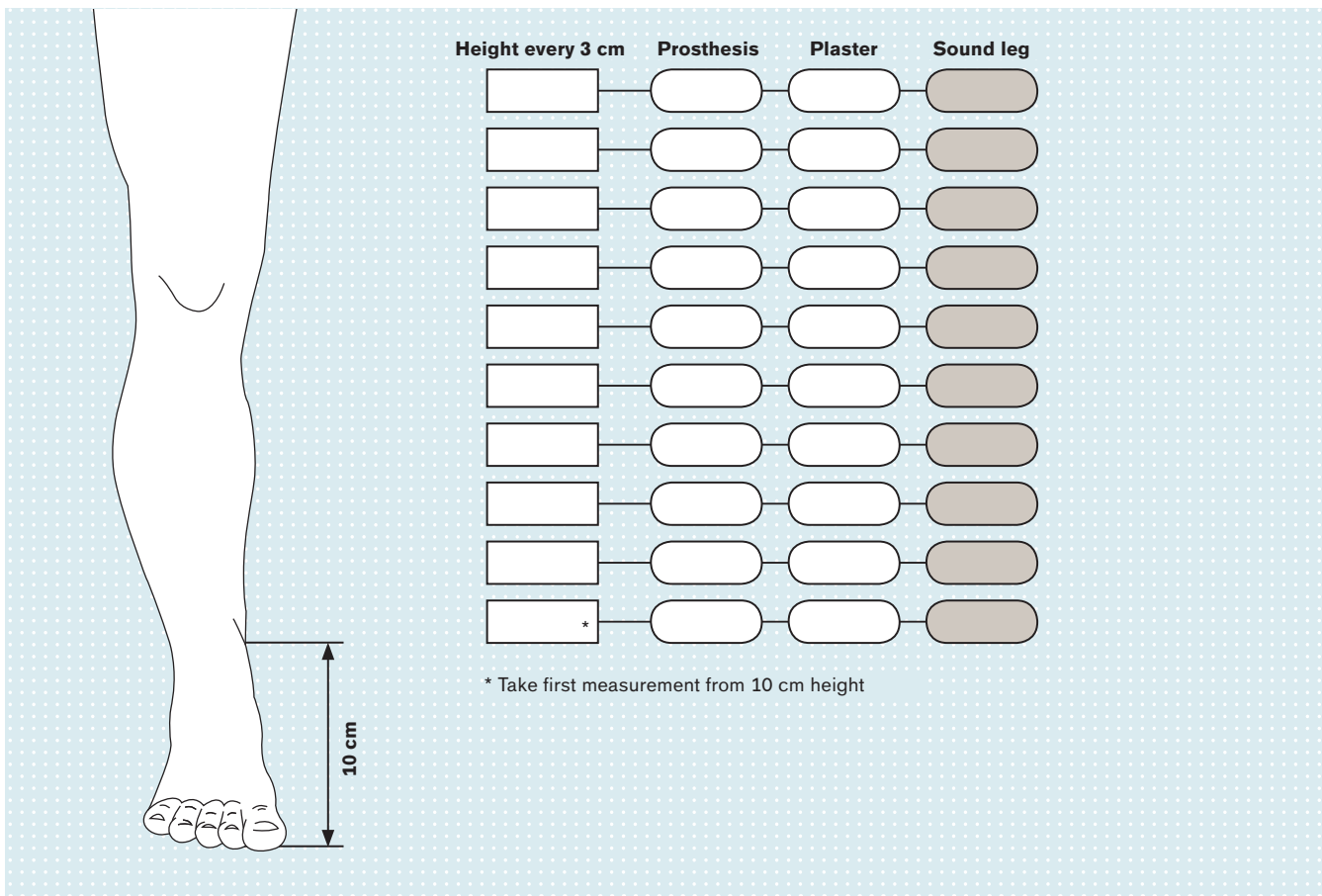

The diagram shows a line drawing of a lower limb (calf and foot) with a vertical line indicating a 10 cm measurement from the heel to the start of the measurement points. To the right, a table is provided for recording measurements every 3 cm. The table has four columns: 'Height every 3 cm', 'Prosthesis', 'Plaster', and 'Sound leg'. Each row corresponds to a 3 cm segment, with the first row starting from a 10 cm height. The 'Sound leg' column contains shaded oval shapes representing the measurement points.

Height every 3 cm	Prosthesis	Plaster	Sound leg
*			

* Take first measurement from 10 cm height

3

Comments:

.....

.....

.....

.....

.....

.....

.....

4

Lower Limb Silicone Cover

Colour determination sheet

Contact	Customer number	Date
---------	-----------------	------

Colour sample – colour strength

Use pen to mark skin colours on the sketch

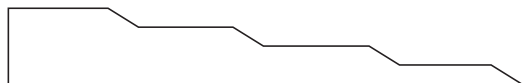

IV	III*	II	I
Pen	Colour sample	Colour strength	
1			
2			
3			
4			
5			
6			
7			
8			
9			
10			

Model blood vessels: Yes No

* Thickness III is recommended for the primer.

Nails

Acrylic

Silicone

Nail length

Like photo

mm longer

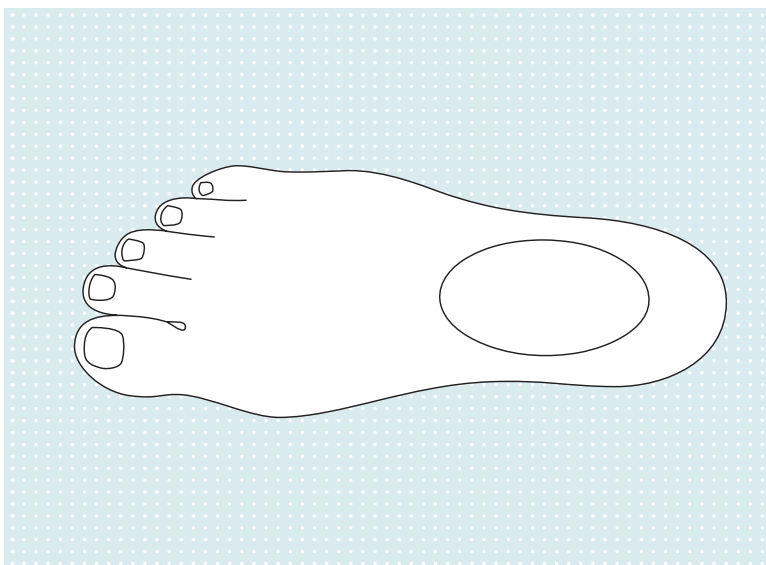
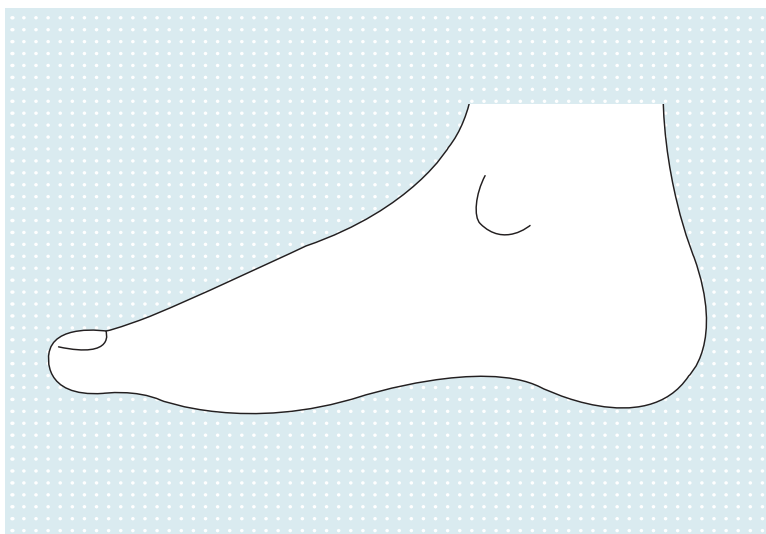

	Hallux	Toes II – V
Nail tip		
Distal edge		
Central		
Proximal edge		
Moon		

Comments:

.....

.....

.....

.....

.....

1

2

3

4

Lower Limb Silicone Cover

Colour determination sheet

1

Contact	Customer number	Date
---------	-----------------	------

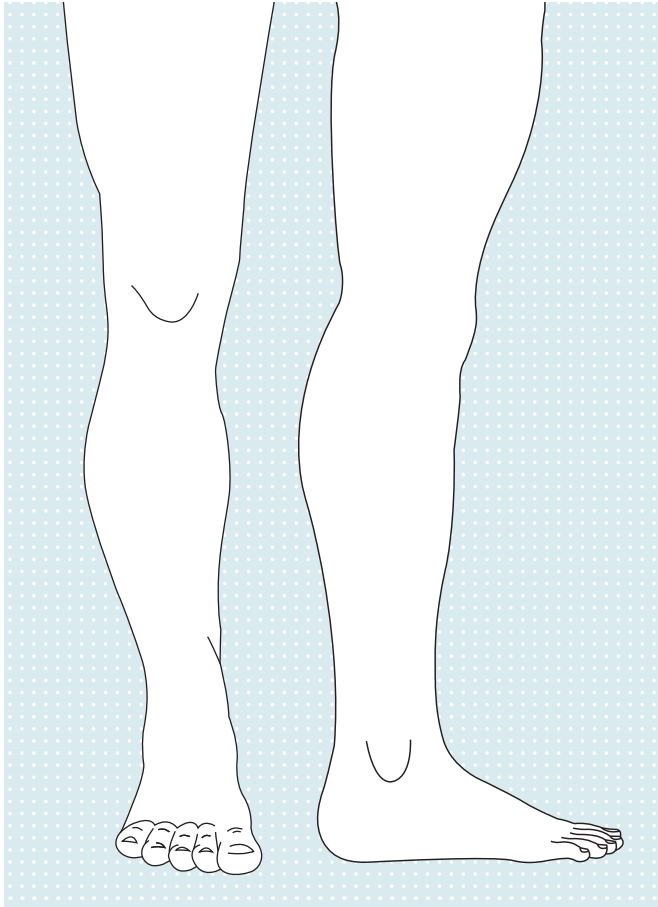

Colour sample – colour strength

Use pen to mark skin colours on the sketch

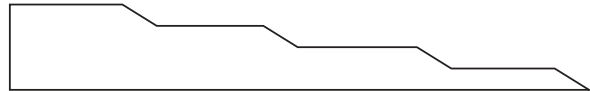

	IV	III*	II	I
Pen	Colour sample	Colour strength		
1				
2				
3				
4				
5				
6				
7				
8				

* Thickness III is recommended for the primer.

2

3

Comments:

.....

.....

.....

.....

.....

.....

.....

.....

.....

.....

4

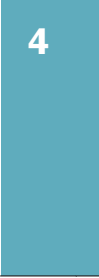
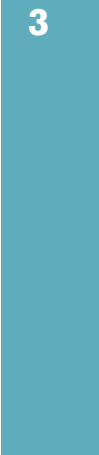
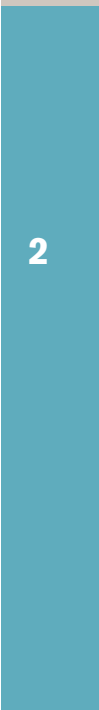
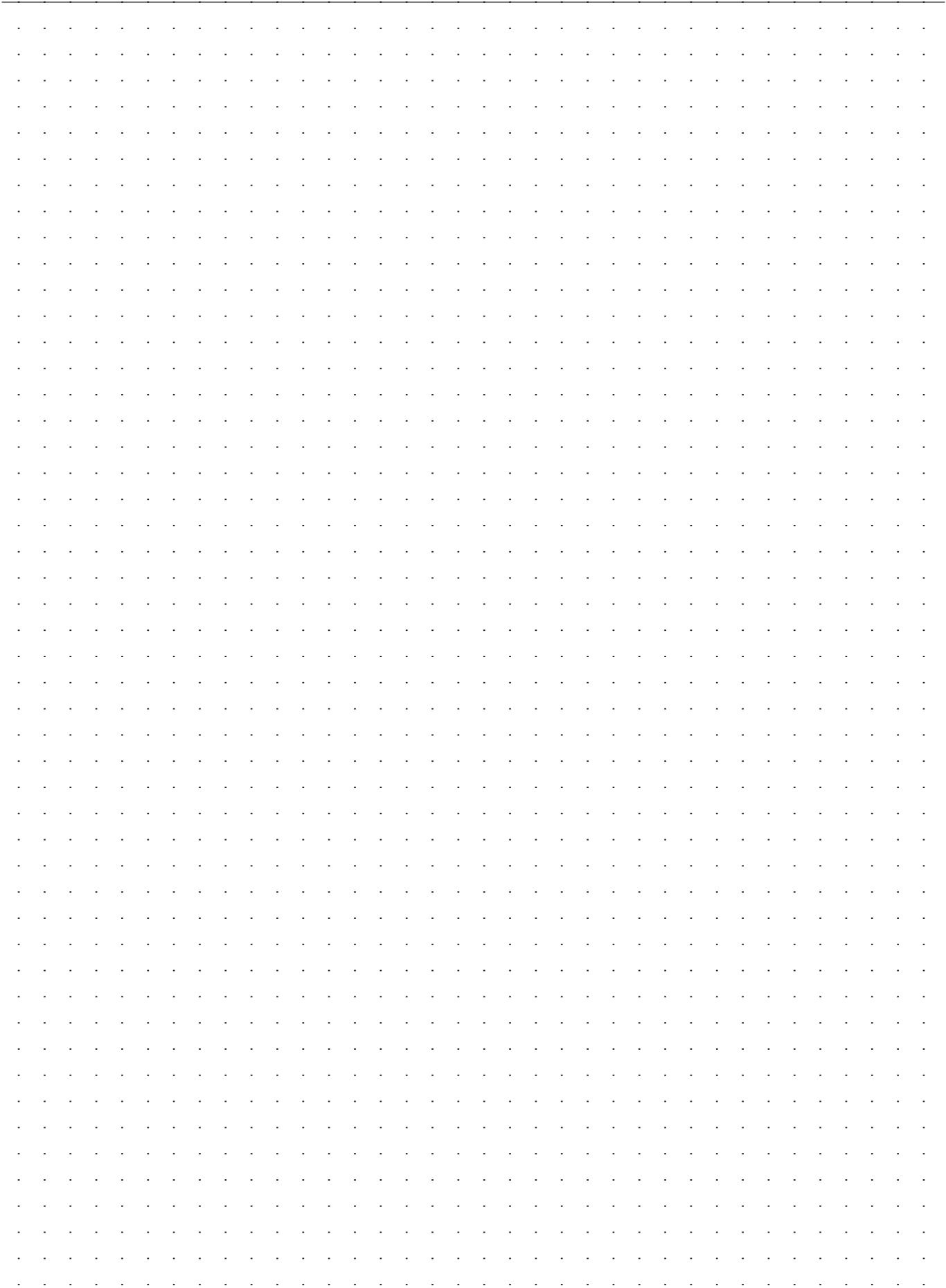

1

2

3

4

1

2

3

4



Silicone Forefoot Prostheses

Silicone Forefoot Prostheses harmonise the gait pattern and contribute to the physiological rollover of the foot. Surface adhesion along with a form-fitting brim secures the prosthesis on the residual limb. The custom design of the prosthetic socket provides a perfect fit, even pressure distribution and compression of the residual limb. The thin socket design also allows the patient to wear standard shoes with no problem. Silicone prostheses are hygienic and easy to clean. They can be washed with soap and water. If they become heavily soiled, they can be cleaned by boiling.

1

2

3

4

Ottobock offers several ordering options to meet the individual needs of your patient.

**"Basic", "Classic" and "Natural" Trial Prosthesis
(not illustrated)**

- Chlorosil and Pastasil Trial Prosthesis
 - Allows compression and Forefoot Prosthesis position to be adjusted within the four-week trial fitting period
-



"Basic" Silicone Forefoot Prosthesis

- Customised socket design
- Anatomical shape
- Silicone foot in one colour
- Silicone nails in skin tone
- Basic surface structure



"Classic" Silicone Forefoot Prosthesis

- Customised socket design
- Customised anatomical shape
- 2-3 individual skin tones, matching the contralateral side
- Anatomical surface structure
- Customised nail design

1

2

3

4

1

2

3

4



"Natural" Silicone Forefoot Prosthesis

- Customised socket design
- Customised anatomical shape
- 6-8 individual skin tones, matching the contralateral side
- Anatomical surface structure
- Custom, multicoloured nail design

For this version, the patient must visit an Ottobock Competence Centre. Prior to final finishing, the patient may come for a follow-up appointment in order to optimise the aesthetic appearance.

"Basic" and "Classic" standard nails

- Silicone toenails in one colour, with colour-matched tip

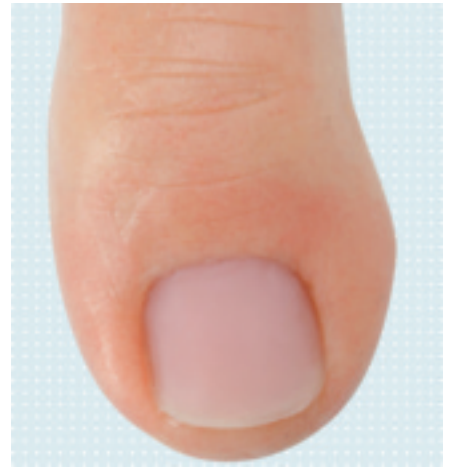

1

"Classic" and "Natural" silicone nails

- Customised 5-colour silicone toenails



2

"Classic" and "Natural" acrylic nails

- Customised 5-colour acrylic toenails
 - Deceptively realistic surface characteristics
 - Suitable for nail polish

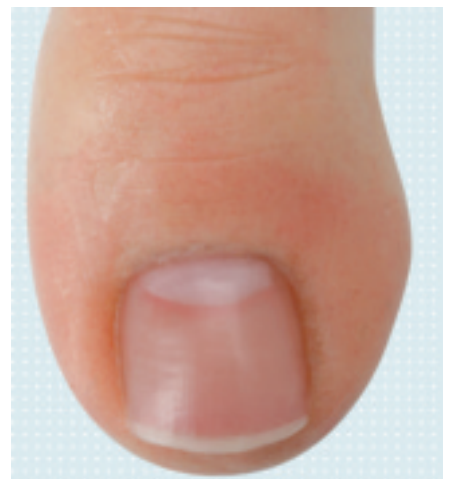

3

4

Ottobock offers accessories for taking impressions and determining the colour of a silicone forefoot prosthesis. An overview of the available options is found on this page.

Tools

1



89D4 Colour ring

The colour ring helps you determine your patient's basic skin tone. In doing so, you provide the service fabrication technicians with additional information so that they can make the prosthesis as realistic as possible.

2



647F285=GB Colour sheet

The colour sheet facilitates determining the individual colour for the "Classic" version. Four photos of the affected and contralateral sides are taken on the colour sheet and sent to Ottobock Service Fabrication.

3

4

Information on the Ordering Process

As the orthopaedic technician, you are responsible for determining the shape and colour as well as ordering the prosthesis:

The **shape** includes:

- Measuring the patient's residual limb
- Completing the measurement form
- Taking 4 informative photos of the left and right foot
- Creating a plaster negative of the affected side

Note for the "Classic" version:

- Also prepare a negative for the contralateral side

Depending on the prosthesis version, **determine the colour using the colour sheet (647F285=GB) and the colour ring (89D4).**

The **order forms must be fully completed before placing the order.**

Ottobock Service Fabrication will fabricate the **Trial Prosthesis according to your specifications and ship it within 10 working days.**

You as the prosthetist can provide the trial prosthesis to your patient for approximately 4 weeks for testing. If required, you can modify the trial prosthesis yourself. After the test phase, please return the trial prosthesis to Ottobock Service Fabrication.

Ottobock Service Fabrication will fabricate the **definitive prosthesis according to your specifications and ship it within 15 working days.**

When the definitive prosthesis is received, you can fit your patient with an individual and functional Silicone Forefoot Prosthesis that helps to harmonise the gait pattern.

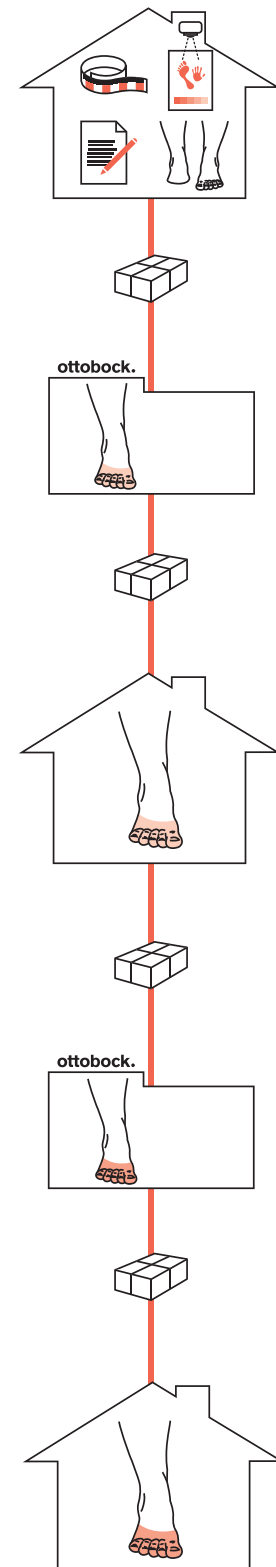

646T1=1.1GB (Technical Information "Measuring and Plaster Techniques for Fabricating a Silicone Forefoot Prosthesis in Service Fabrication")
 646A259=GB (Information for Practitioners "Silicone Forefoot Prosthesis")
 646D280=GB (Product Information "Silicone Forefoot Prosthesis")
 647F285=GB (Information for Practitioners "Colour Sheet for Silicone Products")

Silicone Forefoot Prosthesis

Order form

1

Contact	Customer number	Date
Customer		Shipping address (if different from customer address)
Company	Company	
Street	Street	
Postal code/city	Postal code/city	
Patient name	Phone	

2

Age: Affected side: Left Right

Gender: Female Male Diabetic: Yes No

Height: Weight: Activity level: 1 2 3 4



Configuration

- 88A31=2** Trial prosthesis
- 88A31=1** Definitive prosthesis "Basic" – colour code per D 89D4
- 88A32=1** Definitive prosthesis "Classic"
- 88A32=3** Definitive prosthesis "Natural"

- Colour determination as per colour determination sheet
- Silicone Nails (uni-coloured)
- 88A32=S** Silicone Nails (multi-coloured)
- 88A32=A** Acrylic Nails

3

For the "Classic" and "Natural" versions, the following are also required:

- Colour determination sheet
- Photos with photo background
- Cast of contralateral side

Diagnosis

- Accident
- Diabetes
- Dysmelia
- Miscellaneous
- Leg length discrepancy
- Accompanying diseases

4

Comments:

.....

.....

.....

.....

.....

Silicone Forefoot Prosthesis

Measurement form

Contact	Customer number	Date
---------	-----------------	------

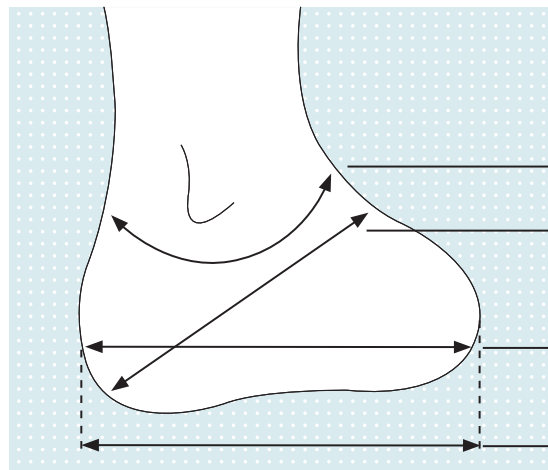

Measurements (in mm)	Residual limb	Plaster	Model
	Prosthetist	OttoBock	
Bow-shaped circumference (below medial and lateral ankle tip)	mm		
Circumference heel/back of foot (h-measurement)	mm		
Horizontal residual limb circumference (at the widest point)	mm		
m-l width measurement below the lateral ankle	mm		
Overall residual limb length	mm		

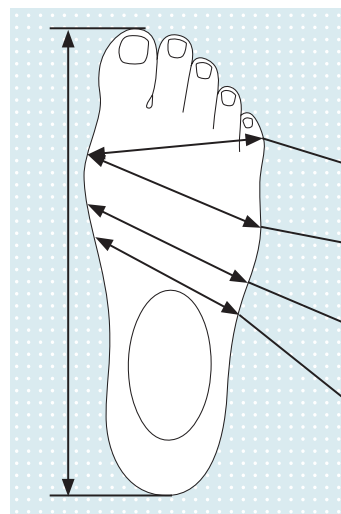

Circumference (mm)	Residual limb	Plaster	Model
	To be filled out by prosthetist		To be filled out by OttoBock
Little toe - Ball of big toe			
Ball of little toe - Ball of big toe			
Circumference in front of instep			
Instep circumference			
Overall foot length in mm:			

Comments:

.....

.....

.....

.....

.....

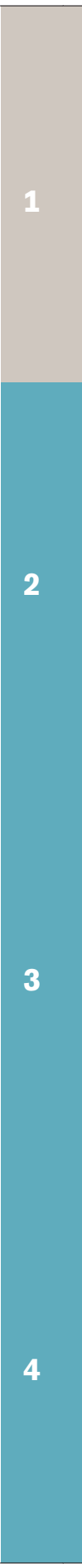

Silicone Forefoot Prosthesis

Colour determination sheet

1

Contact	Customer number	Date
---------	-----------------	------

Colour determination for "Classic" version

Use pen to mark skin colours on the sketch

Colour sample – colour strength

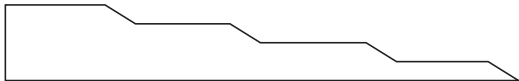

IV	III*	II	I
Pen	Colour sample	Colour strength	
1			
2			
3			
4			
5			
6			
7			
8			

Model blood vessels: Yes No

* Thickness III is recommended for the primer.

Nails

- Acrylic
- Silicone

Nail length

- Like photo
- mm longer

Colour

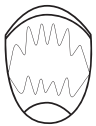

Nail tip _____

Distal edge _____

Central _____

Proximal edge _____

Moon _____

2

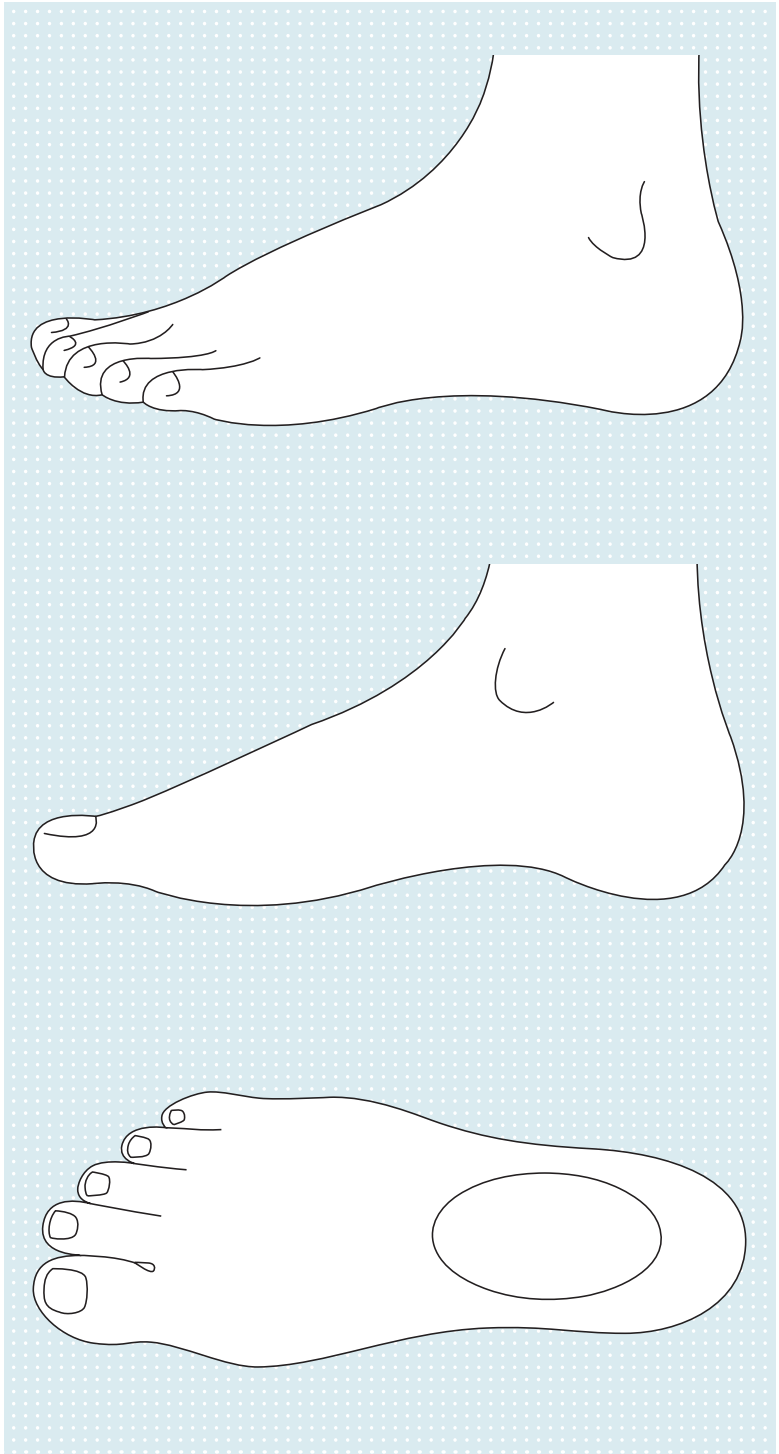

3

4

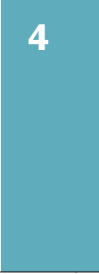
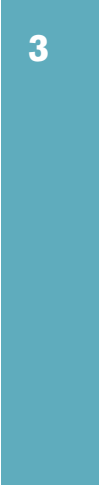
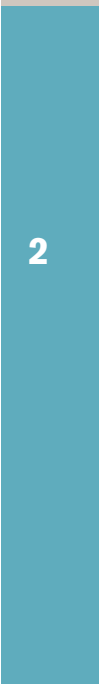
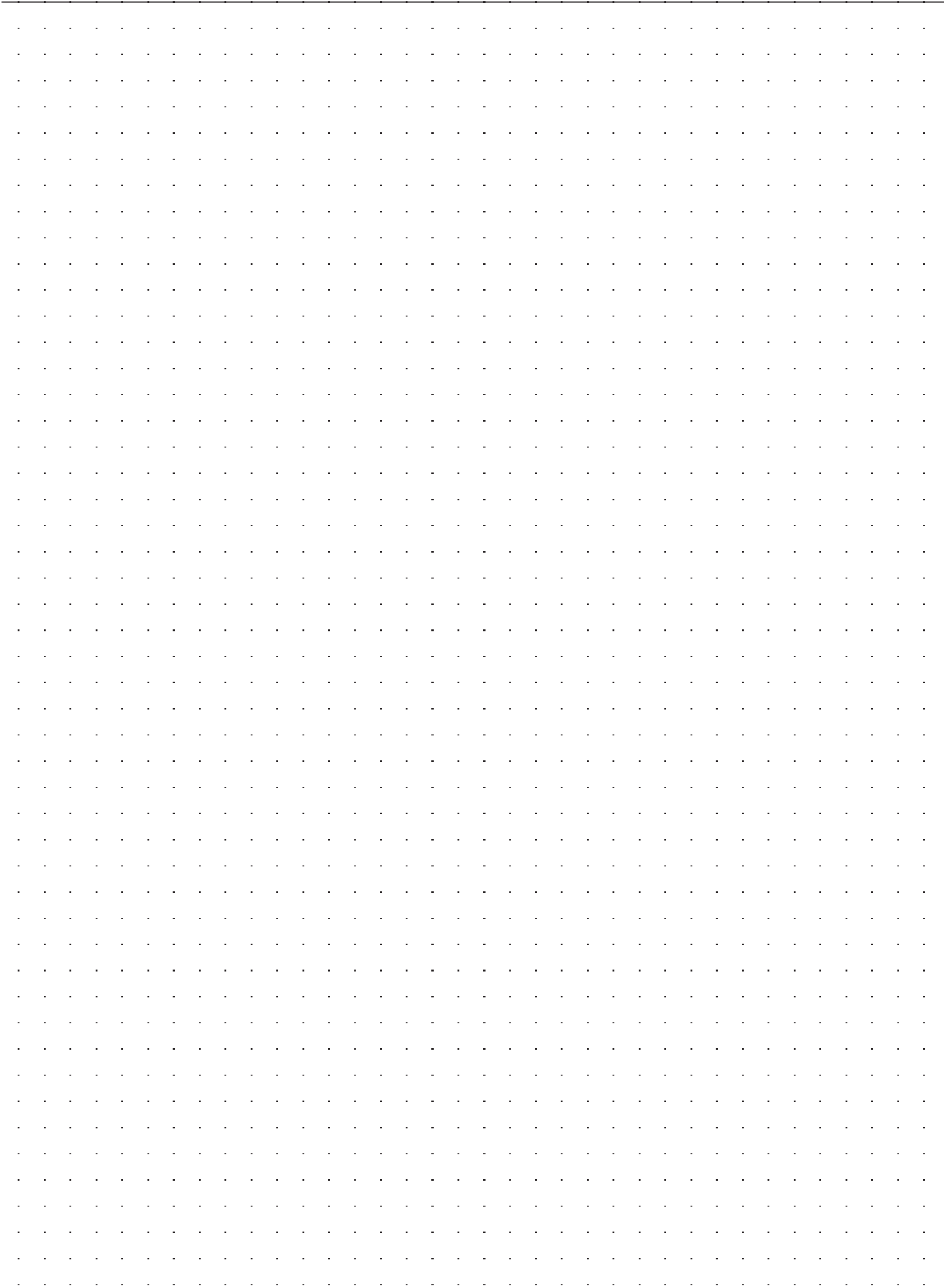

1

2

3

4

1



2



3

4

Silicone Toe Prostheses

Silicone Toe Prostheses harmonise the gait pattern and contribute to the physiological rollover of the foot. Surface adhesion along with a form-fitting brim secures the prosthesis on the residual limb. The custom design of the prosthetic socket provides a perfect fit, even pressure distribution and compression of the residual limb. Thanks to the thin-walled socket design, the patient can even wear regular, standard shoes. Silicone products are hygienic and easy to clean. They can be washed with soap and water. If they become heavily soiled, they can be cleaned by boiling.

1

2

3

4

Ottobock offers several ordering options to meet the individual needs of your patient.

**"Basic", "Classic" and "Natural" Silicone Trial Prosthesis
(not illustrated)**

- Chlorosil and Pastasil Trial Prosthesis
- Allows compression and Toe Prosthesis position to be adjusted within the four-week trial fitting period



"Basic" Silicone Toe Prosthesis

- Customised socket design
- Anatomical shape
- Silicone toe prosthesis in one colour
- Silicone nails in skin tone
- Basic surface structure



"Classic" Silicone Toe Prosthesis

- Customised socket design
- Customised anatomical shape
- 2-3 individual skin tones, matching the contralateral side
- Anatomical surface structure
- Customised nail design

1

2

3

4

1

2

3

4



"Natural" Silicone Toe Prosthesis

- Customised socket design
- Customised anatomical shape
- 6-8 individual skin tones, matching the contralateral side
- Anatomical surface structure
- Custom, multicoloured nail design

For this version, the patient must visit an Ottobock Competence Centre. Prior to final finishing, the patient may come for a follow-up appointment in order to optimise the aesthetic appearance.

"Basic" and "Classic" standard nails

- Silicone toenails in one colour, with colour-matched tip

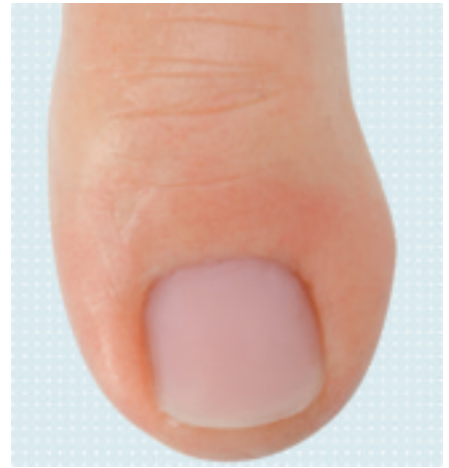

1

"Classic" and "Natural" silicone nails

- Customised 5-colour silicone toenails



2

"Classic" and "Natural" acrylic nails

- Customised 5-colour acrylic toenails
 - Deceptively realistic surface characteristics
 - Suitable for nail polish

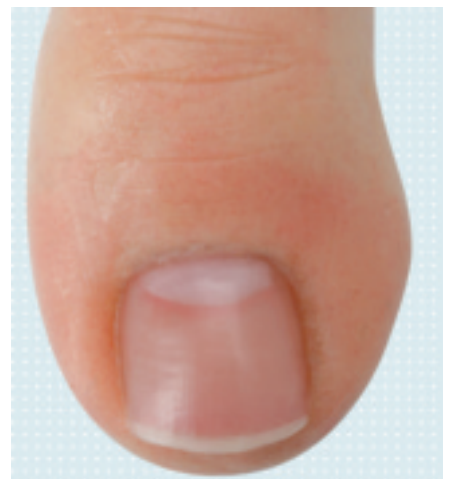

3

4

Ottobock offers accessories for taking impressions and determining the colour of a silicone toe prosthesis. An overview of the available options is found on this page.

Tools

1



89D4 Colour ring

The colour ring helps you determine your patient's basic skin tone. In doing so, you provide the service fabrication technicians with additional information so that they can make the prosthesis as realistic as possible.

2



647F285=GB Colour sheet

The colour sheet facilitates determining the individual colour for the "Classic" version. Four photos of the affected and contralateral sides are taken on the colour sheet and sent to Ottobock Service Fabrication.

3

4

Information on the ordering process

As the orthopaedic technician, you are responsible for determining the shape and colour as well as ordering the prosthesis:

The **shape** includes:

- Measuring the patient's residual limb
- Completing the measurement form
- Taking 4 informative photos of the left and right foot
- Creating a plaster negative of the affected side

Note for the "Classic" version:

- Also create a plaster negative for the contralateral side

Depending on the prosthesis version, **determine the colour using the colour sheet (647F285=GB) and the colour ring (89D4).**

The **order documents must be fully completed before placing the order.**

Ottobock Service Fabrication will fabricate the **Trial Prosthesis according to your specifications and ship it within 10 working days.**

You as the prosthetist can provide the trial prosthesis to your patient for approximately 4 weeks for testing. If required, you can modify the trial prosthesis yourself. After the test phase, please return the trial prosthesis to Ottobock Service Fabrication.

Ottobock Service Fabrication will fabricate the **definitive prosthesis according to your specifications and ship it within 15 working days.**

When the definitive prosthesis is received, you can fit your patient with an individual and functional Silicone Toe Prosthesis that helps to harmonise the gait pattern.

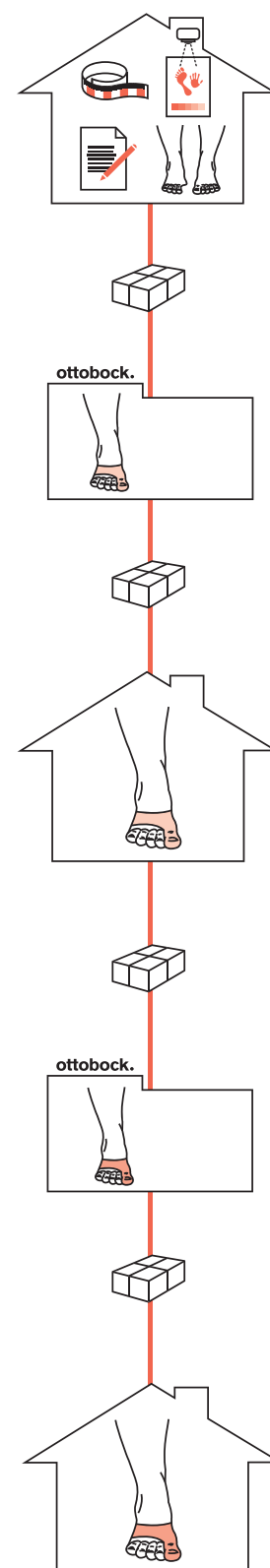

1

2

3

4



- 646T1=1.1GB (Technical Information "Measuring and Plaster Techniques for Fabricating a Silicone Forefoot Prosthesis in Service Fabrication")
- 646A259=GB (Information for Practitioners "Silicone Forefoot Prosthesis")
- 646D280=GB (Product Information "Silicone Forefoot Prosthesis")
- 647F285=GB (Information for Practitioners "Colour Sheet for Silicone Products")

Silicone Toe Prosthesis

Order form

1

Contact		Customer number		Date	
Customer			Shipping address (if different from customer address)		
Company			Company		
Street			Street		
Postal code/city			Postal code/city		
Email			Phone		
Patient ID					

2

Age:

Gender: Female Male

Height: Weight:

Affected side: Left Right

Diabetic: Yes No

Activity level: 1 2 3 4



Configuration

- 88A31=2** Trial prosthesis
- 88A31=1** Definitive prosthesis "Basic" – colour code per D 89D4
- 88A32=1** Definitive prosthesis "Classic"
- 88A32=3** Definitive prosthesis "Natural"

- Colour determination as per colour determination sheet
- Silicone Nails (uni-coloured)
- 88A32=S** Silicone Nails (multi-coloured)
- 88A32=A** Acrylic Nails

3

For the "Classic" and "Natural" versions, the following are also required:

- Colour determination sheet
- Photos with photo background
- Cast of contralateral side

Diagnosis

- Accident
- Diabetes
- Dysmelia
- Miscellaneous
- Leg length discrepancy
- Accompanying diseases

4

Comments:

.....

.....

.....

.....

.....

Silicone Toe Prosthesis

Measurement form

Contact	Customer number	Date
---------	-----------------	------

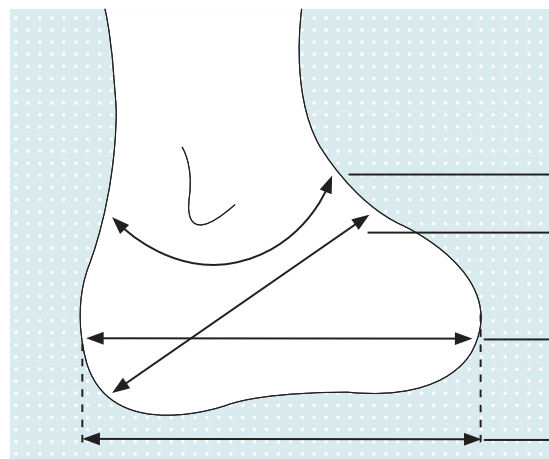

Measurements (in mm)	Residual limb	Plaster	Model
	Prosthetist	Ottobock	
Bow-shaped circumference (below medial and lateral ankle tip)	mm		
Circumference heel/back of foot (h-measurement)	mm		
Horizontal residual limb circumference (at the widest point)	mm		
m-l width measurement below the lateral ankle	mm		
Overall residual limb length	mm		

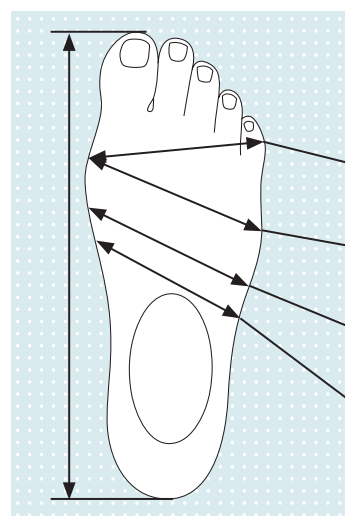

Circumference (mm)	Residual limb	Plaster	Model
	To be filled out by prosthetist	To be filled out by Ottobock	
Little toe – Ball of big toe			
Ball of little toe – Ball of big toe			
Circumference in front of instep			
Instep circumference			
Overall foot length in mm:			

Comments:

.....

.....

.....

.....

.....

1

2

3

4

Silicone Toe Prosthesis

Colour determination sheet

1

Contact	Customer number	Date
---------	-----------------	------

Colour determination for "Classic" version

Use pen to mark skin colours on the sketch

Colour sample – colour strength

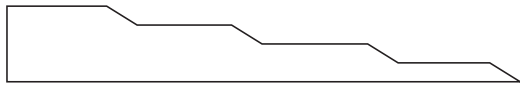

IV	III*	II	I
Pen	Colour sample	Colour strength	
1			
2			
3			
4			
5			
6			
7			
8			

Model blood vessels: Yes No

* Thickness III is recommended for the primer.

Nails

- Acrylic
- Silicone

Nail length

- Like photo
- mm longer

Colour



Nail tip

Distal edge

Central

Proximal edge

Moon

2

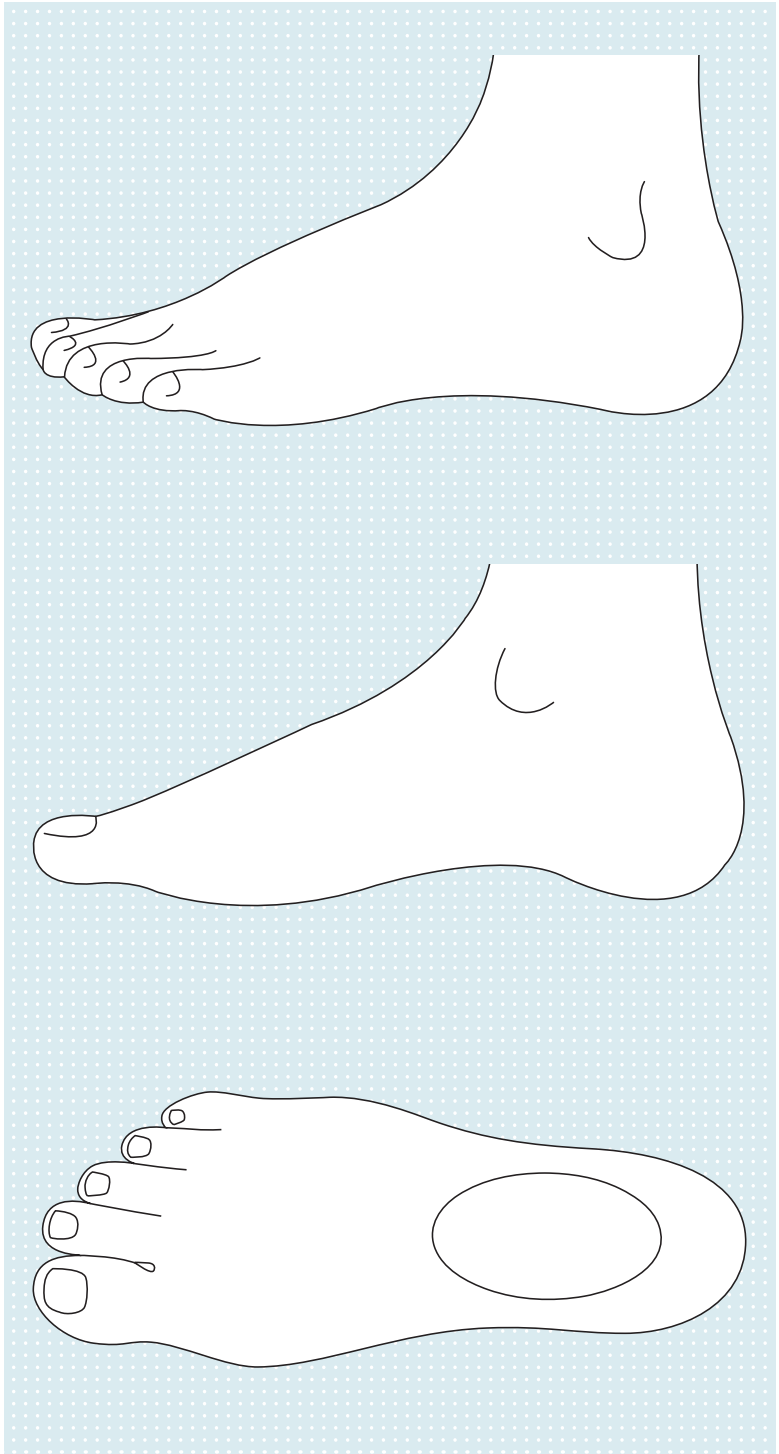

3

4

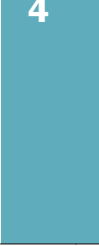
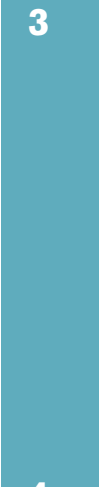
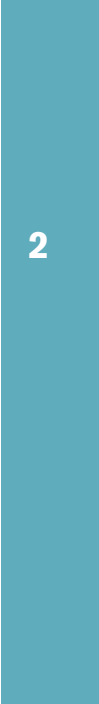
A large grid of dots for taking notes, consisting of 20 columns and 40 rows of small, evenly spaced dots.

1

2

3

4



Prosthetics - Upper Limbs

1

2

3

4

1

2

3

4



PAULA Check Sockets for Transradial Amputations

The Ottobock PAULA software features computer-supported application technology with numerous functions for customised design of transradial check sockets. A photometric method makes it possible to digitalise the residual limb data and visualise the 3-dimensional model of the socket on a PC. Ottobock Service Fabrication uses the submitted data to fabricate a thermoplastic check socket.

1

2

3

4

1

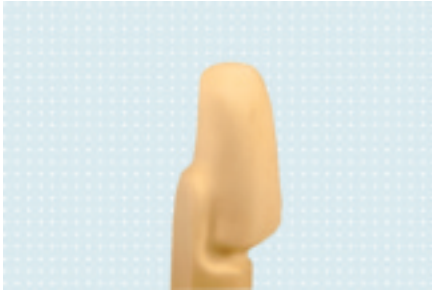

8T5=M Positive model

2



8T5=S Test socket

A TR socket made of ThermoLyn is fabricated by Ottobock service fabrication according to the specified data. The purchase of the 743R11 Ottobock TR design case includes all required tools.

Tools

3



743R11 TR design case

- 2 residual limb socks
- 1 calibrator for TR design
- 1 goniometer
- 1 calliper for TR design
- 1 tape measure
- 1 digital camera
- 1 black photo background
- 1 red felt-tip pen
- 100 adhesive hook and loop dots

4



99B90=2 Residual limb sock

6 per package

Information on the Ordering Process

Take lateral and frontal photos of the patient's residual limb in front of a black background. After entering the data, the photos can be edited using the software. The socket shape can be specified, and may be checked and modified using the 3D model.

Once you have selected the prosthesis components and services, save the order and send the data to Ottobock Service Fabrication by e-mail.

Ottobock Service Fabrication will fabricate the check socket for you and ship it within 3 working days.

You receive a check socket which meets your specifications precisely thanks to highly modern software.

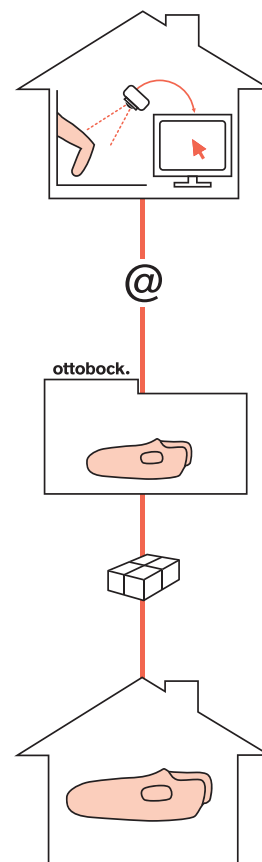

1

2

3

4

Socket Design using PAULA Software in five Steps:

1



1. Order Details

The patient's measurements are entered and the desired socket shape is established in the first step.

2



2. Photo View

The photos are processed in the second step. Individual patches may be put into place.

3



3. Socket View

In the third step, the TR can be visually inspected and adjusted as necessary.

4

4. Component Selection

In this second to last step, the amount of available space can be verified and suitable components according to the patient details can be selected.



1

5. Ordering from Ottobock Service Fabrication

In the final step, the chosen TR socket, components and services are displayed and explained one more time in a product description. Then the selected articles can be ordered in this step. The data are sent to Ottobock Service Fabrication by e-mail.



2

3

4

1

2

3

4

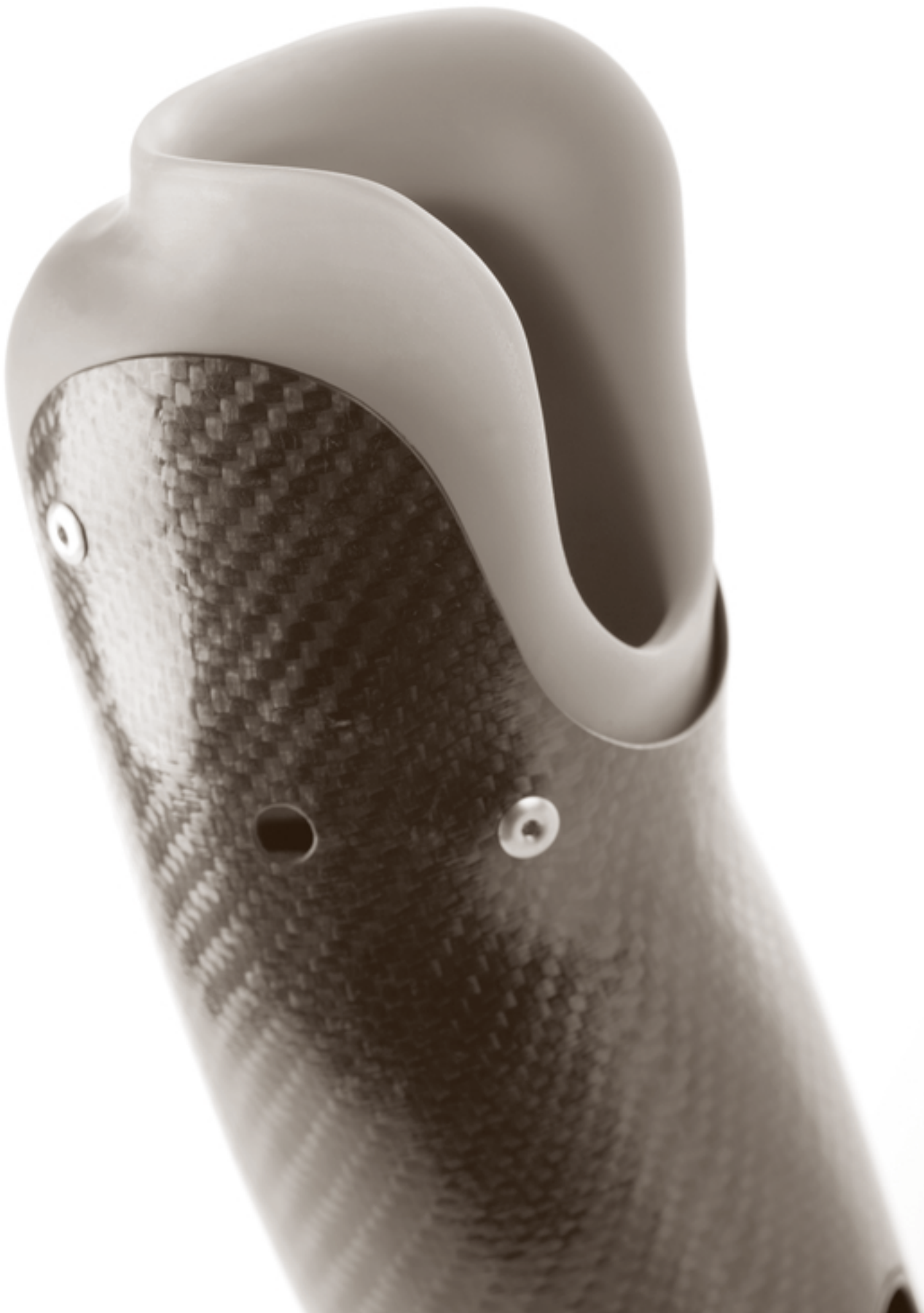

SiOCX TR Socket for Transradial Amputations

Ottobock's SiOCX TR Socket is a definitive new socket for upper limb amputations. With an innovative combination of high-tech materials, Ottobock has succeeded in significantly improving wearer comfort, flexibility, adhesion and customised socket fit. The SiOCX TR Socket consists of an HTV medical-grade silicone inner socket in combination with a carbon prepreg outer socket.

The inner socket material is breathable and hypoallergenic, can be sterilised and therefore assures improved hygiene. Adhesion of the socket on the residual limb is also improved. Using silicone with varying degrees of hardness as well as integrated gel cushions enhances wearer comfort, even for sensitive areas of the residual limb. The soft edge of the socket also increases the range of motion for the residual limb, making it easier to master everyday challenges. The flexible ulna opening in the carbon outer socket allows the residual limb to adapt when the arm is resting on something or during movement. This makes the prosthesis comfortable to wear, even for extended periods of time.

For myoelectric fittings, Ottobock additionally provides the option of integrating conductive silicone myoelectric contact surfaces into the HTV inner socket. The inlays allow myoelectric signals to be transmitted directly through the silicone socket to the electrodes. The positions of the myoelectric contact surfaces can be freely selected. The enclosed socket facilitates cleaning. The electrodes no longer have direct skin contact so skin irritation and soiling are reduced. Perspiration also does not reach the electrodes, which prevents corrosion damage to the electrical and mechanical components.

1



8T350=1 SiOCX TR Socket

- HTV medical-grade silicone inner socket (incl. silicone gel padding)
- Carbon prepreg outer socket

2



8T330=2 HTV Silicone Inner Socket

- HTV medical-grade silicone inner socket
- With silicone gel padding by request

3



8T860=1 Myoelectric contact surfaces

Myoelectric contact surfaces of conductive silicone can be integrated by request. They permit the transmission of myoelectric signals directly to the electrodes.

4

Information on the Ordering Process

You already have a trial fitted and possibly adapted check socket, or a definitive socket that fits well.

Please submit the socket or a plaster positive along with the completed order form to Ottobock Service Fabrication.

Ottobock Service Fabrication will fabricate a definitive silicone inner socket combined with a rigid foam casting form with hand adapter and ship it within 10 working days.

You then conduct the initial trial fitting and determine the final shape, position and length of the prosthesis.

Send the silicone socket with rigid foam casting form and hand adapter along with the completed order form to Ottobock Service Fabrication.

Ottobock Service Fabrication will fabricate the definitive SiOCX TR Socket and ship it within 7 working days – by request also as a fully preassembled prosthesis.

Now you can fit your patient with a definitive socket which offers enhanced comfort with improved hygiene and functionality thanks to an innovative combination of materials.

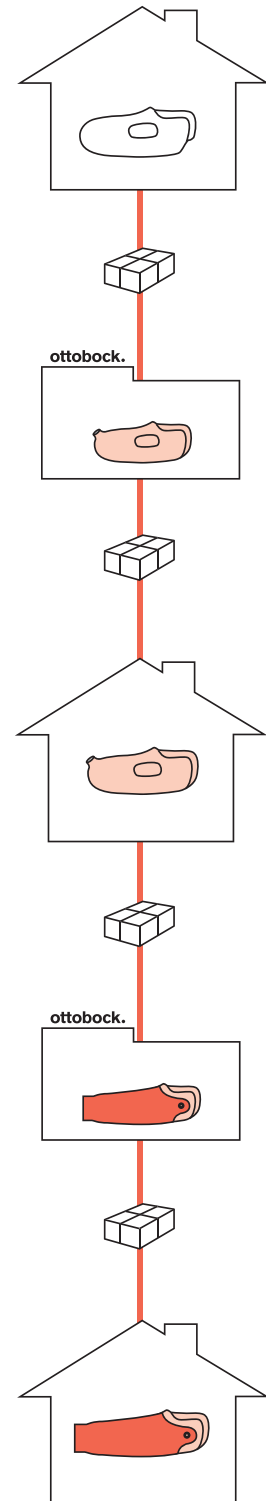

 646D438=GB ("SiOCX TR Socket" Information for Practitioners)

Ordering Information: 8T350=1 SiOCX TR Socket

Ordering a SiOCX TR Socket involves two fitting steps:

1

Fitting Step 1

For ordering please send the following to Service Fabrication:

- A plaster positive of a well-fitting check or definitive socket, or a well-fitting check or definitive socket. This serves as the basis for modelling.
- The socket should be worn until the residual limb volume fluctuations are minimised.

In order to minimise changes to the shape or volume of the residual limb, we recommend having the patient wear the well-fitting check or definitive socket until the new fitting is received.

2

- Please label the socket or plaster positive with the following:
 - The position of the electrodes
 - The position of the connection tube (e.g. tube valve for suction socket)
 - The fixation between the inner and outer sockets
 - The position, size and thickness of any soft padding
- The completed measurement form is also required.

What you receive:

A definitive silicone inner socket with a rigid foam casting form and a matching adapter for the respective hand type/suitable hand size. The initial trial fitting can be conducted using the rigid foam casting form, and the shape, position and length of the prosthesis can be modified.

Fitting Step 2

3

For fitting step 2, please send the following to Service Fabrication:

- The definitive silicone inner socket delivered in fitting step 1, with adapted rigid foam casting form and hand adapter:
 - In the correct position
 - With the length adapted
 - If desired, with marked flexible outer socket regions

What you receive:

The definitive SiOCX TR Socket.

4

SiOCX TR Socket

Order form

Contact		Customer number		Date	
Customer			Shipping address (if different from customer address)		
Company			Company		
Street			Street		
Postal code/city			Postal code/city		
Email			Phone		
Patient ID					

Affected side: Left Right

Fitting step 1

Silicone inner socket

Colour of the inner socket

- Skin colour
 Uni

Setting nut position

- Standard
 Own specification

Electrode receiver

- Without 13E202 13E200

Adapter for PVC connection tube

- 99B13=16 (small)
 99B13=21 (large)

Myoelectric contact surfaces

- Yes (surcharge)
 No

Rigid foam casting form

Olecranon – thumb measurement: mm Hand size:

Fitting step 2

Prepreg outer socket

Flexible outer socket areas

(please mark position and size)

Surface design

- Finished carbon design
 Skin colour

Length

- Accept
 Shorten by: mm

- Designer fabric art. no.:
 Water transfer printing (special order form)

Lamination ring

- Glue in place
 Enclose

Comments:

.....

HTV Silicone Inner Socket TR

Order form

1

Contact		Customer number		Date	
Customer			Shipping address (if different from customer address)		
Company			Company		
Street			Street		
Postal code/city			Postal code/city		
Email			Phone		
Patient ID					

Affected side: Left Right

2

8T330=2 HTV Silicone Inner Socket transradial

Colour of the inner socket

- Skin colour
- Uni

Adapter for PVC connection tube

- 99B13=16 (small)
- 99B13=21 (large)

Setting nut position

- Standard
- Own specification

Myoelectric contact surfaces

- Yes (surcharge)
- No

Electrode receiver

- Without
- 13E202
- 13E200

3

Comments:

.....

.....

.....

.....

.....

.....

4

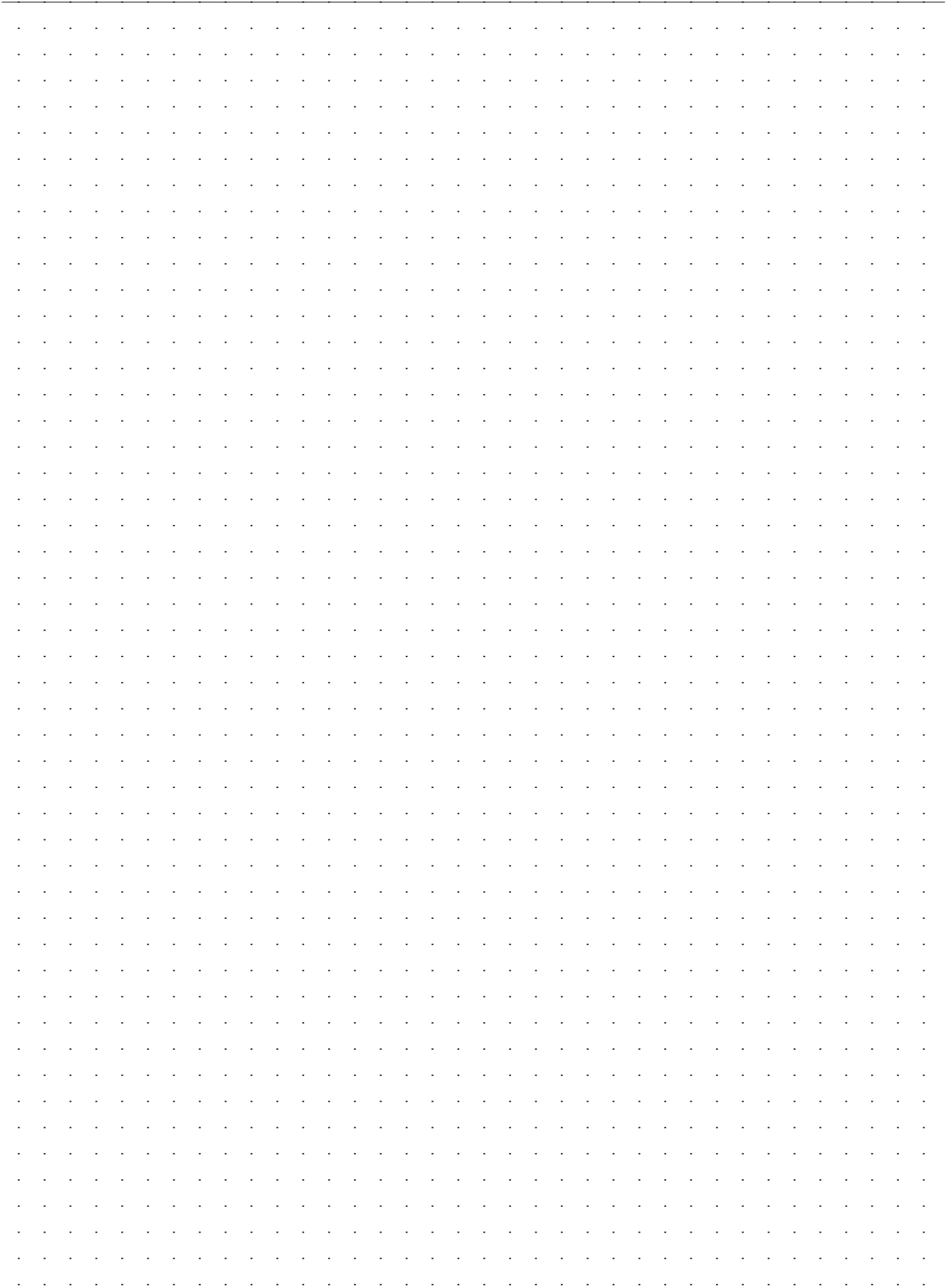

1

2

3

4

1

2

3

4



Customised Silicone Liners for the Upper Limb

Fittings with customised silicone liners facilitate optimal contact between the skin and liner, even for highly unusual residual limb shapes. Patient-specific customisation based on a plaster model makes it possible to accommodate the patient's individual residual limb situation and to provide even unusual residual limbs with a liner. Customised silicone liners for upper limb fittings are used when there are no standard liner fittings available for the respective residual limb size. This can be the case with children – i.e. small residual limb sizes – or in the case of extremely large residual limb sizes. Customised silicone liners are also used for patients who have a complex residual limb situation. Complex residual limb situations are residual limbs with neurologically sensitive or bony areas, dysmelia or deep scarring. A customised silicone liner is also recommended for highly active patients, who place special demands on the liner fitting.

1

2

3

4

Ottobock offers several ordering options to meet the individual needs of your patient.

1



Liner with pin receiver

- For fixation in the socket
- M10 thread

2



Liner with silicone wedge

Instead of a pin, silicone wedges may be used to hold the liner in place. Silicone wedges do not change the structural height, making them particularly well suited for long residual limbs.

3



Liner with strap

The strap is integrated in the silicone liner and does not change the structural height. It is therefore recommended for long residual limbs. In addition to the fixation function, the strap reduces rotational movement in the socket and makes it easier to slip into the prosthetic socket.

4



Electrode window

For patients with a myoelectrically controlled prosthesis, individually positioned windows for direct electrode-skin contact can be integrated into the silicone liner.

When the Myo-Liner is selected, the electrode windows are already included.

Myoelectric contact surfaces

Myoelectric contact surfaces of conductive silicone can be integrated by request. They permit the transmission of myoelectric signals directly to the electrodes.

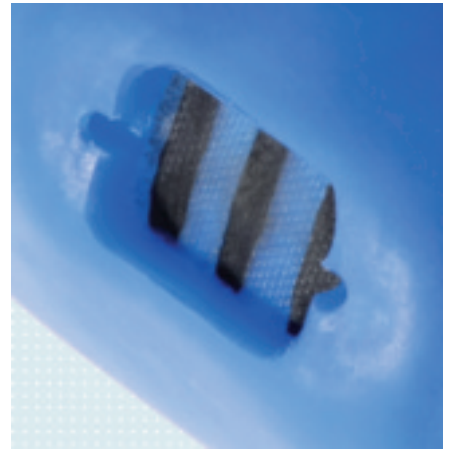

1

Extension strips

The integration of extension strips reduces the elasticity of the liner, thus reducing pistoning.



2

Anti-rotation wedge

To reduce rotation between the socket and liner, the anti-rotation wedge can also be integrated into the silicone socket.



3

Textile cover

Grey and skin-coloured textile covers are available for the liner.



4

Additional Options:

- Shore hardness: different degrees of silicone hardness are available for various residual limb situations. The higher the silicone hardness, the less yielding the silicone liner will be.
- Silicone thickness: the thickness of the silicone can be chosen according to various levels of activity.
- Silicone gel coating – this is a coating on the inner wall of the liner that increases adhesion of the liner on the skin. The gel coating helps create maximum adhesion on a minimal residual limb.
- Residual limb end pad – this is a soft silicone cushion integrated into the liner. It serves as padding for points that are sensitive to pressure and pain.
- With a textile-coated silicone liner, it is easier for the patient to slip into the prosthesis. This eliminates the need for donning spray.

Colour:

- The patient can normally choose between a skin-coloured or translucent silicone liner.
- It is also possible to accommodate the patient's personal colour wishes.

1

2

3

4

Information on the Ordering Process

Prepare a reduced plaster positive (the circular reduction should be 5% to 10%, depending on the soft tissue situation), measure the patient's residual limb and enter all required information on the measurement form and the plaster model.

Send the reduced plaster positive along with the measurement form to Ottobock Service Fabrication.

Ottobock Service Fabrication will fabricate the silicone liner for you and ship it within 8 working days.

Now you can fit patients with an unusual residual limb shape or complex residual limb situation with an optimised, custom silicone liner.

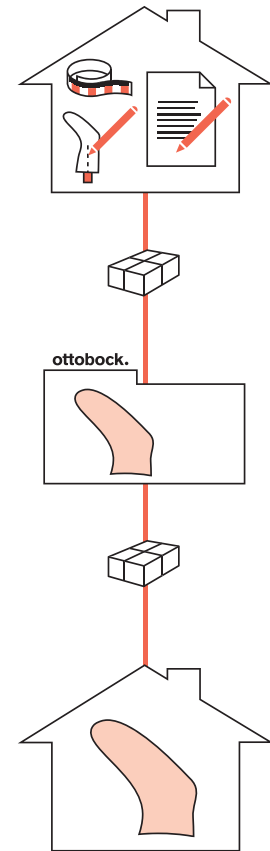

Forearm Silicone Liner from Plaster Cast

Measurement form

Contact		Customer number		Date	
Customer			Shipping address (if different from customer address)		
Company			Company		
Street			Street		
Postal code/city			Postal code/city		
Email			Phone		
Patient ID					

- | | |
|---|--|
| <input type="checkbox"/> 88L2=OA TR silicone liner from plaster cast | <input type="checkbox"/> 88L3=IP Custom residual limb end pad |
| <input type="checkbox"/> 88L5=TR TR silicone liner for Myo from plaster cast | <input type="checkbox"/> 88L3=L Spandex cover |
| <input type="checkbox"/> 88L3=G Fabrication from plaster negative | <input type="checkbox"/> 88L3=B Anti-stick coating |
| <input type="checkbox"/> 8T860=1 Myo-contact surfaces | |

- | | | | | |
|--|---|--|---------------------------------------|-----------------------------------|
| <input type="checkbox"/> Trial liner | <input type="checkbox"/> Side: | <input type="checkbox"/> Left | <input type="checkbox"/> Right | |
| <input type="checkbox"/> Definitive liner | <input type="checkbox"/> Silicone thickness: | <input type="checkbox"/> 1.8 mm | <input type="checkbox"/> 2 mm | <input type="checkbox"/> mm |

Colour:

- Skin colour Skin colour translucent Uni colour

Fixation:

- With receiver for pin (M10) Without fixation
 Silicone wedge Strap

Add-ons:

- Silicone gel coating Extension strip (matrix) to minimise pistoning
 Anti-rotation wedge mm length from residual limb end

Mark limits of the liner and enter circumference measurements at measured locations.

Strap:

Please mark the position, size and number on the plaster model.

MyoBock electrodes:

Please mark precisely on the plaster model.

Pin position and plumb line:

Please mark the position exactly on the plaster model.

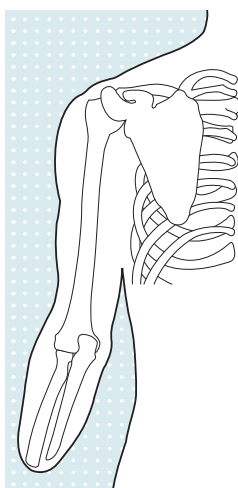

Height every 3 cm from residual limb end	Circumferences		
	Residual limb	Plaster	Model
180 mm	<input type="text"/>	<input type="text"/>	<input type="text"/>
150 mm	<input type="text"/>	<input type="text"/>	<input type="text"/>
120 mm	<input type="text"/>	<input type="text"/>	<input type="text"/>
90 mm	<input type="text"/>	<input type="text"/>	<input type="text"/>
60 mm	<input type="text"/>	<input type="text"/>	<input type="text"/>
30 mm	<input type="text"/>	<input type="text"/>	<input type="text"/>

1
2
3
4

1

2

3

4



Custom Silicone Covers for Passive Hand Systems

Fittings with a Silicone Cover for passive hand systems help restore a deceptively genuine outward appearance. A hand system with silicone cover also offers a passive counter-support when gripping objects. Silicone products are hygienic and easy to clean. Thanks to this property, Silicone Covers do not become permanently soiled as quickly as conventional PVC covers.

1

2

3

4

Ottobock offers several ordering options to meet the individual needs of your patient.

1

2



3

"Classic" Silicone Cover

- Anatomical shape
- 2 to 3-colour silicone cover
- Anatomical surface structure
- Multicoloured fingernails made of silicone or acrylic

4

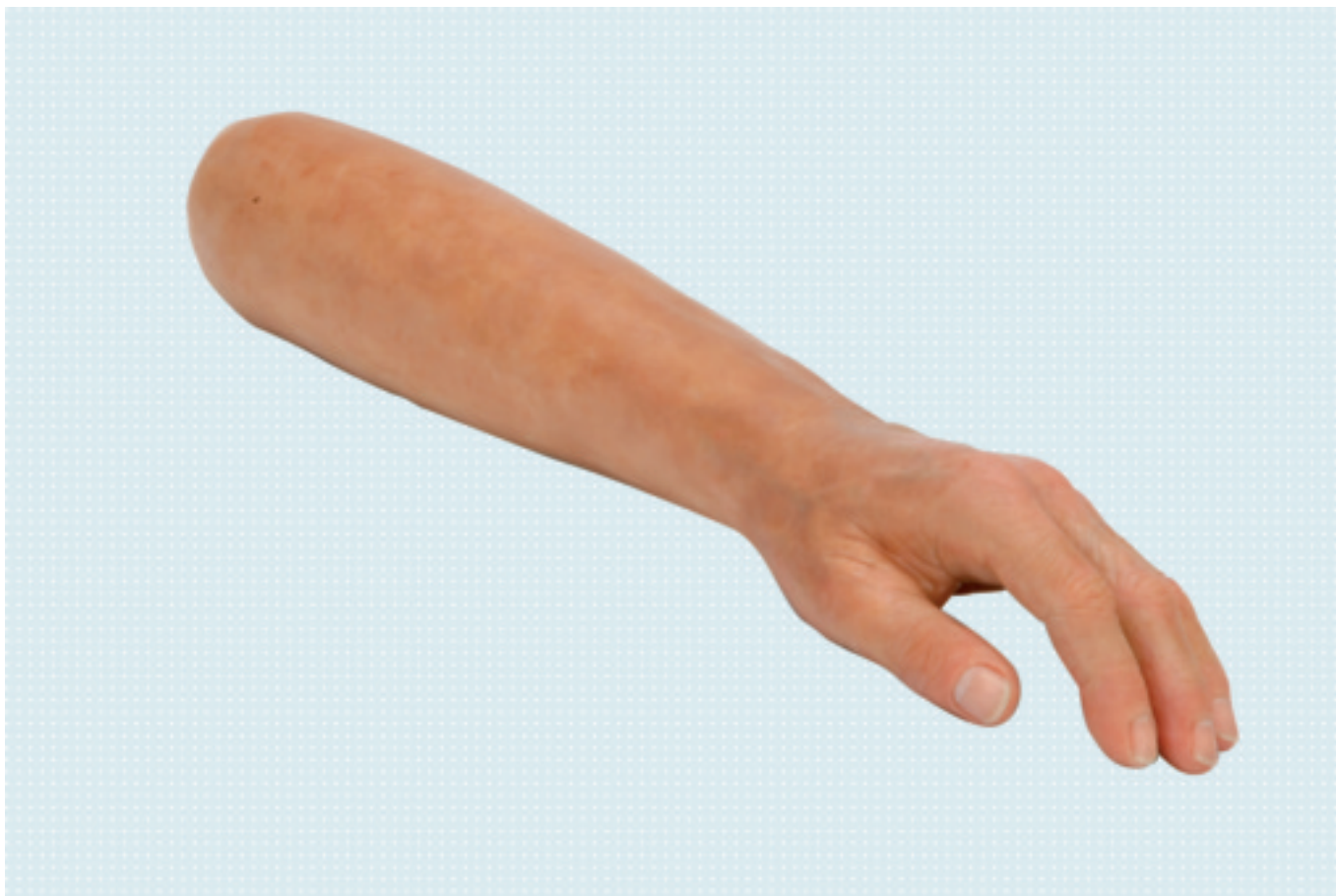

"Natural" Silicone Cover

- Anatomical shape
- 8 to 10-colour silicone cover
- Anatomical surface structure
- Multicoloured fingernails made of silicone or acrylic

For this version, the patient must visit an Ottobock Competence Centre. Prior to final finishing, the patient may come for a follow-up appointment in order to optimise the aesthetic appearance.

1

2

3

4

1



"Classic" and "Natural" silicone nails

- Customised 5-colour silicone fingernails

2



"Classic" and "Natural" acrylic nails

- Customised 5-colour acrylic fingernails
 - Deceptively realistic surface characteristics
 - Suitable for nail polish

3



Hair

Individually matched to the contralateral side, colour, length, shape and density of hair can be realised by request.

4

Ottobock offers several accessories for taking impressions and determining the colour of a silicone cover. An overview of the available options is found on this page.

Tools

89D4 Colour ring

The colour ring helps you determine your patient's basic skin tone. In doing so, you provide the service fabrication technicians with additional information so that they can make the prosthesis as realistic as possible.



1

647F285=GB Colour sheet

The colour sheet facilitates determining the individual colour for the "Classic" version. Four photos of the affected and contralateral sides are taken on the colour sheet and sent to Ottobock Service Fabrication.



2

3

4

Information on the Ordering Process

1



Measure the patient's contralateral side and complete the measurement form. Also please take an impression and photo of the contralateral side and determine the colour depending on the type of prosthesis using the colour sheet (647F285=GB).

Please send the following to Ottobock Service Fabrication:

- The prosthesis to be coated
- The measurement form
- The colour determination forms
- The impression of the contralateral side
- The photos

2

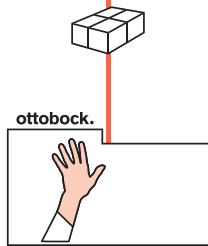

Ottobock Service Fabrication will fabricate the Silicone Cover for you and ship it within 20 working days.

3

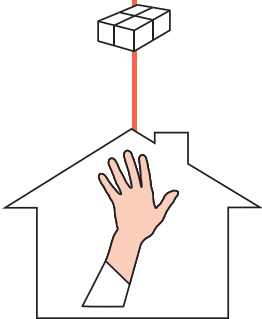

You receive an easy to clean, functional Silicone Cover which helps restore the outward appearance of your patient.

4

Upper Limb Silicone Cover

Order form

Contact		Customer number		Date	
Customer			Shipping address (if different from customer address)		
Company			Company		
Street			Street		
Postal code/city			Postal code/city		
Email			Phone		
Patient ID					

Age:

Gender: Female Male

Affected side: Left Right

Configuration

- 88A10** Silicone Cover (hand – elbow) “Natural”
- 88A11** Silicone Cover (elbow – shoulder) “Natural”
- 88A12** Silicone Cover (hand – elbow) “Classic”
- Colour determination as per colour determination sheet
- 88A2=S** Silicone Fingernails
- 88A2=A** Acrylic Fingernails

- 88A20=H** Genuine Arm Hair
(from contralateral side)

Scope of delivery:

- Complete checklist
- Assembled prosthesis
- Cast of the contralateral side
- Photos

Comments:

.....

.....

.....

.....

.....

.....

.....

.....

1

2

3

4

Upper Limb Silicone Cover

Measurement form

1

Contact	Customer number	Date
---------	-----------------	------

Measurement form contralateral and amputated side

Please reproduce the anatomical shape of the arm in the prosthesis and note that the prosthesis circumference should be approx. 12–14 mm less compared to the contralateral side.

2

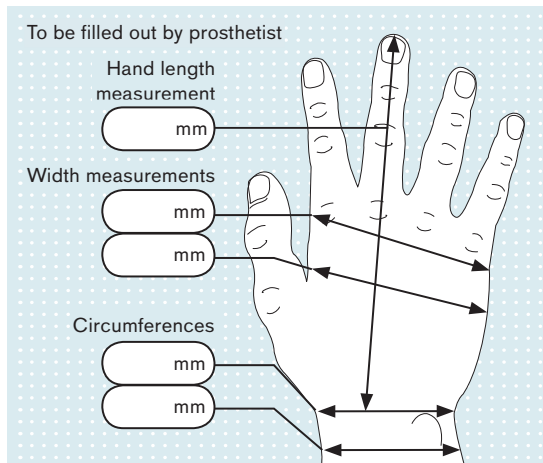

Finger circumference (mm)

D	I	II	III	VI	V
MCP-PIP					
PIP-DIP					
DIP					

3

Height every 5 cm	Prosthesis	Contralateral side
*		

* Take first measurement starting at the wrist

4

Upper Limb Silicone Cover

Colour determination sheet

Contact	Customer number	Date
---------	-----------------	------

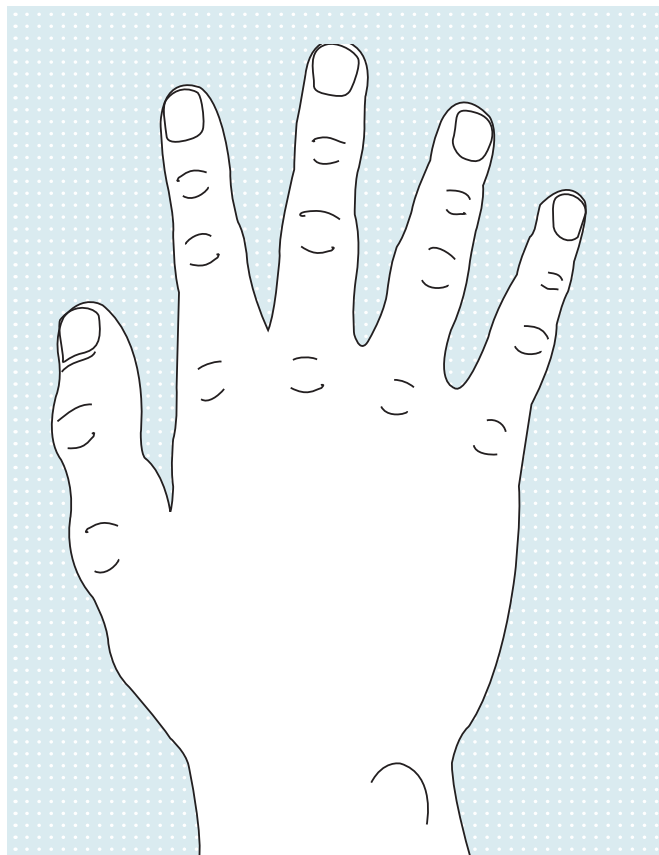

Colour sample – colour strength

Use pen to mark skin colours on the sketch

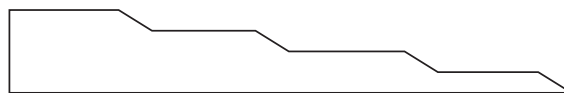

IV	III*	II	I
Pen	Colour sample	Colour strength	
1			
2			
3			
4			
5			
6			
7			
8			
9			
10			

Model blood vessels: Yes No

* Thickness III is recommended for the primer.

Nails

Acrylic

Silicone

Nail length

Like photo

mm longer

Nail shape



Colour



Nail tip

Distal edge

Central

Proximal edge

Moon

1

2

3

4

Upper Limb Silicone Cover

Colour determination sheet

1

Contact	Customer number	Date
---------	-----------------	------

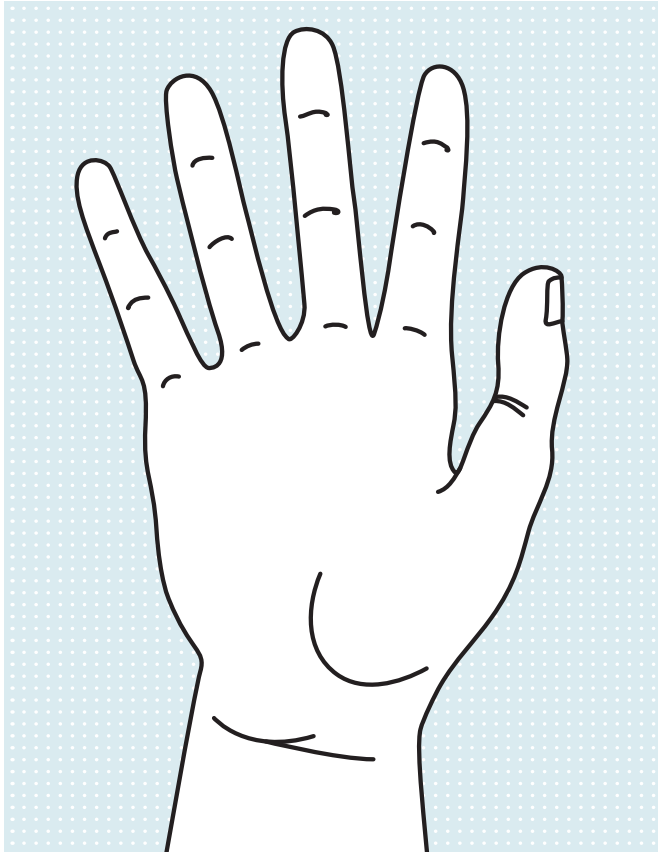

Colour sample – colour strength

Use pen to mark skin colours on the sketch

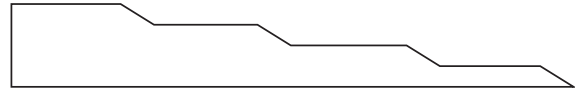

IV	III*	II	I
Pen	Colour sample	Colour strength	
1			
2			
3			
4			
5			
6			
7			
8			
9			
10			

Model blood vessels: Yes No

* Thickness III is recommended for the primer.

2

3

Comments:

.....

.....

.....

.....

.....

.....

.....

.....

.....

.....

4

Upper Limb Silicone Cover

Colour determination sheet

Contact	Customer number	Date
---------	-----------------	------

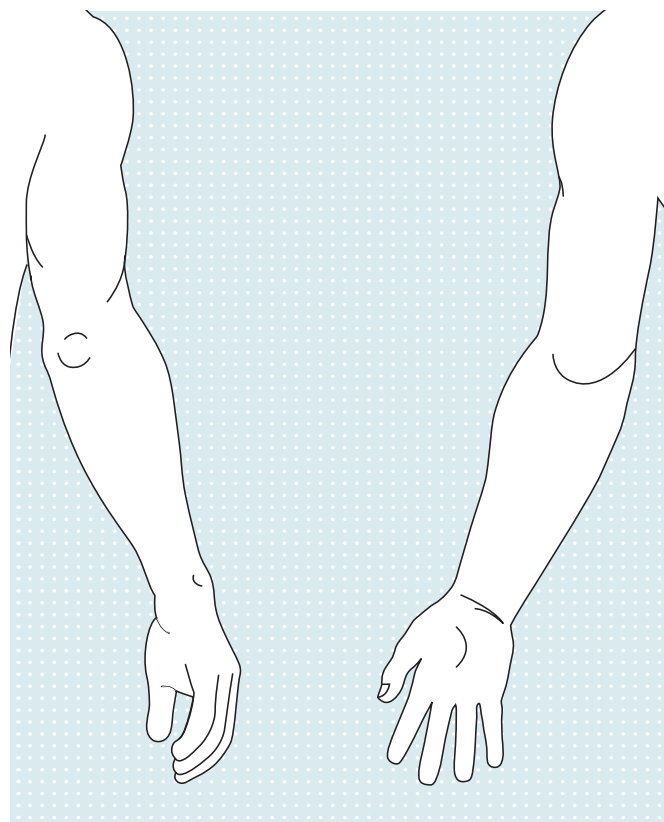

Colour sample – colour strength

Use pen to mark skin colours on the sketch

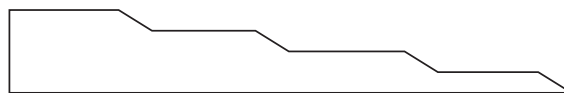

IV	III*	II	I
Pen	Colour sample	Colour strength	
1			
2			
3			
4			
5			
6			

* Thickness III is recommended for the primer.

Comments:

.....

.....

.....

.....

.....

.....

.....

.....

1

2

3

4

1

2

3

4



Silicone Partial Hand Prostheses

Silicone Partial Hand Prostheses expand the selection of demand-based patient fittings and offer a functional partial hand replacement, for example after amputations in the finger base joint and mid-hand area. The partial hand replacement provides passive functionality such as counter-support when grasping objects. A customised socket design and optimal fit of the silicone socket are indispensable for ensuring unrestricted function. The prosthesis is secured on the residual limb without bothersome closures. This type of fixation and the elasticity of the silicone material make donning and doffing straightforward. Thin tapered edges as well as the comfortable material result in functionality and ultimate wearing comfort. Silicone products are hygienic and easy to clean. They can be washed with water and soap. If they become heavily soiled, they can be cleaned by boiling.

1

2

3

4

Ottobock offers several ordering options to meet the individual needs of your patient.

**"Basic", "Classic" and "Natural" Silicone Trial Prosthesis
(not illustrated)**

- Chlorosil and Pastasil trial prosthesis
 - Permits compression and finger positioning to be adjusted within the four-week trial fitting period
-



"Basic" Silicone Partial Hand Prosthesis

- Customised socket design
- Anatomical shape
- Silicone partial hand prosthesis in one colour
- Silicone fingernails in one colour
- Basic surface structure



1

2

3

4

"Classic" Silicone Partial Hand Prosthesis

- Customised socket design
- Customised anatomical shape
- 2-3 customised skin tones, matching the contralateral side
- Anatomical surface structure
- Custom multicoloured nail design

1

2

3

4



"Natural" Silicone Partial Hand Prosthesis

- Customised socket design
- Customised anatomical shape
- 6-8 customised skin tones, matching the contralateral side
- Anatomical surface structure
- Custom, multicoloured nail design

For this version, the patient must visit an Ottobock Competence Centre. Prior to final finishing, the patient may come for a follow-up appointment in order to optimise the aesthetic appearance.

"Basic" and "Classic" standard nails

- Silicone fingernails in one colour, with colour-matched tip

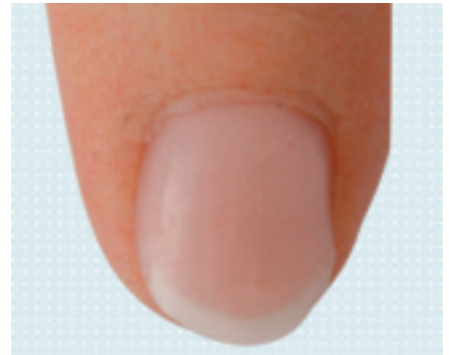

1

"Classic" and "Natural" silicone nails

- Customised 5-colour silicone fingernails



2

"Classic" and "Natural" acrylic nails

- Customised 5-colour acrylic fingernails
 - Deceptively realistic surface characteristics
 - Suitable for nail polish



3

4

Ottobock offers accessories for taking impressions and determining the colour of a Silicone Partial Hand Prosthesis. You will find an overview of the available options on this page.

Tools

1



Impresil

Impresil is a 2-component Silicone that cross-links at room temperature. It is thixotropic so that even when applied to vertical planes at thicknesses of less than 5 mm, it will not drip. It hardens in about 6 minutes, which leaves enough processing time even when taking complex impressions. Impresil is processed at a room temperature of 23°C/73.4°F. The hardness of the vulcanised silicone is approx. 30° Shore A.

Article number	Consisting of
642V15=1	1 dispenser 5 cartridges, 75 ml each (component A and component B) 20 static mixers

2



646T3=1.1GB Impression taking & measuring technique

This technical information for Silicone Finger and Partial Hand Prostheses helps you take impressions with Impresil.

3



89D4 Colour ring

The colour ring helps you determine your patient's basic skin tone. In doing so, you provide the service fabrication technicians with additional information so that they can make the prosthesis as realistic as possible.

4



647F285=GB Colour sheet

The colour sheet facilitates determining the individual colour for the "Classic" version. Four photos of the affected and contralateral sides are taken on the colour sheet and sent to Ottobock Service Fabrication.

Information on the Ordering Process

As the orthopaedic technician, you are responsible for determining the shape and colour as well as ordering the prosthesis:

The **shape** includes:

- Measuring the patient's residual limb
- Completing the measurement form
- Taking informative photos of the left and right hand
- Making an Impresil negative of the affected **and** the contralateral sides.

Depending on the prosthesis version, **determine the colour using the colour sheet (647F285=GB) and the colour ring (89D4).**

The **order forms must be fully completed before placing the order.**

Ottobock Service Fabrication will fabricate the **Trial Prosthesis according to your specifications and ship it within 10 working days.**

You as the orthopaedic technician can provide your patient with the Trial Prosthesis for approximately 4 weeks for testing. If required, you can modify the trial prosthesis yourself. After the test phase, please return the trial prosthesis to Ottobock Service Fabrication.

Ottobock Service Fabrication will fabricate the **definitive prosthesis according to your specifications and ship it within 15 working days.**

When the definitive prosthesis is received, you can fit your patient with a functional and aesthetically appealing Silicone Partial Hand Prosthesis.

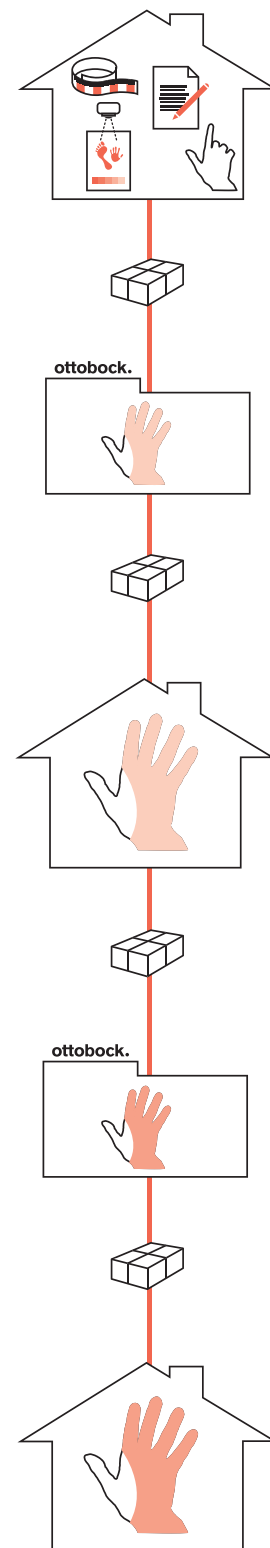

-  646A259=GB (Information for Practitioners "Silicone Finger and Partial Hand Prostheses")
 646D309=GB (Product Information "Silicone Finger and Partial Hand Prostheses")
 647F285=GB (Information for Practitioners "Colour Sheet for Silicone Products")
 646T3=1.1GB (Information for Practitioners for "Impression taking & measuring technique")

Silicone Partial Hand Prosthesis

Order form

1

Contact		Customer number		Date	
Customer			Shipping address (if different from customer address)		
Company			Company		
Street			Street		
Postal code/city			Postal code/city		
Email			Phone		
Patient ID					

2

Age:

Gender: Female Male

Affected side: Left Right

Configuration

- 88A2=PF** Trial Prosthesis
- 88A2=HF** Definitive Prosthesis "Basic"
..... Colour code per 89D4
- 88A2=HS** Definitive Prosthesis "Classic"
- 88A2=F** Definitive Prosthesis "Natural"
- Colour determination as per colour determination sheet
- Silicone fingernails (uni-coloured)
- 88A2=S** Silicone Fingernails (multi-coloured)
- 88A2=A** Acrylic Fingernails

Scope of delivery

- Photos of affected and contralateral sides
- Casting

3

Case history

Finger joints: Free moving Limited motion

Bone end: Wide Pointed

Affected fingers:
Please mark with a cross.

Diagnosis

- Accident
- Dysmelia
- Other
- Arm length differences
- Accompanying disease

Left hand

I II III IV V

Right hand

I II III IV V

4

Comments:

.....

.....

.....

.....

Silicone Partial Hand Prosthesis

Measurement form

Contact	Customer number	Date
---------	-----------------	------

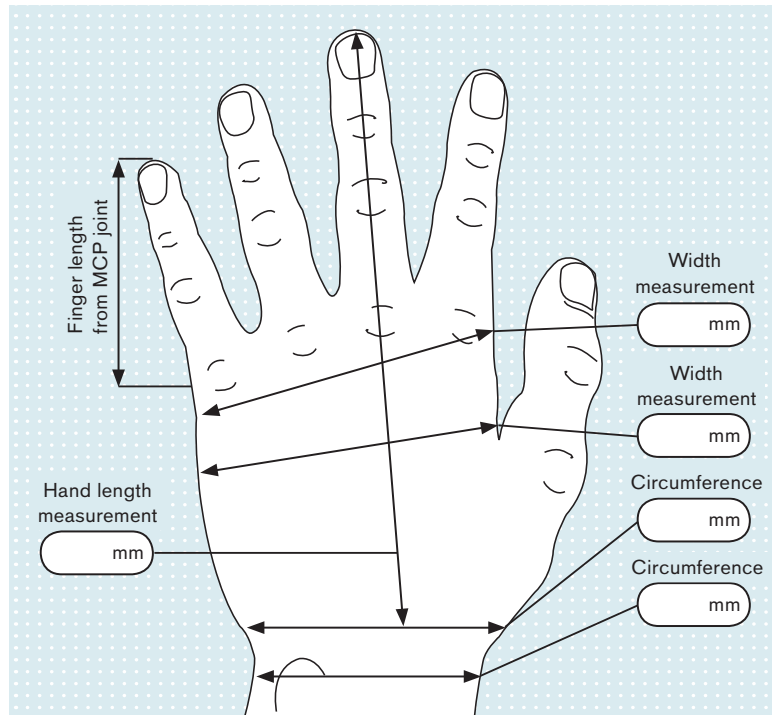

Measurement form contralateral side

Please mark the circumferences of the contralateral side. Take the finger length measurements from the highest point of the MCP joint to the fingertip in a relaxed, functional position.

Finger measurements

D	I	II	III	IV	V
MCP-PIP (circumference)					
PIP-DIP (circumference)					
DIP (circumference)					
Finger length from MCP joint					

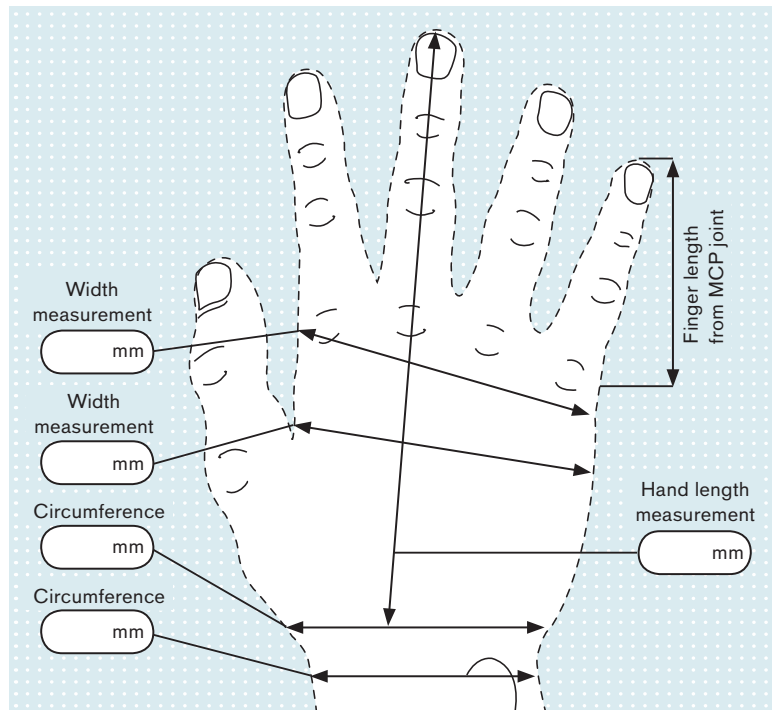

Measurement form amputated side

Please sketch the course of the amputation or use the free "Outline" field on the next page.

Finger measurements

D	I	II	III	IV	V
MCP-PIP (circumference)					
PIP-DIP (circumference)					
DIP (circumference)					
Finger length from MCP joint					

1

2

3

4

Silicone Partial Hand Prosthesis

Colour determination sheet

1

Contact	Customer number	Date
---------	-----------------	------

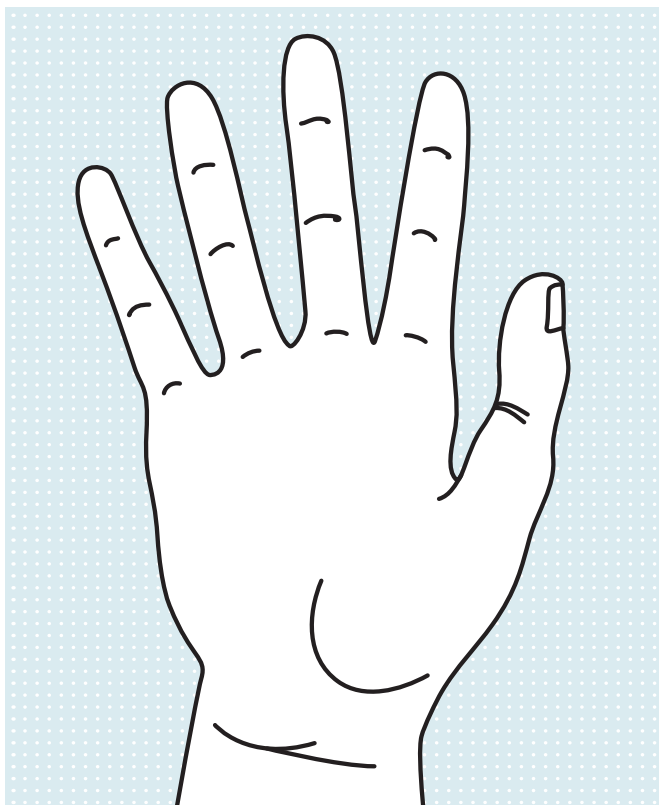

Colour sample – colour strength

Use pen to mark skin colours on the sketch

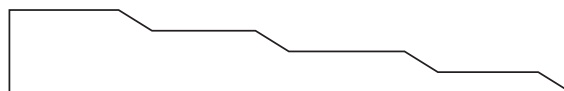

IV	III*	II	I
Pen	Colour sample	Colour strength	
1			
2			
3			
4			
5			
6			
7			
8			
9			
10			

* Thickness III is recommended for the primer.

2

3

Comments:

.....

.....

.....

.....

.....

.....

.....

.....

4

Silicone Partial Hand Prosthesis

Colour determination sheet

Contact	Customer number	Date
---------	-----------------	------

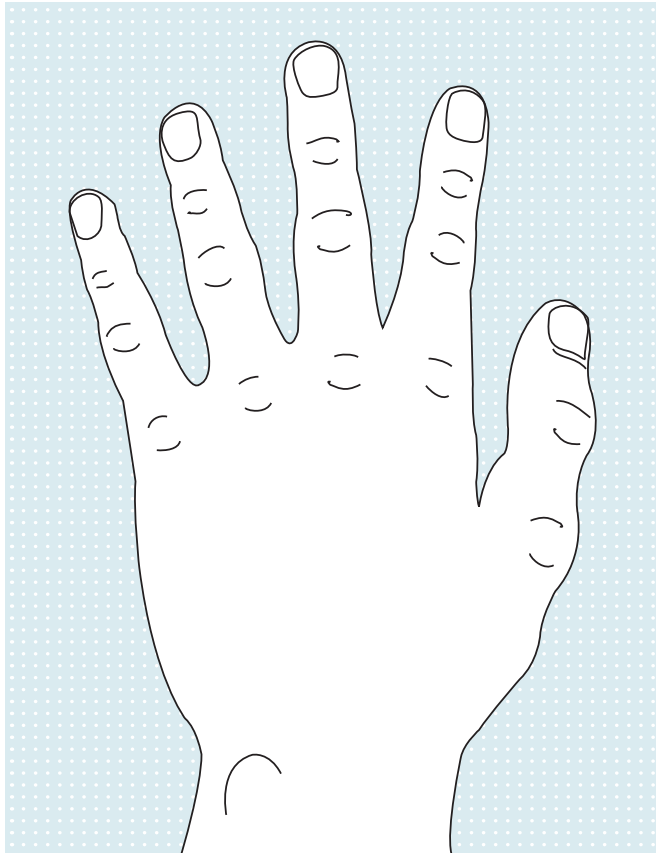

Colour sample – colour strength

Use pen to mark skin colours on the sketch

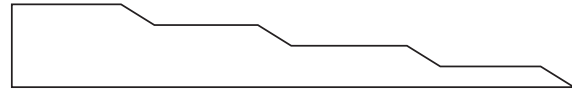

IV	III*	II	I
Pen	Colour sample	Colour strength	
1			
2			
3			
4			
5			
6			
7			
8			
9			
10			

Model blood vessels: Yes No

* Thickness III is recommended for the primer.

Nails

Acrylic

Silicone

Nail length

Like photo

mm longer

Nail shape



Colour



Nail tip

Distal edge

Central

Proximal edge

Moon

1

2

3

4

1

2

3

4



Silicone Finger Prostheses

A Silicone Finger Prosthesis fitting offers high functionality, such as a counter-support for grasping objects, good finger grip for handling coins or using a keyboard or controls in everyday life. A silicone finger prosthesis is secured on the residual limb without annoying closures. Aside from the functional benefits, the patient's appearance is also restored. Silicone products are hygienic and easy to clean. They can be washed with soap and water. If they become heavily soiled, they can be cleaned by boiling.

1

2

3

4

Ottobock offers several ordering options to meet the individual needs of your patient.

1

"Basic", "Classic" and "Natural" Trial Finger (not illustrated)

- Chlorosil and Pastasil trial prosthesis
 - Allows compression and finger position to be adjusted within the four-week trial fitting period
-

2

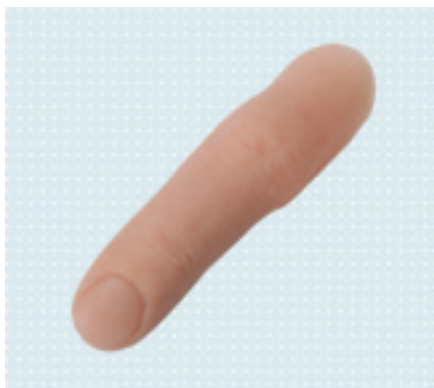

"Basic" Silicone Finger Prosthesis

- Customised socket design
 - Anatomical shape
 - Silicone finger in one colour
 - Silicone fingernail in one colour
 - Basic surface structure
-

3



"Classic" Silicone Finger Prosthesis

- Customised socket design
 - Customised anatomical shape
 - 2-3 customised skin tones, matching the contralateral side
 - Anatomical surface structure
 - Custom nail design
-

4



"Natural" Silicone Finger Prosthesis

- Customised socket design
- Customised anatomical shape
- 6-8 customised skin tones, matching the contralateral side
- Anatomical surface structure
- Custom, multicoloured nail design

For this version, the patient must visit an Ottobock Competence Centre. Prior to final finishing, the patient may come for a follow-up appointment in order to optimise the aesthetic appearance.

"Basic" and "Classic" standard nail

- Silicone fingernail in one colour with colour-matched tip

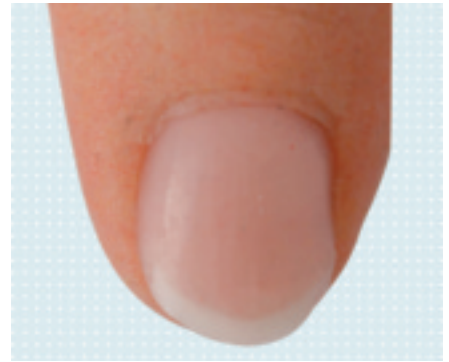

1

"Classic" and "Natural" silicone nail

- Customised 5-colour silicone fingernail

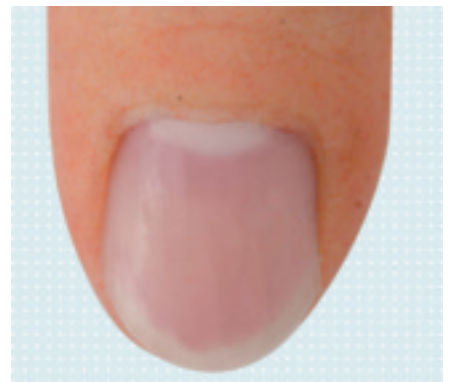

2

"Classic" and "Natural" acrylic nail

- Customised 5-colour acrylic fingernail
 - Deceptively realistic surface characteristics
 - Suitable for nail polish



3

4

Ottobock offers accessories for taking impressions and determining the colour of a Silicone Finger Prosthesis. An overview of the available options is found on this page.

Tools

1



Impresil

Impresil is a 2-component Silicone that cross-links at room temperature. It is thixotropic so that even when applied to vertical planes at thicknesses of less than 5 mm, it will not drip. It hardens in about 6 minutes, which leaves enough processing time even when taking complex impressions. Impresil is processed at a room temperature of 23°C/73.4°F. The hardness of the vulcanised silicone is approx. 30° Shore A.

Article number	Consisting of
642V15=1	1 dispenser 5 cartridges, 75 ml each (component A and component B) 20 static mixers

2



646T3=1.1GB Impression taking & measuring technique

This technical information for Silicone Finger and Partial Hand Prostheses helps you take impressions with Impresil.

3



89D4 Colour ring

The colour ring helps you determine your patient's basic skin tone. In doing so, you provide the service fabrication technicians with additional information so that they can make the prosthesis as realistic as possible.

4



647F285=GB Colour sheet

The colour sheet facilitates determining the individual colour for the "Classic" version. Four photos of the affected and contralateral sides are taken on the colour sheet and sent to Ottobock Service Fabrication.

Information on the Ordering Process

As the orthopaedic technician, you are responsible for determining the shape and colour as well as ordering the prosthesis:

The **shape** includes:

- Measuring the patient's residual limb
- Completing the measurement form
- Taking informative photos of the left and right hand
- Making an Impresil negative of the affected **and** the contralateral sides.

Depending on the prosthesis version, **determine the colour using the colour sheet (647F285=GB) and the colour ring (89D4).**

The **order forms must be fully completed before placing the order.**

Ottobock Service Fabrication will fabricate the **Trial Prosthesis according to your specifications and ship it within 10 working days.**

You as the prosthetist can provide the trial prosthesis to your patient for approximately 2 weeks for testing. If required, you can modify the Trial Prosthesis yourself. After the test phase, please return the trial prosthesis to Ottobock Service Fabrication.

Ottobock Service Fabrication will fabricate the **definitive prosthesis according to your specifications and ship it within 15 working days.**

When the definitive prosthesis is received, you can fit your patient with a functional and aesthetically appealing Silicone Finger Prosthesis.

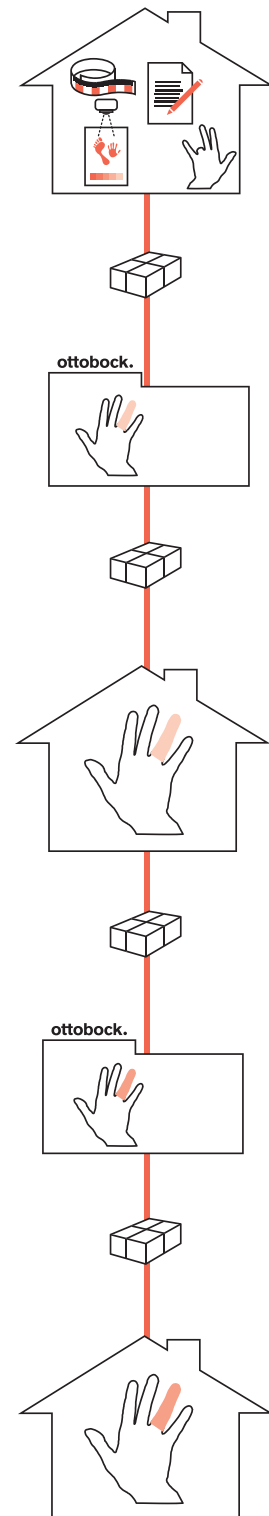

1

2

3

4



- 646A259=GB (Information for Practitioners "Silicone Finger and Partial Hand Prostheses")
- 646D309=GB (Product Information "Silicone Finger and Partial Hand Prostheses")
- 647F285=GB (Information for Practitioners "Colour Sheet for Silicone Products")
- 646T3=1.1GB (Information for Practitioners for "Impression taking & measuring technique")

Fitting Information

- The proximal end of a Silicone Finger Prosthesis is always directly distal to the MCP joint.
- Please take finger and hand impressions with Impresil in the functional position:
 - The wrist is at 25° to 30° extension
 - The wrist should not have any radial or ulnar deviation
 - The fingers are in the slight flexion position so that contact can be made between the thumb, index and middle fingers
 - The thumb is in direct opposition to the index and middle fingers
- Please measure all required lengths with a measuring tape. Apply the measuring tape between the fingers and read the length distally. The finger to be measured must be flat, without tension or hyperextension.
- The 89D4 Colour Ring includes 24 skin colour samples. Colour samples for nail colour determination are not available.

1

2

3

4

Silicone Finger Prosthesis

Order form

Contact		Customer number		Date	
Customer			Shipping address (if different from customer address)		
Company			Company		
Street			Street		
Postal code/city			Postal code/city		
Email			Phone		
Patient ID					

Age:

Gender: Female MaleAffected side: Left Right

Configuration

- 88A1=PF** Trial Prosthesis
- 88A1=FF** Definitive Prosthesis "Basic"
..... Colour code per 89D4
- 88A1=FS** Definitive Prosthesis "Classic"
- 88A1** Definitive Prosthesis "Natural"
- Colour determination as per colour determination sheet
- Silicone fingernails (uni-coloured)
- 88A1=S** Silicone Fingernails (multi-coloured)
- 88A1=A** Acrylic Fingernails

Scope of delivery

- Photos of affected and contralateral sides
- Casting

Case history

Finger joints: Free moving Limited motion

Bone end: Wide Pointed

Affected fingers:
Please mark with a cross.

Diagnosis

- Accident
- Dysmelia
- Other
- Arm length differences
- Accompanying disease

Left hand

I II III IV V

Right hand

I II III IV V

Comments:

.....

.....

.....

.....

Silicone Finger Prosthesis

Measurement form

1

Contact	Customer number	Date
---------	-----------------	------

2

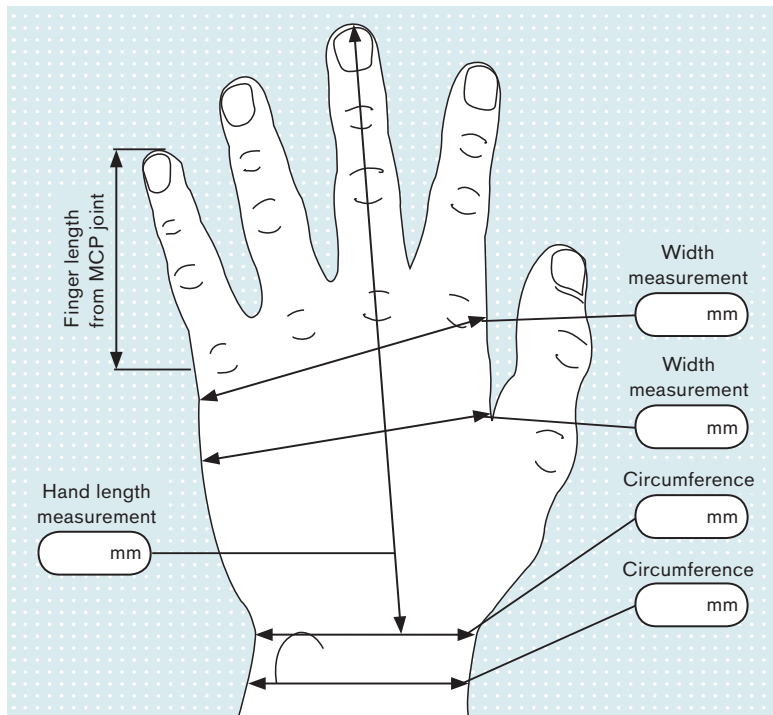

Measurement from contralateral side

Please mark the circumferences of the contralateral side. Take the finger length measurements from the highest point of the MCP joint to the fingertip in a relaxed, functional position.

Finger measurements

D	I	II	III	IV	V
MCP-PIP (circumference)					
PIP-DIP (circumference)					
DIP (circumference)					
Finger length from MCP joint					
Finger length from webbing					

3

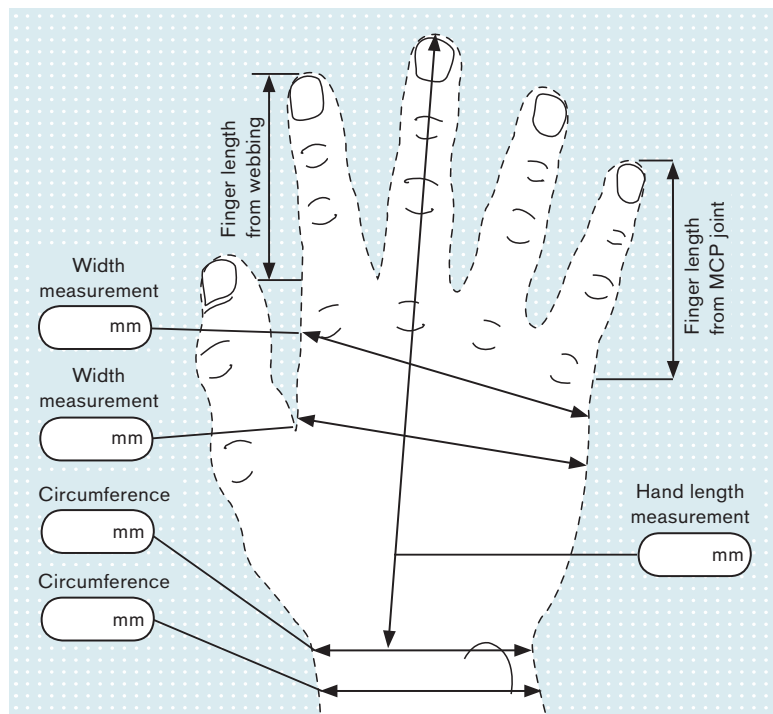

Measurement from amputated side

Please sketch the course of the amputation or use the free "Outline" field on the next page.

Finger measurements

D	I	II	III	IV	V
MCP-PIP (circumference)					
PIP-DIP (circumference)					
DIP (circumference)					
Finger length from MCP joint					
Finger length from webbing					

4

Silicone Finger Prosthesis

Colour determination sheet

Contact	Customer number	Date
---------	-----------------	------

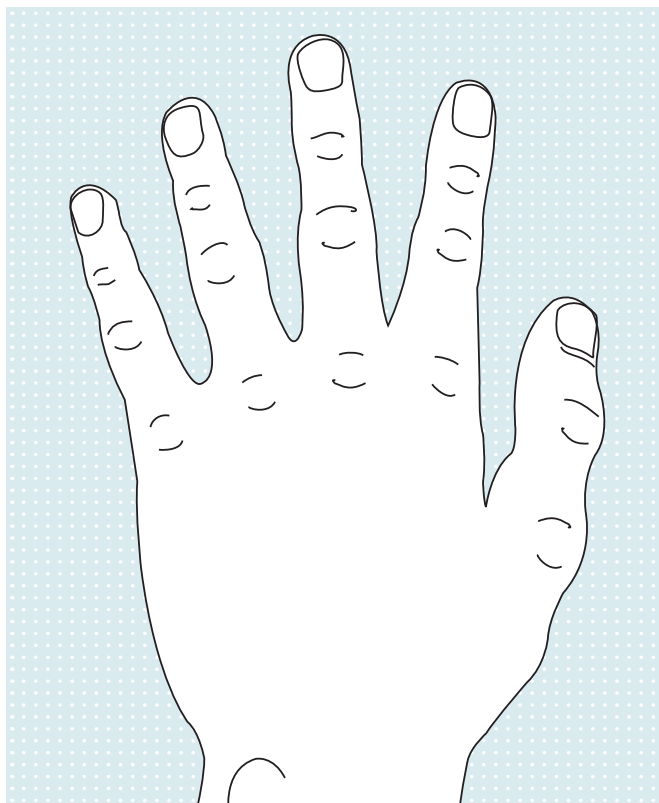

Colour sample – colour strength

Use pen to mark skin colours on the sketch

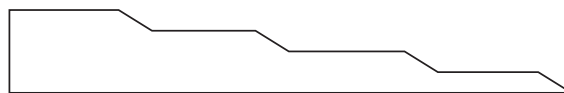

IV	III*	II	I
Pen	Colour sample	Colour strength	
1			
2			
3			
4			
5			
6			
7			
8			
9			
10			

* Thickness III is recommended for the primer.

Nails

Acrylic

Silicone

Nail length

Like photo

mm longer

Nail shape



Colour



Nail tip

Distal edge

Central

Proximal edge

Moon

1

2

3

4

Silicone Finger Prosthesis

Colour determination sheet

1

Contact	Customer number	Date
---------	-----------------	------

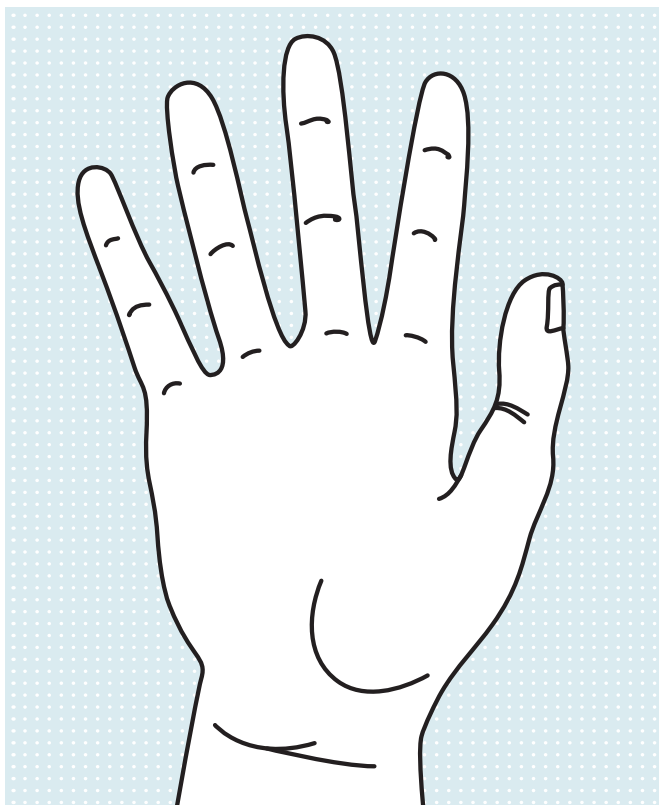

Colour sample – colour strength

Use pen to mark skin colours on the sketch

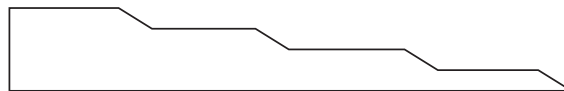

IV	III*	II	I
Pen	Colour sample	Colour strength	
1			
2			
3			
4			
5			
6			
7			
8			
9			
10			

* Thickness III is recommended for the primer.

2

3

Comments:

.....

.....

.....

.....

.....

.....

.....

.....

4

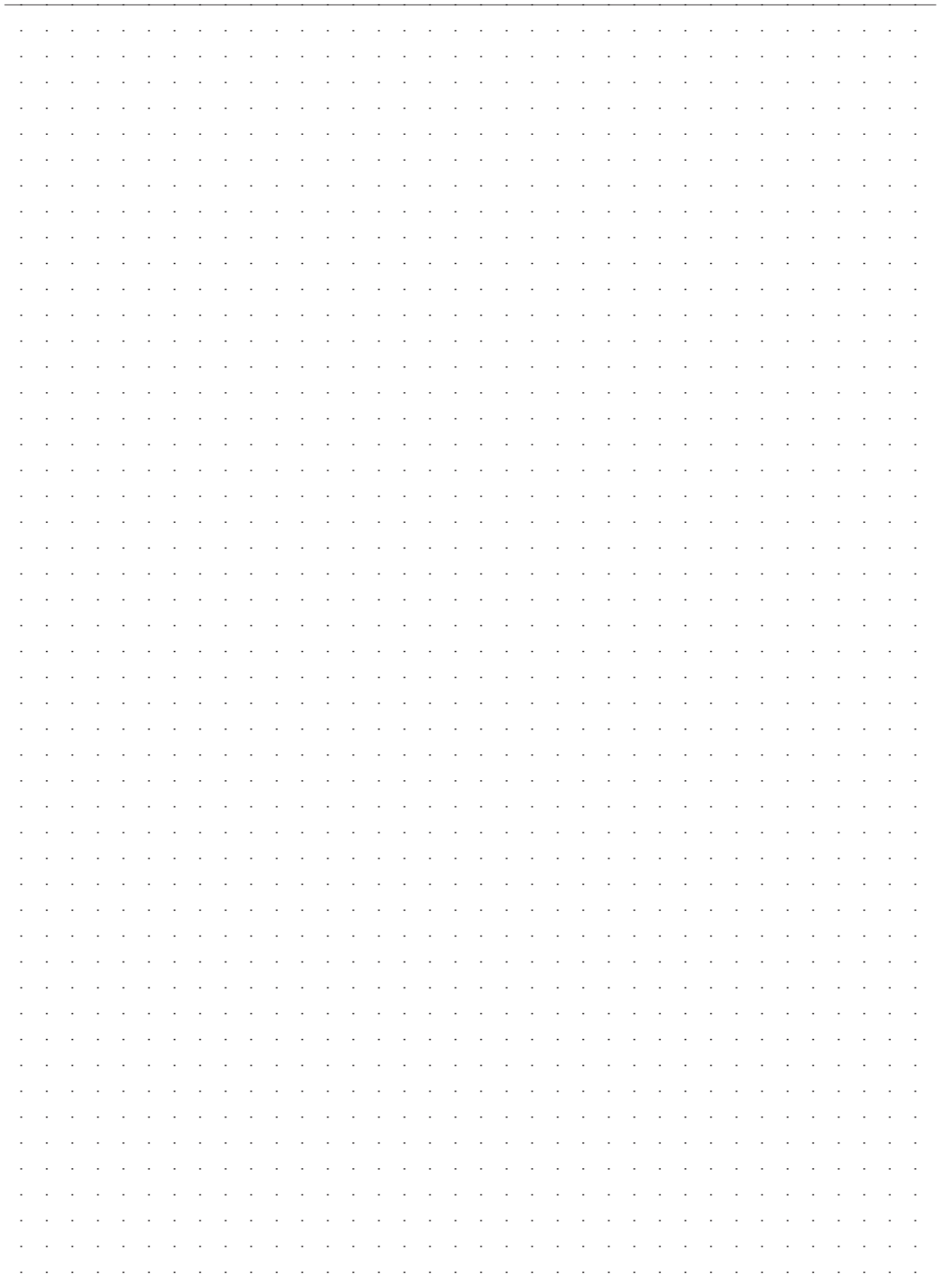

1

2

3

4

1

2

3

4



Orthotics

1

2

3

4

1

2

3

4



Malmö Orthoses

Flexibility where it is needed – stiffness where it is required: Malmö Orthoses are tailored according to individual requirements and indications. With the help of prepreg technology, Ottobock fabricates precisely fitting orthoses for the upper and lower limbs.

Malmö Orthoses offer numerous advantages:

- Graduated material thickness for optimised weight and appearance
- Torsional and flexural stiffness according to the requirements
- Best possible stability with low wall thickness
- Outstanding torsional flexibility
- High functionality
- Improved dynamic response
- Numerous options for closure flaps/brackets/pockets
- Flexible straps, flexible connecting elements and more flexibility in the seating area
- Individual forefoot and heel characteristics

For these orthoses you may choose among all knee and ankle joints from our product range.

	Type of orthosis	Description	Possible diagnosis	Type of orthosis	Description	Possible diagnosis
1		Knee-Ankle-Foot Orthosis KAFO 2 bands and 1 frontal support or 2 bands, each with knee and ankle joints	Paralytic diseases involving the entire leg When a high degree of guidance is required: Osteogenesis imperfecta, Poliomyelitis, ICP		Ankle-Foot Orthosis Spiral DAFO	Peroneal paralysis after stroke
					Ankle-Foot Orthosis DAFO with dorsiflexion assist	Peroneal paralysis with ligament instability in the ankle joint, MDS and similar systemic diseases
2		Knee-Ankle-Foot Orthosis KAFO with flexible connecting element and knee joint	Paralytic diseases involving the entire leg The torsional flex connecting element optimises pelvic movement while walking: Poliomyelitis, progressive muscular dystrophy, severe knee osteoarthritis		Ankle-Foot Orthosis DAFO	Spina bifida, ICP, foot deformities, stiff ankle
					Ankle-Foot Orthosis DAFO	Pseudarthrosis, complete immobilisation of the lower leg
3		Knee-Ankle-Foot Orthosis KAFO with length reduction, without ankle joint, with knee joint	Paralytic diseases involving the entire leg with stiffened ankle joint and length reduction: Poliomyelitis, trauma, osteogenesis imperfecta		Ankle-Foot Orthosis AFO with joint	Paralytic diseases of the leg: Poliomyelitis, severe ligament instability
					Knee Orthosis KO with joint	Ligament instability Knee osteoarthritis

4

Malmö Technique

SF28K=L/R-KAFO

Knee-ankle-foot orthosis with system ankle and knee joint



1

SF28K=L/R-KAFO-1

Knee-ankle-foot orthosis with flexible connecting element



2

SF28K=L/R-KAFO-2

Knee-ankle-foot orthosis without ankle joint

SF28K=L/R-KO

Knee orthosis with joint

3

4

1



SF28K=L/R-AFO

Knee-ankle-foot orthosis with system ankle and knee joint

2



SF28F=L/R-DAFO

Dynamic ankle-foot orthosis

3

SF28F=L/R-DAFO-1

Dynamic ankle-foot orthosis without ankle joint, bilateral

4

Malmö Technique Add-ons

Bracket

Article number	Width
SF28=L1	up to 5 cm
SF28=L2	over 5 cm
SF28=L3	Reinforced flap up to 15 cm



1

Closure pocket

Article number
SF28=V1



2

Design

Standard version
untreated carbon design

Article number	Design
SF28=C1	Smooth carbon design for KAFO / KO (finished)
SF28=C2	Smooth carbon design for DAFO / AFO (finished)
SF28=D1	after forehand. Program for KAFO / KO
SF28=D2	after forehand. Program for DAFO / AFO



3

Test orthosis

Article number	for
SF28=T1	DAFO
SF28=T2	AFO
SF28=T3	KO
SF28=T4	KAFO

4

1

Modelling

Article number	for
SF28=M1	Modelling according to existing test orthosis or DAFO plaster model
SF28=M2	Modelling according to existing test orthosis or AFO plaster model
SF28=M3	Modelling according to existing test orthosis or KO plaster model
SF28=M4	Modelling according to existing test orthosis or KAFO plaster model
SF28=G1	Plaster repair and modelling for KAFO/KO
SF28=G2	Plaster repair and modelling for DAFO/AFO
SF28=GN1	Modelling from KAFO/KO plaster negative
SF28=GN2	Modelling from DAFO/AFO plaster negative

2



Padding distance

Article number	for
SF28=P1	Padding distance KAFO/KO
SF28=P2	Padding distance DAFO/AFO

3

4

Information on the Ordering Process

Prepare a plaster positive of the affected leg and mark the desired design options on it (for details, please see the 646A115=GB Technical Information). Please also fill out the order form.

Send the plaster positive along with the order form to Ottobock Service Fabrication.

Ottobock Service Fabrication will fabricate the orthosis for you and usually ship it within 10 working days.

You receive an orthosis with an exact fit and optimised material characteristics.

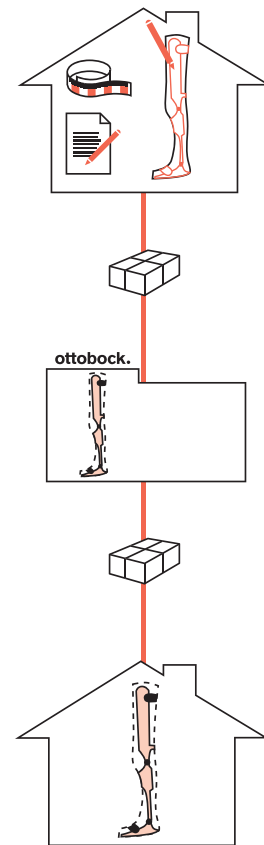

Orthoses in Malmö Technique

Order form

1

Contact		Customer number		Date	
Customer			Shipping address (if different from customer address)		
Company			Company		
Street			Street		
Postal code/city			Postal code/city		
Email			Phone		
Patient ID					

2

Diagnosis: Other diseases:

.....

.....

.....

Shipping: Pick-up service (free of charge) Self-shipment

Trial orthosis (made of thermoplastic resin) Definitive orthosis

Model

Ankle foot orthosis without joint

- DAFO – left
- DAFO – right

Knee orthosis

- KO – left
- KO – right

Ankle foot orthosis with joint

- AFO – left
- AFO – right

Knee-ankle-foot orthosis

- KAFO – left
- KAFO – right

3

Indications for the fitting

Patient: Age: Height: m Weight: kg

Worn for everyday use work sports competitive sports

4

Comments:

.....

.....

.....

.....

Orthoses in Malmö Technique

Order form

Contact	Customer number	Date
---------	-----------------	------

Padding dummy

- Fabricate the orthosis directly on the positive model, without allowing for any padding distance.
- The model has been created without padding distance. Please take into account a padding distance for the:
- Thigh of mm
 - Lower leg of mm
 - Foot of mm

Joints

- Knee joint: Yes No Art. no. With system lamination joint bars Without system lamination joint bars
- Ankle joint: Yes No Art. no. With system lamination joint bars Without system lamination joint bars

Sole

	Rollover		Dynamic		Spring stiffness	
	Without resistance					
	→					
	1 Soft	2	3	4	5	Stiff
Forefoot characteristics:	<input type="checkbox"/>	<input type="checkbox"/>	<input type="checkbox"/>	<input type="checkbox"/>	<input type="checkbox"/>	<input type="checkbox"/>
Heel:	<input type="checkbox"/>		<input type="checkbox"/>		<input type="checkbox"/>	<input type="checkbox"/>

Tongues or flaps

- On the foot Yes No Single tongue, medial fixed Single tongue, lateral fixed Double tongue
- On the lower leg Yes No Single tongue, medial fixed Single tongue, lateral fixed Double tongue
- On the thigh Yes No Single tongue, medial fixed Single tongue, lateral fixed Double tongue

Surface design

- Unfinished carbon design Finished glossy carbon design (surcharge)
- Socket decor design (possible surcharge) Art. no. (from 646K1 Material Catalogue)

Comments:

.....

.....

1

2

3

4



Free Walk Orthoses

Walk smoothly and stand securely with the custom-made Ottobock Free Walk Orthosis – this special orthosis system from Ottobock locks the knee joint during the stance phase and releases it during the swing phase. The light and stable Free Walk Orthosis lightens the load on the back, hips and knee joint through its functionality. It is easy to apply and hardly noticeable under clothing. The Free Walk Orthosis provides the patient with security, stability and freedom of movement. The Free Walk was developed for patients who, due to partial paralysis or a complete failure of the knee extensors, are unable to stabilise their knee without compensating measures. The knee joint is often stabilised through hyperextension achieved by compensating actions of the gluteal muscles (when the foot touches the ground, hip extension leads to knee extension). As a result, severe ligament instabilities and arthrotic symptoms in the knee joint will develop over time. The Free Walk Orthosis helps correct these non-physiological movements. It offers safe functionality for the patient and enables a largely normal gait.

Versions

Please note that the insole must also be sent to us.

1



170K1 Free Walk Orthosis

The Free Walk Orthosis is pre-fabricated for the first trial fitting according to your specifications. The tool kit and datasheets are needed for the measurements required for the fabrication of the orthosis.

Article number	Side	Colour	Scope of delivery	for patient weight up to
170K1=L-80-7	left (L)	black		80 kg
170K1=R-80-7	right (R)	black		80 kg
170K1=L-120-7	left (L)	black		120 kg
170K1=R-120-7	right (R)	black		120 kg
170K1=L-80-0	left (L)	skin colour		80 kg
170K1=R-80-0	right (R)	skin colour		80 kg
170K1=L-120-0	left (L)	skin colour		120 kg
170K1=R-120-0	right (R)	skin colour		120 kg
170K1=T				

- The Ottobock Free Walk Test Orthosis (article no.: 170K1=T) is available on loan.

2

3

4

Additional Options

Spacer pads

(T3, T4)



1

170D30 Medial knee guide

- Extension of the indication
- 5° more valgus deformity can be fitted

Article number	Colour	for patient weight up to
170D30=80-7	black	80 kg
170D30=120-7	black	120



2

170D50 Triple control

- Extension of the indication through greater knee joint functionality
- Locked function
- Free function
- Free Walk function



3

170F1 Foot maintenance set

Installation of 170F1 foot stirrup and insole.



4

Tools

1



170W2 Tool Kit

When you purchase the 170W2 Ottobock Free Walk Tool Kit, you obtain all required tools.

2

642T32 Measurement taking forms for the Ottobock Free Walk Orthosis

- 647F136=GB Patient data and measurement form
- 2x 647F140=1 Measurement forms for outline sketch
- 646T5=4.1GB Technical information

3

4

Information on the Ordering Process

Take the patient measurements (note the 646T5=4 Technical Information). Please also complete the forms (patient data and measurement form, measurement forms for the outline sketch) included in the 170W2 Free Walk Orthosis Tool Kit (may be obtained on loan for initial fittings).

Please submit all forms to Ottobock Service Fabrication.

Ottobock Service Fabrication will fabricate a Free Walk orthosis for you, and usually ships it after 5 working days.

You receive a Free Walk orthosis with an exact fit, supporting a harmonious gait pattern and secure stance.

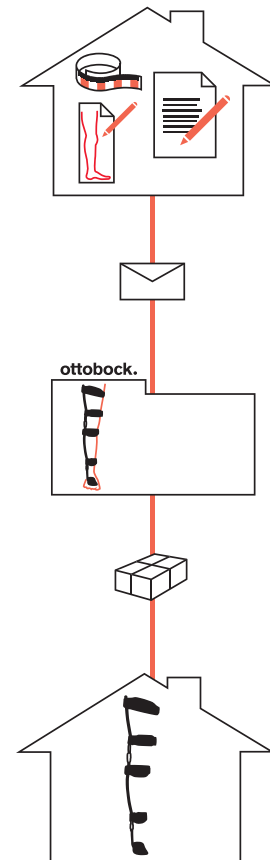

1

2

3

4

 646S3=15.03GB (Info sheet)

 642T32 (measurement taking forms for an Ottobock Free Walk orthosis)
647F136=GB Patient data and measurement form
2x 647F140=1 Measurement form for outline sketch
646T5=4.1GB Technical information
646D182=GB (Information for Doctors)
646D183=GB (Patient Information)
646A214 (Therapeutic Application)
646D352=GB (Product Information)

Ottobock Free Walk Orthosis

Patient information

1

Contact		Customer number		Date	
Customer			Shipping address (if different from customer address)		
Company			Company		
Street			Street		
Postal code/city			Postal code/city		
Email			Phone		
Patient ID					

2

Patient information Male Female Left Right
 Age Height cm Weight

Diagnosis

3

Clinical indications (characteristics)

Muscle strength of hip extensors (scale 0–5)* 5 4 3 2 1 0
 Muscle strength of hip flexors (scale 0–5)* 5 4 3 2 1 0
 Muscle strength of knee extensors (scale 0–5)* 5 4 3 2 1 0
 Hyperextension of the knee Yes No
 Active or passive mobility of the ankle at least 10° Yes No
 Pendulum motion in the hip possible to extend the knee joint at the end of the swing phase. Yes No
 Genu recurvatum (Instruction: in case of hyperextension >5° T3 or T4 is moved to posterior, see measurement form.) Yes No°
 (*see 646T5=4.1EN/646A214=EN)

Contraindications

Knee flexion contraction Yes No°
 (Knee flexion contraction below 10° is acceptable.)
 Unstable varus position of the knee when fully extended Yes No
 (A redressed varus angle below 10° is acceptable.)
 Unstable valgus position of the knee when fully extended Yes No
 (A redressed valgus angle below 10° is acceptable, with medial knee support maximum 15°.)
 Spasticity Yes No
 Severe instability of the ankle joint Yes No
 (If yes, double ankle joints upon request.)

4

Comments:

.....

.....

Ottobock Free Walk Orthosis

Measurement form

Contact	<input type="text"/>	Customer number	<input type="text"/>	Date	<input type="text"/>
Customer			Shipping address (if different from customer address)		
Company	<input type="text"/>		Company	<input type="text"/>	
Street	<input type="text"/>		Street	<input type="text"/>	
Postal code/city	<input type="text"/>		Postal code/city	<input type="text"/>	
Email	<input type="text"/>		Phone	<input type="text"/>	
Patient ID	<input type="text"/>				

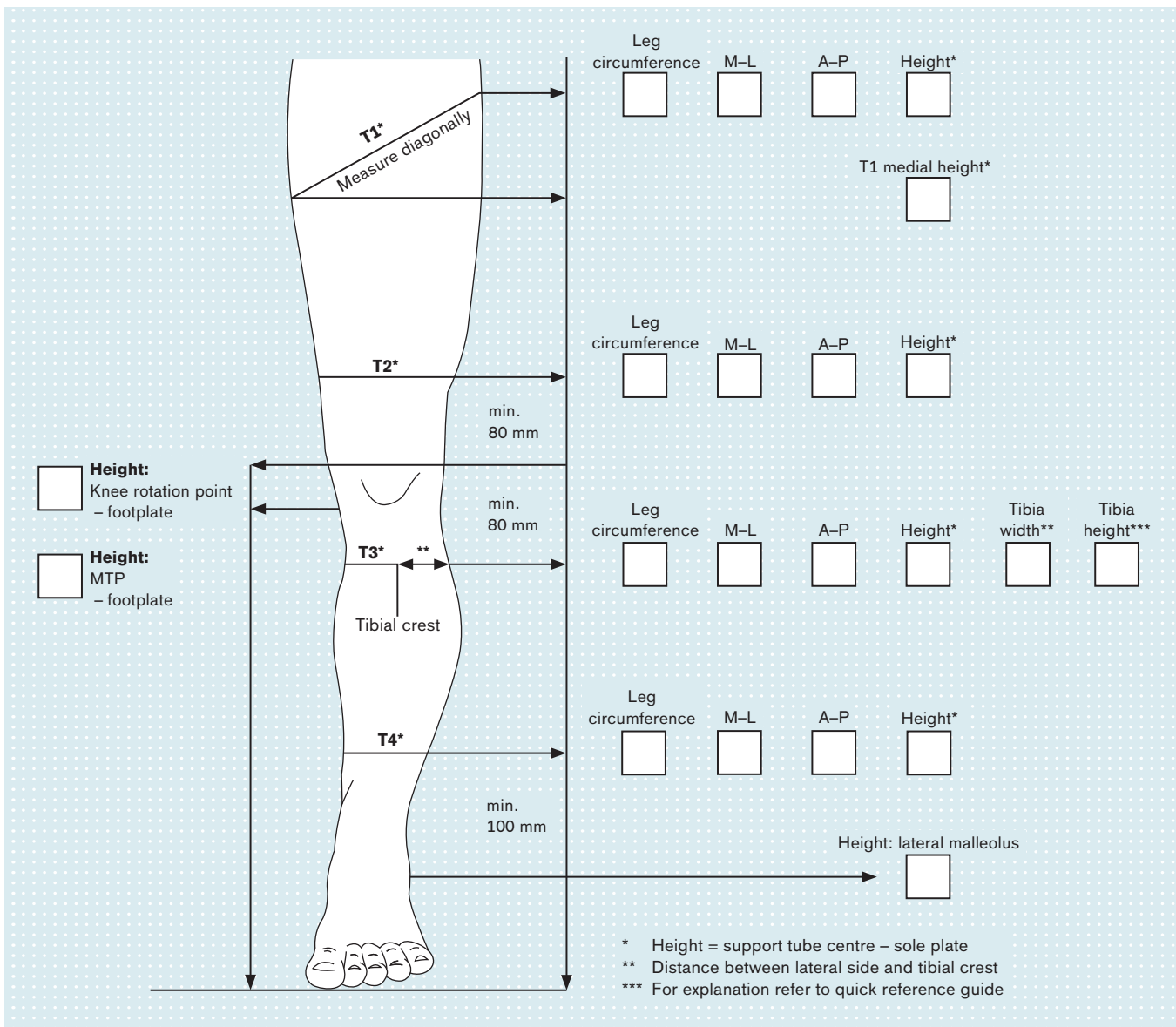

1

2

3

4

Drawing Preparation/Taking Measurements

Quick Reference Guide

Note:

To allow the contour drawings to be used as basis for taking measurements, the bottom side of the measurement form must contact the floor/wall directly. It will then be very easy to determine the measurement form values by measuring the distances to the markings.

Choose a solid background (wall, door frame). Contour drawings made with the patient lying down can result in inaccurate results.

Contour drawing frontal view (Fig. 1)

The patient should be standing.

1. Mark the medial tibial plateau (MTP), knee joint rotation point and lateral malleolus. Later, transfer the measurements from the drawing to the measurement form.
2. Mark **T1** 40 mm below the crotch. Later, transfer the medial and lateral height from T1 to the sole plate from the drawing. Determine additional values according to the measurement form on the patient: measure circumference for T1 with the measuring tape. Then use a calliper to take the A-P and M-L measurements of the thigh on the measuring tape.
3. Mark **T2** 80 mm above the knee rotation point. Determine the values according to the measurement form as with T1.
4. Mark **T3** at least 80 mm below the knee rotation point. If the fibular head can be palpated here, position the support tube more distally. Determine the values according to the measurement form as with T1. Determine additional values according to the measurement form on the patient: measure the tibia width (= tibial crest centre to lateral side) and tibia angle. In doing so, the pivot point of the goniometer should be aligned vertically with the tibial crest. The markings on the goniometer should touch the leg on the medial and lateral side.
5. Mark **T4** 100 mm above the lateral malleolus. Determine the values for the measurement form as with T1.

Contour drawing sagittal view (Fig. 2)

The patient should be standing in neutral zero position.

1. Mark the knee axis, medial tibial plateau (MTP), medial malleolus, and T1–T4.
2. Determine the tibia height (= measurement between tibial crest and lateral compromise pivot point of the knee joint and the lateral malleolus centre).

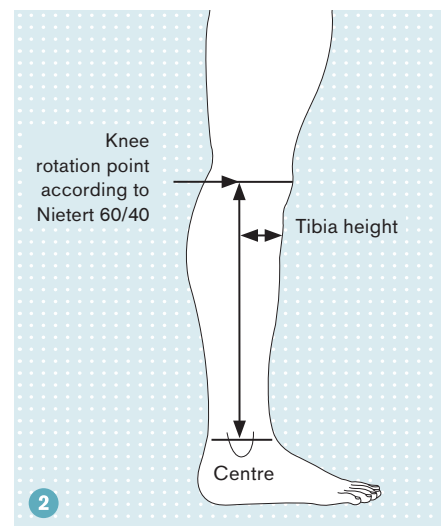
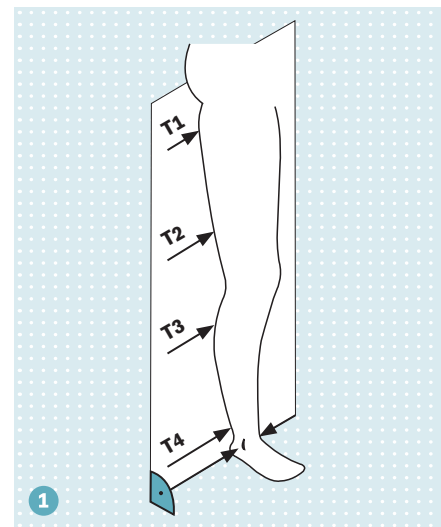

1

2

3

4



Silicone Orthoses for the Upper Limbs

Silicone Orthoses are available for the upper limbs. They are noted for their optimal fit and high functionality thanks to custom fabrication. Ottobock Silicone Service Fabrication offers you customised wrist orthoses, thumb carpometacarpal joint orthoses and finger correction orthoses. Silicon products are hygienic and easy to clean. They can be washed with soap and water. If they become heavily soiled, they can be cleaned by boiling.

1

2

3

4

Ottobock offers several order options to meet the individual needs of your patient.

88IP3=K Wrist orthosis, custom, short with thumb

1



88IP3=L Wrist orthosis, custom, long without thumb

2



88V2=E Custom finger correction sleeve

3

4

Information on the Ordering Process

Prepare a plaster model of the affected hand in its functional position. For wrist and thumb carpometacarpal joint orthoses, it must be made according to the patient's measurements, while it must be reduced by 3% to 5% for finger correction orthoses. Also please mark the proximal and distal edges of the orthosis as well as the positions of the closures and reinforcements on the model and fill out the measurement form.

Please send the plaster model along with the measurement form to Ottobock Service Fabrication.

Ottobock Service Fabrication will fabricate the Silicone Orthosis for you and ship it within 7 working days at the latest.

You receive a functional, easy to care for orthosis with an optimal fit.

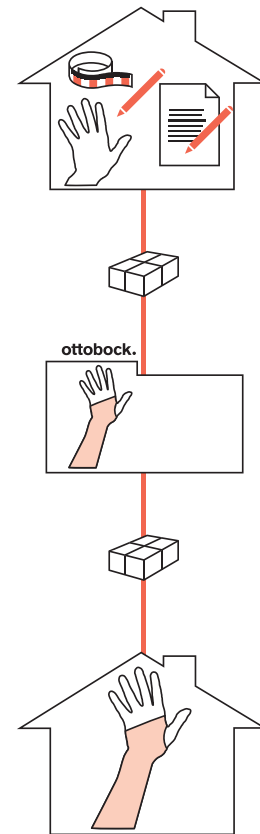

1

2

3

4

Silicone Hand Orthosis

Measurement form

1

Contact		Customer number		Date	
Customer			Shipping address (if different from customer address)		
Company			Company		
Street			Street		
Postal code/city			Postal code/city		
Email			Phone		
Patient ID					

2

Age:

Gender: Female Male

Affected side: Left Right

Diabetic: Yes No

Configuration

Wrist orthosis

With textile coating shore A 65 shore A

Thickness mm

Silicone reinforcement

With volar pocket for PE joint bars

Closures

Number: units
(maximum distance 5 cm)
(with metal loops 2 cm wide)

Colour: Black White

Colour or colour code

Please mark the limits of the orthosis, reinforcements and closure positions on the plaster model.

3

	Patient	Plaster	Model
Heel of hand (A-measurement)	<input type="text"/> cm	<input type="text"/> cm	<input type="text"/> cm
Thumb-DIP	<input type="text"/> cm	<input type="text"/> cm	<input type="text"/> cm
Wrist (C-measurement)	<input type="text"/> cm	<input type="text"/> cm	<input type="text"/> cm
Forearm (C & D-measurement)	<input type="text"/> cm	<input type="text"/> cm	<input type="text"/> cm
Forearm (D-measurement)	<input type="text"/> cm	<input type="text"/> cm	<input type="text"/> cm
	Prosthetist	Ottobock	

Comments:

.....

.....

.....

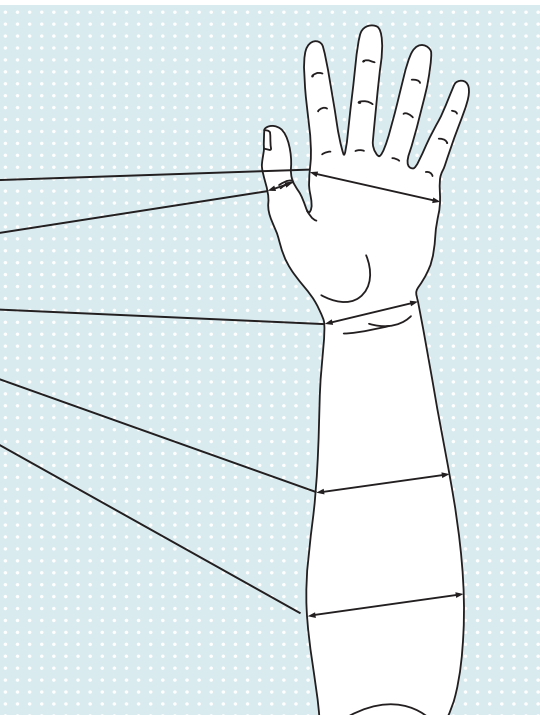

4

A large grid of small dots for taking measurements, consisting of 20 columns and 40 rows of dots.

1

2

3

4

1



2



3

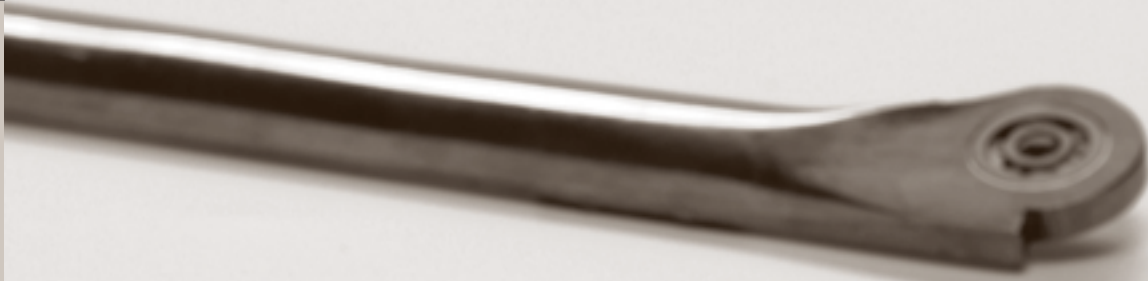

4



Custom Joint Bars

When the standard product range in the catalogue is not sufficient, Ottobock offers customised foot, leg and hip joint bars. These customised joint bars are fabricated to your specifications.

1

2

3

4

Information on the Ordering Process

1



Draw a sketch of the required joint bar or submit an existing, corresponding sample.



Please send the order form, and the sample if applicable, to Ottobock Service Fabrication.

2

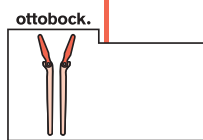

Ottobock Service Fabrication will fabricate the custom joint bar for you and ship it within the agreed term.



3

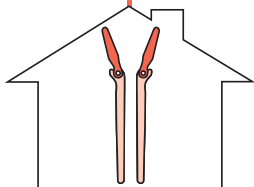

You receive a custom joint bar that meets your specifications precisely.

4

Custom Joint Bars

Measurement form

Contact		Customer number		Date	
Customer			Shipping address (if different from customer address)		
Company			Company		
Street			Street		
Postal code/city			Postal code/city		
Email			Phone		
Patient ID					

Prosthesis Orthosis Would you like to have a cost estimate: Yes No

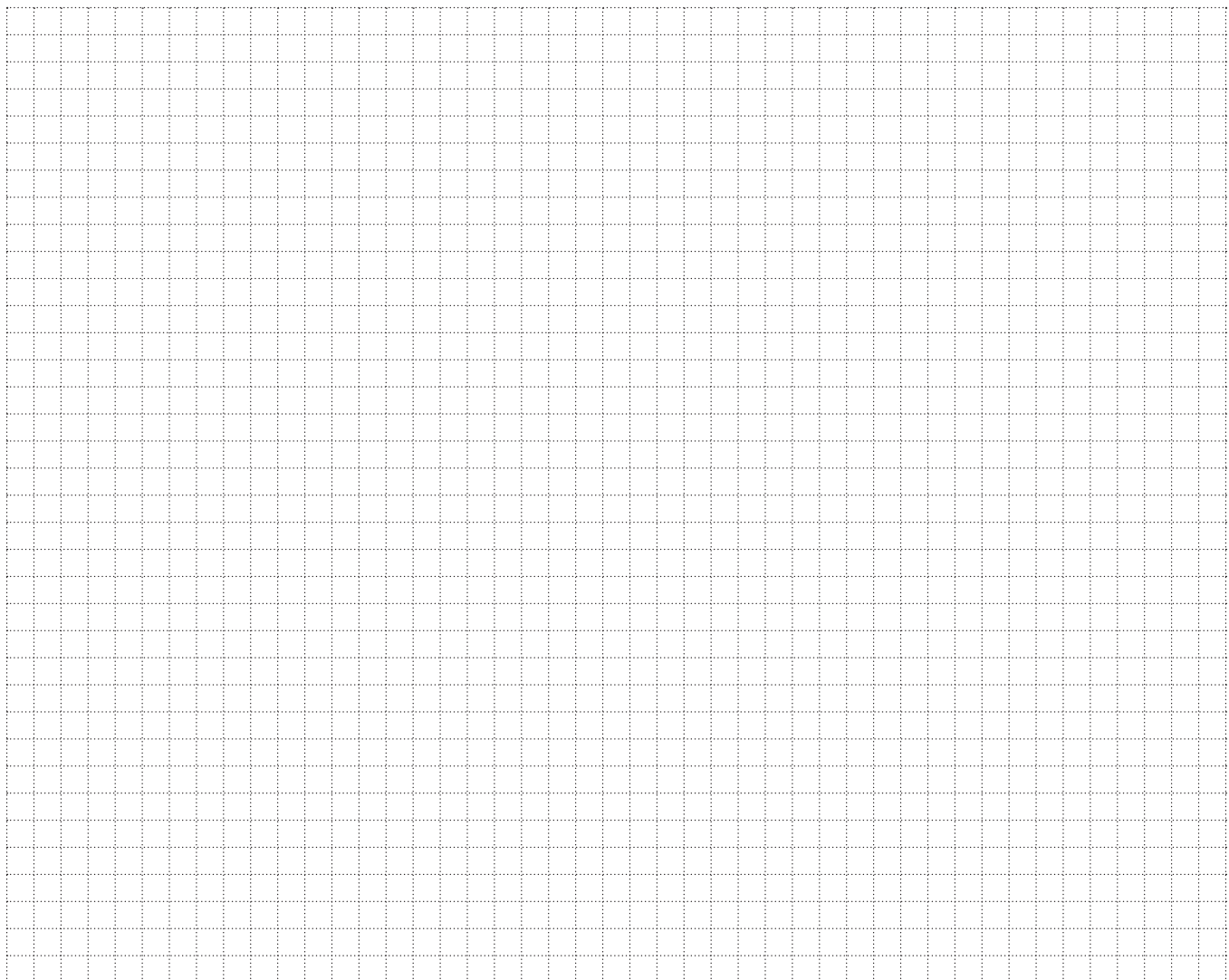

1

2

3

4

Europe



Otto Bock HealthCare Deutschland GmbH
Max-Näder-Str. 15 · 37115 Duderstadt · Germany
T +49 5527 848-3411 · F +49 5527 848-1414
healthcare@ottobock.de · www.ottobock.com



Otto Bock Healthcare Products GmbH
Kaiserstraße 39 · 1070 Wien · Austria
T +43 1 5269548 · F +43 1 5267985
vertrieb.austria@ottobock.com · www.ottobock.at



Otto Bock Adria Sarajevo D.O.O.
Omladinskih radnih brigada 5
71000 Sarajevo · Bosnia-Herzegovina
T +387 33 766200 · F +387 33 766201
obadria@bih.net.ba · www.ottobockadria.com.ba



Otto Bock Bulgaria Ltd.
41 Tzar Boris III' Blvd. · 1612 Sofia · Bulgaria
T +359 2 80 57 980 · F +359 2 80 57 982
info@ottobock.bg · www.ottobock.bg



Otto Bock Suisse AG
Pilatestrasse 2 · CH-6036 Dierikon
T +41 41 455 61 71 · F +41 41 455 61 70
suisse@ottobock.com · www.ottobock.ch



Otto Bock ČR s.r.o.
Protetická 460 · 33008 Zruč-Senec · Czech Republic
T +420 377825044 · F +420 377825036
email@ottobock.cz · www.ottobock.cz



Otto Bock Iberica S.A.
C/Majada, 1 · 28760 Tres Cantos (Madrid) · Spain
T +34 91 8063000 · F +34 91 8060415
info@ottobock.es · www.ottobock.es



Otto Bock France SNC
4 rue de la Réunion · CS 90011
91978 Courtaboeuf Cedex · France
T +33 1 69188830 · F +33 1 69071802
information@ottobock.fr · www.ottobock.fr



Otto Bock Healthcare plc
32, Parsonage Road · Englefield Green
Egham, Surrey TW20 0LD · United Kingdom
T +44 1784 744900 · F +44 1784 744901
bockuk@ottobock.com · www.ottobock.co.uk



Otto Bock Hungária Kft.
Tatai út 74. · 1135 Budapest · Hungary
T +36 1 4511020 · F +36 1 4511021
info@ottobock.hu · www.ottobock.hu



Otto Bock Adria d.o.o.
Dr. Franje Tuđmana 14 · 10431 Sveta Nedelja · Croatia
T +385 1 3361 544 · F +385 1 3365 986
ottobockadria@ottobock.hr · www.ottobock.hr



Otto Bock Italia Srl Us
Via Filippo Turati 5/7 · 40054 Budrio (BO) · Italy
T +39 051 692-4711 · F +39 051 692-4710
info.italia@ottobock.com · www.ottobock.it



Otto Bock Benelux B.V.
Ekkersrijt 1412 · 5692 AK
Son en Breugel · The Netherlands
T +31 499 474585 · F +31 499 476250
info.benelux@ottobock.com · www.ottobock.nl



Industria Ortopédica Otto Bock Unip. Lda.
Av. Miguel Bombarda, 21 · 2º Esq.
1050-161 Lisboa · Portugal
T +351 21 3535587 · F +351 21 3535590
ottobockportugal@mail.telepac.pt



Otto Bock Polska Sp. z o. o.
Ulica Koralowa 3 · 61-029 Poznań · Poland
T +48 61 6538250 · F +48 61 6538031
ottobock@ottobock.pl · www.ottobock.pl



Otto Bock Romania srl
Șos de Centura Chitila - Mogoșoia Nr. 3
077405 Chitila, Jud. Ilfov · Romania
T +40 21 4363110 · F +40 21 4363023
info@ottobock.ro · www.ottobock.ro



OOO Otto Bock Service
p/o Pultikovo, Business Park „Greenwood”,
Building 7, 69 km MKAD
143441 Moscow Region/Krasnogorskiy Rayon
Russian Federation
T +7 495 564 8360 · F +7 495 564 8363
info@ottobock.ru · www.ottobock.ru



Otto Bock Scandinavia AB
Koppargatan 3 · Box 623 · 60114 Norrköping · Sweden
T +46 11 280600 · F +46 11 312005
info@ottobock.se · www.ottobock.se



Otto Bock Slovakia s.r.o.
Röntgenova 26 · 851 01 Bratislava 5 · Slovak Republic
T +421 2 32 78 20 70 · F +421 2 32 78 20 89
info@ottobock.sk · www.ottobock.sk



Otto Bock Sava d.o.o.
Maksima Gorkog bb · 18000 Niš · Republika Srbija
T +381 18 4285888 · F +381 18 4539191
info@ottobock.rs · www.ottobock.rs



Otto Bock Ortopedi ve Rehabilitasyon Tekniği Ltd. Şti.
Ali Dursun Bey Caddesi · Latı Lokum Sokak
Meriç Sitesi B Blok No: 6/1
34387 Mecidiyeköy-Istanbul · Turkey
T +90 212 3565040 · F +90 212 3566688
info@ottobock.com.tr · www.ottobock.com.tr

Africa



Otto Bock Algérie E.U.R.L.
32, rue Ahcène Outaleb · Coopérative les Mimosas
Mackle-Ben Aknoun · Alger · DZ Algérie
T +213 21 913863 · F +213 21 913863
information@ottobock.fr · www.ottobock.fr



Otto Bock Egypt S.A.E.
28 Soliman Abaza St. Mohandessein · Giza · Egypt
T +202 330 24 390 · F +202 330 24 380
info@ottobock.com.eg · www.ottobock.com.eg



Otto Bock South Africa (Pty) Ltd
Building 3 Thornhill Office Park · 94 Bekker Road
Midrand · Johannesburg · South Africa
T +27 11 312 1255
info-southafrica@ottobock.co.za · www.ottobock.co.za

Americas



Otto Bock Argentina S.A.
Av. Cabildo 924 · CP 1426
Ciudad Autónoma de Buenos Aires · Argentina
T +54 11 4706-2255 · F +54 11 4788-3006
atencionclientes@ottobock.com.ar
www.ottobock.com.ar



Otto Bock do Brasil Ltda.
Rua Jovelino Aparecido Miguel, 32
13051-030 Campinas-São Paulo · Brasil
T +55 19 3729 3500 · F +55 19 3269 6061
ottobock@ottobock.com.br · www.ottobock.com.br



Otto Bock HealthCare Canada
5470 Harvester Road
Burlington, Ontario, L7L 5N5, Canada
T +1 289 288-4848 · F +1 289 288-4837
infocanada@ottobock.com · www.ottobock.ca



Otto Bock HealthCare Andina Ltda.
Clínica Universitaria Teletón, Autopista Norte km 21
La Caro Chia, Cundinamarca · Bogotá · Colombia
T +57 1 8619988 · F +57 1 8619977
info@ottobock.com.co · www.ottobock.com.co



Otto Bock de Mexico S.A. de C.V.
Prolongación Calle 18 No. 178-A
Col. San Pedro de los Pinos
C.P. 01180 México, D.F. · Mexico
T +52 55 5575 0290 · F +52 55 5575 0234
info@ottobock.com.mx · www.ottobock.com.mx



Otto Bock HealthCare
Two Carlson Parkway North, Suite 100
Minneapolis, MN 55447 · USA
T +1 763 553 9464 · F +1 763 519 6153
usa.customerservice@ottobockus.com · www.ottobockus.com

Asia/Pacific



Otto Bock Australia Pty. Ltd.
Suite 1.01, Century Corporate Centre · 62 Norwest Boulevard
Baulkham Hills NSW 2153 · Australia
T +61 2 8818 2800 · F +61 2 8814 4500
healthcare@ottobock.com.au · www.ottobock.com.au



Beijing Otto Bock Orthopaedic Industries Co., Ltd.
B12E, Universal Business Park
10 Jiuxianqiao Road, Chao Yang District
Beijing, 100015, P.R. China
T +8610 8598 6880 · F +8610 8598 0040
news-service@ottobock.com.cn · www.ottobock.com.cn



Otto Bock Asia Pacific Ltd.
Suite 3218, 32/F., Sun Hung Kai Centre
30 Harbour Road, Wanchai, Hong Kong · China
T +852 2598 9772 · F +852 2598 7886
info@ottobock.com.hk



Otto Bock HealthCare India
Behind FairLawn Housing Society
St. Gregorios Lane, Sion Trombay Road
Chembur, Mumbai, 400071 · India
T +91 22 2520 1268 · F +91 22 2520 1267
information@indiaottobock.com · www.ottobock.in



Otto Bock Japan K. K.
Yokogawa Building 8F, 4-4-44 Shibaura
Minato-ku, Tokyo, 108-0023 · Japan
T +81 3 3798-2111 · Fax +81 3 3798-2112
ottobock@ottobock.co.jp · www.ottobock.co.jp



Otto Bock Korea HealthCare Inc.
4F Agaworld Building · 1357-74, Seocho-dong
Seocho-ku, 137-070 Seoul · Korea
T +82 2 577-3831 · F +82 2 577-3828
info@ottobockkorea.com · www.ottobockkorea.com



Otto Bock South East Asia Co., Ltd.
1741 Phaholyothin Road,
Kwaeng Chatuchark, Khet Chatuchark
Bangkok 10900 · Thailand
T +66 2 930 3030 · F +66 2 930 3311
obsea@ottobock.co.th · www.ottobock.co.th

Otto Bock HealthCare Deutschland GmbH
Max-Näder-Straße 15 · 37115 Duderstadt/Germany
T +49 5527 848-3030 · F +49 5527 848-1585
servicefertigung@ottobock.de · www.ottobock.com