



2023/2024

new  
generation





vialli

Stilvolles Design in moderner, minimalistischer Atmosphäre  
 Stylish design in a modern, minimalist atmosphere  
 Un design élégant dans une atmosphère moderne et minimaliste  
 Stijlvol design in een moderne, minimalistische sfeer







Frontdekore | Front finishes | Façades | Front kleuren

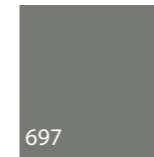

697  
Betongrün  
concrete green  
vert béton  
betongroen

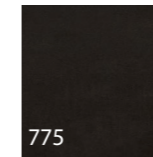

775  
Stahl Dunkel matt  
steel dark matt  
acier sombre mat  
staal donker mat

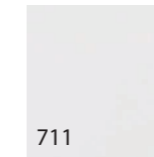

711  
Weiß matt  
white matt  
blanc mat  
wit mat

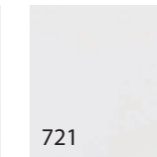

721  
Weiß hgl.  
white hgl.  
blanc haute  
hoogglans wit

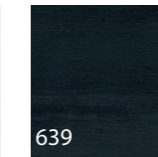

639  
Eiche Schwarz  
oak black  
chêne noir  
eiken zwart



670  
Halifax Eiche  
halifax oak  
chêne Halifax  
halifax eiken

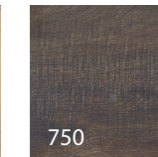

750  
Cardiff Eiche  
cardiff oak  
chêne Cardiff  
cardiff eiken

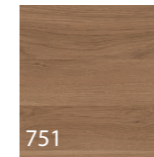

751  
Cuneo Eiche Braun  
cuneo oak brown  
Cuneo imitation  
chêne marron  
cuneo eiken bruin

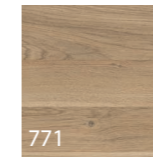

771  
Cuneo Eiche Natural  
cuneo oak natural  
Cuneo imitation  
chêne naturel  
cuneo eiken naturel

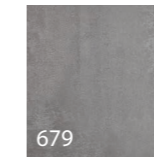

679  
Betonoptik  
concrete imitation  
aspect béton  
betonoptiek

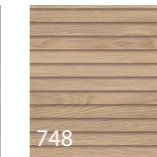

748  
Deepline Hell  
Deepline light  
Deepline clair  
Deepline licht

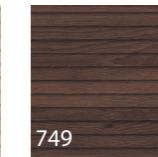

749  
Deepline Dunkel  
Deepline dark  
Deepline sombre  
Deepline donker



Griffprofil  
in Korpusdekor  
handle profile  
in carcass colour  
profil de poignée  
en coloris de corps  
greetprofiel  
in corpus kleur

Korpusdekore und Waschtischplattendekore

Carcass colours and Washbasin top colours | Corps de meuble et Coloris plan de toilette pour vasque à poser | Corpus kleuren en Wastafelplaat kleuren

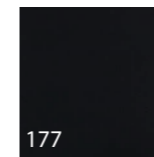

177  
Cosmos Grey matt  
cosmos grey matt  
cosmos grey mat  
cosmos grey mat

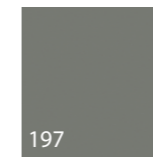

197  
Betongrün  
concrete green  
vert béton  
betongroen

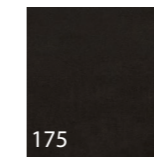

175  
Stahl Dunkel matt  
steel dark matt  
acier sombre mat  
staal donker mat

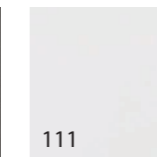

111  
Weiß matt  
white matt  
blanc mat  
wit mat

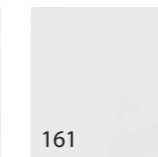

161  
Weiß hgl.  
white hgl.  
blanc haute  
hoogglans wit

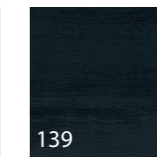

139  
Eiche Schwarz  
oak black  
chêne noir  
eiken zwart



170  
Halifax Eiche  
halifax oak  
chêne Halifax  
halifax eiken

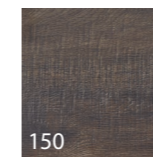

150  
Cardiff Eiche  
cardiff oak  
chêne Cardiff  
cardiff eiken



151  
Cuneo Eiche Braun  
cuneo oak brown  
Cuneo imitation  
chêne marron  
cuneo eiken bruin



171  
Cuneo Eiche Natural  
cuneo oak natural  
Cuneo imitation  
chêne naturel  
cuneo eiken naturel



179  
Betonoptik  
concrete imitation  
aspect béton  
betonoptiek







Planungsbeispiele  
Planning examples | Exemples de composition | Sets

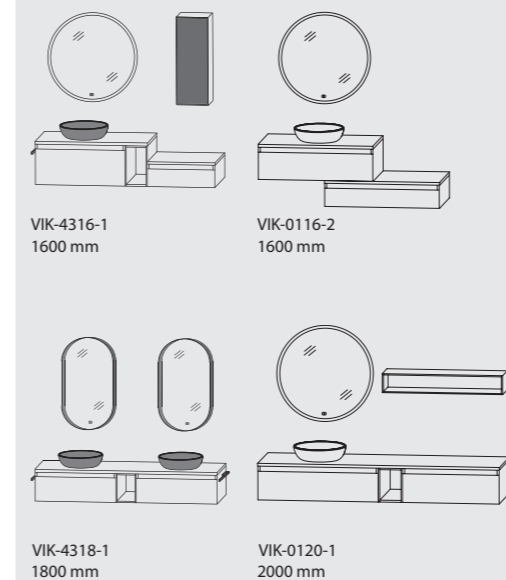

Ergänzungsschränke | Additional cabinets | Meubles complémentaires | Losse kasten

Highboards | highboards | highboards | highboards

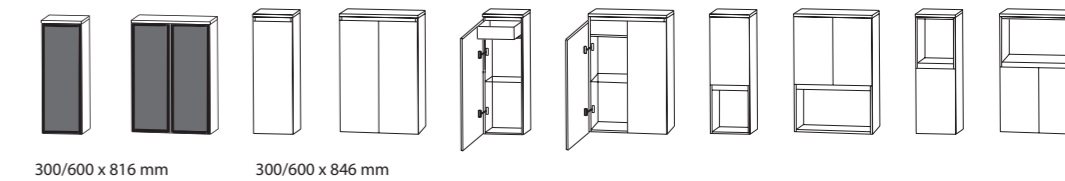

Oberschränke | wall units | éléments suspendus | bovenkasten

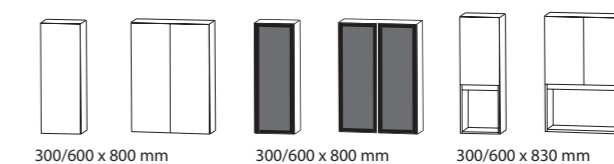

- Breite x Höhe in mm
- Auszug aus dem Typenplan
- Die Artikelnummern der Ergänzungsschränke entnehmen Sie aus den Typenlisten.
- Türen · Auszüge · Schubkästen mit Dämpfung

- Width x height in mm
- Part numbers of the available options
- Please consult the full range available for the article numbers of the add-on cabinets.
- Doors · pull out units · drawers with buffered closing

- Largeur x hauteur in mm
- Extrait du plan type
- Les références des meubles complémentaires sont présentes dans notre liste d'articles.
- Portes · tiroirs · coulissants avec amortisseur

- Breedte x hoogte in mm
- Getoonde kasten zijn een selectie uit de kast mogelijkheden
- De bestelcodes van de losse kasten kunt vindt u bij de losse elementen.
- Deuren en lades met softclose











protection 1

Bestechend klare Formen, geradliniger Charakter, puristischer Keramik-Waschtisch  
 Impressively clear shapes, straightforward character, purity of ceramic washbasins  
 Des formes claires, un style simple, un plan de toilette en céramique épuré  
 Boeiend strakke vormen met een puristische keramische wastafel



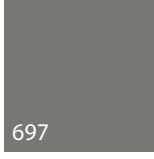
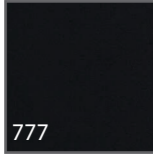
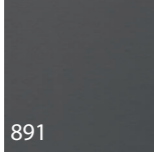

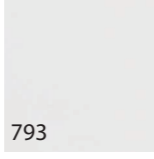
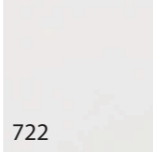
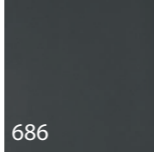
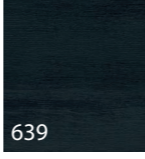

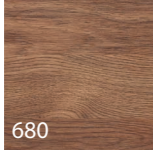
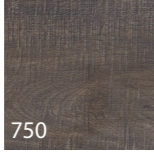
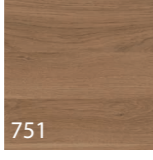
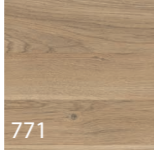
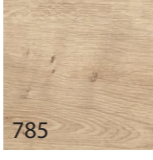
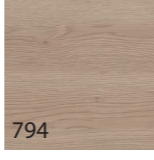



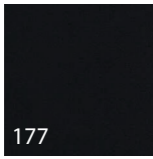
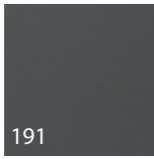

## Frontdekore | Front finishes | Façades | Front kleuren

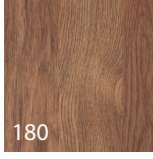
 697 Betongrün concrete green vert béton betongroen	 777 Cosmos Grey matt cosmos grey matt cosmos grey mat cosmos grey mat	 891 Quarzgrau matt quarz grey matt gris quartz mat kwartsgrijs mat	 893 Titangrau matt titanium grey matt titane gris mat titanium grijs mat	 793 Edelweiß matt noble white matt blanc pur mat edelwit mat	 722 Polarweiß hgl. polarwhite hgl. blanc polaire haute brillance hoogglans wit	 686 Anthrazit hgl. anthracite hgl. anthracite haute brillance hoogglans antraciet	 639 Eiche Schwarz oak black chêne noir eiken zwart
 670 Halifax Eiche halifax oak chêne Halifax halifax eiken	 680 Charleston Eiche charleston oak chêne Charleston charleston eiken	 750 Cardiff Eiche cardiff oak chêne Cardiff cardiff eiken	 751 Cuneo Eiche Braun cuneo oak brown Cuneo imitation chêne marron cuneo eiken bruin	 771 Cuneo Eiche Natural cuneo oak natural Cuneo imitation chêne naturel cuneo eiken naturel	 785 Eiche Natur Nachbildung natural oak effect imitation chêne naturel eiken naturel folie	 794 Eiche Sand sand oak chêne sable zand eiken	

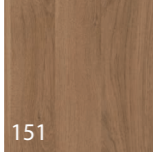
## Korpusdekore | Carcass colours | Corps de meuble | Corpus kleuren

 197 Betongrün concrete green vert béton betongroen	 177 Cosmos Grey matt cosmos grey matt cosmos grey mat cosmos grey mat	 191 Quarzgrau matt quarz grey matt gris quartz mat kwartsgrijs mat	 193 Titangrau matt titanium grey matt titane gris mat titanium grijs mat	 111 Weiß matt white matt blanc mat wit mat	 161 Weiß hgl. white hgl. blanc haute brillance hoogglans wit	 121 Anthrazit hgl. anthracite hgl. anthracite haute brillance hoogglans antraciet	 139 Eiche Schwarz oak black chêne noir eiken zwart
 170 Halifax Eiche halifax oak chêne Halifax halifax eiken	 180 Charleston Eiche charleston oak chêne Charleston charleston eiken	 150 Cardiff Eiche cardiff oak chêne Cardiff cardiff eiken	 151 Cuneo Eiche Braun cuneo oak brown Cuneo imitation chêne marron cuneo eiken bruin	 171 Cuneo Eiche Natural cuneo oak natural Cuneo imitation chêne naturel cuneo eiken naturel	 185 Eiche Natur Nachbildung natural oak effect imitation chêne naturel eiken naturel folie	 194 Eiche Sand sand oak chêne sable zand eiken	

## Planungsbeispiele Planning examples | Exemples de composition | Sets

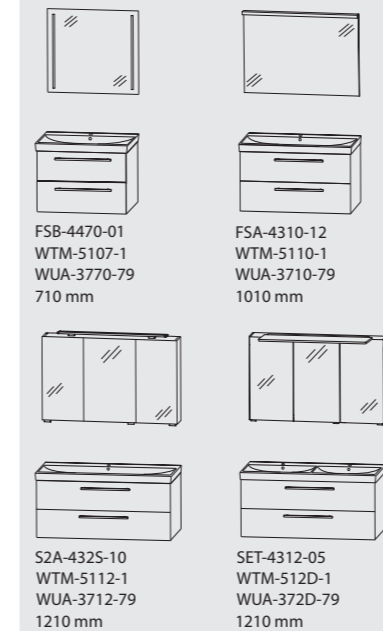

## Ergänzungsschränke | Additional cabinets | Meubles complémentaires | Losse kasten

### Hochschränke | tall units | colonnes | hoge kasten

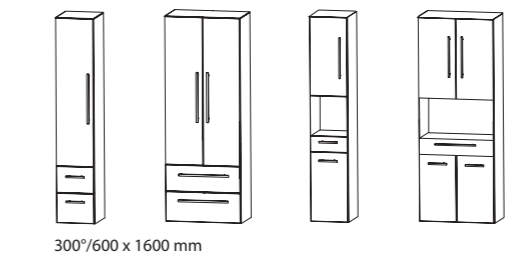

### Mittelschränke | central units | armoires moyennes | middenkasten

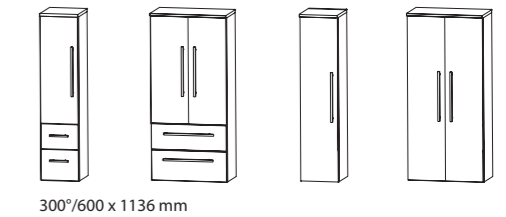

### Highboards | highboards | highboards | highboards

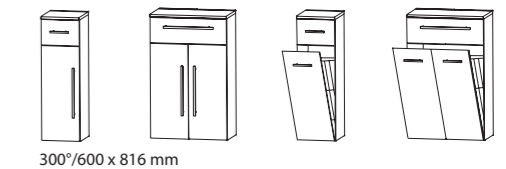
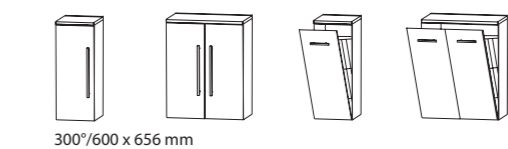

### Ober-/Unterschränke | wall/base units | éléments suspendus/bas | boven-/onderkasten

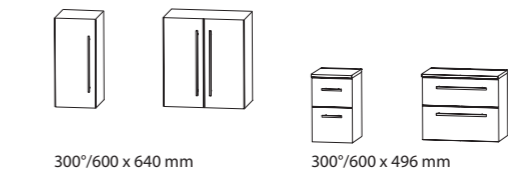

Breite x Höhe in mm  
Width x height in mm  
Largeur x hauteur in mm  
Breedte x hoogte in mm

- ° Schränke auch in 400 mm Breite erhältlich.
- ° Cabinets also available with a width of 400 mm.
- ° Les armoires sont également disponibles avec une largeur de 400 mm.
- ° Kasten ook verkrijgbaar in 400 mm breedte.



Nr. 294  
Stangengriff chrom  
handle chrome  
poignée barre chrome  
stangengreep chrom

- Auszug aus dem Typenplan
- Die Artikelnummern der Ergänzungsschränke entnehmen Sie aus den Typenlisten.
- Türen · Auszüge · Schubkästen mit Dämpfung
- Part numbers of the available options
- Please consult the full range available for the article numbers of the add-on cabinets.
- Doors · pull out units · drawers with buffered closing

- Extrait du plan type
- Les références des meubles complémentaires sont présentes dans notre liste d'articles.
- Portes · tiroirs · coulissants avec amortisseur
- Getoonde kasten zijn een selectie uit de kast mogelijkheden
- De bestelcodes van de losse kasten kunt u vinden bij de losse elementen.
- Deuren en lades met softclose









d.light

Funktionalität trifft zeitloses Design  
 Functionality meets timeless design  
 La fonctionnalité alliée à un design intemporel  
 Funktionaliteit met een tijdloos design



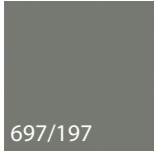
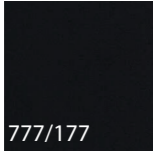
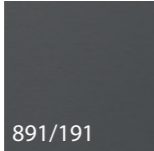
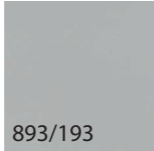
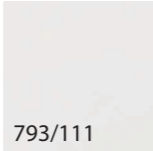
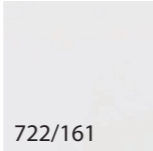
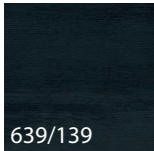

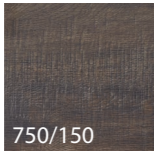
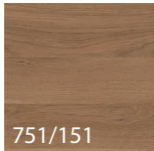
Frontdekore | Front finishes | Façades | Front kleuren  
Korpusdekore | Carcass colours | Corps de meuble | Corpus kleuren

 <p>697/197</p> <p>Betongrün concrete green vert béton betongroen</p>	 <p>777/177</p> <p>Cosmos Grey matt cosmos grey mat cosmos grey mat cosmos grey mat</p>	 <p>891/191</p> <p>Quarzgrau matt quartz grey matt gris quartz mat kwartsgrijs mat</p>	 <p>893/193</p> <p>Titangrau matt titanium grey matt titane gris mat titanium grijs mat</p>	 <p>793/111</p> <p>Edelweiß matt / Weiß matt noble white matt / white matt blanc pur mat / blanc mat edelwit mat / wit mat</p>	 <p>722/161</p> <p>Polarweiß hgl. / Weiß hgl. polarwhite hgl. / white hgl. blanc polaire haute brillance / blanc haute brillance hoogglans wit</p>
 <p>639/139</p> <p>Eiche Schwarz oak black chêne noir eiken zwart</p>	 <p>670/170</p> <p>Halifax Eiche halifax oak chêne Halifax halifax eiken</p>	 <p>750/150</p> <p>Cardiff Eiche cardiff oak chêne Cardiff cardiff eiken</p>	 <p>751/151</p> <p>Cuneo Eiche Braun cuneo oak brown Cuneo imitation chêne marron cuneo eiken bruin</p>	 <p>771/171</p> <p>Cuneo Eiche Natural cuneo oak natural Cuneo imitation chêne naturel cuneo eiken naturel</p>	 <p>785/185</p> <p>Eiche Natur Nachbildung natural oak effect imitation chêne naturel eiken naturel folie</p>



Nr. 294  
Stangengriff chrom  
handle chrome  
poignée barre chrome  
stangengreep chrom

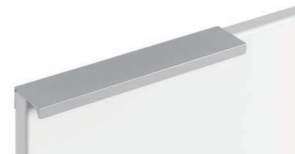

Nr. 343  
Griffleiste alu matt  
strip handle alu matt  
profilé poignée alu mat  
greetlijst alu mat

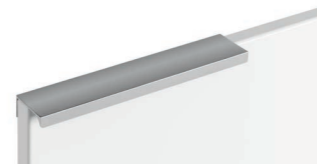

Nr. 334  
Griffleiste chrom  
strip handle chrome  
profilé poignée chrome  
greetlijst chrom



Nr. 344  
Griffleiste schwarz matt  
strip handle black matt  
profilé poignée noir mat  
greetlijst zwart mat

Planungsbeispiele  
Planning examples | Exemples de composition | Sets

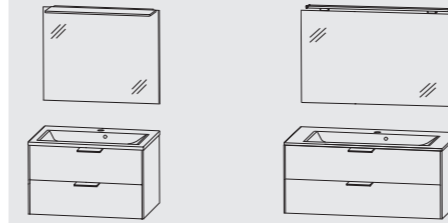

FSA-417B-30  
SET-DL70-1\*  
732 mm

FSA-411B-01  
SET-DL10-1\*  
1032 mm

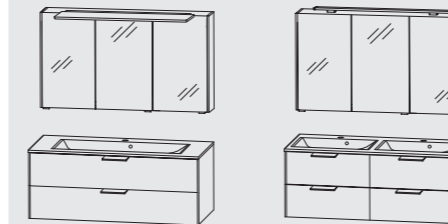

SET-432D-02  
SET-DL12-1\*  
1232 mm

SET-432D-01  
SET-DL2D-1\*  
1232 mm

\* auch mit LED-Beleuchtung erhältlich  
\* also available with LED lighting  
\* aussi disponible avec éclairage LED  
\* ook mogelijk met LED verlichting



Ergänzungsschränke | Additional cabinets | Meubles complémentaires | Losse kasten

Hochschränke | tall units  
colonnes | hoge kasten

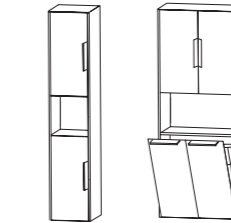

320°/620 x 1290 mm

Mittelschränke | central units  
armoires moyennes | middenkasten

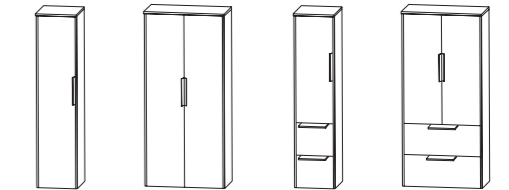

325°/625 x 1630 mm

Highboards | highboards | highboards | highboards

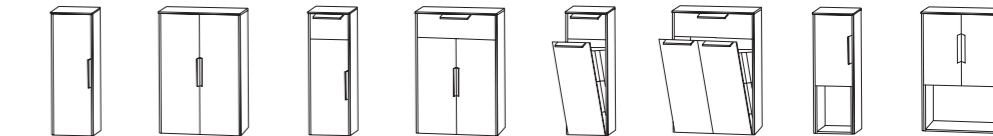

325°/625 x 810 mm

Ober-/Unterschränke | wall/base units | éléments suspendus/bas | boven-/onderkasten

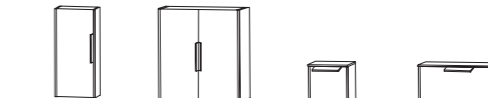

320°/620 x 640 mm

325°/625 x 490 mm

° Schränke auch in 420 / 425 mm Breite erhältlich.  
° Cabinets also available with a width of 420 / 425 mm.  
° Les armoires sont également disponibles avec une largeur de 420 / 425 mm.  
° Kasten ook verkrijgbaar in 420 / 425 mm breedte.

Breite x Höhe in mm  
Width x height in mm  
Largeur x hauteur in mm  
Breedte x hoogte in mm

– Auszug aus dem Typenplan  
– Die Artikelnummern der Ergänzungsschränke entnehmen Sie aus den Typenlisten.  
– Türen · Auszüge · Schubkästen mit Dämpfung

– Extrait du plan type  
– Les références des meubles complémentaires sont présentes dans notre liste d'articles.  
– Portes · tiroirs · coulissants avec amortisseur

– Part numbers of the available options  
– Please consult the full range available for the article numbers of the add-on cabinets.  
– Doors · pull out units · drawers with buffered closing

– Getoonde kasten zijn een selectie uit de kast mogelijkheden  
– De bestelcodes van de losse kasten kunt vindt u bij de losse elementen.  
– Deuren en lades met softclose





unique

Unschlagbare Kombination aus filigranen Details mit enormer Anpassungsfähigkeit  
 Unbeatable combination of fine details with enormous adaptability  
 Alliance incomparable de délicats détails et de grande adaptabilité  
 Onverslaanbare combinatie van filigrane details met enorme aanpassingsmogelijkheden







Griffprofil  
in Korpusdekor  
handle profile  
in carcass colour  
profil de poignée  
en coloris de corps  
griepprofiel  
in corpus kleur



Nr. 324  
Griffleiste chrom  
strip handle chrome  
profilé poignée chrome  
grieplijst chroom

Frontdekore / Korpusdekore / Seitenaufdopplungsdekore | Front finishes / carcass colours / side doubling colours  
Façades / corps de meuble / coloris de doublage | Front kleuren / corpus kleuren / wangen kleuren

697 / 197 Betongrün concrete green vert béton betongroen	775 / 175 Stahl Dunkel matt steel dark matt acier sombre mat staal donker mat	793 / 111 Edelweiß matt noble white matt blanc pur mat edelwit mat	722 / 161 Polarweiß hgl. polarwhite hgl. blanc polaire haute brillance hoogglans wit	679 / 179 Betonoptik concrete imitation aspect béton betonoptiek	639 / 139 Eiche Schwarz oak black chêne noir eiken zwart
670 / 170 Halifax Eiche halifax oak chêne Halifax halifax eiken	750 / 150 Cardiff Eiche cardiff oak chêne Cardiff cardiff eiken	751 / 151 Cuneo Eiche Braun cuneo oak brown Cuneo imitation chêne marron cuneo eiken bruin	771 / 171 Cuneo Eiche Natural cuneo oak natural Cuneo imitation chêne naturel cuneo eiken naturel	794 / 194 Eiche Sand sand oak chêne sable zand eiken	



Waschtischplatten- und Abdeckplattendekore  
Washbasin top and top cover colours | Coloris plan de toilette pour vasque à poser et coloris  
de plateaux de recouvrement | Wastafelplaat en afdeklad kleuren

197 Betongrün concrete green vert béton betongroen	175 Stahl Dunkel matt steel dark matt acier sombre mat staal donker mat	111 Weiß matt white matt blanc mat wit mat	179 Betonoptik concrete imitation aspect béton betonoptiek	139 Eiche Schwarz oak black chêne noir eiken zwart	170 Halifax Eiche halifax oak chêne Halifax halifax eiken	150 Cardiff Eiche cardiff oak chêne Cardiff cardiff eiken	151 Cuneo Eiche Braun cuneo oak brown Cuneo imitation chêne marron cuneo eiken bruin
171 Cuneo Eiche Natural cuneo oak natural Cuneo imitation chêne naturel cuneo eiken naturel	174*1 Hunton Eiche hunton oak chêne Hunton hunton eiken	185 Eiche Natur Nachbildung natural oak effect imitation chêne naturel	194 Eiche Sand sand oak chêne sable zand eiken	143*2 Schieferoptik slate imitation aspect ardoise leisten look			

\*1zusätzliches Seitenaufdopplungsdekor  
(nicht als Korpusdekor möglich)  
\*1additionnel coloris de doublage  
(pas possible comme coloris de corp)

\*2nur als Waschtischplattendekor erhältlich  
\*2only washbasin plate colour

\*1additionnel coloris de doublage  
(pas possible comme coloris de corp)  
\*1extra wangen kleuren  
(niet mogelijk als corpus kleuren)

\*2seulement coloris plan de toilette pour  
vasque à poser  
\*2alleen wastafelplaat en kleur





Planungsbeispiele  
Planning examples | Exemples de composition | Sets

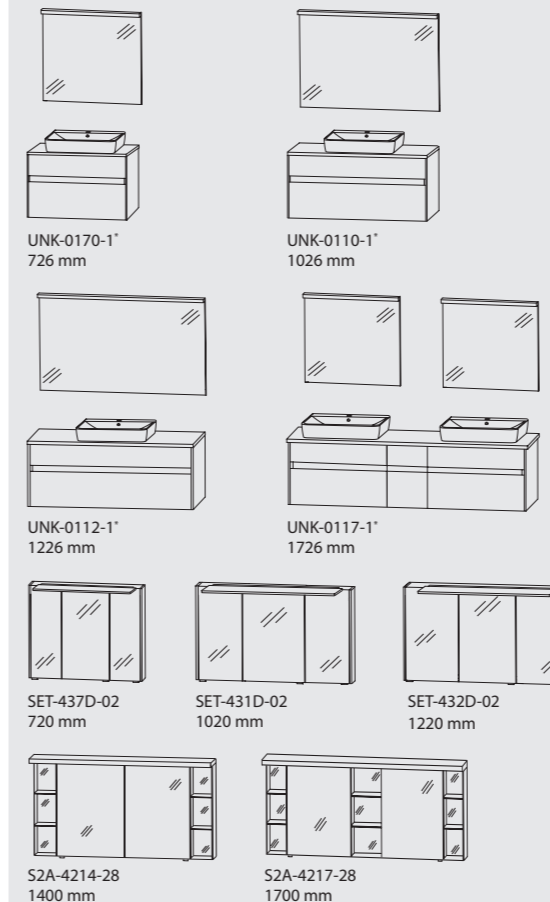

\* auch mit LED-Beleuchtung erhältlich  
\* also available with LED lighting  
\* aussi disponible avec éclairage LED  
\* ook mogelijk met LED verlichting

Abbildungen mit „Ideal Standard CONNECT AIR“ Waschtisch.  
Technical drawing with "Ideal Standard CONNECT AIR" washbasin.  
Les exemples de composition avec vasque à poser «Ideal Standard CONNECT AIR».  
Afgebeeld is met "Ideal Standard CONNECT AIR" wastafel.

Ergänzungsschränke | Additional cabinets | Meubles complémentaires | Losse kasten

Hochschränke | tall units | colonnes | hoge kasten

Mittelschränke | central units | armoires moyennes | middenkasten

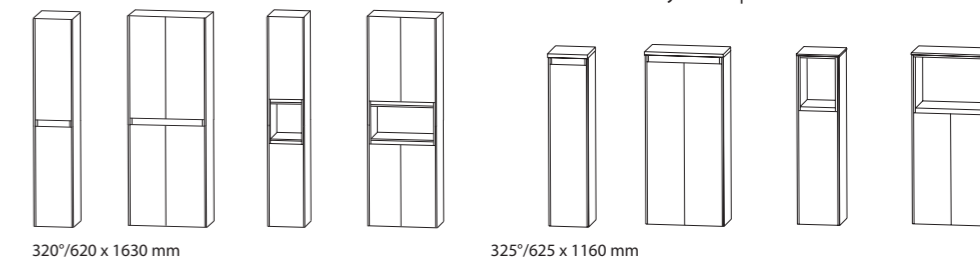

Highboards | highboards | highboards | highboards

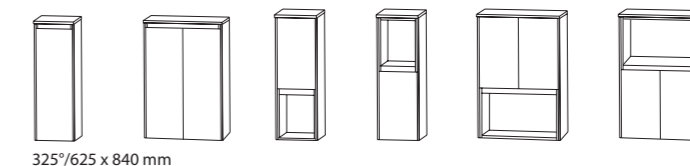

Ober-/Unterschränke | wall/base units | éléments suspendus/bas | boven-/onderkasten

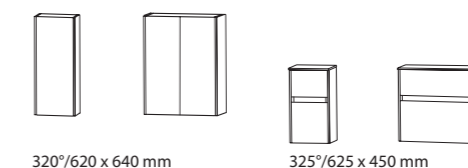

Breite x Höhe in mm  
Width x height in mm  
Largeur x hauteur in mm  
Breedte x hoogte in mm

° Schränke auch in 420 / 425 mm Breite erhältlich.  
° Cabinets also available with a width of 420 / 425 mm.  
° Les armoires sont également disponibles avec une largeur de 420 / 425 mm.  
° Kasten ook verkrijgbaar in 420 / 425 mm breedte.

Abbildungen grifflos, auch mit Griffleiste möglich.  
Technical drawings handleless, also available with strip-handle.  
Les exemples de composition sans poignée possible avec poignée.  
Afbeeldingen zijn greeploos, met greeplijst zijn ook mogelijk.

- Auszug aus dem Typenplan  
- Die Artikelnummern der Ergänzungsschränke entnehmen Sie aus den Typenlisten.  
- Türen · Auszüge · Schubkästen mit Dämpfung

- Extrait du plan type  
- Les références des meubles complémentaires sont présentes dans notre liste d'articles.  
- Portes · tiroirs · coulissants avec amortisseur

- Part numbers of the available options  
- Please consult the full range available for the article numbers of the add-on cabinets.  
- Doors · pull out units · drawers with buffered closing

- Getoonde kasten zijn een selectie uit de kast mogelijkheden  
- De bestelcodes van de losse kasten kunt vindt u bij de losse elementen.  
- Deuren en lades met softclose





purefaction

Geschwungene und ansprechende Formen mit einzigartiger Funktionalität  
 Curved and appealing shapes with unique functionality  
 Des formes courbes et attractives alliées à une fonctionnalité unique  
 Moderne rondingen met unieke functionaliteit







grifflos mit Griffmulde  
handleless with recessed grip  
sans poignée avec prise de main en creux  
greekloos met greeplijstfresing in het front



Nr. 329  
Griffleiste chrom  
strip handle chrome  
profilé poignée chrome  
greeplijst chrom



Nr. 339  
Griffleiste schwarz matt  
strip handle black matt  
profilé poignée noir mat  
greeplijst zwart mat



## Planungsbeispiele Planning examples | Exemples de composition | Sets

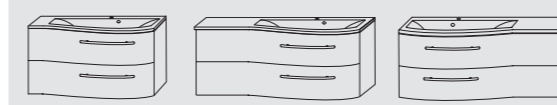

SET-4290-1L (R)  
SET-P229-L (R)  
912 mm

SET-4212-1L (R)  
SET-P222-R (L)  
1212 mm

FSA-4312-11  
SET-P222-R (L)  
1212 mm

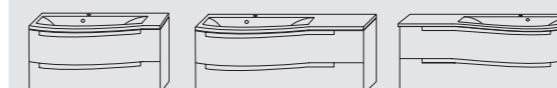

SET-4290-1R (L)  
SET-P209-R (L)  
912 mm

SET-4212-1R (L)  
SET-P212-R (L)  
1212 mm

FSA-4312-11  
SET-P212-L (R)  
1212 mm

\* auch mit LED-Beleuchtung erhältlich  
\* also available with LED lighting  
\* aussi disponible avec éclairage LED  
\* ook mogelijk met LED verlichting

## Frontdekore | Front finishes | Façades | Front kleuren

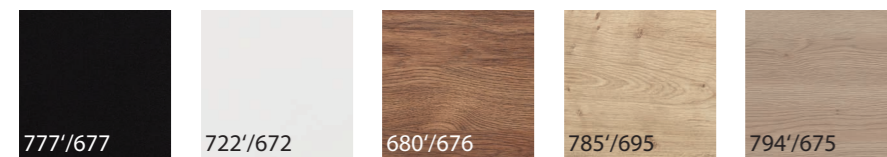

777/677  
Cosmos Grey matt  
cosmos grey matt  
cosmos grey mat  
cosmos grey mat

722/672  
Polarweiß hgl.  
polarwhite hgl.  
blanc polaire haute  
brillance  
hoogglans wit

680/676  
Charleston Eiche  
charleston oak  
chêne Charleston  
charleston eiken

785/695  
Eiche Natur  
Nachbildung  
natural oak effect  
imitation chêne naturel  
eiken naturel folie

794/675  
Eiche Sand  
sand oak  
chêne sable  
zand eiken

## Korpusdekore | Carcass colours | Corps de meuble | Corpus kleuren

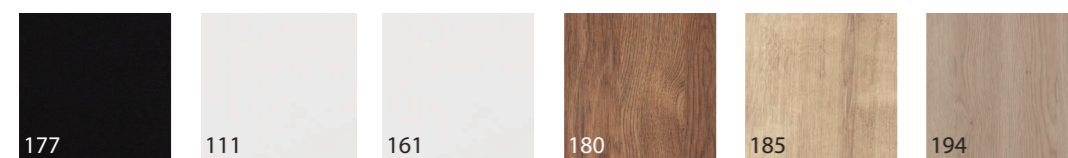

177  
Cosmos Grey matt  
cosmos grey matt  
cosmos grey mat  
cosmos grey mat

111  
Weiß matt  
white matt  
blanc mat  
wit mat

161  
Weiß hgl.  
white hgl.  
blanc haute brillante  
hoogglans wit

180  
Charleston Eiche  
charleston oak  
chêne Charleston  
charleston eiken

185  
Eiche Natur  
Nachbildung  
natural oak effect  
imitation chêne naturel  
eiken naturel folie

194  
Eiche Sand  
sand oak  
chêne sable  
zand eiken



Nr. 320  
Stangengriff chrom  
handle chrome  
poignée barre chrome  
stangengreep chrom



Nr. 350  
Stangengriff schwarz matt  
handle black matt  
poignée barre noir mat  
stangengreep zwart mat

\* Frontdekore nur mit Griff erhältlich.  
\* Front finishes available only with handle.  
\* Façades disponible uniquement avec la poignée.  
\* Front kleuren kan alleen met greep.

## Ergänzungsschränke | Additional cabinets | Meubles complémentaires | Losse kasten

### Hochschränke | tall units | colonnes | hoge kasten

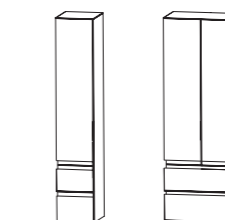

300°/600 x 1600 mm

### Mittelschränke | central units | armoires moyennes | middenkasten

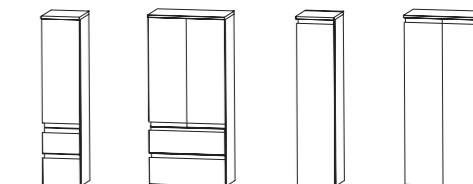

300°/600 x 1136 mm

### Highboards | highboards | highboards | highboards

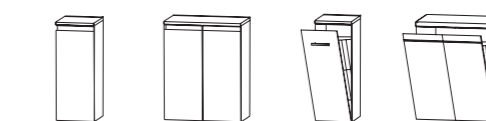

300°/600 x 656 mm

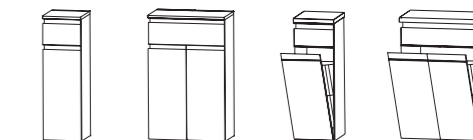

300°/600 x 816 mm

### Ober-/Unterschränke | wall/base units | éléments suspendus/bas | boven-/onderkasten

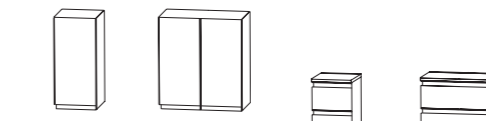

300°/600 x 640 mm



300°/600 x 496 mm

Breite x Höhe in mm  
Width x height in mm  
Largeur x hauteur in mm  
Breedte x hoogte in mm

° Schränke auch in 400 mm Breite erhältlich.  
° Cabinets also available with a width of 400 mm.  
° Les armoires sont également disponibles avec une largeur de 400 mm.  
° Kasten ook verkrijgbaar in 400 mm breedte.

Abbildungen in grifflos, auch mit Griff möglich.  
Technical drawings handleless, also available with handle.  
Les exemples de composition sans poignées également possible avec poignées.  
Afbeeldingen zijn greekloos, met greeplijst zijn ook mogelijk.

- Auszug aus dem Typenplan  
- Die Artikelnummern der Ergänzungsschränke entnehmen Sie aus den Typenlisten.  
- Türen · Auszüge · Schubkästen mit Dämpfung

- Extrait du plan type  
- Les références des meubles complémentaires sont présentes dans notre liste d'articles.  
- Portes · tiroirs · coulissants avec amortisseur

- Part numbers of the available options  
- Please consult the full range available for the article numbers of the add-on cabinets.  
- Doors · pull out units · drawers with buffered closing

- Getoonde kasten zijn een selectie uit de kast mogelijkheden  
- De bestelcodes van de losse kasten kunt u bij de losse elementen.  
- Deuren en lades met softclose











quada

Viel Stauraum hinter glänzendem Auftritt  
 Plenty of storage space behind brilliant appearance  
 De grands espaces de rangement au-delà de l'esthétique  
 Veel opbergruimte achter een glinsterend optreden

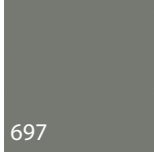
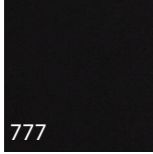
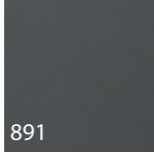

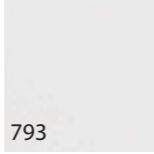
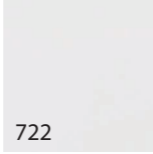
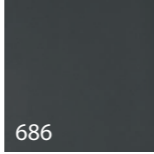
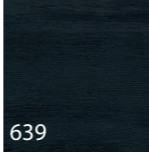

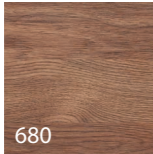
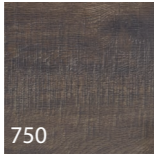
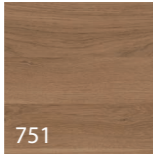
Frontdekore | Front finishes | Façades | Front kleuren

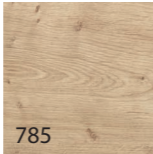
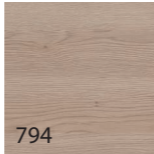
 697 Betongrün concrete green vert béton betongroen	 777 Cosmos Grey matt cosmos grey matt cosmos grey mat cosmos grey mat	 891 Quarzgrau matt quarz grey matt gris quartz mat kwartsgrijs mat	 893 Titangrau matt titanium grey matt titane gris mat titanium grijs mat	 793 Edelweiß matt noble white matt blanc pur mat edelwit mat	 722 Polarweiß hgl. polarwhite hgl. blanc polaire haute brillance hoogglans wit	 686 Anthrazit hgl. anthracite hgl. anthracite haute brillance hoogglans antraciet	 639 Eiche Schwarz oak black chêne noir eiken zwart
 670 Halifax Eiche halifax oak chêne Halifax halifax eiken	 680 Charleston Eiche charleston oak chêne Charleston charleston eiken	 750 Cardiff Eiche cardiff oak chêne Cardiff cardiff eiken	 751 Cuneo Eiche Braun cuneo oak brown Cuneo imitation chêne marron cuneo eiken bruin	 771 Cuneo Eiche Natural cuneo oak natural Cuneo imitation chêne naturel cuneo eiken naturel	 785 Eiche Natur Nachbildung natural oak effect imitation chêne naturel eiken naturel folie	 794 Eiche Sand sand oak chêne sable zand eiken	

Korpusdekore | Carcass colours | Corps de meuble | Corpus kleuren

 197 Betongrün concrete green vert béton betongroen	 177 Cosmos Grey matt cosmos grey matt cosmos grey mat cosmos grey mat	 191 Quarzgrau matt quarz grey matt gris quartz mat kwartsgrijs mat	 193 Titangrau matt titanium grey matt titane gris mat titanium grijs mat	 111 Weiß matt white matt blanc mat wit mat	 161 Weiß hgl. white hgl. blanc haute brillance hoogglans wit	 121 Anthrazit hgl. anthracite hgl. anthracite haute brillance hoogglans antraciet	 139 Eiche Schwarz oak black chêne noir eiken zwart
 170 Halifax Eiche halifax oak chêne Halifax halifax eiken	 180 Charleston Eiche charleston oak chêne Charleston charleston eiken	 150 Cardiff Eiche cardiff oak chêne Cardiff cardiff eiken	 151 Cuneo Eiche Braun cuneo oak brown Cuneo imitation chêne marron cuneo eiken bruin	 171 Cuneo Eiche Natural cuneo oak natural Cuneo imitation chêne naturel cuneo eiken naturel	 185 Eiche Natur Nachbildung natural oak effect imitation chêne naturel eiken naturel folie	 194 Eiche Sand sand oak chêne sable zand eiken	

Planungsbeispiele  
Planning examples | Exemples de composition | Sets

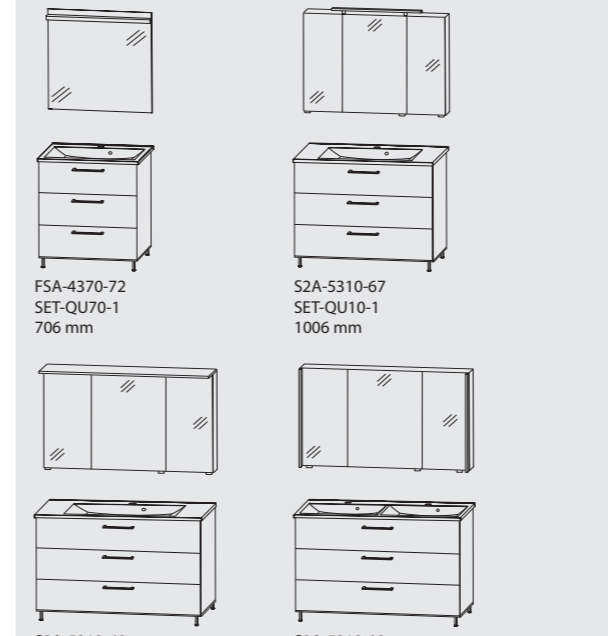

FSA-4370-72  
SET-QU70-1  
706 mm

S2A-5310-67  
SET-QU10-1  
1006 mm

S2A-5312-68  
SET-QU12-1  
1206 mm

S2A-5312-03  
SET-QU2D-1  
1206 mm

Abbildungen mit Mineralguss-Waschtisch, auch in Keramik erhältlich.  
Technical drawing with cast mineral washbasin, also available in ceramic.  
Les exemples de compositions avec plan vasque en matériau de synthèse  
sont également disponible en céramique.  
Afbeeldingen zijn met minerale wastafels, keramische wastafels zijn ook mogelijk.

Ergänzungsschränke | Additional cabinets | Meubles complémentaires | Losse kasten

Hochschränke | tall units | colonnes | hoge kasten

Mittelschränke | central units |  
armoires moyennes | middenkasten



300°/600 x 1748 mm

300°/600 x 1268 mm

Highboards | highboards | highboards | highboards

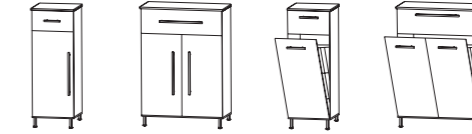

300°/600 x 948 mm

Oberschränke | wall units | éléments suspendus | bovenkasten

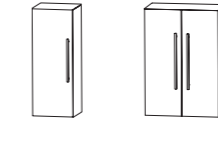

300°/600 x 800 mm

Breite x Höhe in mm  
Width x height in mm  
Largeur x hauteur in mm  
Breedte x hoogte in mm

Höhenangabe inklusive Zierfüße  
Height indication inclusive decoration feet  
Hauteur spécifiée comprend les pieds déco  
Hoogte aangave inclusief siervoet

- ° Schränke auch in 400 mm Breite erhältlich.
- ° Cabinets also available with a width of 400 mm.
- ° Les armoires sont également disponibles avec une largeur de 400 mm.
- ° Kasten ook verkrijgbaar in 400 mm breedte.

- Auszug aus dem Typenplan
- Die Artikelnummern der Ergänzungsschränke entnehmen Sie aus den Typenlisten.
- Türen · Auszüge · Schubkästen mit Dämpfung
- Part numbers of the available options
- Please consult the full range available for the article numbers of the add-on cabinets.
- Doors · pull out units · drawers with buffered closing

- Extrait du plan type
- Les références des meubles complémentaires sont présentes dans notre liste d'articles.
- Portes · tiroirs · coulissants avec amortisseur
- Getoonde kasten zijn een selectie uit de kast mogelijkheden
- De bestelcodes van de losse kasten kunt vindt u bij de losse elementen.
- Deuren en lades met softclose



Nr. 335  
Stangengriff schwarz  
handle black  
poignée barre noir  
stangengreep zwart

Nr. 321  
Stangengriff chrom  
handle chrome  
poignée barre chrome  
stangengreep chroom





vuelta

Perfekte Rundungen mit raffinierten Details  
 Perfect curves with refined details  
 Des rondeurs parfaites dotées de détails raffinés  
 Perfekte rondingen met geraffineerde details





Frontdekore | Front finishes | Façades | Front kleuren

 777	 891	 893	 793	 722	 686
Cosmos Grey matt cosmos grey matt cosmos grey mat cosmos grey mat	Quarzgrau matt quarz grey matt gris quartz mat kwartsgrijs mat	Titangrau matt titanium grey matt titane gris mat titanium grijs mat	Edelweiß matt noble white matt blanc pur mat edelwit mat	Polarweiß hgl. polarwhite hgl. blanc polaire haute brillance hoogglans wit	Anthrazit hgl. anthracite hgl. anthracite haute brillance hoogglans antraciet

 680	 785	 794
Charleston Eiche charleston oak chêne Charleston charleston eiken	Eiche Natur Nachbildung natural oak effect imitation chêne naturel eiken naturel folie	Eiche Sand sand oak chêne sable zand eiken

Korpusdekore | Carcass colours | Corps de meuble | Corpus kleuren

 177	 191	 193	 111	 161	 121
Cosmos Grey matt cosmos grey matt cosmos grey mat cosmos grey mat	Quarzgrau matt quarz grey matt gris quartz mat kwartsgrijs mat	Titangrau matt titanium grey matt titane gris mat titanium grijs mat	Weiß matt white matt blanc mat wit mat	Weiß hgl. white hgl. blanc haute brillance hoogglans wit	Anthrazit hgl. anthracite hgl. anthracite haute brillance hoogglans antraciet

 180	 185	 194
Charleston Eiche charleston oak chêne Charleston charleston eiken	Eiche Natur Nachbildung natural oak effect imitation chêne naturel eiken naturel folie	Eiche Sand sand oak chêne sable zand eiken















Nr. 350  
Stangengriff schwarz  
handle black  
poignée barre noir  
stangengreep zwart

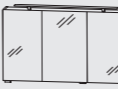













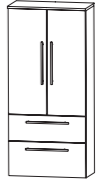



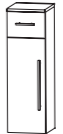

Nr. 320  
Stangengriff chrom  
handle chrome  
poignée barre chrome  
stangengreep chrom

Planungsbeispiele  
Planning examples | Exemples de composition | Sets

 S2A-4375-1* SET-VU70-1** 712 mm	 S2A-4375-2* SET-VU70-1** 712 mm	 S2A-4375-3* SET-VU70-1** 712 mm
 S2A-4395-1* SET-VU90-1** 912 mm	 S2A-4395-2* SET-VU90-1** 912 mm	 S2A-4395-3* SET-VU90-1** 912 mm
 S2A-4325-1* SET-VU12-1** 1212 mm	 S2A-4325-2* SET-VU12-1** 1212 mm	 S2A-4325-3* SET-VU12-1** 1212 mm
 S2A-4345-1* SET-VU14-1** 1412 mm	 S2A-4345-2* SET-VU14-1** 1412 mm	 S2A-4345-3* SET-VU14-1** 1412 mm

Ergänzungsschränke | Additional cabinets | Meubles complémentaires | Losse kasten

<p>Hochschränke   tall units   colonnes   hoge kasten</p>     <p>300°/600 x 1600 mm</p>	<p>Mittelschränke   central units   armoires moyennes   middenkasten</p>     <p>300°/600 x 1296 mm</p>
<p>Highboards   highboards   highboards   highboards</p>     <p>300°/600 x 656 mm</p>	    <p>300°/600 x 816 mm</p>
<p>Ober-/Unterschränke   wall/base units   éléments suspendus/bas   boven-/onderkasten</p>     <p>300°/600 x 640 mm      300°/600 x 496 mm</p>	<p>Breite x Höhe in mm Width x height in mm Largeur x hauteur in mm Breedte x hoogte in mm</p>

° Schränke auch in 400 mm Breite erhältlich.  
° Cabinets also available with a width of 400 mm.  
° Les armoires sont également disponibles avec une largeur de 400 mm.  
° Kasten ook verkrijgbaar in 400 mm breedte.



\* auch mit Facettenschliff erhältlich  
\* also available with facet cut  
\* aussi disponible avec encadrement biseauté  
\* ook mogelijk met facet rand

\*\* auch mit LED-Beleuchtung erhältlich  
\*\* also available with LED lighting  
\*\* aussi disponible avec éclairage LED  
\*\* ook mogelijk met LED verlichting

– Auszug aus dem Typenplan  
– Die Artikelnummern der Ergänzungsschränke entnehmen Sie aus den Typenlisten.  
– Türen · Auszüge · Schubkästen mit Dämpfung  
– Part numbers of the available options  
– Please consult the full range available for the article numbers of the add-on cabinets.  
– Doors · pull out units · drawers with buffered closing

– Extrait du plan type  
– Les références des meubles complémentaires sont présentes dans notre liste d'articles.  
– Portes · tiroirs · coulissants avec amortisseur  
– Getoonde kasten zijn een selectie uit de kast mogelijkheden  
– De bestelcodes van de losse kasten kunt vindt u bij de losse elementen.  
– Deuren en lades met softclose





linea

Ein faszinierender Mix aus Kurven und Ecken  
 A fascinating mix of curves and corners  
 Un mélange fascinant de courbes et d'angles  
 Een fascinerende combinatie van rond en strak





Frontdekore | Front finishes | Façades | Front kleuren

 <b>777</b> Cosmos Grey matt cosmos grey matt cosmos grey mat cosmos grey mat	 <b>891</b> Quarzgrau matt quarz grey matt gris quartz mat kwartsgrijs mat	 <b>893</b> Titangrau matt titanium grey matt titane gris mat titanium grijs mat	 <b>793</b> Edelweiß matt noble white matt blanc pur mat edelwit mat	 <b>722</b> Polarweiß hgl. polarwhite hgl. blanc polaire haute brillance hoogglans wit	 <b>686</b> Anthrazit hgl. anthracite hgl. anthracite haute brillance hoogglans antraciet
--	--	--	--	---	---

 <b>680</b> Charleston Eiche charleston oak chêne Charleston charleston eiken	 <b>785</b> Eiche Natur Nachbildung natural oak effect imitation chêne naturel eiken naturel folie
--	---

Korpusdekore | Carcass colours | Corps de meuble | Corpus kleuren

 <b>177</b> Cosmos Grey matt cosmos grey matt cosmos grey mat cosmos grey mat	 <b>191</b> Quarzgrau matt quarz grey matt gris quartz mat kwartsgrijs mat	 <b>193</b> Titangrau matt titanium grey matt titane gris mat titanium grijs mat	 <b>111</b> Weiß matt white matt blanc mat wit mat	 <b>161</b> Weiß hgl. white hgl. blanc haute brillance hoogglans wit	 <b>121</b> Anthrazit hgl. anthracite hgl. anthracite haute brillance hoogglans antraciet
---	---	---	---	---	--

 <b>180</b> Charleston Eiche charleston oak chêne Charleston charleston eiken	 <b>185</b> Eiche Natur Nachbildung natural oak effect imitation chêne naturel eiken naturel folie
--	---









Nr. 350  
Stangengriff schwarz  
handle black  
poignée barre noir  
stangengreep zwart





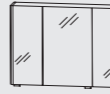
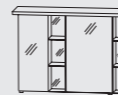

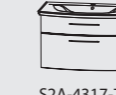



Nr. 320  
Stangengriff chrom  
handle chrome  
poignée barre chrome  
stangengreep chrom



Planungsbeispiele  
Planning examples | Exemples de composition | Sets

 S2A-4270-S1 L (R) SET-LN70-1* 712 mm	 S2A-4370-79 SET-LN70-1* 712 mm	
 S2A-42R1-S1 SET-LN10-1 R* 1012 mm	 S2A-42L1-S1 SET-LN10-1 L* 1012 mm	 S2A-4310-79 SET-LN10-1 L* 1012 mm
 S2A-4213-S1 SET-LN13-1* 1312 mm	 S2A-4313-79 SET-LN13-1* 1312 mm	
 S2A-4217-S1 SET-LN17-1* 1712 mm	 S2A-4317-79 SET-LN17-1* 1712 mm	

Ergänzungsschränke | Additional cabinets | Meubles complémentaires | Losse kasten

<p>Hochschränke   tall units   colonnes   hoge kasten</p>  300°/600 x 1600 mm	 300°/600 x 1296 mm	 300°/600 x 656 mm	 300°/600 x 816 mm
<p>Mittelschränke   central units   armoires moyennes   middenkasten</p>  300°/600 x 1600 mm	 300°/600 x 1296 mm	 300°/600 x 656 mm	 300°/600 x 816 mm
<p>Highboards   highboards   highboards   highboards</p>  300°/600 x 640 mm	 300°/600 x 496 mm		

- ° Schränke auch in 400 mm Breite erhältlich.
- ° Cabinets also available with a width of 400 mm.
- ° Les armoires sont également disponibles avec une largeur de 400 mm.
- ° Kasten ook verkrijgbaar in 400 mm breedte.

**i** \* auch mit LED-Beleuchtung erhältlich  
 \* also available with LED lighting  
 \* aussi disponible avec éclairage LED  
 \* ook mogelijk met LED verlichting

- |  |  |
|--|--|
| <ul style="list-style-type: none"> <li>- Auszug aus dem Typenplan</li> <li>- Die Artikelnummern der Ergänzungsschränke entnehmen Sie aus den Typenlisten.</li> <li>- Türen · Auszüge · Schubkästen mit Dämpfung</li> <li>- Part numbers of the available options</li> <li>- Please consult the full range available for the article numbers of the add-on cabinets.</li> <li>- Doors · pull out units · drawers with buffered closing</li> </ul> | <ul style="list-style-type: none"> <li>- Extrait du plan type</li> <li>- Les références des meubles complémentaires sont présentes dans notre liste d'articles.</li> <li>- Portes · tiroirs · coulissants avec amortisseur</li> <li>- Getoonde kasten zijn een selectie uit de kast mogelijkheden</li> <li>- De bestelcodes van de losse kasten kunt vindt u bij de losse elementen.</li> <li>- Deuren en lades met softclose</li> </ul> |
|--|--|





fresh

Geradliniger Klassiker mit vielseitigen Kombinationsmöglichkeiten  
 Straightforward classic with versatile combination possibilities  
 Un classique simple offrant de nombreuses possibilités de combinaisons  
 Strakke vorm met veel kombinatiemogelijkheden







Nr. 294  
Stangengriff chrom  
handle chrome  
poignée barre chrome  
stangengreep chrom



Nr. 321  
Stangengriff chrom  
handle chrome  
poignée barre chrome  
stangengreep chrom





Frontdekore | Front finishes | Façades | Front kleuren

<b>697</b> Betongrün concrete green vert béton betongroen	<b>777</b> Cosmos Grey matt cosmos grey matt cosmos grey mat cosmos grey mat	<b>891</b> Quarzgrau matt quarz grey matt gris quartz mat kwartsgrijs mat	<b>893</b> Titangrau matt titanium grey matt titane gris mat titanium grijs mat	<b>793</b> Edelweiß matt noble white matt blanc pur mat edelwit mat	<b>722</b> Polarweiß hgl. polarwhite hgl. blanc polaire haute brillance hoogglans wit	<b>686</b> Anthrazit hgl. anthracite hgl. anthracite haute brillance hoogglans antraciet	
<b>639</b> Eiche Schwarz oak black chêne noir eiken zwart	<b>670</b> Halifax Eiche halifax oak chêne Halifax halifax eiken	<b>680</b> Charleston Eiche charleston oak chêne Charleston charleston eiken	<b>750</b> Cardiff Eiche cardiff oak chêne Cardiff cardiff eiken	<b>751</b> Cuneo Eiche Braun cuneo oak brown Cuneo imitation chêne marron cuneo eiken bruin	<b>771</b> Cuneo Eiche Natural cuneo oak natural Cuneo imitation chêne naturel cuneo eiken naturel	<b>785</b> Eiche Natur Nachbildung natural oak effect imitation chêne naturel eiken naturel folie	<b>794</b> Eiche Sand sand oak chêne sable zand eiken

Korpusedekore | Carcass colours | Corps de meuble | Corpus kleuren

<b>197</b> Betongrün concrete green vert béton betongroen	<b>177</b> Cosmos Grey matt cosmos grey matt cosmos grey mat cosmos grey mat	<b>191</b> Quarzgrau matt quarz grey matt gris quartz mat kwartsgrijs mat	<b>193</b> Titangrau matt titanium grey matt titane gris mat titanium grijs mat	<b>111</b> Weiß matt white matt blanc mat wit mat	<b>161</b> Weiß hgl. white hgl. blanc haute brillance hoogglans wit	<b>121</b> Anthrazit hgl. anthracite hgl. anthracite haute brillance hoogglans antraciet	
<b>139</b> Eiche Schwarz oak black chêne noir eiken zwart	<b>170</b> Halifax Eiche halifax oak chêne Halifax halifax eiken	<b>180</b> Charleston Eiche charleston oak chêne Charleston charleston eiken	<b>150</b> Cardiff Eiche cardiff oak chêne Cardiff cardiff eiken	<b>151</b> Cuneo Eiche Braun cuneo oak brown Cuneo imitation chêne marron cuneo eiken bruin	<b>171</b> Cuneo Eiche Natural cuneo oak natural Cuneo imitation chêne naturel cuneo eiken naturel	<b>185</b> Eiche Natur Nachbildung natural oak effect imitation chêne naturel eiken naturel folie	<b>194</b> Eiche Sand sand oak chêne sable zand eiken

Planungsbeispiele  
Planning examples | Exemples de composition | Sets

FRM-0170-2 706 mm

FRM-0170-3 706 mm

FRM-0170-4 706 mm

FRM-0170-5 706 mm

FRM-0110-2 1006 mm

FRM-0110-3 1006 mm

FRM-0110-4 1006 mm

FRM-0110-5 1006 mm

FRM-0112-2 1206 mm

FRM-0112-3 1206 mm

FRM-0112-D4 1206 mm

FRM-0112-D5 1206 mm

Alternativ Flächenspiegel in 700 / 1000 / 1200 mm Breite erhältlich.  
Alternative mirrors available in widths 700 / 1000 / 1200 mm.  
Alternative: miroir disponible en 700 / 1000 / 1200 mm de largeur  
Alternatief zijn spiegels in 700 / 1000 / 1200 breedte verkrijgbaar.

Ergänzungsschränke | Additional cabinets | Meubles complémentaires | Losse kasten

Hochschränke | tall units | colonnes | hoge kasten

Mittelschränke | central units | armoires moyennes | middenkasten

Highboards | highboards | highboards | highboards

Ober-/Unterschränke | wall/base units | éléments suspendus/bas | boven-/onderkasten

300°/600 x 1600 mm

300°/600 x 1136 mm

300°/600 x 656 mm

300°/600 x 816 mm

300°/600 x 640 mm

300°/600 x 496 mm

Breite x Höhe in mm  
Width x height in mm  
Largeur x hauteur in mm  
Breedte x hoogte in mm

° Schränke auch in 400 mm Breite erhältlich.  
° Cabinets also available with a width of 400 mm.  
° Les armoires sont également disponibles avec une largeur de 400 mm.  
° Kasten ook verkrijgbaar in 400 mm breedte.

**i** Abbildungen mit Mineralguss-Waschtisch, auch in Glas oder Keramik erhältlich.  
Technical drawing with cast mineral washbasin, also available in glass or ceramic.  
Les exemples de composition avec plan vasque en matériau de synthèse sont également disponible en verre ou en céramique.  
Afbeeldingen zijn met minerale wastafels, glazen en keramische wastafels zijn ook mogelijk.

- Auszug aus dem Typenplan
- Die Artikelnummern der Ergänzungsschränke entnehmen Sie aus den Typenlisten.
- Türen · Auszüge · Schubkästen mit Dämpfung
- Part numbers of the available options
- Please consult the full range available for the article numbers of the add-on cabinets.
- Doors · pull out units · drawers with buffered closing

- Extrait du plan type
- Les références des meubles complémentaires sont présentes dans notre liste d'articles.
- Portes · tiroirs · coulissants avec amortisseur
- Getoonde kasten zijn een selectie uit de kast mogelijkheden
- De bestelcodes van de losse kasten kunt vindt u bij de losse elementen.
- Deuren en lades met softclose





**puris**  
BAD • MÖBEL



Follow us on  
**Instagram**  
@puris\_bad

Abbildungen und Angaben sind unverbindlich. Technische Änderungen vorbehalten.  
Illustrations and specifications are without obligation. Technical modifications reserved.  
Reproductions et données techniques sans engagement de notre part. Sous réserve de modifications techniques.  
Afbeeldingen en specificaties kunnen afwijken. Technische wijzigingen voorbehouden.



[www.puris.de](http://www.puris.de)

