

2023/2024

**puris**  
BAD · MÖBEL

CIMANO · CIPURO · ROUNDS · MODERN LIFE · NEW XPRESSION · ASPEKT · KAO LINE · FINE LINE · SWING · CRESCENDO · STAR LINE · CLASSIC LINE · COOL LINE



c!mano





c!mano





c!mano



WASCHTISCHE // WASHBASINS // PLAN VASQUE // WASTAFELS



Keramik-Waschtisch „Q!flat“, weiß / weiß matt  
 ceramic washbasin „Q!flat“, white / white matt  
 plan vasque céramique «Q!flat», blanc / blanc mat  
 keramische wastafel „Q!flat“, wit / wit mat

GRIFFVARIANTEN // HANDLE VERSIONS // VARIANTES DE POIGNÉES // GREEP

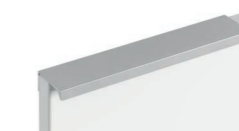

Griffleiste - chrom / alu matt / schwarz matt  
 strip handle - chrome / alu matt / black matt  
 profilé poignée - chrome / alu mat / noir mat  
 greeplijst - chroom / alu mat / zwart mat

Stangengriff chrom / schwarz matt  
 handle chrome / black matt  
 poignée barre noir mat / chrome  
 stangengreep zwart mat / chroom

FRONTDEKORE // KORPUSDEKORE // FRONT FINISHES / CARCASS COLOURS // FAÇADES / CORPS DE MEUBLE // FRONT KLEUREN / CORPUS KLEUREN

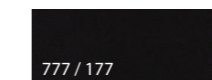

777 / 177  
 Cosmos Grey matt  
 cosmos grey matt  
 cosmos grey mat  
 cosmos grey mat

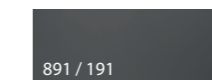

891 / 191  
 Quarzgrau matt  
 quartz grey matt  
 gris quartz mat  
 kwartsgrijs mat

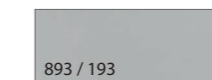

893 / 193  
 Titangrau matt  
 titanium grey matt  
 titane gris mat  
 titanium grijs mat

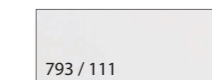

793 / 111  
 Edelweiß matt / Weiß matt  
 noble white matt / white matt  
 blanc pur mat / blanc mat  
 edelwit mat / wit mat

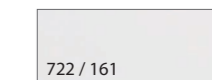

722 / 161  
 Polarweiß hgl. / Weiß hgl.  
 polarwhite hgl. / white hgl.  
 blanc polaire haute brillance /  
 blanc haute brillance  
 hoogglans wit

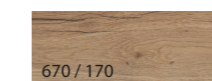

670 / 170  
 Halifax Eiche  
 halifax oak  
 chêne Halifax  
 halifax eiken

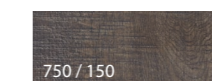

750 / 150  
 Cardiff Eiche  
 cardiff oak  
 chêne Cardiff  
 cardiff eiken

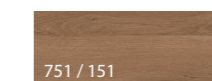

751 / 151  
 Cuneo Eiche Braun  
 cuneo oak brown  
 Cuneo imitation chêne marron  
 cuneo eiken bruin



771 / 171  
 Cuneo Eiche Natural  
 cuneo oak natural  
 Cuneo imitation chêne naturel  
 cuneo eiken naturel

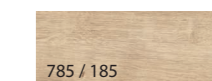

785 / 185  
 Eiche Natur Nachbildung  
 natural oak effect  
 imitation chêne naturel  
 eiken naturel folie

Badmöbelkombinationen in 620, 920, 1220 und 1520 mm Breite erhältlich. 1520 mm Breite ausschließlich als Doppelwaschtisch möglich.  
 Bathroom furniture combinations available in widths 620, 920, 1220 and 1520 mm. Width 1520 mm, only available as double washbasin.  
 Compositions de salle de bains disponibles en largeur de 620, 920, 1220 et 1520 mm. Largeur de 1520 mm uniquement comme plan double vasque.  
 Badkamermeubel combinaties in 620, 920, 1220 en 1520 mm breed verkrijgbaar. 1520 mm breed alleen verkrijgbaar als dubbele wastafel.



c!puro





c!puro



WASCHTISCHE // WASHBASINS // PLAN VASQUE // WASTAFELS



Keramik-Waschtisch „Qfflat“, weiß / weiß matt  
 ceramic washbasin “Qfflat”, white / white matt  
 plan vasque céramique «Qfflat», blanc / blanc mat  
 keramische wastafel “Qfflat”, wit / wit mat

GRIFFVARIANTEN // HANDLE VERSIONS // VARIANTES DE POIGNÉES // GREEP



Griffleiste - weiß matt / alu matt / schwarz matt  
 strip handle - white matt / alu matt / black matt  
 profilé poignée - blanc mat / alu mat / noir mat  
 greeplijst - wit mat / alu mat / zwart mat

FRONTDEKORE / KORPUSDEKORE // FRONT FINISHES / CARCASS COLOURS // FAÇADES / CORPS DE MEUBLE // FRONT KLEUREN / CORPUS KLEUREN

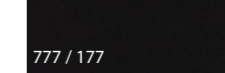

777 / 177  
 Cosmos Grey matt  
 cosmos grey matt  
 cosmos grey mat  
 cosmos grey mat

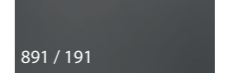

891 / 191  
 Quarzgrau matt  
 quartz grey matt  
 gris quartz mat  
 kwartsgrijs mat

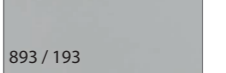

893 / 193  
 Titangrau matt  
 titanium grey matt  
 titane gris mat  
 titanium grijs mat

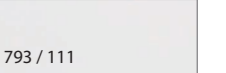

793 / 111  
 Edelweiß matt / Weiß matt  
 noble white matt / white matt  
 blanc pur mat / blanc mat  
 edelwit mat / wit mat

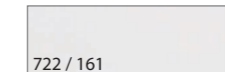

722 / 161  
 Polarweiß hgl. / Weiß hgl.  
 polarwhite hgl. / white hgl.  
 blanc polaire haute brillance /  
 blanc haute brillance  
 hoogglans wit

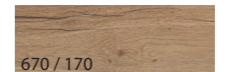

670 / 170  
 Halifax Eiche  
 cardiff oak  
 chêne Halifax  
 halifax eiken

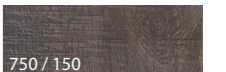

750 / 150  
 Cardiff Eiche  
 cardiff oak  
 chêne Cardiff  
 cardiff eiken



751 / 151  
 Cuneo Eiche Braun  
 cuneo oak brown  
 Cuneo imitation chêne marron  
 cuneo eiken bruin



771 / 171  
 Cuneo Eiche Natural  
 cuneo oak natural  
 Cuneo imitation chêne naturel  
 cuneo eiken naturel

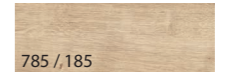

785 / 185  
 Eiche Natur Nachbildung  
 natural oak effect  
 imitation chêne naturel  
 eiken naturel folie

Badmöbelkombinationen in 620, 920, 1220 und 1520 mm Breite erhältlich. 1520 mm Breite ausschließlich als Doppelwaschtisch möglich.  
 Bathroom furniture combinations available in widths 620, 920, 1220 and 1520 mm. Width 1520 mm, only available as double washbasin.  
 Compositions de salle de bains disponibles en largeur de 620, 920, 1220 et 1520 mm. Largeur de 1520 mm uniquement comme plan double vasque.  
 Badkamermeubel combinaties in 620, 920, 1220 en 1520 mm breed verkrijgbaar. 1520 mm breed alleen verkrijgbaar als dubbele wastafel.



# ROUNDS





# ROUNDS







# ROUNDS



## WASCHTISCHE // WASHBASINS // PLAN VASQUE // WASTAFELS



Glas-Waschtisch - optiwhite / optiwhite matt / schwarz matt  
 glass washbasin - optiwhite / optiwhite matt / black matt  
 plan vasque en verre - optiwhite / optiwhite mat / noir mat  
 glazen wastafel - optiwhite / optiwhite mat / zwart mat



## STONEPLUS®



STONEPLUS® Waschtisch, weiß  
 STONEPLUS® washbasin, white  
 STONEPLUS® plan vasque, blanc  
 STONEPLUS® wastafel, wit



„Málaga“ Keramik-Aufsatzwaschtisch, weiß  
 „Málaga“ ceramic top-mounted washbasin, white  
 «Málaga» vasque à poser en céramique, blanc  
 "Málaga" keramische opzetwastafel, wit

## GRIFFVARIANTEN // HANDLE VERSIONS // VARIANTES DE POIGNÉES // GREEP



Griffleiste - chrom / alu matt / schwarz matt  
 strip handle - chrome / alu matt / black matt  
 profilé poignée - chrome / alu mat / noir mat  
 greeplijst - chrom / alu mat / zwart mat

## FRONTDEKORE / KORPUSDEKORE // FRONT FINISHES / CARCASS COLOURS // FAÇADES / CORPS DE MEUBLE // FRONT KLEUREN / CORPUS KLEUREN

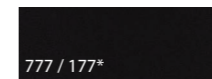

777 / 177\*  
 Cosmos Grey matt  
 cosmos grey matt  
 cosmos grey mat  
 cosmos grey mat

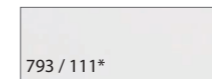

793 / 111\*  
 Edelweiß matt / Weiß matt  
 noble white matt / white matt  
 blanc pur mat / blanc mat  
 edelwit mat / wit mat

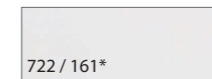

722 / 161\*  
 Polarweiß hgl. / Weiß hgl.  
 polarwhite hgl. / white hgl.  
 blanc polaire haute brillance /  
 blanc haute brillance  
 hoogglans wit

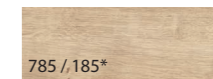

785 / 185\*  
 Eiche Natur Nachbildung  
 natural oak effect  
 imitation chêne naturel  
 eiken naturel folie

\* = Waschtischplattendekore / Abdeckplattendekore  
 \* = washbasin top colours / top cover colours  
 \* = coloris plan de toilette pour vasque à poser /  
 coloris de plateaux de recouvrement  
 \* = wastafelplaat kleuren / afdeklad kleuren



143  
 Schieferoptik  
 slate imitation  
 aspect ardoise  
 leisten look



174  
 Hunton Eiche  
 hunton oak  
 chêne Hunton  
 hunton eiken



170  
 Halifax Eiche  
 halifax oak  
 chêne Halifax  
 halifax eiken

Schieferoptik (143), Hunton Eiche (174) und Halifax Eiche (170)  
 nur Waschtischplatten- und Abdeckplattendekor.  
 slate imitation (143), Hunton oak (174) and halifax oak (170)  
 only washbasin plate and top cover colour.  
 Aspect ardoise (143), Chêne Hunton (174) et chêne Halifax (170)  
 seulement coloris plan de toilette pour vasque à poser et coloris  
 de plateaux de recouvrement.  
 Leisten look (143), Hunton eiken (174) en halifax eiken (170) al-  
 leen wastafelplaat en afdeklad kleur.

Badmöbelkombinationen in 632, 932, 1232 und 1432 mm Breite erhältlich. 1432 mm Breite ausschließlich als Doppelwaschtisch möglich. „Málaga“ Keramik-Aufsatzwaschtisch: 626, 926, 1226 und 1426 mm Breite  
 Bathroom furniture combinations available in widths 632, 932, 1232 and 1432 mm. Width 1432 mm, only as double washbasin. „Málaga“ ceramic top-mounted washbasin: width 626, 926, 1226 and 1426 mm  
 Compositions de salle de bains disponibles en largeur de 632, 932, 1232 et 1432 mm. Largeur de 1432 mm seulement comme plan double vasque. «Málaga» vasque à poser en céramique: 626, 926, 1226 et 1426 mm largeur  
 Badkamermeubelcombinaties in 632, 932, 1232 en 1432 mm breed verkrijgbaar. 1432 mm breed alleen als dubbele wastafel mogelijk. „Málaga“ keramische opzetwastafel: 626, 926, 1226 en 1426 mm breed

# Kollektion MODERN LIFE by Maja Prinzessin von Hohenzollern



## WASCHTISCHE // WASHBASINS // PLAN VASQUE // WASTAFELS



„Ideal Standard CONNECT AIR“  
Keramik-Aufsatzwaschtisch, weiß  
ceramic top-mounted washbasin, white  
vasque à poser en céramique, blanc  
keramische opzetwastafel, wit



„Málaga“ Keramik-Aufsatzwaschtisch, weiß  
„Málaga“ ceramic top-mounted washbasin, white  
«Málaga» vasque à poser en céramique, blanc  
„Málaga“ keramische opzetwastafel, wit

## GRIFFVARIANTEN // HANDLE VERSIONS // VARIANTES DE POIGNÉES // GREEP



Push to open  
push to open  
push to open  
push to open

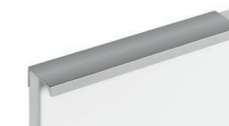

Griffleiste - chrom / alu matt / schwarz matt  
strip handle - chrome / alu matt / black matt  
profilé poignée - chrome / alu mat / noir mat  
greeplijst - chroom / alu mat / zwart mat



## FRONTDEKORE / KORPUSDEKORE // FRONT FINISHES / CARCASS COLOURS // FAÇADES / CORPS DE MEUBLE // FRONT KLEUREN / CORPUS KLEUREN

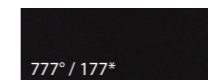

777° / 177\*  
Cosmos Grey matt  
cosmos grey matt  
cosmos grey mat  
cosmos grey mat

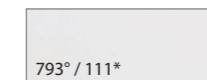

793° / 111\*  
Edelweiß matt / Weiß matt  
noble white matt / white matt  
blanc polaire haute brillance / blanc mat / blanc mat  
edelwit mat / wit mat

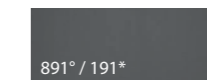

891° / 191\*  
Quarzgrau matt  
quarz grey matt  
gris quartz mat  
kwartsgrijs mat



893° / 193\*  
Titangrau matt  
titanium grey matt  
titane gris mat  
titanium grijs mat

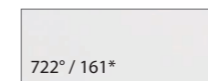

722° / 161\*  
Polarweiß hgl. / Weiß hgl.  
polarwhite hgl. / white hgl.  
blanc polaire haute brillance / blanc haute brillance  
hoogglans wit



785 / 185\*  
Eiche Natur Nachbildung  
natural oak effect  
imitation chêne naturel  
eiken naturel folie



670 / 170\*  
Halifax Eiche  
halifax oak  
chêne Halifax  
halifax eiken

Hunton Eiche (174) nur Waschtischplatten- und Abdeckplattendekor.  
Hunton oak (174) only washbasin plate and top cover colour.  
Chêne Hunton (174) seulement coloris plan de toilette pour vasque à poser et coloris de plateaux de recouvrement.  
Hunton eiken (174) alleen wastafelplaat en afdekblad kleur.



174  
Hunton Eiche  
hunton oak  
chêne Hunton  
hunton eiken

\* = Dekorstreifen  
\* = accent colours  
\* = décor avec mise en relief  
\* = accentdecor

\* = Waschtischplatten- / Abdeckplattendekore  
\* = washbasin top colours / top cover colours  
\* = coloris plan de toilette pour vasque à poser / coloris de plateaux de recouvrement  
\* = wastafelplaat kleuren / afdekblad kleuren

Badmöbelkombinationen in 666, 966, 1066, 1266, 1366 und 1566 mm Breite erhältlich. 1266 mm Breite auch als Doppelwaschtisch möglich.  
Bathroom furniture combinations available in widths 666, 966, 1066, 1266, 1366 and 1566 mm. Width 1266 mm, also available as double washbasin.  
Compositions de salle de bains disponibles en largeur de 666, 966, 1066, 1266, 1366 et 1566 mm. Largeur de 1266 mm également comme plan double vasque.  
Badkamermeubelcombinaties in 666, 966, 1066, 1266, 1366 en 1566 mm breed verkrijgbaar. 1266 mm breed ook als dubbele wastafel mogelijk.



# NEW XPRESSION



PLUS X AWARD

2022 | Ausgezeichnet für:

High Quality

Design

Bedienkomfort

Funktionalität

[www.plusaward.de](http://www.plusaward.de)





# NEW XPRESSION



## WASCHTISCHE // WASHBASINS // PLAN VASQUE // WASTAFELS



Glas-Waschtisch - optiwhite / optiwhite matt  
 glass washbasin - optiwhite / optiwhite matt  
 plan vasque en verre - optiwhite / optiwhite mat  
 glazen wastafel - optiwhite / optiwhite mat



STONEPLUS® Waschtisch, weiß  
 STONEPLUS® washbasin, white  
 STONEPLUS® plan vasque, blanc  
 STONEPLUS® wastafel, wit

STONEPLUS®

## GRIFFVARIANTEN // HANDLE VERSIONS // VARIANTES DE POIGNÉES // GREEP



Griffleiste - weiß matt / alu matt / schwarz matt  
 strip handle - white matt / alu matt / black matt  
 profilé poignée - blanc mat / alu mat / noir mat  
 greeplijst - wit mat / alu mat / zwart mat

## FRONTDEKORE / KORPUSDEKORE // FRONT FINISHES / CARCASS COLOURS // FAÇADES / CORPS DE MEUBLE // FRONT KLEUREN / CORPUS KLEUREN

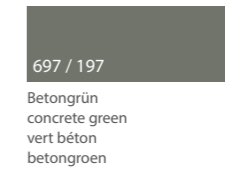

697 / 197  
 Betongrün  
 concrete green  
 vert béton  
 betongroen

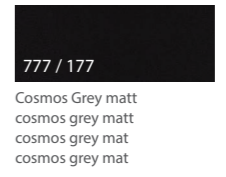

777 / 177  
 Cosmos Grey matt  
 cosmos grey matt  
 cosmos grey mat  
 cosmos grey mat

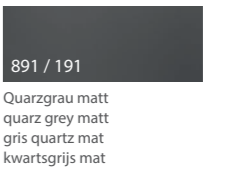

891 / 191  
 Quarzgrau matt  
 quartz grey matt  
 gris quartz mat  
 kwartzgrijs mat

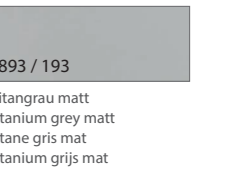

893 / 193  
 Titangrau matt  
 titanium grey matt  
 titane gris mat  
 titanium grijs mat

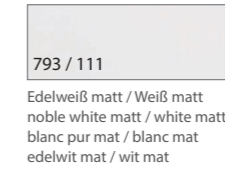

793 / 111  
 Edelweiß matt / Weiß matt  
 noble white matt / white matt  
 blanc pur mat / blanc mat  
 edelwit mat / wit mat

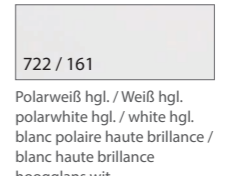

722 / 161  
 Polarweiß hgl. / Weiß hgl.  
 polarwhite hgl. / white hgl.  
 blanc polaire haute brillance /  
 blanc haute brillance  
 hoogglans wit

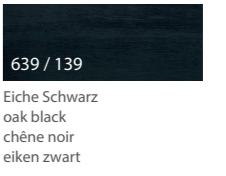

639 / 139  
 Eiche Schwarz  
 oak black  
 chêne noir  
 eiken zwart

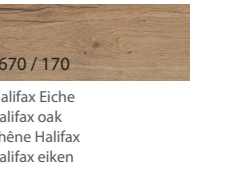

670 / 170  
 Halifax Eiche  
 halifax oak  
 chêne Halifax  
 halifax eiken

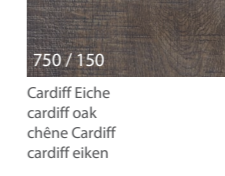

750 / 150  
 Cardiff Eiche  
 cardiff oak  
 chêne Cardiff  
 cardiff eiken

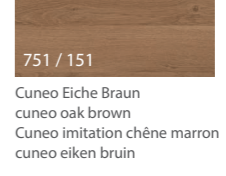

751 / 151  
 Cuneo Eiche Braun  
 cuneo oak brown  
 Cuneo imitation chêne marron  
 cuneo eiken bruin



771 / 171  
 Cuneo Eiche Natural  
 cuneo oak natural  
 Cuneo imitation chêne naturel  
 cuneo eiken naturel

Badmöbelkombinationen in 632, 932, 1232 und 1432 mm Breite erhältlich. 1432 mm Breite ausschließlich als Doppelwaschtisch möglich.  
 Bathroom furniture combinations available in widths 632, 932, 1232 and 1432 mm. Width 1432 mm, only available as double washbasin.  
 Compositions de salle de bains disponibles en largeur de 632, 932, 1232 et 1432 mm. Largeur de 1432 mm uniquement comme plan double vasque.  
 Badkamermeubelcombinaties in 632, 932, 1232 en 1432 mm breed verkrijgbaar. 1432 mm breed alleen verkrijgbaar als dubbele wastafel.



# ASPEKT



## WASCHTISCHE // WASHBASINS // PLAN VASQUE // WASTAFELS



„Squared“ Keramik-Aufsatzwaschtisch - Carbone matt / weiß  
 “Squared” ceramic top-mounted washbasin - carbon matt / white  
 «Squared» vasque à poser en céramique - carbone mat / blanc  
 “Squared” keramische opzetwastafel - carbon mat / wit



Mineralguss-Aufsatzwaschtisch, weiß  
 cast mineral top-mounted washbasin, white  
 vasque à poser en matériau de synthèse, blanc  
 minerale opzetwastafel, wit

## GRIFFVARIANTEN // HANDLE VERSIONS // VARIANTES DE POIGNÉES // GREEP

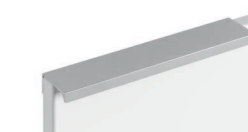

Griffleiste - chrom / alu matt / schwarz matt  
 strip handle - chrome / alu matt / black matt  
 profilé poignée - chrome / alu mat / noir mat  
 greeplijst - chroom / alu mat / zwart mat

## FRONTDEKORE / KORPUSDEKORE // FRONT FINISHES / CARCASS COLOURS // FAÇADES / CORPS DE MEUBLE // FRONT KLEUREN / CORPUS KLEUREN

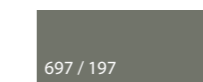

697 / 197

Betongrün  
 concrete green  
 vert béton  
 betongroen

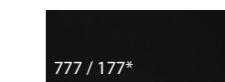

777 / 177\*

Cosmos Grey matt  
 cosmos grey matt  
 cosmos grey mat  
 cosmos grey mat

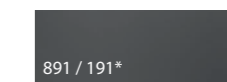

891 / 191\*

Quarzgrau matt  
 quartz grey matt  
 gris quartz mat  
 kwartsgrijs mat

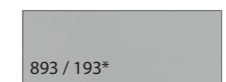

893 / 193\*

Titangrau matt  
 titanium grey matt  
 titane gris mat  
 titanium grijs mat

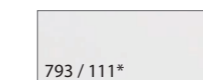

793 / 111\*

Edelweiß matt / Weiß matt  
 noble white matt / white matt  
 blanc pur mat / blanc mat  
 edelwit mat / wit mat

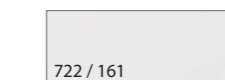

722 / 161

Polarweiß hgl. / Weiß hgl.  
 polarwhite hgl. / white hgl.  
 blanc polaire haute brillance /  
 blanc haute brillance  
 hoogglans wit

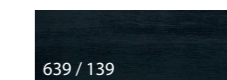

639 / 139

Eiche Schwarz  
 oak black  
 chêne noir  
 eiken zwart



794 / 194\*

Eiche Sand  
 sand oak  
 chêne sable  
 zand eiken

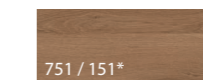

751 / 151\*

Cuneo Eiche Braun  
 cuneo oak brown  
 Cuneo imitation chêne marron  
 cuneo eiken bruin



771 / 171\*

Cuneo Eiche Natural  
 cuneo oak natural  
 Cuneo imitation chêne naturel  
 cuneo eiken naturel

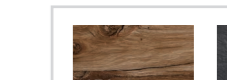

174

Hunton Eiche  
 hunton oak  
 chêne Hunton  
 hunton eiken

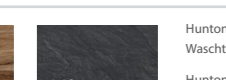

143

Schieferoptik  
 slate imitation  
 aspect ardoise  
 leisten look

Hunton Eiche (174) und Schieferoptik (143) nur Waschtischplatten- und Abdeckplattendekor.  
 Hunton oak (174) and slate imitation (143) only washbasin plate and top cover colour.  
 Chêne Hunton (174) et aspect ardoise (143) seulement coloris plan de toilette pour vasque à poser et coloris de plateaux de recouvrement.  
 Hunton eiken (174) en leiste look (143) alleen wastafelplaat en afdekblad kleur.

\* = Waschtischplattendekore / Abdeckplattendekore  
 \* = washbasin top colours / top cover colours  
 \* = coloris plan de toilette pour vasque à poser / coloris de plateaux de recouvrement  
 \* = wastafelplaat kleuren / afdekblad kleuren

Badmöbelkombinationen von 606 bis 1546 mm Breite erhältlich. Alle Waschtische erhältlich in verschiedenen Größen.  
 Bathroom furniture combinations available in widths from 606 to 1546 mm. All Washbasins are available in different sizes.  
 Compositions de salle de bains disponibles en largeur de 606 à 1546 mm. Toutes les vasques sont livrables en dimensions différentes.  
 Badkamermeubelcombinaties van 606 tot 1546 mm breed verkrijgbaar. Alle wastafels zijn verkrijgbaar in verschillende afmetingen.

# KAO LINE



## WASCHTISCHE // WASHBASINS // PLAN VASQUE // WASTAFELS

➤ Keramik-Waschtisch, weiß  
ceramic washbasin, white  
plan vasque céramique, blanc  
keramische wastafel, wit

## GRIFFVARIANTEN // HANDLE VERSIONS // VARIANTES DE POIGNÉES // GREEP



Griffleiste alu matt  
strip handle alu matt  
profilé poignée alu mat  
greflijst alu mat



Stangengriff chrom  
handle chrome  
poignée barre chrome  
stangengreep chroom



## FRONTDEKORE / KORPUSDEKORE // FRONT FINISHES / CARCASS COLOURS // FAÇADES / CORPS DE MEUBLE // FRONT KLEUREN / CORPUS KLEUREN

697 / 197

Betongrün  
concrete green  
vert béton  
betongroen

777 / 177

Cosmos Grey matt  
cosmos grey matt  
cosmos grey mat  
cosmos grey mat

793 / 111

Edelweiß matt / Weiß matt  
noble white matt / white matt  
blanc pur mat / blanc mat  
edelwit mat / wit mat

722 / 161

Polarweiß hgl. / Weiß hgl.  
polarwhite hgl. / white hgl.  
blanc polaire haute brillance /  
blanc haute brillance  
hoogglans wit

764 / 164

Steingrau matt  
stonegrey matt  
gris pierre mat  
steengrijs mat

891 / 191

Quarzgrau matt  
quartz grey matt  
gris quartz mat  
kwartsgrijs mat

893 / 193

Titangrau matt  
titanium grey matt  
titane gris mat  
titanium grijs mat

686 / 121

Anthrazit hgl.  
anthracite hgl.  
anthracite haute brillance  
hoogglans antraciet

639 / 139

Eiche Schwarz  
oak black  
chêne noir  
eiken zwart

670 / 170

Halifax Eiche  
halifax oak  
chêne Halifax  
halifax eiken

680 / 180

Charleston Eiche  
charleston oak  
chêne Charleston  
charleston eiken

750 / 150

Cardiff Eiche  
cardiff oak  
chêne Cardiff  
cardiff eiken

751 / 151

Cuneo Eiche Braun  
cuneo oak brown  
Cuneo imitation chêne marron  
cuneo eiken bruin

771 / 171

Cuneo Eiche Natural  
cuneo oak natural  
Cuneo imitation chêne naturel  
cuneo eiken naturel

785 / 185

Eiche Natur Nachbildung  
natural oak effect  
imitation chêne naturel  
eiken naturel folie

794 / 194

Eiche Sand  
sand oak  
chêne sable  
zand eiken



Badmöbelkombinationen in 660, 860, 960, 1060 und 1260 mm Breite erhältlich. 1260 mm Breite auch als Doppelwaschtisch möglich.  
Bathroom furniture combinations available in widths 660, 860, 960, 1060 and 1260 mm. Width 1260 mm also available as double washbasin.  
Compositions de salle de bains disponibles en largeur de 660, 860, 960, 1060 et 1260 mm. Largeur de 1260 mm également comme plan double vasque.  
Badkamermeubelcombinaties in 660, 860, 960, 1060 en 1260 mm breed verkrijgbaar. 1260 mm breed ook als dubbele wastafel mogelijk.



**FINE LINE**



WASCHTISCHE // WASHBASINS // PLAN VASQUE // WASTAFELS



Keramik-Waschtisch, weiß  
ceramic washbasin, white  
plan vasque céramique, blanc  
keramische wastafel, wit



STONEPLUS\* Waschtisch, weiß  
STONEPLUS\* washbasin, white  
STONEPLUS\* plan vasque, blanc  
STONEPLUS\* wastafel, wit

**STONEPLUS®**

GRIFFVARIANTEN // HANDLE VERSIONS // VARIANTES DE POIGNÉES // GREEP



Stangengriff chrom  
handle chrome  
poignée barre chrome  
stangengreep chrom



FRONTDEKORE / KORPUSDEKORE // FRONT FINISHES / CARCASS COLOURS // FAÇADES / CORPS DE MEUBLE // FRONT KLEUREN / CORPUS KLEUREN

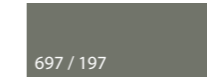

697 / 197  
Betongrün  
concrete green  
vert béton  
betongroen

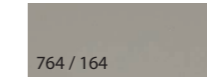

764 / 164  
Steingrau matt  
stonegrey matt  
gris pierre mat  
steengrijs mat

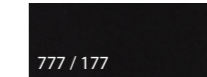

777 / 177  
Cosmos Grey matt  
cosmos grey matt  
cosmos grey mat  
cosmos grey mat

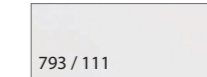

793 / 111  
Edelweiß matt / Weiß matt  
noble white matt / white matt  
blanc pur mat / blanc mat  
edelwit mat / wit mat

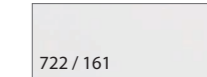

722 / 161  
Polarweiß hgl. / Weiß hgl.  
polarwhite hgl. / white hgl.  
blanc polaire haute brillance /  
blanc haute brillance  
hoogglans wit

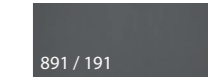

891 / 191  
Quarzgrau matt  
quartz grey matt  
gris quartz mat  
kwartsgrijs mat

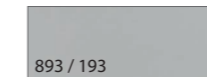

893 / 193  
Titangrau matt  
titanium grey matt  
titane gris mat  
titanium grijs mat

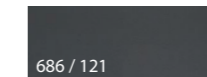

686 / 121  
Anthrazit hgl.  
anthracite hgl.  
anthracite haute brillance  
hoogglans antraciet

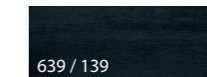

639 / 139  
Eiche Schwarz  
oak black  
chêne noir  
eiken zwart



670 / 170  
Halifax Eiche  
halifax oak  
chêne Halifax  
halifax eiken



680 / 180  
Charleston Eiche  
charleston oak  
chêne Charleston  
charleston eiken

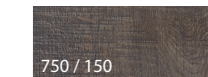

750 / 150  
Cardiff Eiche  
cardiff oak  
chêne Cardiff  
cardiff eiken

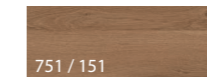

751 / 151  
Cuneo Eiche Braun  
cuneo oak brown  
Cuneo imitation chêne marron  
cuneo eiken bruin

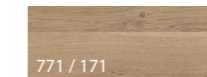

771 / 171  
Cuneo Eiche Natural  
cuneo oak natural  
Cuneo imitation chêne naturel  
cuneo eiken naturel



785 / 185  
Eiche Natur Nachbildung  
natural oak effect  
imitation chêne naturel  
eiken naturel folie



794 / 194  
Eiche Sand  
sand oak  
chêne sable  
zand eiken

Badmöbelkombinationen in 620, 920 und 1220 mm Breite erhältlich. Keramik-Waschtisch: 650, 950 und 1250 mm Breite  
Bathroom furniture combinations available in widths 620, 920 and 1220 mm. Ceramic washbasin: width 650, 950 and 1250 mm  
Compositions de salle de bains disponibles en largeur de 620, 920 et 1220 mm. Plan vasque céramique: 650, 950 et 1250 mm largeur  
Badkamermeubelcombinaties in 620, 920 en 1220 mm breed verkrijgbaar. Keramische wastafel: 650, 950 en 1250 mm breed







GRIFVARIANTEN // HANDLE VERSIONS // VARIANTES DE POIGNÉES // GREEP



Stangengriff chrom  
handle chrome  
poignée barre chrome  
stangengreep chrom



Stangengriff chrom + chrom matt  
handle chrome + chrome matt  
poignée barre chrome + chrome mat  
stangengreep chrom + chrom mat



Stangengriff chrom + chrom matt  
handle chrome + chrome matt  
poignée barre chrome + chrome mat  
stangengreep chrom + chrom mat



Stangengriff chrom + chrom matt  
handle chrome + chrome matt  
poignée barre chrome + chrome mat  
stangengreep chrom + chrom mat



Stangengriff schwarz matt  
handle black matt  
poignée barre noir mat  
stangengreep zwart mat

WASCHTISCHE // WASHBASINS // PLAN VASQUE // WASTAFELS



Keramik-Waschtisch, weiß  
ceramic washbasin, white  
plan vasque en céramique, blanc  
keramische wastafel, wit



Glas-Waschtisch - optiwhite / optiwhite matt  
glass washbasin - optiwhite / optiwhite matt  
plan vasque en verre - optiwhite / optiwhite mat  
glazen wastafel - optiwhite / optiwhite mat



STONEPLUS® Waschtisch, weiß  
STONEPLUS® washbasin, white  
STONEPLUS® plan vasque, blanc  
STONEPLUS® wastafel, wit



STONEPLUS®



FRONTDEKORE / KORPUSDEKORE / DEKORLINE ZWISCHENPLATTE // FRONT FINISHES / CARCASS COLOURS / DEKORLINE BOARD // FAÇADES / CORPS DE MEUBLE / LISÉRÉ DÉCORATIF // FRONT KLEUREN / CORPUS KLEUREN / DECOR BLAD

697 / 197

Betongrün  
concrete green  
vert béton  
betongroen

764 / 164

Steingrau matt  
stonegrey matt  
gris pierre mat  
steengrijs mat

777 / 177

Cosmos Grey matt  
cosmos grey matt  
cosmos grey mat  
cosmos grey mat

793 / 111

Edelweiß matt / Weiß matt  
noble white matt / white matt  
blanc pur mat / blanc mat  
edelwit mat / wit mat

722 / 161

Polarweiß hgl. / Weiß hgl.  
polarwhite hgl. / white hgl.  
blanc polaire haute brillance /  
blanc haute brillance  
hoogglans wit

891 / 191

Quarzgrau matt  
quartz grey matt  
gris quartz mat  
kwartsgrijs mat

893 / 193

Titangrau matt  
titanium grey matt  
titane gris mat  
titanium grijs mat

686 / 121

Anthrazit hgl.  
anthracite hgl.  
anthracite haute brillance  
hoogglans antraciet

639 / 139

Eiche Schwarz  
oak black  
chêne noir  
eiken zwart

670 / 170

Halifax Eiche  
halifax oak  
chêne Halifax  
halifax eiken

680 / 180

Charleston Eiche  
charleston oak  
chêne Charleston  
charleston eiken

750 / 150

Cardiff Eiche  
cardiff oak  
chêne Cardiff  
cardiff eiken

751 / 151

Cuneo Eiche Braun  
cuneo oak brown  
Cuneo imitation chêne marron  
cuneo eiken bruin

771 / 171

Cuneo Eiche Natural  
cuneo oak natural  
Cuneo imitation chêne naturel  
cuneo eiken naturel

785 / 185

Eiche Natur Nachbildung  
natural oak effect  
imitation chêne naturel  
eiken naturel folie

794 / 194

Eiche Sand  
sand oak  
chêne sable  
zand eiken

129

Chrom  
chrome  
chromé  
chrom

144

Schwarz  
black  
noir  
zwart

Chrom (129) und Schwarz (144) nur Dekorline Zwischenplatte.  
chrome (129) and black (144) only Dekorline board.  
chromé (129) et noir (144) seulement Liséré décoratif.  
chrom (129) en zwart (144) alleen Decor blad.



Badmöbelkombinationen in 620, 920 und 1220 mm Breite erhältlich. 1220 mm Breite auch als Doppelwaschtisch möglich.  
Bathroom furniture combinations available in widths 620, 920 and 1220 mm. Width 1220 mm also available as double washbasin.  
Compositions de salle de bains disponibles en largeur de 620, 920 et 1220 mm. Largeur de 1220 mm également comme plan double vasque.  
Badkamermeubelcombinaties in 620, 920 en 1220 mm breed verkrijgbaar. 1220 mm breed ook als dubbele wastafel mogelijk.



# SWING



## WASCHTISCHE // WASHBASINS // PLAN VASQUE // WASTAFELS



Glas-Waschtisch - optiwhite / optiwhite matt  
 glass washbasin - optiwhite / optiwhite matt  
 plan vasque en verre - optiwhite / optiwhite mat  
 glazen wastafel - optiwhite / optiwhite mat

evermite® Waschtisch, weiß  
 evermite® washbasin, white  
 evermite® plan vasque, blanc  
 evermite® wastafel, wit

## GRIFFVARIANTEN // HANDLE VERSIONS // VARIANTES DE POIGNÉES // GREEP



Stangengriff chrom  
 handle chrome  
 poignée barre chrome  
 stangengreep chrom

## FRONTDEKORE / KORPUSDEKORE // FRONT FINISHES / CARCASS COLOURS // FAÇADES / CORPS DE MEUBLE // FRONT KLEUREN / CORPUS KLEUREN

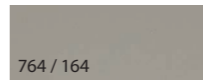

764 / 164  
 Steingrau matt  
 stonegrey matt  
 gris pierre mat  
 steengrijs mat

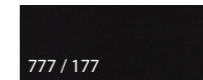

777 / 177  
 Cosmos Grey matt  
 cosmos grey matt  
 cosmos grey mat  
 cosmos grey mat

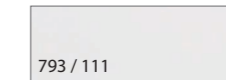

793 / 111  
 Edelweiß matt / Weiß matt  
 noble white matt / white matt  
 blanc pur mat / blanc mat  
 edelwit mat / wit mat

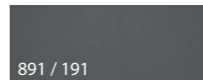

891 / 191  
 Quarzgrau matt  
 quarz grey matt  
 gris quartz mat  
 kwartsgrijs mat

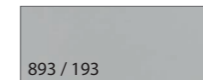

893 / 193  
 Titangrau matt  
 titanium grey matt  
 titane gris mat  
 titanium grijs mat

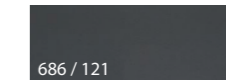

686 / 121  
 Anthrazit hgl.  
 anthracite hgl.  
 anthracite haute brillance  
 hoogglans antraciet

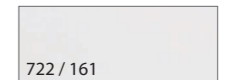

722 / 161  
 Polarweiß hgl. / Weiß hgl.  
 polarwhite hgl. / white hgl.  
 blanc polaire haute brillance /  
 blanc haute brillance  
 hoogglans wit



680 / 180  
 Charleston Eiche  
 charleston oak  
 chêne Charleston  
 charleston eiken

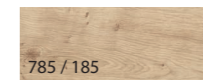

785 / 185  
 Eiche Natur Nachbildung  
 natural oak effect  
 imitation chêne naturel  
 eiken naturel folie



794 / 194  
 Eiche Sand  
 sand oak  
 chêne sable  
 zand eiken

Badmöbelkombinationen in 906, 1206, 1406 und 1806 mm Breite erhältlich. 1806 (1812) mm Breite ausschließlich als Doppelwaschtisch möglich. Glas-Waschtisch: 912, 1212, 1412 und 1812 mm Breite  
 Bathroom furniture combinations available in widths 906, 1206, 1406 and 1806 mm. Width 1806 (1812) mm, only as double washbasin. Glass washbasin: width 912, 1212, 1412 and 1812 mm  
 Compositions de salle de bains disponibles en largeur de 906, 1206, 1406 et 1806 mm. Largeur de 1806 (1812) mm seulement comme plan double vasque. Plan vasque en verre: 912, 1212, 1412 et 1812 mm largeur  
 Badkamermeubelcombinaties in 906, 1206, 1406 en 1806 mm breed verkrijgbaar. 1806 (1812) mm breed alleen als dubbele wastafel mogelijk. Glazen wastafel: 912, 1212, 1412 en 1812 mm breed



# STAR LINE



## WASCHTISCHE // WASHBASINS // PLAN VASQUE // WASTAFELS

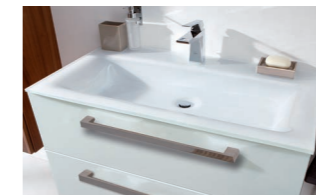

Glas-Waschtisch - optiwhite / optiwhite matt  
 glass washbasin - optiwhite / optiwhite matt  
 plan vasque en verre - optiwhite / optiwhite mat  
 glazen wastafel - optiwhite / optiwhite mat

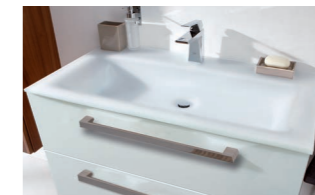

## STONEPLUS®



STONEPLUS® Waschtisch, weiß  
 STONEPLUS® washbasin, white  
 STONEPLUS® plan vasque, blanc  
 STONEPLUS® wastafel, wit

## evermite®



evermite® Waschtisch, weiß  
 evermite® washbasin, white  
 evermite® plan vasque, blanc  
 evermite® wastafel, wit

## GRIFFVARIANTEN // HANDLE VERSIONS // VARIANTES DE POIGNÉES // GREEP

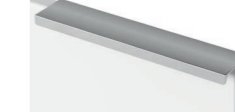

Stangengriff - chrom (schmal) / chrom (dick)  
 handle - chrome (narrow) / chrome (expanded)  
 poignée barre - chrome (étroite) / chrome (large)  
 stangengreep - chroom (smal) / chroom (breed)

Griffeiste - chrom / alu matt / schwarz matt  
 strip handle - chrome / alu matt / black matt  
 profilé poignée - chrome / alu mat / noir mat  
 greeplijst - chroom / alu mat / zwart mat



## FRONTDEKORE / KORPUSDEKORE // FRONT FINISHES / CARCASS COLOURS // FAÇADES / CORPS DE MEUBLE // FRONT KLEUREN / CORPUS KLEUREN

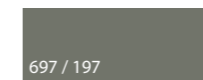

697 / 197

Betongrün  
 concrete green  
 vert béton  
 betongroen

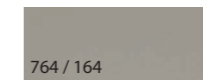

764 / 164

Steingrau matt  
 stonегrey matt  
 gris pierre mat  
 steengrijs mat

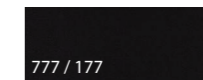

777 / 177

Cosmos Grey matt  
 cosmos grey matt  
 cosmos grey mat  
 cosmos grey mat

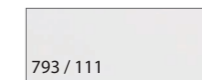

793 / 111

Edelweiß matt / Weiß matt  
 noble white matt / white matt  
 blanc pur mat / blanc mat  
 edelwit mat / wit mat

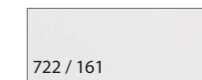

722 / 161

Polarweiß hgl. / Weiß hgl.  
 polarwhite hgl. / white hgl.  
 blanc polaire haute brillance /  
 blanc haute brillance  
 hoogglans wit

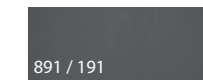

891 / 191

Quarzgrau matt  
 quartz grey matt  
 gris quartz mat  
 kwartzgrijs mat

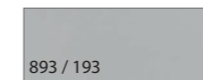

893 / 193

Titangrau matt  
 titanium grey matt  
 titane gris mat  
 titanium grijs mat

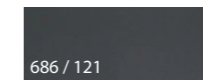

686 / 121

Anthrazit hgl.  
 anthracite hgl.  
 anthracite haute brillance  
 hoogglans antraciet

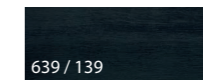

639 / 139

Eiche Schwarz  
 oak black  
 chêne noir  
 eiken zwart



670 / 170

Halifax Eiche  
 halifax oak  
 chêne Halifax  
 halifax eiken



680 / 180

Charleston Eiche  
 charleston oak  
 chêne Charleston  
 charleston eiken



750 / 150

Cardiff Eiche  
 cardiff oak  
 chêne Cardiff  
 cardiff eiken

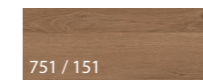

751 / 151

Cuneo Eiche Braun  
 cuneo oak brown  
 Cuneo imitation chêne marron  
 cuneo eiken bruin



771 / 171

Cuneo Eiche Natural  
 cuneo oak natural  
 Cuneo imitation chêne naturel  
 cuneo eiken naturel



785 / 185

Eiche Natur Nachbildung  
 natural oak effect  
 imitation chêne naturel  
 eiken naturel folie



794 / 194

Eiche Sand  
 sand oak  
 chêne sable  
 zand eiken



Badmöbelkombinationen in 906, 1206, 1406 und 1606 mm Breite erhältlich. 1206 und 1406 mm Breite auch als Doppelwaschtisch möglich. 1606 mm Breite ausschließlich als Doppelwaschtisch möglich.  
 Bathroom furniture combinations available in widths 906, 1206, 1406 and 1606 mm. Width 1206 and 1406 mm also available as double washbasin. Width 1606 mm only as double washbasin.  
 Compositions de salle de bains disponibles en largeur de 906, 1206, 1406 et 1606 mm. Largeur de 1206 et 1406 mm également comme plan double vasque. Largeur de 1606 mm seulement comme plan double vasque.  
 Badkamermeubelcombinaties in 906, 1206, 1406 en 1606 mm breed verkrijgbaar. 1206 en 1406 mm breed ook leverbaar met 2 kraangaten of als dubbele wastafel. 1606 mm breed alleen leverbaar met 2 kraangaten of als dubbele wastafel.



# CRESCENDO

## WASCHTISCHE // WASHBASINS // PLAN VASQUE // WASTAFELS



Glas-Waschtisch - optiwhite / optiwhite matt  
 glass washbasin - optiwhite / optiwhite matt  
 plan vasque en verre - optiwhite / optiwhite mat  
 glazen wastafel - optiwhite / optiwhite mat



evermite®



evermite® Waschtisch, weiß  
 evermite® washbasin, white  
 evermite® plan vasque, blanc  
 evermite® wastafel, wit

## GRIFFVARIANTEN // HANDLE VERSIONS // VARIANTES DE POIGNÉES // GREEP



Stangengriff chrom  
 handle chrome  
 poignée barre chrome  
 stangengreep chrom

## FRONTDEKORE / KORPUSDEKORE // FRONT FINISHES / CARCASS COLOURS // FAÇADES / CORPS DE MEUBLE // FRONT KLEUREN / CORPUS KLEUREN

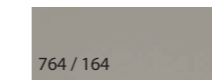

764 / 164  
 Steingrau matt  
 stonegrey matt  
 gris pierre mat  
 steengrijs mat

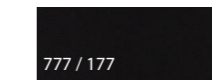

777 / 177  
 Cosmos Grey matt  
 cosmos grey matt  
 cosmos grey mat  
 cosmos grey mat

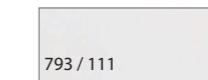

793 / 111  
 Edelweiß matt / Weiß matt  
 noble white matt / white matt  
 blanc pur mat / blanc mat  
 edelwit mat / wit mat

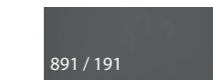

891 / 191  
 Quarzgrau matt  
 quartz grey matt  
 gris quartz mat  
 kwartsgrijs mat

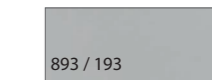

893 / 193  
 Titangrau matt  
 titanium grey matt  
 titane gris mat  
 titanium grijs mat

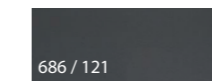

686 / 121  
 Anthrazit hgl.  
 anthracite hgl.  
 anthracite haute brillance  
 hoogglans antraciet

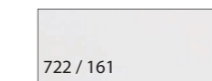

722 / 161  
 Polarweiß hgl. / Weiß hgl.  
 polarwhite hgl. / white hgl.  
 blanc polaire haute brillance / blanc haute brillance  
 hoogglans wit



680 / 180  
 Charleston Eiche  
 charleston oak  
 chêne Charleston  
 charleston eiken

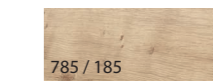

785 / 185  
 Eiche Natur Nachbildung  
 natural oak effect  
 imitation chêne naturel  
 eiken naturel folie



794 / 194  
 Eiche Sand  
 sand oak  
 chêne sable  
 zand eiken



Badmöbelkombinationen in 906, 1206 und 1406 mm Breite erhältlich.  
 Bathroom furniture combinations available in widths 906, 1206 and 1406 mm.  
 Compositions de salle de bains disponibles en largeur de 906, 1206 et 1406 mm.  
 Badkamermeubelcombinaties in 906, 1206 en 1406 mm breed verkrijgbaar.



# CLASSIC LINE



## WASCHTISCHE // WASHBASINS // PLAN VASQUE // WASTAFELS



Glas-Waschtisch - optiwhite / optiwhite matt  
 glass washbasin - optiwhite / optiwhite matt  
 plan vasque en verre - optiwhite / optiwhite mat  
 glazen wastafel - optiwhite / optiwhite mat



evermite® Waschtisch, weiß  
 evermite® washbasin, white  
 evermite® plan vasque, blanc  
 evermite® wastafel, wit

## GRIFFVARIANTEN // HANDLE VERSIONS // VARIANTES DE POIGNÉES // GREEP



Stangengriff chrom  
 handle chrome  
 poignée barre chrome  
 stangengreep chrom

## FRONTDEKORE / KORPUSDEKORE // FRONT FINISHES / CARCASS COLOURS // FAÇADES / CORPS DE MEUBLE // FRONT KLEUREN / CORPUS KLEUREN

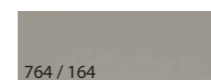

764 / 164  
 Steingrau matt  
 stonegrey matt  
 gris pierre mat  
 steengrijs mat

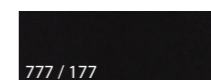

777 / 177  
 Cosmos Grey matt  
 cosmos grey matt  
 cosmos grey mat  
 cosmos grey mat

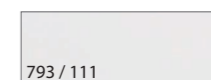

793 / 111  
 Edelweiß matt / Weiß matt  
 noble white matt / white matt  
 blanc pur mat / blanc mat  
 edelwit mat / wit mat

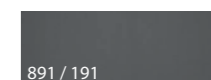

891 / 191  
 Quarzgrau matt  
 quartz grey matt  
 gris quartz mat  
 kwartsgrijs mat

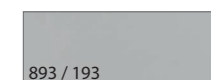

893 / 193  
 Titangrau matt  
 titanium grey matt  
 titane gris mat  
 titanium grijs mat

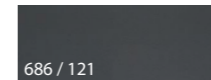

686 / 121  
 Anthrazit hgl.  
 anthracite hgl.  
 anthracite haute brillance  
 hoogglans antraciet

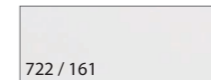

722 / 161  
 Polarweiß hgl. / Weiß hgl.  
 polarwhite hgl. / white hgl.  
 blanc polaire haute brillance /  
 blanc haute brillance  
 hoogglans wit

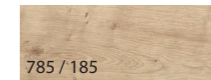

785 / 185  
 Eiche Natur Nachbildung  
 natural oak effect  
 imitation chêne naturel  
 eiken naturel folie



794 / 194  
 Eiche Sand  
 sand oak  
 chêne sable  
 zand eiken



680 / 180  
 Charleston Eiche  
 charleston oak  
 chêne Charleston  
 charleston eiken

Badmöbelkombinationen in 712, 912, 1212 und 1412 mm Breite erhältlich. 1412 mm Breite auch als Doppelwaschtisch möglich (ausgenommen Glas).  
 Bathroom furniture combinations available in widths 712, 912, 1212 and 1412 mm. Width 1412 mm also available as double washbasin (except glass).  
 Compositions de salle de bains disponibles en largeur de 712, 912, 1212 et 1412 mm. Largeur de 1412 mm également comme plan double vasque (sauf verre).  
 Badkamermeubelcombinaties in 712, 912, 1212 en 1412 mm breed verkrijgbaar. 1412 mm breed ook als dubbele wastafel mogelijk (behalve glas).



Weitere Ergänzungsschränke finden Sie in der Typenliste.  
You will find more add-on units in the type list.  
Autres armoires supplémentaires, voir catalogue.  
Meer bijpassende kasten vindt u in de typelijst.

LED-Emotionbeleuchtung (Farbwechselsteuerung)\*  
LED-emotion colour change system\*  
Éclairage des émotions LED (capteur pour changement de couleur)\*  
LED-erotieverlichting (kleurverwisselbaar)\*

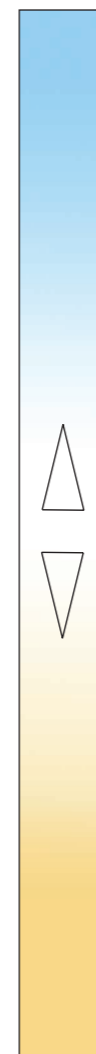

kaltweiß  
cool white  
blanc froid  
koudwit

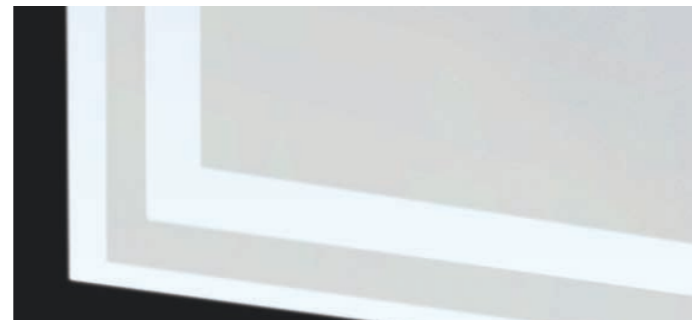

## LED

3 Helligkeitsstufen mit stufenlosem Farbwechsel  
3 brightness levels with continuous colour change  
3 niveaux de luminosité avec variation de couleur infiniment variable  
kleurverandering van 3 kleuren led die naadloos in elkaar overgaan

warmweiß  
warm white  
blanc chaud  
warmwit

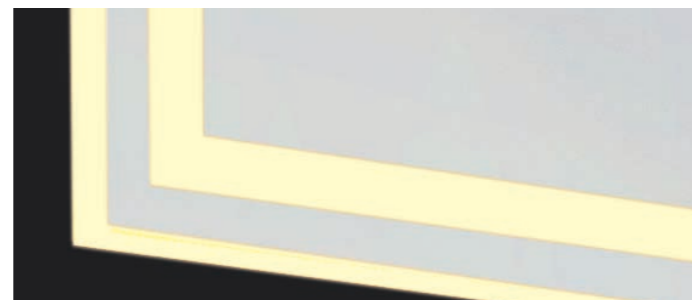

\*Gilt nur für bestimmte Artikel (siehe Typenliste).  
\*Valid only for some articles (see type list).  
\*Ne concerne que certains articles (voir liste des références).  
\*Geldt alleen voor bepaalde artikelen (zie de losse kasten).

## STONE-PLUS® evermite®

Der besondere Schutz für Ihren Waschtisch. Mineralguss neu erleben.  
Dank der einzigartigen Oberfläche.  
The special protection for your washbasin.  
Experience mineral cast in a new way, thanks to the unique surface.  
La protection spéciale pour votre plan de toilette. Expérimenter un nouveau matériau de synthèse. Grâce à sa surface unique.  
De bijzondere bescherming voor uw wastafel. Een minerale wastafel nieuw beleven.  
Dankzij het unieke oppervlak.

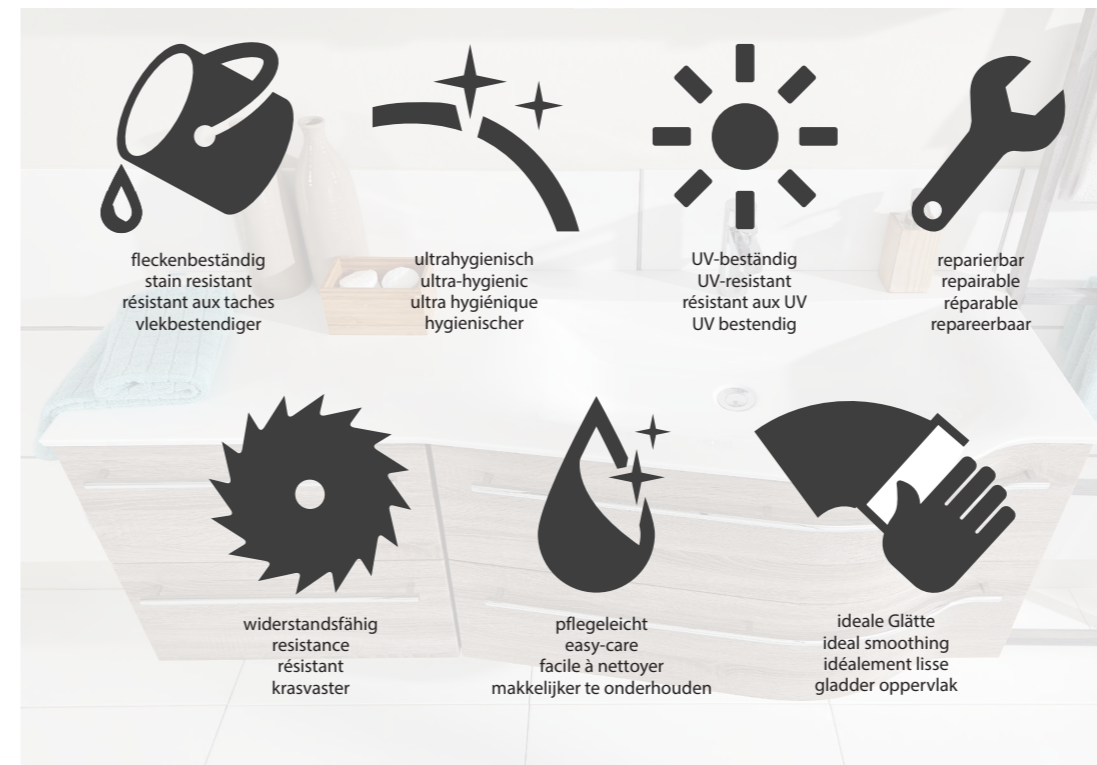

fleckenbeständig  
stain resistant  
résistant aux taches  
vlekbestendig

ultrahygienisch  
ultra-hygienic  
ultra hygiénique  
hygiënischer

UV-beständig  
UV-resistant  
résistant aux UV  
UV bestendig

reparierbar  
repairable  
réparable  
repareerbaar

widerstandsfähig  
resistance  
résistant  
krasvaster

pflegeleicht  
easy-care  
facile à nettoyer  
makkelijker te onderhouden

ideale Glätte  
ideal smoothing  
idéalement lisse  
gladder oppervlak

Bitte beachten Sie die Pflege- und Gebrauchshinweise.  
Please follow the care and use instructions.  
Veillez à respecter les conseils d'entretien et de nettoyage.  
Let u aub op de montage en gebruiksaanwijzingen.

Puris Badmöbel tragen das „Goldene M“. Das „Goldene M“ wird von der Deutschen Gütegemeinschaft Möbel e. V. (DGM) verliehen, die als RAL-Gütegemeinschaft die Aufgabe hat, die Qualität von Möbeln abzusichern und den Verbraucherschutz zu stärken. Möbelhersteller haben sehr hohe Anforderungen zu erfüllen, wenn sie das Siegel erhalten möchten. Die Kriterien zur Prüfung zählen zu den strengsten für Möbel in ganz Europa. Mehr Infos unter [www.dgm-moebel.de](http://www.dgm-moebel.de).

Puris bathroom furniture achieves the „Golden M“. The „Golden M“ is awarded by the Deutsche Gütegemeinschaft Möbel e. V. (DGM), which as the RAL Quality Association is tasked to ensure the quality of furniture that strengthens consumer protection. Furniture manufacturers have very high requirements to meet if they want to receive the seal. The criteria for testing are among the strictest for furniture in Europe. More information under [www.dgm-moebel.de](http://www.dgm-moebel.de).

Le „M d'or“ est décerné par l'Association allemande pour la qualité des meubles (DGM). (DGM), qui, en tant qu'association de qualité RAL, a pour mission de garantir la qualité des meubles et de renforcer la protection des consommateurs. Les fabricants de meubles doivent répondre à des exigences très élevées s'ils veulent recevoir le label. Les critères d'essai sont parmi les plus stricts pour les meubles en Europe. Plus d'informations sur [www.dgm-moebel.de](http://www.dgm-moebel.de).

De „Gouden M“ wordt toegekend door de Duitse Vereniging voor Meubelkwaliteit (DGM). (DGM), die als RAL-kwaliteitsvereniging tot taak heeft de kwaliteit van meubelen te waarborgen en de consumentenbescherming te versterken. Meubelfabrikanten moeten aan zeer hoge eisen voldoen, willen zij het keurmerk ontvangen. De criteria voor het testen behoren tot de strengste voor meubelen in Europa. Meer informatie op [www.dgm-moebel.de](http://www.dgm-moebel.de).



# c!mano & c!puro

Planungsbeispiele Spiegel  
 Planning proposals mirrors  
 Exemples de composition miroir et armoires de toilette miroir  
 Spiegels / Spiegelkasten

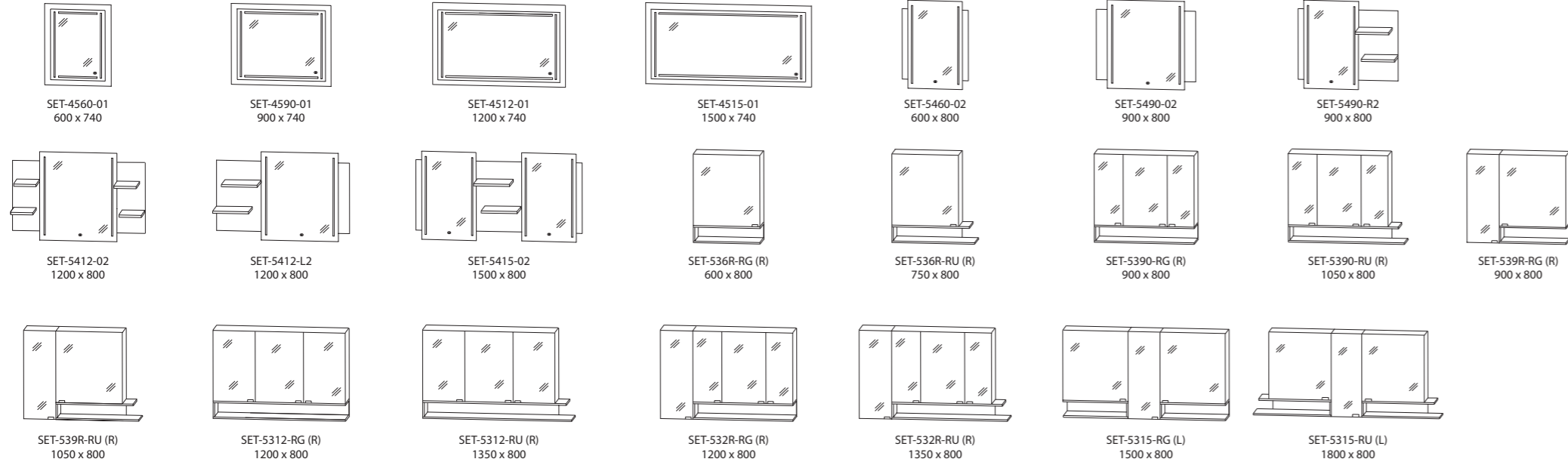

Planungsbeispiele Waschtische  
 Planning proposals washbasins  
 Exemples de composition plans vasque  
 Sets van wastafels en wastafelonderkasten

## c!mano

## c!puro

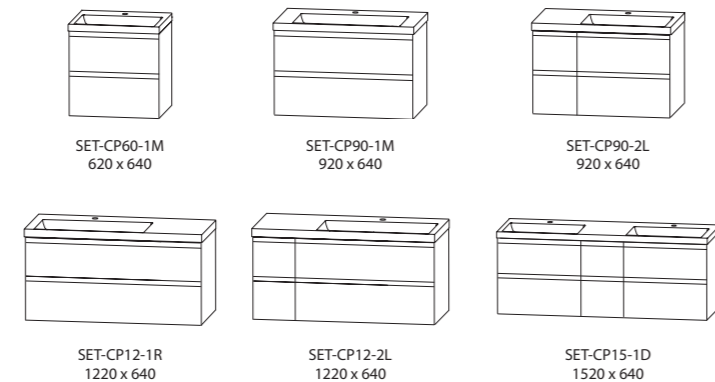
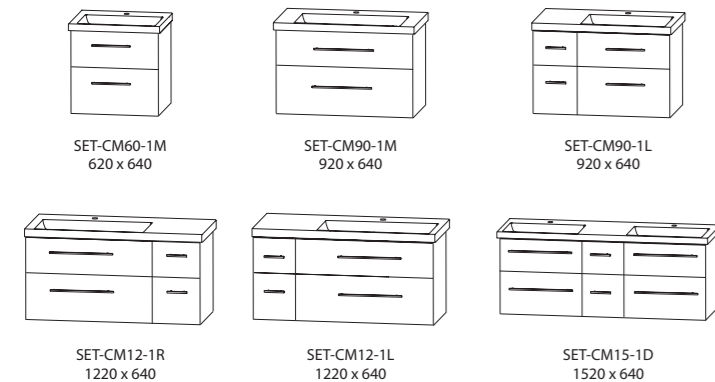

Ergänzungsschränke - Auszug aus dem Typenplan  
 Additional cabinets - part of the type list  
 Meubles complémentaires - extrait du plan type  
 Losse kasten - getoonde kasten zijn een selectie uit de kast mogelijkheden

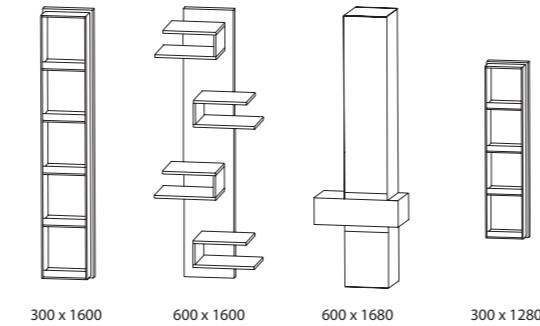

Türen / Auszüge / Schubkästen mit Dämpfung  
 Doors / pull out units / drawers with buffered closing  
 Portes / tiroirs / coulissants avec amortisseur  
 Deuren en lades met softclose

Breite x Höhe in mm  
 Width x height in mm  
 Largeur x hauteur en mm  
 Breedte x hoogte in mm

# ROUNDS

Planungsbeispiele  
 Planning examples  
 Exemples de composition  
 Sets

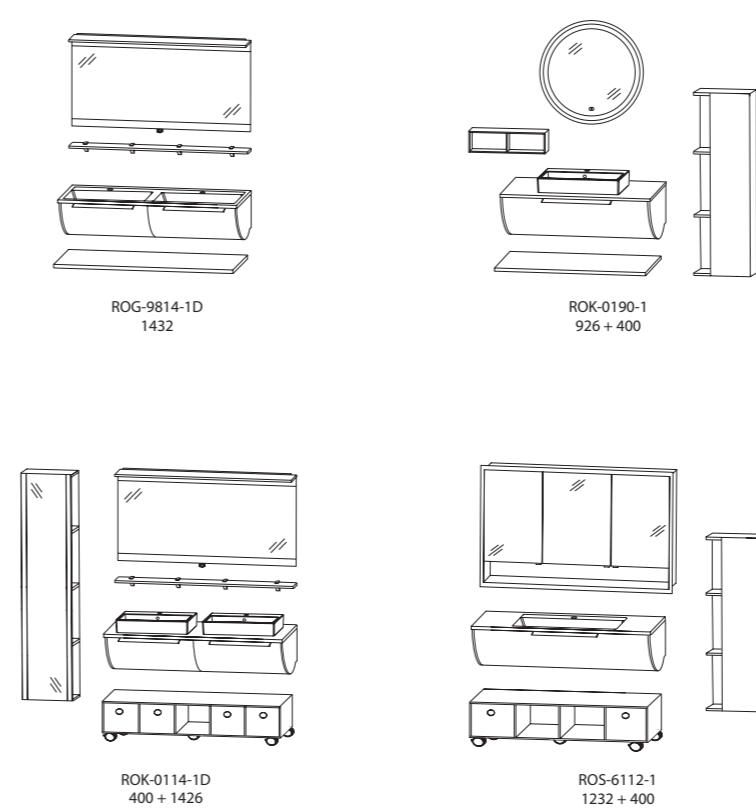

Türen / Auszüge / Schubkästen mit Dämpfung  
 Doors / pull out units / drawers with buffered closing  
 Portes / tiroirs / coulissants avec amortisseur  
 Deuren en lades met softclose

Breite in mm  
 Width in mm  
 Largeur en mm  
 Breedte in mm

# MODERN LIFE

Planungsbeispiele  
 Planning examples  
 Exemples de composition  
 Sets

Türen / Auszüge / Schubkästen mit Dämpfung  
 Doors / pull out units / drawers with buffered closing  
 Portes / tiroirs / coulissants avec amortisseur  
 Deuren en lades met softclose

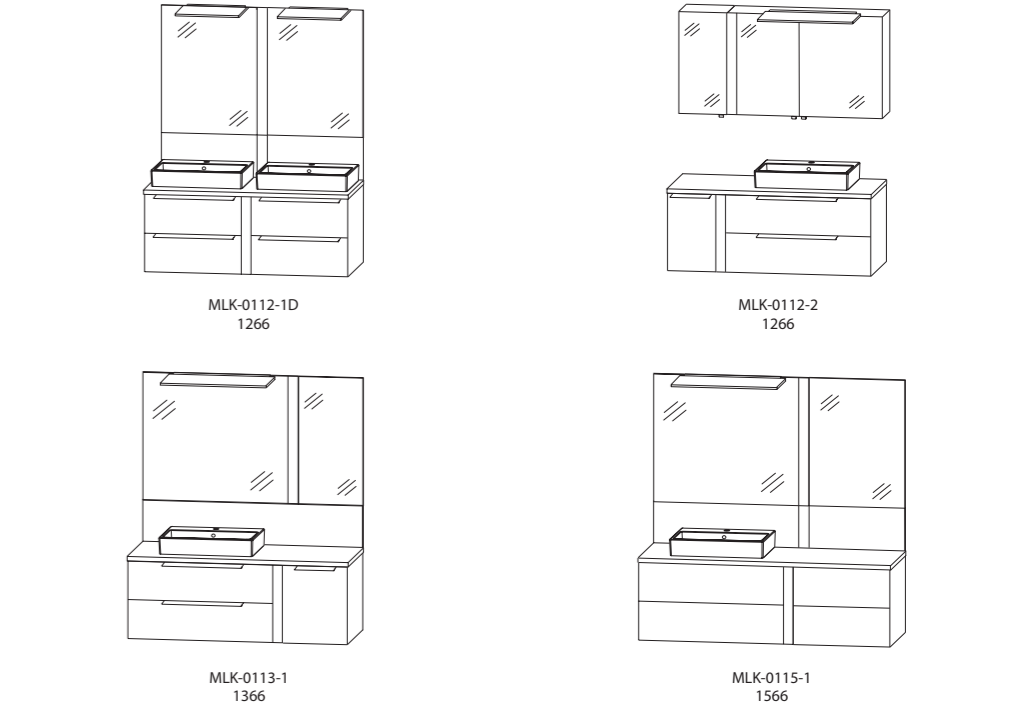

Abbildungen mit Griffleiste, auch in grifflos (push-to-open) möglich.  
 Technical drawings with handle bar, also available handleless (push-to-open).  
 Les exemples de composition avec profilé poignée également possible sans poignées (push-to-open).  
 Afbeeldingen zijn met greeplijst, greeploos (push-to-open) zijn ook mogelijk.

Ergänzungsschränke - Auszug aus dem Typenplan  
 Additional cabinets - part of the type list  
 Meubles complémentaires - extrait du plan type  
 Losse kasten - getoonde kasten zijn een selectie uit de kast mogelijkheden

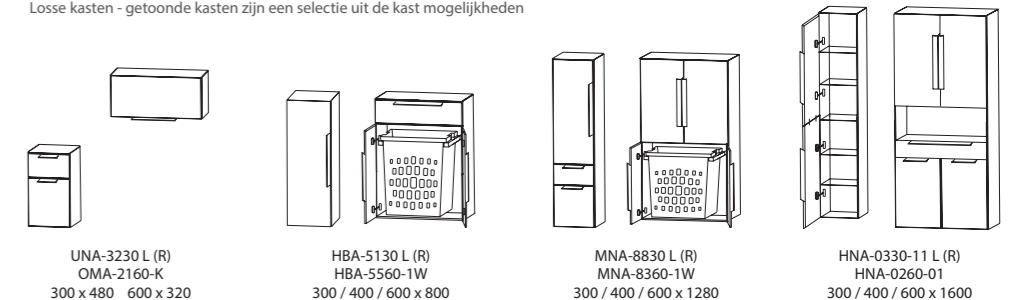

Abbildungen mit Griffleiste. Weitere Ergänzungsschränke finden Sie in der Typenliste.  
 Technical drawings with handle bar. You will find more add-on units in the type list.  
 Les exemples de composition avec profilé poignée. Autres armoires supplémentaires, voir catalogue.  
 Afbeeldingen zijn met greeplijst. Meer bijpassende kasten vindt u in de typelijst.

Breite x Höhe in mm  
 Width x height in mm  
 Largeur x hauteur en mm  
 Breedte x hoogte in mm

# NEW XPRESSION

Planungsbeispiele Spiegel - Auszug aus dem Typenplan  
 Planning proposals mirrors - part of the type list  
 Exemples de composition miroir et armoires de toilette miroir - extrait du plan type  
 Spiegelkasten - getoonde kasten zijn een selectie uit de kast mogelijkheden

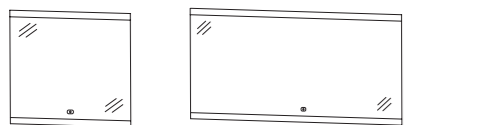

FSB-4360-01  
600 x 640

FSB-4314-01  
1400 x 640

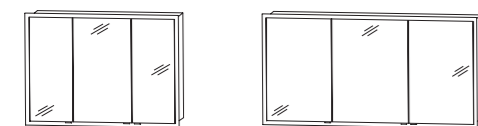

S2A-5390-E1  
951 x 851

S2A-5314-E1  
1451 x 851

Türen / Auszüge / Schubkästen mit Dämpfung  
 Doors / pull out units / drawers with buffered closing  
 Portes / tiroirs / coulissants avec amortisseur  
 Deuren en lades met softclose

Planungsbeispiele Waschtische - Auszug aus dem Typenplan  
 Planning proposals washbasins - part of the type list  
 Exemples de composition plans vasque - extrait du plan type  
 Sets van wastafels en wastafelonderkasten - getoonde kasten zijn een selectie uit de kast mogelijkheden

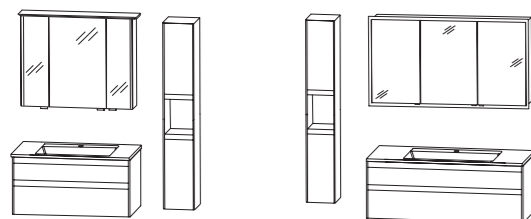

NXG-9290-1  
932

NXG-8212-1  
1232

Abbildungen mit Mineralguss-Aufsatzwaschtisch, auch in Keramik erhältlich.  
 Technical drawing with cast mineral top-mounted washbasin, also available in ceramic.  
 Les exemples de composition avec vasque à poser en matériau de synthèse sont également disponible en céramique.  
 Afbeeldingen zijn met minerale wastafels, keramische wastafels zijn ook mogelijk.

# KAO LINE

Planungsbeispiele Spiegel  
 Planning proposals mirrors  
 Exemples de composition miroir et armoires de toilette miroir  
 Spiegelkasten

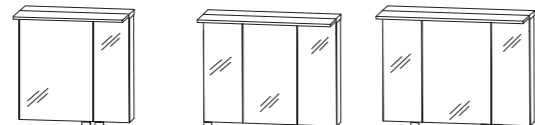

SET-4360-07 L (R)  
600 x 660

SET-4380-06  
800 x 660

SET-4390-07  
900 x 660

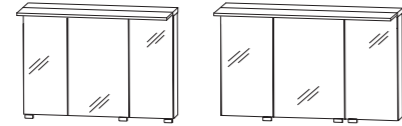

SET-4310-06  
1000 x 660

SET-4312-07  
1200 x 660

Planungsbeispiele Waschtische  
 Planning proposals washbasins  
 Exemples de composition plans vasque  
 Sets van wastafels en wastafelonderkasten

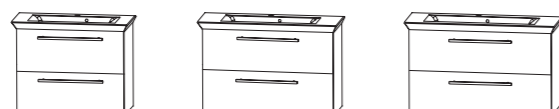

SET-KL60-1  
660 x 530

SET-KL80-1  
860 x 530

SET-KL90-1  
960 x 530

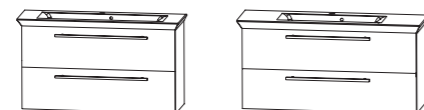

SET-KL10-1  
1060 x 530

SET-KL12-1  
1260 x 530



SET-KL12-D1  
1260 x 530

SET-KL2D-1  
1260 x 530

Breite x Höhe in mm  
 Width x height in mm  
 Largeur x hauteur en mm  
 Breedte x hoogte in mm

Türen / Auszüge / Schubkästen mit Dämpfung  
 Doors / pull out units / drawers with buffered closing  
 Portes / tiroirs / coulissants avec amortisseur  
 Deuren en lades met softclose

# ASPEKT

Planungsbeispiele  
 Planning examples  
 Exemples de composition  
 Sets

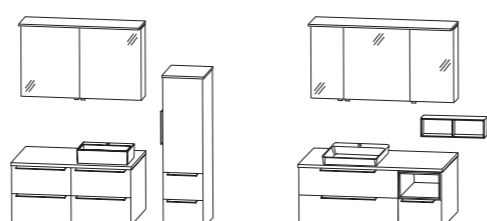

ASK-4312-2  
1206 + 402

ASK-0113-1  
1306

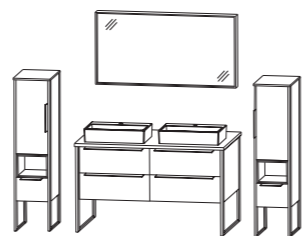

ASK-4312-1  
343 + 1246 + 343

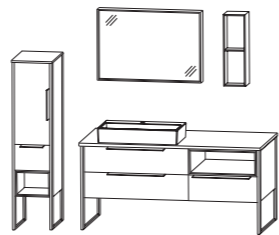

ASK-4315-1  
342 + 1546

Türen / Auszüge / Schubkästen mit Dämpfung  
 Doors / pull out units / drawers with buffered closing  
 Portes / tiroirs / coulissants avec amortisseur  
 Deuren en lades met softclose

Badmöbelkombinationen von 606 bis 1546 mm Breite erhältlich.  
 Bathroom furniture combinations available in widths from 606 to 1546 mm.  
 Compositions de salle de bains disponibles en largeur de 606 à 1546 mm.  
 Badkamermeubelcombinaties van 606 tot 1546 mm breed verkrijgbaar.

Breite in mm  
 Width in mm  
 Largeur en mm  
 Breedte in mm

# SWING

Planungsbeispiele Spiegel  
 Planning proposals mirrors  
 Exemples de composition miroir et armoires de toilette miroir  
 Spiegelkasten

Breite x Höhe in mm  
 Width x height in mm  
 Largeur x hauteur en mm  
 Breedte x hoogte in mm



SET-4390-3 R (L)  
900 x 680

SET-4112-3R (L)  
1200 x 680

SET-4114-2R (L)  
1400 x 680

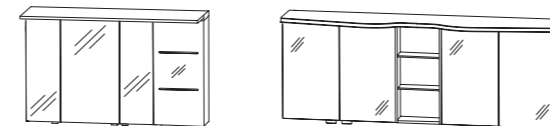

SET-4012-6R (L)  
1200 x 660

SET-4118-3  
1800 x 680

Planungsbeispiele Waschtische  
 Planning proposals washbasins  
 Exemples de composition plans vasque  
 Sets van wastafels en wastafelonderkasten

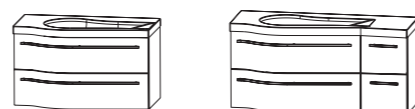

WMM-529R-21 (L)  
WUA-3690-1M R (L)  
906 x 495

WMM-522R-21 (L)  
WUA-3690-1M R (L) + UTA-3630-1M  
1206 x 495

evermite®



WMM-524R-21 (L)  
WUA-3690-1M R (L) + UTA-3650-1M  
1406 x 495

WMM-528D-21  
WUA-3690-1M L + WUA-3690-1M R  
1806 x 495

Türen / Auszüge / Schubkästen mit Dämpfung  
 Doors / pull out units / drawers with buffered closing  
 Portes / tiroirs / coulissants avec amortisseur  
 Deuren en lades met softclose

Abbildungen mit evermite® Waschtisch, auch in Glas erhältlich.  
 Technical drawing with evermite® washbasin, also available in glass.  
 Les exemples de composition avec evermite® plan vasque sont également disponible en verre.  
 Afbeeldingen zijn met evermite® wastafels, glazen wastafels zijn ook mogelijk.

# FINE LINE

Planungsbeispiele Spiegel  
 Planning proposals mirrors  
 Exemples de composition miroir et armoires de toilette miroir  
 Spiegelkasten

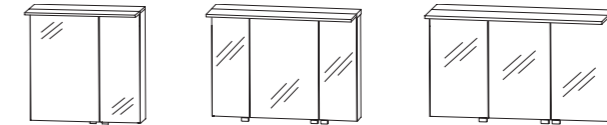

S2A-4360-78 L (R)  
602 x 659

S2A-4390-78  
902 x 659

S2A-4312-78  
1202 x 659

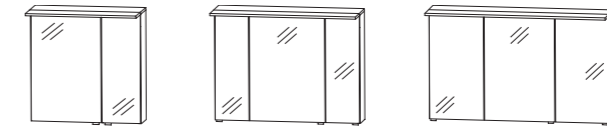

S2A-4365-08 L (R)  
602 x 659

S2A-4395-08  
902 x 659

S2A-4325-08  
1202 x 659

Planungsbeispiele Waschtische  
 Planning proposals washbasins  
 Exemples de composition plans vasque  
 Sets van wastafels en wastafelonderkasten

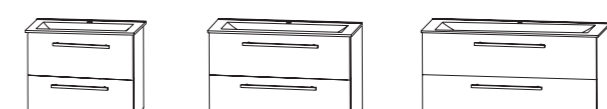

WMS-4060-61  
WUA-3760-28  
620 x 495

WMS-4090-61  
WUA-3790-28  
920 x 495

WMS-4120-61  
WUA-3712-28  
1220 x 495

STONEPLUS®



WTK-7065-1  
WUA-3760-27  
650 x 545

WTK-7095-1  
WUA-3790-27  
950 x 545

WTK-7125-1  
WUA-3712-27  
1250 x 545

Keramik  
 ceramic  
 céramique  
 keramiek

Breite x Höhe in mm  
 Width x height in mm  
 Largeur x hauteur en mm  
 Breedte x hoogte in mm

Türen / Auszüge / Schubkästen mit Dämpfung  
 Doors / pull out units / drawers with buffered closing  
 Portes / tiroirs / coulissants avec amortisseur  
 Deuren en lades met softclose

# CRESCENDO

Planungsbeispiele Spiegel  
 Planning proposals mirrors  
 Exemples de composition miroir et armoires de toilette miroir  
 Spiegels / Spiegelkasten

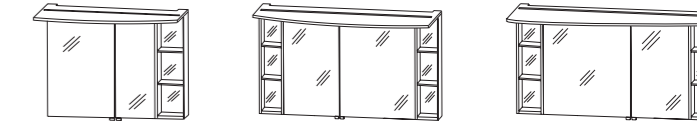

S2A-439R 76  
900 x 650

S2A-4312-76 L (R)  
1200 x 650

S2A-4314-76 R (L)  
1400 x 650

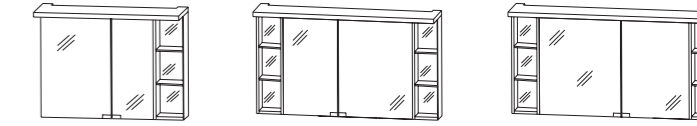

S2A-439R-26  
900 x 668

S2A-4312-26 L (R)  
1200 x 668

S2A-4314-26 R (L)  
1400 x 668

Planungsbeispiele Waschtische  
 Planning proposals washbasins  
 Exemples de composition plans vasque  
 Sets van wastafels en wastafelonderkasten

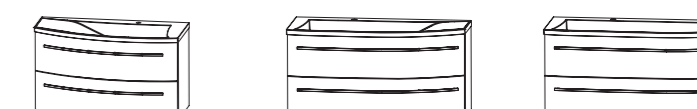

SWM-109L-21 (R)  
WUA-3690-09 L (R)  
906 x 510

SWM-112R-21 (L)  
WUA-3612-09 R (L)  
1206 x 510

SWM-114R-21 (L)  
WUA-3614-09 R (L)  
1406 x 510

evermite®

Breite x Höhe in mm  
 Width x height in mm  
 Largeur x hauteur en mm  
 Breedte x hoogte in mm

Abbildungen mit evermite® Waschtisch, auch in Glas erhältlich.  
 Technical drawing with evermite® washbasin, also available in glass.  
 Les exemples de composition avec evermite® plan vasque sont également disponible en verre.  
 Afbeeldingen zijn met evermite® wastafels, glazen wastafels zijn ook mogelijk.



# COOL LINE

Planungsbeispiele Spiegel  
Planning proposals mirrors  
Exemples de composition miroir et armoires de toilette miroir  
Spiegelkasten

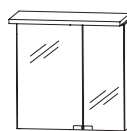

S2A-436A-20 L (R)  
600 x 680

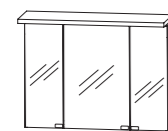

S2A-439A-20  
900 x 680

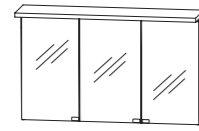

S2A-431A-20  
1200 x 680

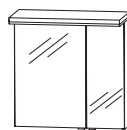

S2A-436A-69 L (R)  
600 x 680



S2A-439A-69  
900 x 680

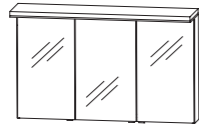

S2A-431A-69  
1200 x 680

Planungsbeispiele Waschtische  
Planning proposals washbasins  
Exemples de composition plans vasque  
Sets van wastafels en wastafelonderkasten



WMS-5060-61  
WUA-386D-1M  
620 x 539

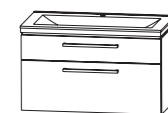

WMS-5090-61  
WUA-389D-1M  
920 x 539

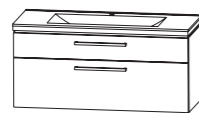

WMS-5120-61  
WUA-381D-1M  
1220 x 539

**STONEPLUS**

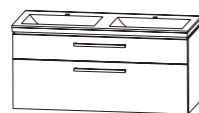

WMS-7120-61  
WUA-381D-3M  
1220 x 539

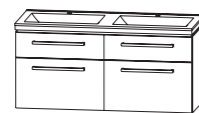

WMS-7120-61  
WUA-341D-3M  
1220 x 539

Breite x Höhe in mm  
Width x height in mm  
Largeur x hauteur en mm  
Breedte x hoogte in mm

Türen / Auszüge / Schubkästen mit Dämpfung  
Doors / pull out units / drawers with buffered closing  
Portes / tiroirs / coulissants avec amortisseur  
Deuren en lades met softclose

Abbildungen mit STONEPLUS® Waschtisch, auch in Glas oder Keramik erhältlich.  
Technical drawing with STONEPLUS® washbasin, also available in glass or ceramic.  
Exemples de composition avec STONEPLUS® plan vasque sont également disponible en verre ou en céramique.  
Afbeeldingen zijn met STONEPLUS® wastafels, glazen en keramische wastafels zijn ook mogelijk.

# STAR LINE

Planungsbeispiele Spiegel  
Planning proposals mirrors  
Exemples de composition miroir et armoires de toilette miroir  
Spiegels / Spiegelkasten

Breite x Höhe in mm  
Width x height in mm  
Largeur x hauteur en mm  
Breedte x hoogte in mm

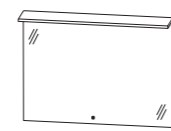

FSB-4190-01  
900 x 652



FSB-4114-01  
1400 x 652

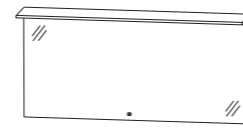

FSB-4116-01  
1600 x 652

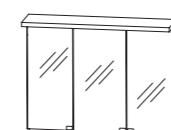

S2A-4390-16  
900 x 668

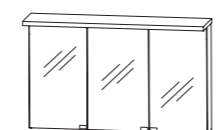

S2A-4312-16  
1200 x 668

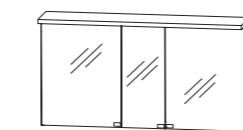

S2A-4314-15  
1400 x 668

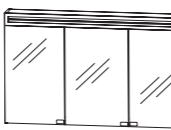

S2A-5812-6  
1200 x 720

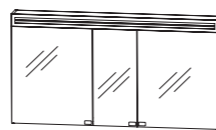

S2A-5814-5  
1400 x 720

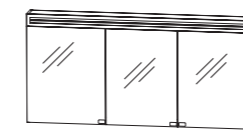

S2A-5816-5  
1600 x 720

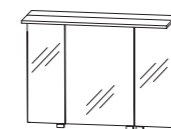

S2A-4390-78  
900 x 660



S2A-4312-77  
1200 x 660



S2A-4314-78  
1400 x 660

Planungsbeispiele Waschtische  
Planning proposals washbasins  
Exemples de composition plans vasque  
Sets van wastafels en wastafelonderkasten

Türen / Auszüge / Schubkästen mit Dämpfung  
Doors / pull out units / drawers with buffered closing  
Portes / tiroirs / coulissants avec amortisseur  
Deuren en lades met softclose

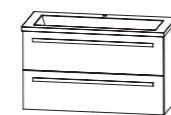

WME-919E-61  
WUA-3390-07  
906 x 498



WME-914E-61  
WUA-3314-07  
1406 x 498

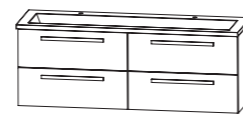

WME-916D-61  
WUA-3316-7  
1606 x 498

**STONEPLUS**

Abbildungen mit STONEPLUS® Waschtisch, auch in „evermite“ oder Glas erhältlich.  
Technical drawing with STONEPLUS® washbasin, also available in „evermite“ or glass.  
Les exemples de composition avec STONEPLUS® plan vasque sont également disponible en „evermite“ ou en verre.  
Afbeeldingen zijn met STONEPLUS® wastafels, „evermite“ en glazen wastafels zijn ook mogelijk.

# CLASSIC LINE

Planungsbeispiele Spiegel  
Planning proposals mirrors  
Exemples de composition miroir et armoires de toilette miroir  
Spiegelkasten

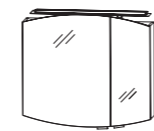

S2A-4370-59 L (R)  
700 x 700

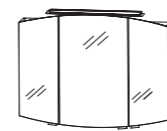

S2A-4390-59  
900 x 700

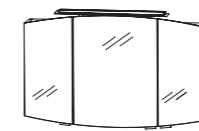

S2A-4312-59  
1200 x 700

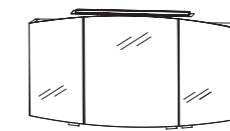

S2A-4314-59  
1400 x 700



S2A-4370-22  
700 x 687

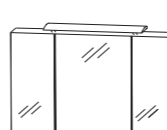

S2A-4390-22  
900 x 687

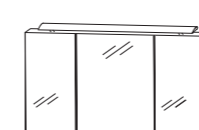

S2A-4312-22  
1200 x 687

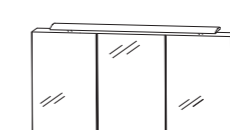

S2A-4314-22  
1400 x 687

Planungsbeispiele Waschtische  
Planning proposals washbasins  
Exemples de composition plans vasque  
Sets van wastafels en wastafelonderkasten



SWM-8207-B1  
WUA-3570-7M  
712 x 520

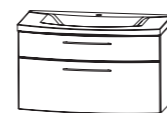

SWM-8209-B1  
WUA-3590-7M  
912 x 520



SWM-8220-B1  
WUA-3512-7M  
1212 x 520



SWM-8240-B1  
WUA-3514-7M  
1412 x 520

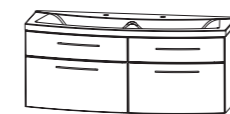

SWM-824D-B1  
WUA-3514-6M  
1412 x 520

**evermite**

Breite x Höhe in mm  
Width x height in mm  
Largeur x hauteur en mm  
Breedte x hoogte in mm

Türen / Auszüge / Schubkästen mit Dämpfung  
Doors / pull out units / drawers with buffered closing  
Portes / tiroirs / coulissants avec amortisseur  
Deuren en lades met softclose

Abbildungen mit evermite® Waschtisch, auch in Glas erhältlich.  
Technical drawing with „evermite“ washbasin, also available in glass.  
Les exemples de composition avec evermite® plan vasque sont également disponible en verre.  
Afbeeldingen is met evermite® wastafels, glazen wastafels zijn ook mogelijk.



# STAR LINE

# ROUNDS

# FINE LINE

# CRESCENDO

Ergänzungsschränke - Auszug aus dem Typenplan  
 Additional cabinets - part of the type list  
 Meubles complémentaires - extrait du plan type  
 Losse kasten - getoonde kasten zijn een selectie uit de kast mogelijkheden

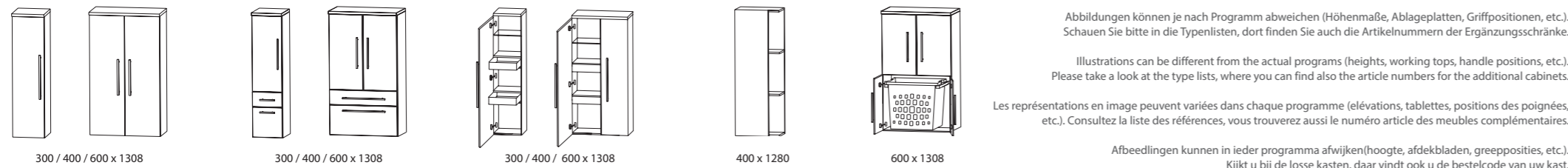

Abbildungen können je nach Programm abweichen (Höhenmaße, Ablageplatten, Griffpositionen, etc.).  
 Schauen Sie bitte in die Typenlisten, dort finden Sie auch die Artikelnummern der Ergänzungsschränke.  
 Illustrations can be different from the actual programs (heights, working tops, handle positions, etc.).  
 Please take a look at the type lists, where you can find also the article numbers for the additional cabinets.  
 Les représentations en image peuvent varierés dans chaque programme (élévations, tablettes, positions des poignées, etc.).  
 Consultez la liste des références, vous trouverez aussi le numéro article des meubles complémentaires.

Afbeeldingen kunnen in ieder programma afwijken(hoogte, afdekbladen, greepposities, etc.).  
 Kijkt u bij de losse kasten, daar vindt ook u de bestelcode van uw kast.

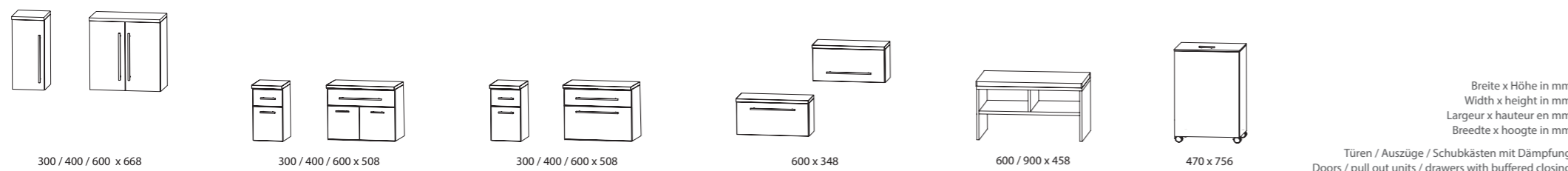
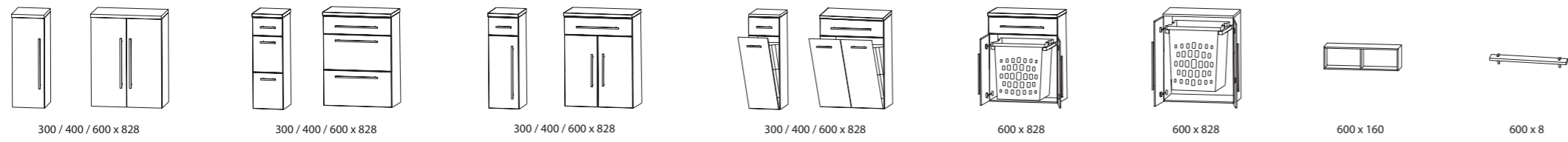

Breite x Höhe in mm  
 Width x height in mm  
 Largeur x hauteur en mm  
 Breedte x hoogte in mm  
 Türen / Auszüge / Schubkästen mit Dämpfung  
 Doors / pull out units / drawers with buffered closing  
 Portes / tiroirs / coulissants avec amortisseur  
 Deuren en lades met softclose

Optionales Zubehör + optionale Ergänzungsschränke  
 optional accessoires + optional additional cabinets  
 accessoires en option + meubles complémentaires  
 optionele accessoires + losse kasten

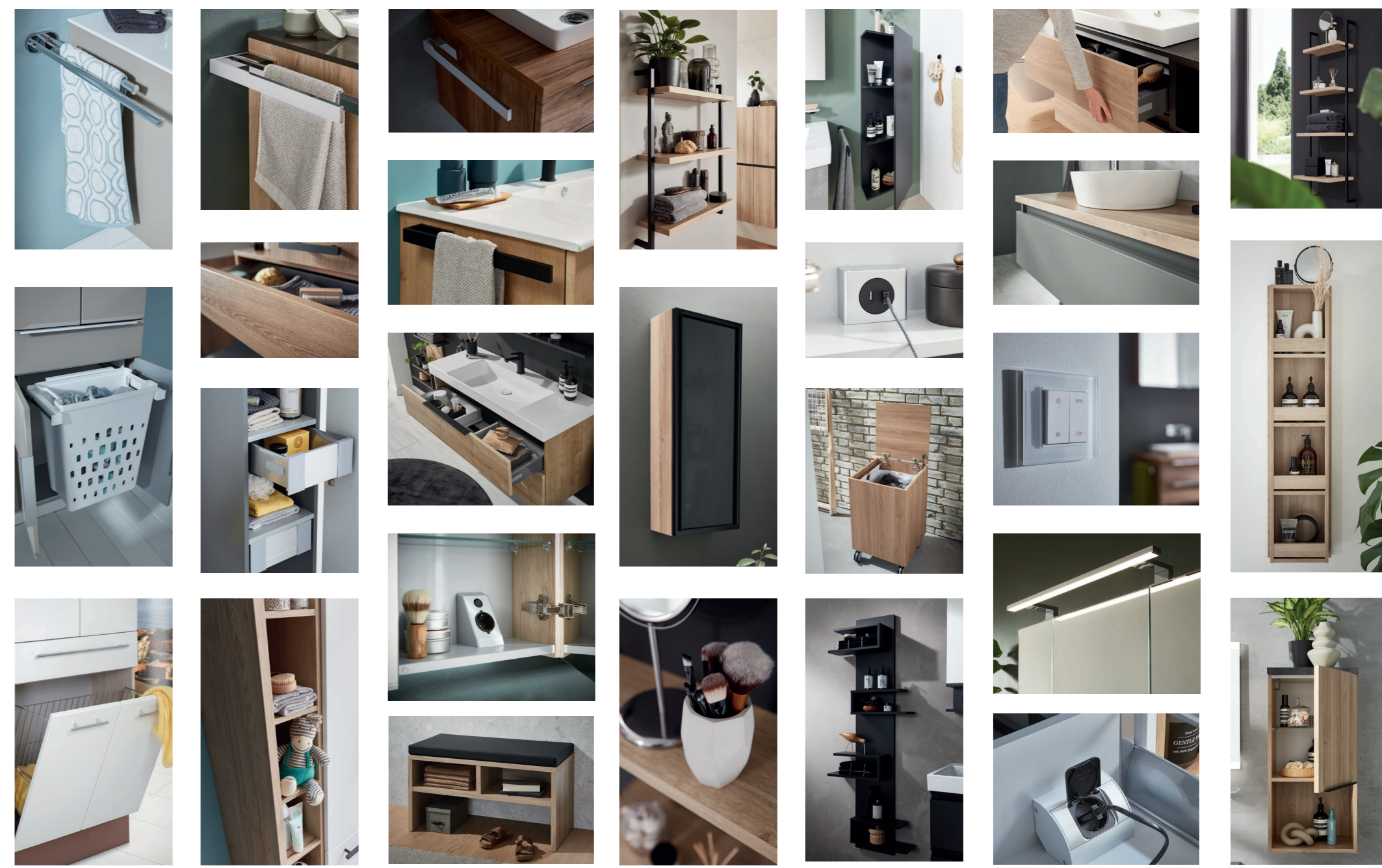

# CLASSIC LINE

# KAO LINE

# COOL LINE

# SWING



Weitere Möbel finden Sie in den Prospekten „KeraPLAN“ und „new generation“.  
 Further bathroom furniture can be found in our brochures “KeraPLAN” and “new generation”.  
 Vous trouverez plus de meubles dans les brochures «KeraPLAN» et «new generation».  
 Meer meubels zijn te vinden in de brochures “KeraPLAN” en “new generation”.



new  
generation

**puris**  
BAD · MÖBEL  
[www.puris.de](http://www.puris.de)

Qualität ist Aufgabe und Ziel.  
 Das „goldene M“ steht für geprüfte Qualität, garantierte Sicherheit und gesundes Wohnen. Es ist das einzige in Deutschland offiziell anerkannte Gütezeichen für Möbel und es ist der strengste Nachweis für überprüfte Möbelqualität und -sicherheit in Europa.

Quality is our mission and goal.  
 The “Golden M” stands for tested quality, guaranteed safety and healthy living. It is Germany’s only officially recognised quality seal for furniture and it is the strictest confirmation of tested furniture quality and safety in Europe.

Notre objectif: la qualité.  
 Le «M d'or» garantit non seulement une qualité et une sécurité contrôlée mais aussi un habitat sain. Il est le seul label de qualité attribué aux meubles reconnu en Allemagne. En Europe, suite à une série de tests réalisés, ce cachet est la garantie optimale de la qualité et la sécurité des meubles.

Kwaliteit is onze taak en doelstelling.  
 De “gouden M” staat voor geteste kwaliteit, veiligheid en gezond wonen gegarandeerd. Het is het enige officiële erkende label in Duitsland. Dit label geeft aan dat puris voldoet aan de strengste eisen van kwaliteit en veiligheid in Europa.



puris Bad GmbH & Co. KG · Hinterm Gallberg 6a · D-59929 Brilon  
 mail@puris.de · [www.puris.de](http://www.puris.de)

Abbildungen und Angaben sind unverbindlich. Technische Änderungen vorbehalten.  
 Illustrations and specifications are without obligation. Technical modifications reserved.  
 Reproductions et données techniques sans engagement de notre part. Sous réserve de modifications techniques.  
 Afbeeldingen en specificaties kunnen afwijken. Technische wijzigingen voorbehouden.



Follow us on  
**Instagram**  
@puris\_bad

