



light and smart

COMMERCIAL LIGHTING

2023V1

Customized Service

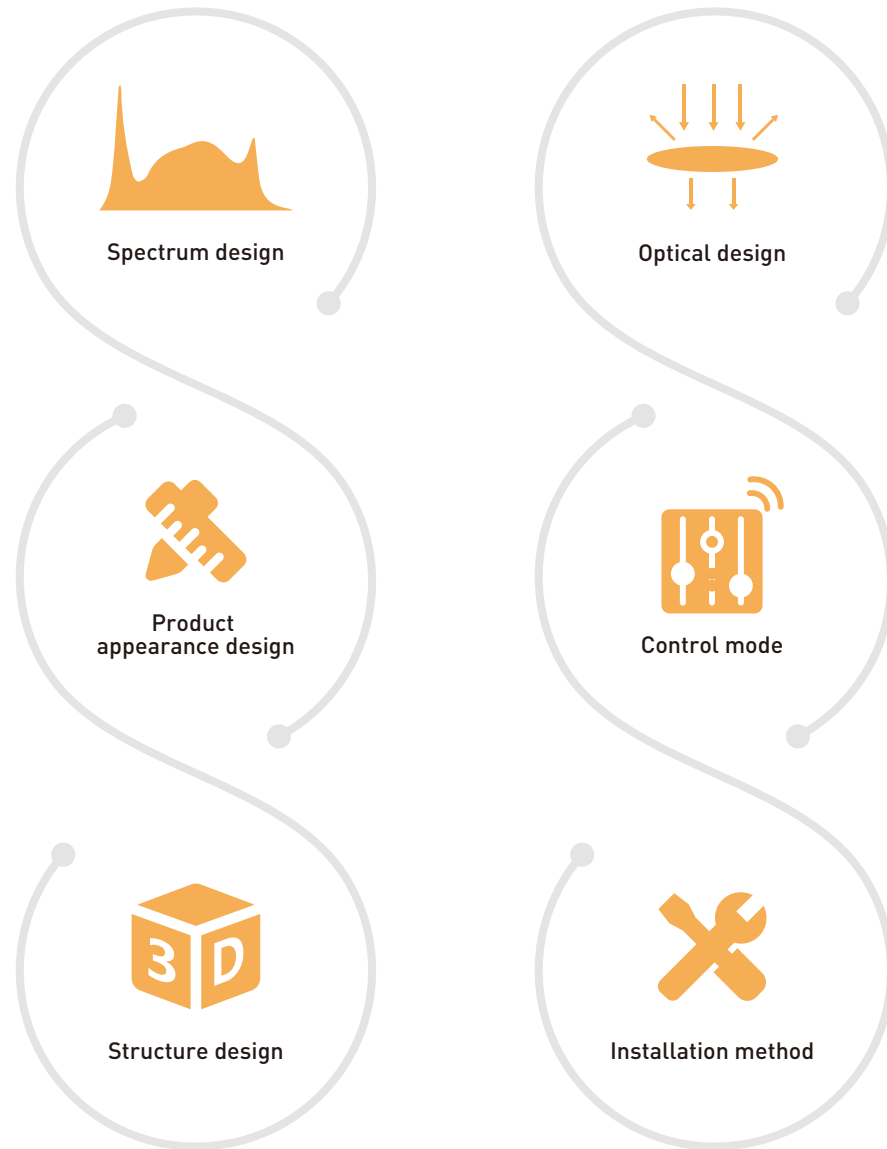

Main Production Devices



SMT machine	13 sets	Auto dispensing machine	2 sets
Reflow soldering	8 sets	Solder paste mixer	4 sets
Auto printer	14 sets	Auto screw machine	11 sets
Auto wire bonder	7 sets	Auto packing machine	4 sets
Auto loading machine	3 sets	LED dehumidification box	8 sets
Slitting machine	9 sets	Spray code machine	4 sets
Injection machine	5 sets	Circular assembly line	15 sets
Silicone extruder	2 sets		

R&D

Signcomplex has R&D capability in LED lighting fixtures. More than 5% of our annual sales in R&D to ensure continuous product improvement and innovation.

Our 100 people R&D team has rich experience in intelligent software, electronic structure, lighting control system, heat dissipation simulation analysis and so on.

We also have the ability to develop customized products.



Rhino modeling
(Shape design)

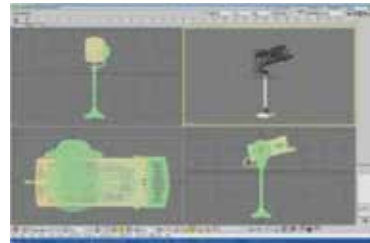

3DS-Rendering
(Shape design)

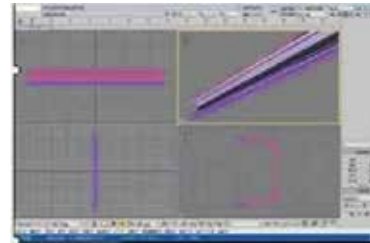

3DSMAX
(Shape design)

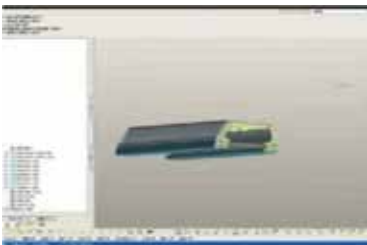

Pro-E
(Structure design)



PCB board design

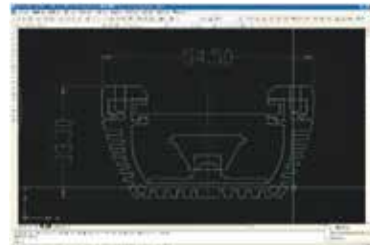

AutoCAD
(Driver design)

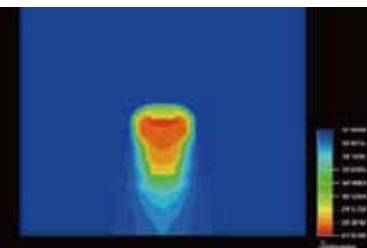

ICEPAK
(Thermal analysis)

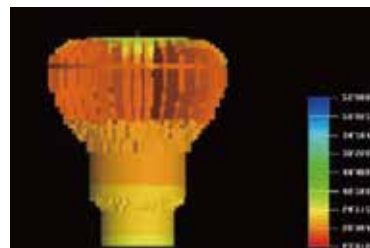

ICEPAK
(Thermal analysis)



Optical design

Certificate



▲ ISO9001:2015

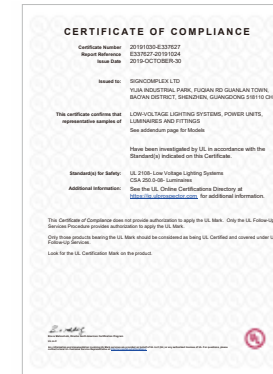

▲ UL

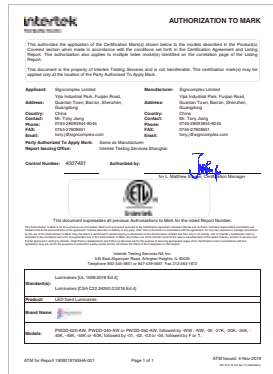

▲ ETL



▲ FCC



▲ IP Grade



▲ SAA



▲ CE



▲ RoHS



▲ ERP

Strict Quality Control

We establish standards and specifications for laboratory reliability testing, improve product testing standards, and improve product quality. Our products have passed the following tests:

- Dust-proof test
- IP rating test
- Wind-shield
- Line leakage test
- Anti-UV test
- Salt Spray test
- High Voltage test
- Suspension test
- Lifespan test
- Power on and off test
- Dimension check
- Wire rod check
- Electronic load test
- Oscilloscope
- Oven
- Safety test
- Drop test
- Aging test
- Optical test
- Cold thermal shock test
- Transport simulation test
- Constant temperature & humidity test



▲ IP rating test



▲ Power on and off test



▲ UV aging test



▲ Optical test



▲ Cold thermal shock test



▲ Salt spray test



▲ ESD generator

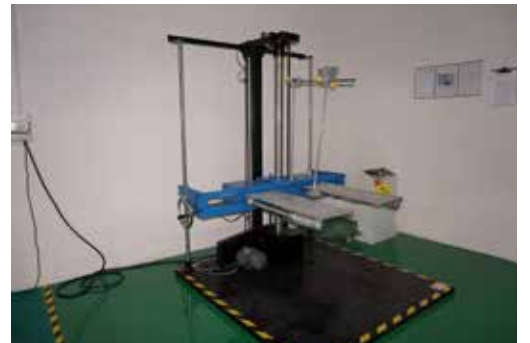

▲ Drop test



▲ Lifespan test



▲ Goniophotometers system

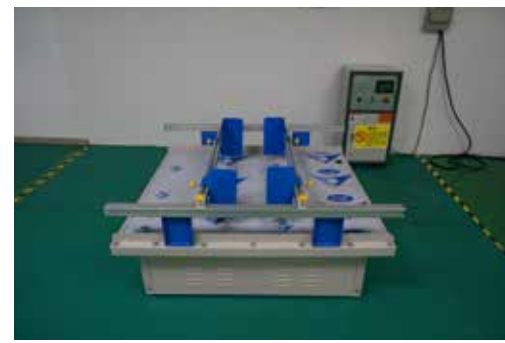

▲ Transport simulation test



▲ Aging test

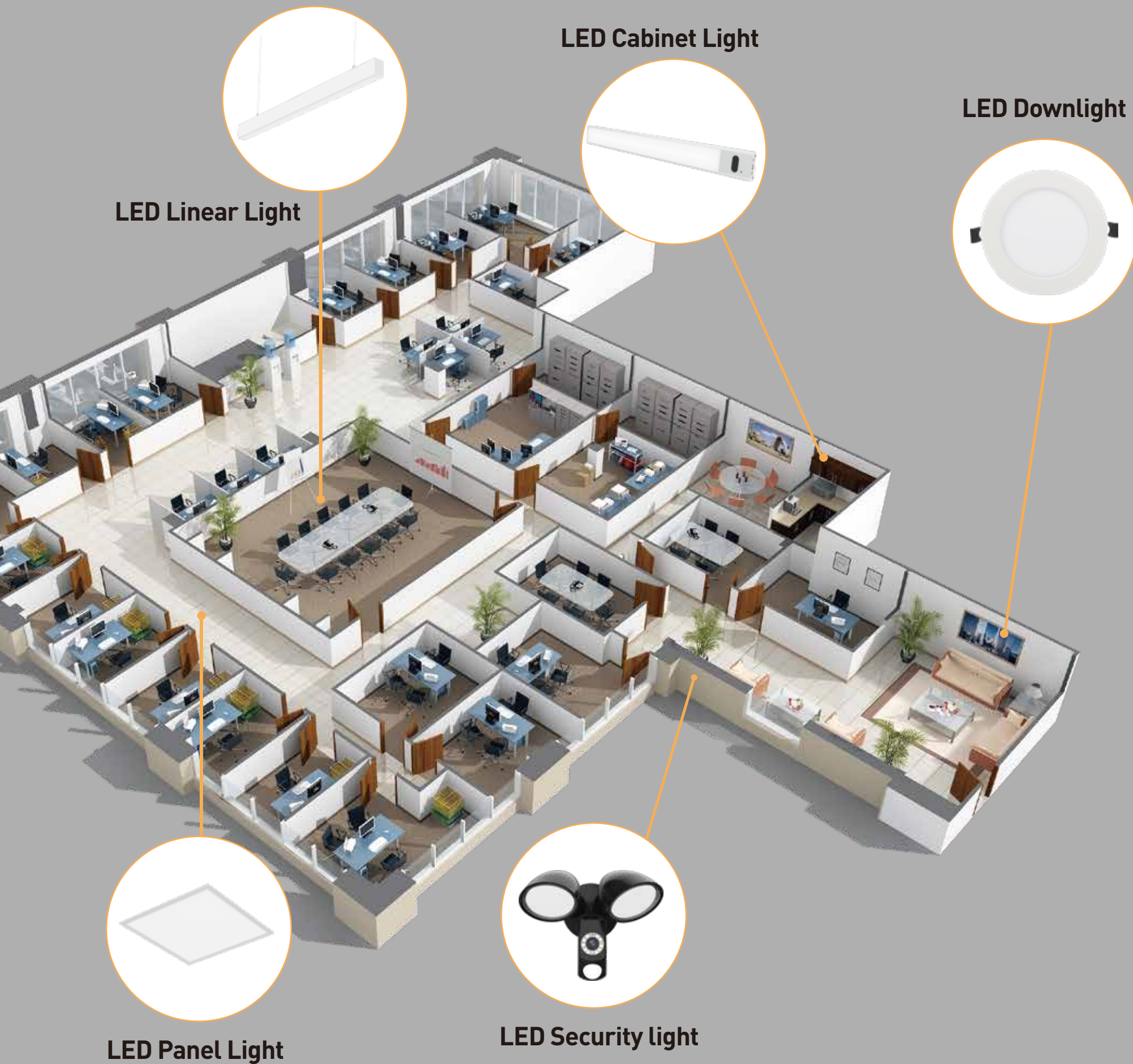

LED Cabinet Light

LED Downlight

LED Linear Light

LED Panel Light

LED Security light

Commercial Lighting

Signcomplex commercial lighting products are designed based on scene and mood lighting, different light efficiency, maximum up to 160lm/W, can meet general illuminance requirement. CCT 3000K, 4000K, 5000K, 6000K, and 2700K, minimum CRI80, maximum CRI97. No matter glorious hotel or warm and sweet coffee shop, you can find suitable lamp from Signcomplex.

It's time to replace them with LED lamp. LED is solid light source, UV free, mercury free, and it is healthy and green lighting; at the same time it is more energy-saving, up to 90%. Since 2006, Signcomplex supply thousands of our products to brand company like Louis Vuitton, Burberry, Sheraton, Four-Seasons, Marriott, Marlboro, NIKE, Walmart, etc, and Signcomplex is the vendor of Schneider, Simon, SLV, Philips and Electrolux.

Application: widely used in hotels, meeting rooms, factories, offices, commercial purposes, residential, institution buildings, schools, hospitals, places which needs energy saving and high color rendering index lighting.

CONTENTS

LED Panel light

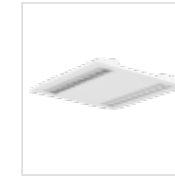

3CCT louvres light
/ 03-08 /



Smart panel light
/ 09-14 /



PIR sensor panel light
/ 15-20 /

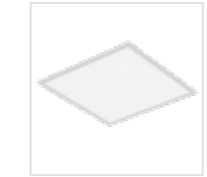

Wattage adjustable & 3CCT tunable series Edge-lit series
/ 21-26 /

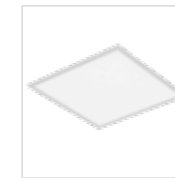

Wattage adjustable & 3CCT tunable series Back-lit series
/ 27-32 /

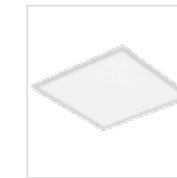

3CCT tunable series
/ 33-38 /



Super slim back-lit series
/ 39-44 /



Super slim edge-lit series
/ 45-54 /



IP65 Waterproof series
/ 55-60 /



Float series
/ 61-64 /

LED Linear light

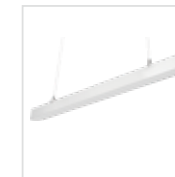

SL8055 series
/ 67-72 /

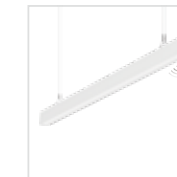

SL8050 series (microwave sensor)
/ 73-78 /

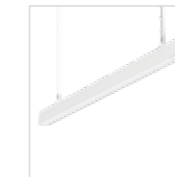

SL8050 series (pir sensor)
/ 79-84 /

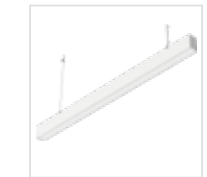

SL8050 series
/ 85-90 /



SL3668 series
/ 91-96 /

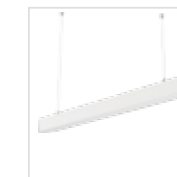

SL8456 series
/ 97-102 /



SL5550 series
/ 103-108 /

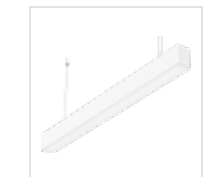

SL10075 series
/ 109-114 /

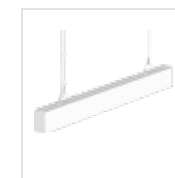

SL11070 series
/ 115-120 /



SL4932 series
/ 121-126 /

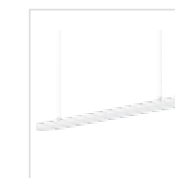

SL4040 series
/ 127-132 /



RL7035 series
/ 133-138 /



LED Panel Light

LED Panel Light can perfectly replace traditional downlight. Using Light Guide Plate, it has the feature of uniform and smooth light beam, low glare rating, low light pollution, and excellent protection from eyestrain. It can be widely used as interior lighting in shops, supermarkets, malls and hospitals, etc

- CE** 3CCT louves light | P03-08
- CE** Smart panel light | P09-14
- CE** PIR sensor panel light | P15-20
- UL** Wattage adjustable & 3CCT tunable series
 - Edge-lit series | P21-26
 - Back-lit series | P27-32
- CE** 3CCT tunable series | P33-38
- CE ETL** Super slim back-lit series | P39-44
- CE UL** Super slim edge-lit series | P45-54
- CE** IP65 waterproof series | P55-60
- CE** FLOAT series round suspending panel light | P61-64



3CCT louvered light

GLM series

The product has simple appearance, soft light, and uniform luminance. The lighting effect includes diffusion type and grille type, with adjustable color temperature through dip switch, widely used in office buildings, factories, department stores and other indoor sites.

Three CCT and three power adjustable

Three CCT and three power adjustable, save stock cost.

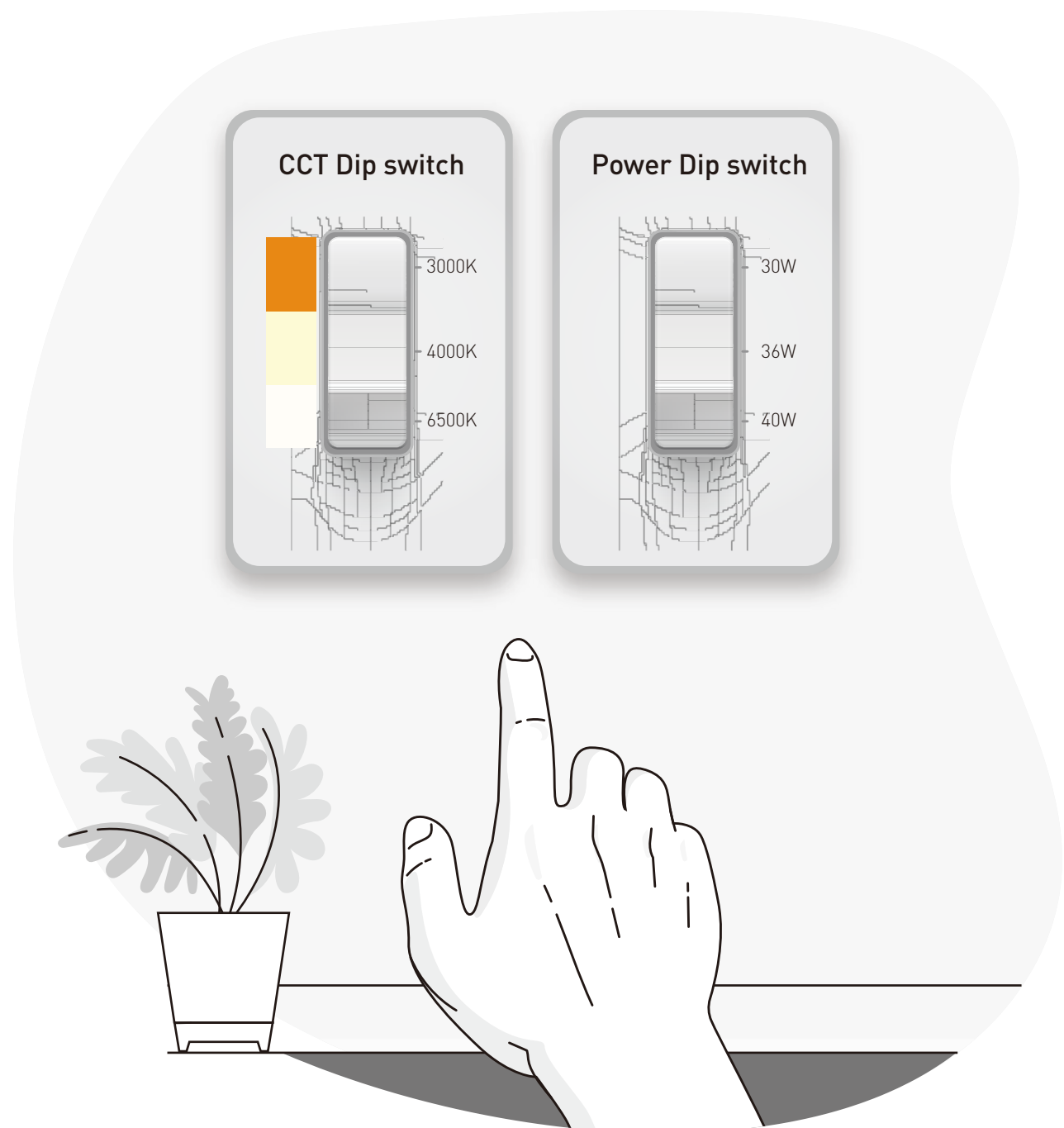

Three lens optional

Three lens version for optional: louveres lens, opal lens and micro prisma lens.

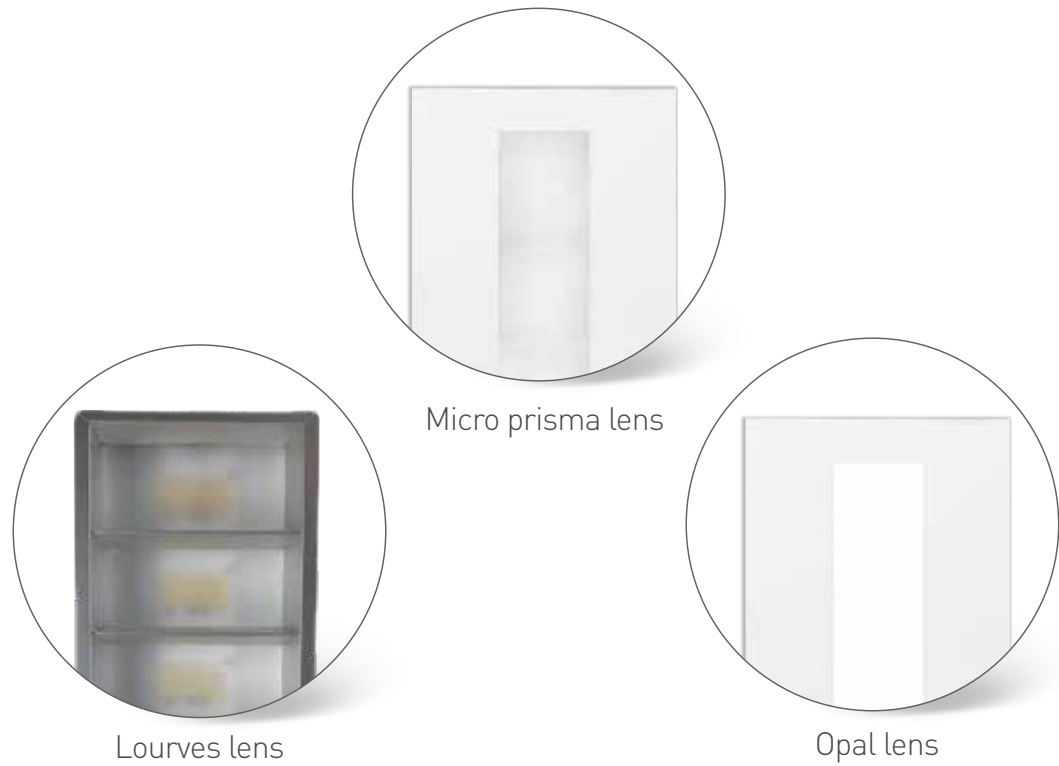

Three beam angles

Three beam angles: 80° (louvres version) / 90° (micro prisma version) / 110° (opal version)

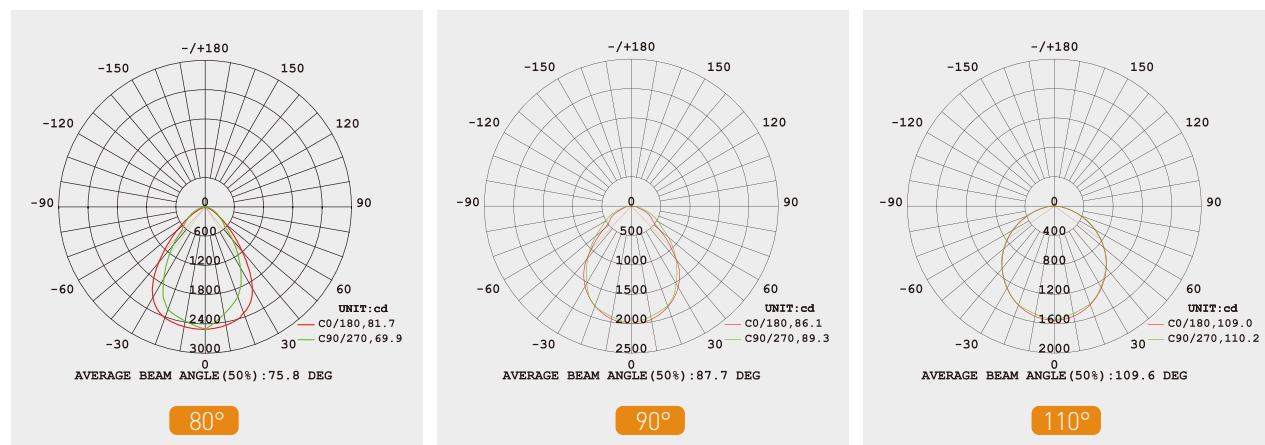

High-quality aluminum profile

Aluminum lattice adopts high-quality aluminum profile.



Integrated molding process

The frame adopts iron frame, integrated molding process and stronger structure.



Parameters CE for EU



Product name	Color	Power	Beam angle(°)	LEDs type	CRI	PF	Voltage
595*595mm	3000K-4000K-6500K	30/36/40W	80°/90°/120°	SMD2835	Ra>80	>0.9	220-240VAC 50/60Hz
295*1195mm	3000K-4000K-6500K	30/36/40W	80°/90°/120°	SMD2835	Ra>80	>0.9	220-240VAC 50/60Hz

Unit:mm

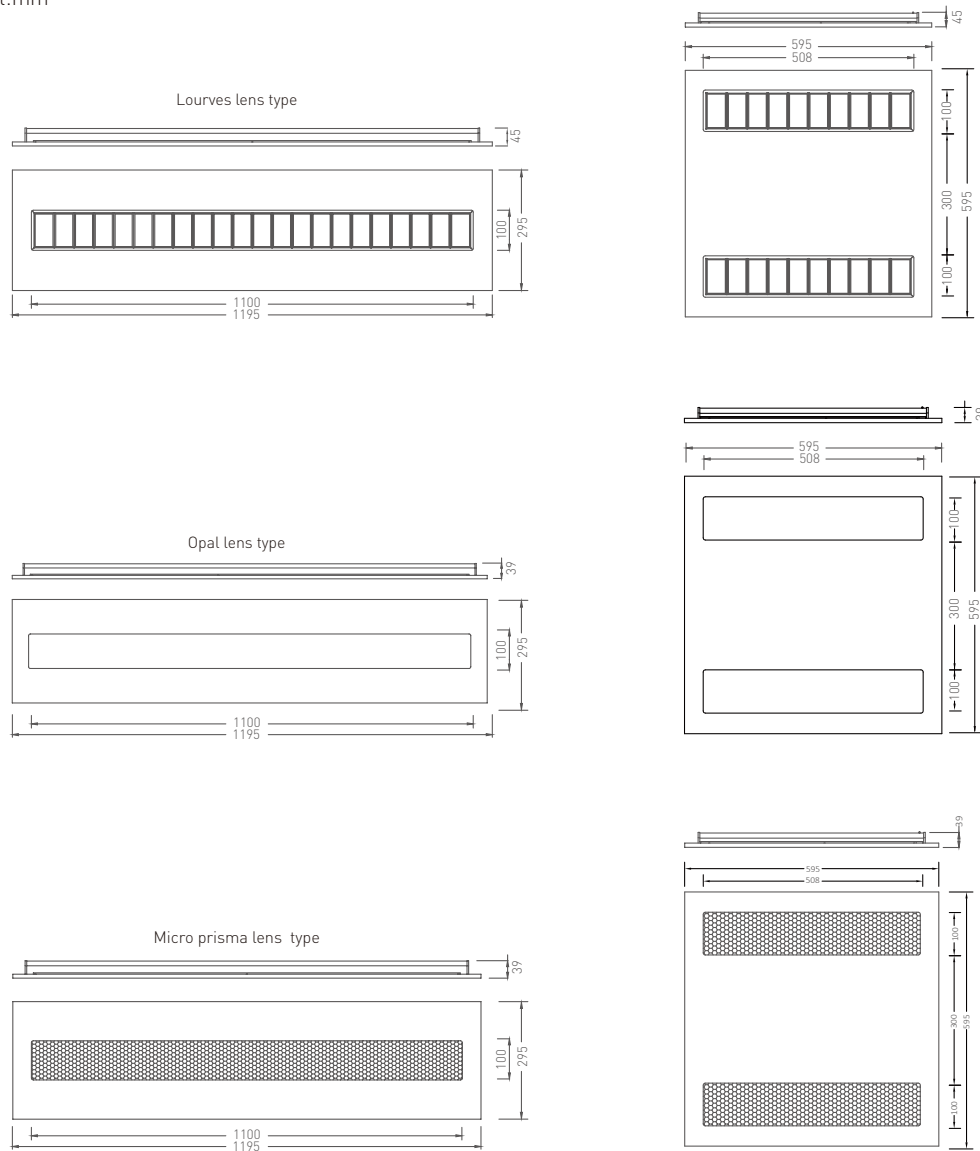

Package

Product size	Inner size	Carton size	Pack Quantity	Net weight	Gross weight
595*595mm	635*638*71mm	655*385*660mm	5PCS	3.1 kg	19.8 kg
295*1195mm	1235*364*71mm	1255*385*385mm	5PCS	3.1 kg	20.5 kg

Installation

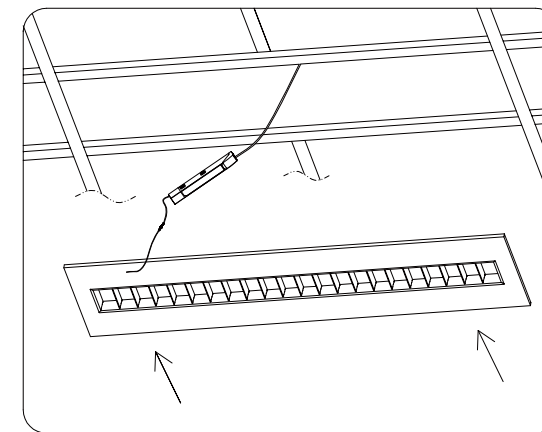

Embedded Installation

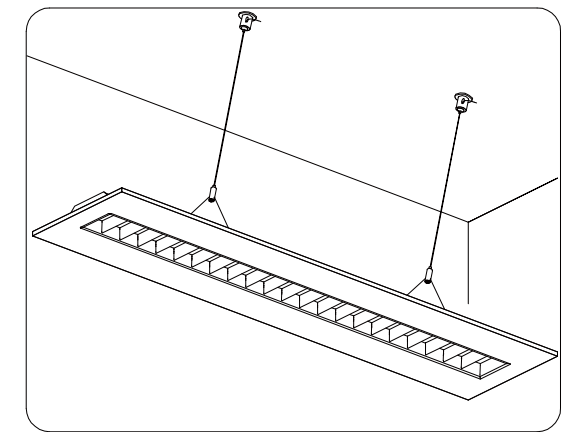

Suspension Installation

Smart panel light

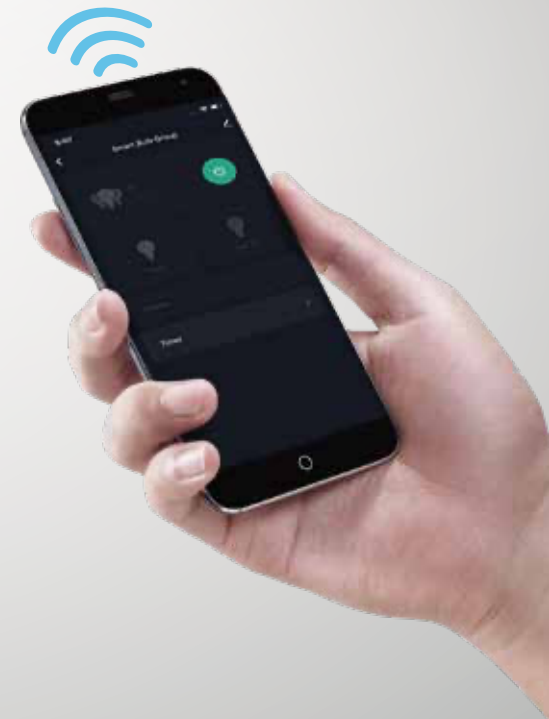
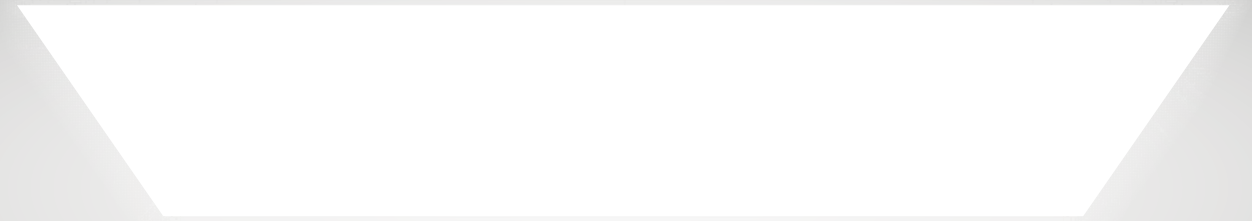
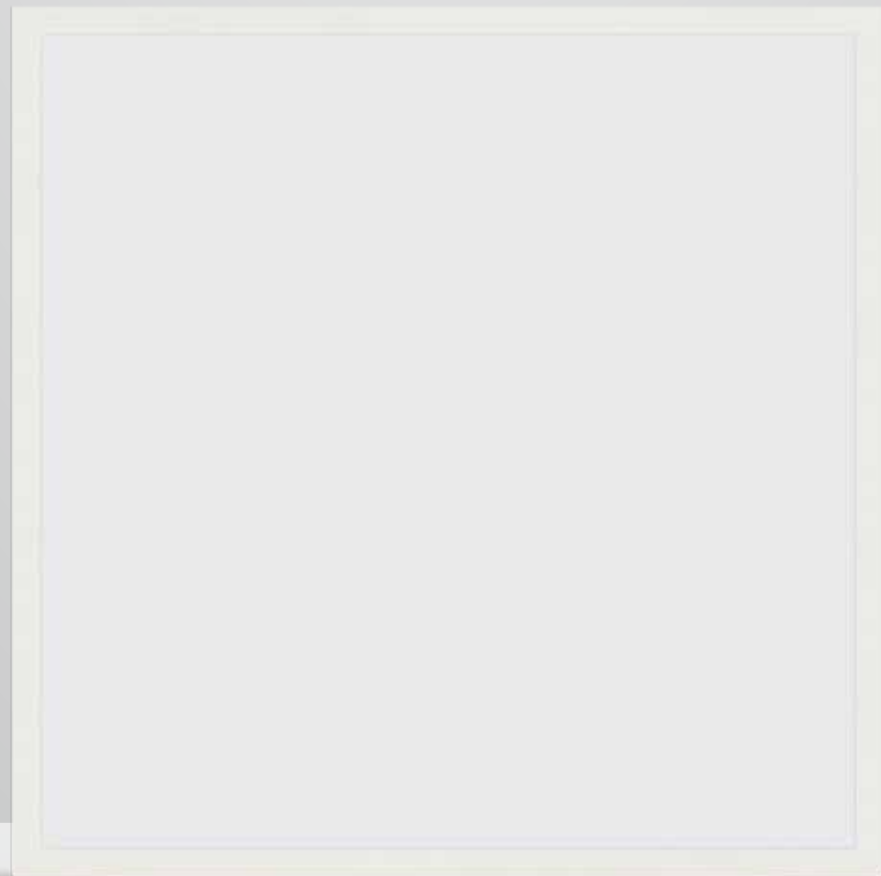

Different smart control methods

Connect bluetooth and WIFI to control the lights.



APP control



Voice control



Group control

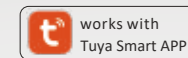

works with
Tuya Smart APP

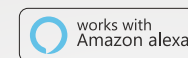

works with
Amazon alexa



works with
Google Assistant



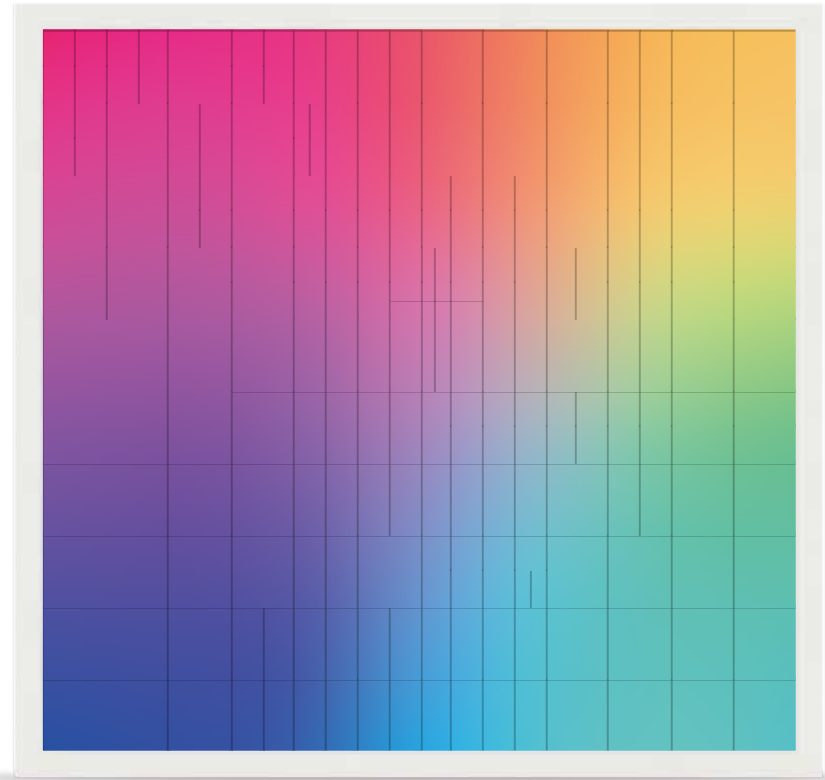

Never yellowing, long lifespan

LEDs covered with lens, never turn dark or yellowish at the middlepart.

Processed by electrostatic dusting

Bottom of the back cover is produced by stamping structure, which can effectively guarantee the appearance of the product, the surface is processed by electrostatic dusting.

Energy savings of up to 90%

Energy-saving percentage (compared with traditional type)
With energy savings of up to 90% than incandescent light.

DIY colors + CCT adjustment

The smart panel light supports warm white and cool white from 3000K to 6500K, and R,G,B mixed colors, totally can provide 16 million different colors.

16 Million Colors



Warm White to Daylight



Brightness adjustment

5%-100% smooth dimming, infinitely switchable.

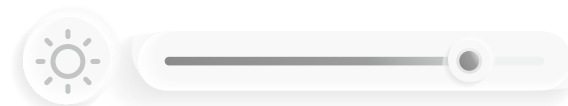

Parameters CE for EU



100LPW Series

Product name	Color	Power	Beam angle(°)	LEDs type	CRI	PF	Voltage
595*595mm	6000-6500K	36W	110°	SMD2835	Ra>80	>0.9	220-240VAC 50/60Hz
	3000-3300K	36W					
	Red	5W					
	Green	4.5W					
	Blue	4.5W					
RGB	7W						
295*1195mm	6000-6500K	36W	110°	SMD2835	Ra>80	>0.9	220-240VAC 50/60Hz
	3000-3300K	36W					
	Red	5W					
	Green	4.5W					
	Blue	4.5W					
RGB	7W						

Unit:mm

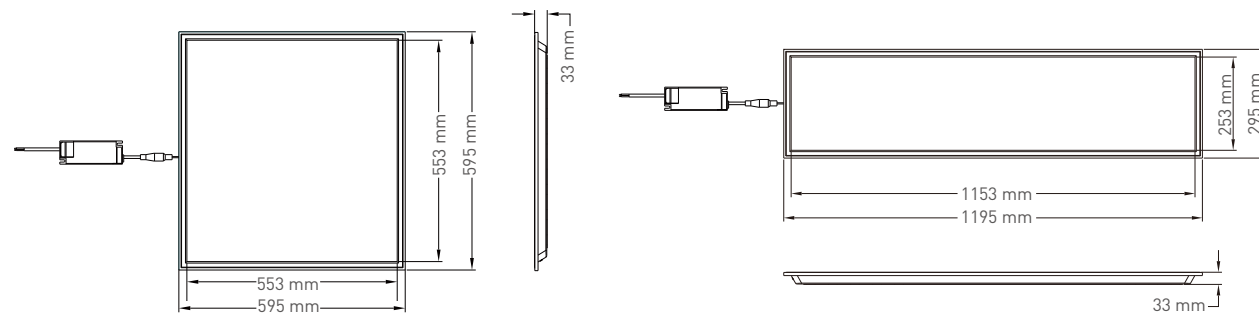

Package

Product size	Inner size	Carton size	Pack Quantity	Net weight	Gross weight
595*595mm	650*650*50mm	675*675*275mm	5PCS	1.8 kg	12.5 kg
295*1195mm	1250*330*50mm	1275*355*275mm	5PCS	1.85 kg	12.8 kg



Application

Suitable for hotels, meeting rooms, factories, offices, commercial purposes, residential, institution buildings, schools, hospitals, etc.

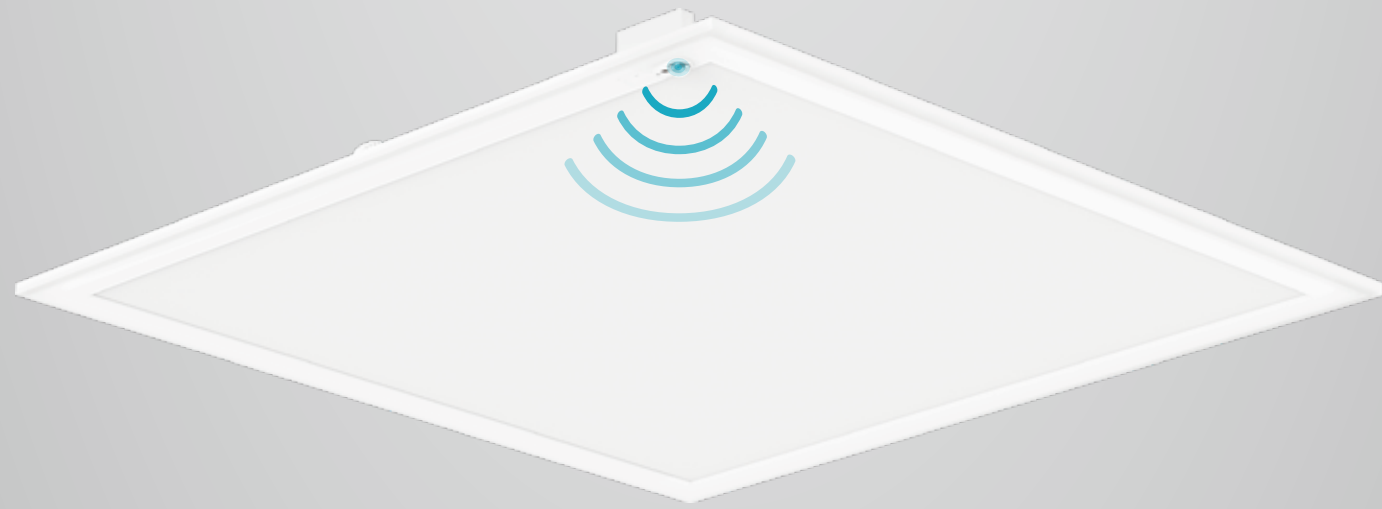

PIR sensor panel light

edge-lit series

PIR sensor panel light, with beautiful and generous appearance, and PIR sensor, realizes intelligent power reduction. Sensor can be easily disassembled and assembled due to the structural design, so customers can choose and match freely.

Optional sensor and non-sensor.

Customers can choose sensor or non-sensor, easy to switch.



PIR sensor



Non-sensor



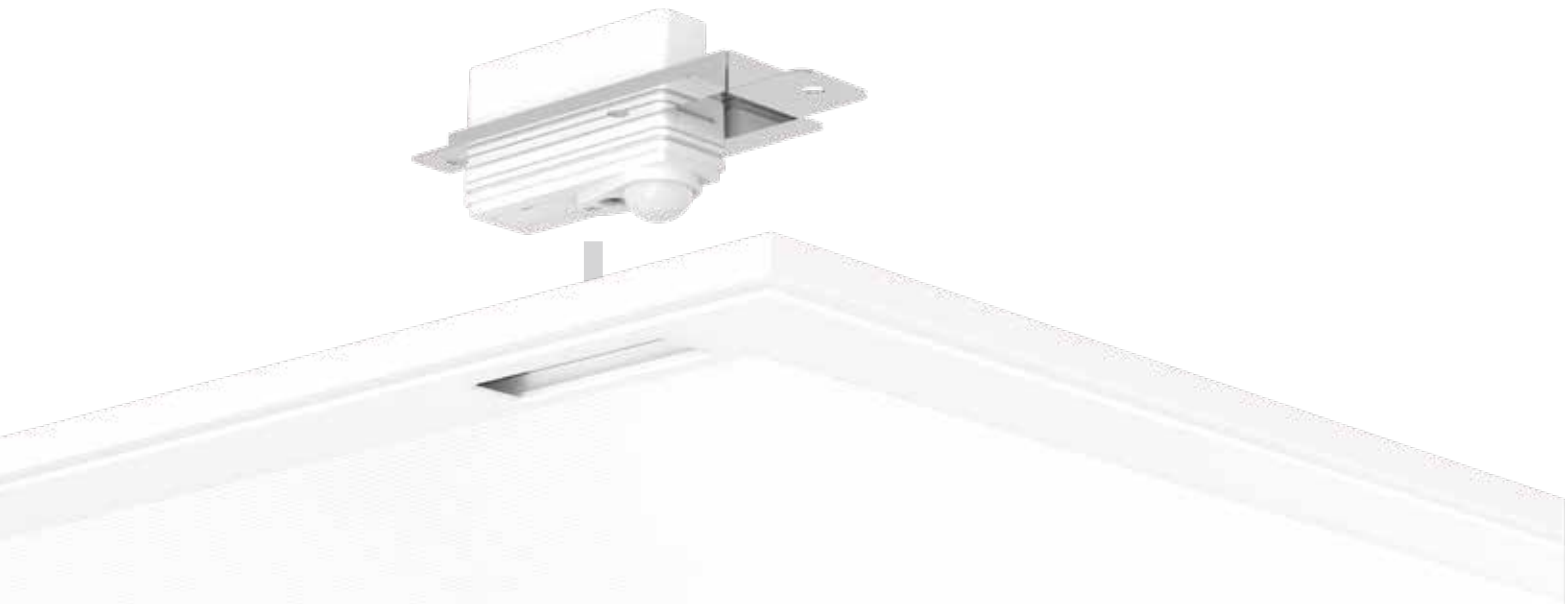

High-efficient thermal design

High-efficient thermal management design, LEDs and power supply work in low temperature, high stability of continuous working.



Easy sensor installation

It's easy to switch between sensor and non-sensor because of the upper and lower clamping structure and notches on both ends of the cover.

Anti-yellowing

PMMA LGP, Edge-lit structure, more uniform and softer light.

Intelligent control

The IR remote control can be used for light setting.



RAL9003 white lamp body

RAL9003 white lamp body, modern and simple design.

Daylight harvesting function

Intelligently lower the power to ensure the constant lux, power saving.

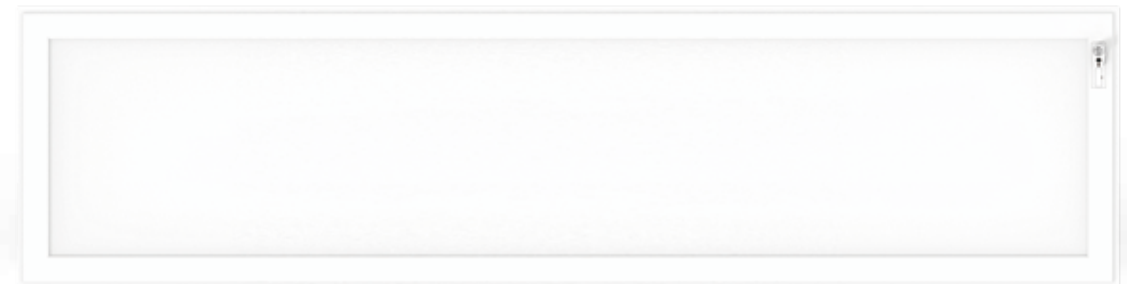

Parameters



Product size	CCT	Lumen(lm)	Beam angle(°)	LEDs type	CRI	PF	Power(W)	Voltage
595*595mm	6000-6500K	4000	110°	SMD4014	Ra>80	>0.9	40W	220-240VAC 50/60Hz
	3800-4200K	4000						
	2800-3200K	3600						
295*1195mm	6000-6500K	4000	110°	SMD4014	Ra>80	>0.9	40W	220-240VAC 50/60Hz
	3800-4200K	4000						
	2800-3200K	3600						
595*1195mm	6000-6500K	5000	110°	SMD4014	Ra>80	>0.9	50W	220-240VAC 50/60Hz
	3800-4200K	5000						
	2800-3200K	4500						

Unit:mm

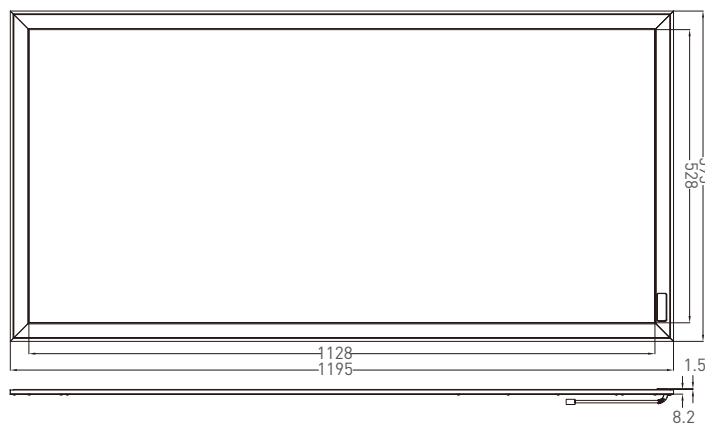
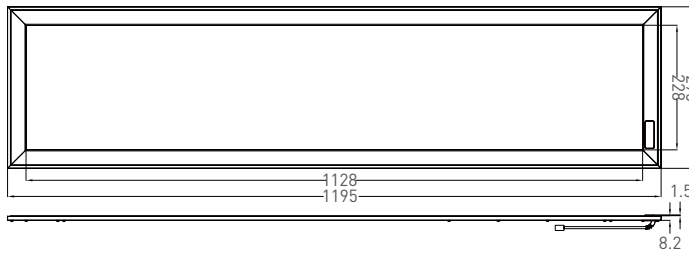
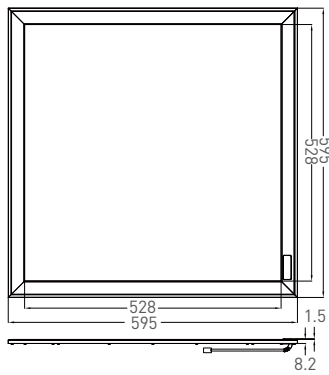

Package

Product size	Inner size	Carton size	Pack Quantity	Net weight	Gross weight
595*595mm	680*636*38mm	715*650*285mm	1 PC/inner box 6 inner boxes/carton	2.40 kg	18.12 kg
295*1195mm	1235*380*38mm	1250*285*415mm	1 PC/inner box 6 inner boxes/carton	2.61 kg	19.67 kg
595*1195mm	1254*694*42mm	1275*110*715mm	2 PC/inner box 2 inner boxes/carton	4.66 kg	23.64 kg

Installation

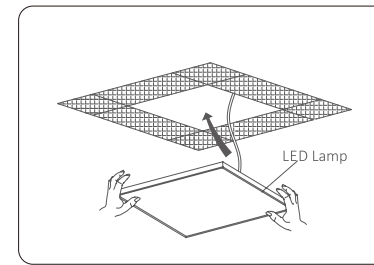

Embedded Installation

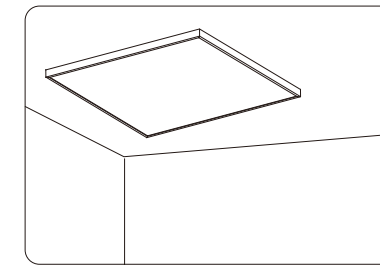

Surface Installation

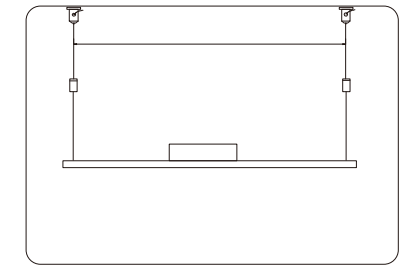

Suspension Installation

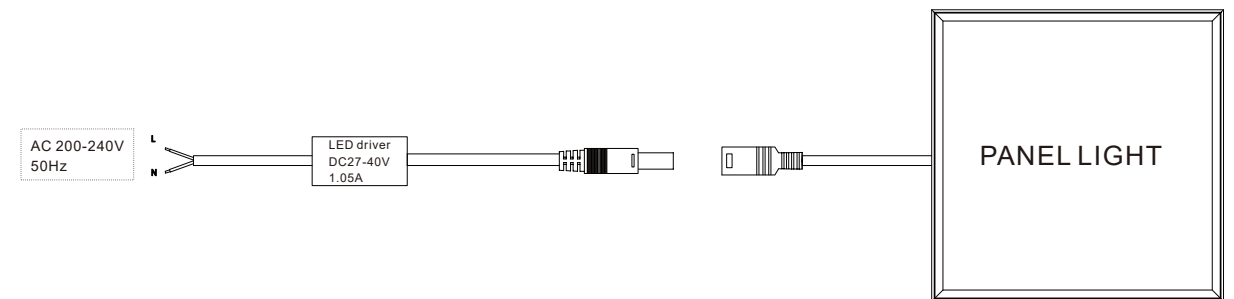

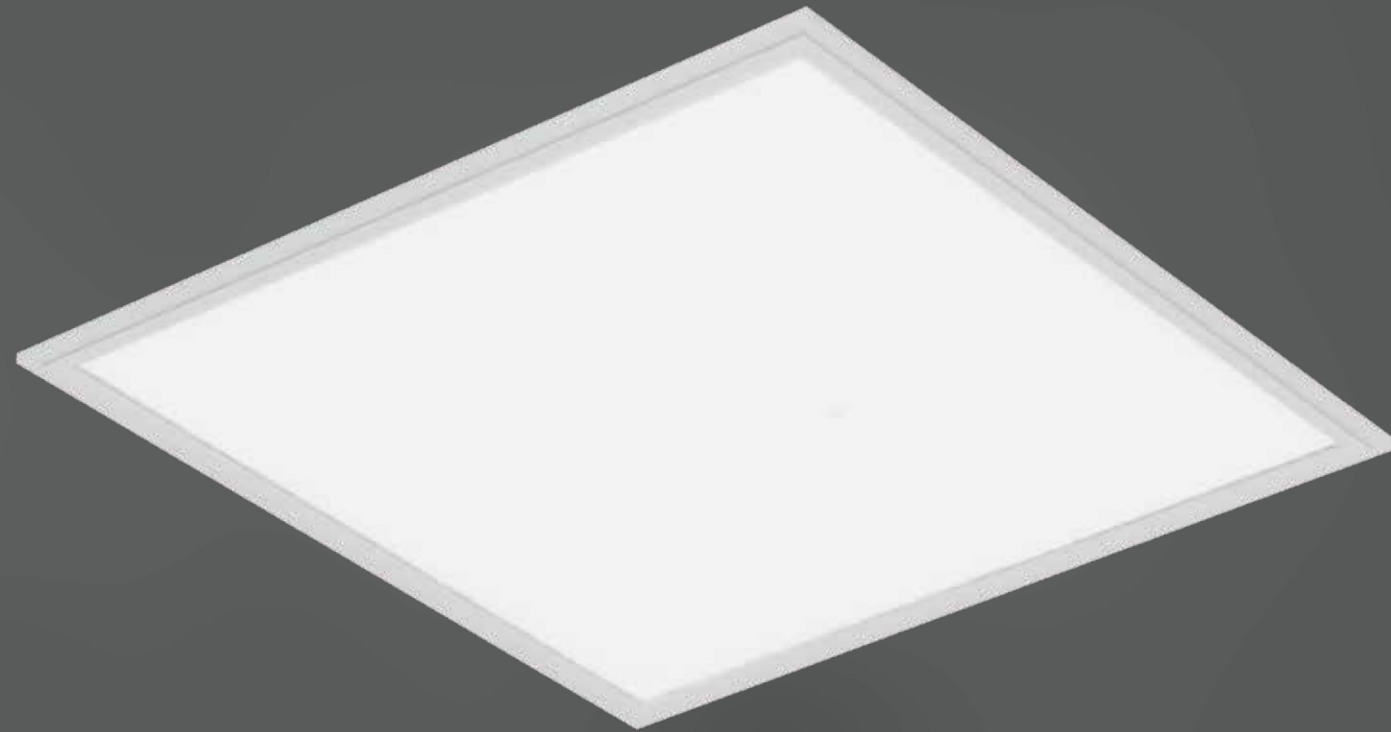

Wattage adjustable & 3CCT tunable panel light

Edge-lit series

It is the latest new generation of edge-lit lighting fixture, which has the uniform and smooth lighting effect and elegant appearance design. Each fixture is 15 SKUS in 1 unit design, so the users can easily set the wattage and color temperature that they want.

Power adjustable

Simply open the driver cover, you can set the different current by dialing the buttons inside the driver, power adjustment 20W-60W.



Color tunable

Adjust the 3-position slide switch with your fingers for different color temperature, color temperature setting: 3500K, 4000K, 5000K.

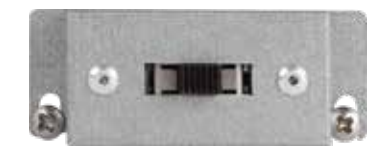
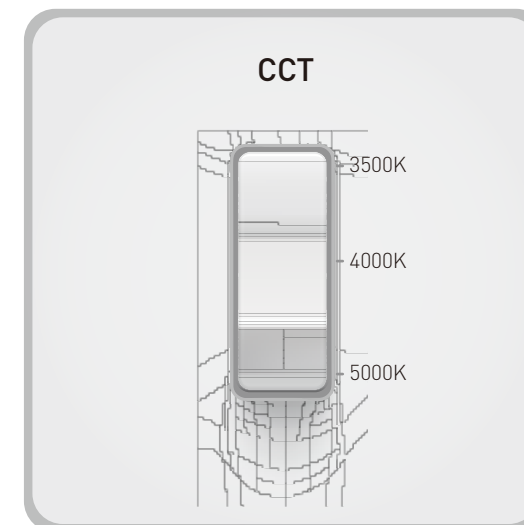

transmission
>90%

High transmission LGP

High transmission LGP (more than 90%), high lumen LED efficacy paired with high power factor drivers.

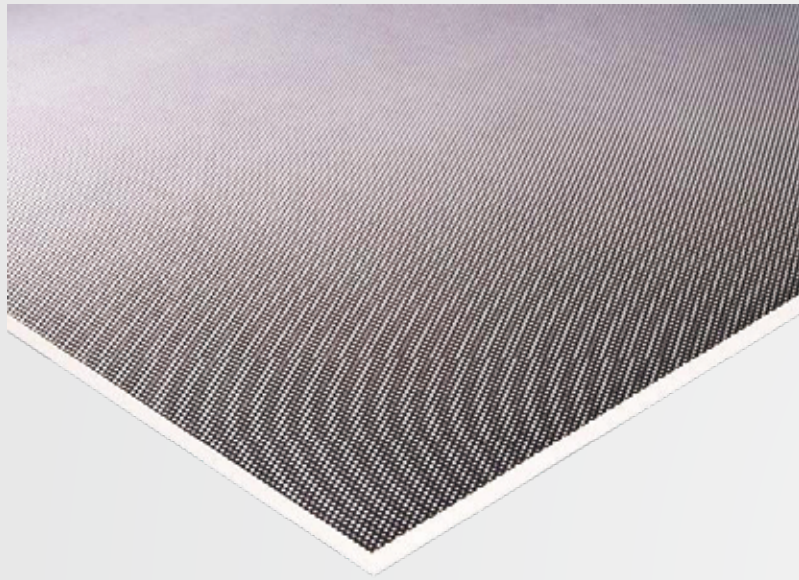

uniformity
>85%

Visual uniformity

Using high quality LGP with silk printing technology, the light uniformity rate is greater than 85%. No yellow edge and dark area, perfect lighting effect.



High efficiency up to 130LPW

High efficiency up to 130LPW, different versions available.



3-in-1 dimming

3-in-1 dimming mode:0-10V, PWM, Rx. Smoothly dimming 0-100%,can dim to off.

Flicker free LED driver

Constant current design, PF>0.9,THD<15%.



1KV surge protection

Short circuit, open circuit protection,and 1KV surge protection.



Installation

Each panel with standard clips for recessed and suspending installation. Optional surface mounted kit available.

1. Drill Holes

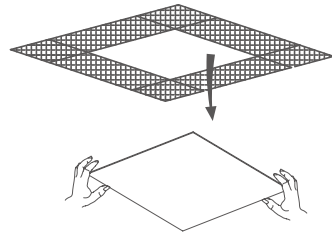

2. Open the power supply

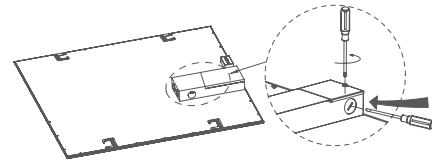

3. Rotate the hook

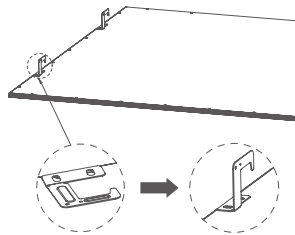

4. Connect the input wire and fix cover of power supply

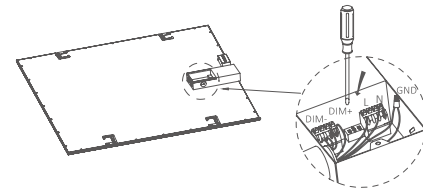

5. Swipe the DIP switch on the back to position of corresponding color temperature

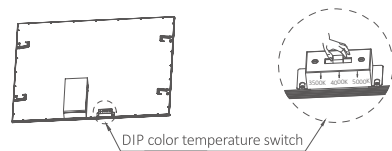

6. Top cover of power supply

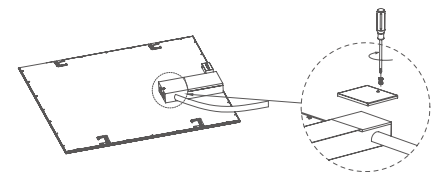

7. Put the lamp into the ceiling

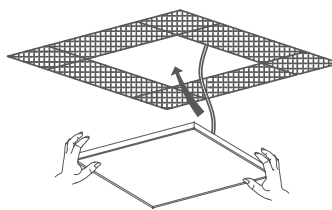

8. Finish installation

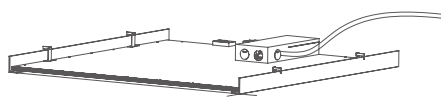

Parameters



105LPW series

Product size	CCT	Power(W)	LEDs type	CRI	Voltage	Color tunable selectable way
2*2FT	3500K-4000K-5000K	20W/25W/30W/35W/40W	SMD4014	Ra>80	100-277VAC 50/60Hz	DIP switch
1*4FT	3500K-4000K-5000K	20W/25W/30W/35W/40W	SMD4014	Ra>80	100-277VAC 50/60Hz	DIP switch
2*4FT	3500K-4000K-5000K	30W/35W/40W/45W/50W	SMD4014	Ra>80	100-277VAC 50/60Hz	DIP switch
2*4FT	3500K-4000K-5000K	40W/45W/50W/55W/60W	SMD4014	Ra>80	100-277VAC 50/60Hz	DIP switch
2*2FT	3500K-4000K-5000K	20W/25W/30W/35W/40W	SMD4014	Ra>80	100-277VAC 50/60Hz	Wall switch 0-10V dimmer
1*4FT	3500K-4000K-5000K	20W/25W/30W/35W/40W	SMD4014	Ra>80	100-277VAC 50/60Hz	Wall switch 0-10V dimmer
2*4FT	3500K-4000K-5000K	30W/35W/40W/45W/50W	SMD4014	Ra>80	100-277VAC 50/60Hz	Wall switch 0-10V dimmer
2*4FT	3500K-4000K-5000K	40W/45W/50W/55W/60W	SMD4014	Ra>80	100-277VAC 50/60Hz	Wall switch 0-10V dimmer

130LPW series

Product size	CCT	Power(W)	LEDs type	CRI	Voltage	Color tunable selectable way
2*2FT	3500K-4000K-5000K	20W/25W/30W/35W/40W	SMD4014	Ra>80	100-277VAC 50/60Hz	DIP switch
1*4FT	3500K-4000K-5000K	20W/25W/30W/35W/40W	SMD4014	Ra>80	100-277VAC 50/60Hz	DIP switch
2*4FT	3500K-4000K-5000K	30W/35W/40W/45W/50W	SMD4014	Ra>80	100-277VAC 50/60Hz	DIP switch
2*4FT	3500K-4000K-5000K	40W/45W/50W/55W/60W	SMD4014	Ra>80	100-277VAC 50/60Hz	DIP switch
2*2FT	3500K-4000K-5000K	20W/25W/30W/35W/40W	SMD4014	Ra>80	100-277VAC 50/60Hz	Wall switch 0-10V dimmer
1*4FT	3500K-4000K-5000K	20W/25W/30W/35W/40W	SMD4014	Ra>80	100-277VAC 50/60Hz	Wall switch 0-10V dimmer
2x4FT	3500K-4000K-5000K	30W/35W/40W/45W/50W	SMD4014	Ra>80	100-277VAC 50/60Hz	Wall switch 0-10V dimmer
2x4FT	3500K-4000K-5000K	40W/45W/50W/55W/60W	SMD4014	Ra>80	100-277VAC 50/60Hz	Wall switch 0-10V dimmer

Package

Product size	Inner size	Carton size	Pack Quantity	Net weight	Gross weight
2*2FT	25.55*25.47*4.25inch	26.38*26.57*9.45inch	2 PCS/inner box 2 inner boxes/carton	6.61 lb	33.07 lb
1*4FT	49.45*13.74*4.25inch	50.39*9.45*14.76inch	2 PCS/inner box 2 inner boxes/carton	6.61 lb	37.48 lb
2*4FT	49.41*25.47*3.7inch	50.79*26.77*8.66inch	2 PCS/inner box 2 inner boxes/carton	13.23 lb	61.73 lb

Wattage adjustable & 3CCT tunable flat panel light

Back-lit series

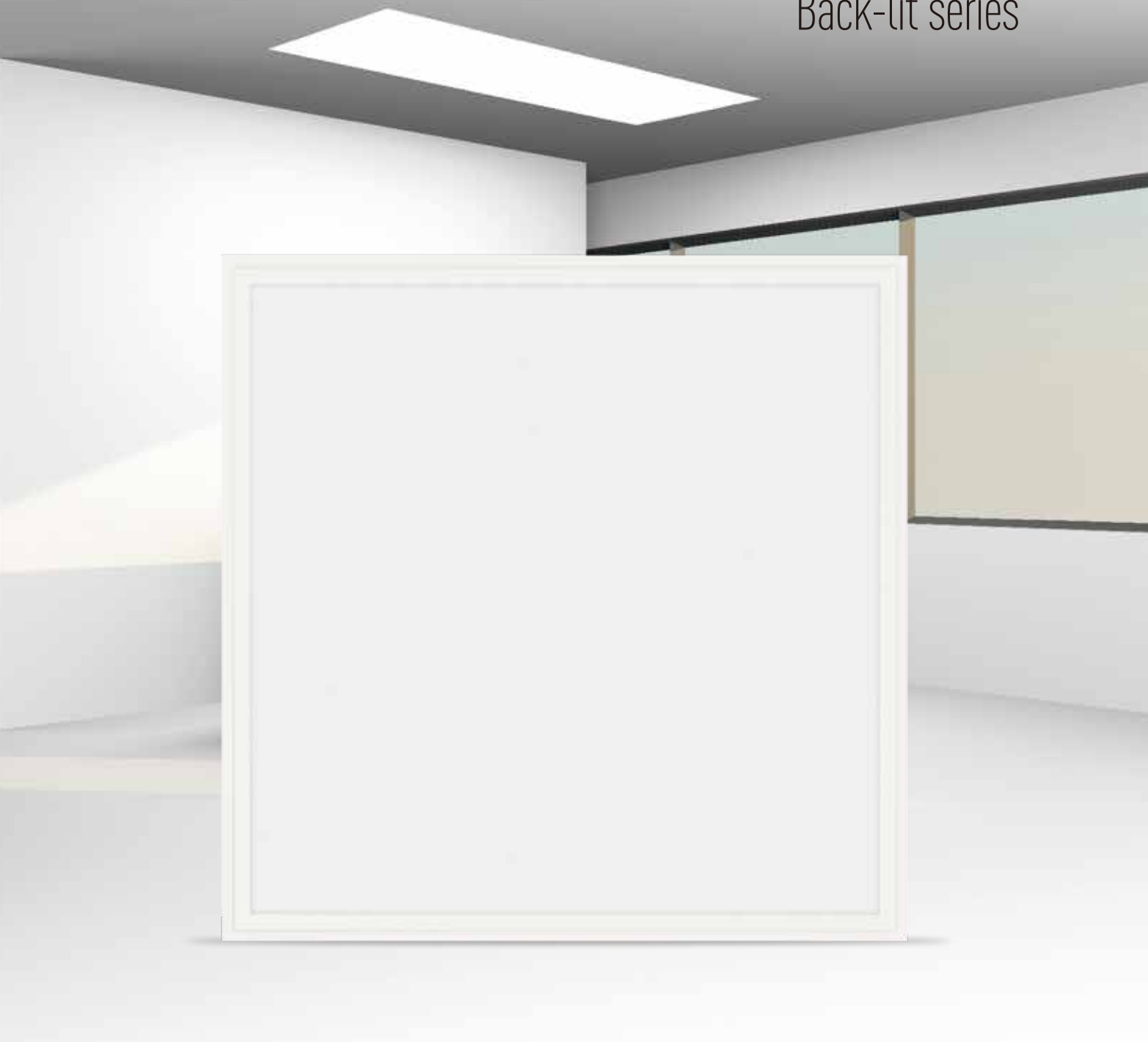

Wattage adjustable

One piece wattage adjustable and color tunable panel light=9 pcs regular panel light now, it can save the shipping time, warehouse space and your stock cost.

2*2Feet: 26W/30W/40W
1*4Feet: 26W/30W/40W
2*4Feet: 30W/40W/50W

Color tunable

Color temperature setting: 3500K, 4000K, 5000K



High efficiency

High transmission back-lit (more than 85%), high lumen LED efficacy paired with high power factor drivers.

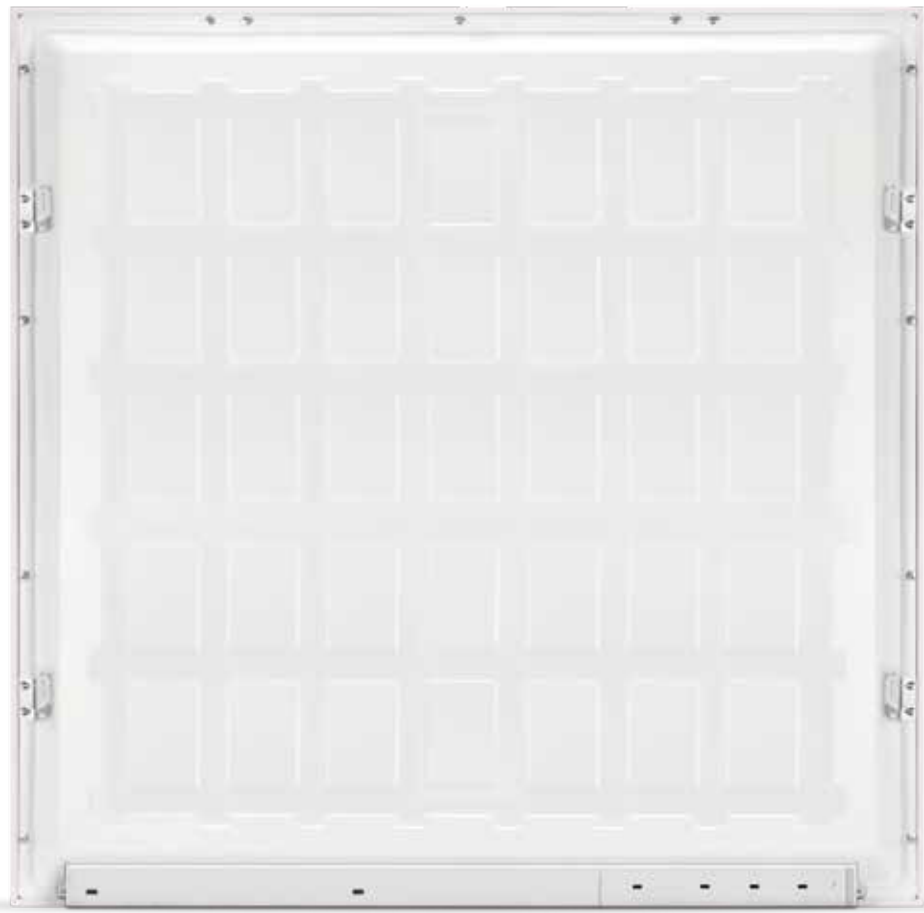
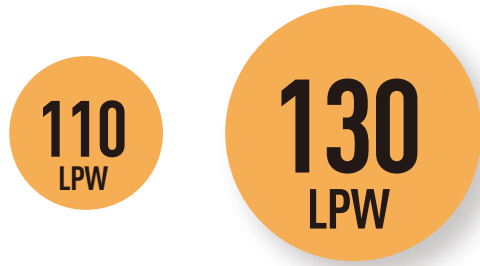

Dimensions (unit: mm/feet)

2 * 2 feet

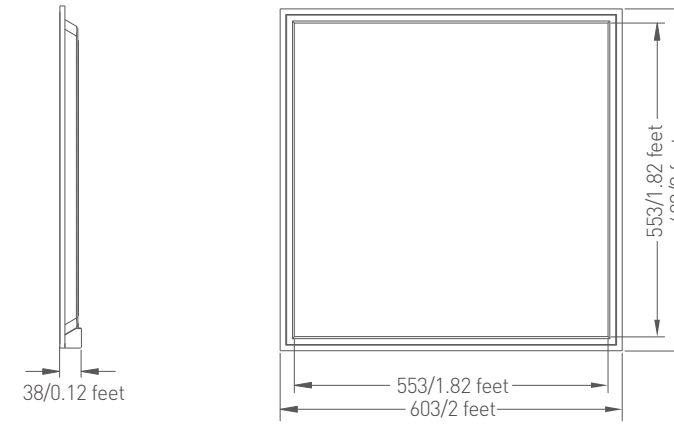

1 * 4 feet

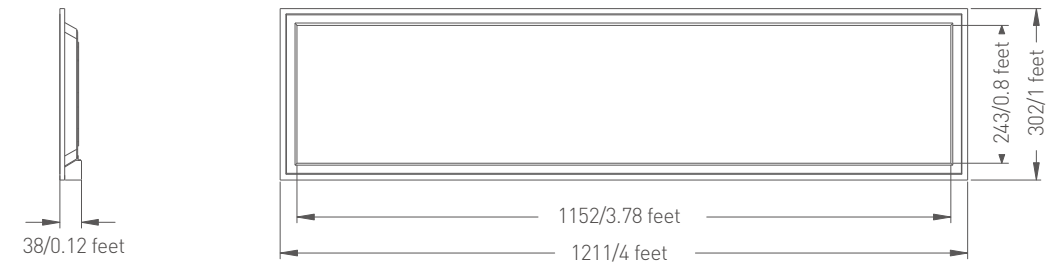

2 * 4 feet



Parameters



110LPW Series

Product size	CCT	Lumen(lm)	Beam angle(°)	LEDs type	CRI	PF	Power(W)	Voltage
2*2FT	5000K 4000K 3500K	2860/3300/4400	110°	SMD2835	Ra > 80	> 0.95	26/30/40W	100-277VAC 50/60Hz
1*4FT	5000K 4000K 3500K	2860/3300/4400	110°	SMD2835	Ra > 80	> 0.95	26/30/40W	100-277VAC 50/60Hz
2*4FT	5000K 4000K 3500K	3300/4400/5500	110°	SMD2835	Ra > 80	> 0.95	30/40/50W	100-277VAC 50/60Hz

130LPW Series

Product size	CCT	Lumen(lm)	Beam angle(°)	LEDs type	CRI	PF	Power(W)	Voltage
2*2FT	5000K 4000K 3500K	3380/3900/5200	110°	SMD2835	Ra > 80	> 0.95	26/30/40W	100-277VAC 50/60Hz
1*4FT	5000K 4000K 3500K	3380/3900/5200	110°	SMD2835	Ra > 80	> 0.95	26/30/40W	100-277VAC 50/60Hz
2*4FT	5000K 4000K 3500K	3900/5200/6500	110°	SMD2835	Ra > 80	> 0.95	30/40/50W	100-277VAC 50/60Hz

Package

Product size	Inner size	Carton size	Pack Quantity	Net weight	Gross weight
2*2FT	25.6*25.5*4.3inch	26.4*26.6*9.4inch	2 PCS/inner box 2 pcs/carton	6.6 lb	33.1 lb
1*4FT	49.4*13.7*4.3inch	50.4*14.8*9.4inch	2 PCS/inner box 2 pcs/carton	6.6 lb	37.5 lb
2*4FT	49.4*25.5*3.7inch	50.8*26.8*8.7inch	2 PCS/inner box 2 pcs/carton	13.2 lb	61.7 lb



3CCT tunable series

LED panel light is the latest new generation of edge-lit lighting fixture, which has the uniform and smooth lighting effect and elegant appearance design. Each fixture is 3 SKUS in 1 unit design, so the users can easily set the wattage and color temperature that they want.

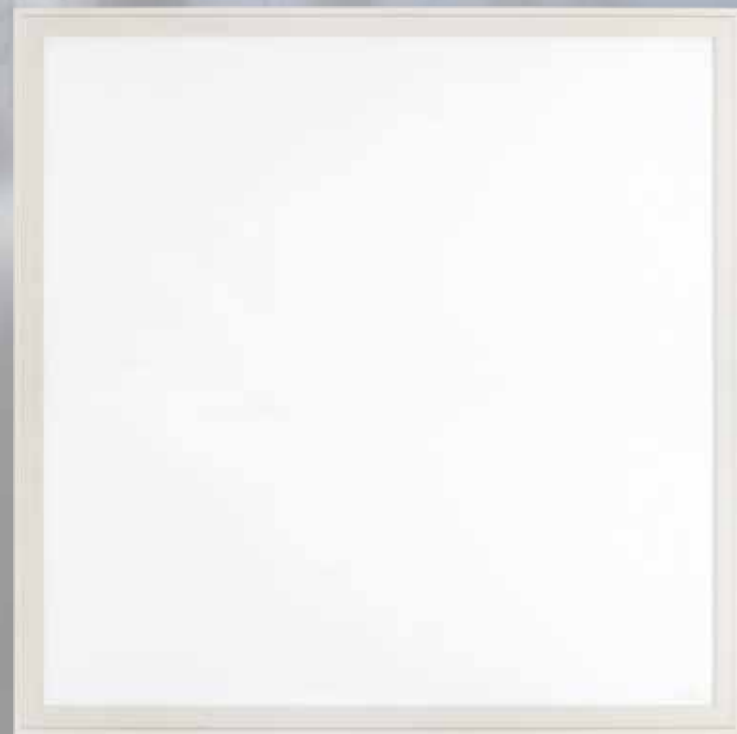

CCT tunable

Adjust the 3-position slide switch with your fingers for different color temperature, color temperature setting: 3000K, 4000K, 6000K.

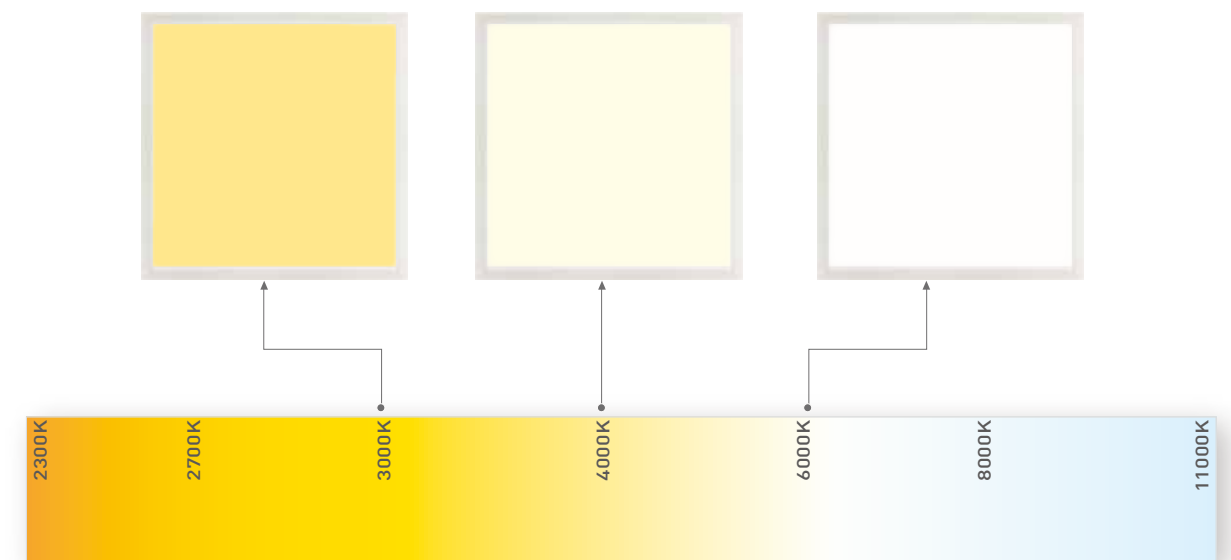
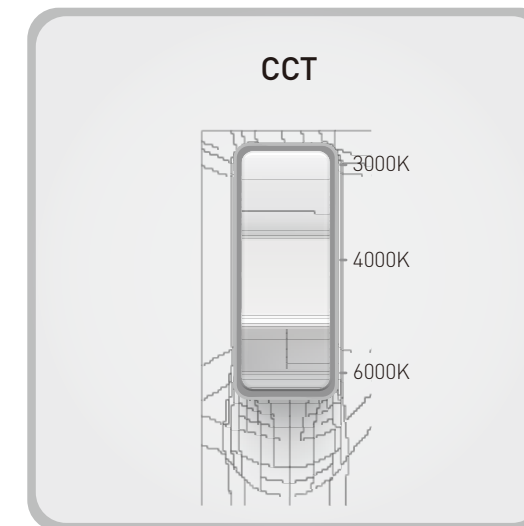



Application

Color adjustable series Square Panel Light can be used in hotels, meeting rooms, factories, offices, commercial purposes, residential institution buildings, schools, hospitals, places which needs energy saving and high color rendering index lighting.



High transmission LGP

High transmission LGP (more than 90%), high lumen LED efficacy paired with high power factor drivers.

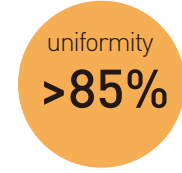

Flicker free LED driver

Constant current design, PF>0.9, THD<15%.

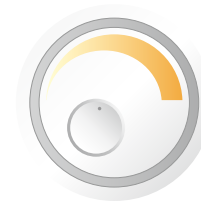

3-in-1 dimming

3-in-1 dimming mode:0-10V, PWM, Rx. Smoothly dimming 0-100%, can dim to off.

1KV surge protection

Short circuit, open circuit protection, and 1KV surge protection.

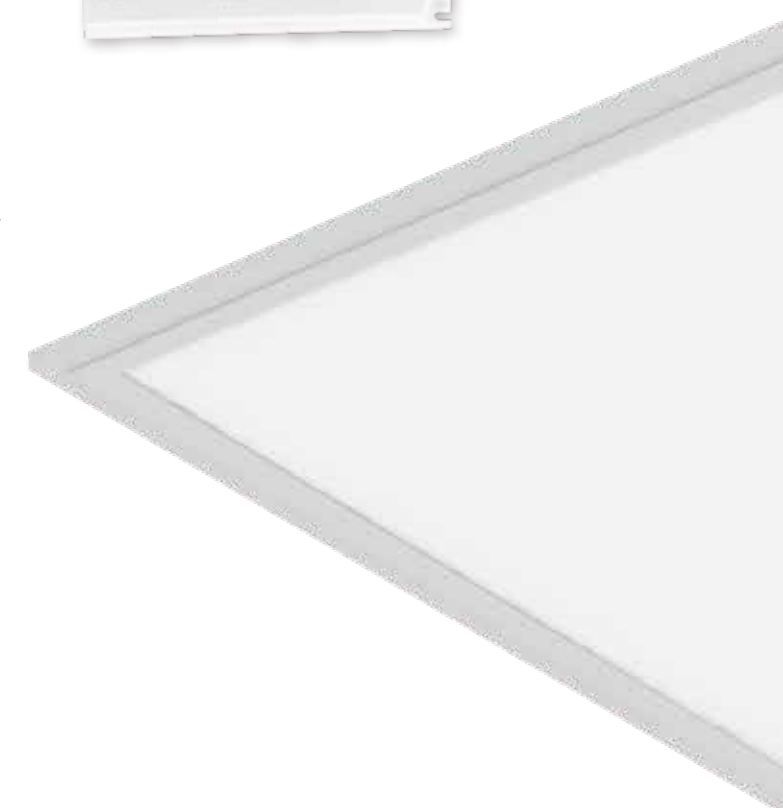

Installation

Each panel with standard clips for recessed and suspension installation. Optional surface mounted kit available.

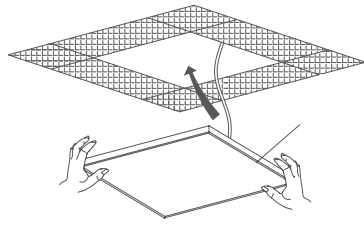

Recessed installation

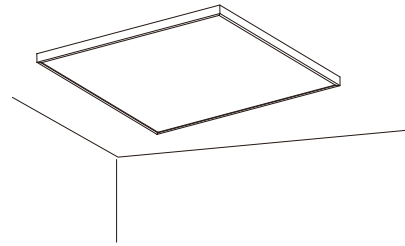

Surface installation

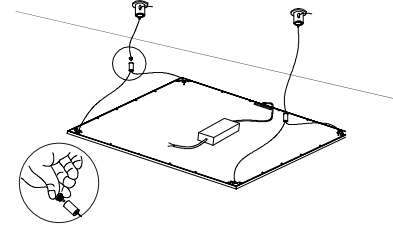

Suspension installation

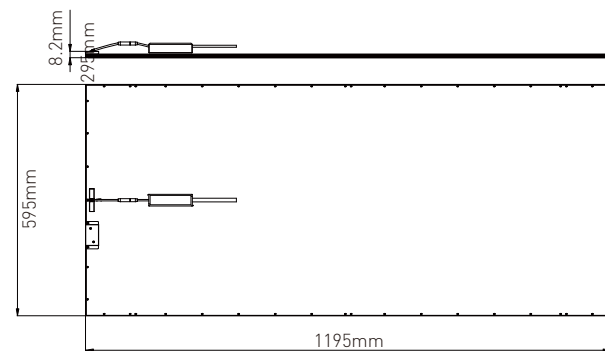
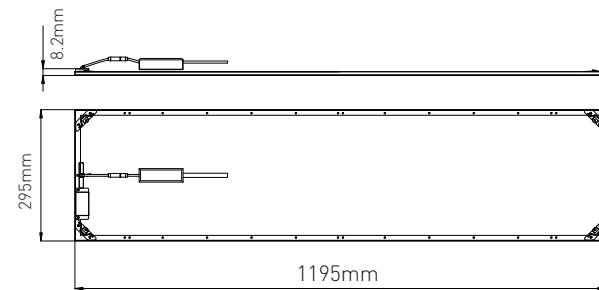
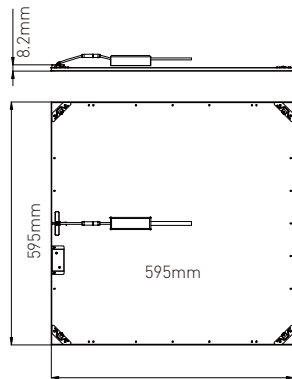

Parameters CE for EU



80-90LPW

Product size	CCT	Power(W)	LEDs type	CRI	Voltage	Color tunable selectable way
595*595mm	3000K-4000K-6000K	40W	SMD4014	Ra>80	200-240VAC 50/60Hz	DIP switch
295*1195mm	3000K-4000K-6000K	40W	SMD4014	Ra>80	200-240VAC 50/60Hz	DIP switch
595*1195mm	3000K-4000K-6000K	50W	SMD4014	Ra>80	200-240VAC 50/60Hz	DIP switch
595*595mm	3000K-4000K-6000K	40W	SMD4014	Ra>80	200-240VAC 50/60Hz	Wall switch
295*1195mm	3000K-4000K-6000K	40W	SMD4014	Ra>80	200-240VAC 50/60Hz	Wall switch
595*1195mm	3000K-4000K-6000K	50W	SMD4014	Ra>80	200-240VAC 50/60Hz	Wall switch

Package

Product size	Inner size	Carton size	Pack Quantity	Net weight	Gross weight
595*595mm	680*636*38mm	650*285*715mm	1 PC/inner box 6 inner boxes/carton	2.395 kg	18.12 kg
295*1195mm	1235*380*38mm	1250*285*415mm	1 PC/inner box 6 inner boxes/carton	2.605 kg	19.69 kg
595*1195mm	1254*694*42mm	1275*110*715mm	2 PCS/inner box 2 inner boxes/carton	4.66 kg	23.64 kg

Super slim back-lit series



Produced by stamping structure

Bottom of the back cover is produced by stamping structure, which can effectively guarantee the appearance of the product.

Super slim driver

With super slim 0-10V driver, assembled at the side of the frame, freight cost saving.

Replaceable power supply

Lamp and power supply is connected by pulling-resistant male connector and female connector to facilitate the replace of power supply.



Application

The product can be used in office, hotel, shopping mall, office building, hospital and other places that require long warranty period.



Aluminum alloy material

Lamp body material: Aluminum alloy + iron + PS.

Energy savings of up to 90%

Energy-saving percentage (compared with traditional type)
With energy savings of up to 90% than incandescent light.

High efficiency up to 125LPW

Lighting effect: High efficiency up to 125LPW, different versions available.

More uniform light

High-haze diffusion plate effectively breaks up the light sent forth from the lamp, making the light more uniform.

Parameters ETL for US



105LPW Series

Product size	CCT	Lumen(lm)	Beam angle(°)	LEDs type	CRI	PF	Power(W)	Voltage
1*4FT	● 5000K ● 4000K ● 3000K	4200	110°	SMD2835	Ra>80	>0.9	40W	100-277VAC 50/60Hz
2*2FT	● 5000K ● 4000K ● 3000K	4200	110°	SMD2835	Ra>80	>0.9	40W	100-277VAC 50/60Hz
2*4FT	● 5000K ● 4000K ● 3000K	5040	110°	SMD2835	Ra>80	>0.9	40W	100-277VAC 50/60Hz

125LPW Series

Product size	CCT	Lumen(lm)	Beam angle(°)	LEDs type	CRI	PF	Power(W)	Voltage
1*4FT	● 5000K ● 4000K ● 3000K	5000	110°	SMD2835	Ra>80	>0.9	40W	100-277VAC 50/60Hz
2*2FT	● 5000K ● 4000K ● 3000K	5000	110°	SMD2835	Ra>80	>0.9	40W	100-277VAC 50/60Hz
2*4FT	● 5000K ● 4000K ● 3000K	5000	110°	SMD2835	Ra>80	>0.9	40W	100-277VAC 50/60Hz
2*4FT	● 5000K ● 4000K ● 3000K	6000	110°	SMD2835	Ra>80	>0.9	48W	100-277VAC 50/60Hz

Unit:inch

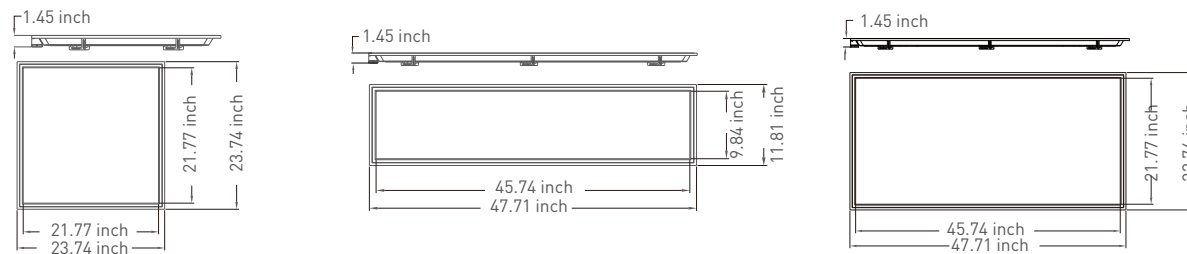

Package

Product size	Inner size	Carton size	Pack Quantity	Net weight	Gross weight
2*2FT	25.55 *25.47*4.33 inch	26.38*26.57*9.45 inch	2 PCS/inner box 2 inner boxes/carton	5.07 lb	24.25 lb
1*4FT	49.45*13.74*4.33 inch	50.39*14.76*9.45 inch	2 PCS/inner box 2 inner boxes/carton	5.07 lb	25.79 lb
2*4FT	49.21 *25.59*4.72 inch	50.39*26.57*9.45 inch	2 PCS/inner box 2 inner boxes/carton	8.82 lb	45.19 lb

Parameters CE for EU



100LPW Series

Product size	CCT	Lumen(lm)	Beam angle(°)	LEDs type	CRI	PF	Power(W)	Voltage
595*595mm	● 6000-6500K ● 3800-4200K ● 2800-3200K	3600 4000 4000	110°	SMD2835	Ra>80	>0.9	40W	220-240VAC 50/60Hz
295*1195mm	● 6000-6500K ● 3800-4200K ● 2800-3200K	3600 4000 4000	110°	SMD2835	Ra>80	>0.9	40W	220-240VAC 50/60Hz
595*1195mm	● 6000-6500K ● 3800-4200K ● 2800-3200K	4500 5000 5000	110°	SMD2835	Ra>80	>0.9	50W	220-240VAC 50/60Hz

Unit:mm

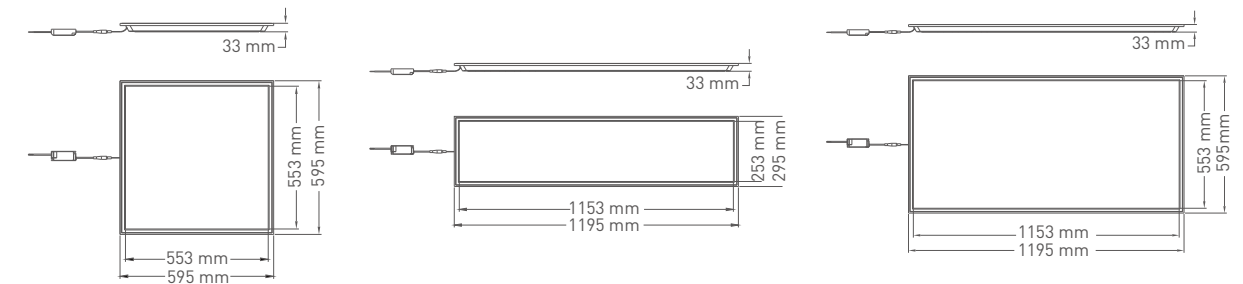

Package

Product size	Inner size	Carton size	Pack Quantity	Net weight	Gross weight
595*595mm	650*50*630mm	675*275*675mm	1 PC/inner box 5 inner boxes/carton	1.8 kg	13 kg
295*1195mm	330*1250*50mm	1275*275*355mm	1 PC/inner box 5 inner boxes/carton	1.85 kg	14 kg
595*1195mm	630*1250*50mm	1275*275*655mm	1 PC/inner box 4 inner boxes/carton	3.4 kg	19 kg

Super slim edge-lit series

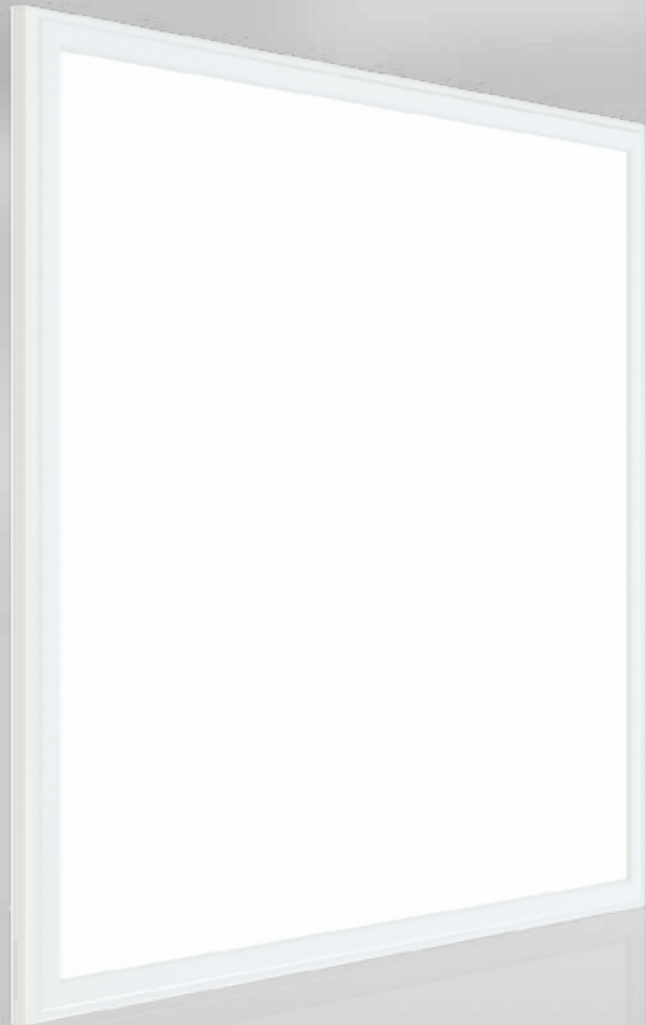

Super slim and lighter

Around 0.39inch lamp body with very light weight, space and transportation cost saving



Visual uniformity

The edge-lit LED panels blend with various ceiling details and produce soft natural light.

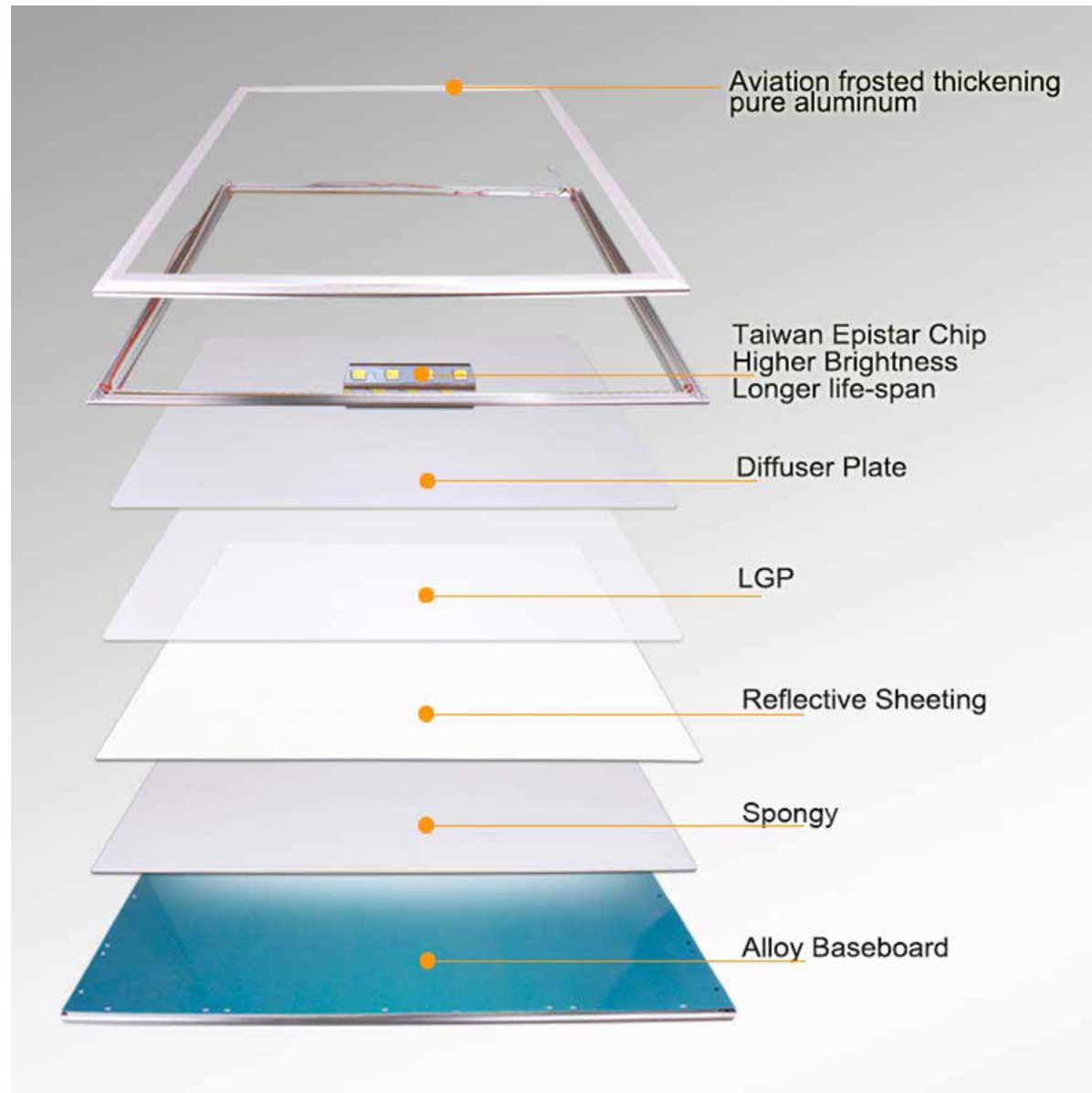

Luminaire construction

A powder coat painted extruded aluminum frame encompasses the perimeter of multi-layered acrylic panelsystem. The fireproof metal junction box is attached at the backside of the panel light.

Low glare lighting

The edge mounted LEDs give even glare free special illumination. It produces a comfortable lighting environment.



High lumen

High lumen LED efficacy paired with high power factor drivers reduce operating cost.

Long life span

More than 50,000 hours life time and 5 years warranty.

Cost and energy saving

50% more energy saving effect than fluorescent tubes

Low heat generation, extra energy saving effect through reduction of HVAC load.

Easy installation: only 3 steps in 2 minutes, labor cost saving.

Parameters



100LPW Series

Product size	CCT	Lumen(lm)	Beam angle(°)	LEDs type	CRI	PF	Power(W)	THD	Voltage
2*2FT	5000K	4040	110°	SMD4014	Ra>80	>0.9	40W	<20	100-277VAC 50/60Hz
	4500K	4080							
	4000K	4080							
	3500K	4000							
	3000K	4000							
	2700K	4000							
1*4FT	5000K	4040	110°	SMD4014	Ra>80	>0.9	40W	<20	100-277VAC 50/60Hz
	4500K	4080							
	4000K	4080							
	3500K	4000							
	3000K	4000							
	2700K	4000							
2*4FT	5000K	5050	110°	SMD4014	Ra>80	>0.9	50W	<20	100-277VAC 50/60Hz
	4500K	5100							
	4000K	5100							
	3500K	5000							
	3000K	5000							
	2700K	5000							
2*4FT	5000K	6060	110°	SMD4014	Ra>80	>0.9	60W	<20	100-277VAC 50/60Hz
	4500K	6120							
	4000K	6120							
	3500K	6000							
	3000K	6000							
	2700K	6000							

125LPW Series

Product size	CCT	Lumen(lm)	Beam angle(°)	LEDs type	CRI	PF	Power(W)	THD	Voltage
2*2FT	5000K	2520	110°	SMD4014	Ra>80	>0.9	20W	<20	100-277VAC 50/60Hz
	4500K	2540							
	4000K	2540							
	3500K	2500							
	3000K	2500							
	2700K	2500							
2*2FT	5000K	3150	110°	SMD4014	Ra>80	>0.9	25W	<20	100-277VAC 50/60Hz
	4500K	3175							
	4000K	3175							
	3500K	3125							
	3000K	3125							
	2700K	3125							
2*2FT	5000K	3780	110°	SMD4014	Ra>80	>0.9	30W	<20	100-277VAC 50/60Hz
	4500K	3810							
	4000K	3810							
	3500K	3750							
	3000K	3750							
	2700K	3750							

Product size	CCT	Lumen(lm)	Beam angle(°)	LEDs type	CRI	PF	Power(W)	THD	Voltage
2*2FT	5000K	5040	110°	SMD4014	Ra>80	>0.9	40W	<20	100-277VAC 50/60Hz
	4500K	5080							
	4000K	5080							
	3500K	5000							
	3000K	5080							
	2700K	5000							
1*4FT	5000K	2520	110°	SMD4014	Ra>80	>0.9	20W	<20	100-277VAC 50/60Hz
	4500K	2540							
	4000K	2540							
	3500K	2500							
	3000K	2500							
	2700K	2500							
1*4FT	5000K	3780	110°	SMD4014	Ra>80	>0.9	30W	<20	100-277VAC 50/60Hz
	4500K	3810							
	4000K	3810							
	3500K	3750							
	3000K	3750							
	2700K	3750							
1*4FT	5000K	5040	110°	SMD4014	Ra>80	>0.9	40W	<20	100-277VAC 50/60Hz
	4500K	5080							
	4000K	5080							
	3500K	5000							
	3000K	5000							
	2700K	5000							
2*4FT	5000K	3780	110°	SMD4014	Ra>80	>0.9	30W	<20	100-277VAC 50/60Hz
	4500K	3810							
	4000K	3810							
	3500K	3750							
	3000K	3750							
	2700K	3750							
2*4FT	5000K	5040	110°	SMD4014	Ra>80	>0.9	40W	<20	100-277VAC 50/60Hz
	4500K	5080							
	4000K	5080							
	3500K	5000							
	3000K	5000							
	2700K	5000							
2*4FT	5000K	4410	110°	SMD4014	Ra>80	>0.9	35W	<20	100-277VAC 50/60Hz
	4500K	4445							
	4000K	4445							
	3500K	4375							
	3000K	4375							
	2700K	4375							
2*4FT	5000K	6300	110°	SMD4014	Ra>80	>0.9	50W	<20	100-277VAC 50/60Hz
	4500K	6350							
	4000K	6350							
	3500K	6250							
	3000K	6250							
	2700K	6250							
2*4FT	5000K	7560	110°	SMD4014	Ra>80	>0.9	60W	<20	100-277VAC 50/60Hz
	4500K	7620							
	4000K	7620							
	3500K	7500							
	3000K	7500							
	2700K	7500							

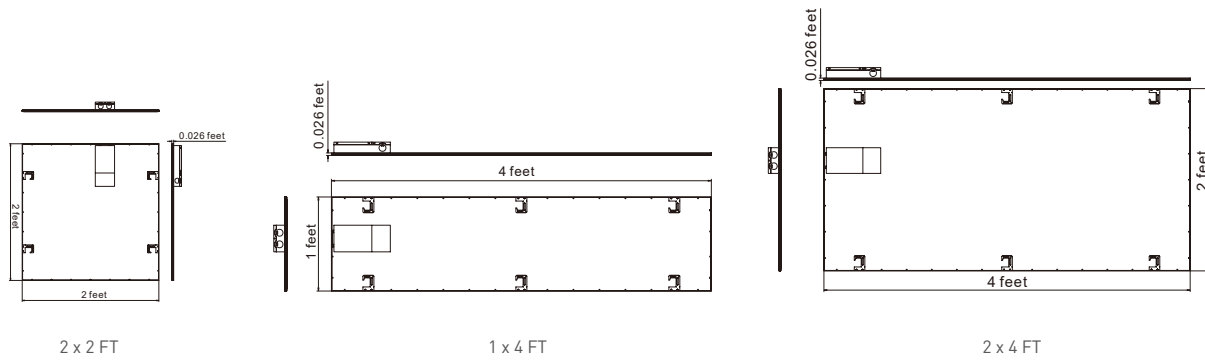

Note: All dimension tolerance is +0.5mm unless otherwise noted.

Package

Product size	Inner size	Carton size	Pack Quantity	Net weight	Gross weight
2*2FT	25.55 *25.47*4.33 inch	26.38*26.57*9.45 inch	2 PCS/inner box 2 inner boxes/carton	6.61 lb	33.07 lb
1*4FT	49.45*13.74*4.33 inch	50.39*14.76*9.45 inch	2 PCS/inner box 2 inner boxes/carton	6.61 lb	37.48 lb
2*4FT	49.21 *25.59*4.72 inch	50.39*26.57*9.45 inch	2 PCS/inner box 2 inner boxes/carton	13.23 lb	61.73 lb

Installation

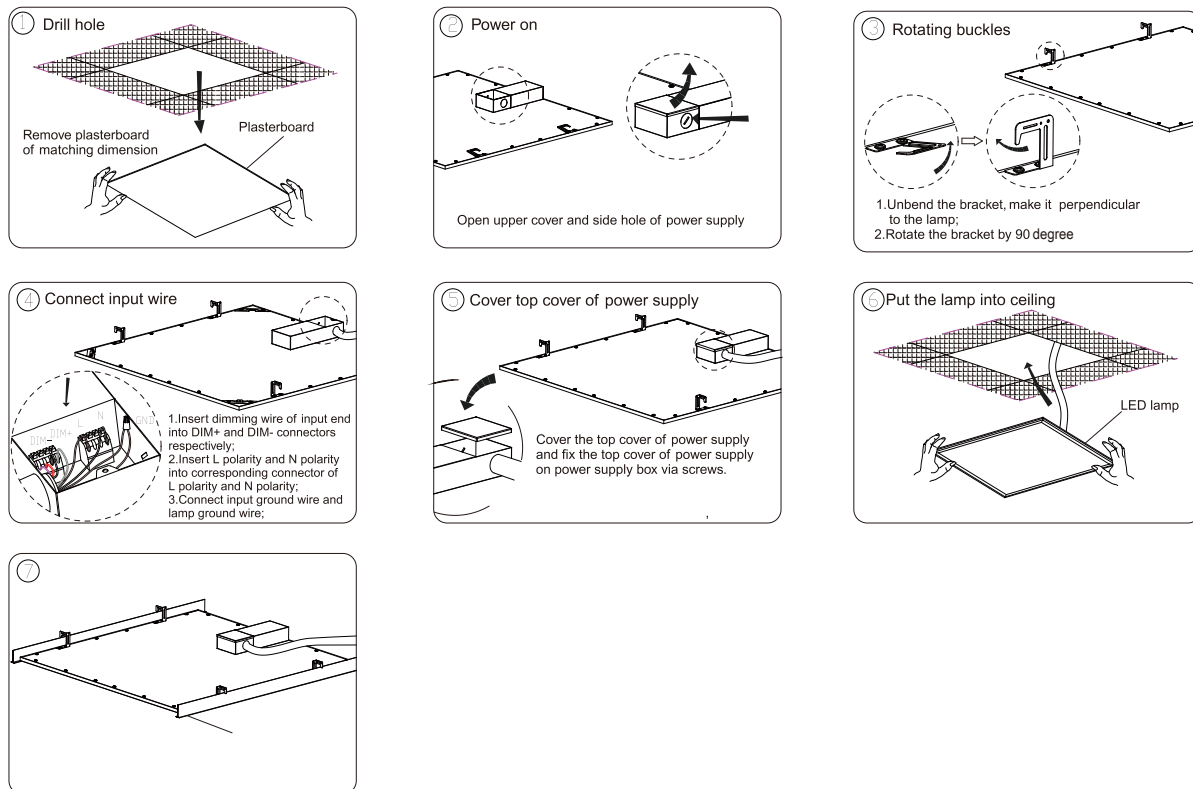

Parameters CE for EU



90LPW Series

Product size	CCT	Lumen(lm)	Beam angle(°)	LEDs type	CRI	PF	Power(W)	Voltage
295*295mm	6000-6500K	1620	110°	SMD4014	Ra>80	>0.9	18W	220-240VAC 50/60Hz
	3800-4200K	1620						
	2800-3200K	1584						
295*595mm	6000-6500K	2160	110°	SMD4014	Ra>80	>0.9	24W	220-240VAC 50/60Hz
	3800-4200K	2160						
	2800-3200K	2112						
595*595mm	6000-6500K	3600	110°	SMD4014	Ra>80	>0.9	40W	220-240VAC 50/60Hz
	3800-4200K	3600						
	2800-3200K	3520						
295*1195mm	6000-6500K	3600	110°	SMD4014	Ra>80	>0.9	40W	220-240VAC 50/60Hz
	3800-4200K	3600						
	2800-3200K	3520						
595*1195mm	6000-6500K	5000	110°	SMD4014	Ra>80	>0.9	50W	220-240VAC 50/60Hz
	3800-4200K	5000						
	2800-3200K	4900						

100LPW Series

Product size	CCT	Lumen(lm)	Beam angle(°)	LEDs type	CRI	PF	Power(W)	Voltage
595*595mm	6000-6500K	4000	110°	SMD4014	Ra>80	>0.9	40W	220-240VAC 50/60Hz
	3800-4200K	4000						
	2800-3200K	3920						
295*1195mm	6000-6500K	4000	110°	SMD4014	Ra>80	>0.9	40W	220-240VAC 50/60Hz
	3800-4200K	4000						
	2800-3200K	3920						
595*1195mm	6000-6500K	5000	110°	SMD4014	Ra>80	>0.9	50W	220-240VAC 50/60Hz
	3800-4200K	5000						
	2800-3200K	4900						

120LPW Series

Product size	CCT	Lumen(lm)	Beam angle(°)	LEDs type	CRI	PF	Power(W)	Voltage
595*1195mm	6000-6500K	4800	110°	SMD4014	Ra>80	>0.9	40W	220-240VAC 50/60Hz
	3800-4200K	4800						
	2800-3200K	4720						
295*1195mm	6000-6500K	4800	110°	SMD4014	Ra>80	>0.9	40W	220-240VAC 50/60Hz
	3800-4200K	4800						
	2800-3200K	4720						
595*1195mm	6000-6500K	6000	110°	SMD4014	Ra>80	>0.9	50W	220-240VAC 50/60Hz
	3800-4200K	6000						
	2800-3200K	5900						

Dimensions

Unit:mm

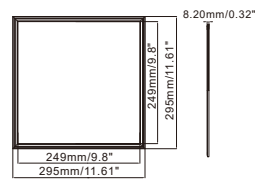

SC-PSC24YE295295-R18W
295*295

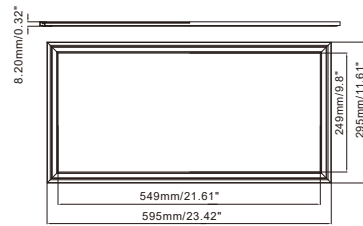

SC-PSC24YE295595-R24W
295*595

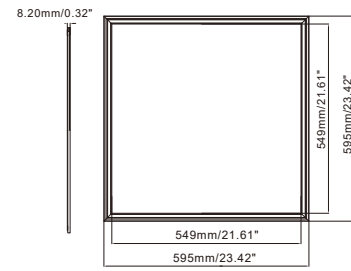

SC-PSC24YE595595-R40W
595*595

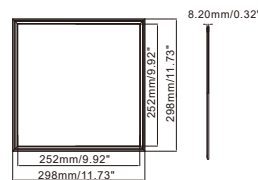

SC-PSC24YE3030-R18W
300*300

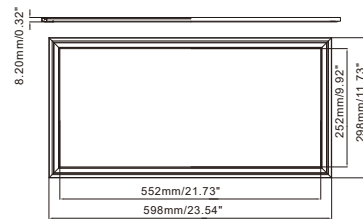

SC-PSC24YE3060-R24W
300*600

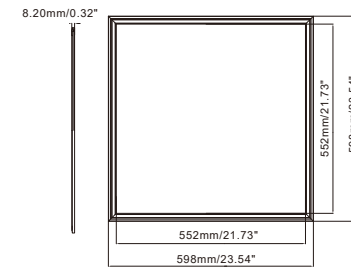

SC-PSC24YE6060-R40W
600*600

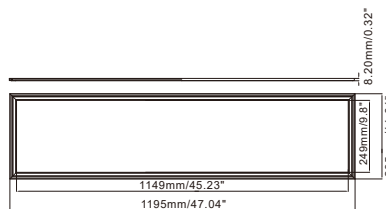

SC-PSC24YE2951195-R40W
295*1195

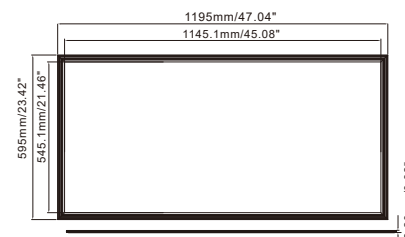

SC-PSC24YE5951195-R50W
595*1195

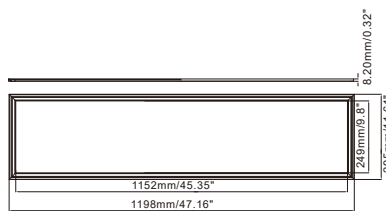

SC-PSC24YE3012-R40W
300*1200

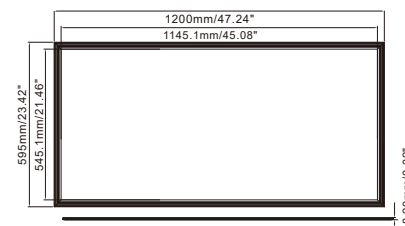

SC-PSC24YE6012-R50W
600*1200

Package

Product size	Inner size	Carton size	Pack Quantity	Net weight	Gross weight
300*300 mm	340*380*46 mm	480*260*410mm	1 PC/inner box 10 inner boxes/carton	0.68 kg	9.8 kg
300*600 mm	635*380*46 mm	650*260*410mm	1 PC/inner box 5 inner boxes/carton	1.175 kg	12.8 kg
600*600mm	680*636*38mm	650*285*715mm	1 PC/inner box 6 inner boxes/carton	2.4 kg	18.12 kg
300*1200 mm	1235*380*38mm	1250*285*715mm	1 PC/inner box 6 inner boxes/carton	2.6 kg	19.67 kg
600*1200mm	1255*694*42mm	1275*110*715mm	2 PCS/inner box 2 inner boxes/carton	4.66 kg	23.64 kg

Installation

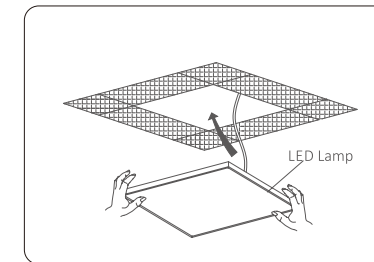

Embedded Installation

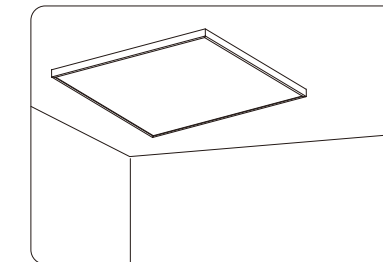

Surface Installation

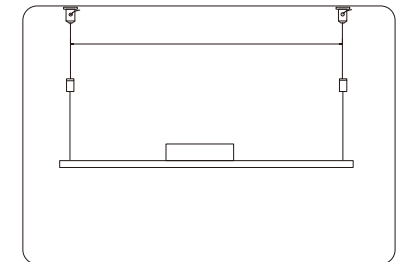

Suspension Installation

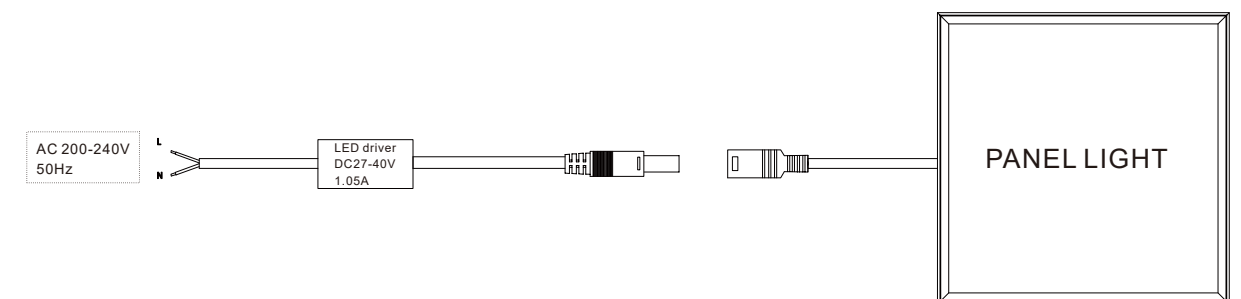

IP65 waterproof series

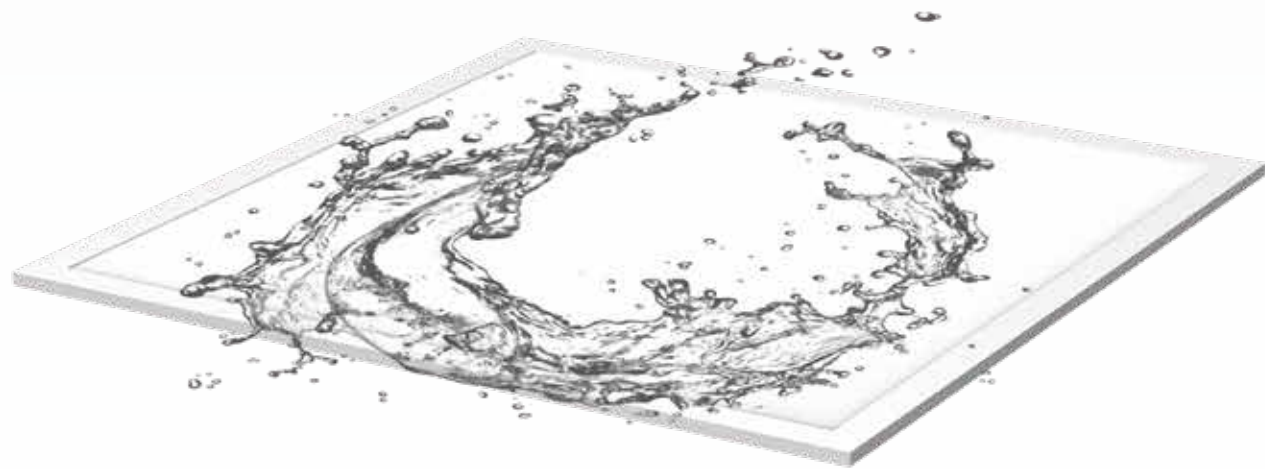

Unit:mm / inch

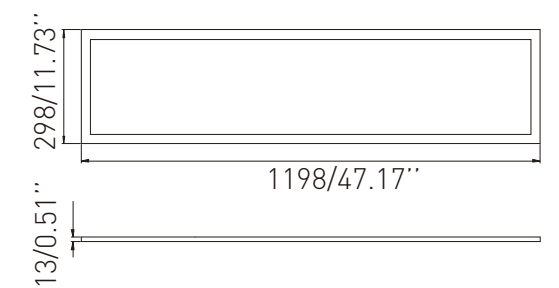
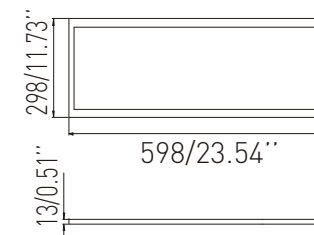
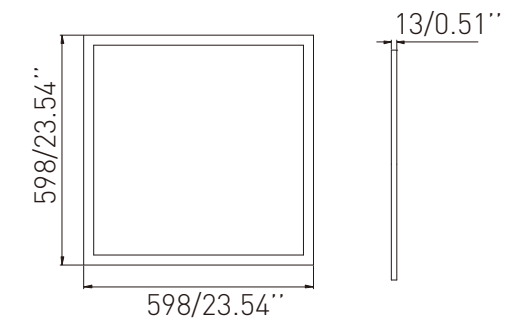
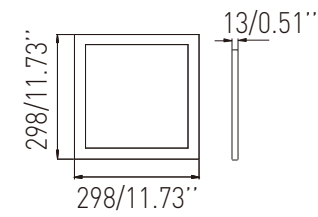

IP65 waterproof

Adopt IP65 waterproof power supply and connector, the panel light can reach IP65 waterproof grade.

Special waterproof foem

Special waterproof foem installed at the front side between aluminum housing and diffuser, also at the back side between the back cover and LGP, to achieve the waterproof effect.

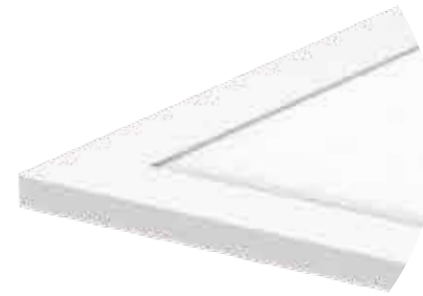

AL6063 aluminum housing

AL6063 aluminum housing, 13mm thickness, very strong structure, not easy to bend during using.



Without any gap at 4 corners

Flat frame design, without any gap at 4 corners.



Anti-leakage

Bending back cover design to prevent light leakage from back side.



Application

The product is suitable for installation in damp environments for use such as bathrooms, kitchens, indoor swimming pools, operation rooms of hospital, etc.

Parameters CE for EU



Product size	CCT	Lumen(lm)	Beam angle(°)	LEDs type	CRI	PF	Power(W)	Voltage
295*295mm	6000-6500K	1656	120°	SMD4014	Ra>80	>0.9	18W	100-240VAC 50/60Hz
	3800-4200K	1656						
	2800-3200K	1476						
295*595mm	6000-6500K	2184	120°	SMD4014	Ra>80	>0.9	24W	100-240VAC 50/60Hz
	3800-4200K	2184						
	2800-3200K	1968						
595*595mm	6000-6500K	4000	120°	SMD4014	Ra>80	>0.9	40W	100-240VAC 50/60Hz
	3800-4200K	4000						
	2800-3200K	3600						
295*1195mm	6000-6500K	4000	120°	SMD4014	Ra>80	>0.9	40W	100-240VAC 50/60Hz
	3800-4200K	4000						
	2800-3200K	3600						

Package

Product size	Inner size	Carton size	Pack Quantity	Net weight	Gross weight
295*295mm	340*385*46mm	480*365*405mm	1 PC/inner box 10 inner boxes/carton	0.8 kg	14.2 kg
295*595mm	635*380*46mm	650*380*410mm	1 PC/inner box 5 inner boxes/carton	1.4 kg	12.0 kg
595*595mm	636*680*38mm	650*260*710mm	1 PC/inner box 6 inner boxes/carton	2.4 kg	22.8 kg
295*1195mm	1235*380*38mm	1250*260*410mm	1 PC/inner box 6 inner boxes/carton	2.5 kg	23.5 kg

Installation

Three installation types : recessed, surface and suspension.

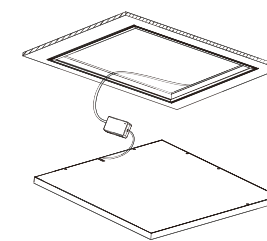

Recessed installation



Surface installation

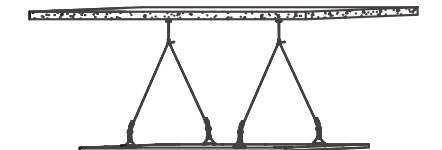

Suspension installation

FLOAT series round suspending panel light

FLOAT round suspending panel light is designed with stylish and fashionable lamp body, and with edge-lit led emitting technology. It has the feature of uniform and smooth light beam, and can be widely used as interior lighting in shops, showrooms, offices, hotels and so on.



Ultrathin and beautiful

Compact appearance, ultrathin, simple and beautiful.

No UV, no IR or mercury free

Energy-saving, eco-friendly, no UV, no IR or mercury free, RoHS compliant;



Better for heat dissipation

Round frame adopt extrusion aluminum, better for heat dissipation, higher hardness, strong structure, have big advantage in large dimension lamp.

90LPW High lighting effect

High lighting effect, uniform light-emitting surface, no ripple.

Brand power supply

Brand power supply, quality assurance.

Can be customized

Lamps of different diameters can be customized, various shapes can be posed to present art of lamps.

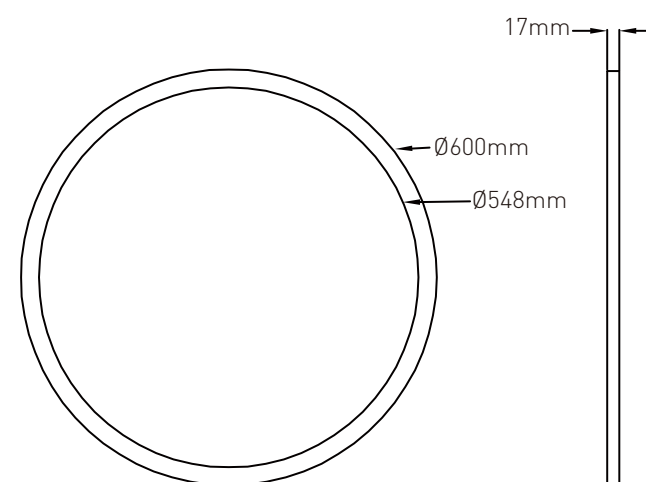

Parameters CE for EU



Product name	CCT	Lumen(lm)	Beam angle(°)	LEDs type	CRI	PF	Power(W)	Voltage
FLOAT (600*600mm)	6000-6500K	4750	110°	SMD2835	Ra>80	>0.9	55W	200-240VAC 50/60Hz
	3800-4200K	5000						
	2800-3200K	4550						

Package

Product name	Inner size	Carton size	Pack Quantity	Net weight	Gross weight
FLOAT	635*686*52mm	650*715*230mm	1 PC/inner box 4 inner boxes/carton	4.38 kg	23.4 kg

