

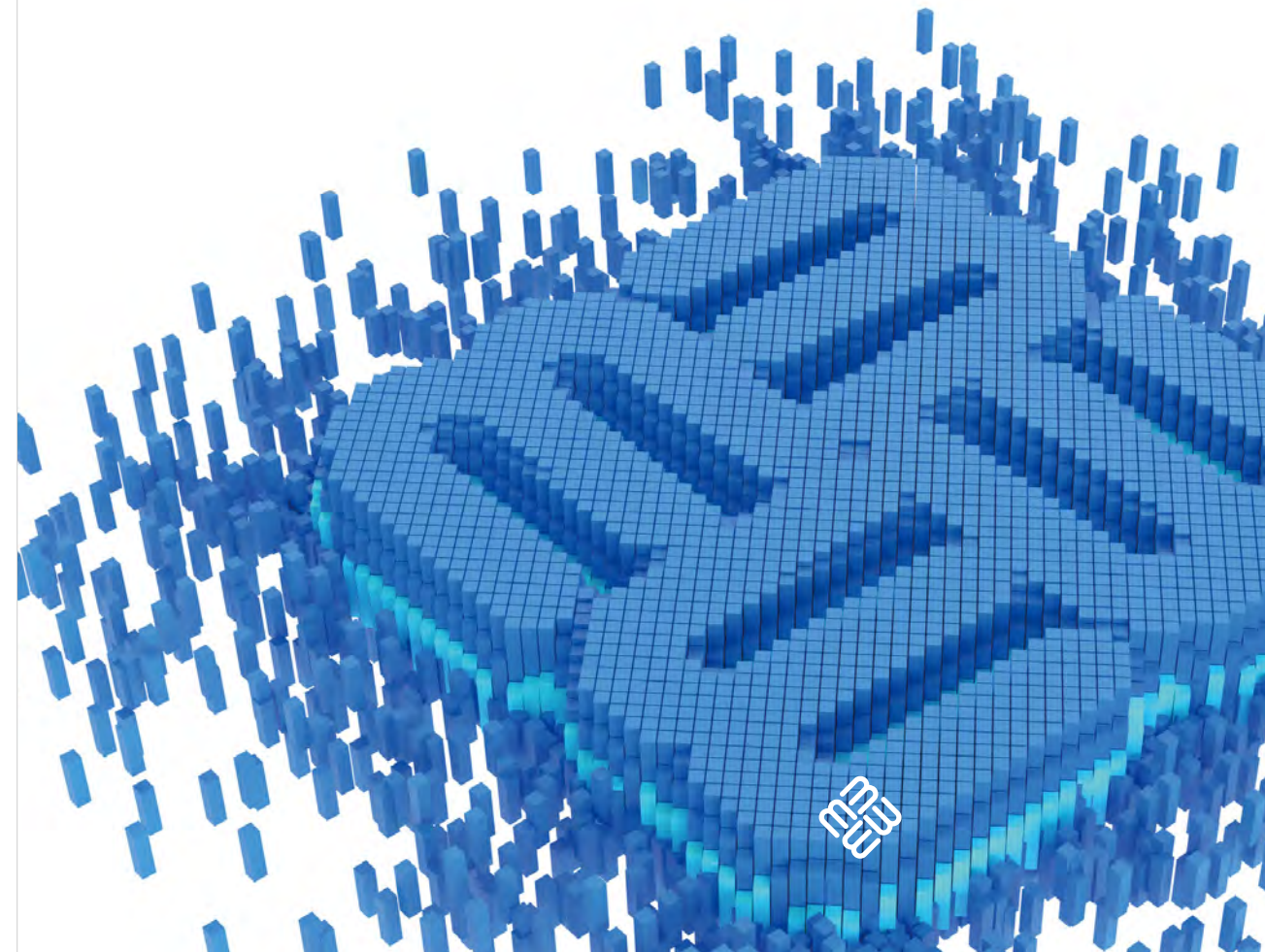

COMMERCIAL LIGHTING ■ PRODUCT COLLECTION 2024 - III

# COMMERCIAL LIGHTING

2024-III / PRODUCT COLLECTION



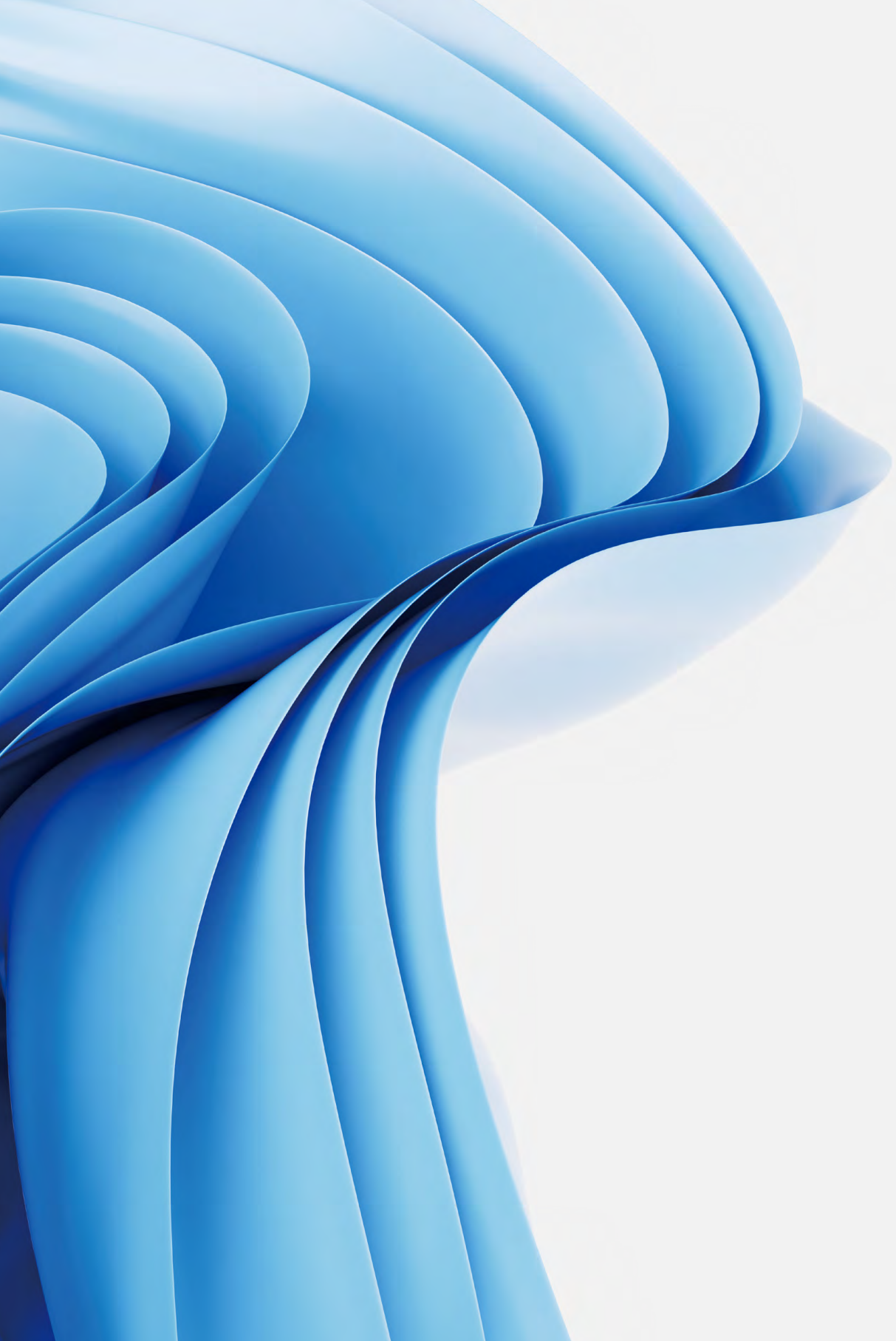

# DIFFERENTIATED LIGHTING SOLUTIONS PROVIDER



## Conception

We always strive to meet each client's unique set of needs and expectations by delivering a truly personalised experience on a professional basis.

## Design

We're a team that believes in the power of strategic design thinking coupled with hands on execution. The seeds of creativity has taken root.

## Prototype









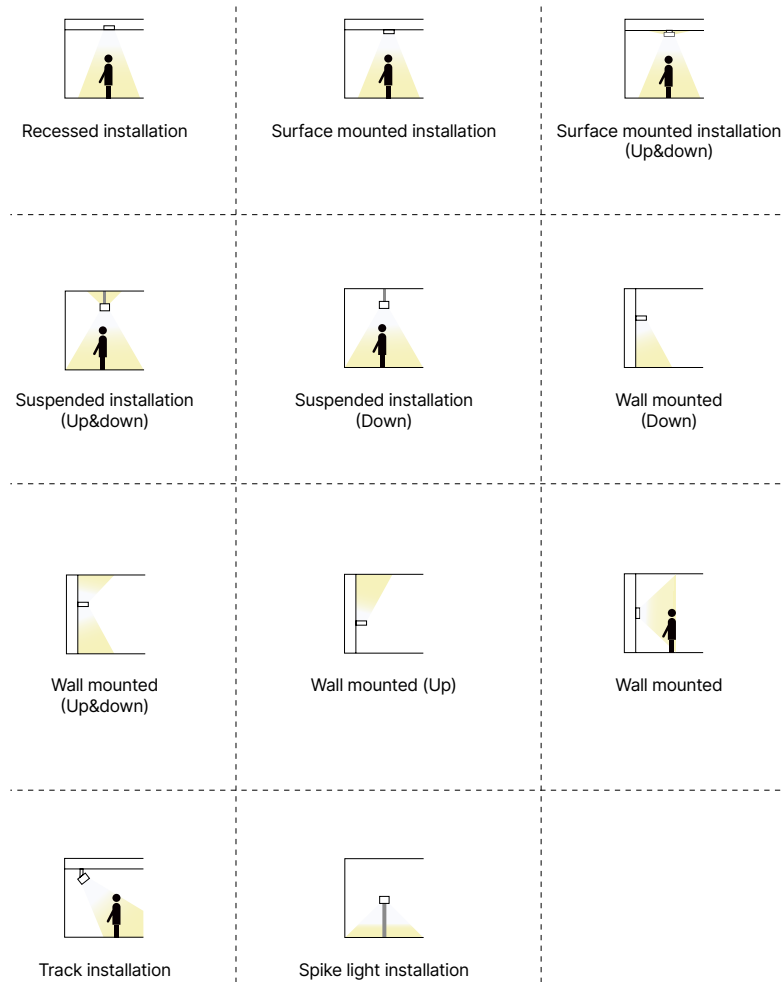























High quality and efficiency are our aim, you will witness the growth very soon and prototype will be provided for evaluation quickly.

## Tooling

Precision of mold technology is well controlled, excellent sample would like to be offered for validation test before mass production.

# ICON INDEX ■ COMMERCIAL LIGHTING



-  Beam Angle
-  Emergency Function
-  Voltage
-  Adjustable Power
-  Power Factor
-  Smart Lighting
-  CRI
-  Unified Glare Rating
-  Ingress Protection
-  Wall Switch CCT Changeable Function
-  Dimmable
-  RGB Color Adjustable Function
-  DALI Dimmable
-  Slide Switch CCT Changeable Function
-  0-10V Dimmable
-  Tunable White
-  Flicker Free
-  Dim to Warm
-  2.4G Intelligent Control
-  Coverable by Insulation Material
-  Wifi intelligent Control
-  Standard Deviation Colour Matching
-  Remote Control
-  Classification TP(a)
-  PIR Sensor Control
-  Classification TP(b)
-  Bluetooth Control
-  Horizontal Rotation
-  Music Functionality
-  Vertical Rotation
-  Microwave Sensor Function
-  GU10

# CONTENTS

## 338 Series P002-009



## 228 Series P010-017



## 322 Series P018-025



## 126 Series P026-029



## 417 Series P030-033



## LED DOWNLIGHT Commercial Series P036-113





**LED DOWNLIGHT** Surface mounted&Pendant Series P114-124



**LED CEILING LIGHT** P128-144



**LED BULKHEAD** P146-161



**LED TRACK LIGHT** P166-208





**LED PANEL LIGHT** P226-266



**LED FREESTANDING LUMINAIRE** P270-274



## LED LINEAR & BATTEN LIGHT P278-337



## LED TUBE LIGHT P340-343





# 338 Series

UGR<19



Track light  
**TL338**



Suspension  
**PD338B**



Suspension  
**PD338A**



Recessed  
**DL338**



Surface mounted  
**DL338A**



Track spot surface  
**DL338B**

# DIY MODULAR DESIGN



## Four size options



## Replaceable reflector (front trim is not exchangeable)



## 3-CCT changeable

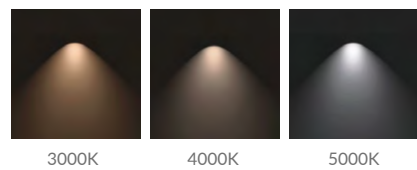

## Power adjustable

Ø65mm :10W/12W/15W  
Ø85mm :15W/20W/25W  
Ø100mm :25W/30W/35W

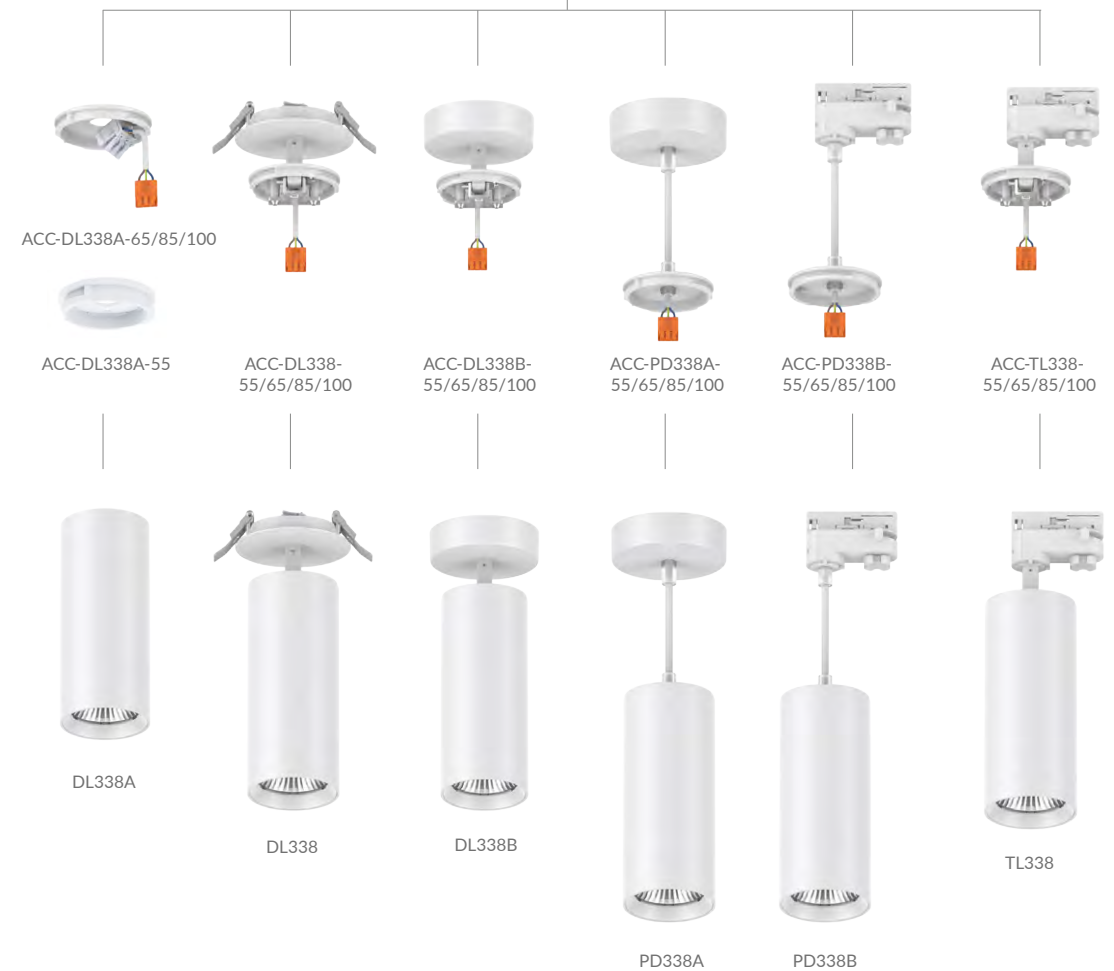



DL338A



DL338B

# DL338A/B Downlight

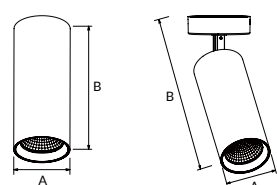

DL338A/B is a DIY modular series with an exquisite appearance and anti-glare UGR19 design, 6 kinds of installation ways, 3 reflectors and 3 front ring colors can be exchangeable. It adopts brand Bridgelux COB led chip with 120lm/W light efficiency. Four size options : Ø55mm, Ø65mm, Ø85mm, Ø100mm. It can do triac dim, DALI dim, CCT interchangeable and wattage adjustable.

Materials of Housing : Aluminium

Materials of Optics : Aluminium+transparent tempered glass

- ▶ 24° 36° 60° 90°
- ▶ IP20 UGR<19
- ▶ DIM DALI Flicker Free SILE SWITCH 3 in 1
- ▶ AC 220-240V PF≥0.85 PF≥0.9 CRI≥80
- ▶ SAA RoHS CE

| Code             | Watt | Size(AxBmm)       | Lumen(±5%) | N.W/pc(kgs) | Q'ty/CTN |
|------------------|------|-------------------|------------|-------------|----------|
| DL338A/B-55-6W   | 6W   | Ø55x160/Ø55x211   | 750lm      | 0.33/0.49   | 24PCS    |
| DL338A/B-55-10W  | 10W  | Ø55x160/Ø55x211   | 1200lm     | 0.33/0.49   | 24PCS    |
| DL338A/B-65-10W  | 10W  | Ø65x180/Ø65x231   | 1200lm     | 0.44/0.60   | 24PCS    |
| DL338A/B-65-15W  | 15W  | Ø65x180/Ø65x231   | 1750lm     | 0.44/0.60   | 24PCS    |
| DL338A/B-85-20W  | 20W  | Ø85x206/Ø85x270   | 2550lm     | 0.73/0.89   | 12PCS    |
| DL338A/B-85-25W  | 25W  | Ø85x206/Ø85x270   | 3150lm     | 0.73/0.89   | 12PCS    |
| DL338A/B-100-30W | 30W  | Ø100x220/Ø100x284 | 3650lm     | 0.99/1.15   | 12PCS    |
| DL338A/B-100-35W | 35W  | Ø100x220/Ø100x284 | 4100lm     | 0.99/1.15   | 12PCS    |

CCT ——— 2700K 3000K 4000K      Finish ——— White Black

Trim ——— Honeycomb White Honeycomb Black Honeycomb Golden

# DL338 Downlight

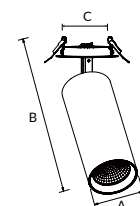

DL338 is a DIY modular series with an exquisite appearance and anti-glare UGR19 design, 6 kinds of installation ways, 3 reflectors and 3 front ring colors can be exchangeable. It adopts brand Bridgelux COB led chip with 120lm/W light efficiency. Four size options : Ø55mm, Ø65mm, Ø85mm, Ø100mm. It can do triac dim, DALI dim, CCT interchangeable and wattage adjustable.

Materials of Housing : Aluminium

Materials of Optics : Aluminium+transparent tempered glass

- ▶ 24° 36° 60° 90° IP20
- ▶ UGR<19
- ▶ DIM DALI Flicker Free SILE SWITCH 3 in 1
- ▶ AC 220-240V PF≥0.85 PF≥0.9 CRI≥80
- ▶ SAA RoHS CE

| Code          | Watt | Size(AxBmm) | Cut-out(mm) | Lumen(±5%) | N.W/pc(kgs) | Q'ty/CTN |
|---------------|------|-------------|-------------|------------|-------------|----------|
| DL338-55-6W   | 6W   | Ø55x215     | 90-95       | 750lm      | 0.51        | 12PCS    |
| DL338-55-10W  | 10W  | Ø55x215     | 90-95       | 1200lm     | 0.51        | 12PCS    |
| DL338-65-10W  | 10W  | Ø65x235     | 90-95       | 1200lm     | 0.62        | 12PCS    |
| DL338-65-15W  | 15W  | Ø65x235     | 90-95       | 1750lm     | 0.62        | 12PCS    |
| DL338-85-20W  | 20W  | Ø85x274     | 90-95       | 2550lm     | 1.08        | 12PCS    |
| DL338-85-25W  | 25W  | Ø85x274     | 90-95       | 3150lm     | 1.08        | 12PCS    |
| DL338-100-30W | 30W  | Ø100x288    | 90-95       | 3650lm     | 1.17        | 12PCS    |
| DL338-100-35W | 35W  | Ø100x288    | 90-95       | 4100lm     | 1.17        | 12PCS    |

CCT ——— 2700K 3000K 4000K      Trim ——— White Black

Trim ——— Honeycomb White Honeycomb Black Honeycomb Golden

PD338A



PD338B



# PD338A/B Downlight

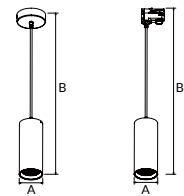

PD338A/B is a DIY modular series with an exquisite appearance and anti-glare UGR19 design, 6 kinds of installation ways, 3 reflectors and 3 front ring colors can be exchangeable. It adopts brand Bridgelux COB led chip with 120lm/W light efficiency. Four size options : Ø55mm, Ø65mm, Ø85mm, Ø100mm. It can do triac dim, DALI dim, CCT interchangeable and wattage adjustable.

Materials of Housing : Aluminium

Materials of Optics : Aluminium+transparent tempered glass

- ▶
- ▶
- ▶
- ▶
- ▶

| Code             | Watt | Size(AxBmm)         | Lumen(±5%) | N.W/pc(kgs) | Q'ty/CTN |
|------------------|------|---------------------|------------|-------------|----------|
| PD338A/B-55-6W   | 6W   | Ø55x1189/Ø55x1213   | 750lm      | 0.50/0.48   | 12PCS    |
| PD338A/B-55-10W  | 10W  | Ø55x1189/Ø55x1213   | 1200lm     | 0.50/0.48   | 12PCS    |
| PD338A/B-65-10W  | 10W  | Ø65x1209/Ø65x1233   | 1200lm     | 0.61/0.59   | 12PCS    |
| PD338A/B-65-15W  | 15W  | Ø65x1209/Ø65x1233   | 1750lm     | 0.61/0.59   | 12PCS    |
| PD338A/B-85-20W  | 20W  | Ø85x1235/Ø85x1259   | 2550lm     | 0.98/0.87   | 12PCS    |
| PD338A/B-85-25W  | 25W  | Ø85x1235/Ø85x1259   | 3150lm     | 0.98/0.87   | 12PCS    |
| PD338A/B-100-30W | 30W  | Ø100x1249/Ø100x1273 | 3650lm     | 1.16/1.14   | 12PCS    |
| PD338A/B-100-35W | 35W  | Ø100x1249/Ø100x1273 | 4100lm     | 1.16/1.14   | 12PCS    |

CCT ——— 2700K ——— 3000K ——— 4000K

Finish ——— White Black

Trim ——— Honeycomb White Honeycomb Black Honeycomb Golden

# TL338 Track light

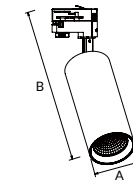

TL338 is a DIY modular series with an exquisite appearance and anti-glare UGR19 design, 6 kinds of installation ways, 3 reflectors and 3 front ring colors can be exchangeable. It adopts brand Bridgelux COB led chip with 120lm/W light efficiency. Four size options : Ø55mm, Ø65mm, Ø85mm, Ø100mm. It can do triac dim, DALI dim, CCT interchangeable and wattage adjustable.

Materials of Housing : Aluminium

Materials of Optics : Aluminium+transparent tempered glass

- ▶
- ▶
- ▶
- ▶
- ▶

| Code          | Watt | Size(AxBmm) | Lumen(±5%) | N.W/pc(kgs) | Q'ty/CTN |
|---------------|------|-------------|------------|-------------|----------|
| TL338-55-6W   | 6W   | Ø55x233     | 750lm      | 0.48        | 12PCS    |
| TL338-55-10W  | 10W  | Ø55x233     | 1200lm     | 0.48        | 12PCS    |
| TL338-65-10W  | 10W  | Ø65x253     | 1200lm     | 0.58        | 12PCS    |
| TL338-65-15W  | 15W  | Ø65x253     | 1750lm     | 0.58        | 12PCS    |
| TL338-85-20W  | 20W  | Ø85x292     | 2550lm     | 0.87        | 12PCS    |
| TL338-85-25W  | 25W  | Ø85x292     | 3150lm     | 0.87        | 12PCS    |
| TL338-100-30W | 30W  | Ø100x306    | 3650lm     | 1.13        | 12PCS    |
| TL338-100-35W | 35W  | Ø100x306    | 4100lm     | 1.13        | 12PCS    |

CCT ——— 2700K ——— 3000K ——— 4000K

Finish ——— White Black

Trim ——— Honeycomb White Honeycomb Black Honeycomb Golden

# 228 Series



Surface mounted  
DL228A



Track spot surface  
DL228B



TL228  
with ceiling box



Suspension  
PD228



Track light  
TL228



Suspension  
PD228B



Suspension  
PD228B

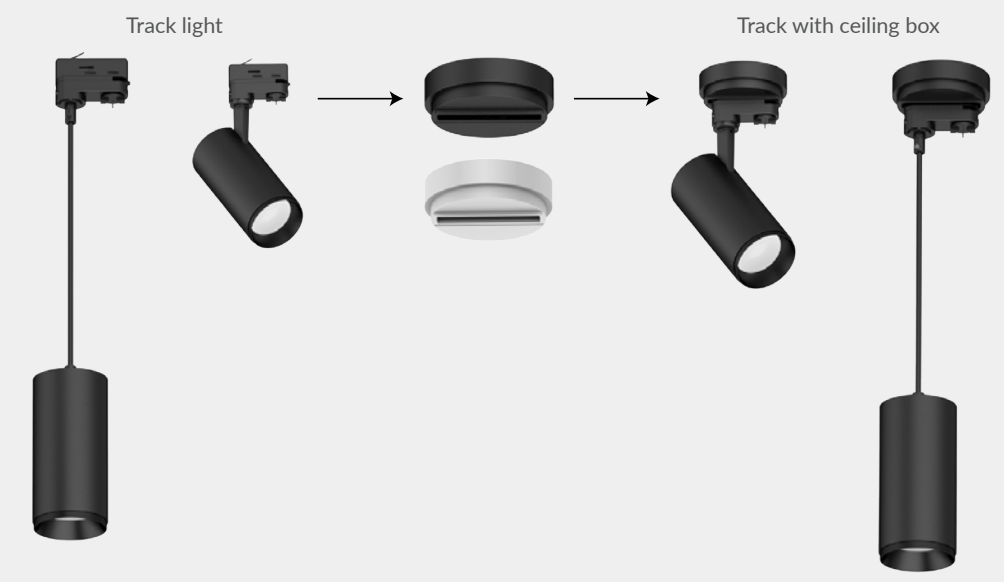



# DL228A Downlight

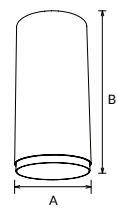

DL228A adopt high lumen COB chip with uniform light effect and enhanced glare control. It offers a wide choice of beam angles 24°/ 36°/60° for optional.

Materials of Housing : Aluminium  
Materials of Optics : PMMA

- ▶ 24° 36° 60°
- ▶ IP20
- ▶ DIM Flicker Free
- ▶ AC 200-240V PF≥0.9 CRI≥80 CRI≥90 CRI≥97
- ▶ SAA RoHS CE CB

| Code       | Watt | Size(AxBmm)                              | Lumen(±5%) | N.W/pc(kgs) | Q'ty/CTN |
|------------|------|--|------------|-------------|----------|
| DL228A-10W | 10W  | Ø65x157                                  | 1100lm     | 0.45        | 12PCS    |
| DL228A-15W | 15W  | Ø65x157 (Non-dim)<br>Ø85x178 (Triac-dim) | 1650lm     | 0.45        | 12PCS    |
| DL228A-20W | 20W  | Ø85x178                                  | 2250lm     | 0.67        | 12PCS    |
| DL228A-25W | 25W  | Ø85x178                                  | 2700lm     | 0.67        | 12PCS    |
| DL228A-30W | 30W  | Ø100x211                                 | 3050lm     | 1.00        | 12PCS    |
| DL228A-40W | 40W  | Ø100x211                                 | 4200lm     | 1.00        | 12PCS    |

CCT ——— 2700K 3000K 4000K      Finish ——— White Black

Interchangeable lens options ——— 24°/30°/45° for 10W/15W      24°/36°/60° for 15W/20W/25W/30W/40W

# DL228B Downlight

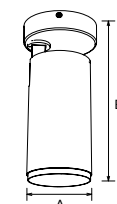

DL228B surface mounted downlight with adjustable lighting orientation, 350° rotate and 90° tilt. It offers a wide choice of beam angles 24°/ 36°/60° for optional. Driver built-in easy for installation.

Materials of Housing : Aluminium  
Materials of Optics : PMMA

- ▶ 24° 36° 60° 350°
- ▶ 90° IP20
- ▶ DIM DALI Flicker Free SLIDE SWITCH 3 in 1
- ▶ AC 200-240V PF≥0.9 CRI≥80 CRI≥90 CRI≥97
- ▶ SAA RoHS CE CB

| Code       | Watt | Size(AxBmm)                             | Lumen(±5%) | N.W/pc(kgs) | Q'ty/CTN |
|------------|------|---|------------|-------------|----------|
| DL228B-10W | 10W  | Ø65x218                                 | 1100lm     | 0.55        | 12PCS    |
| DL228B-15W | 15W  | Ø65x218 (Non-dim)<br>Ø85x241(Triac-dim) | 1650lm     | 0.55        | 12PCS    |
| DL228B-20W | 20W  | Ø85x241                                 | 2250lm     | 0.82        | 12PCS    |
| DL228B-25W | 25W  | Ø85x241                                 | 2700lm     | 0.82        | 12PCS    |
| DL228B-30W | 30W  | Ø100x274                                | 3050lm     | 1.15        | 12PCS    |
| DL228B-40W | 40W  | Ø100x274                                | 4200lm     | 1.15        | 12PCS    |

CCT ——— 2700K 3000K 4000K      Finish ——— White Black

Interchangeable lens options ——— 24°/30°/45° for 10W/15W      24°/36°/60° for 15W/20W/25W/30W/40W

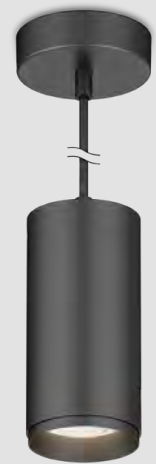

# PD228 Downlight

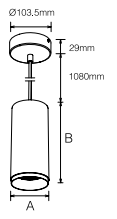

PD228 pendant spot light is a high-performance LED luminaire that is ideal for commercial or residential applications. It adopts high lumen COB chip and lens design offer uniform light effect and enhanced glare control.

Materials of Housing : Aluminium  
Materials of Optics : PMMA

- ▶ IP20
- ▶ DIM DALI Flicker Free SLIDE SWITCH
- ▶ AC 200-240V PF≥0.9 CRI≥80 CRI≥90 CRI≥97
- ▶ SAA RoHS CE CB

| Code      | Watt | Size(AxBmm)                              | Lumen(±5%) | N.W/pc(kgs) | Q'ty/CTN |
|-----------|------|--|------------|-------------|----------|
| PD228-10W | 10W  | Ø65x157                                  | 1100lm     | 0.55        | 12PCS    |
| PD228-15W | 15W  | Ø65x157 (Non-dim)<br>Ø85x178 (Triac-dim) | 1650lm     | 0.55        | 12PCS    |
| PD228-20W | 20W  | Ø85x178                                  | 2250lm     | 0.80        | 12PCS    |
| PD228-25W | 25W  | Ø85x178                                  | 2700lm     | 0.80        | 12PCS    |
| PD228-30W | 30W  | Ø100x211                                 | 3050lm     | 1.15        | 12PCS    |
| PD228-40W | 40W  | Ø100x211                                 | 4200lm     | 1.15        | 12PCS    |

CCT — 2700K — 3000K — 4000K

Finish — White Black

Interchangeable lens options — 24°/30°/45° for 10W/15W 24°/36°/60° for 15W/20W/25W/30W/40W

# TL228 Track light

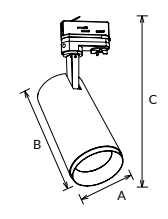

TL228 anti-glare track light is with high lumen COB chip and lens design offer a uniform lighting output, flicker free internal driver. Modular lens design for different beam angle and convenient maintenance.

Materials of Housing : Aluminium  
Materials of Optics : PMMA

- ▶ IP20
- ▶ 90° DIM DALI Flicker Free SLIDE SWITCH Bluetooth Smart Lighting CASAMBI
- ▶ AC 200-240V PF≥0.9 CRI≥80 CRI≥90 CRI≥97
- ▶ SAA RoHS CE CB

| Code      | Watt | Size(AxBxCmm)                                   | Lumen(±5%) | N.W/pc(kgs) | Q'ty/CTN |
|-----------|------|---|------------|-------------|----------|
| TL228-10W | 10W  | Ø65x157x249                                     | 1100lm     | 0.50        | 12PCS    |
| TL228-15W | 15W  | Ø65x157x249(Non-dim)<br>Ø85x178x269 (Triac-dim) | 1650lm     | 0.50        | 12PCS    |
| TL228-20W | 20W  | Ø85x178x269                                     | 2250lm     | 0.76        | 12PCS    |
| TL228-25W | 25W  | Ø85x178x269                                     | 2700lm     | 0.76        | 12PCS    |
| TL228-30W | 30W  | Ø100x211x302                                    | 3050lm     | 1.10        | 12PCS    |
| TL228-40W | 40W  | Ø100x211x302                                    | 4200lm     | 1.10        | 12PCS    |

CCT — 2700K — 3000K — 4000K

Finish — White Black Silver

Interchangeable lens options — 24°/30°/45° for 10W/15W 24°/36°/60° for 15W/20W/25W/30W/40W



# 322 series



Surface mounted  
**DL322A**



Recessed  
**DL322B**



Suspension  
**PD322**



Track light  
**TL322A**



DALI track light  
**TL322B**



Suspension with track  
**PD322A**



DALI suspension with track  
**PD322B**



Oblique axis rotatory

# Modern spherical design



ADC12 body

COB LED  
CRI80/90/97 optional

UGR22  
36°/60° optional



0°

90°

180°

270°

340°

# DIY modular design

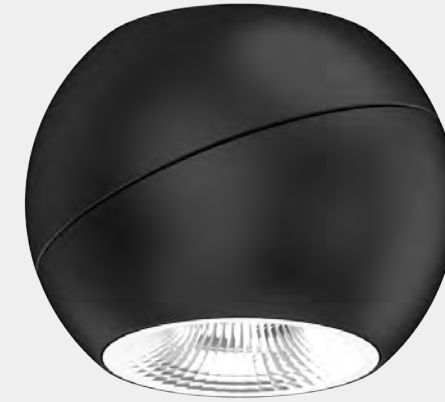

Lamp body

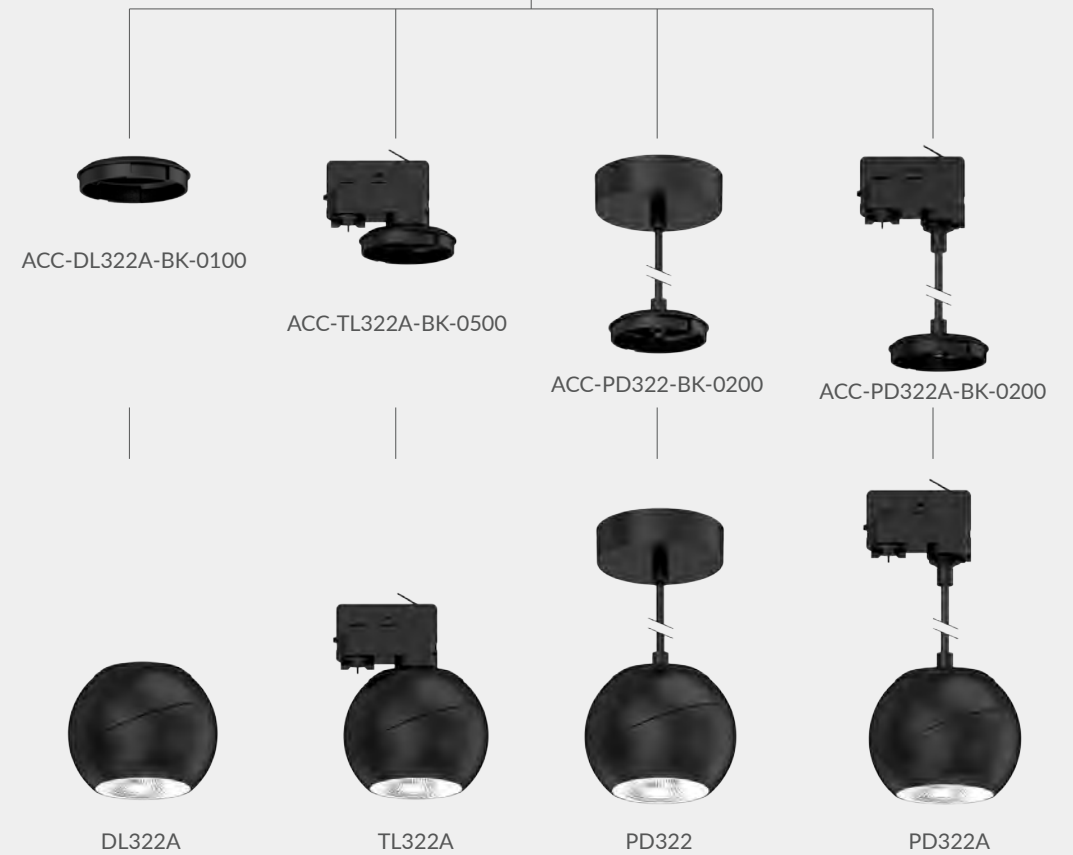



# DL322A Downlight

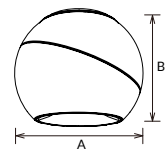

DL322A adopts high lumen COB chip. The type A is surface mounted. ADC12 aluminum lamp body provides excellent heat dissipation. 340degree rotatory and lighting direction is 40 degree adjustable .

Materials of Housing : Die-casting Aluminium  
Materials of Optics : PC

- ▶ 36° 60°
- ▶ IP20
- ▶ Flicker Free
- ▶ AC 220-240V
- ▶ PF≥0.9
- ▶ CRI≥80
- ▶ SAA
- ▶ RoHS
- ▶ CE

| Code       | Watt | Size(AxBmm) | Lumen(±5%) | N.W/pc(kgs) | Q'ty/CTN |
|------------|------|-------------|------------|-------------|----------|
| DL322A-10W | 10W  | Ø120x96     | 1200lm     | 0.81        | 12PCS    |
| DL322A-14W | 14W  | Ø120x96     | 1600lm     | 0.81        | 12PCS    |

# DL322B Downlight

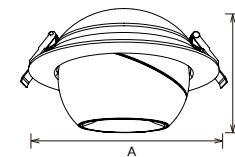

DL322B adopts high lumen COB chip. The type B is recessed installation. ADC12 aluminum lamp body provides excellent heat dissipation. 340degree rotatory and lighting direction is 40 degree adjustable .

Materials of Housing : Die-casting Aluminium  
Materials of Optics : PC

- ▶ 36° 60°
- ▶ IP20
- ▶ DIM
- ▶ Flicker Free
- ▶ AC 220-240V
- ▶ PF≥0.9
- ▶ CRI≥80
- ▶ SAA
- ▶ RoHS
- ▶ CE

| Code       | Watt | Size(AxBmm) | Cut-out(mm) | Lumen(±5%) | N.W/pc(kgs) | Q'ty/CTN |
|------------|------|-------------|-------------|------------|-------------|----------|
| DL322B-12W | 12W  | Ø172x100    | Ø150-160    | 1400lm     | 1.13        | 12PCS    |
| DL322B-16W | 16W  | Ø172x100    | Ø150-160    | 1800lm     | 1.13        | 12PCS    |
| DL322B-20W | 20W  | Ø172x100    | Ø150-160    | 2100lm     | 1.13        | 12PCS    |

CCT — 2700K — 3000K — 4000K

Finish — White — Black

CCT — 2700K — 3000K — 4000K

Trim — White — Black



## PD322 Downlight

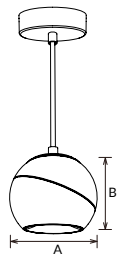

PD322 adopts high lumen COB chip. It is suspension version. PD322A is track suspending, PD322B is DALI track suspending for option. ADC12 aluminum lamp body provides excellent heat dissipation. 340degree rotatory and lighting direction is 40 degree adjustable

Materials of Housing : Die-casting Aluminium  
Materials of Optics : PC

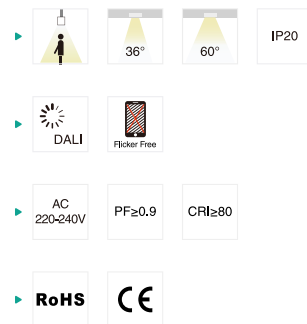

| Code              | Watt | Size(AxBmm) | Lumen(±5%) | N.W/pc(kgs) | Q'ty/CTN |
|-------------------|------|-------------|------------|-------------|----------|
| PD322/ PD322A-10W | 10W  | Ø120x96     | 1200lm     | 0.97        | 12PCS    |
| PD322/ PD322A-14W | 14W  | Ø120x96     | 1600lm     | 0.97        | 12PCS    |
| PD322B-13W        | 13W  | Ø120x96     | 1400lm     | 1.01        | 12PCS    |
| PD322B-17W        | 17W  | Ø120x96     | 1800lm     | 1.01        | 12PCS    |
| PD322B-21W        | 21W  | Ø120x96     | 2100lm     | 1.01        | 12PCS    |

CCT — 2700K — 3000K — 4000K

Finish — White — Black



## TL322 Track light

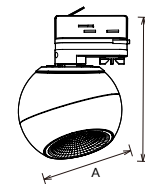

TL322 led track light is an ingenious design adopts high efficiency led. ADC12 aluminum lamp body provides excellent heat dissipation. 340degree rotatory and lighting direction is 40 degree adjustable .

Materials of Housing : Die-casting Aluminium  
Materials of Optics : PC

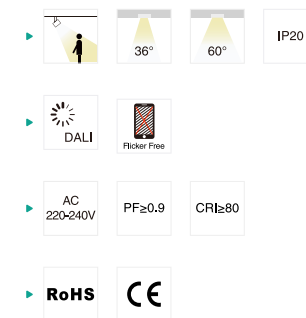

| Code       | Watt | Size(AxBmm) | Lumen(±5%) | N.W/pc(kgs) | Q'ty/CTN |
|------------|------|-------------|------------|-------------|----------|
| TL322A-10W | 10W  | Ø120x96     | 1200lm     | 0.90        | 12PCS    |
| TL322A-14W | 14W  | Ø120x96     | 1600lm     | 0.90        | 12PCS    |
| TL322B-13W | 13W  | Ø120x96     | 1400lm     | 0.92        | 12PCS    |
| TL322B-17W | 17W  | Ø120x96     | 1800lm     | 0.92        | 12PCS    |
| TL322B-21W | 21W  | Ø120x96     | 2100lm     | 0.92        | 12PCS    |

CCT — 2700K — 3000K — 4000K

Finish — White — Black

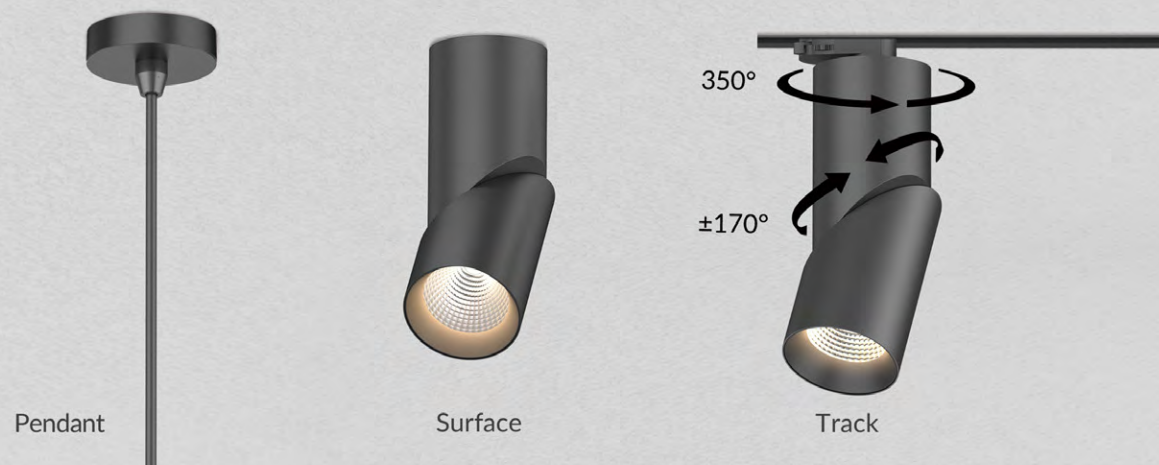

# 126 Series CCT Changeable

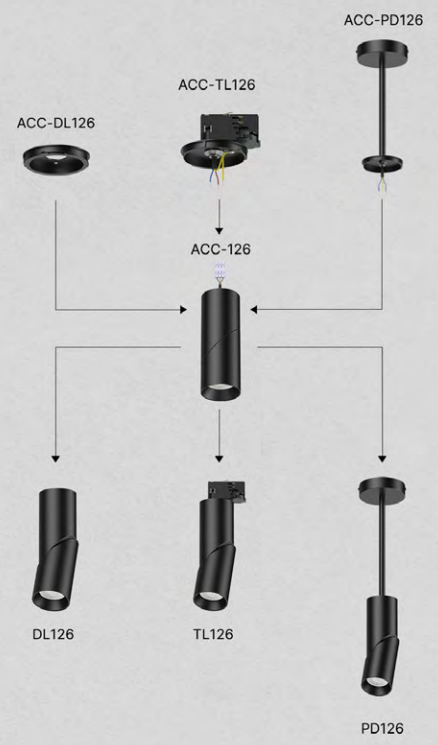
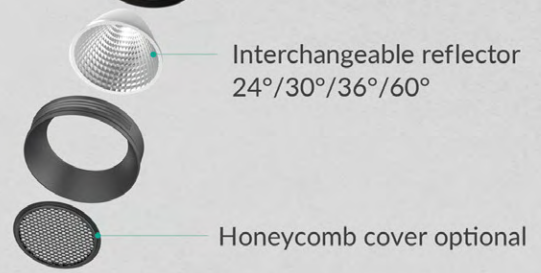

# DL126 Downlight

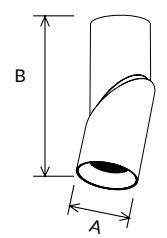

- ▶ Beam angles: 24°, 30°, 36°, 60°, 350° rotation
- ▶ Features: 90° rotation, IP20, UGR<19
- ▶ Controls: DIM, DALI, Flicker Free, SLIDE SWITCH
- ▶ Electrical: AC 200-240V, PF≥0.9, CRI≥90
- ▶ Certifications: SAA, RoHS, CE

DL126 is a modular series with super slim and rotate head design, UGR<19, CRI90 provide high quality light output experience, 3CCT available, 3 kinds of installation for option: track, surface mounted and pendant.

Materials of Housing : Die-casting Aluminium  
Materials of Optics : PC

| Code         | Watt | Size(AxBmm) | Lumen(±5%) | N.W/pc(kgs) | Q'ty/CTN |
|--------------|------|-------------|------------|-------------|----------|
| DL126-65-10W | 10W  | Ø65x248     | 980lm      | 0.78        | 12PCS    |
| DL126-65-15W | 15W  | Ø65x248     | 1400lm     | 0.78        | 12PCS    |
| DL126-85-20W | 20W  | Ø85x278     | 2100lm     | 1.15        | 6PCS     |
| DL126-85-25W | 25W  | Ø85x278     | 2500lm     | 1.15        | 6PCS     |
| DL126-85-28W | 28W  | Ø85x278     | 2850lm     | 1.15        | 6PCS     |
| DL126-85-30W | 30W  | Ø85x278     | 2900lm     | 1.15        | 6PCS     |

CCT ——— 2700K ——— 3000K ——— 4000K ——— Finish ——— White ——— Black

Installation accessories ——— ACC-DL126 ——— Honeycomb cover

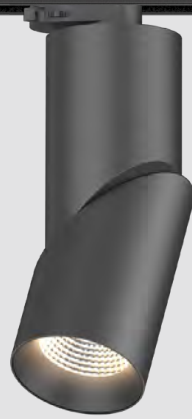

# TL126 Track light

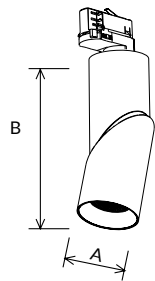

TL126 is a modular series with super slim and rotate head design, UGR<19, CRI90 provide high quality light output experience, 3CCT available, 3 kinds of installation for option: track, surface mounted and pendant.

Materials of Housing : Die-casting Aluminium  
Materials of Optics : PC

- ▶ 24° 30° 36° 60° 350°
- ▶ 90° IP20 UGR<19
- ▶ DIM DALI Flicker Free SLIDE SWITCH 3-in-1
- ▶ AC 200-240V PF≥0.9 CRI≥90
- ▶ SAA RoHS CE

| Code         | Watt | Size(AxBmm) | Lumen(±5%) | N.W/pc(kgs) | Q'ty/CTN |
|--------------|------|-------------|------------|-------------|----------|
| TL126-65-10W | 10W  | Ø65x248     | 980lm      | 0.75        | 12PCS    |
| TL126-65-15W | 15W  | Ø65x248     | 1400lm     | 0.75        | 12PCS    |
| TL126-85-20W | 20W  | Ø85x278     | 2100lm     | 1.25        | 6PCS     |
| TL126-85-25W | 25W  | Ø85x278     | 2500lm     | 1.25        | 6PCS     |
| TL126-85-28W | 28W  | Ø85x278     | 2850lm     | 1.25        | 6PCS     |
| TL126-85-30W | 30W  | Ø85x278     | 2900lm     | 1.25        | 6PCS     |

CCT ——— 2700K 3000K 4000K      Finish ——— White Black

Installation accessories ——— ACC-TL126 ACC-TL126(DALI)

# PD126 Pendant light

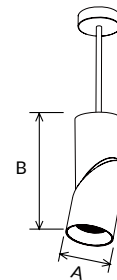

PD126 is a modular series with super slim and rotate head design, UGR<19, CRI90 provide high quality light output experience, 3CCT available, 3 kinds of installation for option: track, surface mounted and pendant.

Materials of Housing : Die-casting Aluminium  
Materials of Optics : PC

- ▶ 24° 30° 36° 60° 350°
- ▶ 90° IP20 UGR<19
- ▶ DIM DALI Flicker Free SLIDE SWITCH 3-in-1
- ▶ AC 200-240V PF≥0.9 CRI≥90
- ▶ SAA RoHS CE

| Code         | Watt | Size(AxBmm) | Lumen(±5%) | N.W/pc(kgs) | Q'ty/CTN |
|--------------|------|-------------|------------|-------------|----------|
| PD126-65-10W | 10W  | Ø65x248     | 980lm      | 0.91        | 12PCS    |
| PD126-65-15W | 15W  | Ø65x248     | 1400lm     | 0.94        | 12PCS    |
| PD126-85-20W | 20W  | Ø85x278     | 2100lm     | 1.45        | 6PCS     |
| PD126-85-25W | 25W  | Ø85x278     | 2500lm     | 1.45        | 6PCS     |
| PD126-85-28W | 28W  | Ø85x278     | 2850lm     | 1.45        | 6PCS     |
| PD126-85-30W | 30W  | Ø85x278     | 2900lm     | 1.45        | 6PCS     |

CCT ——— 2700K 3000K 4000K      Finish ——— White Black

Installation accessories ——— ACC-PD126 Honeycomb cover



Surface  
130LM/W



Wall mounted

2CCT changeable

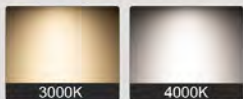

Pendant

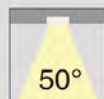

# 417 Series



## DL417 <sup>NEW</sup> Downlight

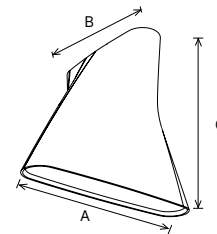

417 is an element series products, same fitting with different installation, DL417 for surface mounted, PD417 for pendant mounted and WL417 is for wall mounted. Internal flicker free driver, adopting high lumen SMD LED and interchangeable CCT with slide switch is available.

Materials of Housing : Aluminium

Materials of Optics : PC

- ▶
- ▶
- ▶
- ▶

| Code      | Watt | Size(AxBmm) | Lumen(±5%) | N.W/pc(kgs) | Q'ty/CTN |
|-----------|------|-------------|------------|-------------|----------|
| DL417-15W | 15W  | 184x124x143 | 1800lm     | 0.75        | 12PCS    |

CCT ——— 2700K ——— 3000K ——— 4000K

Finish ——— White Black

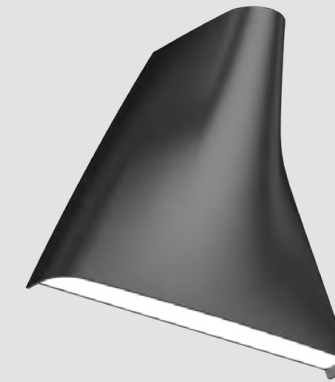

# PD417 NEW Pendant light

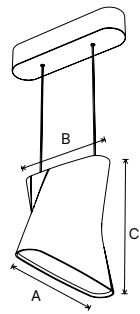

417 is an element series products, same fitting with different installation, DL417 for surface mounted, PD417 for pendant mounted and WL417 is for wall mounted. Internal flicker free driver, adopting high lumen SMD LED and interchangeable CCT with slide switch is available.

Materials of Housing : Aluminium

Materials of Optics : PC

- ▶
- ▶
- ▶
- ▶

| Code      | Watt | Size(AxBxCmm) | Lumen(±5%) | N.W/pc(kgs) | Q'ty/CTN |
|-----------|------|---------------|------------|-------------|----------|
| PD417-15W | 15W  | 184x124x143   | 1500lm     | 0.86        | 12PCS    |

CCT ——— 2700K ——— 3000K ——— 4000K

Finish ——— White Black

# WL417 NEW Exterior wall light

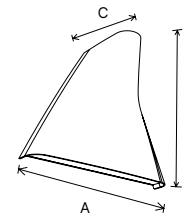

417 is an element series products, same fitting with different installation, DL417 for surface mounted, PD417 for pendant mounted and WL417 is for wall mounted. Internal flicker free driver, adopting high lumen SMD LED and interchangeable CCT with slide switch is available.

Materials of Housing : Aluminium

Materials of Optics : PC

- ▶
- ▶
- ▶
- ▶

| Code     | Watt | Size(AxBxCmm) | Lumen(±5%) | N.W/pc(kgs) | Q'ty/CTN |
|----------|------|---------------|------------|-------------|----------|
| WL417-8W | 8W   | 180x143x72.5  | 800lm      | 0.60        | 12PCS    |

CCT ——— 2700K ——— 3000K ——— 4000K

Finish ——— White Black





# LED Downlight

## /Series/

LED downlight series provide turn-key lighting solutions in domestic and commercial applications. Our downlight is a combination of technique and emotion. We offer our customers a platform to experience the good quality and lighting effects with unique design, 100lm/w and more, UGR<19, Ra80 and Ra90, smart function. UPSHINE LED downlight family provides different solutions for project and distribution with different product types: COB/SMD version, IP54/IP44/IP20, recessed/surface mounted/pendant, different sizes, different watts. The export volume of UPSHINE downlight is in the top three for three consecutive years according to China export data. UPSHINE is your one-stop service supplier for any downlight you're looking for!



# DL210 Downlight

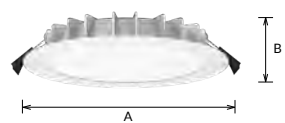

DL210 LED downlight is with super slim design, external driver, adopting high lumen SMD LED with uniform light. Interchangeable CCT with slide switch is available. IP54 waterproof for front side.

- ▶ 100°
- ▶
- ▶
- ▶
- ▶

Materials of Housing : Aluminium  
Materials of Optics : PC

| Code         | Watt | Size(AxBmm) | Cut-out(mm) | Lumen(±5%) | N.W/pc(kgs) | Q'ty/CTN |
|--------------|------|-------------|-------------|------------|-------------|----------|
| DL210-3-10W  | 10W  | Ø110x30     | Ø90-95      | 1000lm     | 0.25        | 36PCS    |
| DL210-3-13W  | 13W  | Ø110x30     | Ø90-95      | 1320lm     | 0.25        | 36PCS    |
| DL210-4-13W  | 13W  | Ø145x30     | Ø120-130    | 1370lm     | 0.35        | 30PCS    |
| DL210-4-18 W | 18W  | Ø145x30     | Ø120-130    | 1980lm     | 0.35        | 30PCS    |
| DL210-6-18W  | 18W  | Ø190x30     | Ø160-170    | 1930lm     | 0.50        | 24PCS    |
| DL210-6-25W  | 25W  | Ø190x30     | Ø160-170    | 2750lm     | 0.50        | 24PCS    |
| DL210-8-25W  | 25W  | Ø225x34     | Ø200-210    | 2750lm     | 0.65        | 12PCS    |
| DL210-8-35W  | 35W  | Ø225x34     | Ø200-210    | 3900lm     | 0.65        | 12PCS    |
| DL210-8-42W  | 42W  | Ø225x34     | Ø200-210    | 4750lm     | 0.65        | 12PCS    |

CCT — 3000K — 4000K — 5700K

Trim — White — Black

# DL216 Downlight

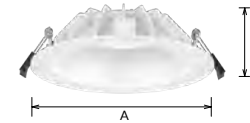

DL216 LED downlight is with high lumen SMD LED. Deep trim design provides soft lighting for eyes. external driver is available for triac dim, 0~10V and DALI. 3CCT changeable with slide switch is available. IP44 waterproof for front side.

- ▶ 90°
- ▶
- ▶
- ▶

Materials of Housing : Aluminium  
Materials of Optics : PC

| Code          | Watt | Size(AxBmm) | Cut-out(mm) | Lumen(±5%) | N.W/pc(kgs) | Q'ty/CTN |
|---------------|------|-------------|-------------|------------|-------------|----------|
| DL216-3-8W    | 8W   | Ø115x45     | Ø90-105     | 790lm      | 0.20        | 36PCS    |
| DL216-3.5-10W | 10W  | Ø129x45     | Ø105-115    | 1045lm     | 0.24        | 36PCS    |
| DL216-4-13W   | 13W  | Ø152x48     | Ø125-140    | 1355lm     | 0.30        | 24PCS    |
| DL216-5-20W   | 20W  | Ø175x52     | Ø145-160    | 2090lm     | 0.40        | 12PCS    |
| DL216-7-25W   | 25W  | Ø203x56     | Ø175-190    | 2610lm     | 0.50        | 12PCS    |
| DL216-7-30W   | 30W  | Ø203x56     | Ø175-190    | 2950lm     | 0.50        | 12PCS    |
| DL216-8-33W   | 33W  | Ø228x63     | Ø205-215    | 3445lm     | 0.65        | 6PCS     |
| DL216-8-40W   | 40W  | Ø228x63     | Ø205-215    | 4000lm     | 0.65        | 6PCS     |

CCT — 3000K — 4000K — 5700K

Trim — White — Black



# DL97 Downlight

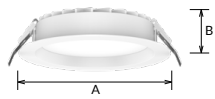

DL97 LED downlight is with high lumen SMD LED, external driver is available for triac dim, 0-10V and DALI, IP54 IK06 protection level. CCT changeable by slide switch is available. Full size from 2.5 inch to 8 inch are all available.

Materials of Housing : Aluminium  
Materials of Optics : PC

- ▶ 90° IP20 IP54
- ▶ DIM DALI 0-10V Flicker Free TUNABLE WHITE SLIDE SWITCH 3 in 1
- ▶ 2.4G WIFI Bluetooth Smart Lighting
- ▶ AC 100-240V AC 200-240V PF≥0.9 CRI≥80
- ▶ SAA RoHS CE CB

| Code         | Watt | Size(AxBmm) | Cut-out(mm) | Lumen(±5%) | N.W/pc(kgs) | Q'ty/CTN |
|--------------|------|-------------|-------------|------------|-------------|----------|
| DL97-2.5-7W  | 7W   | Ø85x39      | Ø70-75      | 590lm      | 0.20        | 50PCS    |
| DL97-3-10W   | 10W  | Ø110x38     | Ø90-95      | 980lm      | 0.25        | 36PCS    |
| DL97-3-13W   | 13W  | Ø110x38     | Ø90-95      | 1300lm     | 0.25        | 36PCS    |
| DL97-3.5-13W | 13W  | Ø120x45     | Ø100-110    | 1230lm     | 0.31        | 30PCS    |
| DL97-4-15W   | 15W  | Ø145x45     | Ø120-130    | 1600lm     | 0.46        | 30PCS    |
| DL97-5-18W   | 18W  | Ø170x45     | Ø140-150    | 2070lm     | 0.52        | 30PCS    |
| DL97-6-18W   | 18W  | Ø190x45     | Ø160-170    | 1900lm     | 0.66        | 20PCS    |
| DL97-6-25W   | 25W  | Ø190x45     | Ø160-170    | 2680lm     | 0.66        | 20PCS    |
| DL97-6-35W   | 35W  | Ø190x45     | Ø160-170    | 3900lm     | 0.66        | 20PCS    |
| DL97-8-18W   | 18W  | Ø228x45     | Ø200-210    | 2050lm     | 0.81        | 10PCS    |
| DL97-8-25W   | 25W  | Ø228x45     | Ø200-210    | 2650lm     | 0.81        | 10PCS    |
| DL97-8-35W   | 35W  | Ø228x45     | Ø200-210    | 4025lm     | 0.81        | 10PCS    |
| DL97-2.5-7W  | 7W   | Ø86x39      | Ø68x39      | 708lm      | 0.20        | 50PCS    |
| DL97-3-10W   | 10W  | Ø110x38     | Ø88x38      | 1120lm     | 0.32        | 36PCS    |
| DL97-3.5-13W | 13W  | Ø120x39     | Ø100x45     | 1420lm     | 0.41        | 36PCS    |
| DL97-4-15W   | 15W  | Ø145x45     | Ø118x45     | 1770lm     | 0.47        | 30PCS    |
| DL97-5-18W   | 18W  | Ø170x45     | Ø136x45     | 2100lm     | 0.52        | 30PCS    |
| DL97-6-18W   | 18W  | Ø190x45     | Ø155x45     | 2170lm     | 0.64        | 20PCS    |
| DL97-6-25W   | 25W  | Ø190x45     | Ø155x45     | 3130lm     | 0.64        | 20PCS    |
| DL97-8-18W   | 18W  | Ø228x45     | Ø200x45     | 2300lm     | 0.81        | 20PCS    |
| DL97-8-25W   | 25W  | Ø228x45     | Ø200x45     | 3200lm     | 0.81        | 10PCS    |
| DL97-8-35W   | 35W  | Ø228x45     | Ø200x45     | 4580lm     | 0.81        | 10PCS    |

CCT — 3000K 4000K 5700K

Trim — White Black

# CL59 Downlight

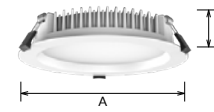

CL59 LED Down light adopts high lumen SMD LED, PC diffuser with even light output max 130lm/W for 8inch and 10inch. White, silver, chrome surface treatments are available for wide choice. Triac dimmable, 0-10V dimmable and DALI dimmable version share great popularity by excellent dimming effect. 3CCT is available, IP44 waterproof in front.

Materials of Housing : Aluminium  
Materials of Optics : PC

- ▶ 90° IP20 IP44
- ▶ DIM DALI 0-10V Flicker Free TUNABLE WHITE CPM TO WARM
- ▶ SLIDE SWITCH 3 in 1 Bluetooth CASAMBI
- ▶ AC 100-240V AC 200-240V PF≥0.9 CRI≥80
- ▶ SAA RoHS CE

| Code              | Watt    | Size(AxBmm) | Cut-out(mm) | Lumen(±5%)    | N.W/pc(kgs) | Q'ty/CTN |
|-------------------|---------|-------------|-------------|---------------|-------------|----------|
| CL59-2-7W         | 7W      | Ø80x39      | Ø60-70      | 480lm         | 0.28        | 50PCS    |
| CL59-2.5-10W      | 10W     | Ø85x39.5    | Ø70-75      | 730lm         | 0.24        | 50PCS    |
| CL59-3-10W/-F     | 10W     | Ø100x38     | Ø90-100     | 720lm         | 0.28        | 24PCS    |
| CL59-3-12W/13W/-F | 12W/13W | Ø110x38     | Ø90-100     | 1170lm/950lm  | 0.28        | 24PCS    |
| CL59-3.5-13W      | 13W     | Ø120x39     | Ø100-110    | 1150lm        | 0.45        | 24PCS    |
| CL59-4-13W/18W    | 13W/18W | Ø145x45     | Ø120-130    | 950lm/1450lm  | 0.59        | 30PCS    |
| CL59-5-18W        | 18W     | Ø170x45     | Ø140-150    | 1550lm        | 0.70        | 30PCS    |
| CL59-5-25W        | 25W     | Ø170x45     | Ø140-150    | 2100lm        | 0.70        | 30PCS    |
| CL59-6-18W        | 18W     | Ø190x45     | Ø160-170    | 1560lm        | 0.83        | 20PCS    |
| CL59-6-25W/35W    | 25W/35W | Ø190x45     | Ø160-170    | 2130lm/2830lm | 0.83        | 20PCS    |
| CL59-8-18W/35W    | 18W/35W | Ø228x45     | Ø200-210    | 1540lm/2790lm | 0.94        | 10PCS    |
| CL59-8-25W        | 25W     | Ø228x45     | Ø200-210    | 2130lm        | 0.94        | 10PCS    |
| CL59-10-45W       | 45W     | Ø280x52     | Ø230-260    | 4170lm        | 1.60        | 10PCS    |
| CL59-2-7W         | 7W      | Ø80x39      | Ø60-65      | 550lm         | 0.24        | 50PCS    |
| CL59-2.5-7W       | 7W      | Ø85x39.5    | Ø68-75      | 680lm         | 0.26        | 50PCS    |
| CL59-3-10W        | NEW 10W | Ø110x44     | Ø90-95      | 1020lm        | 0.28        | 24PCS    |
| CL59-4-12W        | NEW 12W | Ø145x48     | Ø120-130    | 1450lm        | 0.59        | 30PCS    |
| CL59-5-18W        | NEW 18W | Ø170x49     | Ø140-150    | 2200lm        | 0.70        | 30PCS    |
| CL59-6-18W        | NEW 18W | Ø190x49     | Ø160-170    | 2250lm        | 0.83        | 20PCS    |
| CL59-8-25W        | NEW 25W | Ø228x48     | Ø200-210    | 3250lm        | 0.94        | 10PCS    |
| CL59-10-35W       | NEW 35W | Ø280x56     | Ø230-260    | 4600lm        | 1.60        | 10PCS    |

CCT — 3000K 4000K 5700K

Trim — White Black Silver Chrome



DL137A

DL137B

# DL422 NEW Downlight



DL422 LED downlight adapts high lumen SMD with external driver design. It is power changeable version and CCT changeable is for your option. On/off, triac dim and DALI dim are available. IP54 waterproof provides great protection level.

Materials of Housing : Aluminium

Materials of Optics : PC

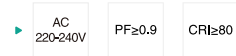

| Code         | Watt    | Size(AxBmm) | Cut-out(mm) | Lumen(±5%) | N.W/pc(kgs) | Q'ty/CTN |
|--------------|---------|-------------|-------------|------------|-------------|----------|
| DL422-3-13W  | 10W/13W | Ø115x52     | 90-95       | 1400lm     | 0.20        | 36PCS    |
| DL422-4-15W  | 12W/15W | Ø145x55     | 120-130     | 1700lm     | 0.25        | 36PCS    |
| DL422-5-25W  | 20W/25W | Ø170x60     | 140-150     | 2950lm     | 0.34        | 24PCS    |
| DL422-6-25W  | 20W/25W | Ø190x62     | 160-170     | 3000lm     | 0.37        | 12PCS    |
| DL422-8-35W  | 28W/35W | Ø235x67     | 200-210     | 4300lm     | 0.47        | 12PCS    |
| DL422-10-40W | 30W/40W | Ø280x78     | 230-260     | 5000lm     | 0.61        | 6PCS     |

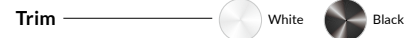

# DL137 Downlight

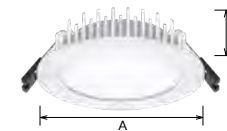

DL137A flat cover & DL137B step cover, super slim downlight. It adopts high lumen SMD LED with even light output. External driver is available for triac dim. It is IP54 for LED cover part and can do CCT changeable.

Materials of Housing : Aluminium Coated Plastic

Materials of Optics : PC

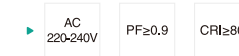
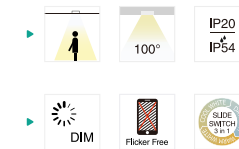

| Code          | Watt | Size(AxBmm) | Cut-out(mm) | Lumen(±5%) | N.W/pc(kgs) | Q'ty/CTN |
|---------------|------|-------------|-------------|------------|-------------|----------|
| DL137A-2.5-7W | 7W   | Ø85x30      | Ø68-75      | 750lm      | 0.17        | 48PCS    |
| DL137A-3-8W   | 8W   | Ø110x30     | Ø90-100     | 940lm      | 0.20        | 36PCS    |
| DL137B-2.5-7W | 7W   | Ø85x36      | Ø68-75      | 710lm      | 0.18        | 48PCS    |
| DL137B-3-8W   | 8W   | Ø110x36     | Ø90-100     | 900lm      | 0.21        | 36PCS    |
| DL137B-4-12W  | 12W  | Ø145x46     | Ø120-130    | 1480lm     | 0.36        | 24PCS    |
| DL137B-4-16W  | 16W  | Ø145x46     | Ø120-130    | 1970lm     | 0.36        | 24PCS    |
| DL137B-5-18W  | 18W  | Ø170x46     | Ø140-150    | 2250lm     | 0.42        | 12PCS    |
| DL137B-6-18W  | 18W  | Ø190x46     | Ø160-170    | 2370lm     | 0.54        | 12PCS    |
| DL137B-6-25W  | 25W  | Ø190x46     | Ø160-170    | 3180lm     | 0.54        | 12PCS    |
| DL137B-6-30W  | 30W  | Ø190x46     | Ø160-170    | 4000lm     | 0.54        | 12PCS    |
| DL137B-8-18W  | 18W  | Ø235x46     | Ø200-210    | 2430lm     | 0.72        | 12PCS    |
| DL137B-8-25W  | 25W  | Ø235x46     | Ø200-210    | 3285lm     | 0.72        | 12PCS    |
| DL137B-8-35W  | 35W  | Ø235x46     | Ø200-210    | 4420lm     | 0.72        | 12PCS    |





# DL110 Downlight



DL110 LED downlight is with high lumen SMD LED. IP65 waterproof for indoor and outdoor use.

- ▶
- ▶
- ▶
- ▶



Materials of Housing : Aluminium  
Materials of Optics : PMMA

| Code        | Watt | Size(AxBmm) | Cut-out(mm) | Lumen(±5%) | N.W/pc(kgs) | Q'ty/CTN |
|-------------|------|-------------|-------------|------------|-------------|----------|
| DL110-3-13W | 13W  | Ø115x55.5   | Ø95-100     | 1320lm     | 0.40        | 24PCS    |
| DL110-4-18W | 18W  | Ø155x67     | Ø120-130    | 1830lm     | 0.61        | 24PCS    |
| DL110-6-25W | 25W  | Ø195x46.5   | Ø175-185    | 2550lm     | 0.75        | 12PCS    |
| DL110-8-35W | 35W  | Ø235x54.5   | Ø205-215    | 3570lm     | 1.08        | 12PCS    |

CCT — 3000K — 4000K — 5700K

Trim — White — Black

# DL54 Downlight



DL54 LED downlight with SMD LED, internal driver for triac dimmable available. IP40/IP54 available for choice. CCT switchable by slide switch is available.

Materials of Housing : Aluminium Coated Plastic  
Materials of Optics : PMMA

- ▶
- ▶
- ▶
- ▶



| Code               | Watt | Size(AxBmm) | Cut-out(mm) | Lumen(±5%) | N.W/pc(kgs) | Q'ty/CTN |
|--------------------|------|-------------|-------------|------------|-------------|----------|
| DL54C-2.5-7W-P3    | 7W   | Ø85x68      | Ø68-75      | 700lm      | 0.12        | 50PCS    |
| DL54C-3-8W         | 8W   | Ø115x58     | Ø90-95      | 750lm      | 0.20        | 30PCS    |
| DL54C-3-8W-C3(P3)  | 8W   | Ø115x61     | Ø90-95      | 750lm      | 0.20        | 30PCS    |
| DL54C-3-10W        | 10W  | Ø115x58     | Ø90-95      | 940lm      | 0.20        | 30PCS    |
| DL54C-3-10W-C3(P3) | 10W  | Ø115x61     | Ø90-95      | 940lm      | 0.20        | 30PCS    |
| DL54B-4-13W        | 13W  | Ø145x61     | Ø120-130    | 1100lm     | 0.28        | 30PCS    |
| DL54B-4-13W-C3(P3) | 13W  | Ø145x62.5   | Ø120-130    | 1300lm     | 0.28        | 30PCS    |
| DL54B-6-16W        | 16W  | Ø190x74     | Ø160-170    | 1550lm     | 0.51        | 30PCS    |
| DL54B-6-16W-C3(P3) | 16W  | Ø190x75.5   | Ø160-170    | 1760lm     | 0.41        | 30PCS    |
| DL54B-8-20W        | 20W  | Ø225x84     | Ø200-210    | 1840lm     | 0.64        | 20PCS    |
| DL54B-8-20W-C3(P3) | 20W  | Ø225x84     | Ø200-210    | 2100lm     | 0.52        | 20PCS    |

CCT — 3000K — 4000K — 5700K

Trim — White

Ring — ACC-DL54 Nickel brushed



# DL41 Downlight

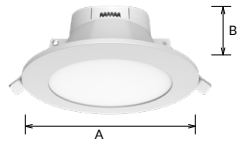

DL41 LED downlight with SMD LED, internal driver for triac dimmable available. IP40/IP54 available for choice. CCT switchable by slide switch is available.

Materials of Housing : Aluminium Coated Plastic  
Materials of Optics : PMMA

- ▶
- ▶
- ▶
- ▶

| Code                | Watt | Size(AxBmm) | Cut-out(mm) | Lumen(±5%) | N.W/pc(kgs) | Q'ty/CTN |
|---------------------|------|-------------|-------------|------------|-------------|----------|
| DL41C-2.5-7W        | 7W   | Ø85x55      | Ø70-75      | 620lm      | 0.12        | 50PCS    |
| DL41C-2.5-7W-C3(P3) | 7W   | Ø85x63      | Ø70-75      | 650lm      | 0.12        | 50PCS    |
| DL41C-3-8W          | 8W   | Ø115x58     | Ø90-95      | 750lm      | 0.20        | 30PCS    |
| DL41C-3-8W-C3(P3)   | 8W   | Ø115x61     | Ø90-95      | 800lm      | 0.20        | 30PCS    |
| DL41C-3-10W         | 10W  | Ø115x58     | Ø90-95      | 880lm      | 0.20        | 30PCS    |
| DL41C-3-10W-C3(P3)  | 10W  | Ø115x61     | Ø90-95      | 940lm      | 0.20        | 30PCS    |
| DL41B-4-13W         | 13W  | Ø145x61     | Ø120-130    | 1210lm     | 0.22        | 30PCS    |
| DL41B-4-13W-C3(P3)  | 13W  | Ø145x62.5   | Ø120-130    | 1320lm     | 0.22        | 30PCS    |
| DL41B-6-16W         | 16W  | Ø190x74     | Ø160-170    | 1670lm     | 0.51        | 30PCS    |
| DL41B-6-16W-C3(P3)  | 16W  | Ø190x75.5   | Ø160-170    | 1840lm     | 0.51        | 30PCS    |
| DL41B-8-20W-C3(P3)  | 20W  | Ø225x84     | Ø200-210    | 2200lm     | 0.64        | 20PCS    |

CCT ——— 3000K ——— 4000K ——— 5700K

Ring ——— ACC-DL41-2.5/ ACC-DL41-3 Nickel brushed

Trim ——— White

# DL41-S1 Downlight

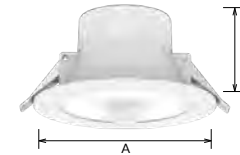

DL41-S1 LED downlight with PIR sensor function, SMD LED, internal driver. IP54 waterproof for cover. CCT switchable by slide switch is available.

Materials of Housing : Aluminium Coated Plastic  
Materials of Optics : PC

- ▶
- ▶
- ▶
- ▶

| Code          | Watt | Size(AxBmm) | Cut-out(mm) | Lumen(±5%) | N.W/pc(kgs) | Q'ty/CTN |
|---------------|------|-------------|-------------|------------|-------------|----------|
| DL41-3-8W-S1  | 8W   | Ø115x70     | Ø90-95      | 690lm      | 0.20        | 30PCS    |
| DL41-3-10W-S1 | 10W  | Ø115x70     | Ø90-95      | 830lm      | 0.20        | 30PCS    |

CCT ——— 3000K ——— 4000K ——— 5700K

Trim ——— White



# DL317 Downlight



DL317 LED downlight adopts high lumen SMD LED, deep housing has been deepened to reduce the glare. Dimmable flicker free driver shares great popularity by the excellent dimming effect. Interchangeable CCT with slide switch is available, IP54 waterproof for front side.

Materials of Housing : Aluminium coated plastic  
Materials of Optics : PC

- ▶
- ▶
- ▶
- ▶

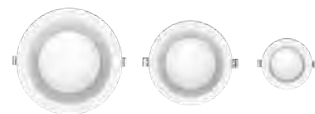

| Code        | Watt | Size(AxBmm) | Cut-out(mm) | Lumen(±5%) | N.W/pc(kgs) | Q'ty/CTN |
|-------------|------|-------------|-------------|------------|-------------|----------|
| DL317-3-10W | 10W  | Ø115x70.5   | Ø90-95      | 910lm      | 0.20        | 30PCS    |
| DL317-6-16W | 16W  | Ø190x102    | Ø160-170    | 1660lm     | 0.40        | 12PCS    |
| DL317-8-20W | 20W  | Ø240x117    | Ø200-210    | 2250lm     | 0.56        | 12PCS    |

CCT — 3000K — 4000K — 5700K

Trim — White — Black

# DL134 Downlight



DL134 LED downlight with SMD LED, internal driver. Deep trim design provides soft lighting. IP54 waterproof for internal use. CCT switchable by slide switch is available.

Materials of Housing : Aluminium Coated Plastic  
Materials of Optics : PC

- ▶
- ▶
- ▶
- ▶



| Code        | Watt | Size(AxBmm) | Cut-out(mm) | Lumen(±5%) | N.W/pc(kgs) | Q'ty/CTN |
|-------------|------|-------------|-------------|------------|-------------|----------|
| DL134-3-10W | 10W  | Ø115x83.4   | Ø90-95      | 880lm      | 0.17        | 36PCS    |
| DL134-4-13W | 13W  | Ø145x97.5   | Ø125-130    | 1230lm     | 0.25        | 24PCS    |
| DL134-6-16W | 16W  | Ø190x115.3  | Ø160-170    | 1720lm     | 0.40        | 12PCS    |
| DL134-8-20W | 20W  | Ø240x132.5  | Ø200-210    | 2150lm     | 0.55        | 12PCS    |

CCT — 3000K — 4000K — 5700K

Trim — White



# DL222 Downlight

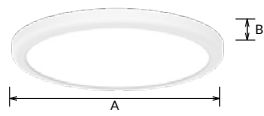

DL222 LED downlight with SMD LED, AC to DC internal driver, round shape design. Recessed and surface mounted installation are available. Adjustable cutout size from Ø65-205mm and Ø120-260mm for recessed installation, CCT and power is switchable for choice.

Materials of Housing : PC/Aluminium  
Materials of Optics : PS

- 120°
- IP20
- DIM
- Flicker Free
- 3 in 1
- PIR Sensor
- Adjustable Power
- AC 200-240V
- PF ≥ 0.9
- CRI ≥ 80
- SAA
- RoHS
- CE

| Code            | Watt        | Size(AxBmm) | Cut-out(mm) | Lumen(±5%) | N.W/pc(kgs) | Q'ty/CTN |
|-----------------|-------------|-------------|-------------|------------|-------------|----------|
| DL222-8-16W     | 16W         | Ø235x16     | Ø65-205     | 1800lm     | 0.36        | 20PCS    |
| DL222-8-16W-A3  | 10W/13W/16W | Ø235x16     | Ø65-205     | 1800lm     | 0.36        | 20PCS    |
| DL222-10-22W    | 22W         | Ø300x20     | Ø120-260    | 2600lm     | 0.68        | 10PCS    |
| DL222-10-22W-A3 | 16W/20W/22W | Ø300x20     | Ø120-260    | 2600lm     | 0.68        | 10PCS    |
| DL222-10-22W-S  | 22W         | Ø300x20     | Ø120-260    | 2600lm     | 0.68        | 10PCS    |

CCT — 3000K — 4000K — 5700K

Trim — White

# DL222B Downlight

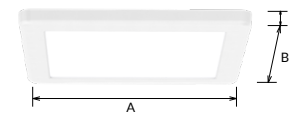

DL222B LED downlight with SMD LED, AC to DC internal driver, square shape design. Recessed and surface mounted installation are available. Adjustable cutout size from Ø65-205mm and Ø120-260mm for recessed installation, CCT and power is switchable for choice.

Materials of Housing : PC/Aluminium  
Materials of Optics : PS

- 120°
- IP20
- DIM
- Flicker Free
- 3 in 1
- Adjustable Power
- AC 200-240V
- PF ≥ 0.9
- CRI ≥ 80
- SAA
- RoHS
- CE

| Code             | Watt        | Size(AxBxCmm) | Cut-out(mm) | Lumen(±5%) | N.W/pc(kgs) | Q'ty/CTN |
|------------------|-------------|---------------|-------------|------------|-------------|----------|
| DL222B-8-16W     | 16W         | 235x235x16    | Ø65-205     | 1800lm     | 0.55        | 20PCS    |
| DL222B-8-16W-A3  | 10W/13W/16W | 235x235x16    | Ø65-205     | 1800lm     | 0.55        | 20PCS    |
| DL222B-10-22W    | 22W         | 300x300x20    | Ø120-260    | 2500lm     | 0.83        | 20PCS    |
| DL222B-10-22W-A3 | 16W/20W/22W | 300x300x20    | Ø120-260    | 2500lm     | 0.83        | 20PCS    |

CCT — 3000K — 4000K — 5700K

Trim — White



# Surface mounted to Recessed

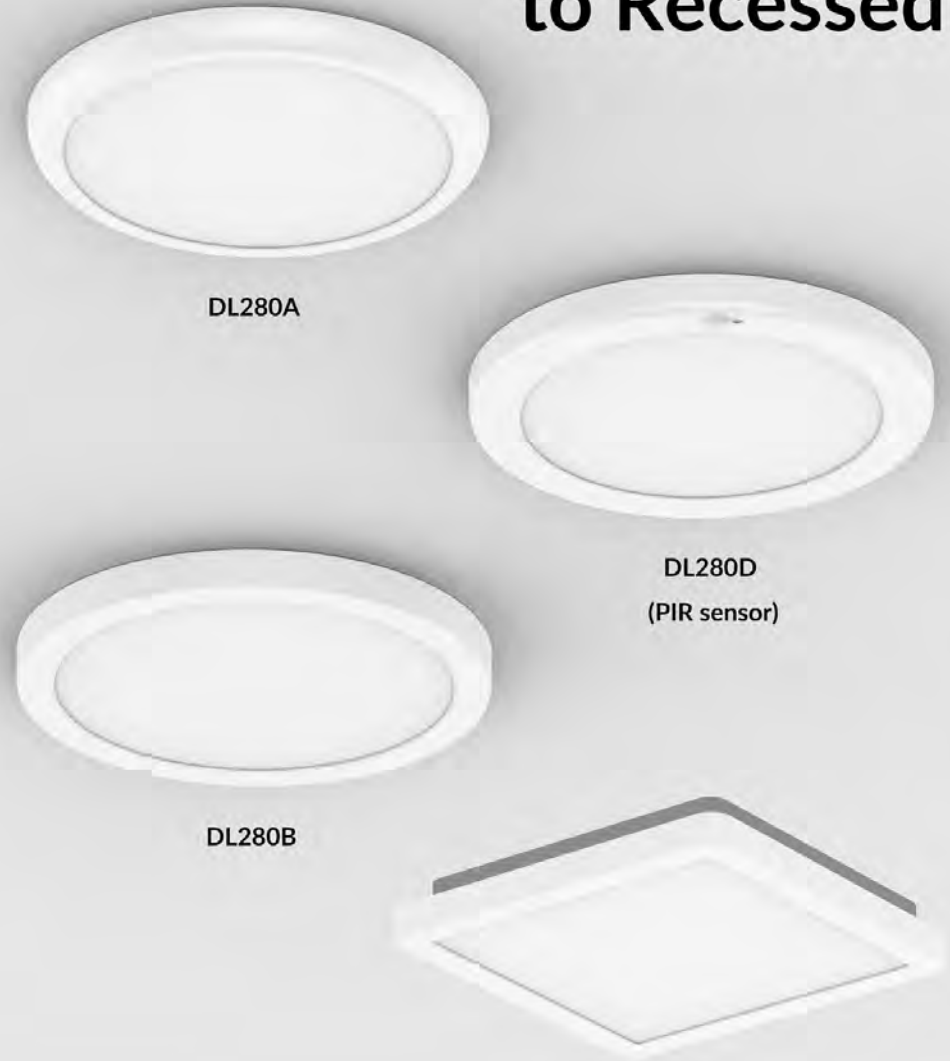

## DL280 Downlight

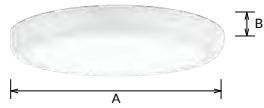

DL280 is a downlight with adjustable cutout from 65~205mm and 120~260mm for recessed installation. Super slim with internal driver and quick connector makes installation easy. Interchangeable CCT and power with slide switch are available. Triac dimmable and flicker free are used.

Materials of Housing : PC/Aluminium  
Materials of Optics : PS

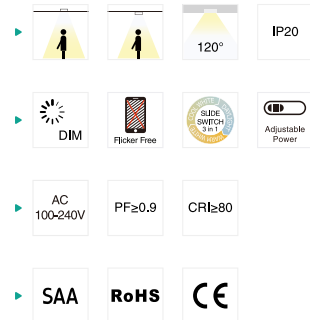

| Code             | Watt        | Size(AxBxCmm) | Cut-out(mm) | Lumen(±5%) | N.W/pc(kgs) | Q'ty/CTN |
|------------------|-------------|---------------|-------------|------------|-------------|----------|
| DL280-8-16W      | 16W         | Ø235x22       | Ø65-205     | 1700lm     | 0.46        | 20PCS    |
| DL280-10-22W     | 22W         | Ø300x25       | Ø120-260    | 2600lm     | 0.78        | 10PCS    |
| DL280C-8-16W     | 16W         | 235x235x22    | Ø65-205     | 1700lm     | 0.50        | 20PCS    |
| DL280C-10-22W    | 22W         | 300x300x25    | Ø120-260    | 2600lm     | 0.93        | 10PCS    |
| DL280D-10-22W-SS | 16W/20W/22W | Ø300x25.5     | Ø120-260    | 2400lm     | 0.73        | 10PCS    |

CCT — 3000K — 4000K — 5700K

Trim — White

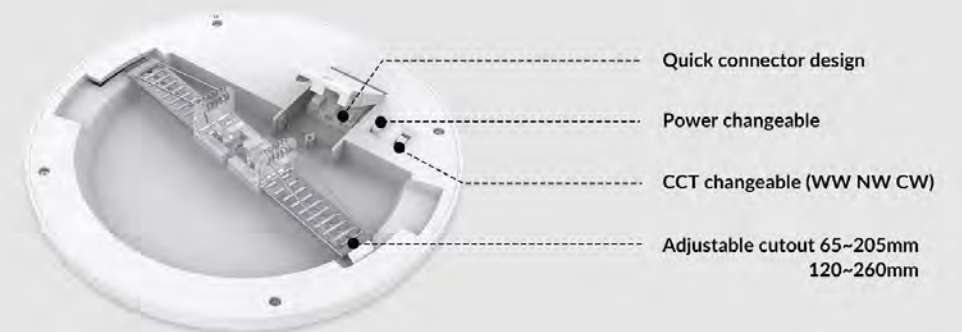

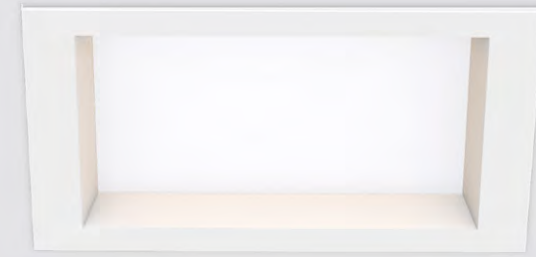
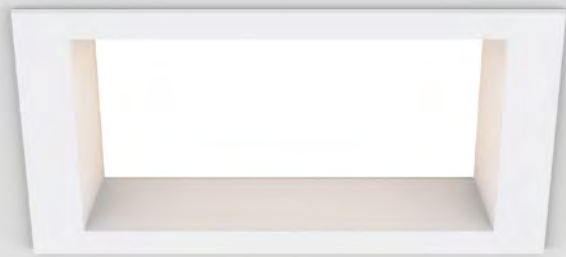

# DL308B Downlight

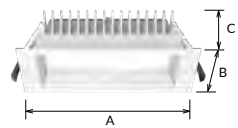

DL308B LED downlight as square design is with high lumen SMD LED, external driver triac dimmable as option, IP54 protection level. CCT changeable by slide switch is available.

- ▶ 90°
- ▶
- ▶
- ▶

Materials of Housing : Aluminium  
Materials of Optics : PC



| Code         | Watt | Size(AxBxCmm) | Cut-out(mm) | Lumen(±5%) | N.W/pc(kgs) | Q'ty/CTN |
|--------------|------|---------------|-------------|------------|-------------|----------|
| DL308B-3-10W | 10W  | 110x110x52    | 90x90       | 1050lm     | 0.26        | 24PCS    |
| DL308B-4-12W | 12W  | 145x145x53    | 120x120     | 1560lm     | 0.40        | 18PCS    |
| DL308B-4-18W | 18W  | 145x145x53    | 120x120     | 2160lm     | 0.40        | 18PCS    |
| DL308B-6-18W | 18W  | 190x190x53    | 160x160     | 2195lm     | 0.58        | 12PCS    |
| DL308B-6-25W | 25W  | 190x190x53    | 160x160     | 2830lm     | 0.58        | 12PCS    |
| DL308B-8-18W | 18W  | 228x228x55    | 200x200     | 2450lm     | 0.92        | 6PCS     |
| DL308B-8-25W | 25W  | 228x228x55    | 200x200     | 3270lm     | 0.92        | 6PCS     |
| DL308B-8-35W | 35W  | 228x228x55    | 200x200     | 4380lm     | 0.92        | 6PCS     |

CCT — 3000K — 4000K — 5700K

Trim — White Black

# DL34 Downlight

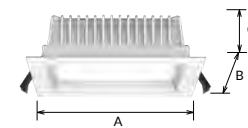

DL34 LED downlight with high lumen SMD LED, square shape, external driver triac, 0~10V, DALI for option. IP20/IP44 waterproof available.

Materials of Housing : Aluminium  
Materials of Optics : PMMA

- ▶ 90°
- ▶
- ▶
- ▶

| Code       | Watt | Size(AxBxCmm) | Cut-out(mm) | Lumen(±5%) | N.W/pc(kgs) | Q'ty/CTN |
|------------|------|---------------|-------------|------------|-------------|----------|
| DL34-3-13W | 13W  | 110x110x44    | 90-95       | 940lm      | 0.40        | 24PCS    |
| DL34-6-25W | 25W  | 190x190x54    | 160-170     | 2300lm     | 1.11        | 12PCS    |

CCT — 3000K — 4000K — 5700K

Trim — White Black



# DL96 Downlight

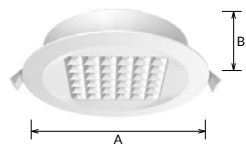

DL96 LED downlight with SMD LED with round shape design, internal driver. IP54 waterproof. Grilling design effectively reduce the UGR index. High lumen output 110lm/W. Push button looping connection terminal saves much installation time.

Materials of Housing : Aluminium  
Materials of Optics : PC

- ▶ 90°
- ▶
- ▶
- ▶

| Code       | Watt | Size(AxBmm) | Cut-out(mm) | Lumen(±5%) | N.W/pc(kgs) | Q'ty/CTN |
|------------|------|-------------|-------------|------------|-------------|----------|
| DL96-3-10W | 10W  | Ø110x40     | Ø90-95      | 1070lm     | 0.22        | 30PCS    |
| DL96-6-18W | 18W  | Ø190x40     | Ø160-170    | 2070lm     | 0.44        | 24PCS    |
| DL96-8-25W | 25W  | Ø228x40     | Ø200-210    | 3000lm     | 0.70        | 20PCS    |

CCT — 3000K — 4000K — 5700K

Trim — White — Silver

# DL105 Downlight



DL105 LED downlight with SMD LED with square shape design, internal driver. IP54 waterproof. Grilling design effectively reduce the UGR index. High lumen output 110lm/W. Push button looping connection terminal saves much installation time.

Materials of Housing : Aluminium  
Materials of Optics : PC

- ▶ 90°
- ▶
- ▶
- ▶

| Code        | Watt | Size(AxBxCmm) | Cut-out(mm) | Lumen(±5%) | N.W/pc(kgs) | Q'ty/CTN |
|-------------|------|---------------|-------------|------------|-------------|----------|
| DL105-3-10W | 10W  | 110x110x39    | 90-95       | 1070lm     | 0.24        | 30PCS    |
| DL105-6-18W | 18W  | 190x190x43.5  | 160-170     | 2070lm     | 0.54        | 24PCS    |
| DL105-8-25W | 25W  | 228x228x43.5  | 200-210     | 3000lm     | 0.84        | 20PCS    |

CCT — 3000K — 4000K — 5700K

Trim — White — Silver

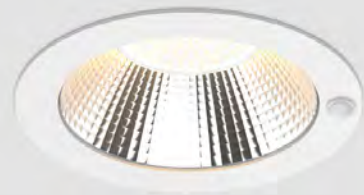
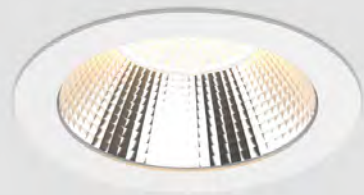

# DL367 Downlight



DL367 SMD downlight is with high lumen efficiency 130lm/w as external driver, The concave design in front and reflector+lens opticcombination reduced the height of the lamp and make it anti-glare. Besides, can do surface mounted with extra accessory for 4/6/8 inches. More function as CCT adjustable, sensor available, one lamp with multiple function use.

Materials of Housing : Aluminium die-casting  
Materials of Optics : PC+Aluminium

- ▶
- ▶
- ▶
- ▶



| Code           | Watt | Size(AxBmm) | Cut-out(mm) | Lumen(±5%) | N.W/pc(kgs) | Q'ty/CTN |
|----------------|------|-------------|-------------|------------|-------------|----------|
| DL367-4-9W     | 9W   | Ø145x55     | Ø120-130    | 1300lm     | 0.32        | 24PCS    |
| DL367-4-12W    | 12W  | Ø145x55     | Ø120-130    | 1750lm     | 0.32        | 24PCS    |
| DL367-5-11W    | 11W  | Ø170x58     | Ø140-150    | 1600lm     | 0.39        | 24PCS    |
| DL367-5-16W    | 16W  | Ø170x58     | Ø140-150    | 2200lm     | 0.39        | 24PCS    |
| DL367-6-12W    | 12W  | Ø190x61     | Ø160-170    | 1780lm     | 0.44        | 24PCS    |
| DL367-6-18W    | 18W  | Ø190x61     | Ø160-170    | 2550lm     | 0.44        | 24PCS    |
| DL367-6-24W    | 24W  | Ø190x61     | Ø160-170    | 3200lm     | 0.44        | 24PCS    |
| DL367-8-12W    | 12W  | Ø228x61     | Ø200-210    | 1850lm     | 0.59        | 24PCS    |
| DL367-8-18W    | 18W  | Ø228x61     | Ø200-210    | 2650lm     | 0.59        | 24PCS    |
| DL367-8-24W    | 24W  | Ø228x61     | Ø200-210    | 3450lm     | 0.59        | 24PCS    |
| DL367-6-9W-S1  | 9W   | Ø180x63     | Ø160-170    | 1300lm     | 0.6         | 12PCS    |
| DL367-6-12W-S1 | 12W  | Ø180x63     | Ø160-170    | 1750lm     | 0.6         | 12PCS    |

CCT ——— 2700K ——— 3000K ——— 4000K

Trim ——— White Black

Conversion housing ——— ACC-DL367-4-WT ACC-DL367-6-WT ACC-DL367-8-WT

# DL264 Downlight



DL264 LED downlight with anti-glare UGR<19 and external driver design. Adopting high lumen SMD light source 100lm/W, the scale PC shade and reflector make a uniform light output. Interchangeable CCT and IP54 in front are available.

Materials of Housing : PC/Aluminium  
Materials of Optics : PC

- ▶
- ▶
- ▶
- ▶



| Code        | Watt | Size(AxBmm) | Cut-out(mm) | Lumen(±5%) | N.W/pc(kgs) | Q'ty/CTN |
|-------------|------|-------------|-------------|------------|-------------|----------|
| DL264-3-10W | 10W  | Ø115x67mm   | Ø90-95mm    | 950lm      | 0.21        | 30PCS    |
| DL264-3-13W | 13W  | Ø115x67mm   | Ø90-95mm    | 1200lm     | 0.21        | 30PCS    |
| DL264-4-13W | 13W  | Ø145x73mm   | Ø120-130mm  | 1200lm     | 0.26        | 24PCS    |
| DL264-4-18W | 18W  | Ø145x73mm   | Ø120-130mm  | 1500lm     | 0.26        | 24PCS    |
| DL264-5-13W | 13W  | Ø170x86mm   | Ø140-150mm  | 1350lm     | 0.31        | 24PCS    |
| DL264-5-18W | 18W  | Ø170x86mm   | Ø140-150mm  | 1850lm     | 0.31        | 24PCS    |
| DL264-5-25W | 25W  | Ø170x86mm   | Ø140-150mm  | 2650lm     | 0.31        | 24PCS    |
| DL264-6-18W | 18W  | Ø190x90mm   | Ø160-170mm  | 1850lm     | 0.36        | 12PCS    |
| DL264-6-25W | 25W  | Ø190x90mm   | Ø160-170mm  | 2650lm     | 0.36        | 12PCS    |
| DL264-6-30W | 30W  | Ø190x90mm   | Ø160-170mm  | 3150lm     | 0.36        | 12PCS    |
| DL264-8-18W | 18W  | Ø235x100mm  | Ø200-210mm  | 1850lm     | 0.52        | 12PCS    |
| DL264-8-25W | 25W  | Ø235x100mm  | Ø200-210mm  | 2650lm     | 0.52        | 12PCS    |
| DL264-8-35W | 35W  | Ø235x100mm  | Ø200-210mm  | 3600lm     | 0.52        | 12PCS    |

CCT ——— 3000K ——— 4000K ——— 5700K

Trim ——— White Black

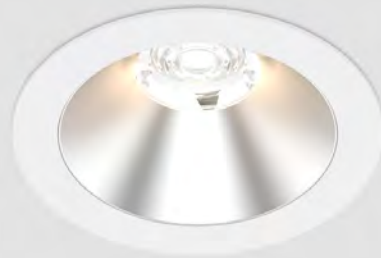

# DL405 NEW Downlight

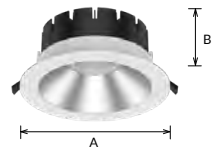

DL405 modular downlight, which realizes replaceable light source, optic lens and reflector, the light source module supports Zhaga standard. It keeps high efficiency 140lm/W and retains the deep design, which has UGR<19 anti glare effect.

Materials of Housing : Aluminium

Materials of Optics : PC+PMMA

- ▶
- ▶
- ▶
- ▶

| Code           | Watt                | Size(AxBmm) | Cut-out(mm) | Lumen(±5%) | N.W/pc(kgs) | Q'ty/CTN |
|----------------|---------------------|-------------|-------------|------------|-------------|----------|
| DL405-6-18W    | 18W                 | Ø190x95     | Ø155-170    | 2650lm     | 1.00        | 6PCS     |
| DL405-6-20W    | 20W                 | Ø190x95     | Ø155-170    | 2900lm     | 1.00        | 6PCS     |
| DL405-6-22W    | 22W                 | Ø190x95     | Ø155-170    | 3200lm     | 1.00        | 6PCS     |
| DL405-6-25W    | 25W                 | Ø190x95     | Ø155-170    | 3500lm     | 1.00        | 6PCS     |
| DL405-6-30W    | 30W                 | Ø190x95     | Ø155-170    | 4100lm     | 1.00        | 6PCS     |
| DL405-6-30W-A5 | 18W/20W/22W/25W/30W | Ø190x95     | Ø155-170    | 4100lm     | 1.00        | 6PCS     |
| DL405-8-18W    | 18W                 | Ø240x99     | Ø190-230    | 2650lm     | 1.35        | 6PCS     |
| DL405-8-20W    | 20W                 | Ø240x99     | Ø190-230    | 2900lm     | 1.35        | 6PCS     |
| DL405-8-22W    | 22W                 | Ø240x99     | Ø190-230    | 2350lm     | 1.35        | 6PCS     |
| DL405-8-25W    | 25W                 | Ø240x99     | Ø190-230    | 3500lm     | 1.35        | 6PCS     |
| DL405-8-30W    | 30W                 | Ø240x99     | Ø190-230    | 4200lm     | 1.35        | 6PCS     |
| DL405-8-36W    | 36W                 | Ø240x99     | Ø190-230    | 4750lm     | 1.35        | 6PCS     |
| DL405-8-36W-A5 | 18W/20W/25W/30W/36W | Ø240x99     | Ø190-230    | 4750lm     | 1.35        | 6PCS     |

# DL412 NEW Downlight

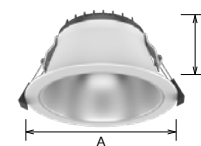

DL412 LED downlight is deep reflector design, which could be UGR<19. It adopts high lumen SMD reaching to 120lm/W. IP54 waterproof and CCT changeable are available.

Materials of Housing : PC/Aluminum

Materials of Optics : PC

- ▶
- ▶
- ▶
- ▶



| Code        | Watt | Size(AxBmm) | Cut-out(mm) | Lumen(±5%) | N.W/pc(kgs) | Q'ty/CTN |
|-------------|------|-------------|-------------|------------|-------------|----------|
| DL412-3-8W  | 8W   | Ø115x65     | Ø90-95      | 1000lm     | 0.26        | 30PCS    |
| DL412-4-10W | 10W  | Ø145x77     | Ø120-130    | 1400lm     | 0.39        | 24PCS    |
| DL412-4-13W | 13W  | Ø145x77     | Ø120-130    | 1700lm     | 0.39        | 24PCS    |
| DL412-5-15W | 15W  | Ø170x92     | Ø140-150    | 1900lm     | 0.45        | 24PCS    |
| DL412-5-18W | 18W  | Ø170x92     | Ø140-150    | 2300lm     | 0.45        | 24PCS    |
| DL412-6-15W | 15W  | Ø190x97     | Ø160-170    | 2000lm     | 0.52        | 12PCS    |
| DL412-6-20W | 20W  | Ø190x97     | Ø160-170    | 2700lm     | 0.52        | 12PCS    |
| DL412-6-25W | 25W  | Ø190x97     | Ø160-170    | 3300lm     | 0.52        | 12PCS    |
| DL412-8-18W | 18W  | Ø235x111    | Ø200-210    | 2500lm     | 0.70        | 6PCS     |
| DL412-8-25W | 25W  | Ø235x111    | Ø200-210    | 3550lm     | 0.70        | 6PCS     |
| DL412-8-30W | 30W  | Ø235x111    | Ø200-210    | 4250lm     | 0.70        | 6PCS     |

CCT ——— 2700K ——— 3000K ——— 4000K

Trim ——— White Black

Conversion ring ——— ACC-DL405-35W-30K  
ACC-DL405-35W-40K  
ACC-DL405-35W-50K  
ACC-DL405-30W-TW

ACC-DL405-6-36  
ACC-DL405-6-50  
ACC-DL405-8-36  
ACC-DL405-8-50

ACC-DL405-6-MS  
ACC-DL405-8-MS

ACC-DL405-6-SL  
ACC-DL405-8-SL

CCT ——— 3000K ——— 4000K ——— 5700K

Trim ——— White Black



## DL98A/B Downlight



DL98 integrated SMD LED downlight series, which is a high-performance LED downlight for accenting and general lighting, it has two reflector design optional, DL98A with faceted reflector and DL98B with specular reflector. The luminaire is easy to install with the combination of integrated driver and fast connector. Triac dimmable and 3CCT are available.

### Reflector



Materials of Housing : PC  
Materials of Optics : PC

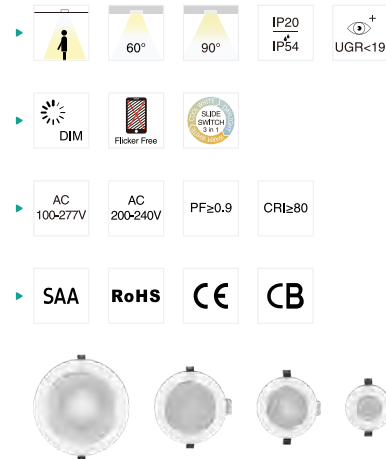

| Code        | Watt | Size(AxBmm) | Cut-out(mm) | Lumen(±5%) | N.W/pc(kgs) | Q'ty/CTN |
|-------------|------|-------------|-------------|------------|-------------|----------|
| DL98A-3-6W  | 6W   | Ø110x70     | 90-95       | 650lm      | 0.18        | 24PCS    |
| DL98A-4-13W | 13W  | Ø145x82     | 125-135     | 1500lm     | 0.28        | 24PCS    |
| DL98A-6-18W | 18W  | Ø172x95     | 150-165     | 2050lm     | 0.35        | 12PCS    |
| DL98A-8-18W | 18W  | Ø228x98     | 200-210     | 2100lm     | 0.54        | 12PCS    |
| DL98A-8-25W | 25W  | Ø228x98     | 200-210     | 3000lm     | 0.54        | 12PCS    |
| DL98B-3-6W  | 6W   | Ø110x70     | 90-95       | 650lm      | 0.18        | 24PCS    |
| DL98B-4-13W | 13W  | Ø145x82     | 125-135     | 1500lm     | 0.28        | 24PCS    |
| DL98B-6-18W | 18W  | Ø172x95     | 150-165     | 2050lm     | 0.35        | 12PCS    |
| DL98B-8-18W | 18W  | Ø228x98     | 200-210     | 2100lm     | 0.54        | 12PCS    |
| DL98B-8-25W | 25W  | Ø228x98     | 200-210     | 3000lm     | 0.54        | 12PCS    |



## DL138A/B Downlight

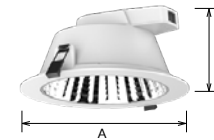

DL138 SMD LED downlight uses slide switch for color selection and is good for home and commercial project requirement. IP54 is available for bathroom and other wet locations. DL98B is 60° beam angle with specular reflector can reach UGR<19.

### Reflector

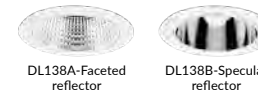

Materials of Housing : PC  
Materials of Optics : PC



| Code         | Watt | Size(AxBmm) | Cut-out(mm) | Lumen(±5%) | N.W/pc(kgs) | Q'ty/CTN |
|--------------|------|-------------|-------------|------------|-------------|----------|
| DL138A-3-6W  | 6W   | Ø110x70     | 90-95       | 650lm      | 0.24        | 24PCS    |
| DL138A-4-13W | 13W  | Ø145x82     | 125-135     | 1500lm     | 0.34        | 24PCS    |
| DL138A-6-18W | 18W  | Ø172x95     | 150-165     | 2050lm     | 0.45        | 12PCS    |
| DL138A-8-18W | 18W  | Ø228x98     | 200-210     | 2100lm     | 0.65        | 12PCS    |
| DL138A-8-25W | 25W  | Ø228x98     | 200-210     | 3000lm     | 0.65        | 12PCS    |
| DL138B-3-6W  | 6W   | Ø110x70     | 90-95       | 650lm      | 0.24        | 24PCS    |
| DL138B-4-13W | 13W  | Ø145x82     | 125-135     | 1500lm     | 0.34        | 24PCS    |
| DL138B-6-18W | 18W  | Ø172x95     | 150-165     | 2050lm     | 0.45        | 12PCS    |
| DL138B-8-18W | 18W  | Ø228x98     | 200-210     | 2100lm     | 0.65        | 12PCS    |
| DL138B-8-25W | 25W  | Ø228x98     | 200-210     | 3000lm     | 0.65        | 12PCS    |





# DL83 Downlight



DL83 SMD downlight, a high-performance LED downlight for accenting and general lighting. The luminaire provides enhanced glare control and leading performance, making it ideal for commercial and residential environments.

Materials of Housing : Aluminium  
Materials of Optics : PMMA

- ▶
- ▶
- ▶
- ▶



| Code       | Watt | Size(AxBmm) | Cut-out(mm) | Lumen(±5%) | N.W/pc(kgs) | Q'ty/CTN |
|------------|------|-------------|-------------|------------|-------------|----------|
| DL83-3-13W | 13W  | Ø110x80     | Ø90-100     | 1160lm     | 0.33        | 30PCS    |
| DL83-6-25W | 25W  | Ø190x100    | Ø160-180    | 2620lm     | 0.76        | 12PCS    |
| DL83-8-35W | 35W  | Ø230x110    | Ø200-220    | 3700lm     | 0.98        | 12PCS    |

CCT ——— 3000K ——— 4000K ——— 5700K ———

Trim ——— White Black



DL268A



DL268B



# DL268 Downlight

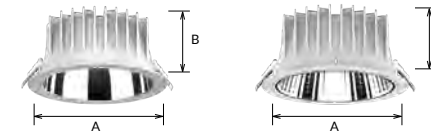

DL268 LED downlight is a traditional design with deep reflector, adopting high lumen SMD LED, providing a perfect combination of high lighting efficiency and comfortable lighting. Standard frame and invisible frame for option, complete size from 2.5inch to 10inch. UGR<19 for option, CCT changeable function is available. IP54 waterproof for room side.

Materials of Housing : Die-casting Aluminium

Materials of Optics : PC

- ▶
- ▶
- ▶
- ▶
- ▶



| Code            | Watt | Size(AxBmm) | Cut-out(mm) | Lumen(±5%) | N.W/pc(kgs) | Q'ty/CTN |
|-----------------|------|-------------|-------------|------------|-------------|----------|
| DL268A/B-2.5-8W | 8W   | Ø95x55      | Ø82-88      | 750lm      | 0.27        | 36PCS    |
| DL268A/B-3-10W  | 10W  | Ø108x55     | Ø90-95      | 800lm      | 0.29        | 36PCS    |
| DL268A/B-4-10W  | 10W  | Ø145x77     | Ø125-135    | 1100lm     | 0.58        | 18PCS    |
| DL268A/B-4-18W  | 18W  | Ø145x77     | Ø125-135    | 1900lm     | 0.58        | 18PCS    |
| DL268A/B-6-18W  | 18W  | Ø172x90     | Ø150-165    | 1900lm     | 0.69        | 12PCS    |
| DL268A/B-6-25W  | 25W  | Ø172x90     | Ø150-165    | 2800lm     | 0.69        | 12PCS    |
| DL268A/B-8-18W  | 18W  | Ø228x107    | Ø200-210    | 2000lm     | 1.13        | 12PCS    |
| DL268A/B-8-25W  | 25W  | Ø228x107    | Ø200-210    | 3000lm     | 1.13        | 12PCS    |
| DL268A/B-8-35W  | 35W  | Ø228x107    | Ø200-210    | 4000lm     | 1.13        | 12PCS    |
| DL268A/B-8-40W  | 40W  | Ø228x107    | Ø200-210    | 4300lm     | 1.13        | 12PCS    |
| DL268A/B-10-35W | 35W  | Ø280x123    | Ø230-260    | 4100lm     | 1.55        | 6PCS     |
| DL268A/B-10-45W | 45W  | Ø280x123    | Ø230-260    | 5000lm     | 1.55        | 6PCS     |
| DL268A/B-10-50W | 50W  | Ø280x123    | Ø230-260    | 5300lm     | 1.55        | 6PCS     |
| DL268A/B-4-10W  | 10W  | Ø145x77     | Ø125-135    | 1150lm     | 0.58        | 18PCS    |
| DL268A/B-4-13W  | 13W  | Ø145x77     | Ø125-135    | 1400lm     | 0.58        | 18PCS    |
| DL268A/B-6-18W  | 18W  | Ø172x90     | Ø150-165    | 2120lm     | 0.69        | 12PCS    |
| DL268A/B-8-18W  | 18W  | Ø228x107    | Ø200-210    | 2160lm     | 1.13        | 12PCS    |
| DL268A/B-8-25W  | 25W  | Ø228x107    | Ø200-210    | 3050lm     | 1.13        | 12PCS    |
| DL268A/B-8-32W  | 32W  | Ø228x107    | Ø200-210    | 3880lm     | 1.13        | 12PCS    |
| DL268A/B-10-32W | 32W  | Ø280x123    | Ø230-260    | 3950lm     | 1.55        | 6PCS     |
| DL268A/B-10-42W | 42W  | Ø280x123    | Ø230-260    | 5100lm     | 1.55        | 6PCS     |

CCT ——— 3000K ——— 4000K ——— 5700K ———

Trim ——— White Black



# DL315 Downlight

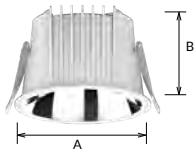

DL315 deep reflector downlight which adopts high lumen efficiency SMD 100lm/W. Three covers for option, honeycomb cover and tri-reflector cover make a low UGR. Adapter ring makes a wider application area and convenient installation. IP54 in front and tri-color changeable are available.

- ▶ IP20  
IP54
- ▶ DIM  
Flicker Free LED SWITCH 3.3V
- ▶ AC  
200-240V PF≥0.9 CRI≥80
- ▶ SAA RoHS CE



Materials of Housing : Die-casting Aluminium  
Materials of Optics : PC + Aluminium

| Code         | Watt | Size(AxBmm) | Cut-out(mm) | Lumen(±5%) | N.W/pc(kgs) | Q'ty/CTN |
|--------------|------|-------------|-------------|------------|-------------|----------|
| DL315-2.5-8W | 8W   | Ø87x73      | Ø68-75      | 760lm      | 0.24        | 24PCS    |
| DL315-3-10W  | 10W  | Ø110x84     | Ø95-100     | 1000lm     | 0.31        | 18PCS    |
| DL315-3-13W  | 13W  | Ø110x84     | Ø95-100     | 1200lm     | 0.31        | 18PCS    |
| DL315-4-18W  | 18W  | Ø135x96     | Ø120-125    | 1850lm     | 0.46        | 18PCS    |
| DL315-4-25W  | 25W  | Ø135x96     | Ø120-125    | 2350lm     | 0.46        | 18PCS    |
| DL315-6-25W  | 25W  | Ø160x117    | Ø150-155    | 2850lm     | 0.64        | 12PCS    |
| DL315-6-35W  | 35W  | Ø160x117    | Ø150-155    | 3850lm     | 0.64        | 12PCS    |
| DL315-8-35W  | 35W  | Ø186x128    | Ø170-175    | 3800lm     | 0.85        | 6PCS     |
| DL315-8-42W  | 42W  | Ø186x128    | Ø170-175    | 4400lm     | 0.85        | 6PCS     |

CCT ——— 3000K ——— 4000K ——— 5700K

Trim ——— White Black

## MORE POSSIBILITIES







# DL179 Downlight



DL179 SMD LED downlight, designed with a traditional deep reflector, which provides perfect and comfortable lighting. External driver solution both in dimmable and non-dimmable version achieves great dimming compatibility with world brand dimmers.

### Reflector

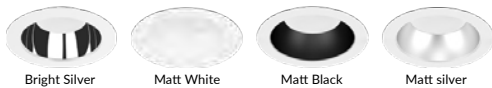

Materials of Housing : Die-casting Aluminium  
Materials of Optics : PC

| Code                | Watt        | Size(AxBmm) | Cut-out(mm) | Lumen(±5%)           | N.W/pc(kgs) | Q'ty/CTN |
|---------------------|-------------|-------------|-------------|----------------------|-------------|----------|
| DL179A-3-10W        | 10W         | Ø95x54      | Ø82-88      | 830lm                | 0.23        | 36PCS    |
| DL179A-3-10W        | 10W         | Ø95x54      | Ø82-88      | 1030lm               | 0.23        | 36PCS    |
| DL179B-3-10W        | 10W         | Ø110x54     | Ø90-95      | 870lm                | 0.27        | 36PCS    |
| DL179B-3-10W        | 10W         | Ø110x54     | Ø90-95      | 1040lm               | 0.27        | 36PCS    |
| DL179B-3-13W        | 13W         | Ø110x54     | Ø90-95      | 1140lm               | 0.27        | 36PCS    |
| DL179-4-10W         | 10W         | Ø145x78     | Ø125-135    | 900lm                | 0.46        | 18PCS    |
| DL179-4-12W         | 12W         | Ø145x78     | Ø125-135    | 1390lm               | 0.46        | 18PCS    |
| DL179-4-18W         | 18W         | Ø145x78     | Ø125-135    | 1950lm               | 0.46        | 18PCS    |
| DL179-4-25W         | 25W         | Ø145x78     | Ø125-135    | 2250lm               | 0.46        | 18PCS    |
| DL179-6-18W         | 18W         | Ø172x90     | Ø150-165    | 1900lm               | 0.67        | 12PCS    |
| DL179-6-18W         | 18W         | Ø172x90     | Ø150-165    | 2250lm               | 0.67        | 12PCS    |
| DL179-6-25W         | 25W         | Ø172x90     | Ø150-165    | 2650lm               | 0.67        | 12PCS    |
| DL179-6-35W         | 35W         | Ø172x90     | Ø150-165    | 3180lm               | 0.67        | 12PCS    |
| DL179-8-18W         | 18W         | Ø228x99     | Ø200-210    | 2070lm               | 1.08        | 12PCS    |
| DL179-8-25W         | 25W         | Ø228x99     | Ø200-210    | 2800lm               | 1.08        | 12PCS    |
| DL179-8-25W         | 25W         | Ø228x99     | Ø200-210    | 3000lm               | 1.08        | 12PCS    |
| DL179-8-35W/40W/45W | 35W/40W/45W | Ø228x99     | Ø200-210    | 4000lm/4400lm/4950lm | 1.08        | 12PCS    |

CCT — 3000K — 4000K — 5700K

Trim — White — Black

# DL179 Narrow Trim

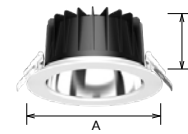

DL179 SMD LED downlight, designed with a traditional deep reflector and die-casting housing, provides perfect and comfortable lighting and excellent thermal dissipation. External driver solution both in dimmable and non-dimmable version achieves great dimming compatibility with world brand dimmers.

### Reflector



Materials of Housing : Aluminium  
Materials of Optics : PC

| Code         | Watt | Size(AxBmm) | Cut-out(mm) | Lumen(±5%) | N.W/pc(kgs) | Q'ty/CTN |
|--------------|------|-------------|-------------|------------|-------------|----------|
| DL179B-3-10W | 10W  | Ø100x54     | Ø90         | 870lm      | 0.23        | 36PCS    |
| DL179B-3-13W | 13W  | Ø100x54     | Ø90         | 1140lm     | 0.27        | 36PCS    |
| DL179-4-10W  | 10W  | Ø130x78     | Ø120        | 900lm      | 0.46        | 18PCS    |
| DL179-4-18W  | 18W  | Ø130x78     | Ø120        | 1950lm     | 0.46        | 18PCS    |
| DL179-4-25W  | 25W  | Ø130x78     | Ø120        | 2250lm     | 0.46        | 18PCS    |
| DL179-6-18W  | 18W  | Ø160x90     | Ø150        | 1900lm     | 0.67        | 12PCS    |
| DL179-6-25W  | 25W  | Ø160x90     | Ø150        | 2650lm     | 0.67        | 12PCS    |
| DL179-6-35W  | 35W  | Ø160x90     | Ø150        | 3180lm     | 0.67        | 12PCS    |
| DL179-8-18W  | 18W  | Ø210x99     | Ø200        | 2070lm     | 1.08        | 12PCS    |
| DL179-8-25W  | 25W  | Ø210x99     | Ø200        | 2800lm     | 1.08        | 12PCS    |
| DL179-8-35W  | 35W  | Ø210x99     | Ø200        | 4000lm     | 1.08        | 12PCS    |
| DL179-8-40W  | 40W  | Ø210x99     | Ø200        | 4400lm     | 1.08        | 12PCS    |
| DL179-8-45W  | 45W  | Ø210x99     | Ø200        | 4500lm     | 1.08        | 12PCS    |

CCT — 3000K — 4000K — 5700K

Trim — White — Black



# DL179 Downlight Drop-glass

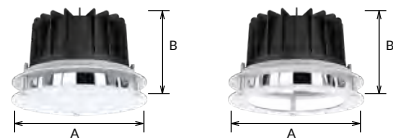

DL179 deep reflector downlight with decorative frosted glass ring and frosted glass cover options. It provides a softer light output and back light effect. The decorative glass ring or frame are very easy to disassemble. The light effect of the glass cover will be 12~18% lower than standard cover.

### Reflector



Materials of Housing : Die-casting Aluminium  
Materials of Optics : PC+Tempered glass

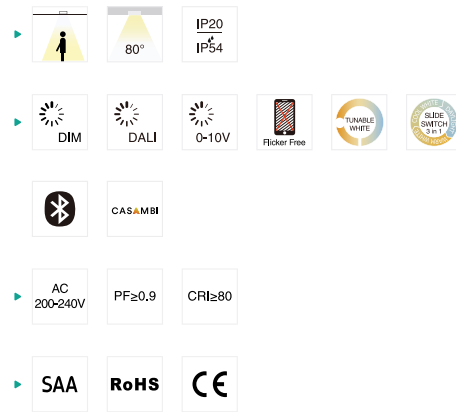

| Code        | Watt | Size(AxBmm) | Cut-out(mm) | Lumen(±5%) | N.W/pc(kgs) | Q'ty/CTN |
|-------------|------|-------------|-------------|------------|-------------|----------|
| DL179-4-10W | 10W  | 145x97      | Ø125-135    | 900lm      | 1.05        | 18PCS    |
| DL179-4-18W | 18W  | 145x97      | Ø125-135    | 1950lm     | 1.05        | 18PCS    |
| DL179-4-25W | 25W  | 145x97      | Ø125-135    | 2250lm     | 1.05        | 18PCS    |
| DL179-6-18W | 18W  | 172x109     | Ø150-165    | 1900lm     | 1.30        | 12PCS    |
| DL179-6-25W | 25W  | 172x109     | Ø150-165    | 2650lm     | 1.30        | 12PCS    |
| DL179-6-35W | 35W  | 172x109     | Ø150-165    | 3180lm     | 1.30        | 12PCS    |
| DL179-8-18W | 18W  | 228x118     | Ø200-210    | 2070lm     | 1.84        | 6PCS     |
| DL179-8-25W | 25W  | 228x118     | Ø200-210    | 2800lm     | 1.84        | 6PCS     |
| DL179-8-35W | 35W  | 228x118     | Ø200-210    | 4000lm     | 1.84        | 6PCS     |
| DL179-8-40W | 40W  | 228x118     | Ø200-210    | 4400lm     | 1.84        | 6PCS     |
| DL179-8-45W | 45W  | 228x118     | Ø200-210    | 4950lm     | 1.84        | 6PCS     |

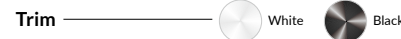

# DL197 Downlight Drop-glass

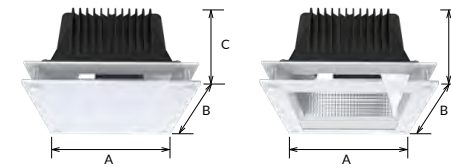

DL197 deep reflector downlight with decorative frosted glass ring and frosted glass cover options. It provides a softer light output and back light effect. The decorative glass ring or frame are very easy to disassemble. The light effect of the glass cover will be 12% lower than standard cover.

Materials of Housing : Die-casting Aluminium  
Materials of Optics : PC+Tempered glass

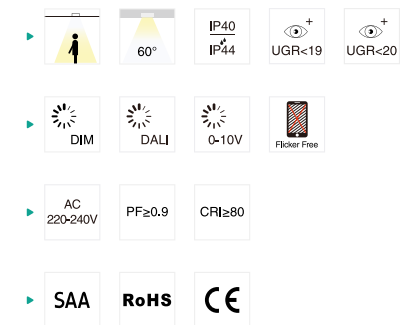

| Code        | Watt | Size(AxBxCmm) | Cut-out(mm) | Lumen(±5%) | N.W/pc(kgs) | Q'ty/CTN |
|-------------|------|---------------|-------------|------------|-------------|----------|
| DL197-6-18W | 18W  | 190x190x127   | 170x170     | 1400lm     | 1.73        | 6PCS     |
| DL197-6-22W | 22W  | 190x190x127   | 170x170     | 1869lm     | 1.73        | 6PCS     |
| DL197-6-25W | 25W  | 190x190x127   | 170x170     | 2165lm     | 1.73        | 6PCS     |
| DL197-6-32W | 32W  | 190x190x127   | 170x170     | 2833lm     | 1.73        | 6PCS     |



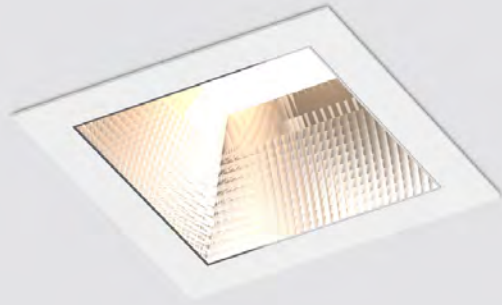

# DL197 Downlight

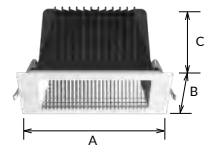

DL197 SMD LED downlight is a square-trim LED downlight for accenting and comfortable lighting. Designed with a traditional deep reflector, the luminaire offers enhanced glare control(UGR<19). IP44 waterproof in front for various application.

Materials of Housing : Die-casting Aluminium  
Materials of Optics : PMMA

- 60°
- IP40  
IP44
- UGR<19
- DIM
- DALI
- 0-10V
- Flicker Free
- TUNABLE WHITE
- SIDE SWITCH 3 in 1
- AC 200-240V
- PF≥0.9
- CRI≥80
- SAA
- RoHS
- CE

| Code        | Watt | Size(AxBxCmm) | Cut-out(mm) | Lumen(±5%) | N.W/pc(kgs) | Q'ty/CTN |
|-------------|------|---------------|-------------|------------|-------------|----------|
| DL197-6-18W | 18W  | 190x190x102   | 170x170     | 1760lm     | 1.02        | 8PCS     |
| DL197-6-22W | 22W  | 190x190x102   | 170x170     | 2120lm     | 1.02        | 8PCS     |
| DL197-6-25W | 25W  | 190x190x102   | 170x170     | 2420lm     | 1.02        | 8PCS     |
| DL197-6-32W | 32W  | 190x190x102   | 170x170     | 3070lm     | 1.02        | 8PCS     |

# DL178 Downlight Drop-glass

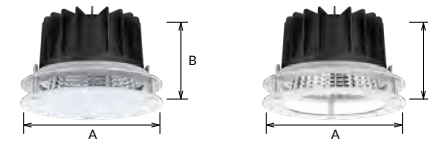

DL178 deep reflector downlight with decorative frosted glass ring and frosted glass cover options. It provides a softer light output and back light effect. The decorative glass ring or frame are very easy to disassemble. The light effect of the glass cover will be 12~18% lower than standard cover.

### Reflector



Materials of Housing : Aluminium

Materials of Optics : PC+Tempered glass

- 24°
  - 36°
  - 60°
  - IP20  
IP54
  - UGR<19
  - DIM
  - DALI
  - 0-10V
  - Flicker Free
  - CASAMBI
  - AC 200-240V
  - PF≥0.9
  - CRI≥80
  - CRI≥90
  - CRI≥97
  - SAA
  - RoHS
  - CE
- 

| Code        | Watt | Size(AxBmm) | Cut-out(mm) | Lumen(±5%) | N.W/pc(kgs) | Q'ty/CTN |
|-------------|------|-------------|-------------|------------|-------------|----------|
| DL178-4-10W | 10W  | Ø145x97     | Ø125-135    | 1012lm     | 1.05        | 18PCS    |
| DL178-4-18W | 18W  | Ø145x97     | Ø125-135    | 1980lm     | 1.05        | 18PCS    |
| DL178-4-25W | 25W  | Ø145x97     | Ø125-135    | 2420lm     | 1.05        | 18PCS    |
| DL178-6-18W | 18W  | Ø172x109    | Ø150-165    | 1936lm     | 1.30        | 12PCS    |
| DL178-6-25W | 25W  | Ø172x109    | Ø150-165    | 2508lm     | 1.30        | 12PCS    |
| DL178-6-35W | 35W  | Ø172x109    | Ø150-165    | 3230lm     | 1.30        | 12PCS    |
| DL178-8-18W | 18W  | Ø228x118    | Ø200-210    | 1822lm     | 1.84        | 6PCS     |
| DL178-8-25W | 25W  | Ø228x118    | Ø200-210    | 2508lm     | 1.84        | 6PCS     |
| DL178-8-35W | 35W  | Ø228x118    | Ø200-210    | 3520lm     | 1.84        | 6PCS     |

CCT — 3000K — 4000K — 5700K

Trim — White — Black

CCT — 2700K — 3000K — 4000K

Trim — White — Black



# DL178 Downlight

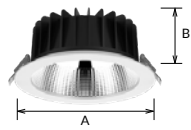

DL178 downlight with deep-set reflector provides better glaring control(UGR<19).The luminaire with modular design offers a wide choice of beam angles, 24°/36°/60°for optional. Adopted COB CITIZEN brand to reach high efficiency 110lm/W and energy saving. The luminaire blends harmoniously into ceilings, making it ideal for commercial and residential applications.

### Reflector



Materials of Housing : Aluminium  
Materials of Optics : PC

- Beam angles: 24°, 36°, 60°
- IP20, IP54, UGR<19
- DIM, DALI, 0-10V, Flicker Free, CASAMBI
- AC 200-240V, PF≥0.9, CRI≥80, CRI≥90, CRI≥97
- SAA, RoHS, CE, CB



| Code         | Watt | Size(AxBmm) | Cut-out(mm) | Lumen(±5%) | N.W/pc(kgs) | Q'ty/CTN |
|--------------|------|-------------|-------------|------------|-------------|----------|
| DL178A-3-10W | 10W  | Ø95x54      | Ø82-88      | 1120lm     | 0.23        | 36PCS    |
| DL178B-3-10W | 10W  | Ø110x54     | Ø90-95      | 1120lm     | 0.27        | 36PCS    |
| DL178B-3-13W | 13W  | Ø110x54     | Ø90-95      | 1300lm     | 0.27        | 36PCS    |
| DL178-4-10W  | 10W  | Ø145x78     | Ø125-135    | 1150lm     | 0.48        | 18PCS    |
| DL178-4-18W  | 18W  | Ø145x78     | Ø125-135    | 2250lm     | 0.48        | 18PCS    |
| DL178-4-25W  | 25W  | Ø145x78     | Ø125-135    | 2750lm     | 0.48        | 18PCS    |
| DL178-6-18W  | 18W  | Ø172x90     | Ø150-165    | 2200lm     | 0.71        | 12PCS    |
| DL178-6-25W  | 25W  | Ø172x90     | Ø150-165    | 2850lm     | 0.71        | 12PCS    |
| DL178-6-35W  | 35W  | Ø172x90     | Ø150-165    | 3670lm     | 0.71        | 12PCS    |
| DL178-8-18W  | 18W  | Ø228x99     | Ø200-210    | 2070lm     | 1.14        | 12PCS    |
| DL178-8-25W  | 25W  | Ø228x99     | Ø200-210    | 2850lm     | 1.14        | 12PCS    |
| DL178-8-35W  | 35W  | Ø228x99     | Ø200-210    | 4000lm     | 1.14        | 12PCS    |



# DL178 Narrow Trim

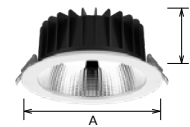

DL178 downlight with deep-set reflector provides better glaring control(UGR<19). The luminaire with modular design offers a wide choice of beam angles, 24°/36°/60°for optional. Adopted COB CITIZEN brand to reach high efficiency 110lm/W and energy saving. The luminaire blends harmoniously into ceilings, making it ideal for commercial and residential applications.

### Reflector



Materials of Housing : Aluminium  
Materials of Optics : PC

- Beam angles: 24°, 36°, 60°
- IP20, IP54, UGR<19
- DIM, DALI, 0-10V, Flicker Free, CASAMBI
- AC 200-240V, PF≥0.9, CRI≥80, CRI≥90, CRI≥97
- SAA, RoHS, CE, CB



| Code         | Watt | Size(AxBmm) | Cut-out(mm) | Lumen(±5%) | N.W/pc(kgs) | Q'ty/CTN |
|--------------|------|-------------|-------------|------------|-------------|----------|
| DL178B-3-10W | 10W  | Ø100x54     | Ø90         | 1120lm     | 0.27        | 36PCS    |
| DL178-3-13W  | 13W  | Ø100x54     | Ø90         | 1300lm     | 0.27        | 36PCS    |
| DL178-4-10W  | 10W  | Ø130x78     | Ø120        | 1150lm     | 0.48        | 18PCS    |
| DL178-4-18W  | 18W  | Ø130x78     | Ø120        | 2250lm     | 0.48        | 18PCS    |
| DL178-4-25W  | 25W  | Ø130x78     | Ø120        | 2750lm     | 0.48        | 18PCS    |
| DL178-6-18W  | 18W  | Ø160x90     | Ø150        | 2200lm     | 0.70        | 12PCS    |
| DL178-6-25W  | 25W  | Ø160x90     | Ø150        | 2850lm     | 0.70        | 12PCS    |
| DL178-6-35W  | 35W  | Ø160x90     | Ø150        | 3670lm     | 0.70        | 12PCS    |
| DL178-8-18W  | 18W  | Ø210x99     | Ø200        | 2070lm     | 1.11        | 12PCS    |
| DL178-8-25W  | 25W  | Ø210x99     | Ø200        | 2850lm     | 1.11        | 12PCS    |
| DL178-8-35W  | 35W  | Ø210x99     | Ø200        | 3900lm     | 1.11        | 12PCS    |



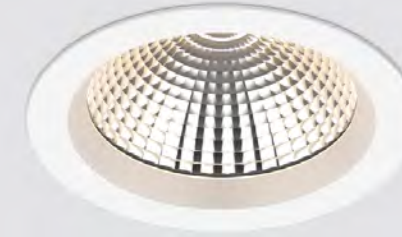
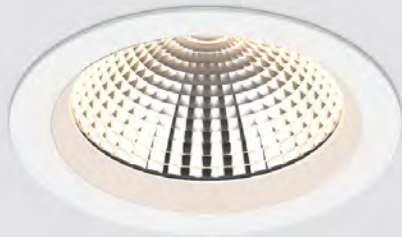

# DL229 Downlight

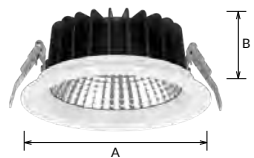

DL229 commercial downlight adopts high power COB LED chip, reflector and tempered glass. External driver is exchangeable through quick connector among non-dimmable driver, Triac dimmable, 0-10V and DALI dimmable drivers.

Materials of Housing : Die-casting Aluminium/PC  
Materials of Optics : PC+Tempered glass

- ▶ 24° 36° 45° 60° IP20 IP54
- ▶ DIM DALI 0-10V Flicker Free SLIDE SWITCH 20K
- ▶ AC 200-240V PF≥0.9 CRI≥80 CRI≥90 CRI≥97 SDCM <6
- ▶ SAA RoHS CE

| Code        | Watt | Size(AxBmm) | Cut-out(mm) | Lumen(±5%) | N.W/pc(kgs) | Q'ty/CTN |
|-------------|------|-------------|-------------|------------|-------------|----------|
| DL229-3-10W | 10W  | Ø110x53     | Ø90-95      | 988lm      | 0.25        | 30PCS    |
| DL229-3-10W | 10W  | Ø110x53     | Ø90-95      | 1250lm     | 0.33        | 30PCS    |
| DL229-3-12W | 12W  | Ø110x53     | Ø90-95      | 1312lm     | 0.25        | 30PCS    |
| DL229-4-12W | 12W  | Ø145x65     | Ø120-130    | 1485lm     | 0.41        | 20PCS    |
| DL229-4-18W | 18W  | Ø145x65     | Ø120-130    | 1997lm     | 0.41        | 20PCS    |
| DL229-4-18W | 18W  | Ø145x65     | Ø120-130    | 2300lm     | 0.50        | 20PCS    |
| DL229-4-25W | 25W  | Ø145x65     | Ø120-130    | 2733lm     | 0.41        | 20PCS    |
| DL229-6-18W | 18W  | Ø190x75     | Ø160-170    | 2079lm     | 0.69        | 12PCS    |
| DL229-6-25W | 25W  | Ø190x75     | Ø160-170    | 2798lm     | 0.69        | 12PCS    |
| DL229-6-25W | 25W  | Ø190x75     | Ø160-170    | 3200lm     | 0.77        | 12PCS    |
| DL229-6-33W | 33W  | Ø190x75     | Ø160-170    | 3674lm     | 0.69        | 12PCS    |
| DL229-8-18W | 18W  | Ø225x87     | Ø200-210    | 2066lm     | 0.96        | 12PCS    |
| DL229-8-25W | 25W  | Ø225x87     | Ø200-210    | 2801lm     | 0.96        | 12PCS    |
| DL229-8-30W | 30W  | Ø225x87     | Ø200-210    | 4000lm     | 1.08        | 12PCS    |
| DL229-8-33W | 33W  | Ø225x87     | Ø200-210    | 3659lm     | 0.96        | 12PCS    |
| DL229-8-42W | 42W  | Ø225x87     | Ø200-210    | 4823lm     | 0.96        | 12PCS    |

CCT — 2700K 3000K 4000K

Trim — White Black

# DL22 Downlight



DL22 the most classic commercial downlight adopts brand CITIZEN and Bridgelux COB, reflector and tempered glass. External driver is exchangeable through quick connector among non-dimmable driver, Triac dimmable, 0-10V and DALI dimmable drivers. Tunable White option adopts dual color temperature COB and dual DALI driver, supports the concept of Human Centric Lighting (HCL), widely applicable in health care center, nursing home, school etc.

Materials of Housing : Die-casting Aluminium  
Materials of Optics : PC+Tempered glass

- ▶ 24° 36° 45° 60° IP20 IP54
- ▶ DIM DALI 0-10V Flicker Free TUNABLE WHITE SLIDE SWITCH 20K
- ▶ AC 100-240V AC 200-240V PF≥0.9 CRI≥80 CRI≥90 CRI≥97
- ▶ SAA RoHS CE

| Code       | Watt | Size(AxBmm) | Cut-out(mm) | Lumen(±5%) | N.W/pc(kgs) | Q'ty/CTN |
|------------|------|-------------|-------------|------------|-------------|----------|
| DL22-3-10W | 10W  | Ø110x53     | Ø90-100     | 800lm      | 0.35        | 30PCS    |
| DL22-3-10W | 10W  | Ø110x53     | Ø90-95      | 1250lm     | 0.35        | 30PCS    |
| DL22-3-13W | 13W  | Ø110x53     | Ø90-100     | 1100lm     | 0.35        | 30PCS    |
| DL22-4-18W | 18W  | Ø145x65     | Ø120-130    | 2105lm     | 0.85        | 20PCS    |
| DL22-4-18W | 18W  | Ø145x65     | Ø120-130    | 2300lm     | 0.81        | 20PCS    |
| DL22-4-25W | 25W  | Ø145x65     | Ø120-130    | 2750lm     | 0.85        | 20PCS    |
| DL22-6-18W | 18W  | Ø190x75     | Ø160-170    | 2160lm     | 1.04        | 12PCS    |
| DL22-6-25W | 25W  | Ø190x75     | Ø160-170    | 2875lm     | 1.04        | 12PCS    |
| DL22-6-25W | 25W  | Ø190x75     | Ø160-170    | 3200lm     | 1.04        | 12PCS    |
| DL22-6-35W | 35W  | Ø190x75     | Ø160-170    | 3955lm     | 1.08        | 12PCS    |
| DL22-6-45W | 45W  | Ø190x75     | Ø160-170    | 4770lm     | 1.08        | 12PCS    |
| DL22-8-30W | 30W  | Ø225x87     | Ø200-210    | 4000lm     | 1.48        | 12PCS    |
| DL22-8-18W | 18W  | Ø225x87     | Ø200-210    | 2160lm     | 1.48        | 12PCS    |
| DL22-8-25W | 25W  | Ø225x87     | Ø200-210    | 2875lm     | 1.48        | 12PCS    |
| DL22-8-35W | 35W  | Ø225x87     | Ø200-210    | 3955lm     | 1.48        | 12PCS    |
| DL22-8-45W | 45W  | Ø225x87     | Ø200-210    | 4770lm     | 1.48        | 12PCS    |

CCT — 2700K 3000K 4000K

Trim — White Black Silver



# DL288 Downlight



DL288 LED downlight is unique designed with reflector and COB high power LED chip. LED module design could save SKU and offer an easy module replacement. Dimmable flicker free driver shares great popularity by the excellent dimming effect. IP54 waterproof for front part.

Materials of Housing : Die-casting Aluminium  
Materials of Optics : Aluminium + Tempered Glass

- ▶
- ▶
- ▶
- ▶



| Code          | Watt | Size(AxBmm) | Cut-out(mm) | Lumen(±5%) | N.W/pc(kgs) | Q'ty/CTN |
|---------------|------|-------------|-------------|------------|-------------|----------|
| DL288-2.5-10W | 10W  | Ø90x60      | 75-83       | 1180lm     | 0.25        | 36PCS    |
| DL288-6-18W   | 18W  | Ø172x96     | 150-160     | 2290lm     | 0.78        | 12PCS    |
| DL288-6-25W   | 25W  | Ø172x96     | 150-160     | 3070lm     | 0.78        | 12PCS    |
| DL288-8-25W   | 25W  | Ø228x125    | 195-210     | 3070lm     | 1.26        | 12PCS    |
| DL288-8-30W   | 30W  | Ø228x125    | 195-210     | 3600lm     | 1.26        | 12PCS    |

CCT — 2700K — 3000K — 4000K

Conversion ring —

Trim — White Black



ADC12 Aluminum housing

ACC-DL288

- 2700K/3000K/4000K optional
- CRI80/90/97 optional
- Different lighting efficiency level optional

IP54

## LIGHT SOURCE INTERCHANGEABLE



# DL399 Downlight

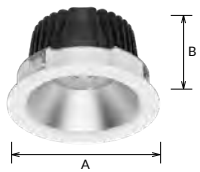

DL399 is LED modular downlight with DIY replaceable optical trim, drivers, COB and housing. 2 CCT and tunable white are available. IP54 waterproof for wet locations.

Materials of Housing : Die-casting Aluminium  
Materials of Optics : PC

- ▶ 36° 60° IP20
- ▶ Flicker Free TUNABLE WHITE SLIDE SWITCH 2 in 1
- ▶ AC 220-240V PF ≥ 0.9 CRI ≥ 80
- ▶ SAA RoHS CE

| Code        | Watt | Size(AxBmm) | Cut-out(mm) | Lumen(±5%) | N.W/pc(kgs) | Q'ty/CTN |
|-------------|------|-------------|-------------|------------|-------------|----------|
| DL399-4-10W | 10W  | Ø139x87     | Ø120        | 1200lm     | 0.89        | 12PCS    |
| DL399-4-13W | 13W  | Ø139x87     | Ø120        | 1560lm     | 0.89        | 12PCS    |
| DL399-4-18W | 18W  | Ø139x87     | Ø120        | 2160lm     | 0.89        | 12PCS    |
| DL399-6-18W | 18W  | Ø180x103    | Ø160        | 2160lm     | 1.20        | 12PCS    |
| DL399-6-25W | 25W  | Ø180x103    | Ø160        | 3000lm     | 1.20        | 12PCS    |
| DL399-6-30W | 30W  | Ø180x103    | Ø160        | 3600lm     | 1.20        | 12PCS    |

CCT ——— 2700K 3000K 4000K

Trim ——— White Black

**Conversion ring**

- ACC-DL399-4/6-WT/BK-51
- ACC-DL399-4/6-WT/BK-52
- ACC-DL399-4/6-WT/BK-53
- ACC-DL399-4-CR
- ACC-DL399-6-WT(GD)-54
- ACC-DL399-6-WT(GD)-55
- ACC-DL399-6-GR-54
- ACC-DL399-6-GR-55
- ACC-DL399-4-60
- ACC-DL399-4-36
- ACC-DL399-6-60
- ACC-DL399-6-36
- ACC-DL399-4/6-27K
- ACC-DL399-4/6-30K
- ACC-DL399-4-TW
- ACC-DL399-4/6-40K
- ACC-DL399-6-C2
- ACC-DL399-4/6-50K
- ACC-DL399-6-TW



Decorative kits



MODULAR  
Design DL399

UGR < 19



# DL326 Downlight

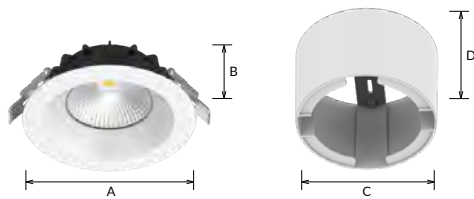

DL326 is a super slim COB downlight, which can be recessed and surface mounted with extra accessory, 4", 6", 8" .

Materials of Housing : Die-casting Aluminium  
Materials of Optics : Reflector+Tempered glass

- ▶
- ▶
- ▶
- ▶

| Code           | Watt | Size(AxB/CxDmm) | Cut-out(mm) | Lumen(±5%) | N.W/pc(kgs) | Q'ty/CTN |
|----------------|------|-----------------|-------------|------------|-------------|----------|
| DL326-2.5-6W   | 6W   | Ø85x36          | Ø68-75      | 620lm      | 0.19        | 36PCS    |
| DL326-3-10W    | 10W  | Ø110x45         | Ø90-95      | 1000lm     | 0.26        | 36PCS    |
| DL326-3-13W    | 13W  | Ø110x45         | Ø90-95      | 1330lm     | 0.26        | 36PCS    |
| DL326-4-13W    | 13W  | Ø145x52         | Ø120-130    | 1380lm     | 0.39        | 30PCS    |
| DL326-4-18W    | 18W  | Ø145x52         | Ø120-130    | 1990lm     | 0.39        | 30PCS    |
| DL326-6-18W    | 18W  | Ø190x52         | Ø160-170    | 2290lm     | 0.58        | 20PCS    |
| DL326-6-25W    | 25W  | Ø190x52         | Ø160-170    | 3080lm     | 0.58        | 20PCS    |
| DL326-8-18W    | 18W  | Ø228x59         | Ø200-210    | 2160lm     | 0.78        | 12PCS    |
| DL326-8-25W    | 25W  | Ø228x59         | Ø200-210    | 2990lm     | 0.78        | 12PCS    |
| DL326-8-35W    | 35W  | Ø228x59         | Ø200-210    | 3860lm     | 0.78        | 12PCS    |
| ACC-DL326-4-WT | -    | Ø148x93         | -           | -          | 0.34        | 24PCS    |
| ACC-DL326-6-WT | -    | Ø193x93         | -           | -          | 0.43        | 12PCS    |
| ACC-DL326-8-WT | -    | Ø232x93         | -           | -          | 0.53        | 12PCS    |

CCT ——— 2700K ——— 3000K ——— 4000K

Trim ——— White Black

Conversion ring ——— ACC-DL326-4-WT ACC-DL326-6-WT ACC-DL326-8-WT

# CL94 Downlight



CL94 LED downlight designed with a deep reflector, provides optimal glare control(UGR<19). It adopts brand CITIZEN COB for uniform and accenting lighting. Ideal for commercial and residential applications looking for a clean, minimalist look.

Materials of Housing : Die-casting Aluminium  
Materials of Optics : Aluminium

- ▶
- ▶
- ▶
- ▶

| Code       | Watt | Size(AxBmm) | Cut-out(mm) | Lumen(±5%) | N.W/pc(kgs) | Q'ty/CTN |
|------------|------|-------------|-------------|------------|-------------|----------|
| CL94-3-13W | 13W  | Ø110x100    | Ø95-100     | 920lm      | 0.38        | 24PCS    |
| CL94-6-25W | 25W  | Ø190x127    | Ø165-180    | 2550lm     | 0.85        | 12PCS    |
| CL94-8-35W | 35W  | Ø230x140    | Ø205-220    | 3350lm     | 1.20        | 12PCS    |

CCT ——— 2700K ——— 3000K ——— 4000K

Trim ——— White Black Silver





# DL361 Downlight



DL361 Led downlight is a deep reflector design, it has a wider shielding angle which can lower the glare and reach UGR<19. Adopt bridgelux brand COB light source, CRI>90 for a more real lighting effect. Transparent tempered glass provides great light transmittance.

Materials of Housing : Die-casting Aluminium  
Materials of Optics : Aluminium + PC

- 
- 
- 
- 
- 

| Code         | Watt | Size(AxBmm) | Cut-out(mm) | Lumen(±5%) | N.W/pc(kgs) | Q'ty/CTN |
|--------------|------|-------------|-------------|------------|-------------|----------|
| DL361-2.5-7W | 7W   | Ø85xH56     | Ø68-75      | 630lm      | 0.20        | 48PCS    |
| DL361-3-10W  | 10W  | Ø110xH75    | Ø90-100     | 1100lm     | 0.30        | 48PCS    |
| DL361-4-13W  | 13W  | Ø150xH97    | Ø120-130    | 1400lm     | 0.44        | 24PCS    |
| DL361-4-18W  | 18W  | Ø150xH97    | Ø120-130    | 1770lm     | 0.44        | 24PCS    |
| DL361-5-18W  | 18W  | Ø170xH112   | Ø140-150    | 2020lm     | 0.61        | 24PCS    |
| DL361-5-25W  | 25W  | Ø170xH112   | Ø140-150    | 2700lm     | 0.61        | 24PCS    |
| DL361-6-18W  | 18W  | Ø190xH120   | Ø160-170    | 2020lm     | 0.70        | 12PCS    |
| DL361-6-25W  | 25W  | Ø190xH120   | Ø160-170    | 2700lm     | 0.70        | 12PCS    |
| DL361-6-30W  | 30W  | Ø190xH120   | Ø160-170    | 3000lm     | 0.70        | 12PCS    |
| DL361-8-18W  | 18W  | Ø240xH142   | Ø195-230    | 2020lm     | 0.93        | 6PCS     |
| DL361-8-25W  | 25W  | Ø240xH142   | Ø195-230    | 2700lm     | 0.93        | 6PCS     |
| DL361-8-35W  | 35W  | Ø240xH142   | Ø195-230    | 3400lm     | 0.93        | 6PCS     |
| DL361-8-40W  | 40W  | Ø240xH142   | Ø195-230    | 4080lm     | 0.93        | 6PCS     |

CCT — 2700K — 3000K — 4000K

Trim — White — Black



LED Downlight Commercial



Cut-off 24°

Clean lighting angle



DL361 Series  
**UGR<19**

VISIBLE BRIGHTNESS, INVISIBLE LIGHT SOURCE

# DL284 series



DL284A COB  
Lens+Tempered Glass

DL284B COB  
Lens+Tempered Glass

DL284C COB  
Lens+PC Cover

DL284A SMD  
PC Cover+Tempered Glass

DL284B SMD  
PC Cover+Tempered Glass

DL284C SMD  
PC Cover+PC Cover



DL284A

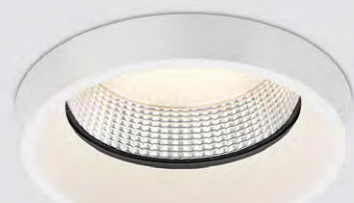

DL284B



IP 65  
20 JOULES=IK 10

# DL284A/B

Downlight COB

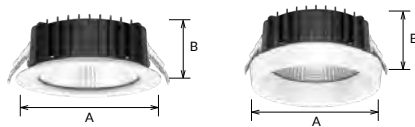

DL284A COB series downlight with traditional deep faceted reflector which provides a perfect combination of high lighting efficiency, comfortable lighting and low glare design, without compromising on lighting performance (color rendering and color uniformity). IP65 waterproof with high protection level, which offers a wider application area. It is with tempered glass as IK06/IK08. Based on DL284A,DL284B added the extend frame which looks like a slim surface mounted downlight.

Materials of Housing : Die-casting Aluminium

Materials of Optics : PC+Aluminium+Tempered glass

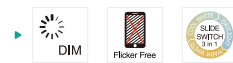

| Code           | Watt | Size(AxBmm)       | Cut-out(mm)        | Lumen(±5%) | N.W/pc(kgs) | Q'ty/CTN |
|----------------|------|-------------------|--------------------|------------|-------------|----------|
| DL284A-3-10W   | 10W  | Ø110x51           | Ø90-Ø95            | 1050lm     | 0.34        | 30PCS    |
| DL284A-3-13W   | 13W  | Ø110x51           | Ø90-Ø95            | 1350lm     | 0.34        | 30PCS    |
| DL284A/B-4-18W | 18W  | Ø150x64/ Ø145x82  | Ø125-140/ Ø125-135 | 1950lm     | 0.62/0.72   | 12PCS    |
| DL284A/B-4-25W | 25W  | Ø150x64/ Ø145x82  | Ø125-140/ Ø125-135 | 2750lm     | 0.62/0.72   | 12PCS    |
| DL284A/B-6-18W | 18W  | Ø172x69/ Ø172x92  | Ø150-165/ Ø150-160 | 1950lm     | 0.79/0.90   | 12PCS    |
| DL284A/B-6-25W | 25W  | Ø172x69/ Ø172x92  | Ø150-165/ Ø150-160 | 2750lm     | 0.79/0.90   | 12PCS    |
| DL284A/B-6-30W | 30W  | Ø172x69/ Ø172x92  | Ø150-165/ Ø150-160 | 3500lm     | 0.79/0.90   | 12PCS    |
| DL284A/B-8-18W | 18W  | Ø235x81/ Ø220x104 | Ø200-220/ Ø200-210 | 1950lm     | 1.27/1.45   | 6PCS     |
| DL284A/B-8-25W | 25W  | Ø235x81/ Ø220x104 | Ø200-220/ Ø200-210 | 2750lm     | 1.27/1.45   | 6PCS     |
| DL284A/B-8-35W | 35W  | Ø235x81/ Ø220x104 | Ø200-220/ Ø200-210 | 3850lm     | 1.27/1.45   | 6PCS     |



# DL284C

Downlight COB



DL284C COB series downlight with traditional deep faceted reflector which provides a perfect combination of high lighting efficiency, comfortable lighting and low glare design, without compromising on lighting performance (color rendering and color uniformity). IP65 waterproof and IK10 with high protection level are available.

Materials of Housing : Die-casting Aluminium

Materials of Optics : PC+Aluminium+Tempered glass

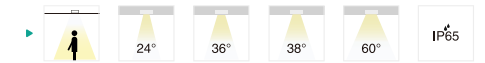

| Code         | Watt | Size(AxBmm) | Cut-out(mm) | Lumen(±5%) | N.W/pc(kgs) | Q'ty/CTN |
|--------------|------|-------------|-------------|------------|-------------|----------|
| DL284C-3-10W | 10W  | Ø110x51     | Ø90         | 1050lm     | 0.34        | 30PCS    |
| DL284C-3-13W | 13W  | Ø110x51     | Ø90         | 1350lm     | 0.34        | 30PCS    |
| DL284C-4-18W | 18W  | Ø150x64     | Ø125        | 1950lm     | 0.62        | 12PCS    |
| DL284C-4-25W | 25W  | Ø150x64     | Ø125        | 2750lm     | 0.62        | 12PCS    |
| DL284C-6-18W | 18W  | Ø172x69     | Ø150        | 1950lm     | 0.79        | 12PCS    |
| DL284C-6-25W | 25W  | Ø172x69     | Ø150        | 2750lm     | 0.79        | 12PCS    |
| DL284C-6-30W | 30W  | Ø172x69     | Ø150        | 3500lm     | 0.79        | 12PCS    |
| DL284C-8-18W | 18W  | Ø235x81     | Ø200        | 1950lm     | 1.27        | 6PCS     |
| DL284C-8-25W | 25W  | Ø235x81     | Ø200        | 2750lm     | 1.27        | 6PCS     |
| DL284C-8-35W | 35W  | Ø235x81     | Ø200        | 3850lm     | 1.27        | 6PCS     |





DL284A

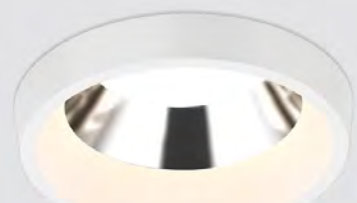

DL284B



IP 65  
20 JOULES=IK 10

LED Downlight  
Commercial

# DL284A/B

## Downlight SMD

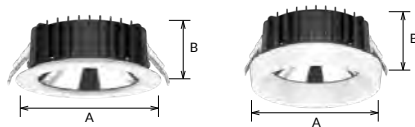

DL284A SMD series downlight with traditional deep faceted reflector which provides a perfect combination of high lighting efficiency, comfortable lighting and low glare design, without compromising on lighting performance (color rendering and color uniformity). IP65 waterproof with high protection level, which offers a wider application area. It is with tempered glass as IK06/IK08. Based on DL284A, DL284B added the extend frame which looks like a slim surface mounted downlight.

Materials of Housing : Die-casting Aluminium

Materials of Optics : PC+Aluminium+Tempered glass

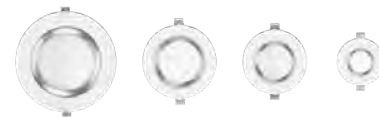
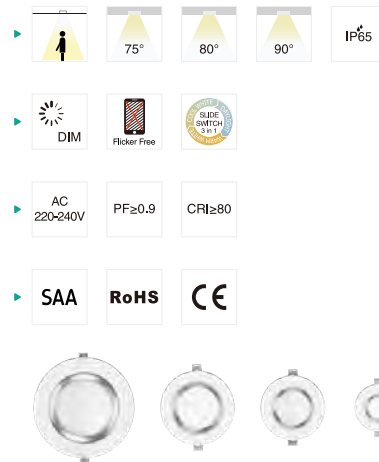

| Code           | Watt | Size(AxBmm)       | Cut-out(mm)        | Lumen(±5%) | N.W/pc(kgs) | Q'ty/CTN |
|----------------|------|-------------------|--------------------|------------|-------------|----------|
| DL284A-3-10W   | 10W  | Ø110x51           | Ø90-Ø95            | 950lm      | 0.34        | 30PCS    |
| DL284A-3-13W   | 13W  | Ø110x51           | Ø90-Ø95            | 1300lm     | 0.34        | 30PCS    |
| DL284A/B-4-18W | 18W  | Ø150x64/ Ø145x82  | Ø125-140/ Ø125-135 | 1950lm     | 0.62/0.72   | 12PCS    |
| DL284A/B-4-25W | 25W  | Ø150x64/ Ø145x82  | Ø125-140/ Ø125-135 | 2750lm     | 0.62/0.72   | 12PCS    |
| DL284A/B-6-18W | 18W  | Ø172x69/ Ø172x92  | Ø150-165/ Ø150-160 | 1950lm     | 0.79/0.90   | 12PCS    |
| DL284A/B-6-25W | 25W  | Ø172x69/ Ø172x92  | Ø150-165/ Ø150-160 | 2750lm     | 0.79/0.90   | 12PCS    |
| DL284A/B-6-30W | 30W  | Ø172x69/ Ø172x92  | Ø150-165/ Ø150-160 | 3500lm     | 0.79/0.90   | 12PCS    |
| DL284A/B-8-18W | 18W  | Ø235x81/ Ø220x104 | Ø200-220/ Ø200-210 | 1950lm     | 1.27/1.45   | 6PCS     |
| DL284A/B-8-25W | 25W  | Ø235x81/ Ø220x104 | Ø200-220/ Ø200-210 | 2750lm     | 1.27/1.45   | 6PCS     |
| DL284A/B-8-35W | 35W  | Ø235x81/ Ø220x104 | Ø200-220/ Ø200-210 | 3850lm     | 1.27/1.45   | 6PCS     |

CCT — 3000K — 4000K — 5700K

Trim — White — Black

# DL284C

## Downlight SMD

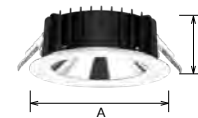

DL284C SMD series downlight with traditional deep faceted reflector which provides a perfect combination of high lighting efficiency, comfortable lighting and low glare design, without compromising on lighting performance (color rendering and color uniformity). IP65 waterproof and IK10 with high protection level are available.

Materials of Housing : Die-casting Aluminium

Materials of Optics : PC+Aluminium+Tempered glass

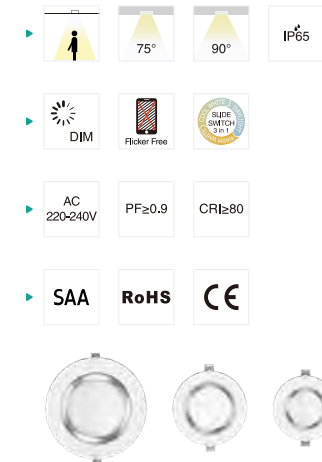

| Code         | Watt | Size(AxBmm) | Cut-out(mm) | Lumen(±5%) | N.W/pc(kgs) | Q'ty/CTN |
|--------------|------|-------------|-------------|------------|-------------|----------|
| DL284C-3-10W | 10W  | Ø110x51     | Ø90         | 1050lm     | 0.34        | 30PCS    |
| DL284C-3-13W | 13W  | Ø110x51     | Ø90         | 1350lm     | 0.34        | 30PCS    |
| DL284C-4-18W | 18W  | Ø150x64     | Ø125        | 1950lm     | 0.62        | 12PCS    |
| DL284C-4-25W | 25W  | Ø150x64     | Ø125        | 2750lm     | 0.62        | 12PCS    |
| DL284C-6-18W | 18W  | Ø172x69     | Ø150        | 1950lm     | 0.79        | 12PCS    |
| DL284C-6-25W | 25W  | Ø172x69     | Ø150        | 2750lm     | 0.79        | 12PCS    |
| DL284C-6-30W | 30W  | Ø172x69     | Ø150        | 3500lm     | 0.79        | 12PCS    |
| DL284C-8-18W | 18W  | Ø235x81     | Ø200        | 1950lm     | 1.27        | 6PCS     |
| DL284C-8-25W | 25W  | Ø235x81     | Ø200        | 2750lm     | 1.27        | 6PCS     |
| DL284C-8-35W | 35W  | Ø235x81     | Ø200        | 3850lm     | 1.27        | 6PCS     |

CCT — 3000K — 4000K — 5700K

Trim — White — Black



# TH0001 Downlight



TH0001 is a trim cover exchangeable modular downlight with six beam angles 15° / 20° / 24° / 36° / 45° / 50° as options. It adopts magnet splice and quick clips design, make assemble and installation more convenience. UGR<19, IP20/IP44 available, SDCM<4, it's a great luminaire which very suitable for high-end lighting applications.

Materials of Housing : Die-casting Aluminium  
Materials of Optics : PMMA/PC

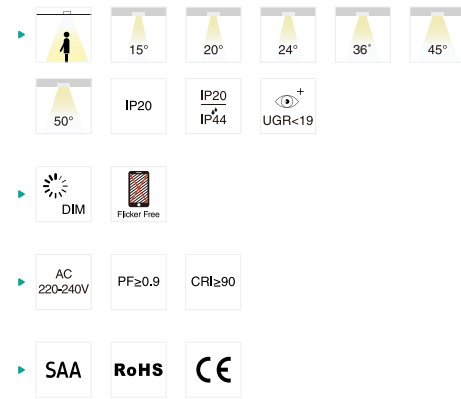

| Code            | Watt | Size(AxBmm) | Cut-out(mm) | Lumen(±5%) | N.W/pc(kgs) | Q'ty/CTN |
|-----------------|------|-------------|-------------|------------|-------------|----------|
| TH0001A-55-4.5W | 4.5W | Ø62x67      | Ø55-57      | 350lm      | 0.19        | 24PCS    |
| TH0001A-55-4.5W | 4.5W | 62x62x73    | Ø55-57      | 350lm      | 0.19        | 24PCS    |
| TH0001A-55-4.5W | 4.5W | Ø64x68      | Ø75-77      | 350lm      | 0.19        | 24PCS    |
| TH0001A-55-8W   | 8W   | Ø62x67      | Ø75-77      | 550lm      | 0.19        | 24PCS    |
| TH0001A-55-8W   | 8W   | 62x62x73    | Ø75-77      | 550lm      | 0.19        | 24PCS    |
| TH0001A-55-8W   | 8W   | Ø64x68      | Ø75-77      | 550lm      | 0.19        | 24PCS    |
| TH0001B-55-4.5W | 4.5W | Ø62x67      | Ø105-107    | 350lm      | 0.19        | 24PCS    |
| TH0001B-55-4.5W | 4.5W | 62x62x73    | Ø105-107    | 350lm      | 0.19        | 24PCS    |
| TH0001B-55-4.5W | 4.5W | Ø62x67      | Ø105-107    | 350lm      | 0.19        | 24PCS    |
| TH0001B-55-8W   | 8W   | Ø62x67      | Ø105-107    | 550lm      | 0.19        | 24PCS    |
| TH0001B-55-8W   | 8W   | 62x62x73    | Ø150-152    | 550lm      | 0.19        | 24PCS    |
| TH0001B-55-8W   | 8W   | Ø62x67      | Ø150-152    | 550lm      | 0.19        | 24PCS    |

|                   |      |            |         |        |      |       |
|-------------------|------|------------|---------|--------|------|-------|
| TH0001A/B-75-7.5W | 7.5W | Ø82x85     | Ø75-77  | 650lm  | 0.29 | 24PCS |
| TH0001A/B-75-7.5W | 7.5W | Ø110x85    | Ø75-77  | 650lm  | 0.29 | 24PCS |
| TH0001A/B-75-7.5W | 7.5W | 83x83x85   | Ø75-77  | 650lm  | 0.29 | 24PCS |
| TH0001A/B-75-7.5W | 7.5W | 110x110x85 | Ø75-77  | 650lm  | 0.29 | 24PCS |
| TH0001A/B-75-7.5W | 7.5W | Ø82x85     | Ø75-77  | 650lm  | 0.29 | 24PCS |
| TH0001A/B-75-7.5W | 7.5W | Ø110x85    | Ø75-77  | 650lm  | 0.29 | 24PCS |
| TH0001A/B-75-10W  | 10W  | Ø82x85     | Ø75-77  | 800lm  | 0.29 | 24PCS |
| TH0001A/B-75-10W  | 10W  | Ø110x85    | Ø75-77  | 800lm  | 0.29 | 24PCS |
| TH0001A/B-75-10W  | 10W  | 83x83x85   | Ø75-77  | 800lm  | 0.29 | 24PCS |
| TH0001A/B-75-10W  | 10W  | 110x110x85 | Ø75-77  | 800lm  | 0.29 | 24PCS |
| TH0001A/B-75-10W  | 10W  | Ø82x85     | Ø75-77  | 800lm  | 0.29 | 24PCS |
| TH0001A/B-75-10W  | 10W  | Ø110x85    | Ø75-77  | 800lm  | 0.29 | 24PCS |
| TH0001A/B-75-12W  | 12W  | Ø82x85     | Ø75-77  | 950lm  | 0.29 | 24PCS |
| TH0001A/B-75-12W  | 12W  | Ø110x85    | Ø75-77  | 950lm  | 0.29 | 24PCS |
| TH0001A/B-75-12W  | 12W  | 83x83x85   | Ø75-77  | 950lm  | 0.29 | 24PCS |
| TH0001A/B-75-12W  | 12W  | 110x110x85 | Ø75-77  | 950lm  | 0.29 | 24PCS |
| TH0001A/B-75-12W  | 12W  | Ø82x85     | Ø75-77  | 950lm  | 0.29 | 24PCS |
| TH0001A/B-75-12W  | 12W  | Ø110x85    | Ø75-77  | 950lm  | 0.29 | 24PCS |
| TH0001A/B-75-15W  | 15W  | Ø82x85     | Ø75-77  | 1100lm | 0.29 | 24PCS |
| TH0001A/B-75-15W  | 15W  | Ø110x85    | Ø75-77  | 1100lm | 0.29 | 24PCS |
| TH0001A/B-75-15W  | 15W  | 83x83x85   | Ø75-77  | 1100lm | 0.29 | 24PCS |
| TH0001A/B-75-15W  | 15W  | 110x110x85 | Ø75-77  | 1100lm | 0.29 | 24PCS |
| TH0001A/B-75-15W  | 15W  | Ø82x85     | Ø75-77  | 1100lm | 0.29 | 24PCS |
| TH0001A/B-75-15W  | 15W  | Ø110x85    | Ø75-77  | 1100lm | 0.29 | 24PCS |
| TH0001A/B-105-14W | 14W  | Ø114x120   | 105-107 | 1250lm | 0.70 | 12PCS |
| TH0001A/B-105-20W | 20W  | Ø114x120   | 105-107 | 1750lm | 0.70 | 12PCS |
| TH0001A/B-105-25W | 25W  | Ø114x120   | 105-107 | 2100lm | 0.70 | 12PCS |
| TH0001A/B-105-30W | 30W  | Ø114x120   | 105-107 | 2400lm | 0.70 | 12PCS |
| TH0001A/B-150-30W | 30W  | Ø154x174   | 150-152 | 3100lm | 1.75 | 6PCS  |
| TH0001A/B-150-35W | 35W  | Ø154x174   | 150-152 | 3500lm | 1.75 | 6PCS  |
| TH0001A/B-150-40W | 40W  | Ø154x174   | 150-152 | 3900lm | 1.75 | 6PCS  |
| TH0001A/B-150-45W | 45W  | Ø154x174   | 150-152 | 4300lm | 1.75 | 6PCS  |
| TH0001C-75-10W    | 10W  | Ø82x94     | Ø75-77  | 850lm  | 0.37 | 24PCS |
| TH0001C-75-10W    | 10W  | Ø110x94    | Ø75-77  | 850lm  | 0.37 | 24PCS |
| TH0001C-75-14W    | 14W  | Ø82x94     | Ø75-77  | 1200lm | 0.37 | 24PCS |
| TH0001C-75-14W    | 14W  | Ø110x94    | Ø75-77  | 1200lm | 0.37 | 24PCS |
| TH0001D-75-10W    | 10W  | Ø82x94     | Ø75-77  | 1000lm | 0.37 | 24PCS |
| TH0001D-75-10W    | 10W  | Ø110x94    | Ø75-77  | 1000lm | 0.37 | 24PCS |
| TH0001D-75-14W    | 14W  | Ø82x94     | Ø75-77  | 1450lm | 0.37 | 24PCS |
| TH0001D-75-14W    | 14W  | Ø110x94    | Ø75-77  | 1450lm | 0.37 | 24PCS |

CCT — 2700K 3000K 4000K Trim — White Black Silver

CCT — 2700K 3000K 4000K Trim — White Black Silver



TH0001A/B

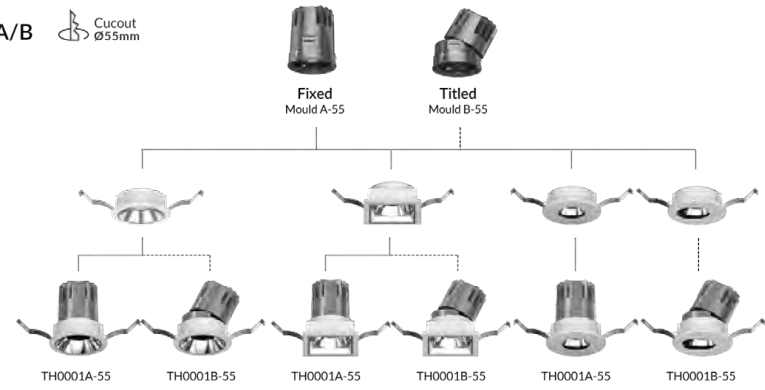

TH0001A/B

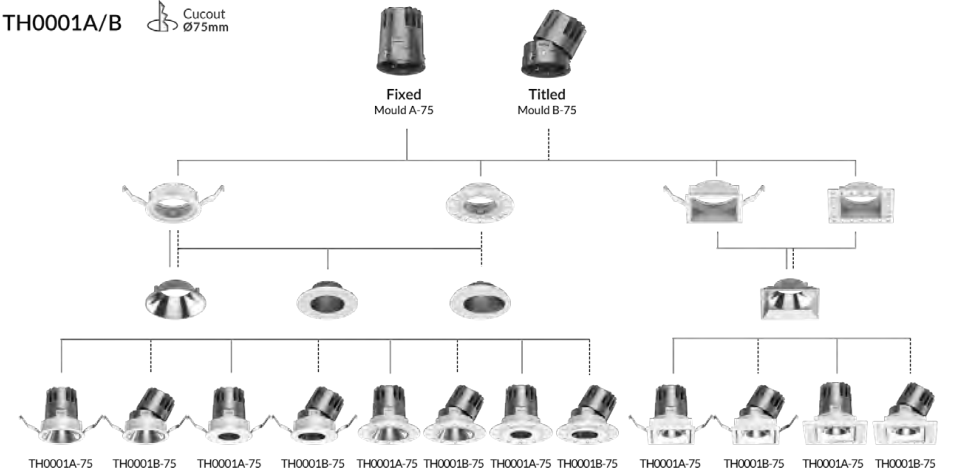

TH0001C/D

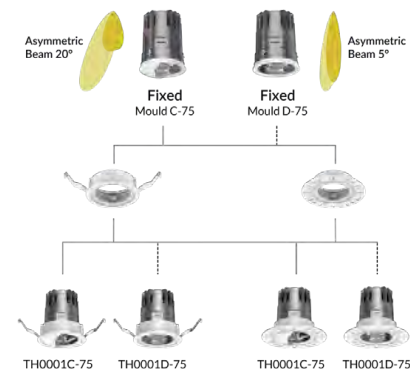

TH0001A/B

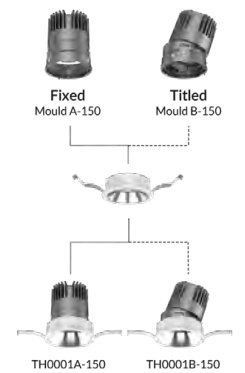
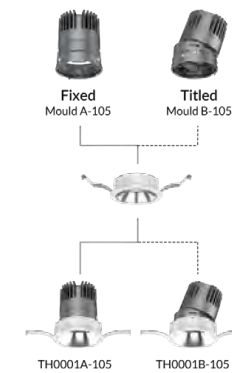



# DL113 Downlight



DL113 unique downlight adopts brand CITIZEN COB, reflector and tempered glass. Deep reflector reduces glare rate effectively. External driver is exchangeable through quick connector among non-dimmable driver, Triac dimmable, 0-10V and DALI dimmable drivers.

Materials of Housing : Die-casting Aluminium  
Materials of Optics : PC+Al1070+Tempered glass

- ▶
- ▶
- ▶
- ▶

| Code        | Watt | Size(AxBmm) | Cut-out(mm) | Lumen(±5%) | N.W/pc(kgs) | Q'ty/CTN |
|-------------|------|-------------|-------------|------------|-------------|----------|
| DL113-4-13W | 13W  | Ø150x123    | Ø135-140    | 1520lm     | 0.85        | 12PCS    |
| DL113-4-20W | 20W  | Ø150x123    | Ø135-140    | 2280lm     | 0.85        | 12PCS    |
| DL113-4-25W | 25W  | Ø150x123    | Ø135-140    | 2810lm     | 0.85        | 12PCS    |

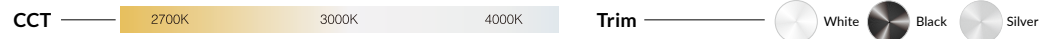

# DL122 Downlight



DL122 Gimbal downlight adopts brand CITIZEN COB, exchangeable reflector and tempered glass. Horizontally 355° and vertically 30° rotatable. External driver is exchangeable through quick connector among non-dimmable driver, Triac dimmable, 0-10V and DALI dimmable drivers.

Materials of Housing : Aluminium  
Materials of Optics : PC

- ▶
- ▶
- ▶
- ▶
- ▶

| Code        | Watt | Size(AxBmm) | Cut-out(mm) | Lumen(±5%) | N.W/pc(kgs) | Q'ty/CTN |
|-------------|------|-------------|-------------|------------|-------------|----------|
| DL122-4-18W | 18W  | Ø150x116    | Ø130-140    | 1820lm     | 0.71        | 12PCS    |
| DL122-4-25W | 25W  | Ø150x116    | Ø130-140    | 2430lm     | 0.71        | 12PCS    |
| DL122-6-25W | 25W  | Ø185x130    | Ø160-170    | 2420lm     | 1.10        | 12PCS    |
| DL122-6-35W | 35W  | Ø185x130    | Ø160-170    | 3260lm     | 1.10        | 12PCS    |
| DL122-6-42W | 42W  | Ø185x130    | Ø160-170    | 3780lm     | 1.10        | 12PCS    |





# CL156 Downlight

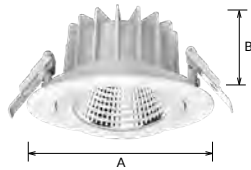

CL156 is IP20 LED downlight with COB LED. Various optical design 10°/15°/24°/36°/45°/60° and full dimensions 2.5inch, 3inch, 4inch, 6inch meet different demand.

Materials of Housing : Die-casting Aluminium  
Materials of Optics : PC

- ▶ 10° 15° 24° 36° 45° 60°
- ▶ IP20
- ▶ 25°-30°
- ▶ DIM DALI 0-10V Floor Free
- ▶ AC 220-240V PF≥0.9 CRI≥80 CRI≥90
- ▶ SAA RoHS CE

| Code         | Watt | Size(AxBmm) | Cut-out(mm) | Lumen(±5%) | N.W/pc(kgs) | Q'ty/CTN |
|--------------|------|-------------|-------------|------------|-------------|----------|
| CL156-2.5-8W | 8W   | Ø80x32      | Ø68-75      | 850lm      | 0.24        | 30PCS    |
| CL156-3-10W  | 10W  | Ø110x47     | Ø90-95      | 1100lm     | 0.38        | 30PCS    |
| CL156-3-13W  | 13W  | Ø110x47     | Ø90-95      | 1400lm     | 0.38        | 30PCS    |
| CL156-4-18W  | 18W  | Ø140x65     | Ø120-130    | 2200lm     | 0.56        | 12PCS    |
| CL156-4-25W  | 25W  | Ø140x65     | Ø120-130    | 2800lm     | 0.56        | 12PCS    |
| CL156-6-18W  | 18W  | Ø180x81     | Ø160-170    | 2250lm     | 0.88        | 12PCS    |
| CL156-6-25W  | 25W  | Ø180x81     | Ø160-170    | 2800lm     | 0.88        | 12PCS    |
| CL156-6-35W  | 35W  | Ø180x81     | Ø160-170    | 3700lm     | 0.88        | 12PCS    |

CCT ——— 3000K ——— 4000K ——— 5700K

Trim ——— White Black



## Tilted

25-30° flexible rotary





# DL297A Downlight

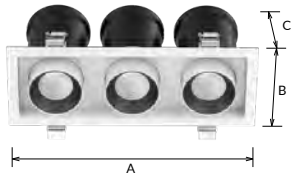

DL297A LED downlight adopts high lumen COB light source, the special optic lens and reflector design offer a uniform light output and low glare effect. It is an extension design, 360 degree horizontal rotation and 68 degree vertically rotation. And it has round shape, square shape with single/ double/triple heads which is suitable for various application area.

Materials of Housing : Aluminium

Materials of Optics : PC

- ▶
- ▶
- ▶
- ▶



| Code              | Watt | Size(AxBxCmm) | Cut-out(mm)   | Lumen(±5%) | N.W/pc(kgs) | Q'ty/CTN |
|-------------------|------|---------------|---------------|------------|-------------|----------|
| DL297A-2.5-10W    | 10W  | Ø100x114      | Ø83-90        | 900lm      | 0.50        | 24PCS    |
| DL297A-1010-10W   | 10W  | 100x100x114   | 83-90x83-90   | 900lm      | 0.50        | 24PCS    |
| DL297A-2.5-15W    | 15W  | Ø100x114      | Ø83-90        | 1350lm     | 0.50        | 24PCS    |
| DL297A-1010-15W   | 15W  | 100x100x114   | 83-90x83-90   | 1350lm     | 0.50        | 24PCS    |
| DL297A-1018-20W   | 20W  | 180x100x114   | 85-90x165-170 | 1800lm     | 0.90        | 12PCS    |
| DL297A-1018-30W   | 30W  | 180x100x114   | 85-90x165-170 | 2700lm     | 0.90        | 12PCS    |
| DL297A-1026-30W   | 30W  | 260x100x114   | 85-90x245-250 | 2700lm     | 1.50        | 6PCS     |
| DL297A-1026-45W   | 45W  | 260x100x114   | 85-90x245-250 | 4050lm     | 1.50        | 6PCS     |
| DL297A-1026-42W-D | 42W  | 260x100x114   | 85-90x245-250 | 3600lm     | 1.50        | 6PCS     |

CCT ——— 2700K ——— 3000K ——— 4000K

Trim ——— White Black

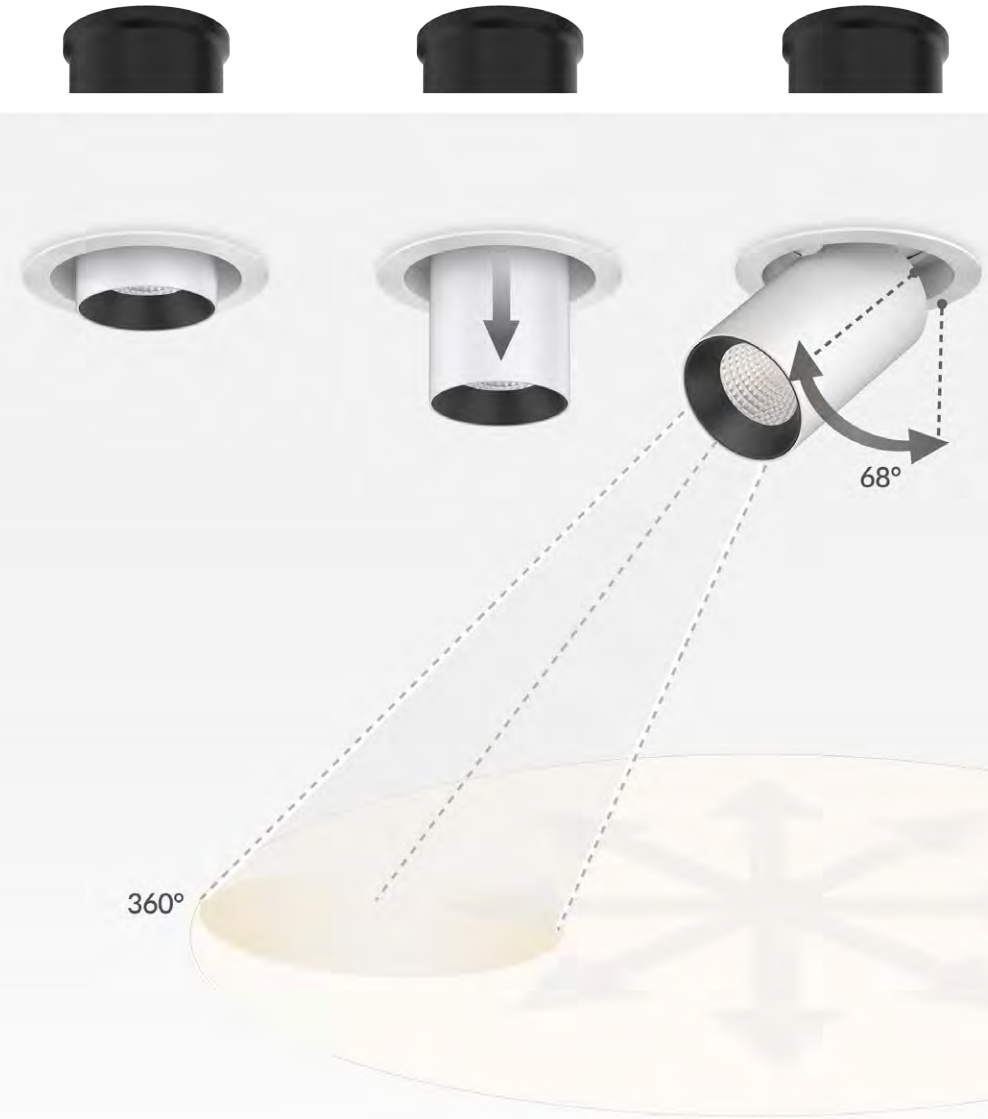

## DL297 SERIES

DL297A Series Extension Design  
Adjustable Downlight



# DL77 Downlight

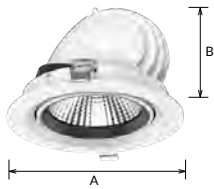

DL77 Gimbal downlight adopts brand CITIZEN COB, reflector and tempered glass. External driver is exchangeable through quick connector among non-dimmable driver, Triac dimmable, 0-10V and DALI dimmable drivers.

Materials of Housing : Die-casting Aluminium

Materials of Optics : PC

- ▶ 15° 24° 36° 45° 60°
- ▶ 350° 35° IP20
- ▶ DIM DALI 0-10V Flicker Free
- ▶ AC 200-240V PF≥0.9 CRI≥80 CRI≥90 CRI≥97
- ▶ SAA RoHS CE CB

| Code         | Watt | Size(AxBmm) | Cut-out(mm) | Lumen(±5%) | N.W/pc(kgs) | Q'ty/CTN |
|--------------|------|-------------|-------------|------------|-------------|----------|
| DL77-2.5-10W | 10W  | Ø96x68      | Ø85-90      | 800lm      | 0.25        | 36PCS    |
| DL77-4-15W   | 15W  | Ø145x102    | Ø120-130    | 1800lm     | 0.57        | 18PCS    |
| DL77-4-20W   | 20W  | Ø145x102    | Ø120-130    | 2100lm     | 0.57        | 18PCS    |
| DL77-6-35W   | 35W  | Ø180x128.5  | Ø165-170    | 3800lm     | 1.07        | 12PCS    |
| DL77-6-45W   | 45W  | Ø180x128.5  | Ø165-170    | 5080lm     | 1.07        | 12PCS    |

CCT — 2700K 3000K 4000K Trim — White Black Silver

# DL335 Downlight



DL335 is scoop design COB downlight and can be rotated in horizontal direction with 350° and vertical direction 90°. External driver, non-dimmable, Triac dimmable, 0-10V and DALI dimmable are available.

Materials of Housing : Die-casting Aluminium

Materials of Optics : PC/Aluminium

- ▶ 15° 24° 36° 60°
- ▶ 350° 90° IP20
- ▶ DIM DALI 0-10V Flicker Free
- ▶ AC 220-240V PF≥0.9 CRI≥80 CRI≥90 CRI≥97
- ▶ SAA RoHS CE CB

| Code          | Watt | Size(AxBmm) | Cut-out(mm) | Lumen(±5%) | N.W/pc(kgs) | Q'ty/CTN |
|---------------|------|-------------|-------------|------------|-------------|----------|
| DL335-2.5-10W | 10W  | Ø96x74      | Ø85-90      | 1000lm     | 0.20        | 36PCS    |
| DL335-4-18W   | 18W  | Ø145x111    | Ø125-130    | 1900lm     | 0.60        | 18PCS    |
| DL335-4-25W   | 25W  | Ø145x111    | Ø125-130    | 2600lm     | 0.60        | 18PCS    |
| DL335-6-25W   | 25W  | Ø180x147    | Ø165-170    | 2700lm     | 1.05        | 12PCS    |
| DL335-6-35W   | 35W  | Ø180x147    | Ø165-170    | 3600lm     | 1.05        | 12PCS    |
| DL335-6-45W   | 45W  | Ø180x147    | Ø165-170    | 4500lm     | 1.05        | 12PCS    |
| DL335-8-25W   | 25W  | Ø235x144    | Ø200-210    | 2700lm     | 1.15        | 12PCS    |
| DL335-8-35W   | 35W  | Ø235x144    | Ø200-210    | 3600lm     | 1.15        | 12PCS    |
| DL335-8-45W   | 45W  | Ø235x144    | Ø200-210    | 4500lm     | 1.15        | 12PCS    |

CCT — 2700K 3000K 4000K Trim — White Black

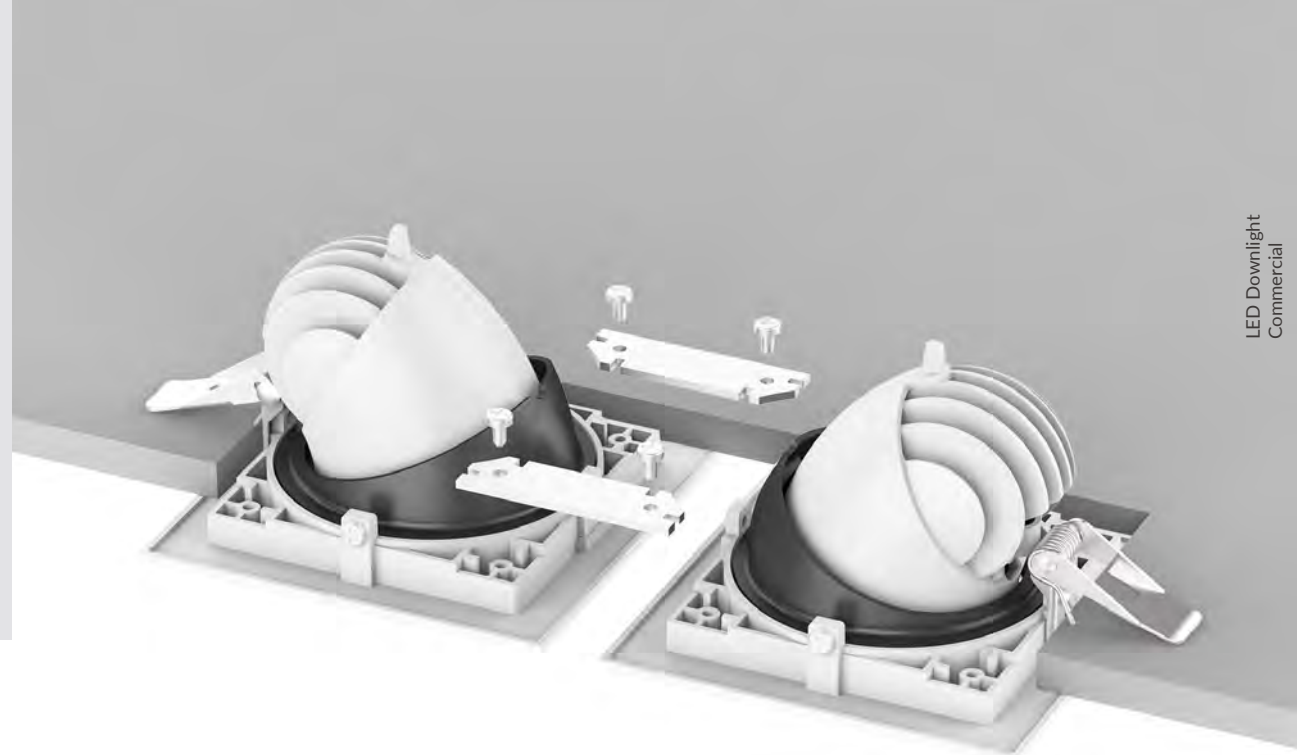

# CL108 Downlight

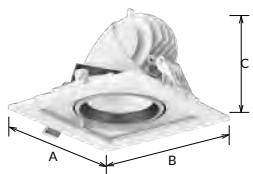

CL108 Gimbal downlight adopts brand CITIZEN COB, Square modular design allows various DIY combinations through splicing plates. External driver is exchangeable through quick connector among non-dimmable driver, Triac dimmable, 0-10V and DALI dimmable drivers.

Materials of Housing : Die-casting Aluminium  
Materials of Optics : PC

- ▶ 15° 24° 36° 45° 60°
- ▶ 350° 35° IP20
- ▶ DIM DALI 0-10V Flicker Free
- ▶ AC 200-240V PF≥0.9 CRI≥80 CRI≥90 CRI≥97
- ▶ SAA RoHS CE

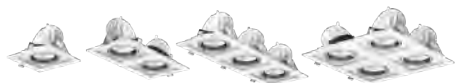

| Code          | Watt | Size(AxBxCmm) | Cut-out(mm) | Lumen(±5%) | N.W/pc(kgs) | Q'ty/CTN |
|---------------|------|---------------|-------------|------------|-------------|----------|
| CL108-2.5-10W | 10W  | 100x100x70    | 85-85       | 780lm      | 0.29        | 36PCS    |
| CL108-4-15W   | 15W  | 145x145x107   | 125-125     | 1290lm     | 0.60        | 18PCS    |
| CL108-4-20W   | 20W  | 145x145x107   | 125-125     | 2100lm     | 0.60        | 18PCS    |
| CL108-6-35W   | 35W  | 180x180x129   | 165-165     | 3800lm     | 1.07        | 12PCS    |
| CL108-6-45W   | 45W  | 180x180x129   | 165-165     | 4350lm     | 1.07        | 12PCS    |

CCT ——— 2700K ——— 3000K ——— 4000K

Trim ——— White Black

## DIY Splicing Scoop downlight





# CL113A Downlight

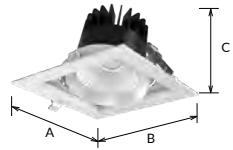

CL113A Gimbal downlight adopts brand CITIZEN COB. Square modular design allows various DIY combinations through splicing plates. External driver is exchangeable through quick connector among non-dimmable driver, Triac dimmable, 0-10V and DALI dimmable drivers.

Materials of Housing : Aluminium  
Materials of Optics : PC

- ▶ IP20
- ▶
- ▶
- ▶



| Code         | Watt | Size(AxBxCmm) | Cut-out(mm) | Lumen(±5%) | N.W/pc(kgs) | Q'ty/CTN |
|--------------|------|---------------|-------------|------------|-------------|----------|
| CL113A-6-25W | 25W  | 175x175x110   | 150-160     | 2750lm     | 0.83        | 18PCS    |
| CL113A-6-35W | 35W  | 175x175x110   | 150-160     | 3850lm     | 0.83        | 18PCS    |

CCT — 3000K — 4000K — 5700K

Trim — White — Black

# CL113B Downlight



CL113B Gimbal downlight adopts brand CITIZEN COB. External driver is exchangeable through quick connector among non-dimmable driver, Triac dimmable, 0-10V and DALI dimmable drivers.

Materials of Housing : Aluminium  
Materials of Optics : PC

- ▶ IP20
- ▶
- ▶
- ▶

| Code         | Watt | Size(AxBmm) | Cut-out(mm) | Lumen(±5%) | N.W/pc(kgs) | Q'ty/CTN |
|--------------|------|-------------|-------------|------------|-------------|----------|
| CL113B-6-25W | 25W  | Ø180x110    | Ø150-160    | 2750lm     | 0.79        | 18PCS    |
| CL113B-6-35W | 35W  | Ø180x110    | Ø150-160    | 3850lm     | 0.79        | 18PCS    |

CCT — 2700K — 3000K — 4000K

Trim — White — Black



# RD01 Downlight



RD01 rectangular downlight is unique designed with COB high power LED chip. IP65 waterproof can be used in wider applications, especial for damp location. Isolated external driver solution achieves stable working performance.

Materials of Housing : Die-casting Aluminium  
Materials of Optics : Tempered glass

- ▶ 120°
- ▶ 45°
- ▶ IP65
- ▶ DIM
- ▶ DALI
- ▶ 0-10V
- ▶ Flicker Free
- ▶ AC 100-240V
- ▶ PF≥0.9
- ▶ CRI≥80
- ▶ SAA
- ▶ RoHS
- ▶ CE

| Code     | Watt | Size(AxBxCmm) | Cut-out(mm) | Lumen(±5%) | N.W/pc(kgs) | Q'ty/CTN |
|----------|------|---------------|-------------|------------|-------------|----------|
| RD01-35W | 35W  | 235x145x117.4 | 220x130     | 3950lm     | 2.40        | 6PCS     |
| RD01-45W | 45W  | 235x145x117.4 | 220x130     | 4700lm     | 2.40        | 6PCS     |

CCT — 3000K — 4000K — 5700K

Finish — White — Black

# RD01-C Downlight

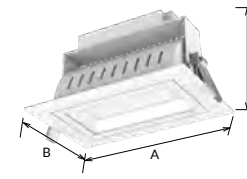

RD01-C SMD Rectangular downlight achieves high lumen output, 90° wide beam angle. External driver solution achieves stable working performance and easy maintenance. Tilt head provides various lighting direction for different applications. It is widely used for different commercial lighting situation.

Materials of Housing : Die-casting Aluminium  
Materials of Optics : Tempered glass

- ▶ 90°
- ▶ 65°
- ▶ IP20
- ▶ DIM
- ▶ DALI
- ▶ 0-10V
- ▶ Flicker Free
- ▶ SMD 3 in 1
- ▶ AC 200-240V
- ▶ PF≥0.9
- ▶ CRI≥80
- ▶ SAA
- ▶ RoHS
- ▶ CE

| Code          | Watt | Size(AxBxCmm) | Cut-out(mm) | Lumen(±5%) | N.W/pc(kgs) | Q'ty/CTN |
|---------------|------|---------------|-------------|------------|-------------|----------|
| RD01-C-40W    | 40W  | 246x156x115   | 225x130     | 3950lm     | 2.30        | 4PCS     |
| RD01-C-40W-C3 | 40W  | 246x156x115   | 225x130     | 4400lm     | 2.30        | 4PCS     |
| RD01-C-60W    | 60W  | 246x156x115   | 225x130     | 5450lm     | 2.30        | 4PCS     |
| RD01-C-60W-C3 | 60W  | 246x156x115   | 225x130     | 6900lm     | 2.30        | 4PCS     |

CCT — 3000K — 4000K — 5700K

Finish — White — Black



# RD07A&B Downlight

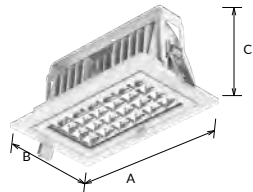

RD07 LED is new commercial light series with external driver design. Type A is unique louver reflector design and type B woven glass design, both 2 types adopting high lumen SMD LED chip with uniform light output. IP65 waterproof and 70°vertically rotatable are available

Materials of Housing : PC/Aluminium  
Materials of Optics : PC/Aluminium

- ▶ 70° 110° 70° IP65
- ▶ DIM DALI 0-10V Flicker Free SLIDE SWITCH 3 IN 1
- ▶ AC 200-240V PF≥0.9 CRI≥80
- ▶ SAA RoHS CE



| Code      | Watt | Size(AxBxCmm) | Cut-out(mm) | Lumen(±5%) | N.W/pc(kgs) | Q'ty/CTN |
|-----------|------|---------------|-------------|------------|-------------|----------|
| RD07A-32W | 32W  | 235x145x117.4 | 220x130     | 3150lm     | 1.77        | 6PCS     |
| RD07A-42W | 42W  | 235x145x117.4 | 220x130     | 3900lm     | 1.77        | 6PCS     |
| RD07B-32W | 32W  | 235x145x117.4 | 220x130     | 4200lm     | 1.77        | 6PCS     |
| RD07B-42W | 42W  | 235x145x117.4 | 220x130     | 5100lm     | 1.77        | 6PCS     |

CCT 3000K 4000K 5700K

Finish White Black

# CL146 Downlight

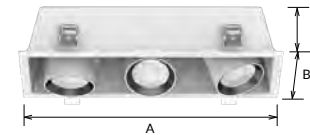

CL146 is gyro design commercial LED downlight with single/double/triple head options. It is tilttable 45° in all directions 355°. SMD with 1CCT/ 3CCT, COB LED light source is available.

Materials of Housing : Die-casting Aluminium  
Materials of Optics : PC

- ▶ 15° 24° 36° 45° 60° IP20
- ▶ DIM Flicker Free SLIDE SWITCH 3 IN 1
- ▶ AC 220-240V PF≥0.9 CRI≥80
- ▶ SAA RoHS CE



| Code            | Watt | Size(AxBxCmm) | Cut-out(mm) | Lumen(±5%) | N.W/pc(kgs) | Q'ty/CTN |
|-----------------|------|---------------|-------------|------------|-------------|----------|
| CL146A-15W(COB) | 15W  | 125x125x88    | 115x115     | 1590lm     | 0.63        | 12PCS    |
| CL146A-30W(COB) | 30W  | 228x125x88    | 218x115     | 3240lm     | 0.95        | 12PCS    |
| CL146A-45W(COB) | 45W  | 331x125x88    | 321x115     | 4830lm     | 1.32        | 6PCS     |
| CL146B-8W(SMD)  | 8W   | 125x125x88    | 115x115     | 770lm      | 0.63        | 12PCS    |
| CL146B-16W(SMD) | 16W  | 228x125x88    | 218x115     | 1480lm     | 0.95        | 12PCS    |
| CL146B-24W(SMD) | 24W  | 331x125x88    | 321x115     | 2400lm     | 1.32        | 6PCS     |

CCT 2700K 3000K 4000K

Trim White Black



# CL99 Downlight

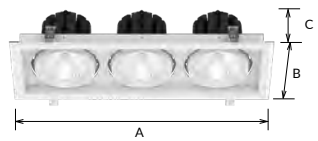

CL99 downlight is a unique replaceable module design which makes an easier installation and maintenance. The drivers are separate and external for easy replacement. It is an ideal design for commercial lighting.

Materials of Housing : Die-casting Aluminium  
Materials of Optics : PC

- ▶ 15° 24° 36° 340° IP20
- ▶ DIM DALI 0-10V Flicker Free
- ▶ AC 200-240V PF≥0.9 CRI≥80 CRI≥90 CRI≥97
- ▶ SAA RoHS CE

| Code     | Watt | Size(AxBxCmm) | Cut-out(mm) | Lumen(±5%) | N.W/pc(kgs) | Q'ty/CTN |
|----------|------|---------------|-------------|------------|-------------|----------|
| CL99-30W | 30W  | 175x175x110   | 160-160     | 3500lm     | 1.25        | 12PCS    |
| CL99-60W | 60W  | 330x175x110   | 310-160     | 6700lm     | 2.25        | 6PCS     |
| CL99-90W | 90W  | 475x175x110   | 455-160     | 9870lm     | 3.20        | 6PCS     |

CCT ——— 2700K ——— 3000K ——— 4000K

Finish ——— White Black

# Focusing lighting





# RD02&RD03 Downlight

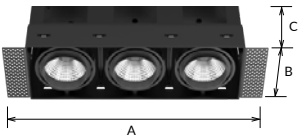

This frameless commercial downlight adopted brand CREE COB chip which offers a high lumen output. RD02 RD03 single head, double heads, triple heads provide a wider choice. Adjustable lighting direction offers various lighting orientation.

Materials of Housing : Die-casting Aluminium  
Materials of Optics : PC

- ▶ 24° IP20
- ▶ Flicker Free
- ▶ AC 200-240V PF≥0.9 CRI≥80 CRI≥90 CRI≥97
- ▶ SAA RoHS CE



| Code     | Watt | Size(AxBxCmm)  | Cut-out(mm) | Lumen(±5%) | N.W/pc(kgs) | Q'ty/CTN |
|----------|------|----------------|-------------|------------|-------------|----------|
| RD02-8W  | 8W   | 155.5x83.5x134 | 86-86       | 550lm      | 1.30        | 12PCS    |
| RD02-16W | 16W  | 235.5x83.5x134 | 167-86      | 1250lm     | 1.90        | 6PCS     |
| RD02-24W | 24W  | 315.5x83.5x134 | 247-86      | 1700lm     | 2.50        | 6PCS     |
| RD03-12W | 12W  | 185x113x154    | 116-116     | 980lm      | 1.70        | 12PCS    |
| RD03-24W | 24W  | 294x113x154    | 228-116     | 2040lm     | 2.50        | 6PCS     |
| RD03-36W | 36W  | 404x113x154    | 338-116     | 2700lm     | 3.10        | 6PCS     |

CCT — 2700K 3000K 4000K

Finish — White Grey

# RD04&RD05 Downlight

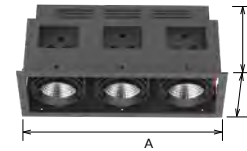

RD04 RD05 with brand CREE COB high power LED chip. Single head, double heads and triple heads provide a wider choice. Adjustable lighting direction offers various lighting orientation.

Materials of Housing : Die-casting Aluminium  
Materials of Optics : PC

- ▶ 24° IP20
- ▶ Flicker Free
- ▶ AC 200-240V PF≥0.9 CRI≥80 CRI≥90 CRI≥97
- ▶ SAA RoHS CE



| Code     | Watt | Size(AxBxCmm) | Cut-out(mm) | Lumen(±5%) | N.W/pc(kgs) | Q'ty/CTN |
|----------|------|---------------|-------------|------------|-------------|----------|
| RD04-8W  | 8W   | 100x100x135   | 85-85       | 550lm      | 1.10        | 12PCS    |
| RD04-16W | 16W  | 180x100x135   | 165-85      | 1250lm     | 1.80        | 6PCS     |
| RD04-24W | 24W  | 260x100x135   | 245-85      | 1700lm     | 2.40        | 6PCS     |
| RD05-12W | 12W  | 130x130x155   | 115-115     | 980lm      | 1.60        | 12PCS    |
| RD05-24W | 24W  | 239x130x155   | 224-115     | 2040lm     | 2.40        | 6PCS     |
| RD05-36W | 36W  | 349x130x155   | 334-115     | 2700lm     | 3.00        | 6PCS     |

CCT — 2700K 3000K 4000K

Finish — White Black





DL266B



DL266C

LED Downlight  
Surface mounted  
& Pendant Series

# DL266B/C Downlight

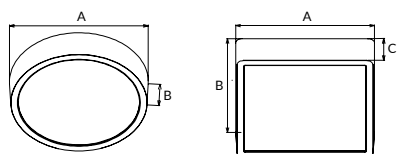

DL266B/C surface mounted downlight adopts 2835 SMD. The internal driver design and 3 CCT interchangeable are available.

Materials of Housing : PC

Materials of Optics : PC

- ▶ 120°
- ▶
- ▶
- ▶

| Code           | Watt | Size(AxBmm) | Lumen(±5%) | N.W/pc(kgs) | Q'ty/CTN |
|----------------|------|-------------|------------|-------------|----------|
| DL266B-120-6W  | 6W   | Ø120x45     | 700lm      | 0.187       | 24PCS    |
| DL266B-160-8W  | 8W   | Ø160x45     | 900lm      | 0.247       | 24PCS    |
| DL266B-220-18W | 18W  | Ø220x47     | 2250lm     | 0.411       | 12PCS    |
| DL266B-300-24W | 24W  | Ø300x47     | 3300lm     | 0.637       | 6PCS     |
| DL266C-120-6W  | 6W   | 120x120x45  | 700lm      | 0.212       | 24PCS    |
| DL266C-160-8W  | 8W   | 160x160x45  | 900lm      | 0.285       | 24PCS    |
| DL266C-220-18W | 18W  | 220x220x47  | 2250lm     | 0.477       | 12PCS    |
| DL266C-300-24W | 24W  | 300x300x47  | 3200lm     | 0.748       | 6PCS     |



DL266B/C

UP TO 140LM/W

CCT ——— 3000K ——— 4000K ——— 5700K

Finish ——— White Black



# DL38B Downlight

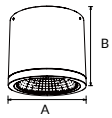

DL38B surface mounted downlight is a high-performance LED luminaire that can simultaneously or individually offer uniform and excellent light. It offers a wide choice of beam angles 24°/36°/45°/60° for optional. DALI and 3-CCT changeable are available.

Materials of Housing : Die-casting Aluminium  
Materials of Optics : PC

- ▶ 24° 36° 45° 60°
- ▶ IP54
- ▶ DIM DALI Flicker Free 3-CCT
- ▶ AC 200-240V PF≥0.9 CRI≥80
- ▶ SAA RoHS CE

| Code      | Watt | Size(AxBmm) | Lumen(±5%) | N.W/pc(kgs) | Q'ty/CTN |
|-----------|------|-------------|------------|-------------|----------|
| DL38B-10W | 10W  | Ø90x100     | 1150lm     | 0.45        | 24PCS    |
| DL38B-15W | 15W  | Ø90x100     | 1600lm     | 0.50        | 24PCS    |
| DL38B-10W | 10W  | Ø120x110    | 1200lm     | 0.52        | 18PCS    |
| DL38B-15W | 15W  | Ø120x110    | 1700lm     | 0.52        | 18PCS    |
| DL38B-20W | 20W  | Ø120x110    | 2450lm     | 0.52        | 18PCS    |
| DL38B-25W | 25W  | Ø120x110    | 2700lm     | 0.52        | 18PCS    |
| DL38B-25W | 25W  | Ø160x120    | 2950lm     | 1.23        | 18PCS    |
| DL38B-32W | 32W  | Ø160x120    | 3580lm     | 1.23        | 18PCS    |

CCT ——— 2700K ——— 3000K ——— 4000K

Finish ——— White Black

Installation accessories ——— Suspension kit ACC-DL38B-90/120/160

# DL38 Series



LED Downlight  
Surface mounted  
& Pendant Series

## Interchangeable CCT

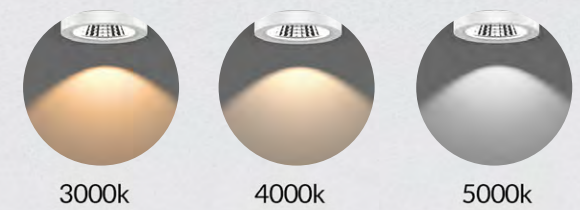



LED Downlight  
Surface mounted  
& Pendant Series

# DL328 Downlight

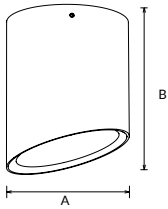

DL328 Surface mounted downlight shape comes from a cone. It adopts COB light source and reflector polarized design to reach a uniform wall washing effect and lower the glare. No need to adjust angle to reach wall washing effect, integrated polarized design keeps both professional level and high cost performance.

Materials of Housing : Die-casting Aluminium+PC  
Materials of Optics : PC + Tempered glass

- ▶
- ▶
- ▶
- ▶

| Code        | Watt | Size(AxBmm) | Lumen(±5%) | N.W/pc(kgs) | Q'ty/CTN |
|-------------|------|-------------|------------|-------------|----------|
| DL328-3-10W | 10W  | Ø90x113     | 1000lm     | 0.26        | 24PCS    |
| DL328-4-18W | 18W  | Ø120x142    | 1950lm     | 0.39        | 12PCS    |
| DL328-4-25W | 25W  | Ø120x142    | 2700lm     | 0.39        | 12PCS    |

# DL176 Downlight

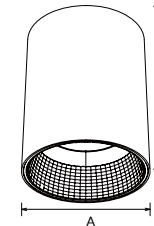

DL176 downlight with deep-set reflector provides better glaring control(UGR<19). It offers a wide choice of outputs, beam angles and color rendering options. Surface mounted down light with no-screw outside fixation provide a much cleaner out-looking design. Built-in driver, easy for installation.

Materials of Housing : Die-casting Aluminium  
Materials of Optics : PC

- ▶
- ▶
- ▶
- ▶

| Code      | Watt | Size(AxBmm) | Lumen(±5%) | N.W/pc(kgs) | Q'ty/CTN |
|-----------|------|-------------|------------|-------------|----------|
| DL176-15W | 15W  | Ø100x134    | 1750lm     | 0.65        | 18PCS    |
| DL176-25W | 25W  | Ø120x144    | 2800lm     | 0.84        | 12PCS    |
| DL176-35W | 35W  | Ø170x159    | 3900lm     | 1.45        | 6PCS     |

CCT — 2700K — 3000K — 4000K

Finish — White Black

CCT — 2700K — 3000K — 4000K

Finish — White Black Wood grain



# DL269 Downlight

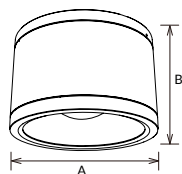

DL269 series downlight as IP65 waterproof design is widely used for indoor and semi-outdoor environment. DL269A as COB and DL269B as SMD with flicker free driver, 3 CCT switchable. DL269A UGR<19, DL269B UGR<25. Tempered Glass in front as IK06.

Materials of Housing : Die-casting Aluminium  
Materials of Optics : PC+Tempered Glass

- ▶ 24° 36° 60° 70° 75°
- ▶ IP65 IK06 UGR<19 UGR<25
- ▶ Flicker Free SMD SWITCH 5V+1.8V
- ▶ AC 200-240V PF≥0.9 CRi≥80
- ▶ SAA RoHS CE CB

| Code            | Watt | Size(AxBmm) | Lumen(±5%) | N.W/pc(kgs) | Q'ty/CTN |
|-----------------|------|-------------|------------|-------------|----------|
| DL269A/B-3-10W  | 10W  | Ø90x107     | 1100lm     | 0.60        | 18PCS    |
| DL269A/B-3-15W  | 15W  | Ø90x107     | 1600lm     | 0.60        | 18PCS    |
| DL269A/B-5-18W  | 18W  | Ø130x115    | 1900lm     | 0.92        | 12PCS    |
| DL269A/B-5-25W  | 25W  | Ø130x115    | 2500lm     | 0.92        | 12PCS    |
| DL269A/B-6-25W  | 25W  | Ø160x110    | 2500lm     | 1.18        | 6PCS     |
| DL269A/B-6-30W  | 30W  | Ø160x110    | 3000lm     | 1.18        | 6PCS     |
| DL269A/B-8-25W  | 25W  | Ø214x119    | 2500lm     | 2.20        | 6PCS     |
| DL269A/B-8-35W  | 35W  | Ø214x119    | 3500lm     | 2.20        | 6PCS     |
| DL269A/B-10-35W | 35W  | Ø250x125    | 3500lm     | 2.80        | 4PCS     |
| DL269A/B-10-40W | 40W  | Ø250x125    | 4200lm     | 2.80        | 4PCS     |
| DL269A/B-10-45W | 45W  | Ø250x125    | 4600lm     | 2.80        | 4PCS     |

CCT — 2700K — 3000K — 4000K

Finish — White — Black

# IP65 IK06 Downlight

DL269B SMD (70°)

DL269A COB (24°/36°/60°)

Tempered glass

Fast connector

LED Downlight  
Surface mounted  
& Pendant Series



# DL115A/B Downlight

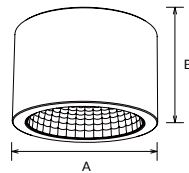

DL115A/B SMD compact and neat surface mounted downlight series with 3 CCT in 1 lamp optional, slide switch for color selection are good for commercial project requirement. An IP54-rated version for indoor use. 60° beam angle with specular reflector can reach UGR<19.

### Reflector



Materials of Housing : PC  
Materials of Optics : PC+Aluminium

- ▶
- ▶
- ▶
- ▶



| Code        | Watt | Size(AxBmm) | Lumen(±5%) | N.W/pc(kgs) | Q'ty/CTN |
|-------------|------|-------------|------------|-------------|----------|
| DL115-4-13W | 13W  | Ø143x112    | 1460lm     | 0.39        | 12PCS    |
| DL115-6-18W | 18W  | Ø170x124    | 1890lm     | 0.49        | 12PCS    |
| DL115-8-25W | 25W  | Ø213x129    | 2930lm     | 0.80        | 12PCS    |

CCT ——— 3000K ——— 4000K ——— 5700K ——— Finish ——— White Black

# PD05A/B Pendant light

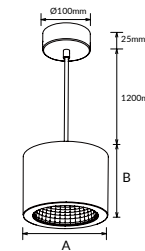

PD05A/B SMD pendant downlight series with 3 CCT in 1 lamp optional, slide switch for color selection is good for commercial project requirement. 60° beam angle with specular reflector can reach UGR<19.

### Reflector

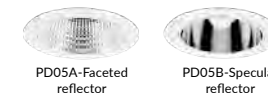

Materials of Housing : PC  
Materials of Optics : PC+Aluminium

- ▶
- ▶
- ▶
- ▶



| Code       | Watt | Size(AxBmm) | Lumen(±5%) | N.W/pc(kgs) | Q'ty/CTN |
|------------|------|-------------|------------|-------------|----------|
| PD05-4-13W | 13W  | Ø143x110    | 1460lm     | 0.65        | 12PCS    |
| PD05-6-18W | 18W  | Ø170x123    | 1890lm     | 0.83        | 12PCS    |
| PD05-8-25W | 25W  | Ø213x127    | 2930lm     | 1.06        | 12PCS    |

CCT ——— 3000K ——— 4000K ——— 5700K ——— Finish ——— White Black



# DL207 Downlight

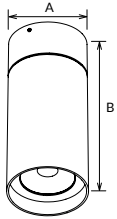

DL207 surface mounted LED downlight, with the special design of adjusting lighting orientation, 330° rotate and 90° tilt. The luminaire adopts CITIZEN brand COB, makes uniform light and excellent lumen output.

Materials of Housing : PC/Die-casting Aluminium

Materials of Optics : PMMA

- ▶ 36° 60° 330° 90° IP20
- ▶ DIM DALI Flicker Free
- ▶ AC 100-240V AC 200-240V CRI≥80 CRI≥90 CRI≥97
- ▶ SAA RoHS CE

| Code      | Watt | Size(AxBmm) | Lumen(±5%) | N.W/pc(kgs) | Q'ty/CTN |
|-----------|------|-------------|------------|-------------|----------|
| DL207-15W | 15W  | Ø85x186     | 1750lm     | 0.67        | 12PCS    |
| DL207-25W | 25W  | Ø85x211     | 2900lm     | 0.73        | 12PCS    |

CCT ——— 2700K ——— 3000K ——— 4000K

Finish ——— White Black



LED Downlight  
Surface mounted  
& Pendant Series



# LED Ceiling Light & LED Bulkhead */Series/*

LED ceiling light in all its forms—most of the time plays a secondary role of attention but attach great importance to the general lighting of a room. It puts your room in best lighting effect by innovative lighting solutions and design. UPSHINE ceiling light series has a low profile design providing a discreet, robust and stylish emergency, sensor and main luminaires.

It's with Elegantly slim and offered as both emergency and mains luminaires. It allows same seamless profile to be used throughout an installation. All options in the range are ideal for all projects when a high quality luminaire is required. Offering wide flexibility in facility lighting which is best suited to residential and commercial areas.

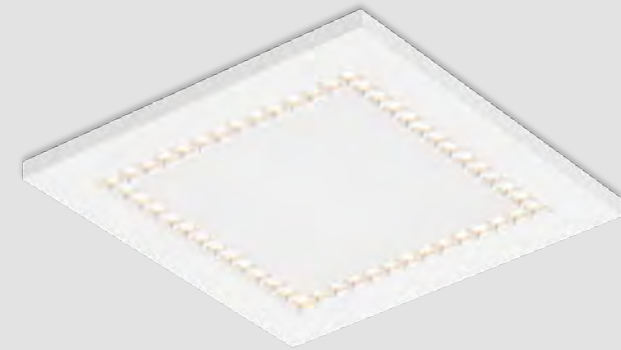

# AL37 Ceiling light

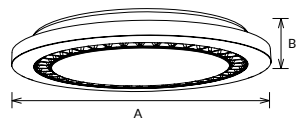

AL37 Anti-glare LED ceiling light adopts multi-louver reflectors, effectively reduces glare index(UGR) to protecting human eyes. High luminous efficiency and fast connection terminal design make it to be widely used in various lighting applications. Microwave Sensor and Triac dimmable function are available.

Materials of Housing : PC  
Materials of Optics : PC

- ▶
- ▶
- ▶
- ▶

| Code        | Watt | Size(AxBmm) | Lumen(±5%) | N.W/pc(kgs) | Q'ty/CTN |
|-------------|------|-------------|------------|-------------|----------|
| AL37-10-12W | 12W  | Ø250x33     | 1520lm     | 0.54        | 20PCS    |
| AL37-12-15W | 15W  | Ø300x33     | 2000lm     | 0.80        | 10PCS    |
| AL37-16-25W | 25W  | Ø400x33     | 3120lm     | 1.33        | 10PCS    |

# AL38 Ceiling light

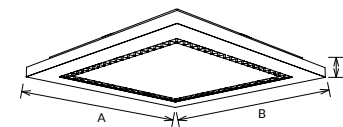

AL38 Anti-glare square ceiling light adopts multi louver reflectors, effectively reduces glare index(UGR) to protecting human eyes. High luminous efficiency and fast connection terminal design make it to be widely used in various lighting applications. Microwave Sensor and Triac dimmable function are available.

Materials of Housing : PC  
Materials of Optics : PC

- ▶
- ▶
- ▶
- ▶

| Code        | Watt | Size(AxBxCmm) | Lumen(±5%) | N.W/pc(kgs) | Q'ty/CTN |
|-------------|------|---------------|------------|-------------|----------|
| AL38-10-12W | 12W  | 250x250x33    | 1560lm     | 0.66        | 20PCS    |
| AL38-12-15W | 15W  | 300x300x33    | 1890lm     | 0.90        | 10PCS    |
| AL38-16-25W | 25W  | 400x400x33    | 3050lm     | 1.58        | 10PCS    |

CCT — 3000K — 4000K — 5700K

Finish — White

CCT — 3000K — 4000K — 5700K

Finish — White



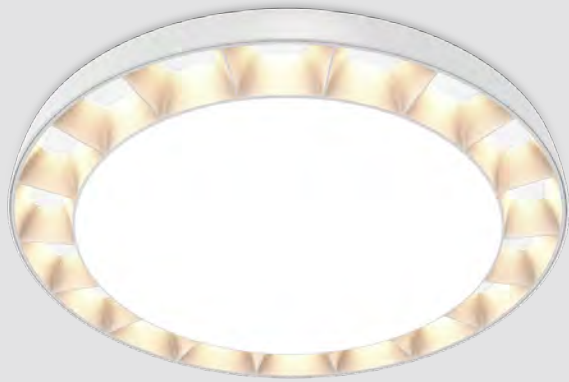

# AL131 Ceiling light

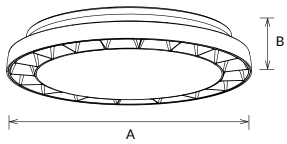

AL131 is a grille-reflector ceiling light with low glare, offering comfortable visual experience. It's the perfect combination of technology and art, suitable for modern lighting.

Materials of Housing : PC

Materials of Optics : PC

- ▶
- ▶
- ▶
- ▶

| Code         | Watt | Size(AxBmm) | Lumen(±5%) | N.W/pc(kgs) | Q'ty/CTN |
|--------------|------|-------------|------------|-------------|----------|
| AL131-11-11W | 11W  | Ø275x48     | 1350lm     | 0.81        | 12PCS    |
| AL131-11-17W | 17W  | Ø275x48     | 1900lm     | 0.81        | 12PCS    |
| AL131-14-17W | 17W  | Ø350x48     | 1900lm     | 1.23        | 10PCS    |
| AL131-14-24W | 24W  | Ø350x48     | 2600lm     | 1.23        | 10PCS    |

## IP54 GRILL REFLECTOR REPLACEABLE

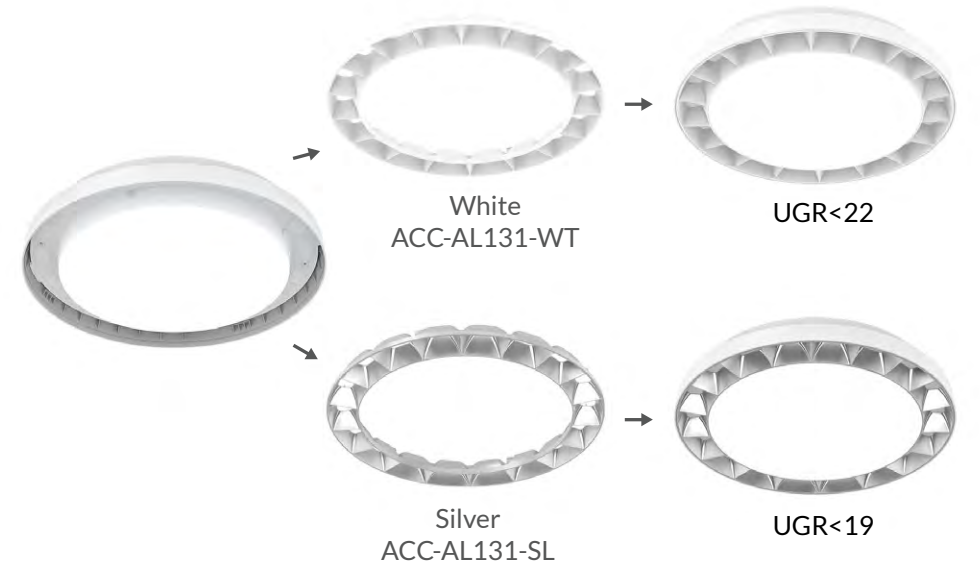
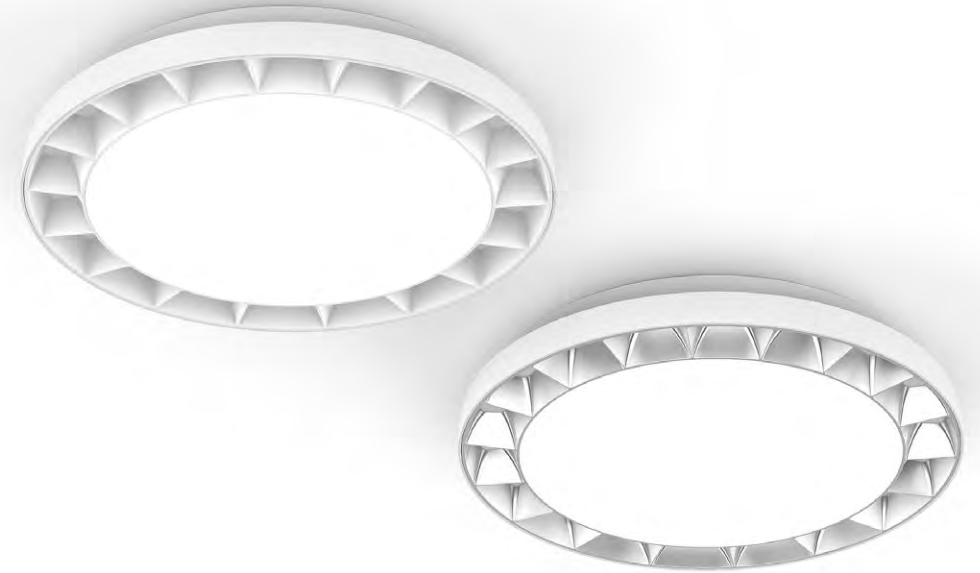

LED Ceiling light

CCT ——— 3000K ——— 4000K

Finish ——— White ——— Silver



# AL188 Ceiling light

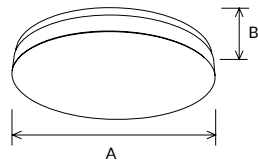

AL188 LED ceiling light is tool free modular design, the modules can be replaceable tool free. It includes 10inch,12inch and 16inch, adopting high lumen SMD led, PIR sensor,microwave sensor, emergency, CCT interchangeable and wattage adjustable are available, IP54 and IK06 ( not include PIR sensor version ) protection level. Dimming way: triac dim and dali dim.

Materials of Housing : PC

Materials of Optics : PC



| Code         | Watt | Size(AxBmm) | Lumen(±5%) | N.W/pc(kgs) | Q'ty/CTN |
|--------------|------|-------------|------------|-------------|----------|
| AL188-10-10W | 10W  | Ø250x53     | 1000lm     | 1.20        | 12PCS    |
| AL188-10-15W | 15W  | Ø250x53     | 1500lm     | 1.20        | 12PCS    |
| AL188-12-12W | 12W  | Ø300x53     | 1230lm     | 1.80        | 6PCS     |
| AL188-12-18W | 18W  | Ø300x53     | 1980lm     | 1.80        | 6PCS     |
| AL188-12-25W | 25W  | Ø300x53     | 2750lm     | 1.80        | 6PCS     |
| AL188-16-18W | 18W  | Ø400x53     | 1980lm     | 2.20        | 6PCS     |
| AL188-16-25W | 25W  | Ø400x53     | 2750lm     | 2.20        | 6PCS     |
| AL188-16-30W | 30W  | Ø400x53     | 3300lm     | 2.20        | 6PCS     |



# AL189 Ceiling light

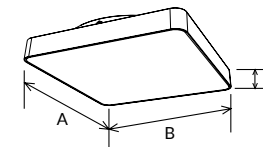

AL189 is a square led ceiling light with modular design, adopting high lumen SMD LED, IP54 and IK08 protection level, multi-functional with adjustable microwave sensor, PIR sensor, emergency, CCT interchangeable and wattage selection. Dimming way: triac dim and DALI dim.

Materials of Housing : PC

Materials of Optics : PC

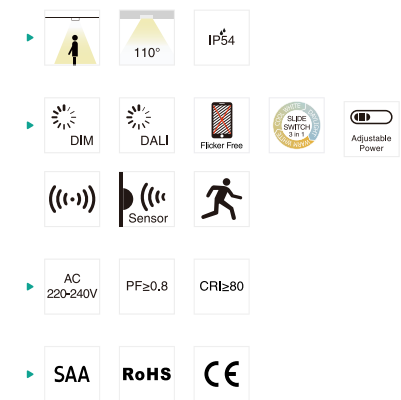

| Code         | Watt | Size(AxBxCmm) | Lumen(±5%) | N.W/pc(kgs) | Q'ty/CTN |
|--------------|------|---------------|------------|-------------|----------|
| AL189-10-10W | 10W  | 250x250x54    | 1200lm     | 0.98        | 12PCS    |
| AL189-10-15W | 15W  | 250x250x54    | 1800lm     | 0.98        | 12PCS    |
| AL189-12-15W | 15W  | 300x300x54    | 1800lm     | 1.33        | 12PCS    |
| AL189-12-18W | 18W  | 300x300x54    | 2160lm     | 1.33        | 12PCS    |
| AL189-12-25W | 25W  | 300x300x54    | 3000lm     | 1.33        | 12PCS    |
| AL189-16-18W | 18W  | 400x400x54    | 2160lm     | 2.03        | 6PCS     |
| AL189-16-25W | 25W  | 400x400x54    | 3000lm     | 2.03        | 6PCS     |
| AL189-16-30W | 30W  | 400x400x54    | 3600lm     | 2.03        | 6PCS     |





# AL165 Ceiling light

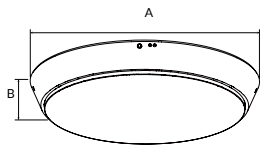

AL165 LED ceiling light adopts high lumen SMD LED with 120lm/W light efficiency. It is IP44 and IK06 protection level. Multiple functions for options: triac dim, CCT interchangeable, sensor and emergency.

Materials of Housing : PC

Materials of Optics : PC

- ▶
- ▶
- ▶
- ▶

| Code         | Watt | Size(AxBxCmm) | Lumen(±5%) | N.W/pc(kgs) | Q'ty/CTN |
|--------------|------|---------------|------------|-------------|----------|
| AL165-10-12W | 12W  | Ø250x50       | 1500lm     | 0.65        | 12PCS    |
| AL165-12-12W | 12W  | Ø300x50       | 1500lm     | 1.00        | 6PCS     |
| AL165-12-18W | 18W  | Ø300x50       | 2200lm     | 1.00        | 6PCS     |
| AL165-16-25W | 25W  | Ø420x50       | 3100lm     | 1.65        | 6PCS     |
| AL165-16-30W | 30W  | Ø420x50       | 3600lm     | 1.65        | 6PCS     |

CCT ——— 3000K ——— 4000K ——— 5700K

Finish ——— White



LED Ceiling light



## AL137 Ceiling light

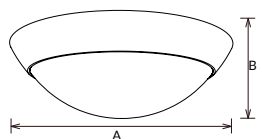

AL137 LED ceiling light with oyster design, 120° beam angle and IP44 waterproof are available. Multiple functions: dim, 3CCT changeable, sensor and emergency. Available for both rear and side cable entry.

Materials of Housing : PC

Materials of Optics : PC

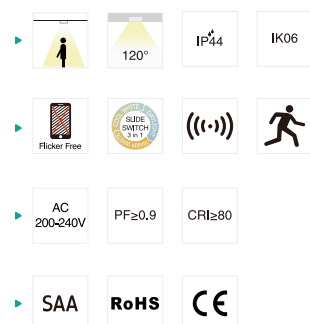

| Code         | Watt | Size(AxBmm) | Lumen(±5%) | N.W/pc(kgs) | Q'ty/CTN |
|--------------|------|-------------|------------|-------------|----------|
| AL137-10-12W | 12W  | Ø250x86     | 1400lm     | 0.50        | 12PCS    |
| AL137-12-15W | 15W  | Ø300x90     | 1800lm     | 0.85        | 10PCS    |
| AL137-16-18W | 18W  | Ø420x110    | 2200lm     | 1.50        | 6PCS     |
| AL137-16-25W | 25W  | Ø420x110    | 3000lm     | 1.50        | 6PCS     |

CCT — 3000K — 4000K — 5700K

Finish — White



## AL137B Ceiling light

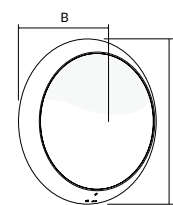

AL137B LED wall lamp is with arc surface design with 30° downward polarized light, adopting high lumen SMD LED. Multiple functions with triac dim, CCT interchangeable, sensor and emergency. Available for both rear and side cable entry.

Materials of Housing : PC

Materials of Optics : PC



| Code          | Watt | Size(AxBmm) | Lumen(±5%) | N.W/pc(kgs) | Q'ty/CTN |
|---------------|------|-------------|------------|-------------|----------|
| AL137B-12-18W | 18W  | Ø300x90     | 2000lm     | 0.85        | 6PCS     |

CCT — 3000K — 4000K — 5700K

Finish — White



# AL166 Ceiling light

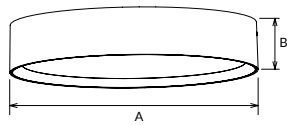

AL166 LED ceiling light is stylish and modern design, with golden/ white/ black decorative rings. It can do multiple installation with surface/recessed/ suspension with accessories easily.

Materials of Housing : Die-casting Aluminium+PC  
Materials of Optics : PC

- ▶
- ▶
- ▶
- ▶

| Code         | Watt | Size(AxBmm) | Cut-out(mm) | Lumen(±5%) | N.W/pc(kgs) | Q'ty/CTN |
|--------------|------|-------------|-------------|------------|-------------|----------|
| AL166-12-18W | 18W  | Ø301x58     | Ø320x85     | 1800lm     | 1.30        | 6PCS     |
| AL166-12-24W | 24W  | Ø301x58     | Ø320x85     | 2500lm     | 1.30        | 6PCS     |
| AL166-16-24W | 24W  | Ø422x58     | Ø440x85     | 2750lm     | 2.20        | 6PCS     |
| AL166-16-30W | 30W  | Ø422x58     | Ø440x85     | 3400lm     | 2.20        | 6PCS     |

CCT ——— 3000K ——— 4000K ——— 5700K      Finish ——— White Black

Installation accessories ——— ACC-AL166-WT-BK-0200      ACC-AL166-12/16-WT-0300



Surface mounted

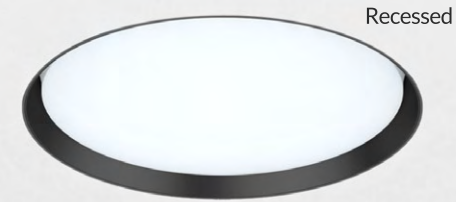

Recessed



Suspended

LED Ceiling light

# AL166

Elegant design  
with uniform lighting



## Multiple installations



• AL99C

Flat



• AL99D

Curved  
(Recessed)

## AL99C/D Ceiling light

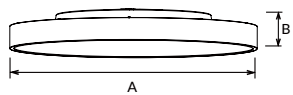

AL99C/D LED ceiling light is with high efficiency uniform LED lens, Opal or Microprismatic diffuser, AL99C as flat surface, AL99D as curved surface. It can be Up&down lighting and down lighting only. Multiple installation ways available as surface mounted, recessed, suspended. Microwave sensor and emergency are available.

Materials of Housing : Aluminium

Materials of Optics : PS

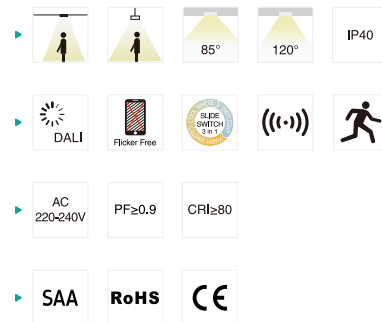

| Code          | Watt | Size(AxBmm) | Cut-out(mm) | Lumen(±5%) | N.W/pc(kgs) | Q'ty/CTN |
|---------------|------|-------------|-------------|------------|-------------|----------|
| AL99C-16-40W  | 40W  | Ø400x86     | Ø220-250    | 4450lm     | 2.61        | 6PCS     |
| AL99C-24-60W  | 60W  | Ø600x86     | Ø385-415    | 6920lm     | 5.96        | 2PCS     |
| AL99C-32-75W  | 75W  | Ø800x86     | Ø385-415    | 9100lm     | 7.17        | 1PCS     |
| AL99C-40-100W | 100W | Ø1000x86    | Ø385-415    | 11920lm    | 10.83       | 1PCS     |
| AL99D-16-40W  | 40W  | Ø400x86     | Ø220-250    | 4450lm     | 2.61        | 6PCS     |
| AL99D-24-60W  | 60W  | Ø600x86     | Ø385-415    | 6920lm     | 5.96        | 2PCS     |
| AL99D-32-75W  | 75W  | Ø800x86     | Ø385-415    | 9100lm     | 7.17        | 1PCS     |
| AL99D-40-100W | 100W | Ø1000x86    | Ø385-415    | 11920lm    | 10.83       | 1PCS     |

CCT — 3000K — 4000K — 5700K      Finish — White — Black — Wood grain



Wire harness suspension



Pendant rod suspension



Steel wire suspension

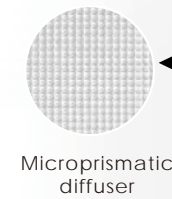

Microprismatic diffuser

Wall mounted  
(Indirect lighting)



Wall mounted  
(Direct lighting)

LED Ceiling light



# AL194 Ceiling light

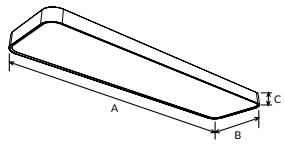

AL194 is a rectangular led ceiling light, adopting high lumen SMD LED, white and black finish can be provided, DALI dim and interchangeable CCT function are available. Installation way: surface mounted and pendant.

Materials of Housing : Aluminium

Materials of Optics : PS

- ▶ DALI, Flicker Free, SLIDE SWITCH, 80°, 110°, IP20
- ▶ AC 200-240V, PF ≥ 0.9, CRI ≥ 80
- ▶ SAA, RoHS, CE

| Code      | Watt | Size(AxBxCmm) | Lumen(±5%) | N.W/pc(kgs) | Q'ty/CTN |
|-----------|------|---------------|------------|-------------|----------|
| AL194-36W | 36W  | 1200x300x72   | 5200lm     | 4.50        | 2PCS     |
| AL194-42W | 42W  | 1200x300x72   | 6100lm     | 4.50        | 2PCS     |
| AL194-50W | 50W  | 1200x300x72   | 7300lm     | 4.50        | 2PCS     |

CCT ——— 3000K ——— 4000K ——— 5700K

Finish ——— White Black



LED Ceiling light



# AL174/B Ceiling light

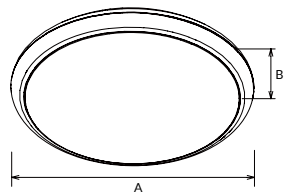

AL174 is IP65 water-proof ceiling light, available with adjustable CCT, microwave sensor, PIR sensor triac dim, DALI 2.0 push dim function. Screless surface, ceiling & wall mounting, and quick installation makes it an excellent model. Available for both rear and side cable entry.

Materials of Housing : PC  
Materials of Optics : PC

- ▶
- ▶
- ▶
- ▶

| Code          | Watt | Size(AxBmm) | Lumen(±5%) | N.W/pc(kgs) | Q'ty/CTN |
|---------------|------|-------------|------------|-------------|----------|
| AL174-10-12W  | 12W  | Ø250x70     | 1350lm     | 0.52        | 12PCS    |
| AL174-12-18W  | 18W  | Ø300x70     | 2030lm     | 0.85        | 6PCS     |
| AL174-12-25W  | 25W  | Ø300x70     | 2670lm     | 0.85        | 6PCS     |
| AL174-16-25W  | 25W  | Ø400x79     | 2750lm     | 1.38        | 6PCS     |
| AL174-16-30W  | 30W  | Ø400x79     | 3350lm     | 1.38        | 5PCS     |
| AL174B-12-18W | 18W  | Ø300x75     | 2670lm     | 0.89        | 6PCS     |
| AL174B-16-25W | 25W  | Ø400x81     | 2750lm     | 1.40        | 5PCS     |
| AL174B-16-30W | 30W  | Ø400x81     | 3350lm     | 1.40        | 5PCS     |

CCT — 3000K — 4000K — 5700K

Finish — White

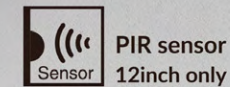
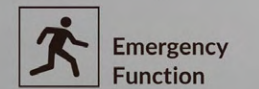

## AL174 SERIES IP65 LED CEILING LIGHT



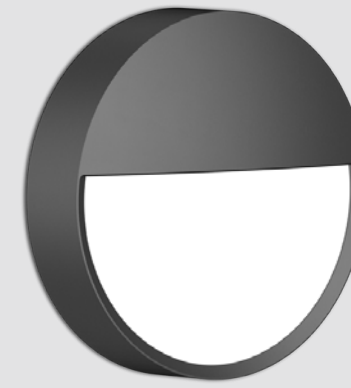

## AL96 Bulkhead

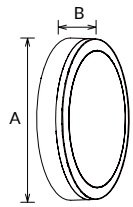

AL96 is IP65 and IK10 LED ceiling light, which adopts high lumen SMD LED. Wall mounted and surface mounted for options. Multiple functions such as 3 CCT and power interchangeable, emergency, adjustable sensor, triac/0-10V/ DALI dimmable are available. Available for both rear and side cable entry

Materials of Housing : PC

Materials of Optics : PC

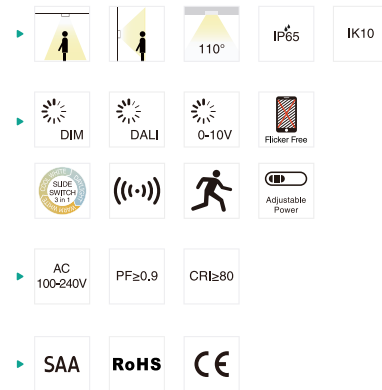

| Code        | Watt | Size(AxBmm) | Lumen(±5%) | N.W/pc(kgs) | Q'ty/CTN |
|-------------|------|-------------|------------|-------------|----------|
| AL96-8-12W  | 12W  | Ø200x60     | 1250lm     | 0.48        | 12PCS    |
| AL96-11-12W | 12W  | Ø275x60     | 1300lm     | 0.85        | 12PCS    |
| AL96-11-18W | 18W  | Ø275x60     | 1850lm     | 0.85        | 12PCS    |
| AL96-11-25W | 25W  | Ø275x60     | 2530lm     | 0.85        | 12PCS    |
| AL96-14-25W | 25W  | Ø350x60     | 2530lm     | 1.38        | 6PCS     |
| AL96-14-30W | 30W  | Ø350x60     | 2920lm     | 1.38        | 6PCS     |

CCT — 3000K — 4000K — 5700K

Finish — White — Black



## AL66 Bulkhead

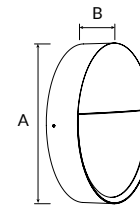

AL66 is IP65 IK08 LED bulkhead, this fixture provides an alternative to the color changeable and emergency function, it is a perfect answer to complete your outdoor look.

Materials of Housing : Aluminium

Materials of Optics : PC

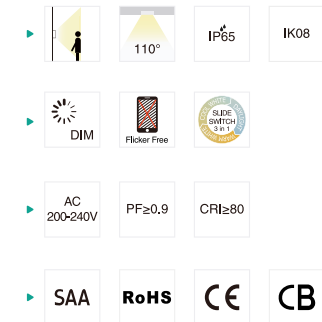

| Code        | Watt | Size(AxBmm) | Lumen(±5%) | N.W/pc(kgs) | Q'ty/CTN |
|-------------|------|-------------|------------|-------------|----------|
| AL66-10-12W | 12W  | Ø250x74     | 1100lm     | 1.10        | 10PCS    |

CCT — 3000K — 4000K — 5700K

Finish — Black

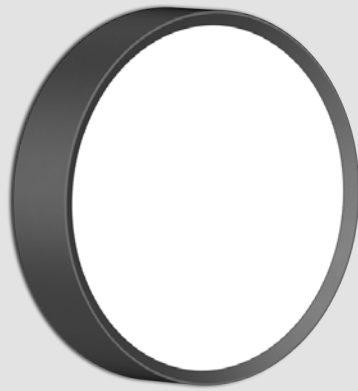

IP **65**  
20 JOULES=IK **10**



## AL65 Bulkhead

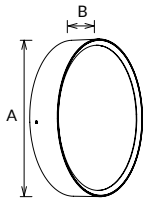

AL65 is IP65 IK08 LED bulkhead, this fixture provides an alternative to the color changeable and emergency function, it is a perfect answer to complete your outdoor look.

Materials of Housing : Aluminium

Materials of Optics : PC



| Code        | Watt | Size(AxBmm) | Lumen(±5%) | N.W/pc(kgs) | Q'ty/CTN |
|-------------|------|-------------|------------|-------------|----------|
| AL65-10-12W | 12W  | Ø250x58     | 1250lm     | 1.05        | 10PCS    |
| AL65-10-18W | 18W  | Ø250x58     | 1850lm     | 1.15        | 10PCS    |

CCT — 3000K — 4000K — 5700K

Finish — Black

## AL65B Bulkhead

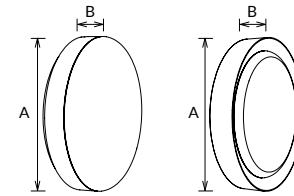

AL65 is IP65 IK08 LED bulkhead, this fixture is with four frames options and provides an alternative to color changeable, adjustable sensor and emergency function. It is a perfect answer to complete your outdoor look.

Materials of Housing : Die-casting Aluminium

Materials of Optics : PC



| Code         | Watt | Size(AxBmm) | Lumen(±5%) | N.W/pc(kgs) | Q'ty/CTN |
|--------------|------|-------------|------------|-------------|----------|
| AL65B-10-12W | 12W  | Ø251x64     | 1420lm     | 1.18        | 10PCS    |
| AL65B-10-18W | 18W  | Ø251x64     | 2120lm     | 1.18        | 10PCS    |
| AL65B-10-12W | 12W  | Ø300x64     | 1400lm     | 1.49        | 6PCS     |
| AL65B-10-18W | 18W  | Ø300x64     | 2070lm     | 1.49        | 6PCS     |

CCT — 3000K — 4000K — 5700K

Finish — White Black

Ring — ACC-AL65B-10-BK-50

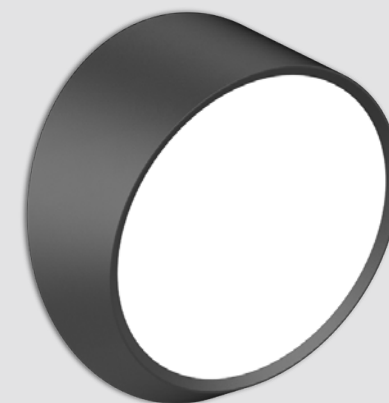
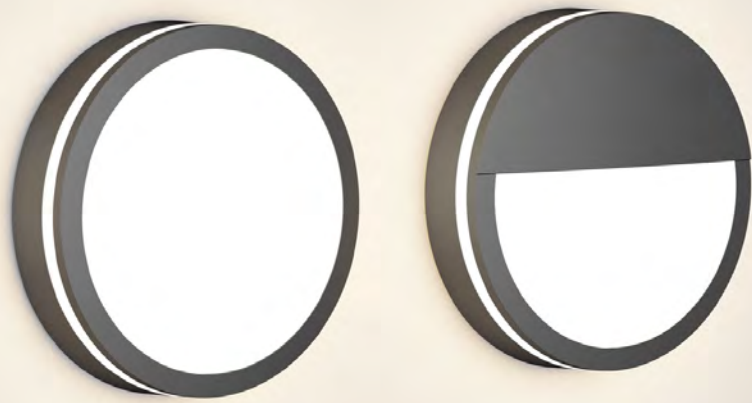

**IP 65**  
20 JOULES=**IK 10**

## AL65C Bulkhead

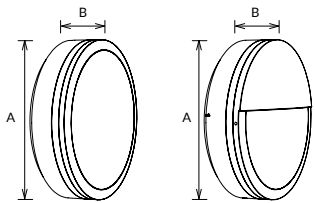

AL65 is IP65 IK08 LED bulkhead, this fixture is with four frames options and provides an alternative to color changeable, adjustable sensor and emergency function, it is a perfect answer to complete your outdoor look.

Materials of Housing : Die-casting Aluminium

Materials of Optics : PC

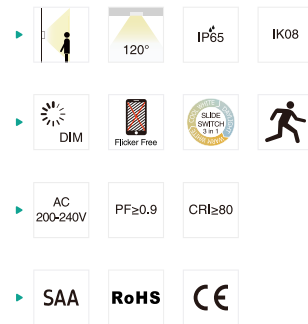

| Code         | Watt | Size(AxBmm) | Lumen(±5%) | N.W/pc(kgs) | Q'ty/CTN |
|--------------|------|-------------|------------|-------------|----------|
| AL65C-10-12W | 12W  | Ø251x75     | 1030lm     | 1.34        | 10PCS    |
| AL65C-10-18W | 18W  | Ø251x75     | 1530lm     | 1.34        | 10PCS    |
| AL65C-10-12W | 12W  | Ø251x76     | 720lm      | 1.44        | 10PCS    |
| AL65C-10-18W | 18W  | Ø251x76     | 970lm      | 1.44        | 10PCS    |

CCT — 3000K — 4000K — 5700K

Finish — White Black

Ring —   
ACC-AL65C-10-BK-50 ACC-AL65C-10-BK-51

## AL65D Bulkhead

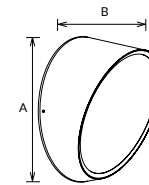

AL65D LED bulkhead adopts high lumen 2835 SMD light source. It has a high transmittance and uniform light output. High protection level IK06&IP65, high lumen efficiency 100lm/W with 110° beam angel are available. More functions: CCT interchangeable, triac dim wth flicker free and S7 sensor.

Materials of Housing : Die-casting Aluminium

Materials of Optics : PC



| Code         | Watt | Size(AxBmm) | Lumen(±5%) | N.W/pc(kgs) | Q'ty/CTN |
|--------------|------|-------------|------------|-------------|----------|
| AL65D-10-15W | 15W  | Ø251x116    | 1500lm     | 1.09        | 12PCS    |

CCT — 3000K — 4000K — 5700K

Finish — White Black



## AL162/B Bulkhead

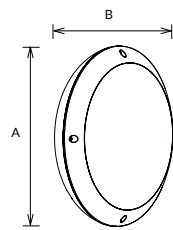

AL162 is an IP65 IK08 LED bulkhead with full bezel shape, adopting high lumen SMD LED. It can do CCT interchangeable, adjustable sensor and emergency available. Available for both rear and side cable entry.

Materials of Housing : ABS

Materials of Optics : PC

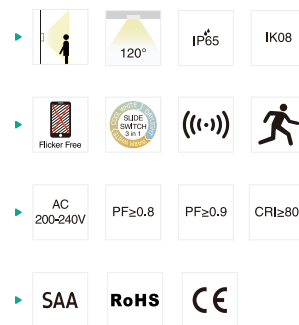

| Code          | Watt | Size(AxBmm) | Lumen(±5%) | N.W/pc(kgs) | Q'ty/CTN |
|---------------|------|-------------|------------|-------------|----------|
| AL162-12-12W  | 12W  | Ø300x95     | 1270lm     | 0.83        | 6PCS     |
| AL162-12-14W  | 14W  | Ø300x95     | 1490lm     | 0.83        | 6PCS     |
| AL162-12-18W  | 18W  | Ø300x95     | 1680lm     | 0.83        | 6PCS     |
| AL162B-12-12W | 12W  | Ø300x95     | 1320lm     | 0.83        | 6PCS     |
| AL162B-12-14W | 14W  | Ø300x95     | 1540lm     | 0.83        | 6PCS     |
| AL162B-12-18W | 18W  | Ø300x95     | 1840lm     | 0.83        | 6PCS     |

CCT — 3000K — 4000K — 5700K

Finish — White — Black

## AL163/B Bulkhead

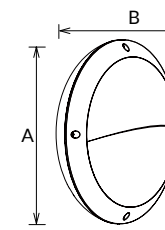

AL163 is an IP65 IK08 LED bulkhead with eyelid bezel shape, adopting high lumen SMD LED. It can do CCT interchangeable, adjustable sensor and emergency available. Available for both rear and side cable entry.

Materials of Housing : ABS

Materials of Optics : PC

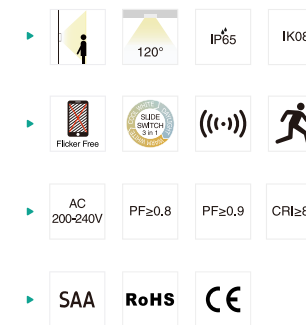

| Code          | Watt | Size(AxBmm) | Lumen(±5%) | N.W/pc(kgs) | Q'ty/CTN |
|---------------|------|-------------|------------|-------------|----------|
| AL163-12-12W  | 12W  | Ø300x97     | 1020lm     | 0.85        | 6PCS     |
| AL163-12-14W  | 14W  | Ø300x97     | 1190lm     | 0.85        | 6PCS     |
| AL163-12-18W  | 18W  | Ø300x97     | 1340lm     | 0.85        | 6PCS     |
| AL163B-12-12W | 12W  | Ø300x97     | 1050lm     | 0.85        | 6PCS     |
| AL163B-12-14W | 14W  | Ø300x97     | 1190lm     | 0.85        | 6PCS     |
| AL163B-12-18W | 18W  | Ø300x97     | 1530lm     | 0.85        | 6PCS     |

CCT — 3000K — 4000K — 5700K

Finish — White — Black

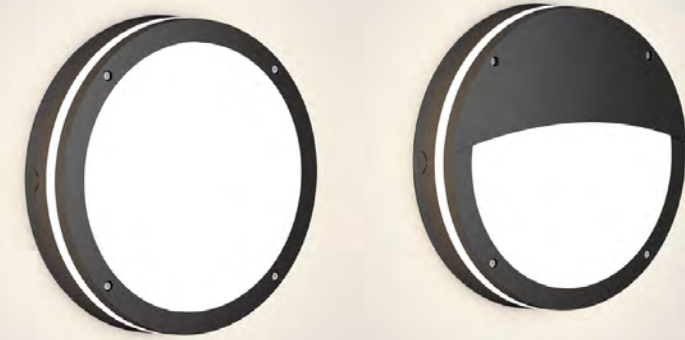

# AL91 Bulkhead

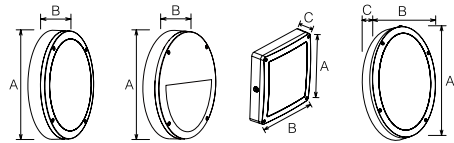

AL91 is with multiple shapes design, including circle, semicircle, square and oval, adopting high lumen SMD LED. Wall mounted and surface mounted available. The base and shade are detachable which make easier maintenance and installation. Remote sensor control for 15W & 25W. Available for both rear and side cable entry.

Materials of Housing : PC  
Materials of Optics : PC

- ▶
- ▶
- ▶
- ▶
- ▶

| Code                   | Watt | Size(AxBxCmm) | Lumen(±5%) | N.W/pc(kgs) | Q'ty/CTN |
|------------------------|------|---------------|------------|-------------|----------|
| AL91-11-12W-Circle     | 12W  | Ø275x59       | 1250lm     | 0.76        | 12PCS    |
| AL91-11-18W-Circle     | 18W  | Ø275x59       | 1780lm     | 0.76        | 12PCS    |
| AL91-11-25W-Circle     | 25W  | Ø275x59       | 2450lm     | 0.76        | 12PCS    |
| AL91-14-25W-Circle     | 25W  | Ø350x59       | 2450lm     | 1.19        | 6PCS     |
| AL91-14-30W-Circle     | 30W  | Ø350x59       | 2850lm     | 1.19        | 6PCS     |
| AL91-11-12W-Semicircle | 12W  | Ø275x59       | 1150lm     | 0.77        | 12PCS    |
| AL91-11-18W-Semicircle | 18W  | Ø275x59       | 1650lm     | 0.77        | 12PCS    |
| AL91-10-12W-Square     | 12W  | 242x242x59    | 1250lm     | 0.72        | 12PCS    |
| AL91-10-18W-Square     | 18W  | 242x242x59    | 1780lm     | 0.72        | 12PCS    |
| AL91-10-25W-Square     | 25W  | 242x242x59    | 2450lm     | 0.72        | 12PCS    |
| AL91-12-12W-Oval       | 12W  | 320x230x60    | 1250lm     | 0.78        | 12PCS    |
| AL91-12-18W-Oval       | 18W  | 320x230x60    | 1780lm     | 0.78        | 12PCS    |
| AL91-12-25W-Oval       | 25W  | 320x230x60    | 2450lm     | 0.78        | 12PCS    |

CCT ——— 3000K ——— 4000K ——— 5700K

Finish ——— White ——— Black

# AL91E Bulkhead

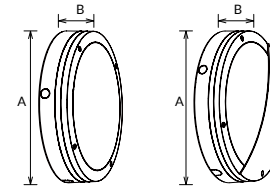

AL91E LED ceiling light with modular design which adopts high lumen SMD LED. It has a wide lighting area with down lighting and side lighting. IP65 and IK10 are suitable for outdoor application. Multiple functions: interchangeable CCT and power, adjustable sensor, emergency. And DALI/0-10V/Triac dimmable are available. Available for both rear and side cable entry.

Materials of Housing : PC  
Materials of Optics : PC

- ▶
- ▶
- ▶
- ▶
- ▶

| Code                    | Watt | Size(AxBmm) | Lumen(±5%) | N.W/pc(kgs) | Q'ty/CTN |
|-------------------------|------|-------------|------------|-------------|----------|
| AL91E-11-12W-Circle     | 15W  | Ø275x67     | 1150lm     | 0.92        | 12PCS    |
| AL91E-11-18W-Circle     | 18W  | Ø275x67     | 1650lm     | 0.92        | 12PCS    |
| AL91E-11-25W-Circle     | 25W  | Ø275x67     | 2250lm     | 0.92        | 12PCS    |
| AL91E-11-12W-Semicircle | 12W  | Ø275x68     | 750lm      | 0.95        | 12PCS    |
| AL91E-11-18W-Semicircle | 18W  | Ø275x68     | 1100lm     | 0.95        | 12PCS    |
| AL91E-11-25W-Semicircle | 25W  | Ø275x68     | 1550lm     | 0.95        | 12PCS    |

CCT ——— 3000K ——— 4000K ——— 5700K

Finish ——— White ——— Black

Ring ——— ACC-AL91E

LED Bulkhead



# AL91F Bulkhead

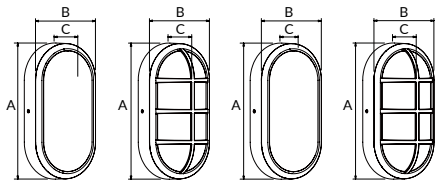

AL91F is IP65 IK08 bulkhead with oval shape and surface frame DIY design, adopting high lumen SMD LED. CCT interchangeable with slide switch and PIR sensor function available. Available for both rear and side cable entry.

Materials of Housing : PC  
Materials of Optics : PC

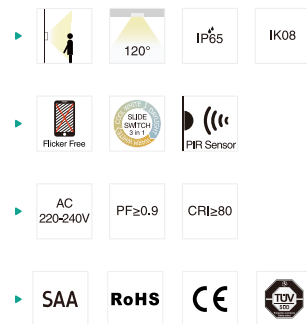

| Code              | Watt | Size(AxBxCmm) | Lumen(±5%) | N.W/pc(kgs) | Q'ty/CTN |
|-------------------|------|---------------|------------|-------------|----------|
| AL91F-8-5W        | 5W   | 220x120x66    | 600lm      | 0.40        | 30PCS    |
| AL91F-8-10W       | 10W  | 220x120x66    | 1100lm     | 0.40        | 30PCS    |
| AL91F-8-5W        | 5W   | 220x120x69    | 500lm      | 0.40        | 30PCS    |
| AL91F-8-10W       | 10W  | 220x120x69    | 900lm      | 0.40        | 30PCS    |
| ACC-AL91F-8-BK-50 | -    | 220x120x36.5  | -          | 0.06        | 30PCS    |
| ACC-AL91F-8-WH-50 | -    | 220x120x36.5  | -          | 0.06        | 30PCS    |
| ACC-AL91F-8-BK-51 | -    | 220x120x69    | -          | 0.07        | 30PCS    |
| ACC-AL91F-8-WH-51 | -    | 220x120x69    | -          | 0.07        | 30PCS    |

CCT — 3000K — 4000K — 5700K

Finish — White — Black

# DIY Design AL91F



PIR sensor  
Adjustable

Detection Area Hold Time Daylight Sensor

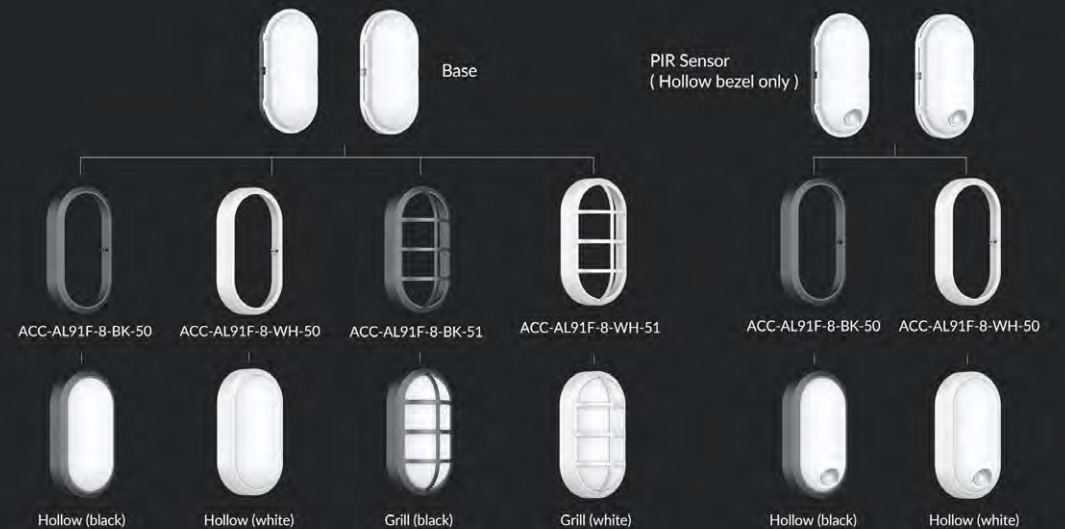



IP 65  
20 JOULES=IK 10

# AL104 Bulkhead

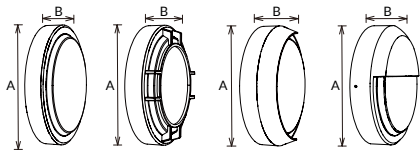

AL104 is IP65 IK10 bulkhead which adopts high lumen SMD LED. This fixture is with four different trims and provides an alternative to color changeable, sensor and emergency functions. Dali and 0-10V dimming is also available.

Materials of Housing : Die-casting Aluminium

Materials of Optics : PC

- ▶
- ▶
- ▶
- ▶
- ▶

| Code          | Watt | Size(AxBmm) | Lumen(±5%) | N.W/pc(kgs) | Q'ty/CTN |
|---------------|------|-------------|------------|-------------|----------|
| AL104A-10-15W | 15W  | Ø250X63     | 1750lm     | 1.05        | 10PCS    |
| AL104A-12-25W | 25W  | Ø300X63     | 3000lm     | 1.58        | 6PCS     |
| AL104B-10-15W | 15W  | Ø250X68     | 1500lm     | 1.15        | 10PCS    |
| AL104B-12-25W | 25W  | Ø300X68     | 2150lm     | 1.69        | 6PCS     |
| AL104C-10-15W | 15W  | Ø250X83     | 1600lm     | 1.19        | 10PCS    |
| AL104C-12-25W | 25W  | Ø300X83     | 2600lm     | 1.73        | 6PCS     |
| AL104D-10-15W | 15W  | Ø250X67     | 1100lm     | 1.38        | 10PCS    |
| AL104D-12-25W | 25W  | Ø300X67     | 1900lm     | 2.05        | 6PCS     |

CCT ——— 3000K ——— 4000K ——— 5700K

Finish ——— White Black



FOUR DIFFERENT TRIMS



LED Bulkhead



IP **65**  
20 JOULES=**IK 10**

## AL104R Bulkhead

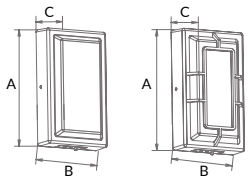

AL104R is IP65 IK10 bulkhead which adopts high lumen SMD LED. AL104R is rectangle. This fixture is with two different trims and provides an alternative to color changeable, sensor and emergency functions. Dali and 0-10V dimming are also available.

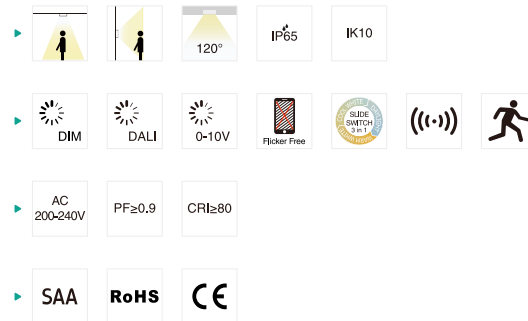

Materials of Housing : Die-casting Aluminium  
Materials of Optics : PC



| Code          | Watt | Size(AxBxCmm) | Lumen(±5%) | N.W/pc(kgs) | Q'ty/CTN |
|---------------|------|---------------|------------|-------------|----------|
| AL104R-10-15W | 15W  | 250x150x63    | 1650lm     | 0.90        | 10PCS    |
| AL104R-10-15W | 15W  | 250x150x69    | 1350lm     | 0.97        | 10PCS    |

CCT — 3000K — 4000K — 5700K



Finish —  White  Black

## AL104S Bulkhead

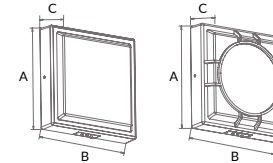

AL104S is IP65 IK10 bulkhead which adopts high lumen SMD LED. AL104S is square version. This fixture is with two different trims and provides an alternative to color changeable, sensor and emergency functions. Dali and 0-10V dimming are also available.

Materials of Housing : Die-casting Aluminium  
Materials of Optics : PC

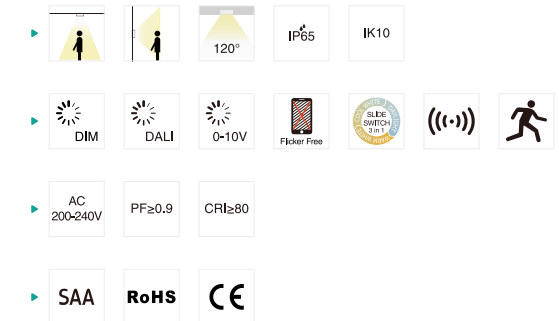

| Code          | Watt | Size(AxBxCmm) | Lumen(±5%) | N.W/pc(kgs) | Q'ty/CTN |
|---------------|------|---------------|------------|-------------|----------|
| AL104S-10-15W | 15W  | 250x250x63    | 1780lm     | 0.90        | 10PCS    |
| AL104S-10-15W | 15W  | 250x250x69    | 1500lm     | 0.97        | 10PCS    |

CCT — 3000K — 4000K — 5700K



Finish —  White  Black





# LED Track Light

/Series/

LED track light has been around for decades, yet it remains as fresh and contemporary a ceiling light fixture as ever. This is due primarily to its pure modern look, with clean, rigid tracks and streamlined directional heads. But function is also a factor when it comes to a track lighting system, with each of the selected track heads independently and easily adjustable and brightly focused. Complete track lighting kits will also allow you to have a stylish ceiling track lighting systems instantly. UPSHINE various track light could be your excellent choice!



TL29A/C



TL29B/D



TL29E



TL29F

## TL29 Track Light /Series/

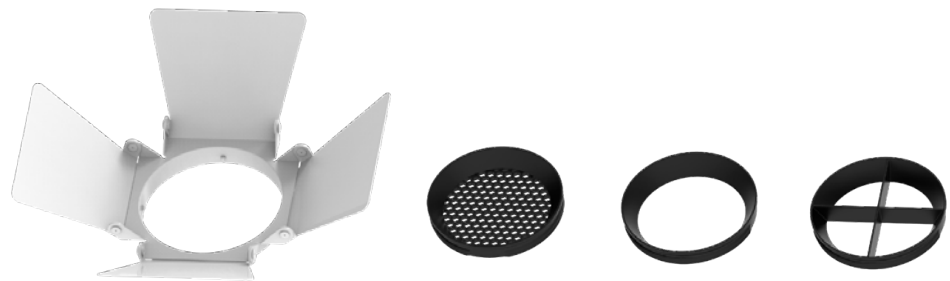



# TL29A Track light

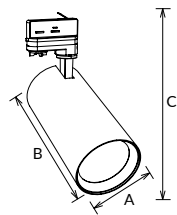

TL29A driverless track light adopts high quality brand DOB led light source. Standard/honeycomb/shutter trims for optional.

Materials of Housing : Aluminium

Materials of Optics : PC

- ▶ 15° 24° 36° 350° 90°
- ▶ Flicker Free
- ▶ AC 220-240V CRI≥80 CRI≥90
- ▶ SAA RoHS CE

| Code      | Watt | Size(AxBxCmm) | Lumen(±5%) | N.W/pc(kgs) | Q'ty/CTN |
|-----------|------|---------------|------------|-------------|----------|
| TL29A-20W | 20W  | Ø85x170x261   | 1560lm     | 0.55        | 12PCS    |
| TL29A-30W | 30W  | Ø100x200x291  | 2550lm     | 0.79        | 12PCS    |
| TL29A-40W | 40W  | Ø100x200x291  | 3400lm     | 0.79        | 12PCS    |

CCT ——— 2700K ——— 3000K ——— 4000K ——— **Finish** ——— White Black Silver

**Trim Accessories** ——— Standard Barn Door ACC-TL29-50 Honeycomb Louver ACC-TL29-51 Cross Louver ACC-TL29-52

# TL29B Track light

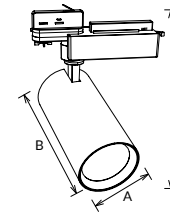

TL29B track light adopts brand Citizen COB with CRI80 CRI90 CRI97 for options.Brand Trodonic Driver available,also could be for Fresh Lighting with Citizen CRI95 Natrual Vivid COB.Standard/honeycomb/shutter trims for optional.

Materials of Housing : Aluminium

Materials of Optics : PC

- ▶ 15° 24° 36° 350° 90°
- ▶ DIM Flicker Free Vivid Lighting
- ▶ AC 220-240V CRI≥80 CRI≥90 CRI≥97
- ▶ SAA RoHS CE

| Code      | Watt | Size(AxBxCmm) | Lumen(±5%) | N.W/pc(kgs) | Q'ty/CTN |
|-----------|------|---------------|------------|-------------|----------|
| TL29B-12W | 12W  | Ø65x150x188   | 1200lm     | 0.52        | 12PCS    |
| TL29B-25W | 25W  | Ø85x170x206   | 2750lm     | 0.75        | 12PCS    |
| TL29B-35W | 35W  | Ø85x200x206   | 3675lm     | 0.79        | 12PCS    |
| TL29B-42W | 42W  | Ø100x200x220  | 4410lm     | 1.05        | 12PCS    |

CCT ——— 2700K ——— 3000K ——— 4000K ——— **Finish** ——— White Black Silver

**Trim Accessories** ——— Standard Barn Door ACC-TL29-50 Honeycomb Louver ACC-TL29-51 Cross Louver ACC-TL29-52

LED Track light



## TL29C Track light

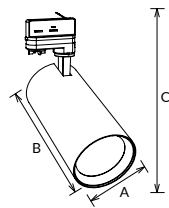

TL29C track light adopts brand Citizen COB led chip with internal driver. Standard/honeycomb/shutter trims for optional.

Materials of Housing : Aluminium

Materials of Optics : PC

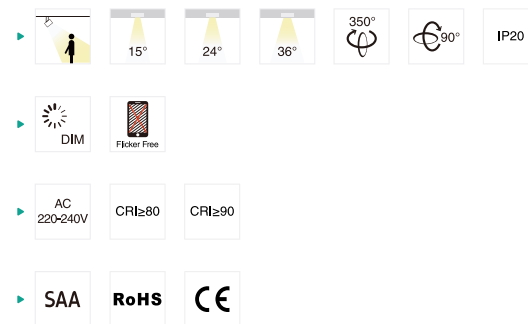

| Code      | Watt | Size(AxBxCmm) | Lumen(±5%) | N.W/pc(kgs) | Q'ty/CTN |
|-----------|------|---------------|------------|-------------|----------|
| TL29C-12W | 12W  | Ø65x150x243   | 1200lm     | 0.47        | 12PCS    |
| TL29C-25W | 25W  | Ø85x200x291   | 2750lm     | 0.68        | 12PCS    |
| TL29C-35W | 35W  | Ø100x200x291  | 3675lm     | 0.79        | 12PCS    |

CCT — 2700K — 3000K — 4000K — Finish — White — Black — Silver

Trim Accessories — Standard — Barn Door ACC-TL29-50 — Honeycomb Louver ACC-TL29-51 — Cross Louver ACC-TL29-52

## TL29D Track light

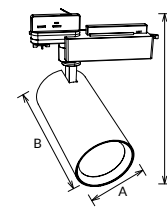

TL29D track light is minimalist design with external driver. It adopts high lumen SMD LED, anti-glare PC lens to achieve great lighting distribution. Tri-color with slide switch to reduce stock, standard/honeycomb/shutter trims for optional.

Materials of Housing : Aluminium

Materials of Optics : PC

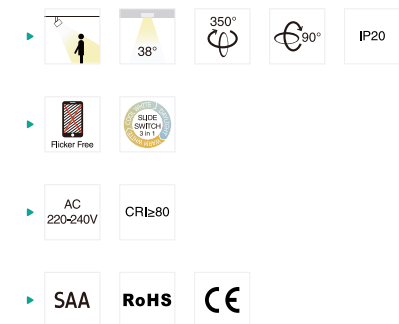

| Code         | Watt | Size(AxBxCmm) | Lumen(±5%) | N.W/pc(kgs) | Q'ty/CTN |
|--------------|------|---------------|------------|-------------|----------|
| TL29D-20W-C3 | 20W  | Ø85x170x206   | 1800lm     | 0.75        | 12PCS    |
| TL29D-30W-C3 | 30W  | Ø85x200x206   | 2600lm     | 0.79        | 12PCS    |

CCT — 3000K — 4000K — 5700K — Finish — White — Black — Silver

Trim Accessories — Standard — Barn Door ACC-TL29-50 — Honeycomb Louver ACC-TL29-51 — Cross Louver ACC-TL29-52



# TL29E Track light

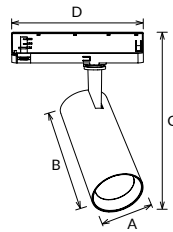

TL29E is with integrated designed of driver and adapter Adopt brand Citizen COB led light source, high quality, reliable performance. CRI80 CRI90 CRI97 for options. Standard/honeycomb/shutter trims available.

Materials of Housing : Aluminium

Materials of Optics : PC

- ▶
- ▶
- ▶
- ▶

| Code      | Watt | Size(AxBxCxDmm) | Lumen(±5%) | N.W/pc(kgs) | Q'ty/CTN |
|-----------|------|-----------------|------------|-------------|----------|
| TL29E-25W | 25W  | Ø85x170x258x198 | 2750lm     | 0.65        | 12PCS    |
| TL29E-35W | 35W  | Ø85x200x288x198 | 3675lm     | 0.68        | 12PCS    |

CCT ——— 2700K ——— 3000K ——— 4000K ——— Finish ——— White Black Silver

Trim Accessories ——— Standard Barn Door ACC-TL29-50 Honeycomb Louver ACC-TL29-51 Cross Louver ACC-TL29-52

# TL29F Track light

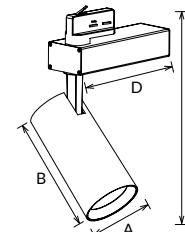

TL29F adopts brand Citizen COB led light source, and external Tridonic DALI driver to ensure high quality, reliable performance. CRI80 CRI90 CRI97 for options. Standard/honeycomb/shutter trims available.

Materials of Housing : Aluminium

Materials of Optics : PC

- ▶
- ▶
- ▶
- ▶

| Code      | Watt | Size(AxBxCxDmm)  | Lumen(±5%) | N.W/pc(kgs) | Q'ty/CTN |
|-----------|------|------------------|------------|-------------|----------|
| TL29F-25W | 25W  | Ø85x170x298x198  | 2610lm     | 0.90        | 12PCS    |
| TL29F-35W | 35W  | Ø85x200x328x198  | 3490lm     | 0.95        | 12PCS    |
| TL29F-42W | 42W  | Ø100x200x328x198 | 4110lm     | 1.20        | 12PCS    |

CCT ——— 2700K ——— 3000K ——— 4000K ——— Finish ——— White Black Silver

Trim Accessories ——— Standard Barn Door ACC-TL29-50 Honeycomb Louver ACC-TL29-51 Cross Louver ACC-TL29-52

LED Track light



# TL90 Track light

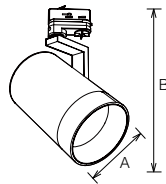

TL90 is a high-end track light with professional optical design. It adopts COB light source, special deep reflector design achieves anti-glare effect (Type A UGR<10, Type B UGR<17). Module design provides an easily replacement with different optic parts: reflector+tempered glass with circle lighting spot, reflector+special PC lens with oval lighting spot. Compact structure with big power 40W/50W which meets a high brightness demand. Horizontally 358 degree, vertically 180 degree rotary. DALI dim available.

Materials of Housing : Die-casting Aluminium

Materials of Optics : Glass+Aluminium/ PC+Aluminium

- ▶ 12° 24° 36° 45° 358°
- ▶ 180° IP40 UGR<19
- ▶ DALI Flicker Free Adjustable Power
- ▶ AC 220-240V PF≥0.9 CRI≥80 CRI≥90 CRI≥97
- ▶ SAA RoHS CE

| Code             | Watt        | Size(AxBmm) | Lumen(±5%)                       | N.W/pc(kgs) | Q'ty/CTN |
|------------------|-------------|-------------|----------------------------------|-------------|----------|
| TL90-70-15W      | 15W         | Ø70x214     | 1250lm                           | 0.54        | 6PCS     |
| TL90A-90-30W-A3  | 20W/25W/30W | Ø90x295     | 20W:2100lm/25W:2400lm/30W:2750lm | 1.20        | 6PCS     |
| TL90A-110-40W-A3 | 30W/35W/40W | Ø110x294.8  | 30W:3200lm/35W:3600lm/40W:3800lm | 1.25        | 6PCS     |
| TL90A-125-50W-A3 | 40W/45W/50W | Ø125x315.4  | 40W:4000lm/45W:4400lm/50W:4700lm | 1.56        | 6PCS     |
| TL90A-110-30W-DA | 30W         | Ø110x294.8  | 2600lm                           | 1.25        | 6PCS     |
| TL90A-125-40W-DA | 40W         | Ø125x315.4  | 3500lm                           | 1.56        | 6PCS     |
| TL90B-90-30W-A3  | 20W/25W/30W | Ø90x280     | 20W:2300lm/25W:2850lm/30W:3100lm | 1.20        | 6PCS     |
| TL90B-110-40W-A3 | 30W/35W/40W | Ø110x269.8  | 30W:3300lm/35W:3700lm/40W:4000lm | 1.25        | 6PCS     |
| TL90B-125-50W-A3 | 40W/45W/50W | Ø125x287.4  | 40W:4000lm/45W:4600lm/50W:5000lm | 1.56        | 6PCS     |
| TL90B-110-30W-DA | 30W         | Ø110x269.8  | 2900lm                           | 1.25        | 6PCS     |
| TL90B-125-40W-DA | 40W         | Ø125x287.4  | 3800lm                           | 1.56        | 6PCS     |

CCT — 2700K — 3000K — 4000K — Finish — White Black Silver

# INTERCHANGEABLE REFLECTOR AND DIFFUSER

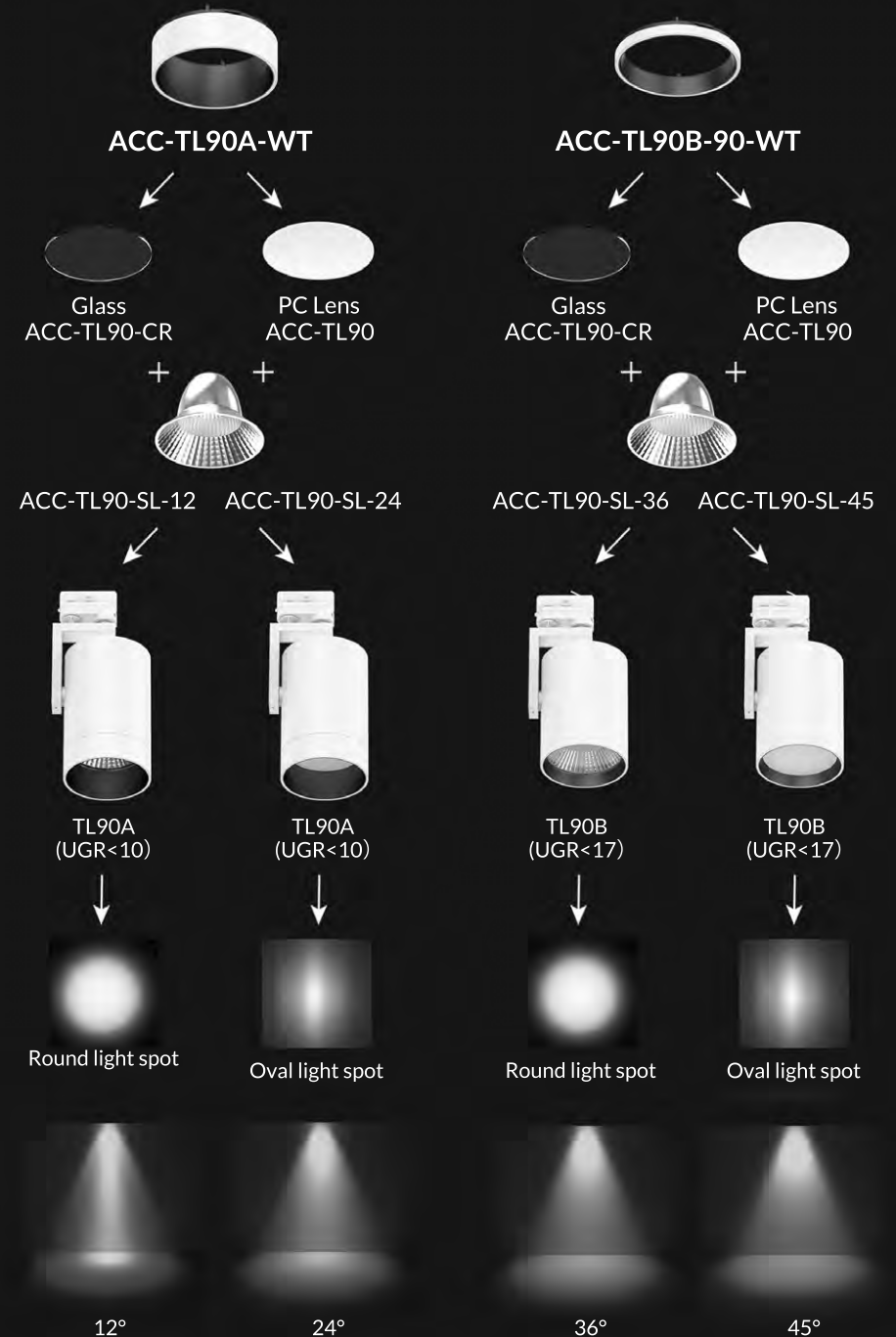

LED Track light



# TL69A Track light

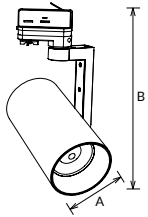

TL69 series track light with focus adjustable design, special lens can have a fast beam angle change (Just press the lens). Adopt high lumen Citizen light source, two bracket design options, changeable lighting orientation with 350° in horizontal direction and 300° in vertical direction.

Materials of Housing : PC/Aluminium  
Materials of Optics : PMMA

- ▶ 20° 24° 36° 350° 300° IP20
- ▶ DIM Flicker Free
- ▶ AC 200-240V PF≥0.9 CRI≥80 CRI≥90 CRI≥97
- ▶ SAA RoHS CE

| Code      | Watt | Size(AxBmm) | Lumen(±5%) | N.W/pc(kgs) | Q'ty/CTN |
|-----------|------|-------------|------------|-------------|----------|
| TL69A-25W | 25W  | Ø96x298     | 2950lm     | 1.20        | 12PCS    |
| TL69A-35W | 35W  | Ø96x298     | 3950lm     | 1.20        | 12PCS    |

# TL69B Track light

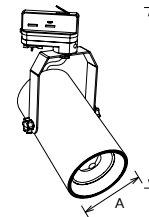

TL69B track light is with special design with lens changeable 36°~60°by press . Adopt high lumen Citizen light source effected 115lm/w. Black and white finish color for option.

Materials of Housing : PC/Aluminium  
Materials of Optics : PMMA

- ▶ 36° 45° 60° 350° 300° IP20
- ▶ DIM Flicker Free
- ▶ AC 200-240V PF≥0.9 CRI≥80 CRI≥90 CRI≥97
- ▶ SAA RoHS CE

| Code      | Watt | Size(AxBmm) | Lumen(±5%) | N.W/pc(kgs) | Q'ty/CTN |
|-----------|------|-------------|------------|-------------|----------|
| TL69B-25W | 25W  | Ø96x298     | 2950lm     | 1.20        | 12PCS    |
| TL69B-35W | 35W  | Ø96x298     | 3950lm     | 1.20        | 12PCS    |

CCT — 2700K 3000K 4000K

Finish — White Black

CCT — 2700K 3000K 4000K

Finish — White Black



## TL57A Track light

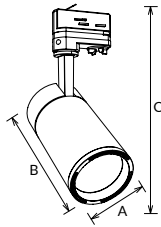

TL57A led track light with built-in driver, it adopts brand Citizen COB chip. Secondary optics with lens and reflector make more uniform light.

Materials of Housing : Aluminium

Materials of Optics : PC

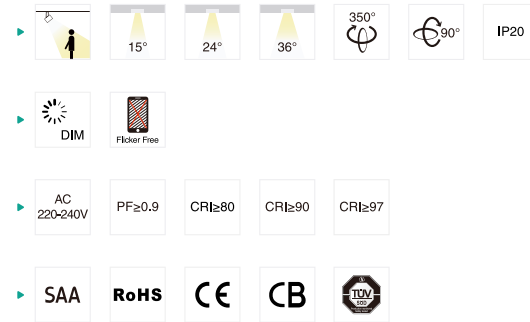

| Code        | Watt | Size(AxBxCmm) | Lumen(±5%) | N.W/pc(kgs) | Q'ty/CTN |
|-------------|------|---------------|------------|-------------|----------|
| TL57A-10W-D | 10W  | Ø65x127x223   | 1050lm     | 0.51        | 12PCS    |
| TL57A-25W-D | 25W  | Ø80x157x254   | 2500lm     | 0.81        | 12PCS    |
| TL57A-35W-D | 35W  | Ø100x167x259  | 3450lm     | 1.03        | 12PCS    |
| TL57A-15W   | 15W  | Ø65x127x223   | 1600lm     | 0.51        | 12PCS    |
| TL57A-25W   | 25W  | Ø80x157x254   | 2700lm     | 0.81        | 12PCS    |
| TL57A-35W   | 35W  | Ø100x167x259  | 3800lm     | 1.03        | 12PCS    |

CCT — 2700K — 3000K — 4000K — Finish — White — Black — Silver



## TL58A Track light

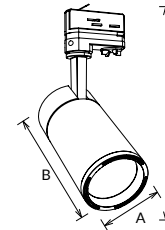

TL58A LED track light with internal driver adopts CITIZEN chips with high quality LED source, CRI80/90/97 optional. Secondary optics with lens make more uniform light.

Materials of Housing : Aluminium

Materials of Optics : PC

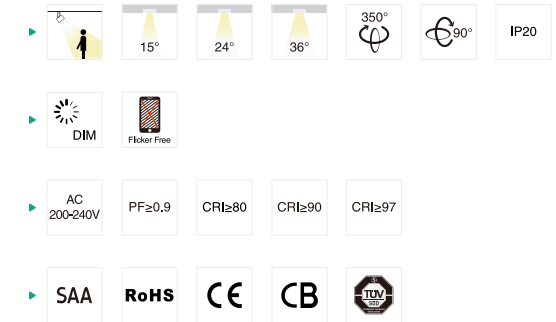

| Code      | Watt | Size(AxBxCmm) | Lumen(±5%) | N.W/pc(kgs) | Q'ty/CTN |
|-----------|------|---------------|------------|-------------|----------|
| TL58A-15W | 15W  | Ø65x131x 227  | 1650lm     | 0.52        | 12PCS    |
| TL58A-25W | 25W  | Ø80x152.5x249 | 2750lm     | 0.82        | 12PCS    |
| TL58A-35W | 35W  | Ø100x167x259  | 3850lm     | 1.10        | 12PCS    |

CCT — 2700K — 3000K — 4000K — Finish — White — Black — Silver





# TL02 Track light

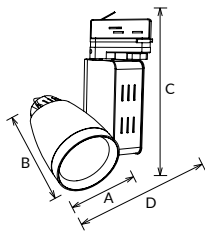

TL02 LED track light with internal driver adopts CREE/ CITIZEN branded chips, providing adjustable lighting orientation with 360 degree in horizontal direction and 180 in vertical direction.

Materials of Housing : Die-casting Aluminium  
Materials of Optics : PC

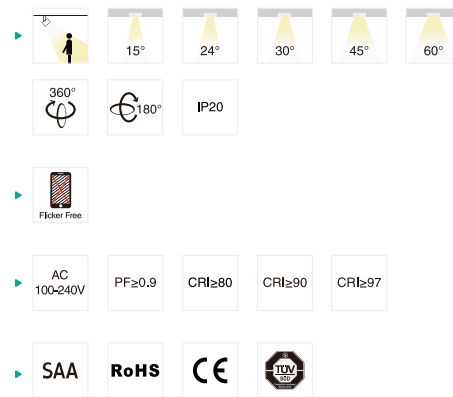

| Code     | Watt | Size(AxBxCxDmm)   | Lumen(±5%) | N.W/pc(kgs) | Q'ty/CTN |
|----------|------|-------------------|------------|-------------|----------|
| TL02-12W | 12W  | Ø75x104x220x126.5 | 1380lm     | 0.70        | 12PCS    |
| TL02-25W | 25W  | Ø90x121x233x141   | 2500lm     | 1.17        | 12PCS    |
| TL02-35W | 35W  | Ø110x131x234x161  | 3600lm     | 1.30        | 8PCS     |
| TL02-45W | 45W  | Ø110x131x234x161  | 4380lm     | 1.30        | 8PCS     |

CCT — 2700K — 3000K — 4000K — Finish — White — Black — Silver

# TL127 Track light

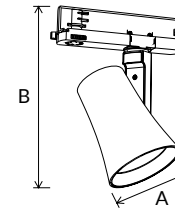

TL127 track light using high-lumen COB chip, the design presents a contrast and harmonious appearance, multi-beam Angle reflector, modular design, easy to replace. Track installation, suitable for clothing stores, hotels, exhibition rooms and other indoor commercial lighting.

Materials of Housing : Aluminium  
Materials of Optics : Aluminium

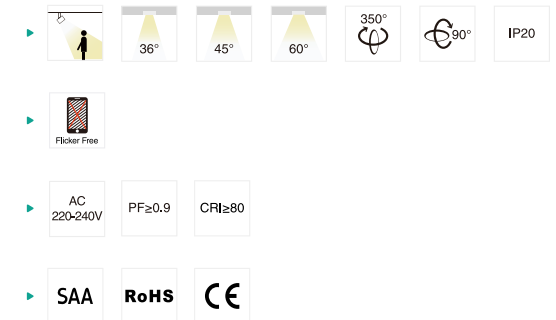

| Code         | Watt | Size(AxBmm) | Lumen(±5%) | N.W/pc(kgs) | Q'ty/CTN |
|--------------|------|-------------|------------|-------------|----------|
| TL127-86-16W | 16W  | Ø86x198     | 2200lm     | 0.44        | 12PCS    |
| TL127-86-25W | 25W  | Ø86x198     | 3300lm     | 0.44        | 12PCS    |
| TL127-97-25W | 25W  | Ø97x210     | 3300lm     | 0.56        | 12PCS    |
| TL127-97-35W | 35W  | Ø97x210     | 4400lm     | 0.56        | 12PCS    |

CCT — 2700K — 3000K — 4000K — Finish — White — Black — Nickel

LED Track light



## TL25 Track light

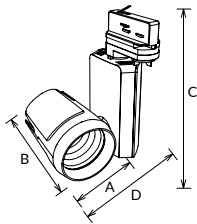

TL25 LED track light with dimming button on the bottom of the track light adopts CITIZEN LED, adjustable lighting orientation with 360 degree in horizontal direction and 180 in vertical direction, 1-circuit adapter, 3-circuit adapter available for wide choice.

Materials of Housing : Aluminium

Materials of Optics : PC

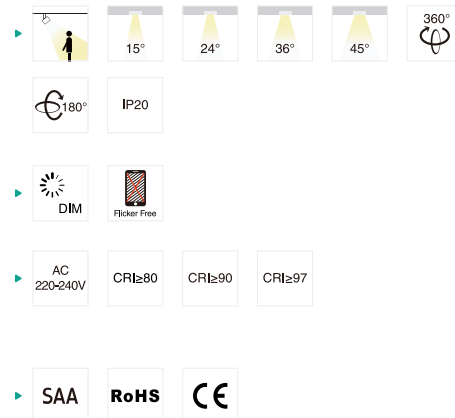

| Code     | Watt | Size(AxBxCxDmm)   | Lumen(±5%) | N.W/pc(kgs) | Q'ty/CTN |
|----------|------|-------------------|------------|-------------|----------|
| TL25-15W | 15W  | Ø68x83x170x102    | 1470lm     | 0.38        | 18PCS    |
| TL25-25W | 25W  | Ø90x118.5x215x146 | 2600lm     | 0.68        | 12PCS    |
| TL25-35W | 35W  | Ø105x128x215x161  | 3600lm     | 0.85        | 12PCS    |
| TL25-45W | 45W  | Ø105x128x215x161  | 4410lm     | 0.85        | 12PCS    |

CCT ——— 2700K ——— 3000K ——— 4000K

Finish ——— White ——— Black

Dimming button (100% down to 5%)



## TL25B Track light

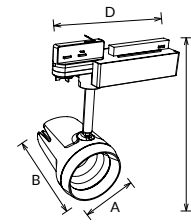

TL25B LED track light adopts CITIZEN LED, adjustable lighting orientation with 360 degree in horizontal direction and 180 in vertical direction and 1-circuit adapter, 3-circuit adapter available for wide choice.

Materials of Housing : Aluminium

Materials of Optics : PC

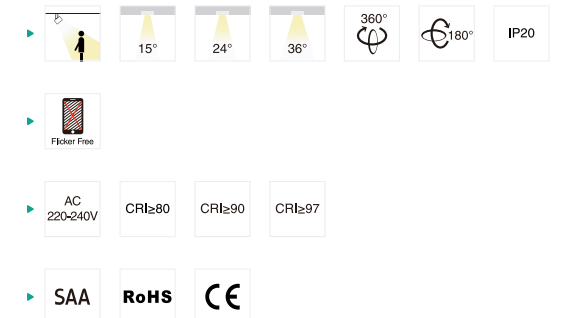

| Code      | Watt | Size(AxBxCxDmm)  | Lumen(±5%) | N.W/pc(kgs) | Q'ty/CTN |
|-----------|------|------------------|------------|-------------|----------|
| TL25B-25W | 25W  | Ø90x118x247x207  | 2600lm     | 0.75        | 12PCS    |
| TL25B-35W | 35W  | Ø105x128x262x207 | 3600lm     | 0.92        | 12PCS    |
| TL25B-45W | 45W  | Ø105x128x262x207 | 4410lm     | 0.92        | 12PCS    |

CCT ——— 2700K ——— 3000K ——— 4000K

Finish ——— White ——— Black ——— Silver

LED Track light



# TL129 Track light

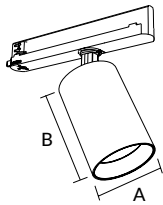

TL129 led track light is modular design with high lumen COB led, CRI80 and CRI90 both available, low glare with UGR<19, reflector is replaceable with various beam angle 24°/36°/50°, CCT interchangeable, triac dim and dali dim both available.

Materials of Housing : Aluminium  
Materials of Optics : PC/Aluminium

- ▶
- ▶
- ▶
- ▶
- ▶

| Code           | Watt | Size(AxBmm) | Lumen(±5%) | N.W/pc(kgs) | Q'ty/CTN |
|----------------|------|-------------|------------|-------------|----------|
| TL129-65-10W   | 10W  | Ø65x96      | 1250lm     | 0.39        | 24PCS    |
| TL129-65-15W   | 15W  | Ø65x96      | 1700lm     | 0.39        | 24PCS    |
| TL129-85-20W   | 20W  | Ø85x130     | 2300lm     | 0.72        | 12PCS    |
| TL129-85-25W   | 25W  | Ø85x130     | 2850lm     | 0.72        | 12PCS    |
| TL129-85-27W-D | 27W  | Ø85x130     | 3100lm     | 0.74        | 12PCS    |
| TL129-85-28W   | 28W  | Ø85x130     | 3300lm     | 0.72        | 12PCS    |

CCT — 2700K — 3000K — 4000K

Finish — White — Black



Lighting source interchangeable

Reflector interchangeable

Honeycomb optional

# MODULAR Design

LED Track light



# TL120 Track light

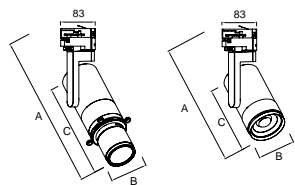

TL120 is a track spotlight with versatility and a high degree of flexibility in terms of combination, adopts high CRI COB light source. It can be horizontally rotated up to 350 degrees and vertically tilted up to 180 degrees, allowing for versatile lighting angles and directions, CCT Interchangeable is available. TL120A is dry damping design, TL120B adopt stepless zooming technology.

Materials of Housing : Die-casting Aluminium

Materials of Optics : Glass (TL120A)/ PC(TL120B)

- ▶ 35° 20°-60° 350° 180° IP20
- ▶ UGR<19
- ▶ DIM Flicker Free SIDE SWITCH
- ▶ AC 220-240V PF≥0.9 CRI≥80
- ▶ SAA RoHS CE

| Code            | Watt | Size(AxBxCmm) | Lumen(±5%) | N.W/pc(kgs) | Q'ty/CTN |
|-----------------|------|---------------|------------|-------------|----------|
| TL120A-32W-P2/D | 32W  | 360x88.9x267  | 750lm      | 1.86        | 6PCS     |
| TL120B-32W-P2/D | 32W  | 263x92x170    | 3250lm     | 1.19        | 6PCS     |

CCT ——— 2700K ——— 3000K ——— 4000K

Finish ——— White Black

# DIY MODULE



## TL120A

Optical-grade variable aperture design



Multi-layer dry damping design



Color



Projection

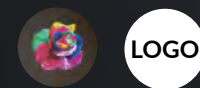

## TL120B

ZOOM lens



Four-blade baffle



Stretch optics



360° manual rotation design





# TL135 Track light

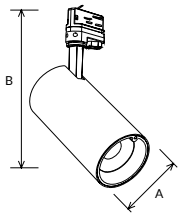

TL135 track light, intelligent induction color change design. It can automatically adjust the color temperature according to the environmental color change, changing the color according to the need to achieve a variety of decorative effects. Very suitable for home, office, exhibition, display etc

Materials of Housing : Aluminium

Materials of Optics : PC

- ▶ 38° 350° 90° IP20
- ▶ Flicker Free
- ▶ AC 110-240V PF≥0.9 CRI≥95
- ▶ SAA RoHS CE

| Code      | Watt | Size(AxBmm) | Lumen(±5%) | N.W/pc(kgs) | Q'ty/CTN |
|-----------|------|-------------|------------|-------------|----------|
| TL135-33W | 33W  | Ø100x294    | 1800lm     | 1.24        | 6PCS     |

CCT ——— 2700K ——— 3000K ——— 5100K

Finish ——— Black



**TL135**

2700K-5100K

**Colour-Sensor**

LED Track light

4000K Ra95

TL135

SUNLIGHT

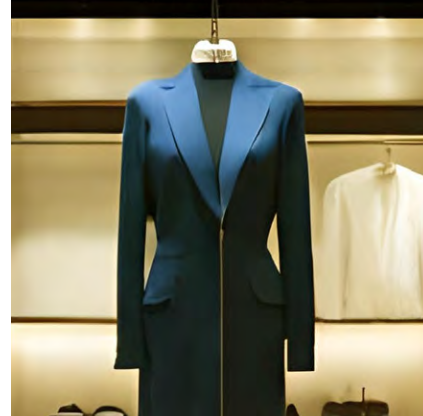



# TL56 Track light

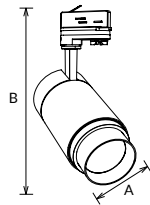

TL56 track light with simple and elegant design. One track light with adjustable beam angle varies from 15° to 60°, creating a diversified and dramatic atmosphere. Lens optical design with even light output. Changeable lighting orientation with 350° in horizontal direction and 90° in vertical direction. Single CCT and interchangeable CCT available.

Materials of Housing : Aluminium

Materials of Optics : PC

- ▶ 15°-60°
- ▶ 350°
- ▶ 90°
- ▶ IP20
- ▶ DIM
- ▶ Flicker Free
- ▶ SLIDE SWITCH
- ▶ Bluetooth
- ▶ CASAMBI
- ▶ AC 220-240V
- ▶ PF≥0.9
- ▶ CRI≥80
- ▶ CRI≥90
- ▶ CRI≥97
- ▶ SAA
- ▶ RoHS
- ▶ CE
- ▶ CB
- ▶ TUV

| Code                   | Watt | Size(AxBxCmm) | Lumen(±5%) | N.W/pc(kgs) | Q'ty/CTN |
|------------------------|------|---------------|------------|-------------|----------|
| TL56-10W-D             | 10W  | Ø65x234       | 960lm      | 0.69        | 12PCS    |
| TL56-25W-D             | 25W  | Ø80x260       | 2500lm     | 0.91        | 12PCS    |
| TL56-30W-D             | 30W  | Ø100x260      | 2800lm     | 1.29        | 12PCS    |
| TL56-15W               | 15W  | Ø65x234       | 1500lm     | 0.69        | 12PCS    |
| TL56-25W               | 25W  | Ø80x260       | 2500lm     | 0.91        | 12PCS    |
| TL56-30W               | 30W  | Ø100x265      | 3000lm     | 1.29        | 12PCS    |
| TL56-25W-C3 <b>NEW</b> | 25W  | Ø80x260       | 2250lm     | 0.91        | 12PCS    |
| TL56-30W-C3 <b>NEW</b> | 30W  | Ø100x260      | 2750lm     | 1.29        | 12PCS    |

CCT — 2700K — 3000K — 4000K

Finish — White — Black

# TL17 Track light

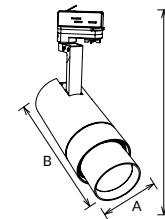

TL17 LED tracklight ,using advancing zooming technology, have a flexible beam angle from 10° to 60°. Flicker free LED driver. Dimmable for option.

Materials of Housing : Aluminium

Materials of Optics : PC

- ▶ 10°-60°
- ▶ 320°
- ▶ 90°
- ▶ IP20
- ▶ DIM
- ▶ Flicker Free
- ▶ AC 200-240V
- ▶ PF≥0.9
- ▶ CRI≥80
- ▶ CRI≥90
- ▶ CRI≥97
- ▶ SAA
- ▶ RoHS
- ▶ CE

| Code     | Watt | Size(AxBxCmm) | Lumen(±5%)  | N.W/pc(kgs) | Q'ty/CTN |
|----------|------|---------------|-------------|-------------|----------|
| TL17-35W | 35W  | Ø100x207x301  | 1790~3720lm | 1.53        | 6PCS     |

CCT — 2700K — 3000K — 4000K

Finish — White — Black — Silver

Adjustable beam angle from 24°~60°



# TL149 NEW Track light

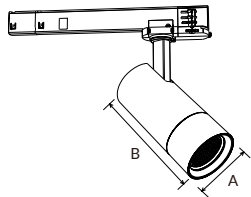

TL149 Track light is lens and honeycomb louver design, adjustable lighting orientation with horizontal 350° and vertically 90° and adjustable beam angle from 24°~60°, CRI90, 3CCT, adjustable power, triac and DALI dimmable function available.

- ▶ 24°~60° 30°~60° 350° 90° IP20
- ▶ DIM Flicker Free SILENT SWITCH 3 in 1 Adjustable Power
- ▶ AC 220-240V PF≥0.9 CRI≥90
- ▶ SAA RoHS CE

Materials of Housing : Aluminium

Materials of Optics : PC

| Code            | Watt        | Size(AxBxCmm) | Lumen(±5%) | N.W/pc(kgs) | Q'ty/CTN |
|-----------------|-------------|---------------|------------|-------------|----------|
| TL149-65-20W-A3 | 10W/15W/20W | Ø65x145       | 1600lm     | 1.40        | 12PCS    |
| TL149-80-35W-A3 | 25W/30W/35W | Ø80x171       | 2800lm     | 1.60        | 12PCS    |

CCT ——— 2700K ——— 3000K ——— 4000K

Finish ——— White Black

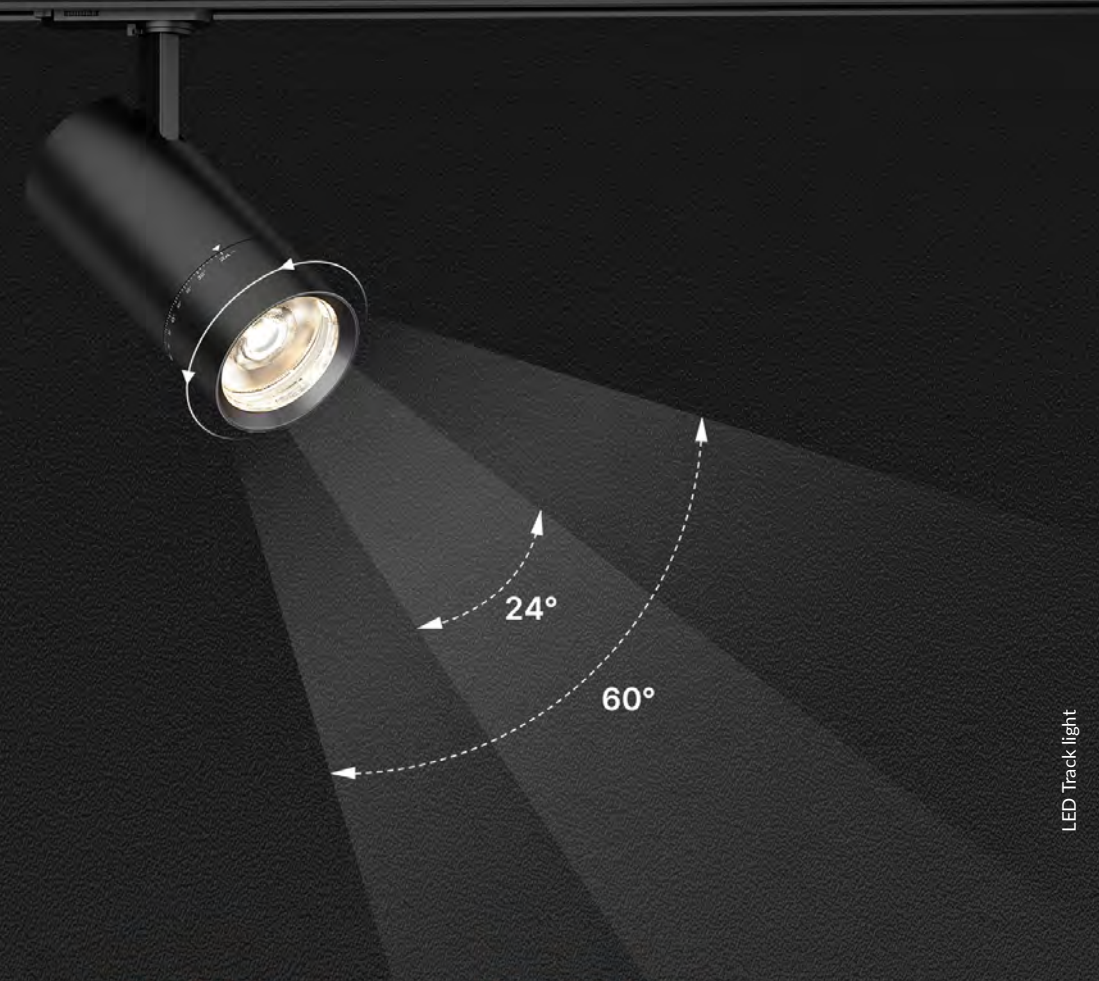

24~60° effect



## TL79 Track light

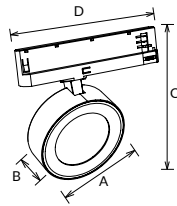

TL79 track light is an integrated design with internal driver and 3 circuit adapter. It is with interchangeable lens 15°/24°/36°/60° and Replaceable rings Black/White/Gold/Silver.

Materials of Housing : PC/Aluminium

Materials of Optics : PMMA

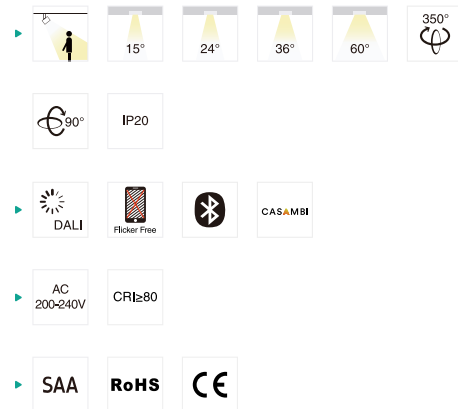

| Code        | Watt | Size(AxBxCxDmm) | Lumen(±5%) | N.W/pc(kgs) | Q'ty/CTN |
|-------------|------|-----------------|------------|-------------|----------|
| TL79-10W    | 10W  | Ø90x43x146x196  | 1250lm     | 0.44        | 12PCS    |
| TL79-18W    | 18W  | Ø90x43x146x196  | 2150lm     | 0.44        | 12PCS    |
| TL79-25W    | 25W  | Ø120x43x178x207 | 2950lm     | 0.61        | 12PCS    |
| TL79-30W    | 30W  | Ø120x43x178x207 | 3350lm     | 0.61        | 12PCS    |
| TL79-13W-DA | 13W  | Ø90x43x146x265  | 1600lm     | 0.52        | 12PCS    |
| TL79-20W-DA | 20W  | Ø90x43x146x265  | 2300lm     | 0.52        | 12PCS    |
| TL79-25W-DA | 25W  | Ø120x43x176x260 | 2650lm     | 0.65        | 12PCS    |
| TL79-30W-DA | 30W  | Ø120x43x178x260 | 3200lm     | 0.65        | 12PCS    |

CCT — 2700K — 3000K — 4000K — Trim — White — Black — Silver — Golden

## TL40B Track light

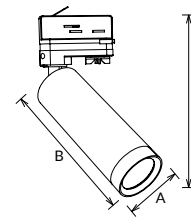

TL40B led track light adopts Citizen chip which can create a diversified and dramatic atmosphere. Adjustable lighting orientation with 350° in horizontal direction and 90° in vertical direction will bring a flexible exposure. 1-circuit and 3-circuit are all available.

Materials of Housing : Aluminium

Materials of Optics : PC

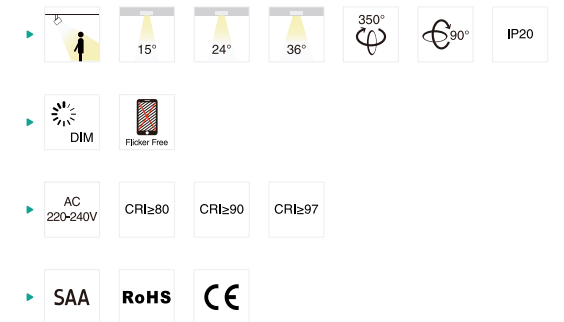

| Code      | Watt | Size(AxBxCmm) | Lumen(±5%) | N.W/pc(kgs) | Q'ty/CTN |
|-----------|------|---------------|------------|-------------|----------|
| TL40B-10W | 10W  | Ø54x162x236   | 1000lm     | 0.45        | 24PCS    |
| TL40B-12W | 12W  | Ø54x162x236   | 1200lm     | 0.45        | 24PCS    |

CCT — 2700K — 3000K — 4000K — Finish — White — Black — Silver

LED Track light



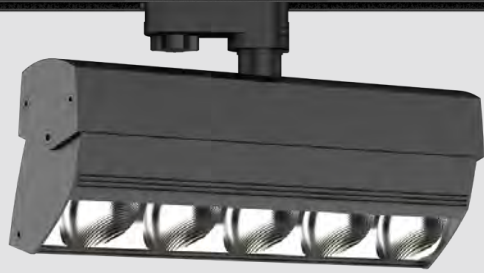

# TL121 Track light

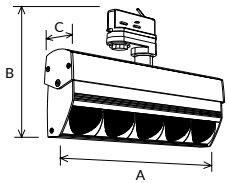

TL121 Track light is adjustable design with horizontal rotation 355°, vertical rotation 18°. The polarized track avoids direct light from the light source and reduces the luminous area perceived by the outside world. The relatively small size can wash very wide shelves, with uniform illumination and wide irradiation range.

Materials of Housing : Aluminium

Materials of Optics : PC

- ▶ 20° 355° 18° IP20
- ▶ DIM DALI Flicker Free
- ▶ AC 200-240V PF≥0.9 CRI≥80 CRI≥90
- ▶ SAA RoHS CE

| Code      | Watt | Size(AxBxCmm) | Lumen(±5%) | N.W/pc(kgs) | Q'ty/CTN |
|-----------|------|---------------|------------|-------------|----------|
| TL121-35W | 35W  | 310x118x50    | 3850lm     | 1.26        | 6PCS     |
| TL121-40W | 40W  | 310x118x50    | 4400lm     | 1.26        | 6PCS     |

CCT ——— 2700K ——— 3000K ——— 4000K

Finish ——— White Black





# TL49 Track light

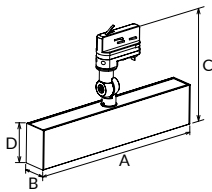

TL49 LED linear track light with louver reflector design. It's widely used as additional lighting compared with traditional spot track light. Adopt 2835SMD chip, louver reflector make it anti-glare, Adjustable lighting orientation with 350° in horizontal direction and 220° in vertical direction.

Materials of Housing : Aluminium

Materials of Optics : PC+ABS

- ▶ 60° 350° 220°
- ▶ IP20 UGR<19
- ▶ Flicker Free
- ▶ AC 220-240V PF≥0.9 CRI≥80
- ▶ SAA RoHS CE

| Code     | Watt | Size(AxBxCxDmm)   | Lumen(±5%) | N.W/pc(kgs) | Q'ty/CTN |
|----------|------|-------------------|------------|-------------|----------|
| TL49-15W | 15W  | 319.5x42x195.5x70 | 1400lm     | 0.74        | 12PCS    |
| TL49-30W | 30W  | 424.5x42x195.5x70 | 2750lm     | 0.92        | 12PCS    |
| TL49-37W | 37W  | 529.5x42x195.5x70 | 3400lm     | 1.15        | 12PCS    |
| TL49-45W | 45W  | 529.5x42x195.5x70 | 3850lm     | 1.15        | 12PCS    |

CCT — 3000K 4000K 5700K Finish — White Black Silver

# TL110 Track light

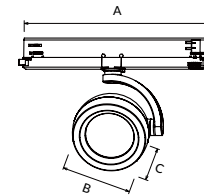

TL110 is a compact and exquisite track light. It adopts high lumen branded COB light source, special texture designed lens lowered glare to create a comfortable visual experience. Horizontally and vertically 350 degree rotation can be freely adjusted.

Materials of Housing : Aluminium

Materials of Optics : PMMA

- ▶ 20° 30° 45° 60° 350°
- ▶ 350° IP20
- ▶ Flicker Free
- ▶ AC 220-240V PF≥0.9 CRI≥80
- ▶ SAA RoHS CE

| Code      | Watt | Size(AxBxCmm) | Lumen(±5%) | N.W/pc(kgs) | Q'ty/CTN |
|-----------|------|---------------|------------|-------------|----------|
| TL110-20W | 20W  | 158x108x74    | 2350lm     | 0.63        | 12PCS    |
| TL110-30W | 30W  | 250x108x74    | 3400lm     | 0.67        | 12PCS    |

CCT — 2700K 3000K 4000K Finish — White Black Silver

# TL151A <sup>NEW</sup> Track light

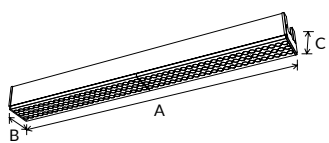

TL151A is linear track light with SMD design, lens design with symmetric beam and asymmetric beam. High lumen efficiency up to 180lm/W. It is integral driver design. Splicing is available.

Materials of Housing : Aluminium  
Materials of Optics : PC

- ▶
- ▶
- ▶
- ▶
- ▶

| Code                | Watt             | Size(AxBmm)      | Lumen(±5%) | N.W/pc(kgs) | Q'ty/CTN |
|---------------------|------------------|------------------|------------|-------------|----------|
| TL151A-600-30W-A4   | 20W/22W/26W/30W  | 605.8x79.5x61.5  | 5400lm     | 0.98        | 6PCS     |
| TL151A-1200-60W-A4  | 39W/46W/53W/60W  | 1205.8x79.5x61.5 | 11000lm    | 1.95        | 4PCS     |
| TL151A-1500-75W-A4  | 51W/59W/67W/75W  | 1505.8x79.5x61.5 | 13600lm    | 2.25        | 2PCS     |
| TL151A-1500-100W-A4 | 70W/80W/90W/100W | 1505.8x79.5x61.5 | 17500lm    | 2.25        | 2PCS     |

# TL151B <sup>NEW</sup> Track light

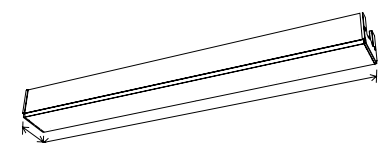

TL151B linear track light is SMD design, opal diffuser with symmetric beam. High lumen efficiency up to 180lm/W. It is integral driver design. Splicing is available.

Materials of Housing : Aluminium  
Materials of Optics : PC

- ▶
- ▶
- ▶
- ▶
- ▶

| Code                | Watt             | Size(AxBmm)  | Lumen(±5%) | N.W/pc(kgs) | Q'ty/CTN |
|---------------------|------------------|--------------|------------|-------------|----------|
| TL151B-600-30W-A4   | 20W/22W/26W/30W  | 605.4x78x75  | 5050lm     | 0.94        | 6PCS     |
| TL151B-1200-60W-A4  | 39W/46W/53W/60W  | 1205.4x78x75 | 10900lm    | 1.95        | 4PCS     |
| TL151B-1500-75W-A4  | 51W/59W/67W/75W  | 1505.4x78x75 | 13100lm    | 2.25        | 2PCS     |
| TL151B-1500-100W-A4 | 70W/80W/90W/100W | 1505.4x78x75 | 17400lm    | 2.25        | 2PCS     |

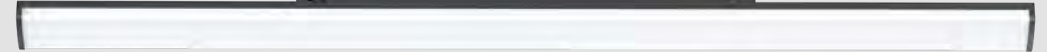

# TL161A <sup>NEW</sup> Track light

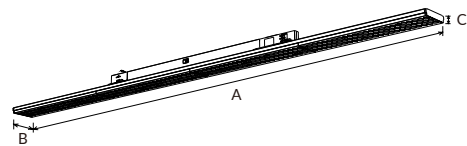

TL161A Track light is a new type of super slim high-efficiency linear track light. Type A applies a high-transmission PC optical lens, 30°/60°/90°/30°x90°/double asymmetric 20° to have various lighting distribution. Type B adopts opal cover for uniform illumination. All of which support DIP switch power adjustment. It also can be flexibly combined with track spotlights on the same track rail for general lighting & accent lighting. Applicable for retrofit and new mounting with EU standard track system.

Materials of Housing : Aluminium

Materials of Optics : PC

- ▶ 30° 60° 90° 30°x90° 20°
- ▶ 120° IP20 IP50
- ▶ DALI Flicker Free
- ▶ AC 220-240V PF≥0.9 CRI≥80
- ▶ SAA RoHS CE

| Code            | Watt | Size(AxBxCmm)    | Lumen(±5%) | N.W/pc(kgs) | Q'ty/CTN |
|-----------------|------|------------------|------------|-------------|----------|
| TL161A-600-30W  | 30W  | 606.2x65.9x62.4  | 5400lm     | 0.85        | 12PCS    |
| TL161A-1200-60W | 60W  | 1206.2x65.9x62.4 | 11100lm    | 1.42        | 6PCS     |
| TL161A-1500-75W | 75W  | 1506.2x65.9x62.4 | 13600lm    | 1.69        | 6PCS     |

CCT — 2700K 3000K 4000K

Finish — White Black

# TL161B <sup>NEW</sup> Track light

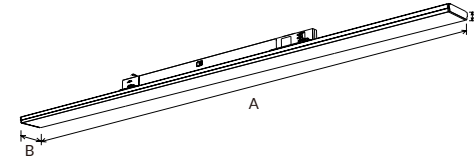

TL161B Track light is a new type of super slim high-efficiency linear track light. Type A applies a high-transmission PC optical lens, 30°/60°/90°/30°x90°/double asymmetric 20° to have various lighting distribution. Type B adopts opal cover for uniform illumination. All of which support DIP switch power adjustment. It also can be flexibly combined with track spotlights on the same track rail for general lighting & accent lighting. Applicable for retrofit and new mounting with EU standard track system.

Materials of Housing : Aluminium

Materials of Optics : PC

- ▶ 30° 60° 90° 30°x90° 20°
- ▶ 120° IP20 IP50
- ▶ DALI Flicker Free
- ▶ AC 220-240V PF≥0.9 CRI≥80
- ▶ SAA RoHS CE

| Code            | Watt | Size(AxBxCmm)    | Lumen(±5%) | N.W/pc(kgs) | Q'ty/CTN |
|-----------------|------|------------------|------------|-------------|----------|
| TL161B-600-30W  | 30W  | 607.4x65.9x75.4  | 5100lm     | 0.70        | 12PCS    |
| TL161B-1200-60W | 60W  | 1207.4x65.9x75.4 | 10900lm    | 1.20        | 6PCS     |
| TL161B-1500-75W | 75W  | 1507.4x65.9x75.4 | 13100lm    | 1.45        | 6PCS     |

CCT — 2700K 3000K 4000K

Finish — White Black



# TL50/B Track light

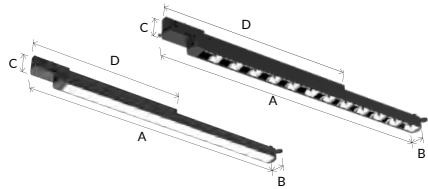

TL50 LED linear track light is a concise design with internal flicker free led driver. Adopting high lumen efficiency SMD LED. Interchangeable CCT with slide switch is available.

Materials of Housing : Aluminium  
Materials of Optics : PC

- ▶ 110° IP20
- ▶ Flicker Free SLIDE SWITCH
- ▶ AC 220-240V PF≥0.9 CRI≥80
- ▶ SAA RoHS CE

| Code       | Watt | Size(AxBxCxDmm)  | Lumen(±5%) | N.W/pc(kgs) | Q'ty/CTN |
|------------|------|------------------|------------|-------------|----------|
| TL50/B-10W | 10W  | 650x32.5x52x436  | 1000lm     | 0.43        | 12PCS    |
| TL50/B-16W | 16W  | 650x32.5x52x436  | 1560lm     | 0.45        | 12PCS    |
| TL50/B-25W | 25W  | 1212x32.5x52x496 | 2550lm     | 0.76        | 12PCS    |
| TL50/B-30W | 30W  | 1212x32.5x52x496 | 3000lm     | 0.76        | 12PCS    |
| TL50/B-30W | 30W  | 1493x32.5x52x496 | 3000lm     | 0.92        | 12PCS    |

CCT — 3000K — 4000K — 5700K — Finish — White Black Silver

# TL109 Track light

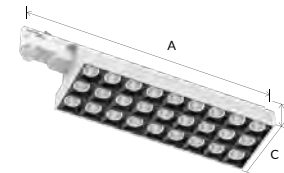

TL109 track light with both high lumen efficiency and low UGR. It adopts super high lumen SMD light source, combine with honeycomb optic reflector to reach a low UGR<19. Standard European 3 circuits track and multiple beam angles for options.

Materials of Housing : Aluminium  
Materials of Optics : PC

- ▶ 15° 24° 36° 45° 35°x70° IP20
- ▶ Flicker Free
- ▶ AC 200-240V PF≥0.9 CRI≥80
- ▶ SAA RoHS CE

| Code      | Watt | Size(AxBxCmm) | Lumen(±5%) | N.W/pc(kgs) | Q'ty/CTN |
|-----------|------|---------------|------------|-------------|----------|
| TL109-52W | 52W  | 435x123x96    | 7000lm     | 1.62        | 6PCS     |

CCT — 3000K — 4000K — 5700K — Finish — White Black

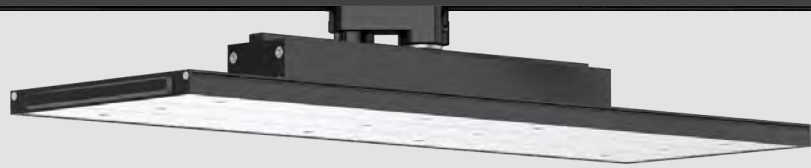

# TL111 Track light

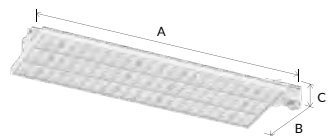

TL111 LED track light with Osram brand driver is specifically designed for supermarket aisles. Type A with an adapter at the side while type B with adapter at the back and can do 350 degree rotary. European standard three-circuit track system is suitable. High lumen efficiency 130-140lm/W is available.

Materials of Housing : Aluminium  
Materials of Optics : PMMA

- ▶
- ▶
- ▶
- ▶

| Code       | Watt | Size(AxBxCmm) | Lumen(±5%) | N.W/pc(kgs) | Q'ty/CTN |
|------------|------|---------------|------------|-------------|----------|
| TL111A-50W | 50W  | 670x190x80    | 7040lm     | 2.50        | 6PCS     |
| TL111A-60W | 60W  | 670x190x80    | 8250lm     | 2.50        | 6PCS     |
| TL111A-80W | 80W  | 670x190x80    | 10480lm    | 2.50        | 6PCS     |
| TL111B-50W | 50W  | 582x190x116   | 7040lm     | 2.50        | 6PCS     |
| TL111B-60W | 60W  | 582x190x116   | 8250lm     | 2.50        | 6PCS     |
| TL111B-80W | 80W  | 582x190x116   | 10480lm    | 2.50        | 6PCS     |

CCT — 3000K — 4000K — 5700K

Finish — White — Black

# TL112 Track light

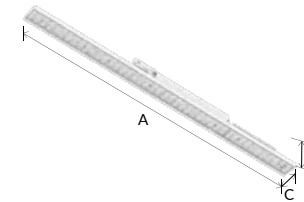

TL112 a new seamless linear track lighting system, which has thin body, light weight and compact structure, suitable for European standard three-circuit track system. Multiple PMMA lens optics 30°, 60°, 90°, double asymmetric 20° for options.

Materials of Housing : Aluminium  
Materials of Optics : PMMA

- ▶
- ▶
- ▶
- ▶

| Code      | Watt | Size(AxBxCmm) | Lumen(±5%) | N.W/pc(kgs) | Q'ty/CTN |
|-----------|------|---------------|------------|-------------|----------|
| TL112-40W | 40W  | 1152x80x85    | 5100lm     | 2.17        | 6PCS     |
| TL112-60W | 60W  | 1152x80x85    | 7150lm     | 2.17        | 6PCS     |

CCT — 3000K — 4000K — 5700K

Finish — White — Black

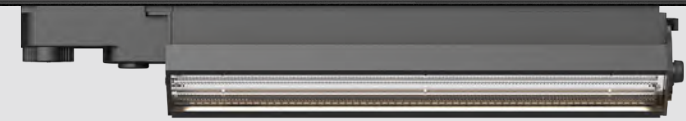

# TL113 Track light

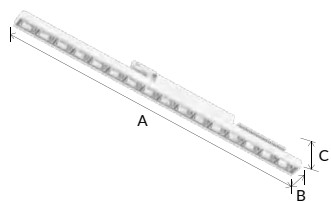

TL113 a new seamless linear track lighting system with Osram brand driver, which has thin body, light weight and compact structure, suitable for European standard three-circuit track system. Optic design combines with diffuser and reflector, which make more uniform light output.

Materials of Housing : Aluminium  
Materials of Optics : PC

- ▶ 30°x60° 60°x90° IP20
- ▶ Flicker Free
- ▶ AC 220-240V PF≥0.9 CRI≥80
- ▶ SAA RoHS CE

| Code      | Watt | Size(AxBxCmm) | Lumen(±5%) | N.W/pc(kgs) | Q'ty/CTN |
|-----------|------|---------------|------------|-------------|----------|
| TL113-47W | 47W  | 1142x60x98    | 6300lm     | 2.05        | 6PCS     |
| TL113-63W | 63W  | 1142x60x98    | 8550lm     | 2.05        | 6PCS     |

CCT — 3000K — 4000K — 5700K

Finish — White — Black

# TL114 Track light

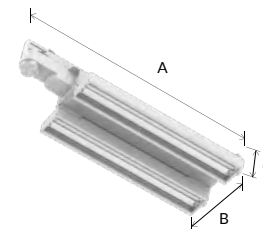

TL114 is designed specifically for supermarket aisles, shelves, corridors etc. The light source is divided into left and right parts, which can be rotated upwards by 90°. The unique structural design allows the product to fit different aisle widths and installation heights with high flexibility. A great compatibility with European standard 3-circuit track and convenient for group control.

Materials of Housing : Aluminium  
Materials of Optics : PC

- ▶ 60°x90° 90°x100° 90° IP20
- ▶ Flicker Free
- ▶ AC 220-240V PF≥0.9 CRI≥80
- ▶ SAA RoHS CE

| Code      | Watt | Size(AxBxCmm) | Lumen(±5%) | N.W/pc(kgs) | Q'ty/CTN |
|-----------|------|---------------|------------|-------------|----------|
| TL114-57W | 57W  | 416x135x60    | 7100lm     | 1.2         | 6PCS     |

CCT — 3000K — 4000K — 5700K

Finish — White — Black

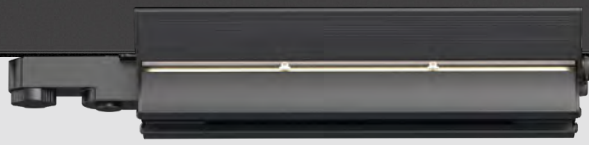

# TL115 Track light

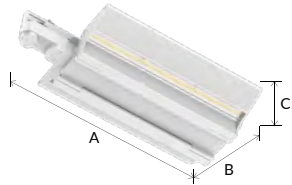

TL115 is a two-wing bionic design and has a unique rectangular light distribution that guides users eyes to the shelf. At the same time, the illumination on the ground will not be too high, which can greatly improve the utilization rate of light and reduce energy consumption. The wings can be tilted downward by 30°, which is convenient to adjust the beam angle and meet the requirements of different aisle widths and installation heights.

Materials of Housing : Aluminium  
Materials of Optics : PC

- ▶ 60°x90° 90°x100° 30° IP20
- ▶ Flicker Free
- ▶ AC 200-240V PF≥0.9 CRI≥80
- ▶ SAA RoHS CE

| Code      | Watt | Size(AxBxCmm) | Lumen(±5%) | N.W/pc(kgs) | Q'ty/CTN |
|-----------|------|---------------|------------|-------------|----------|
| TL115-57W | 57W  | 388x218x70    | 5500lm     | 1.52        | 6PCS     |

CCT ——— 3000K ——— 4000K ——— 5700K

Finish ——— White Black

# Angel's Wings

Multiple beam angle options:

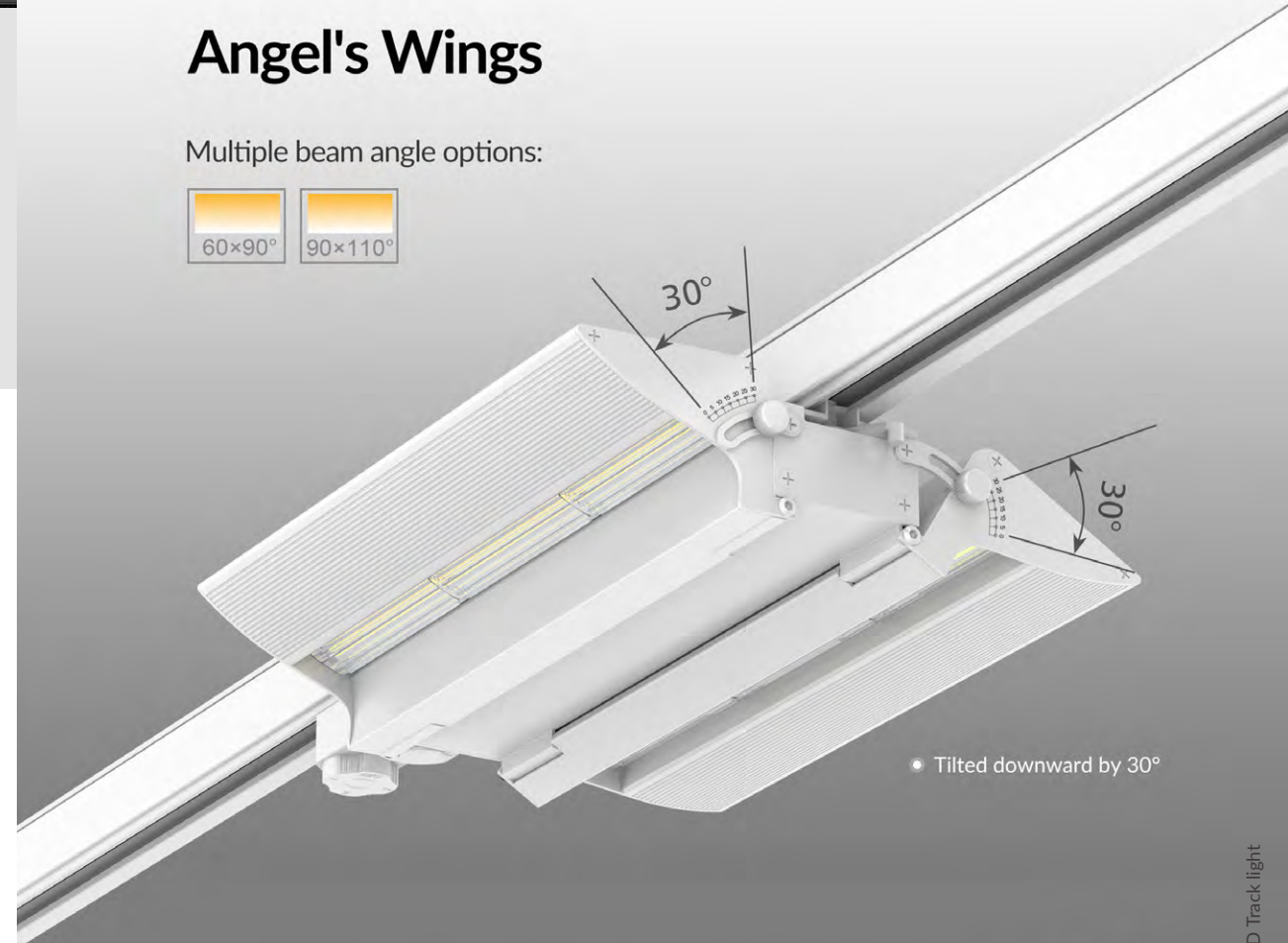

• Tilted downward by 30°

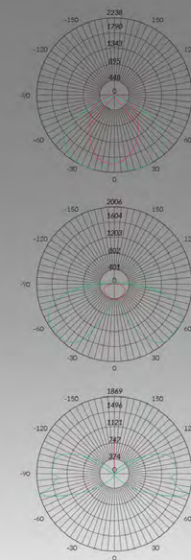

Safety lock

European 3 circuits track

LED Track light



# Track System

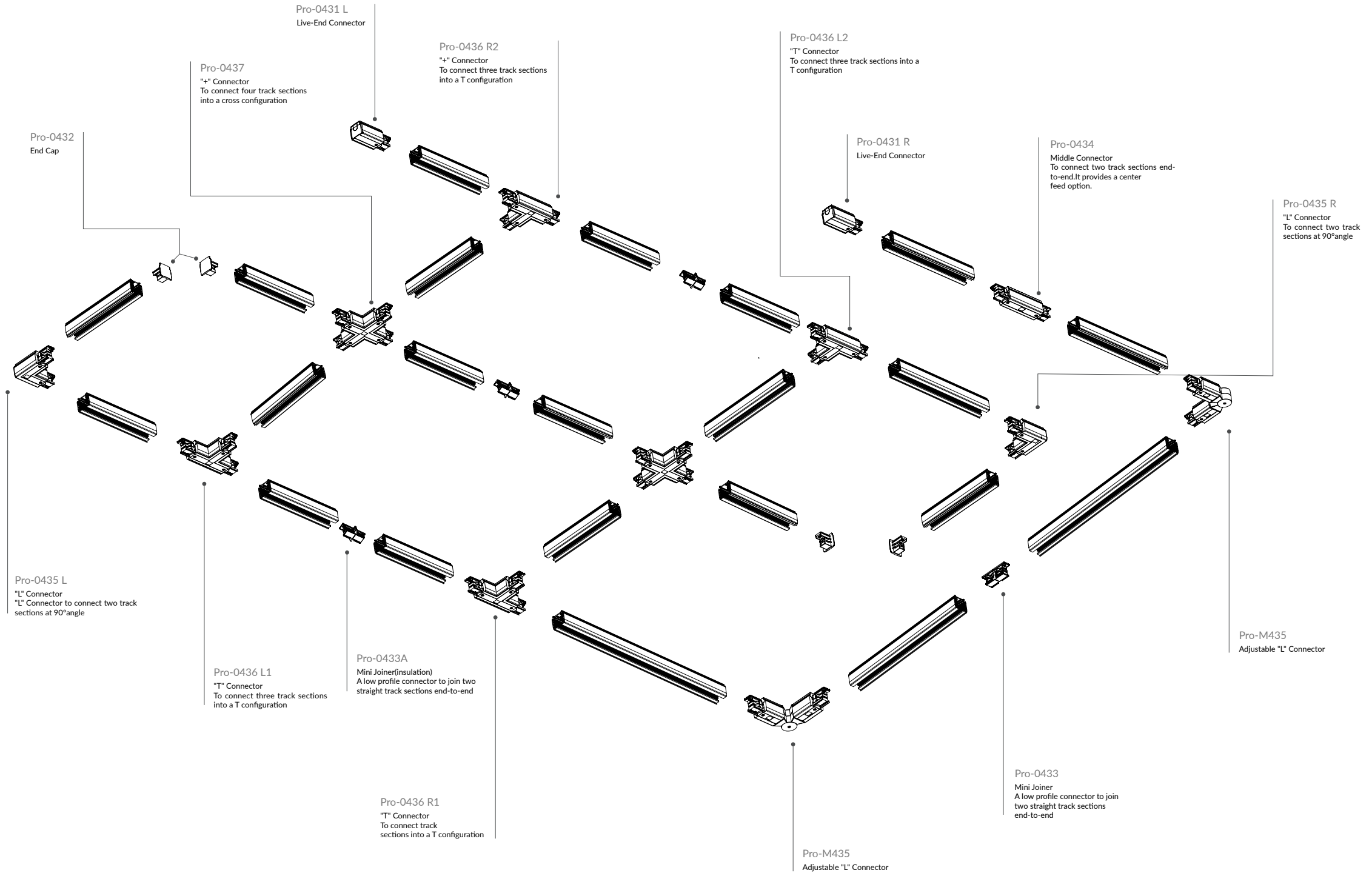

LED Track light

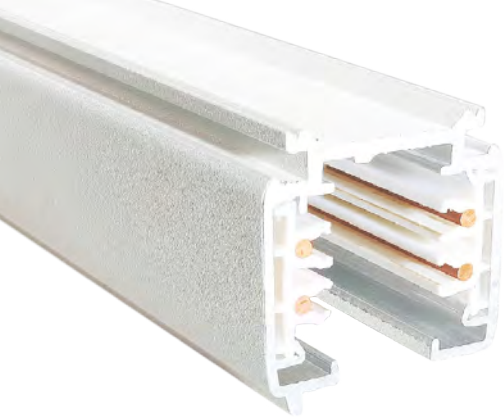

# 3 Circuits Track System

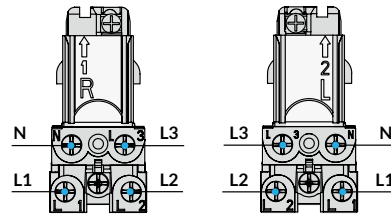
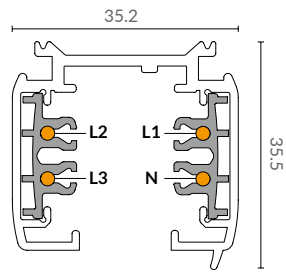

| Model No.                              | Track length                        | Shell Material      | Colour  | Package |
|--|-------------------------------------|---------------------|---|---------|
| Pro-0410-W / Pro-0410-S / Pro-0410-B   | 1M track actual one meter.(100cm)   | Aluminium Extrusion | White <input type="checkbox"/> Silver <input type="checkbox"/> Black <input type="checkbox"/> | 1 / 12  |
| Pro-0415-W / Pro-0415-S / Pro-0415-B   | 1.5M track actual one meter.(150cm) | Aluminium Extrusion | White <input type="checkbox"/> Silver <input type="checkbox"/> Black <input type="checkbox"/> | 1 / 12  |
| Pro-0420-W / Pro-0420-S / Pro-0420-B   | 2M track actual one meter.(200cm)   | Aluminium Extrusion | White <input type="checkbox"/> Silver <input type="checkbox"/> Black <input type="checkbox"/> | 1 / 12  |
| Pro-0430-W / Pro-0430-S / Pro-0430-B   | 3M track actual one meter.(300cm)   | Aluminium Extrusion | White <input type="checkbox"/> Silver <input type="checkbox"/> Black <input type="checkbox"/> | 1 / 8   |
| Pro-0440-W / Pro-04000-S / Pro-04000-B | 4M track actual one meter.(400cm)   | Aluminium Extrusion | White <input type="checkbox"/> Silver <input type="checkbox"/> Black <input type="checkbox"/> | 1 / 6   |

## Live-End Connector



| Model No.    | Package | Colour                          |
|--------------|---------|---------------------------------|
| Pro-0431 L-W | 1 / 150 | White <input type="checkbox"/>  |
| Pro-0431 L-S | 1 / 150 | Silver <input type="checkbox"/> |
| Pro-0431 L-B | 1 / 150 | Black <input type="checkbox"/>  |

## Live-End Connector

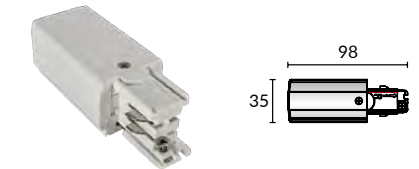

| Model No.    | Package | Colour                          |
|--------------|---------|---------------------------------|
| Pro-0431 R-W | 1 / 150 | White <input type="checkbox"/>  |
| Pro-0431 R-S | 1 / 150 | Silver <input type="checkbox"/> |
| Pro-0431 R-B | 1 / 150 | Black <input type="checkbox"/>  |

## Mini Joiner



| Model No.  | Package | Colour                          |
|------------|---------|---------------------------------|
| Pro-0433-W | 1 / 400 | White <input type="checkbox"/>  |
| Pro-0433-S | 1 / 400 | Silver <input type="checkbox"/> |
| Pro-0433-B | 1 / 400 | Black <input type="checkbox"/>  |

## Mini Joiner(Insulation)



| Model No.   | Package | Colour                          |
|-------------|---------|---------------------------------|
| Pro-0433A-W | 1 / 150 | White <input type="checkbox"/>  |
| Pro-0433A-S | 1 / 150 | Silver <input type="checkbox"/> |
| Pro-0433A-B | 1 / 150 | Black <input type="checkbox"/>  |

## End Cap



| Model No.  | Package | Colour                          |
|------------|---------|---------------------------------|
| Pro-0432-W | 1 / 500 | White <input type="checkbox"/>  |
| Pro-0432-S | 1 / 500 | Silver <input type="checkbox"/> |
| Pro-0432-B | 1 / 500 | Black <input type="checkbox"/>  |

## Mini Joiner(Insulation)

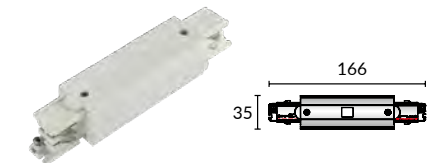

| Model No.  | Package | Colour                          |
|------------|---------|---------------------------------|
| Pro-0434-W | 1 / 150 | White <input type="checkbox"/>  |
| Pro-0434-S | 1 / 150 | Silver <input type="checkbox"/> |
| Pro-0434-B | 1 / 150 | Black <input type="checkbox"/>  |

Twisted "L" Connector



| Model No.  | Package | Colour   |
|------------|---------|----------|
| Pro-0438-W | 1 / 154 | White □  |
| Pro-0438-S | 1 / 154 | Silver ■ |
| Pro-0438-B | 1 / 154 | Black ■  |

"+" Connector



| Model No.  | Package | Colour   |
|------------|---------|----------|
| Pro-0437-W | 1 / 60  | White □  |
| Pro-0437-S | 1 / 60  | Silver ■ |
| Pro-0437-B | 1 / 60  | Black ■  |

Ceiling mount, EZCLICK suspension kit with ROD

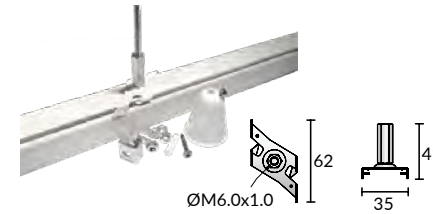

| Model No.    | Package | Colour   |
|--------------|---------|----------|
| Pro-EZ0447-W | 1 / 200 | White □  |
| Pro-EZ0447-S | 1 / 200 | Silver ■ |
| Pro-EZ0447-B | 1 / 200 | Black ■  |

Ceiling mount, EZCLICK suspension kit with wire

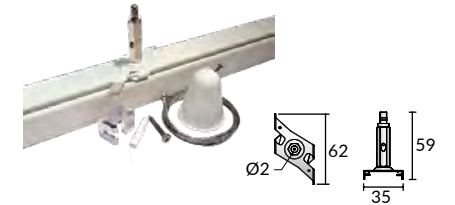

| Model No.    | Package | Colour   |
|--------------|---------|----------|
| Pro-EZ0448-W | 1 / 200 | White □  |
| Pro-EZ0448-S | 1 / 200 | Silver ■ |
| Pro-EZ0448-B | 1 / 200 | Black ■  |

Flexible Connector

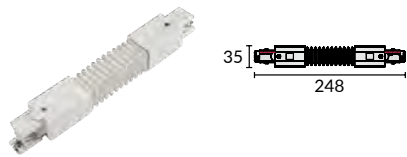

| Model No.  | Package | Colour   |
|------------|---------|----------|
| Pro-0439-W | 1 / 119 | White □  |
| Pro-0439-S | 1 / 119 | Silver ■ |
| Pro-0439-B | 1 / 119 | Black ■  |

Adjustable "L" Connector

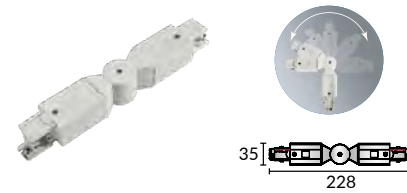

| Model No.  | Package | Colour   |
|------------|---------|----------|
| Pro-0435-W | 1 / 119 | White □  |
| Pro-0435-S | 1 / 119 | Silver ■ |
| Pro-0435-B | 1 / 119 | Black ■  |

T-Bar, EZCLICK mounting kit



| Model No.   | Package | Colour   |
|-------------|---------|----------|
| Pro-M146T-W | 1 / 500 | White □  |
| Pro-M146T-S | 1 / 500 | Silver ■ |
| Pro-M146T-B | 1 / 500 | Black ■  |

Suspension Mounting Kits Manual

1) Adjust the EZCLICK Mounting Kit's Direction, put it vertically into the T-Bar ceiling, and then rotate right and fix (as picture shows).

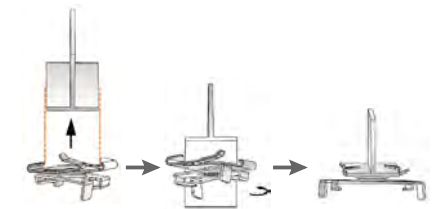

2) Adjust the EZCLICK Mounting Kit's Direction, put the track vertically into the EZCLICK Mounting Kit, rotate left and fix (like picture shows).

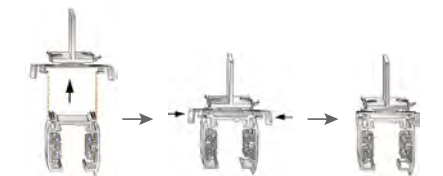

Twisted "T" Connector(Left)

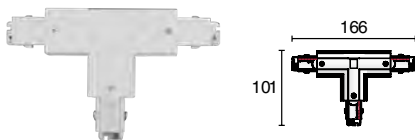

| Model No.   | Package | Colour   |
|-------------|---------|----------|
| Pro-M436L-W | 1 / 84  | White □  |
| Pro-M436L-S | 1 / 84  | Silver ■ |
| Pro-M436L-B | 1 / 84  | Black ■  |

Twisted "T" Connector(Right)

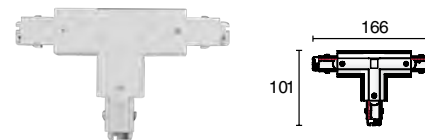

| Model No.   | Package | Colour   |
|-------------|---------|----------|
| Pro-M436R-W | 1 / 84  | White □  |
| Pro-M436R-S | 1 / 84  | Silver ■ |
| Pro-M436R-B | 1 / 84  | Black ■  |

**Ceiling Mount** Reinforcement Plate with suspension wire



| Model No.  | Package | Colour   |
|------------|---------|----------|
| Pro-M147-W | 1 / 200 | White □  |
| Pro-M147-S | 1 / 200 | Silver ■ |
| Pro-M147-B | 1 / 200 | Black ■  |

**Ceiling Mount** Reinforcement Plate with suspension rod

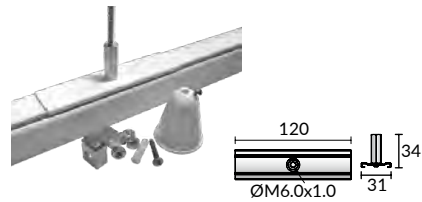

| Model No.  | Package | Colour   |
|------------|---------|----------|
| Pro-M148-W | 1 / 200 | White □  |
| Pro-M148-S | 1 / 200 | Silver ■ |
| Pro-M148-B | 1 / 200 | Black ■  |

**T-Bar, EZCLICK** with Reinforcement Plate

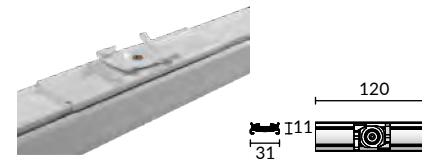

| Model No.  | Package | Colour   |
|------------|---------|----------|
| Pro-M149-W | 1 / 200 | White □  |
| Pro-M149-S | 1 / 200 | Silver ■ |
| Pro-M149-B | 1 / 200 | Black ■  |

**Suspension Hook**



| Model No.  | Package | Colour   |
|------------|---------|----------|
| Pro-M142-W | 1 / 500 | White □  |
| Pro-M142-S | 1 / 500 | Silver ■ |
| Pro-M142-B | 1 / 500 | Black ■  |

**Suspension Mounting Kits Manual**

1) Put the Track into the EZCLICK Mounting Kits Parallely (As picture shows).

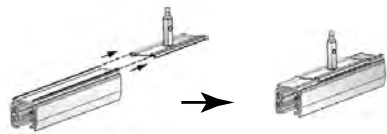

2) Release the start valve, press and get the wire rope through the EZCLICK Mounting Kit, rotate tight the start valve and lock the wire rope (like picture shows).

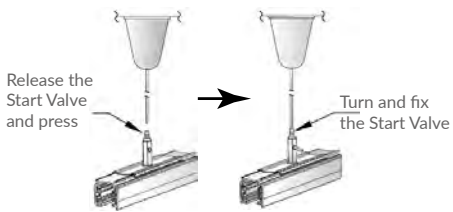

**Suspension Mounting Kits Manual**

1) Put the Track into the EZCLICK Kit Parallely (As picture shows).

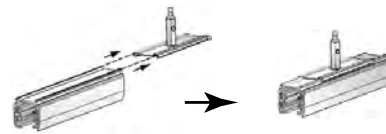

2) Rotate right the EZCLICK Kit and fix it on the rod.

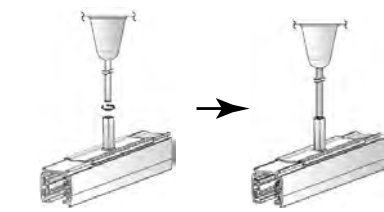

**Suspension Mounting Kits Manual**

1) Put the Track into the EZCLICK Mounting Kits parallely (As picture shows).

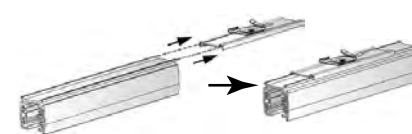

2) Adjust the EZCLICK Mounting Kit's direction, put the track vertically into the EZCLICK Mounting Kit, rotate right and fix (like picture shows).

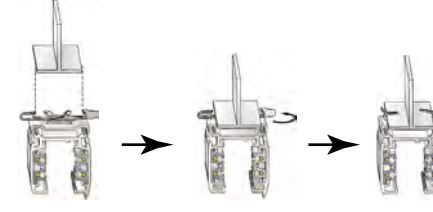

**Mechanical Adaptor**



| Model No.  | Package | Colour   |
|------------|---------|----------|
| Pro-0449-W | 1 / 100 | White □  |
| Pro-0449-S | 1 / 100 | Silver ■ |
| Pro-0449-B | 1 / 100 | Black ■  |

**Suspension kit**



| Model No.  | Package | Colour   |
|------------|---------|----------|
| Pro-04SK-W | 1 / 100 | White □  |
| Pro-04SK-S | 1 / 100 | Silver ■ |
| Pro-04SK-B | 1 / 100 | Black ■  |

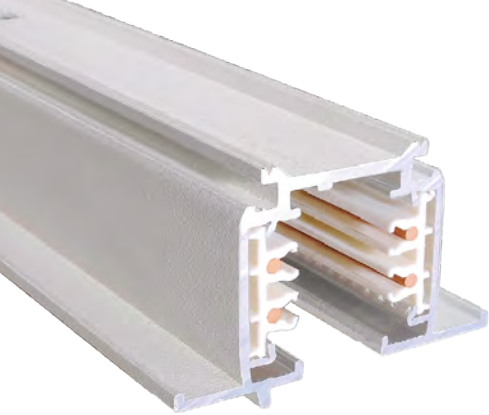

# 3 Circuits Recessed Track System

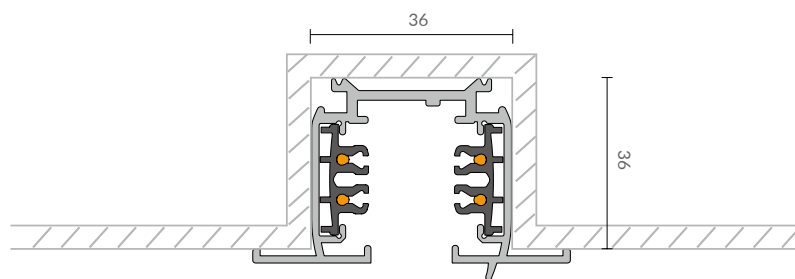
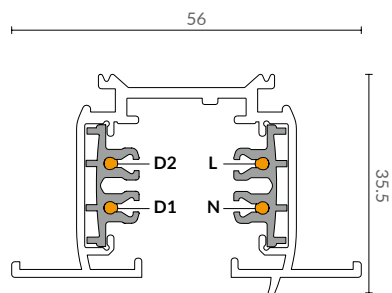

| Model No.                               | Track length                         | Shell Material      | Colour  | Package |
|---|--------------------------------------|---------------------|---|---------|
| Pro-R410-W / Pro-R410-S / Pro-R410-B    | 1M track actual one meter.(100cm)    | Aluminium Extrusion | White <input type="checkbox"/> Silver <input type="checkbox"/> Black <input type="checkbox"/> | 1 / 9   |
| Pro-R415-W / Pro-R415-S / Pro-R415-B    | 1.5M track actual one meter. (150cm) | Aluminium Extrusion | White <input type="checkbox"/> Silver <input type="checkbox"/> Black <input type="checkbox"/> | 1 / 9   |
| Pro-R420-W / Pro-R420-S / Pro-R420-B    | 2M track actual one meter.(200cm)    | Aluminium Extrusion | White <input type="checkbox"/> Silver <input type="checkbox"/> Black <input type="checkbox"/> | 1 / 9   |
| Pro-R430-W / Pro-R430-S / Pro-R430-B    | 3M track actual one meter.(300cm)    | Aluminium Extrusion | White <input type="checkbox"/> Silver <input type="checkbox"/> Black <input type="checkbox"/> | 1 / 6   |
| Pro-R4400-W / Pro-R4400-S / Pro-R4400-B | 4M track actual one meter.(400cm)    | Aluminium Extrusion | White <input type="checkbox"/> Silver <input type="checkbox"/> Black <input type="checkbox"/> | 1 / 6   |

## Live-end Connector Cover



| Model No.  | Package | Colour                          |
|------------|---------|---------------------------------|
| Pro-R431-W | 1 / 500 | White <input type="checkbox"/>  |
| Pro-R431-S | 1 / 500 | Silver <input type="checkbox"/> |
| Pro-R431-B | 1 / 500 | Black <input type="checkbox"/>  |

## Live-End Connector

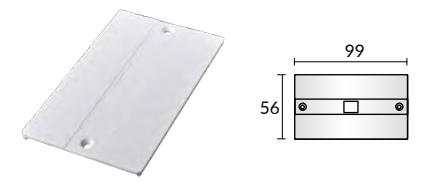

| Model No.  | Package | Colour                          |
|------------|---------|---------------------------------|
| Pro-R434-W | 1 / 400 | White <input type="checkbox"/>  |
| Pro-R434-S | 1 / 400 | Silver <input type="checkbox"/> |
| Pro-R434-B | 1 / 400 | Black <input type="checkbox"/>  |

## Mini Joiner



| Model No.  | Package | Colour                          |
|------------|---------|---------------------------------|
| Pro-R435-W | 1 / 400 | White <input type="checkbox"/>  |
| Pro-R435-S | 1 / 400 | Silver <input type="checkbox"/> |
| Pro-R435-B | 1 / 400 | Black <input type="checkbox"/>  |

## Mini Joiner(insulation)



| Model No.  | Package | Colour                          |
|------------|---------|---------------------------------|
| Pro-R436-W | 1 / 400 | White <input type="checkbox"/>  |
| Pro-R436-S | 1 / 400 | Silver <input type="checkbox"/> |
| Pro-R436-B | 1 / 400 | Black <input type="checkbox"/>  |

## End Cap



| Model No.  | Package | Colour                          |
|------------|---------|---------------------------------|
| Pro-R437-W | 1 / 400 | White <input type="checkbox"/>  |
| Pro-R437-S | 1 / 400 | Silver <input type="checkbox"/> |
| Pro-R437-B | 1 / 400 | Black <input type="checkbox"/>  |

LED Track light

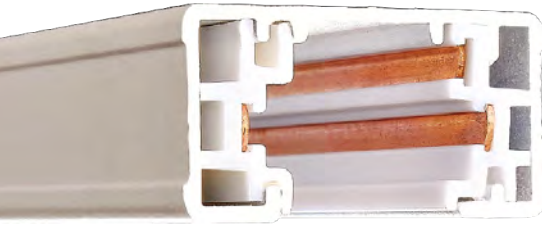

# Single Circuit Track System 3 Wires

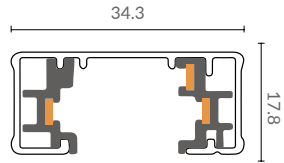

| Model No.  | Track length                                       | Shell Material      | Colour  | Package |
|------------|--|---------------------|---|---------|
| Pro-0310A  | 1M track with double end cap.(100cm)               | Aluminium Extrusion | White <input type="checkbox"/> Silver <input type="checkbox"/> Black <input type="checkbox"/> | 1 / 12  |
| Pro-0320A  | 2M track with double end cap.(200cm)               | Aluminium Extrusion | White <input type="checkbox"/> Silver <input type="checkbox"/> Black <input type="checkbox"/> | 1 / 12  |
| Pro-0330A  | 3M track with double end cap.(300cm)               | Aluminium Extrusion | White <input type="checkbox"/> Silver <input type="checkbox"/> Black <input type="checkbox"/> | 1 / 9   |
| Pro-03400A | 4M track with double end cap.(400cm)               | Aluminium Extrusion | White <input type="checkbox"/> Silver <input type="checkbox"/> Black <input type="checkbox"/> | 1 / 9   |
| Pro-0302A  | 2'track with double end cap actual length24"       | Aluminium Extrusion | White <input type="checkbox"/> Silver <input type="checkbox"/> Black <input type="checkbox"/> | 1 / 12  |
| Pro-0304A  | 4'track with double end cap actual length48"       | Aluminium Extrusion | White <input type="checkbox"/> Silver <input type="checkbox"/> Black <input type="checkbox"/> | 1 / 12  |
| Pro-0306A  | 6'track with double end cap actual length72"       | Aluminium Extrusion | White <input type="checkbox"/> Silver <input type="checkbox"/> Black <input type="checkbox"/> | 1 / 12  |
| Pro-0308A  | 8'track with double end cap actual length96"       | Aluminium Extrusion | White <input type="checkbox"/> Silver <input type="checkbox"/> Black <input type="checkbox"/> | 1 / 12  |
| Pro-0310B  | 1M track with live end & end cap.(100cm)           | Aluminium Extrusion | White <input type="checkbox"/> Silver <input type="checkbox"/> Black <input type="checkbox"/> | 1 / 12  |
| Pro-0320B  | 2M track with live end & end cap.(200cm)           | Aluminium Extrusion | White <input type="checkbox"/> Silver <input type="checkbox"/> Black <input type="checkbox"/> | 1 / 12  |
| Pro-0330B  | 3M track with live end & end cap.(300cm)           | Aluminium Extrusion | White <input type="checkbox"/> Silver <input type="checkbox"/> Black <input type="checkbox"/> | 1 / 9   |
| Pro-03400B | 4M track with live end & end cap.(400cm)           | Aluminium Extrusion | White <input type="checkbox"/> Silver <input type="checkbox"/> Black <input type="checkbox"/> | 1 / 9   |
| Pro-0302B  | 2'track with live end and end cap actual length24" | Aluminium Extrusion | White <input type="checkbox"/> Silver <input type="checkbox"/> Black <input type="checkbox"/> | 1 / 12  |
| Pro-0304B  | 4'track with live end and end cap actual length48" | Aluminium Extrusion | White <input type="checkbox"/> Silver <input type="checkbox"/> Black <input type="checkbox"/> | 1 / 12  |
| Pro-0306B  | 6'track with live end and end cap actual length72" | Aluminium Extrusion | White <input type="checkbox"/> Silver <input type="checkbox"/> Black <input type="checkbox"/> | 1 / 12  |
| Pro-0308B  | 8'track with live end and end cap actual length96" | Aluminium Extrusion | White <input type="checkbox"/> Silver <input type="checkbox"/> Black <input type="checkbox"/> | 1 / 12  |
| Pro-0310C  | 1M track with live end & end cap.(100cm)           | Aluminium Extrusion | White <input type="checkbox"/> Silver <input type="checkbox"/> Black <input type="checkbox"/> | 1 / 12  |
| Pro-0320C  | 2M track with live end & end cap.(200cm)           | Aluminium Extrusion | White <input type="checkbox"/> Silver <input type="checkbox"/> Black <input type="checkbox"/> | 1 / 12  |
| Pro-0330C  | 3M track with live end & end cap.(300cm)           | Aluminium Extrusion | White <input type="checkbox"/> Silver <input type="checkbox"/> Black <input type="checkbox"/> | 1 / 9   |
| Pro-03400C | 4M track with live end & end cap.(400cm)           | Aluminium Extrusion | White <input type="checkbox"/> Silver <input type="checkbox"/> Black <input type="checkbox"/> | 1 / 9   |
| Pro-0302C  | 2'track with live end and end cap actual length24" | Aluminium Extrusion | White <input type="checkbox"/> Silver <input type="checkbox"/> Black <input type="checkbox"/> | 1 / 12  |
| Pro-0304C  | 4'track with live end and end cap actual length48" | Aluminium Extrusion | White <input type="checkbox"/> Silver <input type="checkbox"/> Black <input type="checkbox"/> | 1 / 12  |
| Pro-0306C  | 6'track with live end and end cap actual length72" | Aluminium Extrusion | White <input type="checkbox"/> Silver <input type="checkbox"/> Black <input type="checkbox"/> | 1 / 12  |
| Pro-0308C  | 8'track with live end and end cap actual length96" | Aluminium Extrusion | White <input type="checkbox"/> Silver <input type="checkbox"/> Black <input type="checkbox"/> | 1 / 12  |

# Single Circuit Recessed 3 Wires

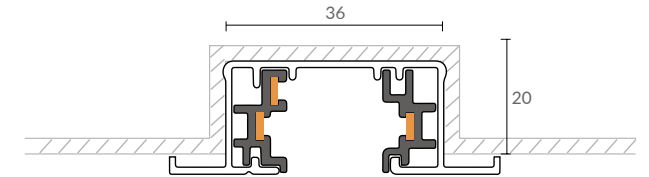
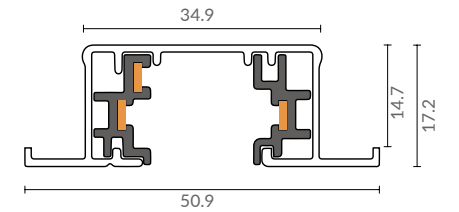

| Model No.  | Track length                                       | Shell Material      | Colour  | Package |
|------------|--|---------------------|---|---------|
| Pro-R310A  | 1M track with double end cap.(100cm)               | Aluminium Extrusion | White <input type="checkbox"/> Silver <input type="checkbox"/> Black <input type="checkbox"/> | 1 / 12  |
| Pro-R320A  | 2M track with double end cap.(200cm)               | Aluminium Extrusion | White <input type="checkbox"/> Silver <input type="checkbox"/> Black <input type="checkbox"/> | 1 / 12  |
| Pro-R330A  | 3M track with double end cap.(300cm)               | Aluminium Extrusion | White <input type="checkbox"/> Silver <input type="checkbox"/> Black <input type="checkbox"/> | 1 / 12  |
| Pro-R3400A | 4M track with double end cap.(400cm)               | Aluminium Extrusion | White <input type="checkbox"/> Silver <input type="checkbox"/> Black <input type="checkbox"/> | 1 / 9   |
| Pro-R302A  | 2'track with double end cap actual length24"       | Aluminium Extrusion | White <input type="checkbox"/> Silver <input type="checkbox"/> Black <input type="checkbox"/> | 1 / 12  |
| Pro-R304A  | 4'track with double end cap actual length48"       | Aluminium Extrusion | White <input type="checkbox"/> Silver <input type="checkbox"/> Black <input type="checkbox"/> | 1 / 12  |
| Pro-R306A  | 6'track with double end cap actual length72"       | Aluminium Extrusion | White <input type="checkbox"/> Silver <input type="checkbox"/> Black <input type="checkbox"/> | 1 / 12  |
| Pro-R308A  | 8'track with double end cap actual length96"       | Aluminium Extrusion | White <input type="checkbox"/> Silver <input type="checkbox"/> Black <input type="checkbox"/> | 1 / 12  |
| Pro-R310B  | 1M track with live end & end cap.(100cm)           | Aluminium Extrusion | White <input type="checkbox"/> Silver <input type="checkbox"/> Black <input type="checkbox"/> | 1 / 12  |
| Pro-R320B  | 2M track with live end & end cap.(200cm)           | Aluminium Extrusion | White <input type="checkbox"/> Silver <input type="checkbox"/> Black <input type="checkbox"/> | 1 / 12  |
| Pro-R330B  | 3M track with live end & end cap.(300cm)           | Aluminium Extrusion | White <input type="checkbox"/> Silver <input type="checkbox"/> Black <input type="checkbox"/> | 1 / 12  |
| Pro-R3400B | 4M track with live end & end cap.(400cm)           | Aluminium Extrusion | White <input type="checkbox"/> Silver <input type="checkbox"/> Black <input type="checkbox"/> | 1 / 9   |
| Pro-R302B  | 2'track with live end and end cap actual length24" | Aluminium Extrusion | White <input type="checkbox"/> Silver <input type="checkbox"/> Black <input type="checkbox"/> | 1 / 12  |
| Pro-R304B  | 4'track with live end and end cap actual length48" | Aluminium Extrusion | White <input type="checkbox"/> Silver <input type="checkbox"/> Black <input type="checkbox"/> | 1 / 12  |
| Pro-R306B  | 6'track with live end and end cap actual length72" | Aluminium Extrusion | White <input type="checkbox"/> Silver <input type="checkbox"/> Black <input type="checkbox"/> | 1 / 12  |
| Pro-R308B  | 8'track with live end and end cap actual length96" | Aluminium Extrusion | White <input type="checkbox"/> Silver <input type="checkbox"/> Black <input type="checkbox"/> | 1 / 12  |

LED Track light

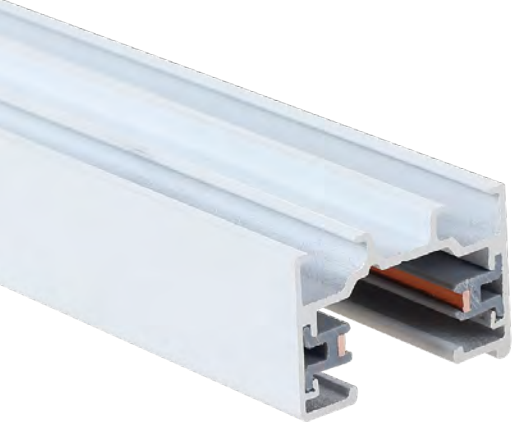

# Single Circuit Track System

## 2 Wires

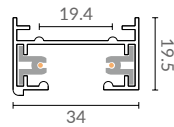

| Model No.  | Track length   | Shell Material      | Colour  |
|------------|--|---------------------|---|
| Pro-L210-W | 1M / 1.5M / 2M / 3M track actual one meter.<br>(100cm / 150cm / 200cm / 300cm) | Aluminium Extrusion | White <input type="checkbox"/> Silver <input type="checkbox"/> Black <input type="checkbox"/> |

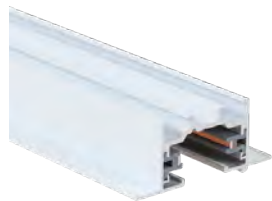

| Model No.   | Track length   | Shell Material      | Colour  |
|-------------|--|---------------------|---|
| Pro-RL210-W | 1M / 1.5M / 2M / 3M track actual one meter.<br>(100cm / 150cm / 200cm / 300cm) | Aluminium Extrusion | White <input type="checkbox"/> Silver <input type="checkbox"/> Black <input type="checkbox"/> |

# 3 Circuit Recessed

## 6 Wires

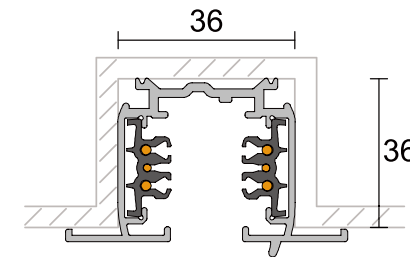
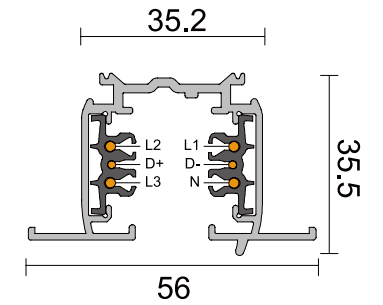

LED Track light

| Model No. | Track length | Shell Material      | Colour  | Package |
|-----------|--------------|---------------------|---|---------|
| Pro-R610  | 1000(mm)     | Aluminium Extrusion | White <input type="checkbox"/> Silver <input type="checkbox"/> Black <input type="checkbox"/> | 1 / 9   |
| Pro-R620  | 2000(mm)     | Aluminium Extrusion | White <input type="checkbox"/> Silver <input type="checkbox"/> Black <input type="checkbox"/> | 1 / 9   |
| Pro-R630  | 3000(mm)     | Aluminium Extrusion | White <input type="checkbox"/> Silver <input type="checkbox"/> Black <input type="checkbox"/> | 1 / 6   |
| Pro-R6400 | 4000(mm)     | Aluminium Extrusion | White <input type="checkbox"/> Silver <input type="checkbox"/> Black <input type="checkbox"/> | 1 / 4   |



# LED Panel Light

/Series/

LED panel light is one of the most popular luminaire for commercial lighting, with continuous modification of its design, light efficiency, CRI, UGR and smart function, UPSHINE Lighting is always capable of providing customers with helpful solution and best price, that's the main reason UPSHINE Lighting is preferred supplier of LED panel lamp in the market. UPSHINE LED panel family supply different solution for project and distribution, such as regular LED panel with high Lumen and low UGR, CCT changing LED panel, waterproof led panel, frameless led panel, Up/down emitting led panel, big size round led panel with recessed / surface mounted / pendant installation, TUV-CE approved Upshine driver and Lifud, Tridonic, Philips driver ensure our reputation of quality always.



# PL-CK5 Backlit panel light

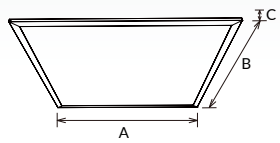

PL-CK5 series is slim design backlit panel just 25mm thickness. It makes full use of all light and is more cost effective compared with side lighting LED panel light. It is adopted high lumen 2835 SMD light source, the optical lens provides a uniform light output.

Materials of Housing : Aluminium, SPCC

Materials of Optics : PMMA(Lens)+PS(Diffuser)

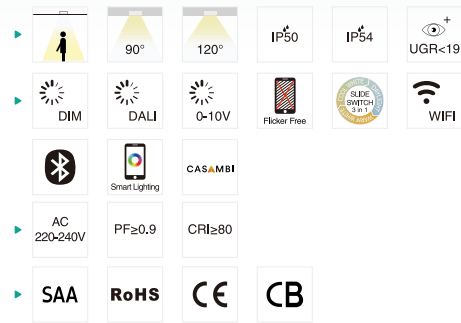

| Code            | Watt | Size(AxBxCmm) | Cut-out(±5mm) | Lumen(±5%)                  | N.W/pc(kgs) | Q'ty/CTN  |
|-----------------|------|---------------|---------------|-----------------------------|-------------|-----------|
| PL6060-36W-CK5  | 36W  | 595x595x25    | 570x570       | 100lm/W<br>(90lm/W UGR<19)  | 1.82        | 5PCS/6PCS |
| PL6262-36W-CK5  | 36W  | 620x620x25    | 590x590       | 100lm/W<br>(90lm/W UGR<19)  | 1.91        | 5PCS/6PCS |
| PL30120-36W-CK5 | 36W  | 1195x295x25   | 1170x270      | 100lm/W<br>(90lm/W UGR<19)  | 1.86        | 5PCS/6PCS |
| PL6060-36W-CK5  | 36W  | 595x595x25    | 570x570       | 120lm/W<br>(110lm/W UGR<19) | 1.82        | 5PCS/6PCS |
| PL6262-36W-CK5  | 36W  | 620x620x25    | 590x590       | 120lm/W<br>(110lm/W UGR<19) | 1.91        | 5PCS/6PCS |
| PL30120-36W-CK5 | 36W  | 1195x295x25   | 1170x270      | 120lm/W<br>(110lm/W UGR<19) | 1.86        | 5PCS/6PCS |
| PL6060-30W-CK5  | 30W  | 595x595x25    | 570x570       | 140lm/W<br>(130lm/W UGR<19) | 1.82        | 5PCS/6PCS |
| PL6262-30W-CK5  | 30W  | 620x620x25    | 590x590       | 140lm/W<br>(130lm/W UGR<19) | 1.91        | 5PCS/6PCS |
| PL30120-30W-CK5 | 30W  | 1195x295x25   | 1170x270      | 140lm/W<br>(130lm/W UGR<19) | 1.86        | 5PCS/6PCS |
| PL6060-20W-CK5  | 20W  | 595x595x25    | 570x570       | 180lm/W<br>(160lm/W UGR<19) | 1.82        | 5PCS/6PCS |
| PL6262-20W-CK5  | 20W  | 620x620x25    | 590x590       | 180lm/W<br>(160lm/W UGR<19) | 1.91        | 5PCS/6PCS |
| PL30120-20W-CK5 | 20W  | 1195x295x25   | 1170x270      | 180lm/W<br>(160lm/W UGR<19) | 1.86        | 5PCS/6PCS |
| PL6060-22W-CK5  | 22W  | 595x595x25    | 570x570       | 4260lm<br>(200lm/W)         | 8.40        | 6PCS      |
| PL6262-22W-CK5  | 22W  | 620x620x25    | 590x590       | 4260lm<br>(200lm/W)         | 9.70        | 6PCS      |
| PL30120-22W-CK5 | 22W  | 1195x295x25   | 1170x270      | 4260lm<br>(200lm/W)         | 9.60        | 6PCS      |
| PL60120-40W-CK5 | 40W  | 1195x595x25   | 1170x570      | 7800lm<br>(200lm/W)         | 13.1        | 4PCS      |

CCT — 3000K — 4000K — 5700K

Finish — White

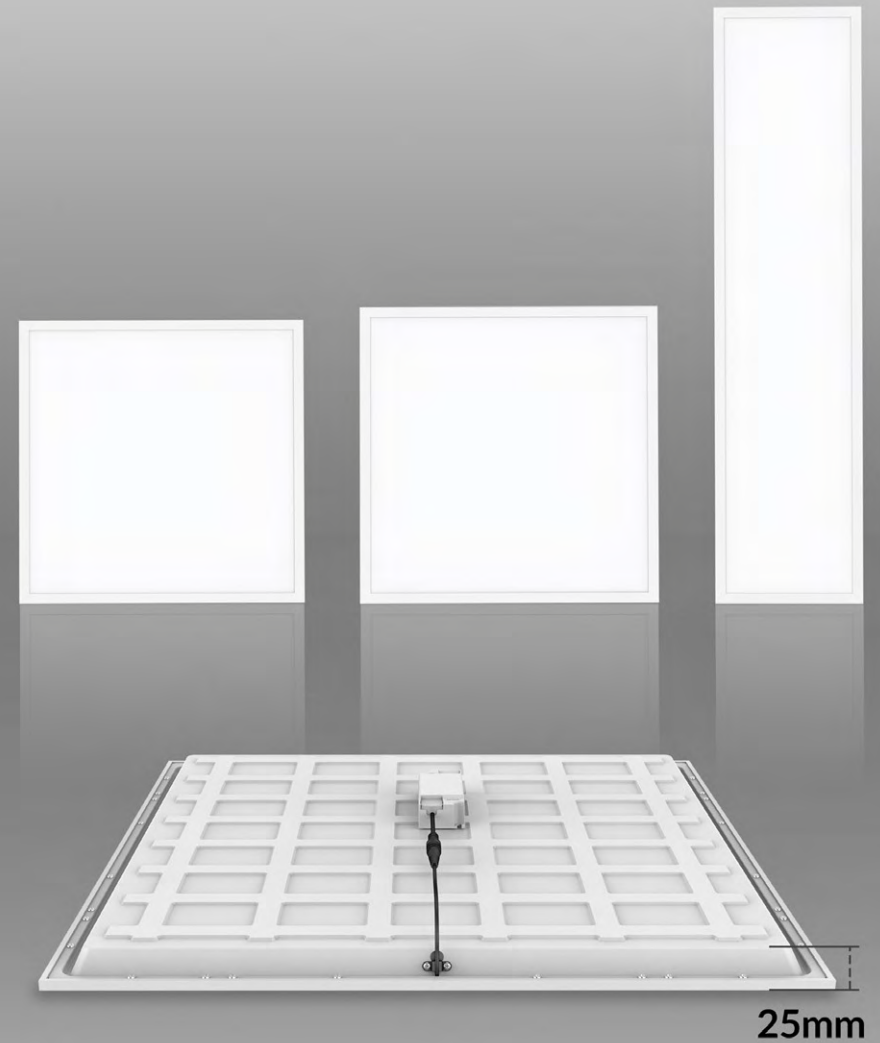

## PL-CK5 SUPER SLIM BACKLIT PANEL



# PL-CK002 Backlit panel light

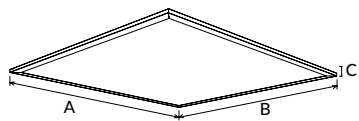

PL-CK002 series is slim design backlit panel just 20mm thickness. It makes full use of all light and is more cost effective compared with side lighting LED panel light. It is adopted high lumen 2835 SMD light source, the optical lens provides a uniform light output. With integrated iron plate, providing great thermal management.

Materials of Housing : SPCC

Materials of Optics : PMMA(Lens)+PS(Diffuser)

- ▶ 90° 120°
- IP54 UGR<19
- ▶ DIM DALI 0-10V Flicker Free
- ▶ AC 220-240V PF≥0.9 CRI≥80
- ▶ SAA RoHS CE CB

| Code                     | Watt | Size(AxBxCmm) | Lumen(±5%) | N.W/pc(kgs) | Q'ty/CTN |
|--------------------------|------|---------------|------------|-------------|----------|
| PL6060-36W-CK002         | 36W  | 595x595x20    | 3800lm     | 1.67        | 6PCS     |
| PL6060-36W-CK002(UGR19)  | 36W  | 595x595x20    | 3500lm     | 1.96        | 6PCS     |
| PL30120-36W-CK002        | 36W  | 1195x295x20   | 3720lm     | 1.52        | 6PCS     |
| PL30120-36W-CK002(UGR19) | 36W  | 1195x295x20   | 3460lm     | 1.77        | 6PCS     |

CCT  3000K 4000K 5700K

Installation accessories Suspension kit

Finish White

# 20MM THICKNESS

## Generation Backlit Panel

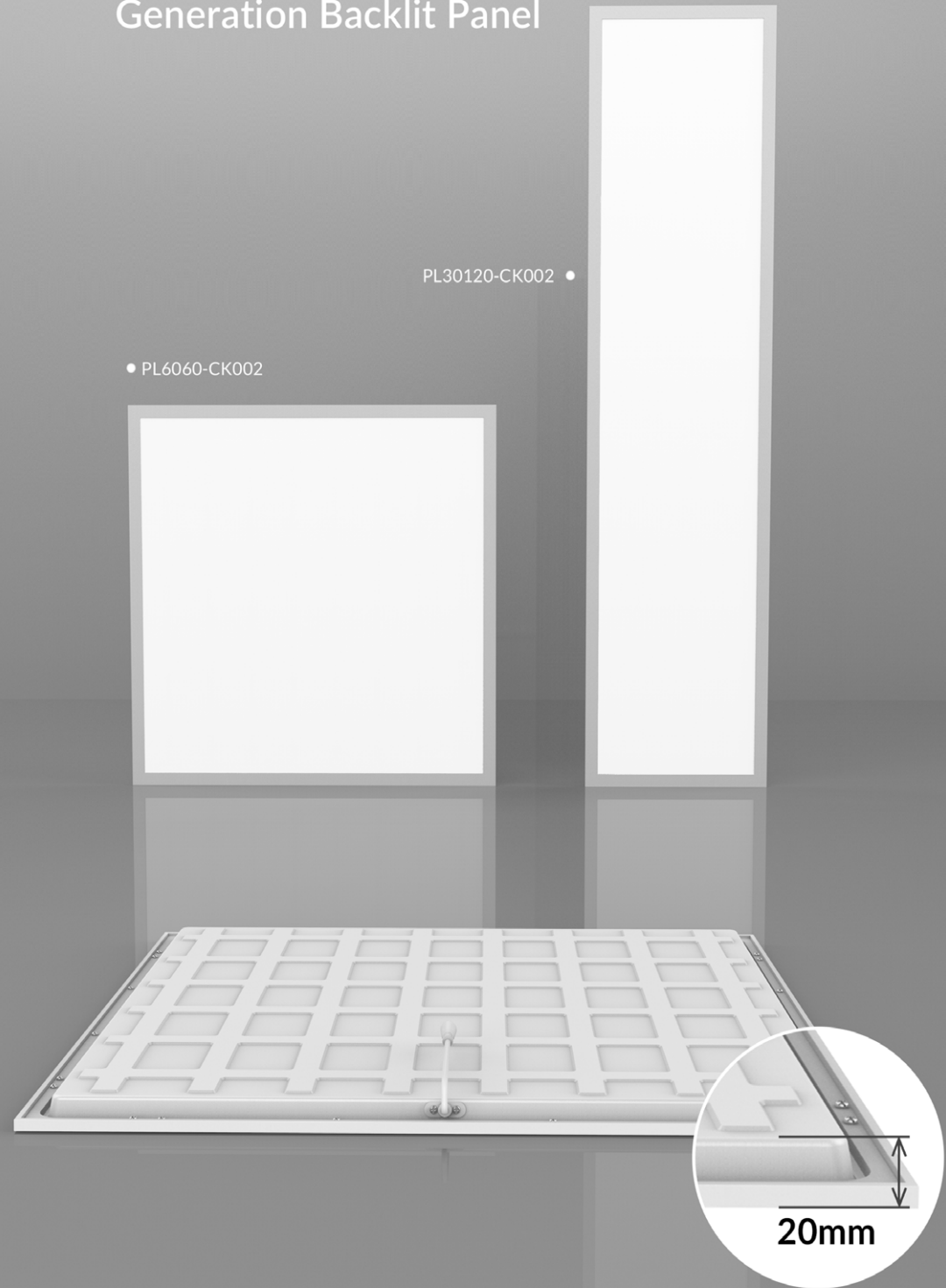

PL30120-CK002 •

• PL6060-CK002

20mm

# PL-CK8 Backlit panel light

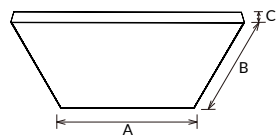

PL-CK8 panel is backlit panel with frameless design. Adopt high lumen 2835 SMD light source, CRI>80 and CRI>90 for option, CCT switch is available. Recessed, suspended and surface mounted installation ways for choice.

Materials of Housing : Aluminium, SPCC  
Materials of Optics : PMMA(Lens)+PS(Diffuser)

- ▶
- ▶

| Code            | Watt | Size(AxBxCmm) | Cut-out(mm) | Lumen(±5%) | N.W/pc(kgs) | Q'ty/CTN |
|-----------------|------|---------------|-------------|------------|-------------|----------|
| PL6060-CK8-36W  | 36W  | 595x595x50    | 570x570     | 4770lm     | 2.70        | 5PCS     |
| PL30120-CK8-36W | 36W  | 1195x295x50   | 1170x270    | 4450lm     | 3.20        | 5PCS     |

CCT ——— 3000K ——— 4000K ——— 5700K

Finish ——— White

Installation accessories ——— Suspension kit

# PL-CK2 Backlit panel light

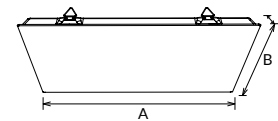

PL-CK2 panel is a patented frameless design with larger lighting area, direct lighting way makes full use of all light. Adopt high lumen 2835 SMD light source, the optical lens provides a uniform light output. The lamps are directly provided with pendants, which is convenient for installation. 2CCT/ 3CCT adjustable by slide switch is available.

Materials of Housing : SPCC  
Materials of Optics : PMMA(Lens)+PS(Diffuser)

- ▶
- ▶

| Code            | Watt | Size(AxBxCmm) | Cut-out(±5mm) | Lumen(±5%) | N.W/pc(kgs) | Q'ty/CTN  |
|-----------------|------|---------------|---------------|------------|-------------|-----------|
| PL6060-36W-CK2  | 36W  | 595x595x28    | 580x580       | 120LM/W    | 1.50        | 5PCS/6PCS |
| PL6262-36W-CK2  | 36W  | 620x620x28    | 605x605       | 120LM/W    | 1.82        | 5PCS/6PCS |
| PL30120-36W-CK2 | 36W  | 1195x295x28   | 1180x280      | 120LM/W    | 1.76        | 5PCS/6PCS |
| PL6060-25W-CK2  | 25W  | 595x595x28    | 580x580       | 130LM/W    | 1.50        | 5PCS/6PCS |
| PL6262-25W-CK2  | 25W  | 620x620x28    | 605x605       | 130LM/W    | 1.82        | 5PCS/6PCS |
| PL30120-25W-CK2 | 25W  | 1195x295x28   | 1180x280      | 130LM/W    | 1.76        | 5PCS/6PCS |
| PL6060-28W-CK2  | 28W  | 595x595x28    | 580x580       | 130LM/W    | 1.50        | 5PCS/6PCS |
| PL6262-28W-CK2  | 28W  | 620x620x28    | 605x605       | 130LM/W    | 1.82        | 5PCS/6PCS |
| PL30120-28W-CK2 | 28W  | 1195x295x28   | 1180x280      | 130LM/W    | 1.76        | 5PCS/6PCS |

CCT ——— 3000K ——— 4000K ——— 5700K

Finish ——— White

Installation accessories ——— Suspension kit

# CK15 Backlit panel light

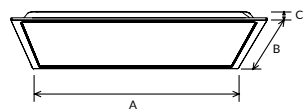

Panel light PL-CK15 is ECO design, no screw fixing, no separate frame with high working efficiency. There are hooks on four sides, convenient for suspension installation.

Materials of Housing : SPCC

Materials of Optics : PMMA(Lens)+PS(Diffuser)



| Code           | Watt | Size(AxBxCmm) | Cut-out(mm) | Lumen(±5%) | N.W/pc(kgs) | Q'ty/CTN |
|----------------|------|---------------|-------------|------------|-------------|----------|
| CK15-6060-36W  | 36W  | 595x595x30    | 570x570     | 3600lm     | 1.50        | 6PCS     |
| CK15-30120-36W | 36W  | 295x1195x30   | 270x1170    | 3600lm     | 1.80        | 6PCS     |

CCT — 3000K — 4000K — 5700K

Finish — White

Installation accessories — Suspension kit

# CK19 <sup>NEW</sup> Backlit panel light

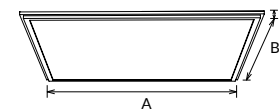

CK19 Panel light is stepped frame design to blend perfectly with the ceiling and facilitates easy installation. Uniform light effect with optic lens and Built-out driver, 3CCT available.

Materials of Housing : Aluminium, SPCC

Materials of Optics : PMMA(Lens)+PS(Diffuser)

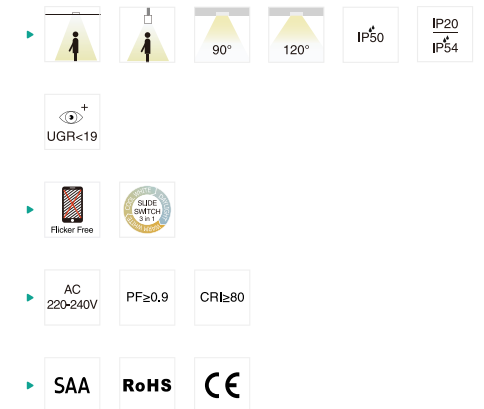

| Code               | Watt | Size(AxBxCmm) | Cut-out(mm) | Lumen(±5%) | N.W/pc(kgs) | Q'ty/CTN |
|--------------------|------|---------------|-------------|------------|-------------|----------|
| CK19-6060-36W      | 36W  | 595x595x32    | 580x580     | 4050lm     | 1.70        | 5PCS     |
| CK19-6060-36W(UGR) | 36W  | 595x595x32    | 580x580     | 3780lm     | 1.70        | 5PCS     |

CCT — 3000K — 4000K — 5700K

Finish — White

Installation accessories — Suspension kit

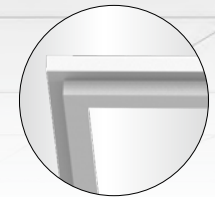

# CK22 NEW Backlit panel light

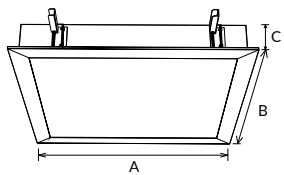

CK22 Led panel light is a pubish light, speical design with dustproof, waterproof IP65, explosion-proof IK10 and anti-tamper function suitable for hospitals, pharmaceutical factories, food processing plants . It's high lumen SMD 120lm/w, anti-glare UGR<19 design and CRI90, it's available for sensor and emergency function.

Materials of Housing : AL+SPCC  
Materials of Optics : PC/PMMA/PS

- ▶ 90° IP65
- ▶ DIM DALI 0-10V Flicker Free
- ▶ AC 220-240V PF≥0.9 CRI≥80 CRI≥90
- ▶ SAA RoHS CE

| Code       | Watt | Size(AxBxCmm) | Cut-out(mm) | Lumen(±5%) | N.W/pc(kgs) | Q'ty/CTN |
|------------|------|---------------|-------------|------------|-------------|----------|
| CK22-6060  | 40W  | 592x592x80    | 575x575     | 4800lm     | 7.00        | 2PCS     |
| CK22-30120 | 40W  | 1230x325x80   | 310x1190    | 4800lm     | 7.00        | 2PCS     |

CCT ——— 3000K ——— 4000K ——— 5700K

Finish ——— White



LED Panel light

# PL-CK003 Backlit Panel light



PL-CK003 is an IP65 rating panel light with backlit lighting structure, with external IP65 driver, the whole lamp satisfy IP65. It adopts PMMA optical lens and high lumen SMD, give uniform light output and avoid yellow risky. The panel equipped with a waterproof and breathable valve to balance the pressure inside and outside.

Materials of Housing : Aluminium+SPCC

Materials of Optics : PMMA(Lens)+PS(Diffuser)

- ▶
- ▶
- ▶
- ▶

| Code               | Watt | Size(AxBxCmm) | Cut-out(mm) | Lumen(±5%) | N.W/pc(kgs) | Q'ty/CTN |
|--------------------|------|---------------|-------------|------------|-------------|----------|
| PL-CK003-6060-36W  | 36W  | 595x595x27    | Ø570x570    | 3680lm     | 1.82        | 5PCS     |
| PL-CK003-30120-36W | 36W  | 295x1195x27   | Ø270x1170   | 3600lm     | 2.02        | 5PCS     |

CCT — 3000K — 4000K — 5700K

Installation accessories — Suspension kit

# PL-DS Panel light

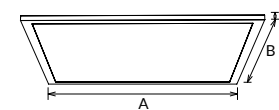

PL-DS panel adopts upper and lower frame structure design to reach an IP65 waterproof effect, it has a strong structure with 10mm thickness. Besides, it has high lumen SMD light source and PMMA LGP which offer a uniform light output and avoid yellow risky. External IP65 flicker free driver with waterproof DC connector UGR<19 available. Multiple installation ways: recessed, suspended and surface mounted.

Materials of Housing : Aluminium(Frame)

Materials of Optics : PMMA (LGP) / PS(Diffuser)

- ▶
- ▶
- ▶
- ▶

| Code                    | Watt | Size(AxBxCmm) | Cut-out(±5mm) | Lumen(±5%) | N.W/pc(kgs) | Q'ty/CTN |
|-------------------------|------|---------------|---------------|------------|-------------|----------|
| PL3030-15W-DS           | 15W  | 295x295x10    | 280x280       | 1275lm     | 1.05        | 10PCS    |
| PL3060-20W-DS           | 20W  | 595x295x10    | 580x280       | 1800lm     | 1.79        | 5PCS     |
| PL6060-36W-DS           | 36W  | 595x595x10    | 580x580       | 3600lm     | 3.16        | 4PCS     |
| PL6262-36W-DS           | 36W  | 620x620x10    | 605x605       | 3600lm     | 3.43        | 4PCS     |
| PL30120-36W-DS          | 36W  | 1195x295x10   | 1180x280      | 3600lm     | 3.31        | 4PCS     |
| PL60120-60W-DS          | 60W  | 1195x595x10   | 1180x580      | 6300lm     | 6.37        | 2PCS     |
| PL3030-10W-DS (UGR<19)  | 10W  | 295x295x10    | 280x280       | 950lm      | 1.05        | 10PCS    |
| PL3060-15W-DS (UGR<19)  | 15W  | 595x295x10    | 580x280       | 1575lm     | 1.79        | 5PCS     |
| PL6060-36W-DS (UGR<19)  | 36W  | 595x595x10    | 580x580       | 3960lm     | 3.16        | 4PCS     |
| PL6262-36W-DS (UGR<19)  | 36W  | 620x620x10    | 605x605       | 3960lm     | 3.43        | 4PCS     |
| PL30120-36W-DS (UGR<19) | 36W  | 1195x295x10   | 1180x280      | 3960lm     | 3.31        | 4PCS     |

CCT — 3000K — 4000K — 5700K

Installation accessories — Suspension kit

Finish — White

# PL009 NEW Panel light

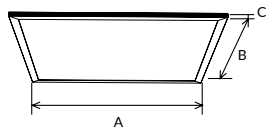

PL009 is a new panel light solution with strong aluminum frame structure. It adopts PMMA LGP, high lumen SMD with CRI>80, Besides, it can fit seamlessly into any work place, available in various installation ways: recessed, suspended and surface mounted. Triac dim, 0-10V dim, Dali dim and 3CCT changeable for wide option.

Materials of Housing : Aluminium(Frame)

Materials of Optics : PS(diffuser)+PMMA(LGP)

- ▶ IP40
- ▶
- ▶
- ▶

| Code            | Watt | Size(AxBxCmm) | Lumen(±5%) | N.W/pc(kgs) | Q'ty/CTN |
|-----------------|------|---------------|------------|-------------|----------|
| PL009-3030-16W  | 16W  | 295x296x8.5   | 1700lm     | 0.66        | 12PCS    |
| PL009-3060-18W  | 18W  | 295x595x8.5   | 1945lm     | 1.22        | 6PCS     |
| PL009-6060-33W  | 33W  | 595x595x8.5   | 3635lm     | 2.92        | 5PCS     |
| PL009-6262-33W  | 33W  | 620x620x8.5   | 3635lm     | 2.48        | 5PCS     |
| PL009-30120-33W | 33W  | 295x1195x8.5  | 3635lm     | 2.2         | 5PCS     |

CCT ——— 3000K ——— 4000K ——— 5700K

Installation accessories ——— Suspension kit

Finish ——— White

# PL001 Panel light

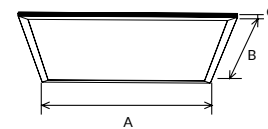

PL001 is a side-emitting panel light with 150lm/W @ 4000K. PMMA LGP makes it uniform light and high lumen output, prismatic diffuser makes UGR<19. The external flicker free driver design with triac, 0-10V, DALI are available. Various installation ways for options: recessed, suspended and surface mounted.

Materials of Housing : PS(Diffuser plate)/Aluminium(Frame)

Materials of Optics : PMMA(Lens)+PS(Diffuser)

- ▶ IP40
- ▶
- ▶
- ▶

| Code            | Watt | Size(AxBxCmm) | Lumen(±5%) | N.W/pc(kgs) | Q'ty/CTN |
|-----------------|------|---------------|------------|-------------|----------|
| PL001-6060-25W  | 25W  | 596x596x9     | 3750lm     | 2.78        | 5PCS     |
| PL001-6262-25W  | 25W  | 620x620x9     | 3750lm     | 2.99        | 5PCS     |
| PL001-30120-25W | 25W  | 295x1195x9    | 3750lm     | 2.85        | 5PCS     |
| PL001-60120-25W | 40W  | 595x1195x9    | 6000lm     | 5.75        | 2PCS     |

CCT ——— 3000K ——— 4000K ——— 5700K

Installation accessories ——— Suspension kit

Finish ——— White

# PL-G5B Panel light

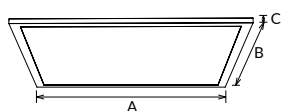

PL-G5B is 10mm thickness edgelit panel, which adopts high lumen SMD LED acheive 120lm/W, with external flickering free driver, triac dim, 0-10V dim and DALI dim available. It available with various installation ways: embedded into ceiling, suspended with hanging wires, surface mounted in a concrete ceiling by using surface mounting frame.

Materials of Housing : Aluminium

Materials of Optics : PMMA (LGP) / PS(Diffuser)

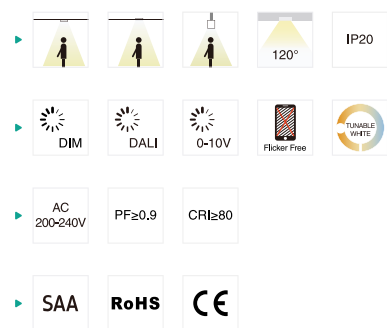

| Code            | Watt | Size(AxBxCmm) | Cut-out(±5mm) | Lumen(±5%) | N.W/pc(kgs) | Q'ty/CTN |
|-----------------|------|---------------|---------------|------------|-------------|----------|
| PL3030-10W-G5B  | 10W  | 295x295x10    | 280x280       | 1210lm     | 0.76        | 12PCS    |
| PL3060-20W-G5B  | 20W  | 595x295x10    | 580x280       | 2530lm     | 1.37        | 6PCS     |
| PL6060-28W-G5B  | 28W  | 595x595x10    | 580x580       | 3696lm     | 2.60        | 5PCS     |
| PL6060-33W-G5B  | 33W  | 595x595x10    | 580x580       | 4356lm     | 2.60        | 5PCS     |
| PL6262-28W-G5B  | 28W  | 620x620x10    | 605x605       | 3696lm     | 2.80        | 2PCS     |
| PL6262-33W-G5B  | 33W  | 620x620x10    | 605x605       | 4356lm     | 2.80        | 2PCS     |
| PL30120-28W-G5B | 28W  | 1195x295x10   | 1180x280      | 3696lm     | 2.67        | 5PCS     |
| PL30120-33W-G5B | 33W  | 1195x295x10   | 1180x280      | 4356lm     | 2.67        | 5PCS     |
| PL60120-50W-G5B | 50W  | 1195x595x10   | 1180x580      | 6600lm     | 5.23        | 2PCS     |

CCT — 3000K — 4000K — 5700K

Installation accessories — Suspension kit

Finish — White

# PL-G6B Panel light

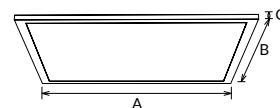

PL-G6B is UGR<19 10mm thickness edgelit panel, which adopts high lumen SMD LED acheive 120lm/W, with external flickering free driver, triac dim, 0-10V dim and DALI dim available. It available with various installation ways: embedded into ceiling, suspended with hanging wires, surface mounted in a concrete ceiling by using surface mounting frame.

Materials of Housing : Aluminium

Materials of Optics : PMMA (LGP) / PS(Diffuser)

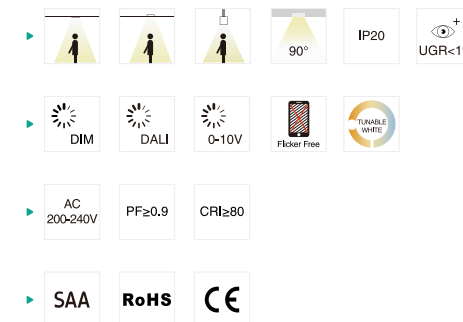

| Code            | Watt | Size(AxBxCmm) | Cut-out(±5mm) | Lumen(±5%) | N.W/pc(kgs) | Q'ty/CTN |
|-----------------|------|---------------|---------------|------------|-------------|----------|
| PL3030-10W-G6B  | 10W  | 295x295x10    | 280x280       | 1210lm     | 0.76        | 12PCS    |
| PL3060-20W-G6B  | 20W  | 595x295x10    | 580x280       | 2530lm     | 1.37        | 6PCS     |
| PL6060-28W-G6B  | 28W  | 595x595x10    | 580x580       | 3696lm     | 2.60        | 5PCS     |
| PL6060-33W-G6B  | 33W  | 595x595x10    | 580x580       | 4356lm     | 2.60        | 5PCS     |
| PL6262-28W-G6B  | 28W  | 620x620x10    | 605x605       | 3696lm     | 2.80        | 5PCS     |
| PL6262-33W-G6B  | 33W  | 620x620x10    | 605x605       | 4356lm     | 2.80        | 5PCS     |
| PL30120-28W-G6B | 28W  | 1195x295x10   | 1180x280      | 3696lm     | 2.67        | 5PCS     |
| PL30120-33W-G6B | 33W  | 1195x295x10   | 1180x280      | 4356lm     | 2.67        | 5PCS     |
| PL60120-50W-G6B | 50W  | 1195x595x10   | 1180x580      | 6600lm     | 5.23        | 2PCS     |

CCT — 3000K — 4000K — 5700K

Installation accessories — Suspension kit

Finish — White

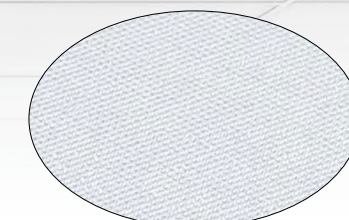





# PL-AF2 Air Slot

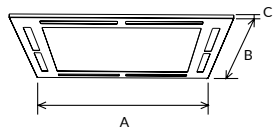

PL-AF2 LED panel light with external flicker free driver, adopting high lumen leds which reach to 110lm/W. frame with air slot design to allow the air to circulate. Separate panel module ensures the easy installation and maintenance.

Materials of Housing : Aluminium,SPCC  
Materials of Optics : PP(Piffuser plate)

- ▶ IP40
- ▶ DIM Flicker Free
- ▶ AC 220-240V PF≥0.9 CRI≥80
- ▶ SAA RoHS CE

| Code       | Watt | Size(AxBxCmm) | Lumen(±5%) | N.W/pc(kgs) | Q'ty/CTN |
|------------|------|---------------|------------|-------------|----------|
| PL6060-AF2 | 27W  | 596x596x10    | 2970lm     | 2.90        | 5PCS     |

CCT ——— 3000K ——— 4000K ——— 5700K

Finish ——— White

## AIR SLOT RECESSED DESIGN

Ideal Replacement For Fluorescent Fixtures  
With Air-Conditioning Slots

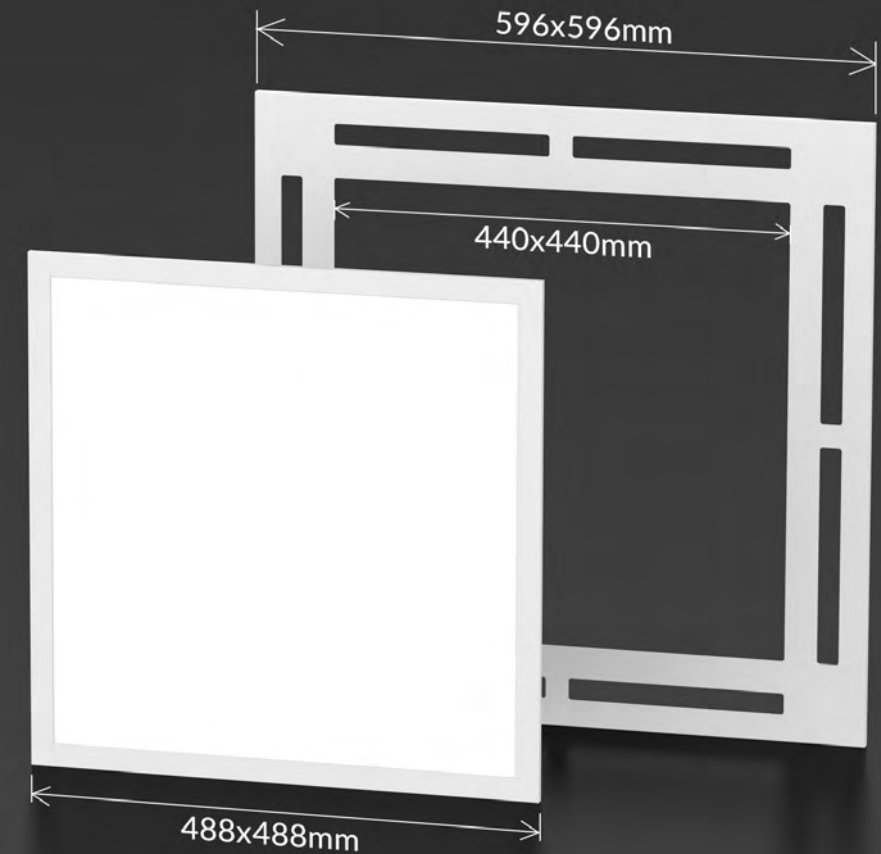

LED Panel light



# PL-CC Fine Line

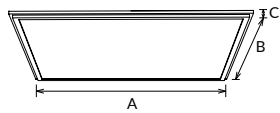

PL-CC panel is 14.3mm thickness panel with external driver, adopts high lumen LED chips with CRI>80, PMMA LGP produces uniform and comfortable light. Stronger frame makes better heat dissipation than common panels. The lighting area fits seamlessly with the ceiling. Recessed installation with clips make it suitable for more kinds of ceiling perfectly.

Materials of Housing : Aluminium

Materials of Optics : PMMA(LGP)+PP(diffuser)

- ▶ 120° IP40
- ▶ DIM DALI 0-10V Flicker Free
- ▶ AC 220-240V PF≥0.9 CRI≥80
- ▶ SAA RoHS CE

| Code           | Watt | Size(AxBxCmm) | Cut-out(±5mm) | Lumen(±5%) | N.W/pc(kgs) | Q'ty/CTN |
|----------------|------|---------------|---------------|------------|-------------|----------|
| PL6060-33W-CC  | 33W  | 595x595x14.3  | 585x585       | 3530lm     | 2.50        | 5PCS     |
| PL6060-42W-CC  | 42W  | 595x595x14.3  | 585x585       | 4370lm     | 2.50        | 5PCS     |
| PL30120-33W-CC | 33W  | 1195x295x14.3 | 285x1185      | 3400lm     | 2.65        | 5PCS     |
| PL30120-42W-CC | 42W  | 1195x295x14.3 | 285x1185      | 4210lm     | 2.65        | 5PCS     |

CCT — 3000K — 4000K — 5700K

Finish — White

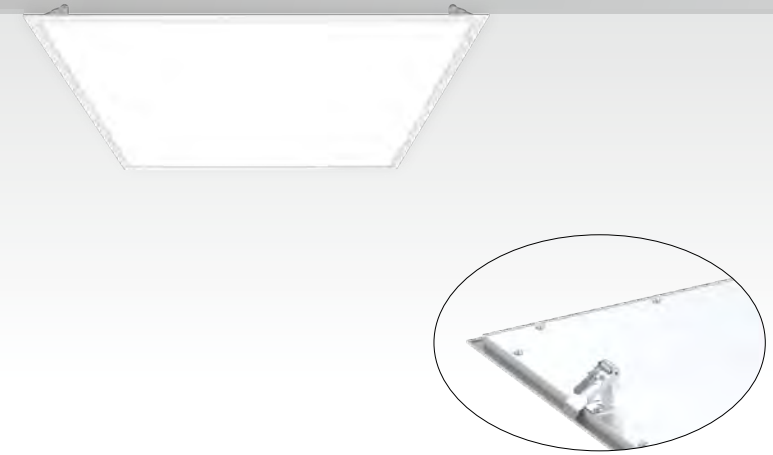

# PL-CD Panel light

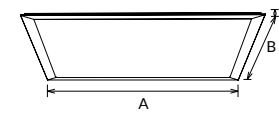

PL-CD panel light is 8.5mm thickness frame with fixed spring design panel light with external driver, adopts high lumen LED chips with CRI>80, special frame design provides excellent thermal management. Recessed installation with clips makes it suitable for more kinds of ceiling.

Materials of Housing : Aluminium

Materials of Optics : PS(LGP)+PP(diffuser)

- ▶ 120° IP40
- ▶ DIM DALI 0-10V Flicker Free
- ▶ AC 220-240V PF≥0.9 CRI≥80
- ▶ SAA RoHS CE

| Code           | Watt | Size(AxBxCmm) | Cut-out(±5mm) | Lumen(±5%) | N.W/pc(kgs) | Q'ty/CTN |
|----------------|------|---------------|---------------|------------|-------------|----------|
| PL6060-33W-CD  | 33W  | 595x595x35.5  | 585x585       | 3460lm     | 2.35        | 5PCS     |
| PL30120-33W-CD | 33W  | 1195x295x35.5 | 285x1185      | 3400lm     | 2.40        | 5PCS     |

CCT — 3000K — 4000K — 5700K

Finish — White



# PL006 Panel light

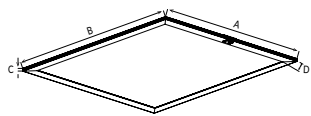

PL006 side-lit panel light is a ODM case with tuya IOT provider, share the same UI as tuya, available with PIR sensor, photo sensor, and tuya smart control with on/off, dimming, CCT adjustable, time setting, records, voice control, master-slave control. Optics designed with SMD LED and prismatic diffuser to reach UGR<19. Clean backside with one external driver only.

Materials of Housing : Aluminium

Materials of Optics : PMMA

- ▶ 90° IP40 UGR<19
- ▶ DIM Flicker Free PIR Sensor WIFI Bluetooth Smart Lighting
- ▶ AC 180-265V PF≥0.9 CRI≥80
- ▶ SAA RoHS CE

| Code                    | Watt | Size(AxBxCmm) | Lumen(±5%) | N.W/pc(kgs) | Q'ty/CTN |
|-------------------------|------|---------------|------------|-------------|----------|
| PL006-6060-40W-WBS-I01  | 40W  | 595x595x8.5   | 4000lm     | 3.10        | 4PCS     |
| PL006-6262-40W-WBS-I01  | 40W  | 620x620x8.5   | 4000lm     | 3.50        | 4PCS     |
| PL006-30120-40W-WBS-I01 | 40W  | 1195x295x8.5  | 4000lm     | 3.10        | 4PCS     |

CCT — 2700K — 3000K — 6500K

Finish — White

Installation accessories — Suspension kit

# WiFi+Bluetooth

Smart Dual Protocol Panel **PL006-WBS-I01** Series

PIR Sensor — — Daylight Sensor



LED Panel light

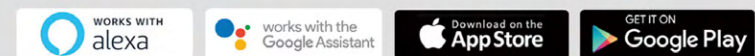



# PL-DP Panel light

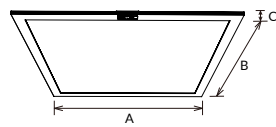

PL-DP is side-lit panel light is a ODM case with tuya IOT provider, with ODM UI. It is available with smart dimming, PIR sensor, photo sensor, and tuya smart control with on/off, dimming, CCT adjustable, time setting, records, voice control, electricity consumption. Optics designed with SMD LED and prismatic diffuser to reach UGR<19. Clean backside with external driver and controller.

Materials of Housing : Aluminium

Materials of Optics : PMMA

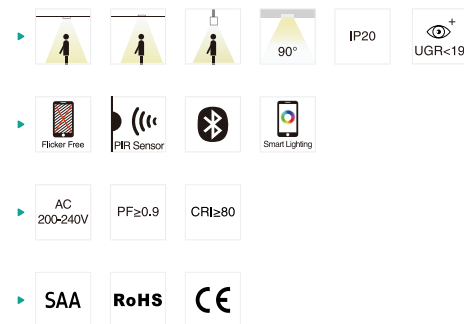

| Code           | Watt | Size(AxBxCmm) | Cut-out(±5mm) | Lumen(±5%) | N.W/pc(kgs) | Q'ty/CTN |
|----------------|------|---------------|---------------|------------|-------------|----------|
| PL6060-40W-DP  | 40W  | 595x595x8.5   | 580x580       | 4000lm     | 3.10        | 4PCS     |
| PL6262-40W-DP  | 40W  | 620x620x8.5   | 605x605       | 4000lm     | 3.50        | 4PCS     |
| PL30120-40W-DP | 40W  | 1195x295x8.5  | 1180x280      | 4000lm     | 3.10        | 4PCS     |

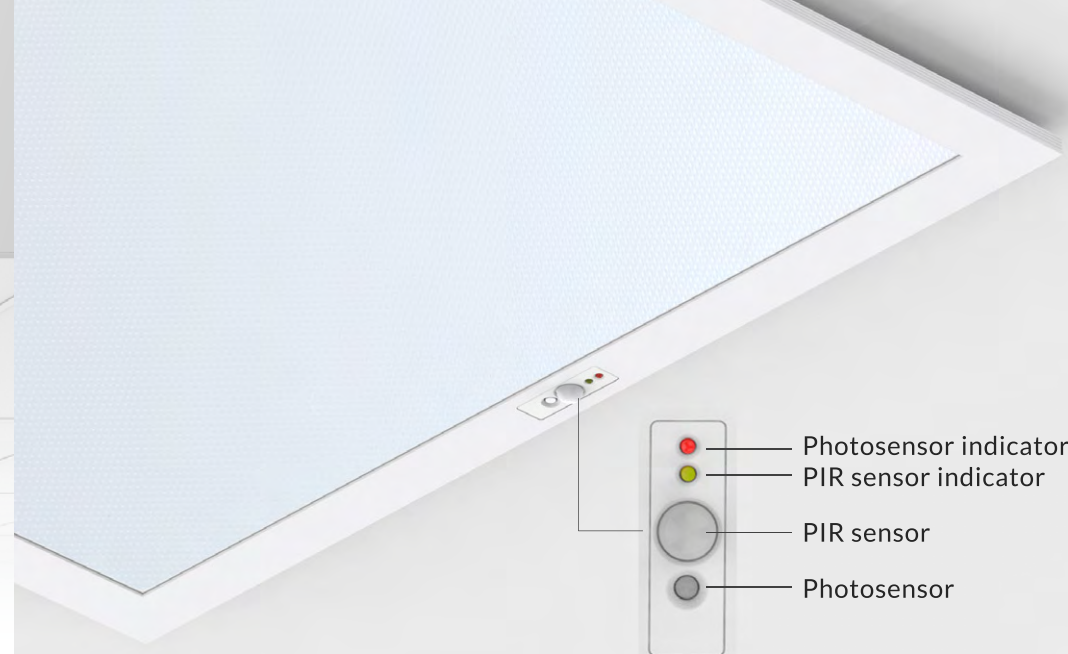
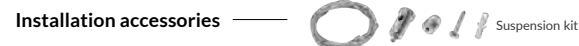

## PHOTOSENSOR

daylight harvest, change brightness according to the ambient

## PIR SENSOR

hold time & detection distance adjustable

## SMARTPHONE APP CONTROL

- CCT Adjustable
- Dimming
- Time setting
- Electricity consumption
- turn on/off sensors in App
- Self-test function
- Photosensor
- Record
- Scene setting

## STANDBY POWER<0.5W

# GL-P Panel light

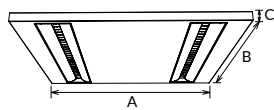

GL-P direct panel light is with anti-glare design UGR<19. Optics with lens and grille provides high lumen efficiency. External driver available with on/ off, triac, DALI and 0-10V.

Materials of Housing : PC+ABS / SPCC

Materials of Optics : PC

- 
- 
- 
- 
- 
- 
- 
- 
- 
- 
- 
- 
- 
- 
- 
- 
- 
- 

| Code          | Watt | Size(AxBxCmm) | Cut-out(±5mm) | Lumen(±5%) | N.W/pc(kgs) | Q'ty/CTN |
|---------------|------|---------------|---------------|------------|-------------|----------|
| GL6060-35W-P  | 35W  | 595x595x23.5  | 555x555       | 4450lm     | 3.50        | 4PCS     |
| GL6262-35W-P  | 35W  | 620x620x23.5  | 580x580       | 4450lm     | 3.65        | 4PCS     |
| GL30120-35W-P | 35W  | 295x1195x23.5 | 255x1155      | 4450lm     | 3.55        | 4PCS     |
| GL60120-60W-P | 60W  | 595*1195*23.5 | 555x1155      | 8000lm     | 6.80        | 2PCS     |

CCT ——— 3000K ——— 4000K ——— 5700K

Finish ——— White

Installation accessories ——— Suspension kit

# PL18 <sup>NEW</sup> Panel light

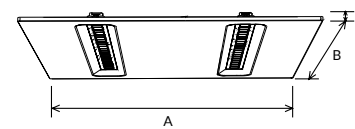

PL18 panel light is modular design easy to replacement, high lumen efficiency, 120lm/w@30W and 140lm/w@25W, louver reflectors design makes UGR<16, multiple installation: recessed, suspended, surface mounted and triac, 0-10V, DALI for option.

Materials of Housing : SPCC

Materials of Optics : PC+PET

- 
- 
- 
- 
- 
- 
- 
- 
- 
- 
- 
- 
- 
- 
- 
- 
- 

| Code          | Watt | Size(AxBxCmm) | Cut-out(mm) | Lumen(±5%) | N.W/pc(kgs) | Q'ty/CTN |
|---------------|------|---------------|-------------|------------|-------------|----------|
| PL18-6060-25W | 25W  | 595x595x31    | 570x570     | 3890lm     | 2.63        | 5PCS     |
| PL18-6060-30W | 30W  | 595x595x31    | 570x570     | 3795lm     | 2.63        | 5PCS     |

CCT ——— 3000K ——— 4000K ——— 5700K

Finish ——— White

Installation accessories ——— Suspension kit

# PL-AK Panel light

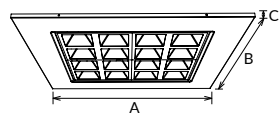

PL-AK panel light is a module design. Great optics design with SMD, reach low glare UGR<16, single CCT and 3CCT available. External driver available with on/ off, triac, DALI and 0-10V.

Materials of Housing : SPCC  
Materials of Optics : PC (Modular)

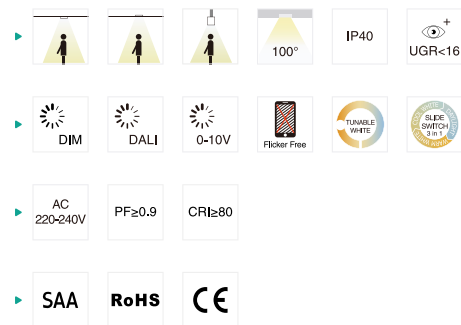

| Code           | Watt | Size(AxBxCmm) | Cut-out(±5mm) | Lumen(±5%) | N.W/pc(kgs) | Q'ty/CTN |
|----------------|------|---------------|---------------|------------|-------------|----------|
| PL3060-18W-AK  | 18W  | 595x295x36    | 580x280       | 2010lm     | 1.55        | 4PCS     |
| PL6060-25W-AK  | 25W  | 595x595x36    | 580x580       | 3552lm     | 2.90        | 4PCS     |
| PL6060-30W-AK  | 30W  | 595x595x36    | 580x580       | 3660lm     | 2.90        | 4PCS     |
| PL6060-36W-AK  | 36W  | 595x595x36    | 580x580       | 3900lm     | 2.90        | 4PCS     |
| PL6262-25W-AK  | 25W  | 620x620x36    | 605x605       | 3900lm     | 3.30        | 4PCS     |
| PL6262-30W-AK  | 30W  | 620x620x36    | 605x605       | 3560lm     | 3.30        | 4PCS     |
| PL6262-36W-AK  | 36W  | 620x620x36    | 605x605       | 3670lm     | 3.30        | 4PCS     |
| PL30120-25W-AK | 36W  | 1195x295x36   | 1180x280      | 3920lm     | 2.95        | 4PCS     |
| PL30120-30W-AK | 30W  | 1195x295x36   | 1180x280      | 3540lm     | 2.95        | 4PCS     |
| PL30120-36W-AK | 36W  | 1195x295x36   | 1180x280      | 3635lm     | 2.95        | 4PCS     |

CCT — 3000K — 4000K — 5700K

Finish — White

Installation accessories — Suspension kit

# PL008 Panel light

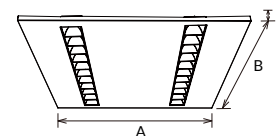

PL008 panel light is direct lighting with reflector design, reflector available with multiple colors, white, bright silver, matt silver, and black. Great optics design with SMD, reach low glare UGR<19 and high lumen efficiency up to 140lm/W, single CCT and 3CCT available. External driver available with on/ off, triac, DALI and 0-10V.

### Reflector



Materials of Housing : SPCC  
Materials of Optics : PC

| Code            | Watt | Size(AxBxCmm) | Cut-out(±5mm) | Lumen(±5%) | N.W/pc(kgs) | Q'ty/CTN |
|-----------------|------|---------------|---------------|------------|-------------|----------|
| PL008-3060-15W  | 15W  | 295x595x31.5  | 570x270       | 1800lm     | 1.47        | 5PCS     |
| PL008-6060-30W  | 30W  | 595x595x31.5  | 570x570       | 3600lm     | 2.70        | 5PCS     |
| PL008-6262-30W  | 30W  | 620x620x31.5  | 595x595       | 3600lm     | 2.90        | 5PCS     |
| PL008-30120-30W | 30W  | 295x1195x31.5 | 1170x270      | 3600lm     | 2.74        | 5PCS     |
| PL008-60120-55W | 55W  | 595x1195x31.5 | 1170x570      | 6700lm     | 5.28        | 2PCS     |
| PL008-3060-12W  | 12W  | 295x595x31.5  | 570x270       | 1700lm     | 1.47        | 5PCS     |
| PL008-6060-25W  | 25W  | 595x595x31.5  | 570x570       | 3550lm     | 2.70        | 5PCS     |
| PL008-6262-25W  | 25W  | 620x620x31.5  | 595x595       | 3550lm     | 2.90        | 5PCS     |
| PL008-30120-25W | 25W  | 295x1195x31.5 | 1170x270      | 3550lm     | 2.74        | 5PCS     |
| PL008-60120-40W | 40W  | 595x1195x31.5 | 1170x570      | 5700lm     | 5.28        | 2PCS     |

CCT — 3000K — 4000K — 5700K

Finish — White

Installation accessories — Suspension kit

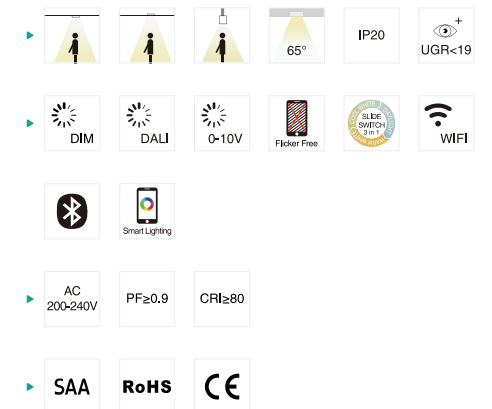



# PL-DE Panel light

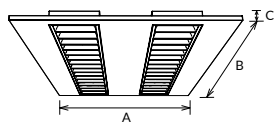

PL-DE panel light is direct lighting with modular design, prismatic diffuser and louver reflector replaceable, air-slot design and non-air slot design optional. Great optics design with SMD, reach low glare UGR<19. External driver available with on/ off, triac, DALI and 0-10V.

Materials of Housing : SPCC  
Materials of Optics : PS/PC+Aluminium

- ▶ 90° IP20 UGR<19
- ▶ DIM DALI 0-10V Flicker Free
- ▶ AC 220-240V PF≥0.9 CRI≥90
- ▶ SAA RoHS CE

| Code           | Watt | Size(AxBxCmm) | Cut-out(±5mm) | Lumen(±5%) | N.W/pc(kgs) | Q'ty/CTN |
|----------------|------|---------------|---------------|------------|-------------|----------|
| PL3060-13W-DE  | 13W  | 292x592x48    | 282x582       | 1495lm     | 2.10        | 4PCS     |
| PL6060-28W-DE  | 28W  | 1192x292x48   | 582x582       | 3360lm     | 4.10        | 4PCS     |
| PL30120-28W-DE | 28W  | 1192x392x48   | 282x1182      | 3360lm     | 3.84        | 4PCS     |
| PL40120-28W-DE | 28W  | 592x592x48    | 382x1182      | 3360lm     | 4.30        | 4PCS     |
| PL30150-40W-DE | 40W  | 1492x292x48   | 282x1482      | 4800lm     | 4.86        | 4PCS     |

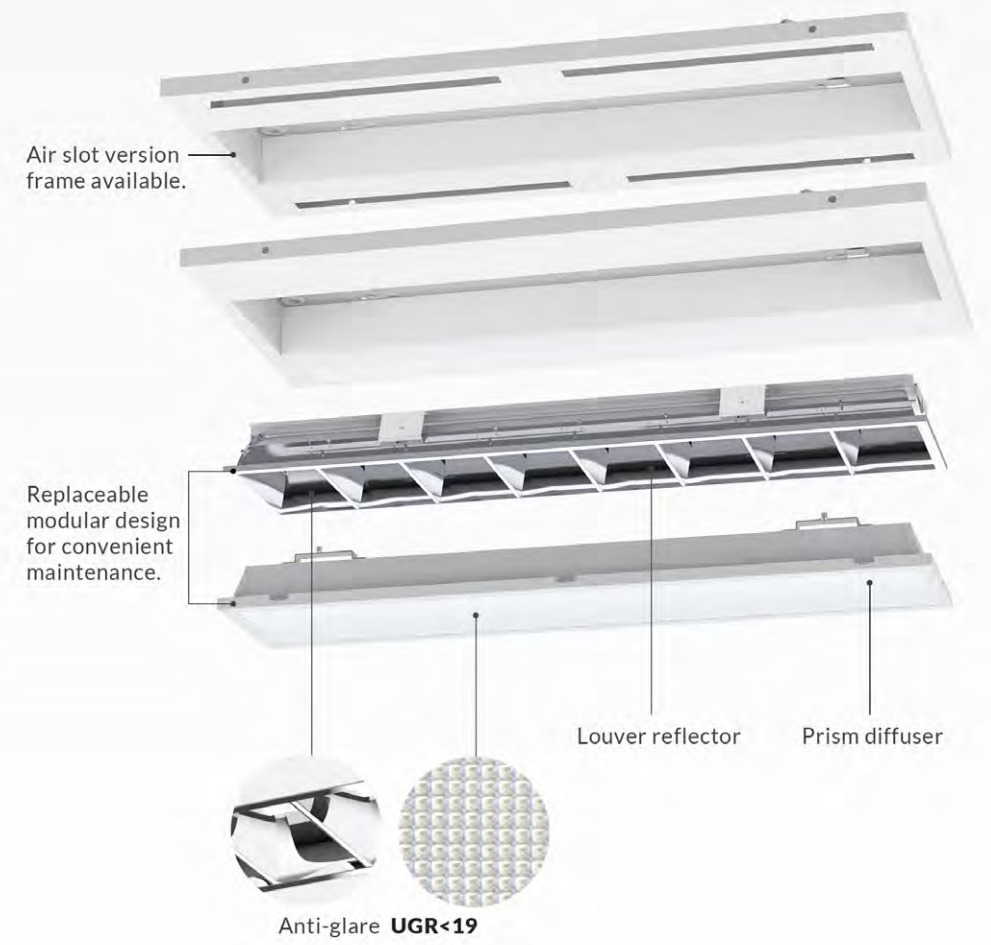

# PL-DE MODULAR DESIGN LED PANEL

Replaceable modular design for convenient maintenance

CCT — 3000K — 4000K — 5700K — Finish — White



# GL-AA Backlit Troffer light

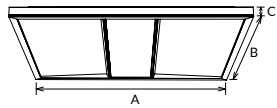

GL-AA backlit troffer is anti-glare design, the compact and seamless splicing make it a great looking. Optics with prismatic diffuser to reach UGR<19, interchangeable CCT available, high lumen efficiency 100lm/W and 125lm/W for options. External driver available with on/ off, triac, DALI and 0-10V.

Materials of Housing : Aluminium

Materials of Optics : PMMA(Lens)+PS(Diffuser)

- ▶ 90° IP20 UGR<19
- ▶ DIM DALI 0-10V Flicker Free TUNABLE WHITE SLIDE SWITCH 3 in 1
- ▶ CASAMBI
- ▶ AC 220-240V PF≥0.9 CRI≥80 TP(b)
- ▶ SAA RoHS CE

| Code           | Watt | Size(AxBxCmm) | Cut-out(±5mm) | Lumen(±5%) | N.W/pc(kgs) | Q'ty/CTN |
|----------------|------|---------------|---------------|------------|-------------|----------|
| GL6060-36W-AA  | 36W  | 595x595x40    | 570x570       | 3700lm     | 2.60        | 5PCS     |
| GL30120-36W-AA | 36W  | 1195x295x40   | 1170x270      | 3700lm     | 2.99        | 5PCS     |
| GL6262-36W-AA  | 36W  | 620x620x49    | 590x590       | 3700lm     | 2.73        | 5PCS     |
| GL60120-60W-AA | 60W  | 1195x595x49   | 1170x570      | 6500lm     | 5.41        | 2PCS     |
| GL6060-30W-AA  | 30W  | 595x595x40    | 570x570       | 4000lm     | 2.60        | 5PCS     |
| GL30120-30W-AA | 30W  | 1195x295x40   | 1170x270      | 3670lm     | 2.99        | 5PCS     |
| GL6262-30W-AA  | 30W  | 620x620x49    | 590x590       | 3980lm     | 2.73        | 5PCS     |
| GL60120-50W-AA | 50W  | 1195x595x49   | 1170x570      | 6670lm     | 5.41        | 2PCS     |

CCT ——— 3000K ——— 4000K ——— 5700K

Finish ——— White

Installation accessories ——— Suspension kit

# GL002 Troffer light

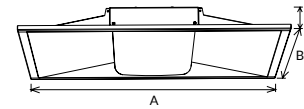

GL002 troffer light adopts secondary optical design and special diffuser to achieve uniform and softer light. Optics with high lumen SMD LED, reach luminous efficiency 105lm/W. External driver available with on/ off, triac, DALI and 0-10V.

Materials of Housing : SPCC

Materials of Optics : PMMA(Lens)+PC(Diffuser)

- ▶ 130° IP20
- ▶ DIM DALI 0-10V Flicker Free SLIDE SWITCH 3 in 1
- ▶ AC 220-240V PF≥0.9 CRI≥80
- ▶ SAA RoHS CE

| Code            | Watt | Size(AxBxCmm) | Lumen(±5%) | N.W/pc(kgs) | Q'ty/CTN |
|-----------------|------|---------------|------------|-------------|----------|
| GL002-6060-32W  | 32W  | 595x595x54    | 3800lm     | 2.37        | 4PCS     |
| GL002-30120-32W | 32W  | 295x1195x54   | 3800lm     | 2.53        | 4PCS     |

CCT ——— 3000K ——— 4000K ——— 5700K

Finish ——— White





# PL-DF Panel light

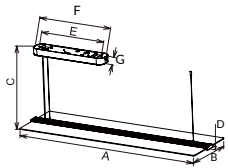

PL-DF panel light is frameless, transparent and 360 degree lighting design, which provides a great visual aesthetic feeling. Optics with high lumen SMD light source, reach anti-glare UGR<19. External driver in magnetic box provides convenient installation and available with on/ off, triac, and DALI.

Materials of Housing : Aluminium  
Materials of Optics : PMMA

- ▶
- ▶
- ▶
- ▶

| Code             | Watt | Size(AxBxCxDxExFxGmm)       | Lumen(±5%) | N.W/pc(kgs) | Q'ty/CTN |
|------------------|------|-----------------------------|------------|-------------|----------|
| PL35120-40W-DF   | 40W  | 1200x350x1500x19x422x480x43 | 4800lm     | 4.50        | 2PCS     |
| PL35120-40W-DF-D | 40W  | 1200x350x1500x19x422x480x43 | 4800lm     | 4.50        | 2PCS     |
| PL35120-60W-DF   | 60W  | 1200x350x1500x19x422x480x43 | 7300lm     | 4.50        | 2PCS     |

CCT — 3000K — 4000K — 5700K

Finish — White



# PL-DB Panel light

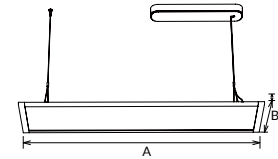

PL-DB panel light is up & down emitting panel, novel design without any screw make it a special and good looking panel. Optics design with anti-glare UGR<19 but without Prism plate. External driver in magnetic box provides convenient installation and available with on/ off, triac, and DALI

Materials of Housing : Aluminium  
Materials of Optics : PS (Diffuser) /PMMA (LGP)

- ▶
- ▶
- ▶
- ▶

| Code           | Watt | Size(AxBxCmm) | Lumen(±5%) | N.W/pc(kgs) | Q'ty/CTN |
|----------------|------|---------------|------------|-------------|----------|
| PL30120-30W-DB | 30W  | 1200x300x16.5 | 3060lm     | 3.76        | 2PCS     |
| PL30120-40W-DB | 40W  | 1200x300x16.5 | 4000lm     | 3.76        | 2PCS     |
| PL30120-50W-DB | 50W  | 1200x300x16.5 | 4950lm     | 3.76        | 2PCS     |

CCT — 3000K — 4000K — 5700K

Finish — White



Surface mounted

Recessed

Suspension

# DB15B Batten

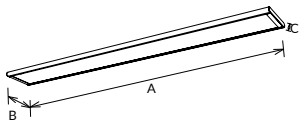

DB15B panel light is up & down design with 270° wide beam angle. Optics with side-lit SMD. External driver available with on/ off and triac dim.

Materials of Housing : Aluminium  
Materials of Optics : PS

- ▶ 110°  
 110°
- ▶ IP20
- ▶ DIM  
 Flicker Free
- ▶ AC 200-240V  
 PF ≥ 0.9  
 CRI ≥ 80
- ▶ SAA  
 RoHS  
 CE

| Code           | Watt | Size(AxBxCmm) | Lumen(±5%) | N.W/pc(kgs) | Q'ty/CTN |
|----------------|------|---------------|------------|-------------|----------|
| DB15B-600-20W  | 20W  | 600x148x17    | 1400lm     | 1.60        | 6PCS     |
| DB15B-900-30W  | 30W  | 900x148x17    | 2250lm     | 1.90        | 6PCS     |
| DB15B-1200-45W | 45W  | 1200x148x17   | 2790lm     | 2.30        | 6PCS     |

CCT — 3000K — 4000K — 5700K

Finish — White — Black

# PL-DR Backlit panel light

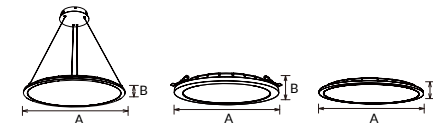

PL-DR direct lighting round panel, optics with SMD LED and PMMA lens reach uniform light output, non UGR and UGR<19 for option. Installation available with surface, recessed with plate, recessed with clips, and pendant installation. External driver available with on/ off, triac, DALI and 0-10V.

Materials of Housing : Aluminium  
Materials of Optics : PMMA(Lens)+PS(Diffuser)

- ▶ 120°
- ▶ IP20  
 UGR < 19
- ▶ DIM  
 DALI  
 0-10V  
 Flicker Free
- ▶ AC 200-240V  
 PF ≥ 0.9  
 CRI ≥ 80
- ▶ SAA  
 RoHS  
 CE

| Code         | Watt | Size(AxBmm) | Cut-out(±5mm) | Lumen(±5%) | N.W/pc(kgs) | Q'ty/CTN |
|--------------|------|-------------|---------------|------------|-------------|----------|
| PL300-18W-DR | 18W  | Ø300x13.8   | -             | 1980lm     | 1.44        | 4PCS     |
| PL400-25W-DR | 25W  | Ø400x13.8   | Ø200-240      | 2750lm     | 1.92        | 4PCS     |
| PL400-35W-DR | 35W  | Ø400x13.8   | Ø200-240      | 4000lm     | 1.92        | 4PCS     |
| PL500-30W-DR | 30W  | Ø500x13.8   | Ø200-240      | 3960lm     | 2.50        | 4PCS     |
| PL500-35W-DR | 35W  | Ø500x13.8   | Ø200-240      | 4300lm     | 2.50        | 4PCS     |
| PL600-35W-DR | 35W  | Ø600x13.8   | Ø200-240      | 4300lm     | 3.26        | 2PCS     |
| PL600-45W-DR | 45W  | Ø600x13.8   | Ø200-240      | 5950lm     | 3.26        | 2PCS     |
| PL600-55W-DR | 55W  | Ø600x13.8   | Ø200-240      | 6650lm     | 3.26        | 2PCS     |

CCT — 3000K — 4000K — 5700K

Finish — White



# PL-DG Panel light

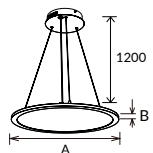

PL-DG round pendant panel light translucent up & down lighting design. It adopts SMD LED, high quality diffuser and 3.0T PMMA light guide plate which provide a high transmittance rate and uniform light. External driver available with on/ off, triac, DALI and 0-10V.

- ▶ 120° / 120° 35% / 65% IP20
- ▶ DIM DALI 0-10V Flicker Free
- ▶ AC 220-240V PF≥0.9 CRI≥80
- ▶ SAA RoHS CE

Materials of Housing : Aluminium  
Materials of Optics : PMMA+PS

| Code          | Watt | Size(AxBmm) | Lumen(±5%) | N.W/pc(kgs) | Q'ty/CTN |
|---------------|------|-------------|------------|-------------|----------|
| PL3012-18W-DG | 18W  | Ø300x11.5   | 1820lm     | 1.25        | 5PCS     |
| PL4012-35W-DG | 35W  | Ø400x11.5   | 3605lm     | 1.75        | 4PCS     |
| PL5012-40W-DG | 40W  | Ø500x11.5   | 4120lm     | 2.25        | 4PCS     |
| PL6012-60W-DG | 60W  | Ø600x11.5   | 6210lm     | 3.15        | 2PCS     |

CCT ——— 3000K ——— 4000K ——— 5700K

Finish ——— White

# PL-DG PENDANT LED ROUND PANEL

UP & DOWN translucent lighting 35%:65%



Slim transparent body design

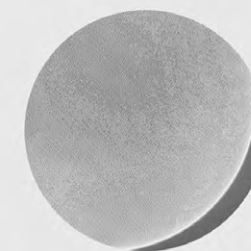

PMMA LGP



Translucent lighting area can offer a great decorative effect

LED Panel light

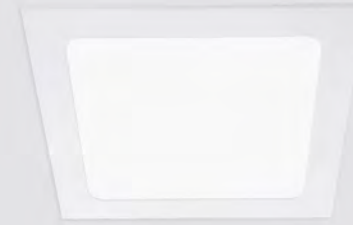

# PL-W Panel light

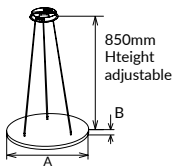

PL-W round pendant panel light with side-lighting design. Optics with high quality diffuser and 3T PMMA LGP. 300mm, 400mm, 500mm, 600mm and 780mm diameter for options. Various installation ways with suspended, surface mounted and recessed. External driver available with on/ off, triac, DALI and 0-10V.

Materials of Housing : Aluminium  
Materials of Optics : PMMA (LGP)

- IP40
- 120°
- DIM
- DALI
- 0-10V
- Flicker Free
- AC 100-240V
- AC 200-240V
- PF≥0.9
- CRI≥80
- SAA
- RoHS
- CE
- TUV

| Code         | Watt | Size(AxBmm) | Lumen(±5%) | N.W/pc(kgs) | Q'ty/CTN |
|--------------|------|-------------|------------|-------------|----------|
| PL3012-18W-W | 18W  | Ø300x12     | 1560lm     | 2.50        | 5PCS     |
| PL4012-25W-W | 25W  | Ø400x12     | 2070lm     | 3.10        | 4PCS     |
| PL4012-35W-W | 35W  | Ø400x12     | 2900lm     | 3.10        | 4PCS     |
| PL5012-30W-W | 30W  | Ø500x12     | 2520lm     | 4.20        | 4PCS     |
| PL5012-35W-W | 35W  | Ø500x12     | 2900lm     | 4.20        | 4PCS     |
| PL6012-35W-W | 35W  | Ø600x12     | 3040lm     | 4.34        | 2PCS     |
| PL6012-45W-W | 45W  | Ø600x12     | 3600lm     | 4.34        | 2PCS     |
| PL8012-60W-W | 60W  | Ø780x20     | 5430lm     | 6.10        | 2PCS     |
| PL8012-80W-W | 80W  | Ø780x20     | 7460lm     | 6.90        | 2PCS     |

CCT — 3000K — 4000K — 5700K

Finish — White

# PL-DD Panel light

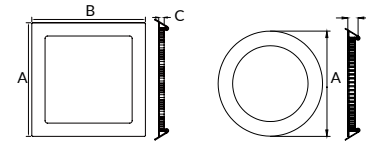

PL-DD small round & square panel with complete diameter options. Optics with 2835SMD LED chip and PMMA LGP offer a great light transmittance and light output. External driver available with on/ off, triac, DALI and 0-10V.

Materials of Housing : Aluminium  
Materials of Optics : PS(Diffuser)+PMMA(LGP)

- IP20
- 120°
- DIM
- DALI
- 0-10V
- Flicker Free
- AC 200-240V
- PF≥0.9
- CRI≥80
- SAA
- RoHS
- CE

| Code          | Watt | Size(AxBxCmm) | Cut-out(±5mm) | Lumen(±5%) | N.W/pc(kgs) | Q'ty/CTN |
|---------------|------|---------------|---------------|------------|-------------|----------|
| PL1212-7W-DD  | 7W   | 120x120x21    | 105x105       | 580lm      | 0.24        | 36PCS    |
| PL1515-9W-DD  | 9W   | 146x146x21    | 127x127       | 810lm      | 0.28        | 24PCS    |
| PL1717-12W-DD | 12W  | 171x171x21    | 155x155       | 1070lm     | 0.34        | 20PCS    |
| PL2222-18W-DD | 18W  | 224x224x21    | 205x205       | 1580lm     | 0.52        | 12PCS    |
| PL3030-24W-DD | 24W  | 300x300x21    | 277x277       | 2500lm     | 0.88        | 12PCS    |
| PL1221-7W-DD  | 7W   | Ø120x21       | Ø108-113      | 580lm      | 0.20        | 36PCS    |
| PL1521-9W-DD  | 9W   | Ø145x21       | Ø127-133      | 810lm      | 0.24        | 24PCS    |
| PL1721-12W-DD | 12W  | Ø170x21       | Ø157-162      | 1050lm     | 0.29        | 20PCS    |
| PL2021-15W-DD | 15W  | Ø200*21       | Ø177-182      | 1470lm     | 0.35        | 12PCS    |
| PL2221-18W-DD | 18W  | Ø224x21       | Ø205-212      | 1680lm     | 0.42        | 12PCS    |
| PL2421-22W-DD | 22W  | Ø238*21       | Ø224-228      | 2150lm     | 0.50        | 12PCS    |
| PL3021-24W-DD | 24W  | Ø300x21       | Ø282-288      | 2500lm     | 0.71        | 12PCS    |

CCT — 3000K — 4000K — 5700K

Finish — White

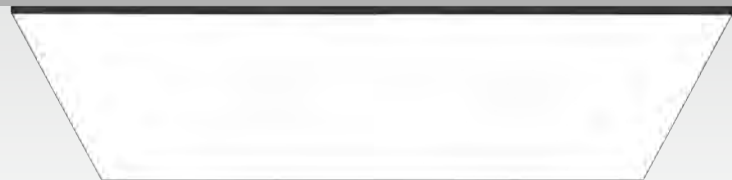

# PL-EA Panel light



PL-EA large size panel with simple and elegant design. Optics with CRI $\geq$ 90 SMD LED and secondary light distribution design, reach UGR $<$ 19, fireproof B1 grade soft film as luminous cover and 0.5mm thickness backboard make this panel looks very reliable. External driver available with DALI and 0-10V.

Materials of Housing : Aluminium

Materials of Optics : PVC Soft film

- ▶
- ▶
- ▶
- ▶

| Code             | Watt | Size(AxBxCmm) | Lumen( $\pm$ 5%) | N.W/pc(kgs) | Q'ty/CTN |
|------------------|------|---------------|------------------|-------------|----------|
| PL120120-60W-EA  | 60W  | 1200x1200x110 | 4800lm           | 11          | 1PCS     |
| PL120240-120W-EA | 120W | 1200x2400x110 | 9600lm           | 21          | 1PCS     |
| PL120300-180W-EA | 180W | 1200x3000x110 | 14400lm          | 27          | 1PCS     |
| PL150150-80W-EA  | 80W  | 1500x1500x110 | 6400lm           | 17          | 1PCS     |
| PL150300-240W-EA | 240W | 1500x3000x110 | 19200lm          | 34          | 1PCS     |

CCT ——— 3000K ——— 4000K ——— 5700K

Finish ——— Black

Installation accessories

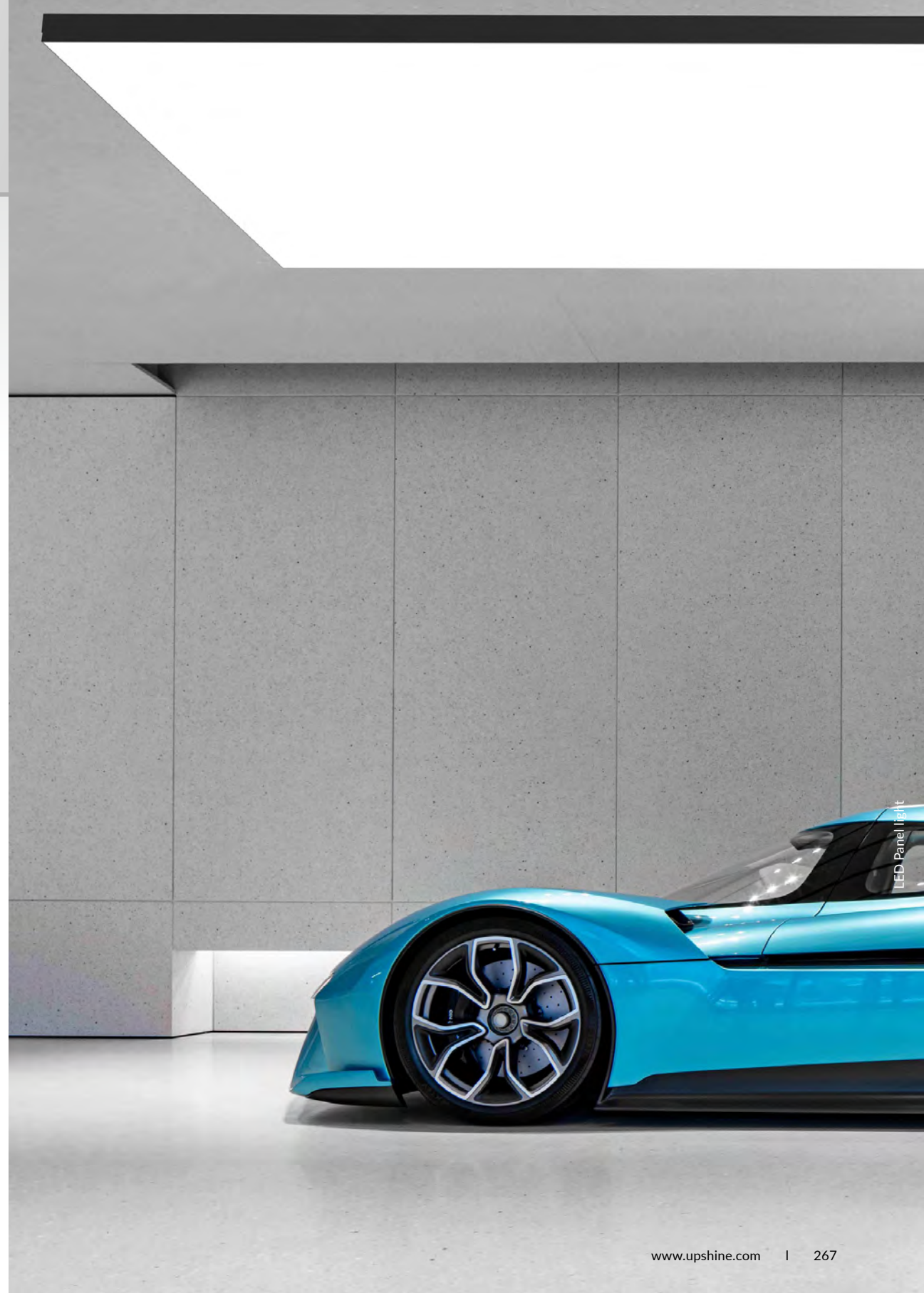
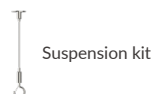

# Panel Light installation accessories

## Assembled surface mounted frame



CF01



CF13



## DIY surface mounted frame



CF04



CF11



CF06

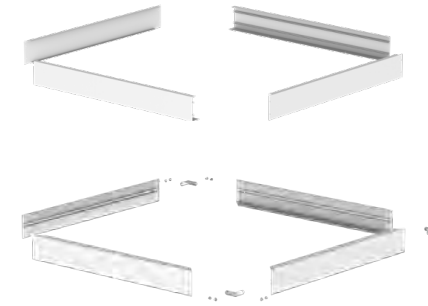

## Assembled embedded mounted frame



RF01



RF02



## Suspending Kits



## Recessed Installation Clips



## Integrated Recessed Installation Clips





# OL02 LED freestanding luminaire

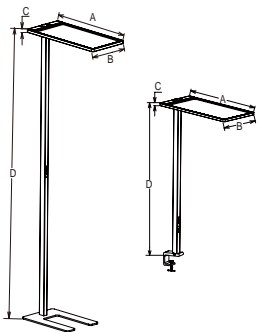

OL02 free standing luminaire is up & down panel design, available with standing and desk version. OL02A with USB, OL02B without USB version. Function available with touchable 0-10V dimmer, PIR sensor function, and light sensor. Optics with high quality SMD LED, reach UGR<14.

Materials of Housing : Aluminium  
Materials of Optics : PMMA

- ▶ 75%  
25% UGR<14
- ▶
- ▶
- ▶

| Code            | Watt | Size(AxBxCxDmm)   | Lumen(±5%) | N.W/pc(kgs)   | Q'ty/CTN               |
|-----------------|------|-------------------|------------|---|------------------------|
| OL02/B-75W-DOS  | 75W  | 720x340x21.5x1900 | 8200lm     | Flat lamp body:2.70<br>Lamp pole:3.10<br>Lamp base:6.70 | 6PCS<br>6PCS<br>2x3PCS |
| OL02C/D-75W-DOS | 75W  | 720x340x21.5x1188 | 8200lm     | Flat lamp body:2.70<br>Lamp pole:3.00                   | 6PCS<br>6PCS           |

CCT — 3000K — 4000K — 5700K

Finish — White Black

- Indirect lighting and direct lighting (500~700LUX on the desk)
- PMMA LGP with Prismatic diffuser to achieve UGR<14 ideal for office lighting.

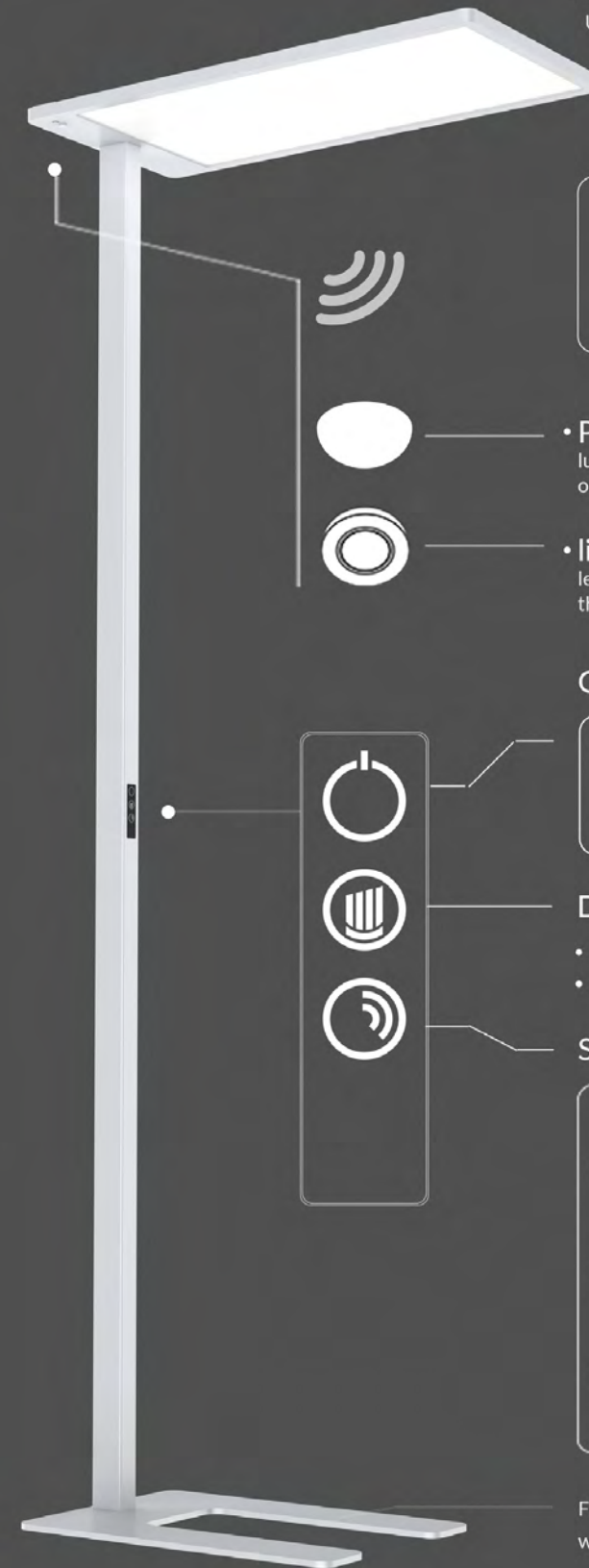

## STATUS

|  |  |  |  |  |  |     |
|--|--|--|--|--|--|-----|
|  |  |  |  |  |  | ON  |
|  |  |  |  |  |  | OFF |

- **PIR sensor** detector automatically switches the luminaire on and then switches it off when there is no one in the room.
- **light sensor** continuously measures the illuminance level on the desk and dims the light itself depending on the amount of available daylight and artificial lighting.

## ON/OFF

|  |   |  |                |
|--|---|--|----------------|
|  | Factory setting:<br>Dimming 50%Light,<br>sensor and PIR<br>sensor in ON status. |  | Turn<br>ON/OFF |
|--|---|--|----------------|

## Dimming button

- Short press in 1s, brightness will increase/ decrease 5%
- Long press brightness will increase/ decrease continually

## Sensor

|  |   |  |   |  |  |  |  |  |  |
|--|---|--|---|--|--|--|--|--|--|
|  | > |  | > |  |  |  |  |  |  |
|  | > |  | > |  |  |  |  |  |  |
|  | > |  | > |  |  |  |  |  |  |

Flat lamp base with reliable stability? saving space and widely work with office furniture



## OL06 LED freestanding luminaire

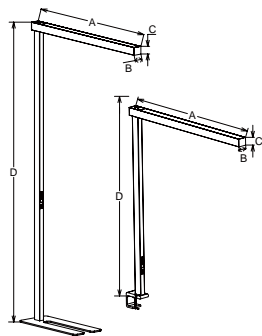

OL06 free standing luminaire is up & down reflector design, available with standing and desk version. OL06A is for floor standing, OL06B is for desk installation, OL06C is for floor standing with smart control, OL06D is for desk installation with with smart control. Optics with SMD and reflector design, UGR<16, 125lm/W high light efficiency. Function with 0-10V dimmer, light sensor, PIR sensor module and USB connector.

Materials of Housing : Aluminium  
Materials of Optics : PC / PET



| Code           | Watt | Size(AxBxCxDmm) | Lumen(±5%) | N.W/pc(kgs)                                     | Q'ty/CTN     |
|----------------|------|-----------------|------------|---|--------------|
| OL06A-80W -DOS | 80W  | 1060x60x53x2026 | 10500lm    | Flat lamp body+Lamp pole:5.70<br>Lamp base:6.80 | 3PCS<br>3PCS |
| OL06B-80W-DOS  | 80W  | 1060x60x53x1276 | 10500lm    | 5.10  | 3PCS         |
| OL06C-85W-B    | 85W  | 1060x60x53x2026 | 10500lm    | Flat lamp body+Lamp pole:5.70<br>Lamp base:6.80 | 3PCS<br>3PCS |
| OL06C-75W-B1   | 75W  | 1060x60x53x2026 | 10500lm    | Flat lamp body+Lamp pole:5.70<br>Lamp base:6.80 | 3PCS<br>3PCS |
| OL06D-85W-B    | 85W  | 1060x60x53x1276 | 10500lm    | 5.10  | 3PCS         |
| OL06D-75W-B1   | 75W  | 1060x60x53x1276 | 10500lm    | 5.10  | 3PCS         |

CCT — 3000K — 4000K — 5700K

Finish — White

## OL07 LED freestanding luminaire

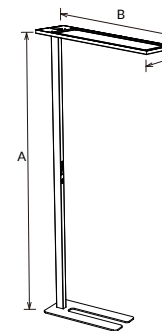

OL07 free standing luminaire is up & down panel design. OL07A is professional version, OL07B is intelligent version with Casambi dimming. OL07A professional version could be 0-10V dim, PIR sensor and daylight sensor, with/ without USB version for option. OL07B intelligent version is smart dim by Casambi. 120 degree beam angle and UGR<16 could provide uniform lighting performance. Optics with UGR<16 and high lumen up to 12,000lm.

Materials of Housing : Aluminium  
Materials of Optics : PMMA/PC

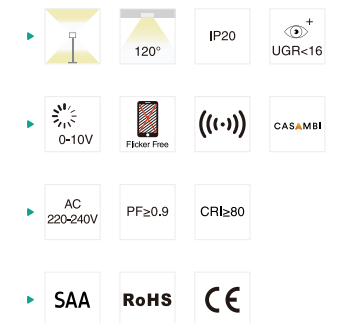

| Code           | Watt | Size(AxBxCmm) | Lumen(±5%) | N.W/pc(kgs) | Q'ty/CTN |
|----------------|------|---------------|------------|-------------|----------|
| OL07A-75W-DOS  | 75W  | 1925x920x300  | 7500lm     | 14          | 3PCS     |
| OL07A-100W-DOS | 100W | 1925x920x300  | 10000lm    | 14          | 3PCS     |
| OL07B-85W-B    | 85W  | 1925x920x300  | 8500lm     | 14          | 3PCS     |
| OL07B-100W-B   | 100W | 1925x920x300  | 10000lm    | 14          | 3PCS     |
| OL07B-75W-B1   | 75W  | 1925x920x300  | 7500lm     | 14          | 3PCS     |
| OL07B-100W-B1  | 100W | 1925x920x300  | 10000lm    | 14          | 3PCS     |

CCT — 3000K — 4000K — 5000K

Finish — White





# OL01 LED freestanding luminaire

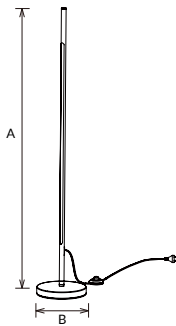

OL01 free standing luminaire combines modern industrial style, the unique shape and simple design perfectly fit the aesthetic concept of modern society. It adopts Tuya WIFI+2.4G intelligent technology, create various atmospheres, can switch to different lighting scenes according to your needs. The slender body, plug and play, makes it convenient for different position.

Materials of Housing : Aluminium  
Materials of Optics : PC

- ▶ 120° IP20
- ▶ Flicker Free
- ▶ AC 200-240V PF≥0.9 CRI≥80
- ▶ SAA RoHS CE

| Code         | Watt | Size(AxBmm) | Lumen(±5%) | N.W/pc(kgs)               | Q'ty/CTN      |
|--------------|------|-------------|------------|---------------------------|---------------|
| OL01-15W -WG | 15W  | 1600x182    | 1400lm     | Base:2.2<br>Lamp Body:0.6 | 6PCS<br>18PCS |

CCT ——— 3000K ——— 4000K ——— 5700K

Finish ——— White Black



LED Freestanding Luminaire



# LED Linear & Batten Light

/Series/

LED batten series and linear light are more and more popular nowadays. The original design concept is to replace the LED tube. But LED batten is more decorative and elegant, while it also maintains high lumen efficiency. UPSHINE is committed to the design and development of LED battens for many years. Multiple functions are updated constantly: UGR<19, 100lm/W, 120lm/W, lighting up&down, as well as DALI or 0-10v dimmable system. Surface mounted, suspended and wall mounted are all available.

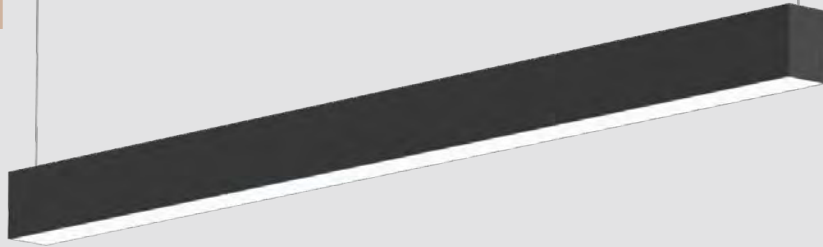

# DB77A Linear light

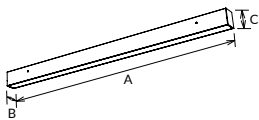

DB77A is a seamless splicing design with straight/ corner/cross splicing connector. Two lamp cover options: Standard cover and anti-glare cover. Adopt high lumen SMD light source, flicker free and high efficiency driver make a better lumen. Functions: Down lighting, up&down lighting, adjustable CCT, emergency and sensor. Multiple installation: pendant/surface mounted/wall mounted/ recessed/track. Modular design: replaceable driver and emergency module.

Materials of Housing : Aluminium  
Materials of Optics : PC

| Code           | Watt    | Size(AxBxCmm) | Lumen(±5%) | N.W/pc(kgs) | Q'ty/CTN |
|----------------|---------|---------------|------------|-------------|----------|
| DB77A-600-17W  | 17W     | 602x57x76     | 1680lm     | 1.70        | 6PCS     |
| DB77A-600-22W  | 17W+5W  | 602x57x76     | 2250lm     | 1.70        | 6PCS     |
| DB77A-1200-36W | 36W     | 1212x57x76    | 3850lm     | 2.70        | 6PCS     |
| DB77A-1200-45W | 36W+9W  | 1212x57x76    | 4850lm     | 2.70        | 6PCS     |
| DB77A-1500-45W | 45W     | 1512x57x76    | 4850lm     | 3.50        | 6PCS     |
| DB77A-1500-56W | 45W+11W | 1512x57x76    | 6000lm     | 3.50        | 6PCS     |

CCT ——— 3000K ——— 4000K ——— 5700K

Installation accessories ——— Suspension kit

Finish ——— White Black

Recessed ACC-DB66-0300 Suspended with ceiling plate ACC-0200 Track ACC-DB77A-0500

# DB77A | DIFFUSER TYPE

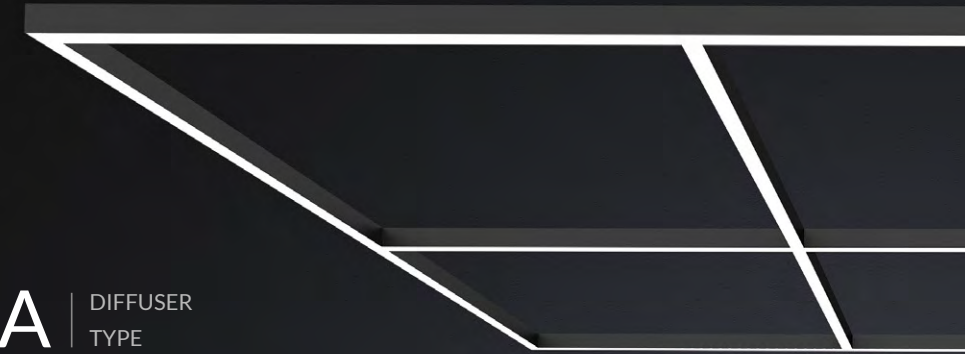

Upper Glowing Accessories

Connection accessories

LED Linear & Batten light

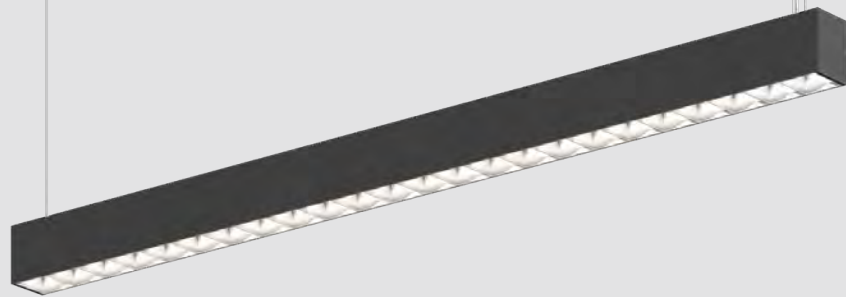

**DB77B** | GRILL REFLECTOR  
UGR<19

# DB77B Linear light

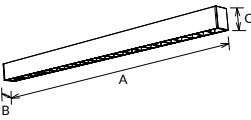

DB77B is a UGR<19 SMD linear light with reflector design, The splicing with L/T/X node connector, making a very convenient connection. It can be down lighting (CCT changeable is optional) or up&down lighting. Functions: 1-10V/DALI dimming, emergency. Multiple installation: surface mounted/Recessed/Suspending.

- ▶ 65° IP20
- ▶ DIM DALI 1-10V Flicker Free SLIDE SWITCH 3 in 1
- ▶ AC 220-240V PF≥0.9 CRI≥80
- ▶ SAA RoHS CE

Materials of Housing : Aluminium  
Materials of Optics : PC

| Code           | Watt | Size(AxBxCmm) | Lumen(±5%) | N.W/pc(kgs) | Q'ty/CTN |
|----------------|------|---------------|------------|-------------|----------|
| DB77B-1200-36W | 36W  | Ø1212x57x76   | 3650lm     | 2.30        | 6PCS     |
| DB77B-1200-48W | 48W  | Ø1212x57x76   | 4850lm     | 2.30        | 6PCS     |
| DB77B-1500-45W | 45W  | Ø1512x57x76   | 4550lm     | 2.80        | 6PCS     |
| DB77B-1500-60W | 60W  | Ø1512x57x76   | 6100lm     | 2.80        | 6PCS     |
| DB77B-1800-54W | 54W  | Ø1812x57x76   | 5500lm     | 3.40        | 6PCS     |
| DB77B-1800-65W | 65W  | Ø1812x57x76   | 6600lm     | 3.40        | 6PCS     |
| DB77B-2400-72W | 72W  | Ø2412x57x76   | 7300lm     | 4.50        | 2PCS     |
| DB77B-2400-96W | 96W  | Ø2412x57x76   | 9700lm     | 4.50        | 2PCS     |

CCT ——— 3000K 4000K 5700K      Finish ——— White Black

Installation accessories ——— Suspension kit   Recessed ACC-DB66-0300   Suspended with ceiling plate ACC-DB66-0200   Track ACC-DB77A-0500

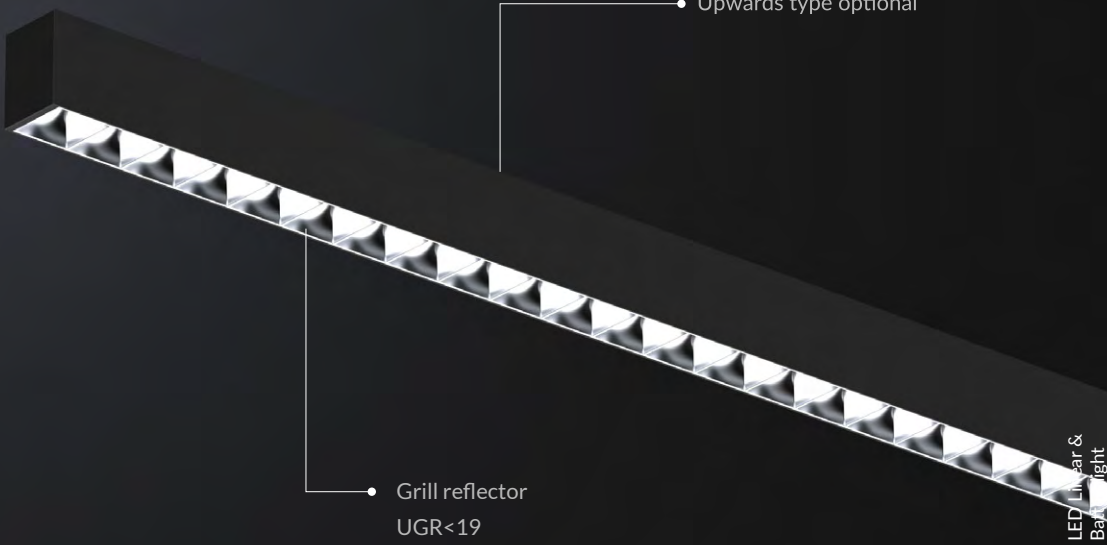

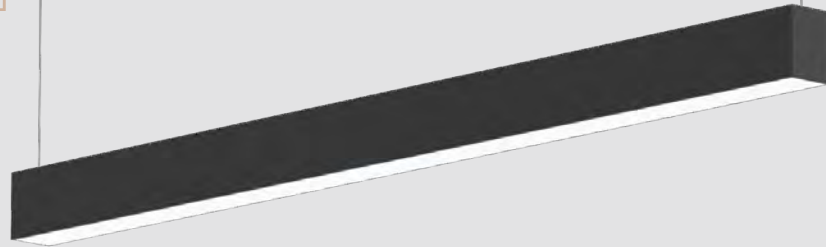

# DB66 Linear light

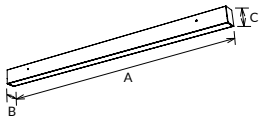

DB66A/B is a new linkable design light. Adopt high lumen efficiency SMD LED. Pendant/surface mounted/wall mounted installation available. Up and down light effect for wall mounted and pendant installation. Interchangeable CCT, DALI/0-10V dimming for options. Tridonic DALI driver available.

- ▶
- ▶
- 
- ▶
- ▶

Materials of Housing : Aluminium  
Materials of Optics : PC

| Code           | Watt | Size(AxBxCmm) | Lumen(±5%)    | N.W/pc(kgs) | Q'ty/CTN |
|----------------|------|---------------|---------------|-------------|----------|
| DB66A-1200-36W | 36W  | 1204x56x75    | 3950lm/4800lm | 2.75        | 6PCS     |
| DB66A-1200-50W | 50W  | 1204x56x75    | 6200lm/6400lm | 2.75        | 6PCS     |
| DB66A-1500-42W | 42W  | 1504x56x75    | 4750lm/5400lm | 3.35        | 6PCS     |
| DB66A-1500-60W | 60W  | 1504x56x75    | 6450lm/7500lm | 3.35        | 6PCS     |
| DB66B-1200-36W | 36W  | 1204x56x75    | 3950lm/4300lm | 2.75        | 6PCS     |
| DB66B-1200-50W | 50W  | 1204x56x75    | 5300lm/6400lm | 2.75        | 6PCS     |
| DB66B-1500-42W | 42W  | 1504x56x75    | 4600lm/4800lm | 3.35        | 6PCS     |
| DB66B-1500-60W | 60W  | 1504x56x75    | 6600lm/7600lm | 3.35        | 6PCS     |

CCT — 3000K — 4000K — 5700K      Finish — White Black

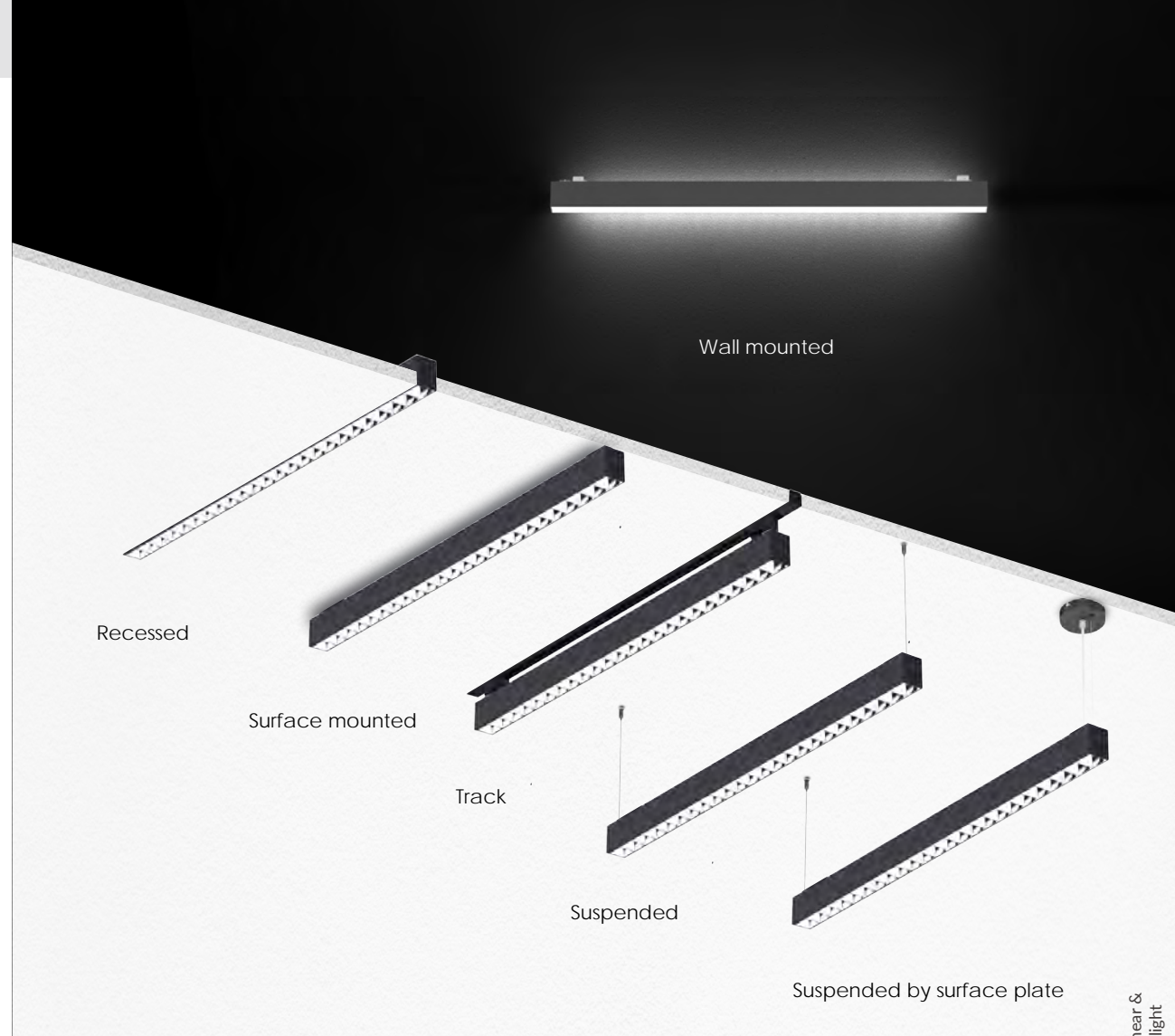

## Multi-installation

LED Linear & Batten light

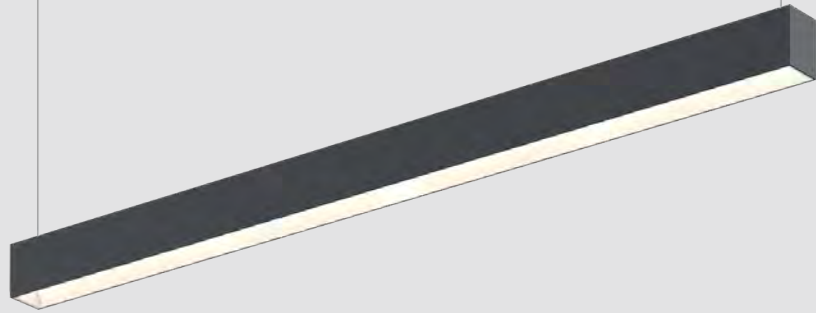

## DB66D Linear light

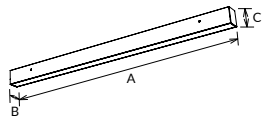

The DB66D is a new model upgraded based on DB66A, it adopts super high lumen efficiency SMD LED reach 140lm/w. Internal structure is special designed to control glare light achieve UGR<19. It also available with linking, DIY with up lighting module, 6 various installation methods.

Materials of Housing : Aluminium  
Materials of Optics : PC

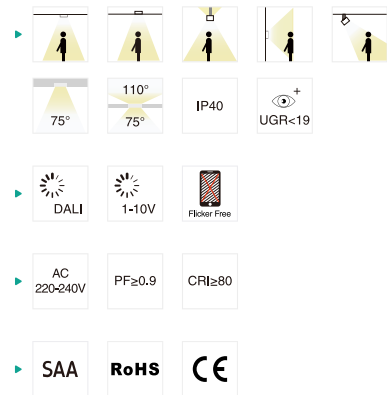

| Code           | Watt | Size(AxBmm) | Cut-out(mm) | Lumen(±5%) | N.W/pc(kgs) | Q'ty/CTN |
|----------------|------|-------------|-------------|------------|-------------|----------|
| DB66D-1200-28W | 28W  | 1204x56x75  | 1208x65     | 4000lm     | 2.75        | 6PCS     |
| DB66D-1200-40W | 40W  | 1204x56x75  | 1208x65     | 5550lm     | 2.75        | 6PCS     |
| DB66D-1500-35W | 35W  | 1504x56x75  | 1508x65     | 5100lm     | 3.35        | 6PCS     |
| DB66D-1500-49W | 49W  | 1504x56x75  | 1508x65     | 6850lm     | 3.35        | 6PCS     |

CCT ——— 3000K ——— 4000K ——— 5700K      Finish ——— White ——— Black

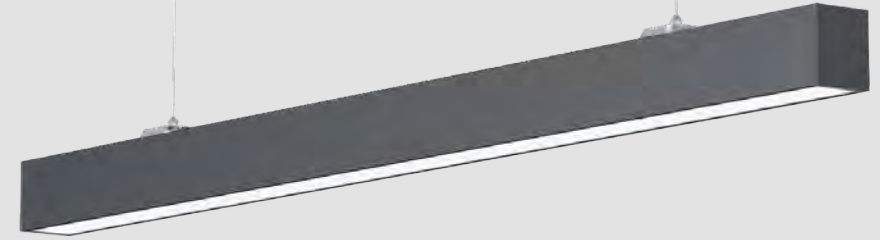

## DB158 Linear light

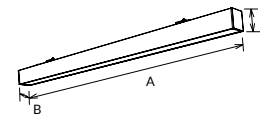

DB158 LED Linear Light is a perfect replacement for traditional tube. It adopt high lumen SMD light source, CCT changeable by dip switch. Loop in and loop out design, fast and convenient wiring. Flicker free driver. Support surface mounted and suspending installations.

Materials of Housing : Aluminium  
Materials of Optics : PS



| Code            | Watt | Size(AxBxCmm) | Lumen(±5%) | N.W/pc(kgs) | Q'ty/CTN |
|-----------------|------|---------------|------------|-------------|----------|
| DB158-1200-30W  | 30W  | 1200x58.6x70  | 3400lm     | 1.55        | 6PCS     |
| DB158-1200-40W  | 40W  | 1200x58.6x70  | 4400lm     | 1.55        | 6PCS     |
| DB158-1500-40W  | 40W  | 1500x58.6x70  | 4400lm     | 1.96        | 6PCS     |
| DB158-1500-60W  | 60W  | 1500x58.6x70  | 6300lm     | 1.96        | 6PCS     |
| DB158B-1200-30W | 30W  | 1200x58.6x70  | 3400lm     | 1.55        | 6PCS     |
| DB158B-1200-40W | 40W  | 1200x58.6x70  | 4400lm     | 1.55        | 6PCS     |
| DB158B-1500-40W | 40W  | 1500x58.6x70  | 4400lm     | 1.96        | 6PCS     |
| DB158B-1500-60W | 60W  | 1500x58.6x70  | 6300lm     | 1.96        | 6PCS     |

CCT ——— 3000K ——— 4000K ——— 5700K      Finish ——— White ——— Black



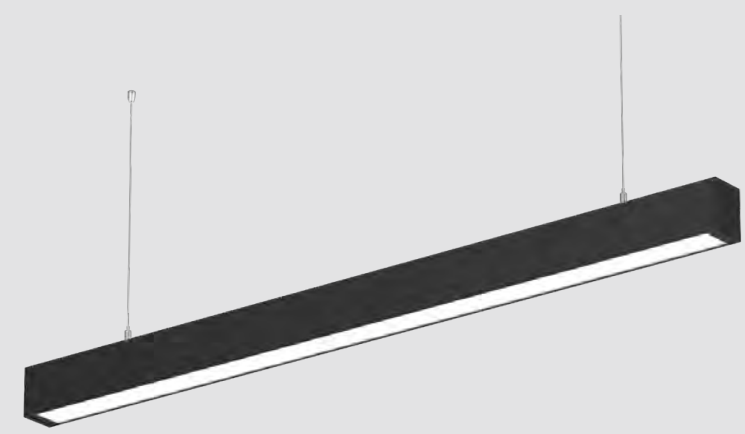
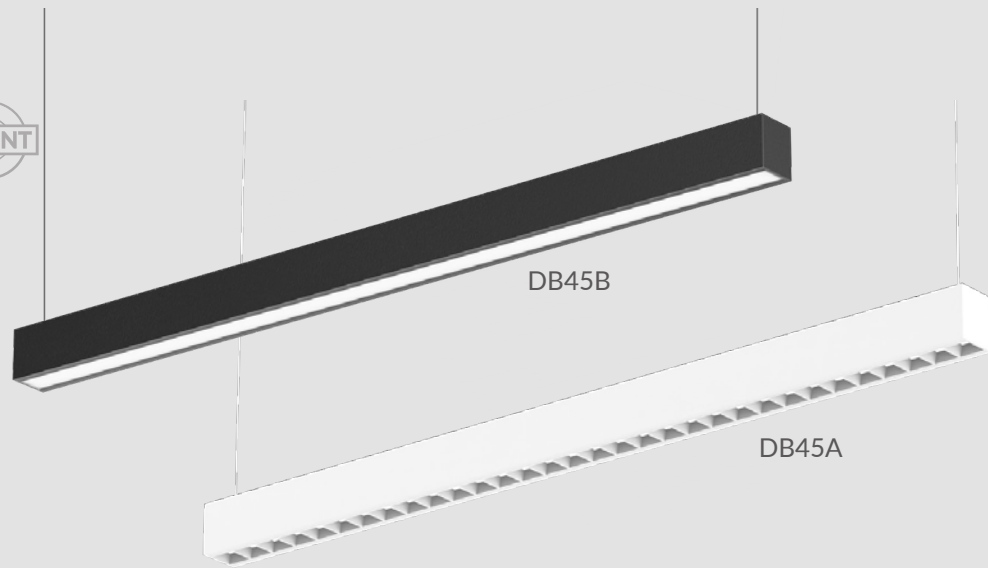

# DB45A/B Linear light

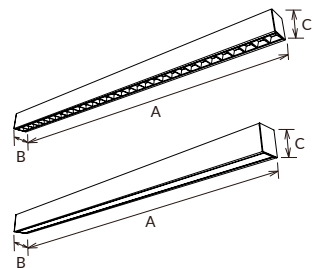

Module changeable design LED batten DB45 provides good heat dissipation, quality light and substantial energy saving. Suspended, surface mounted and splicing installation optional.

Materials of Housing : Aluminium  
Materials of Optics : PC

- ▶
- ▶
- ▶
- ▶

| Code           | Watt | Size(AxBxCmm) | Lumen(±5%) | N.W/pc(kgs) | Q'ty/CTN |
|----------------|------|---------------|------------|-------------|----------|
| DB45A-600-20W  | 20W  | 604x60x70     | 2500lm     | 1.15        | 12PCS    |
| DB45A-1200-40W | 40W  | 1204x60x70    | 5200lm     | 2.20        | 6PCS     |
| DB45B-600-20W  | 20W  | 604x60x70     | 2400lm     | 1.15        | 12PCS    |
| DB45B-1200-40W | 40W  | 1204x60x70    | 4800lm     | 2.20        | 6PCS     |

CCT ——— 3000K ——— 4000K ——— 5700K

Finish ——— White Black

Installation accessories ——— Suspension kit

Splicing kit

# DB163 Linear light

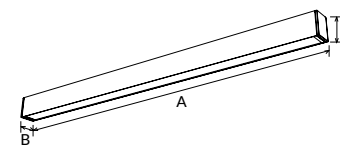

DB163 is IP54 water-proof design LED linear light, the high lumen LED makes it high lumen efficiency 125lm/W design.

Materials of Housing : Aluminium+PC  
Materials of Optics : PC

- ▶
- ▶
- ▶
- ▶

| Code           | Watt | Size(AxBxCmm) | Lumen(±5%) | N.W/pc(kgs) | Q'ty/CTN |
|----------------|------|---------------|------------|-------------|----------|
| DB163-1200-32W | 32W  | 1215x57x76    | 4200lm     | 2.60        | 6PCS     |
| DB163-1500-38W | 38W  | 1515x57x76    | 5200lm     | 3.08        | 6PCS     |

CCT ——— 3000K ——— 4000K ——— 5700K

Finish ——— White Black Silver

Installation accessories ——— Suspension kit

Splicing accessories ACC-DB163

Suspension splicing ACC-DB163

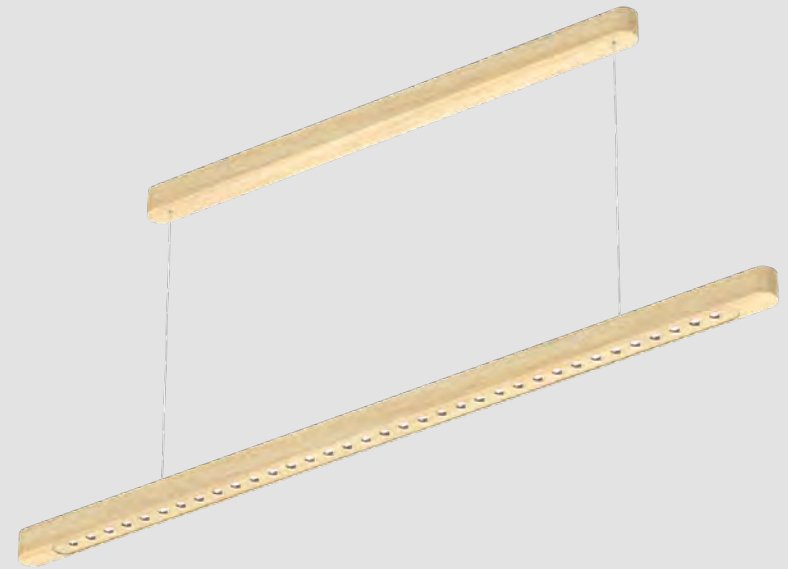
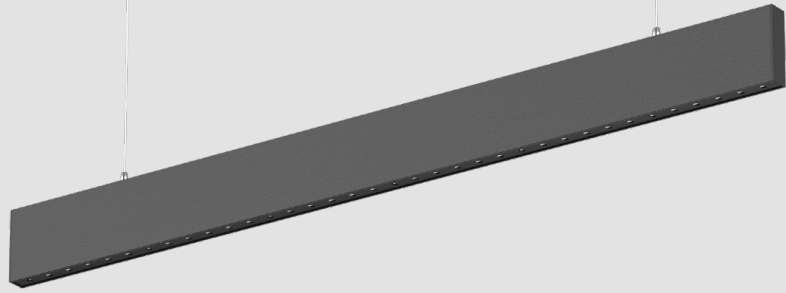

# DB176 Linear light

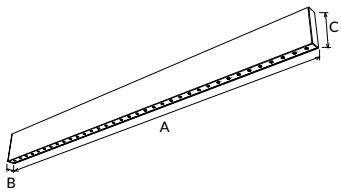

DB176 is anti-slim office linear light with 29mm width. It is anti-glare design with UGR<19. Internal flicker free driver and triac/DALI dimming are available. Surface mounted and suspended for options.

Materials of Housing : Aluminium  
Materials of Optics : PC

- ▶ 30°
- ▶ IP20
- ▶ UGR<19
- ▶ DIM
- ▶ DALI
- ▶ Flicker Free
- ▶ AC 220-240V
- ▶ PF≥0.9
- ▶ CRI≥80
- ▶ SAA
- ▶ RoHS
- ▶ CE

| Code               | Watt                            | Size(AxBxCmm) | Lumen(±5%) | N.W/pc(kgs) | Q'ty/CTN |
|--------------------|---------------------------------|---------------|------------|-------------|----------|
| DB176-1200-28W     | 28W                             | 1200x29x103   | 2250lm     | 1.87        | 6PCS     |
| DB176-1600-34W     | 34W                             | 1595x29x103   | 2800lm     | 2.37        | 4PCS     |
| DB176-2000-40W/42W | 40W(Non-dim/DALI)<br>42W(Triac) | 1990x29x103   | 3100lm     | 2.87        | 4PCS     |

CCT ——— 2700K ——— 3000K ——— 4000K

Finish ——— White Black

Installation accessories



# DB198 Linear light

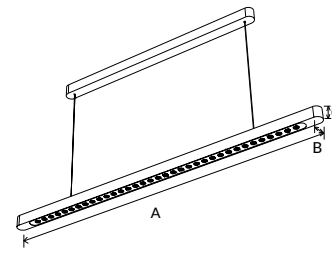

DB198 LED brich batten light is an ideal lighting solution for carbon emission reduction and environmental protection. It adopts high lumen SMD LED which could be 130lm/W. Internal driver design with power changeable and DALI available. Up & down lighting design provides great lighting performance,the upper lighting can be on/off.

Materials of Housing : Wooden  
Materials of Optics : PC

- ▶ 110°  
36°/60°
- ▶ IP20
- ▶ UGR<19
- ▶ DALI
- ▶ Flicker Free
- ▶ Adjustable Power
- ▶ AC 220-240V
- ▶ PF≥0.9
- ▶ CRI≥80
- ▶ SAA
- ▶ RoHS
- ▶ CE

| Code               | Watt   | Size(AxBxCmm) | Lumen(±5%) | N.W/pc(kgs) | Q'ty/CTN |
|--------------------|--|---------------|------------|-------------|----------|
| DB198A-1200-34W-A5 | (34W/31W/29W/27W/25W)<br>(27W/25W/23W/21W/20W) | 1200x40x40    | 4600lm     | 1.50        | 6PCS     |
| DB198A-1500-45W-A5 | (45W/42W40W/38W/36W)<br>(35W/33W/31W/30W/28W)  | 1500x40x40    | 6200lm     | 2.00        | 6PCS     |

CCT ——— 3000K ——— 4000K

Finish ——— Wood grain

Installation accessories

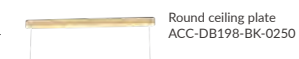



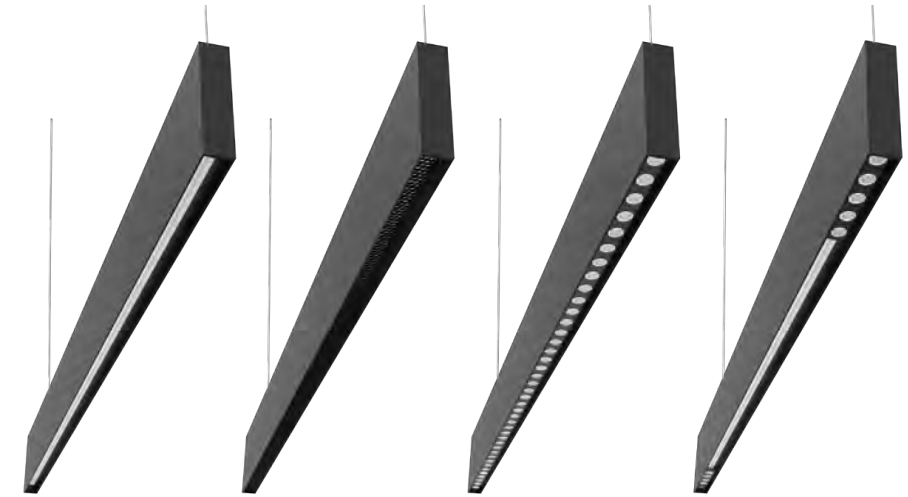
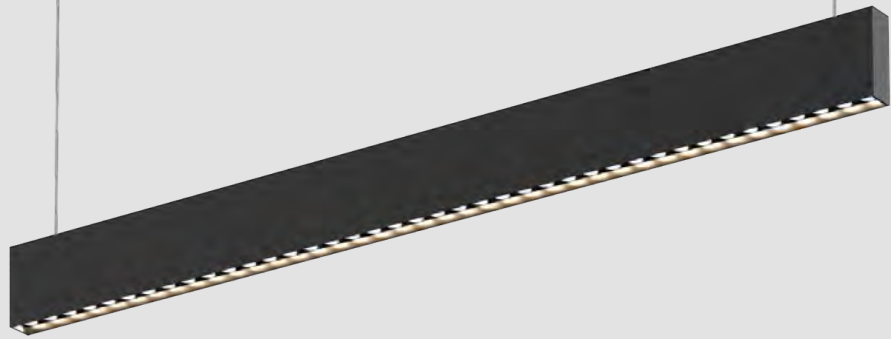

DB146A

DB146B

DB146C

DB146D

# DB146 Linear light

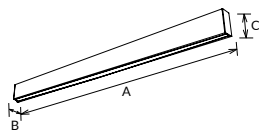

The DB146 batten has a minimalist appearance, adopts a variety of optics, it is perfect for a variety of use environment. Plug-in link and seamless splicing design effectively improve the installation time. Adopts 100lm/W & 120lm/W SMD high lumen efficiency as option ;flicker free driver with high efficiency. Up & down lighting design, up 20% & down 80%. Interchangeable CCT(3000K+4000K) and up lighting control with the same slide switch. DIY module design option: direct lighting module, honeycomb module, lens module, direct lighting + lens module.

- 
- 
- 
- 
- 

Materials of Housing : Aluminium

Materials of Optics : PMMA / PMMA+PC

| Code            | Watt    | Size(AxBxCmm) | Lumen(±5%) | N.W/pc(kgs) | Q'ty/CTN |
|-----------------|---------|---------------|------------|-------------|----------|
| DB146A-600-18W  | 15W     | 605x34x105    | 1650lm     | 1.40        | 6PCS     |
| DB146A-600-18W  | 15W+3W  | 605x34x105    | 2000lm     | 1.40        | 6PCS     |
| DB146A-900-25W  | 20W     | 905x34x105    | 2200lm     | 2.10        | 6PCS     |
| DB146A-900-25W  | 20W+5W  | 905x34x105    | 2700lm     | 2.10        | 6PCS     |
| DB146A-1200-38W | 30W     | 1205x34x105   | 4000lm     | 2.70        | 6PCS     |
| DB146A-1200-38W | 30W+8W  | 1205x34x105   | 4900lm     | 2.70        | 6PCS     |
| DB146A-1500-50W | 40W     | 1505x34x105   | 5200lm     | 3.20        | 6PCS     |
| DB146A-1500-50W | 40W+10W | 1505x34x105   | 6400lm     | 3.20        | 6PCS     |
| DB146B-1200-38W | 30W     | 1205x34x105   | 1800lm     | 2.70        | 6PCS     |
| DB146B-1200-38W | 30W+8W  | 1205x34x105   | 2850lm     | 2.70        | 6PCS     |
| DB146B-1500-50W | 40W     | 1505x34x105   | 2400lm     | 3.20        | 6PCS     |
| DB146B-1500-50W | 40W+10W | 1505x34x105   | 3700lm     | 3.20        | 6PCS     |
| DB146C-1200-38W | 30W     | 1205x34x105   | 4000lm     | 2.70        | 6PCS     |
| DB146C-1200-38W | 30W+8W  | 1205x34x105   | 4900lm     | 2.70        | 6PCS     |
| DB146C-1500-50W | 40W     | 1505x34x105   | 5200lm     | 3.20        | 6PCS     |
| DB146C-1500-50W | 40W+10W | 1505x34x105   | 6400lm     | 3.20        | 6PCS     |
| DB146D-1200-38W | 30W     | 1205x34x105   | 4000lm     | 2.70        | 6PCS     |
| DB146D-1200-38W | 30W+8W  | 1205x34x105   | 4900lm     | 2.70        | 6PCS     |
| DB146D-1500-50W | 40W     | 1505x34x105   | 5200lm     | 3.20        | 6PCS     |
| DB146D-1500-50W | 40W+10W | 1505x34x105   | 6400lm     | 3.20        | 6PCS     |

CCT — 3000K — 4000K — 5000K

Finish — White — Black

Installation accessories



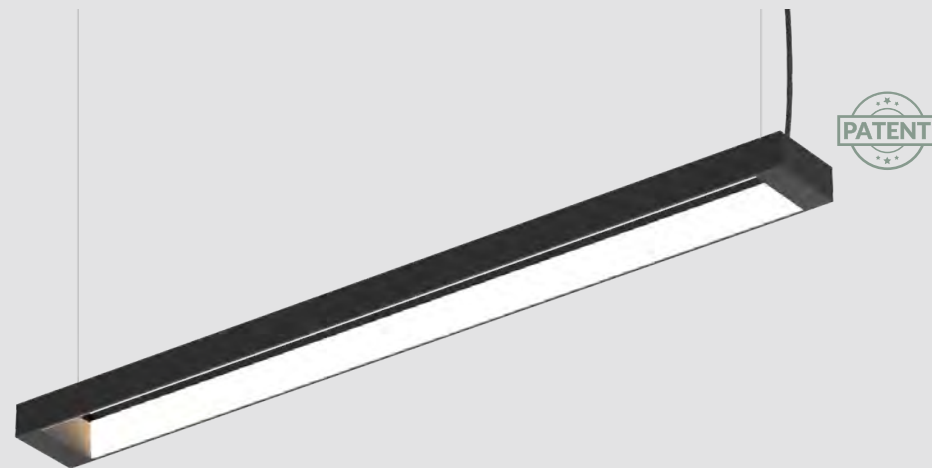

# DB197 Wooden Linear light

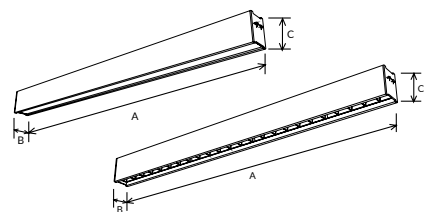

DB197 brick batten light is an ideal lighting solution for double carbon and environmental protection. It adopts high lumen SMD LED with 2CCT UGR19 low glare light and uses built-in driver that support 0-10V/DALI dim. It's also available for both pendant and surface mounted installation.

Materials of Housing : Wooden  
Materials of Optics : PC

- ▶
- ▶
- ▶
- ▶
- ▶

| Code            | Watt | Size(AxBxCmm) | Lumen(±5%) | N.W/pc(kgs) | Q'ty/CTN |
|-----------------|------|---------------|------------|-------------|----------|
| DB197A-1200-28W | 28W  | 1208x70x100   | 3800lm     | 1.50        | 4PCS     |
| DB197A-1200-36W | 36W  | 1208x70x100   | 4800lm     | 1.50        | 4PCS     |
| DB197A-1500-32W | 32W  | 1508x70x100   | 4500lm     | 1.80        | 4PCS     |
| DB197A-1500-50W | 50W  | 1508x70x100   | 7000lm     | 1.80        | 4PCS     |
| DB197B-1200-28W | 28W  | 1208x70x100   | 3800lm     | 1.50        | 4PCS     |
| DB197B-1200-36W | 36W  | 1208x70x100   | 4800lm     | 1.50        | 4PCS     |
| DB197B-1500-32W | 32W  | 1508x70x100   | 4500lm     | 1.80        | 4PCS     |
| DB197B-1500-50W | 50W  | 1508x70x100   | 7000lm     | 1.80        | 4PCS     |

CCT  3000K 4000K

Finish  Wood grain

Installation accessories Suspension kit

# DB25 Linear light

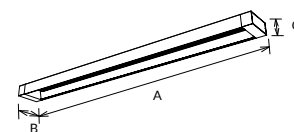

DB25 Linear with suspended and hollow design highlight the brand features, which makes the light go both up and down sides. The light for upside can reduce the extra light decoration.

Materials of Housing : Aluminium  
Materials of Optics : PC

- ▶
- ▶
- ▶
- ▶
- ▶

| Code          | Watt | Size(AxBxCmm) | Lumen(±5%) | N.W/pc(kgs) | Q'ty/CTN |
|---------------|------|---------------|------------|-------------|----------|
| DB25-900-20W  | 20W  | 922x115x48.8  | 2000lm     | 1.46        | 6PCS     |
| DB25-1200-40W | 40W  | 1222x115x48.8 | 3800lm     | 1.86        | 6PCS     |
| DB25-1600-60W | 60W  | 1622x115x48.8 | 5800lm     | 2.47        | 6PCS     |

CCT  3000K 4000K 5700K

Finish  White  Black



# DB147 Linear light

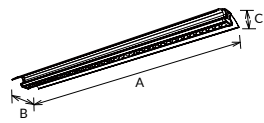

Not only with modern and classic aesthetics looking, DB147 linear light also has a special optic design: up&down lighting and symmetrical lighting(with special wing shape). It adopts high lumen efficiency SMD light source, 1W LED for up&down main lighting, 0.2W LED for Symmetrical soft lighting. The shape design highly increased lighting area, also lowered the glare to make it UGR<16. It is suitable for dining room and office to achieve both lighting effect and decoration effect.

Materials of Housing : Aluminium

Materials of Optics : PC

- ▶ 50°
- ▶ 35% 65% 100%
- ▶ IP20
- ▶ UGR<16
- ▶ Flicker Free
- ▶ SLIDE SWITCH 2 in 1
- ▶ SLIDE SWITCH 3 in 1
- ▶ AC 220-240V
- ▶ PF≥0.9
- ▶ CRI≥80
- ▶ SAA
- ▶ RoHS
- ▶ CE

| Code           | Watt | Size(AxBxCmm) | Lumen(±5%) | N.W/pc(kgs) | Q'ty/CTN |
|----------------|------|---------------|------------|-------------|----------|
| DB147-1200-36W | 36W  | 1172x236x74   | 3500lm     | 3.70        | 2PCS     |
| DB147-1200-45W | 45W  | 1172x236x74   | 4800lm     | 3.70        | 2PCS     |
| DB147-1500-40W | 40W  | 1552x236x74   | 4100lm     | 3.70        | 2PCS     |
| DB147-1500-60W | 60W  | 1552x236x74   | 5800lm     | 3.70        | 2PCS     |

CCT — 3000K — 4000K — 5700K

Finish — White

# DB155 Linear light

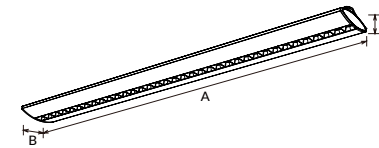

DB155 is a pendant light with curved appearance design. It adopts high lumen SMD light source and bright silver reflector, giving comfortable lighting effect achieve UGR<19. It available with 3CCT, seamless splicing, with up and down lighting design, it's an ideal pendant light for office lighting.

Materials of Housing : Aluminium

Materials of Optics : PC

- ▶ 45°
- ▶ IP20
- ▶ UGR<19
- ▶ DALI
- ▶ Flicker Free
- ▶ SLIDE SWITCH 3 in 1
- ▶ AC 200-264V
- ▶ PF≥0.9
- ▶ CRI≥80
- ▶ SAA
- ▶ RoHS
- ▶ CE

| Code           | Watt                          | Size(AxBxCmm) | Lumen(±5%) | N.W/pc(kgs) | Q'ty/CTN |
|----------------|-------------------------------|---------------|------------|-------------|----------|
| DB155-1200-36W | 9W(Indirect)+27W(Direct)      | 1161.5x150x40 | 3700lm     | 2.70        | 6PCS     |
| DB155-1200-50W | 12.5W(Indirect)+37.5W(Direct) | 1161.5x150x40 | 4800lm     | 2.70        | 6PCS     |
| DB155-1500-40W | 10W(Indirect)+30W(Direct)     | 1143.5x150x40 | 4000lm     | 3.25        | 6PCS     |
| DB155-1500-60W | 15W(Indirect)+45W(Direct)     | 1143.5x150x40 | 5800lm     | 3.25        | 6PCS     |

CCT — 3000K — 4000K — 5700K

Finish — White Black



# MODULAR DESIGN

HIGH WATTAGE

WITH HIGH LUMEN **180LM/W**

## DB211 NEW Batten

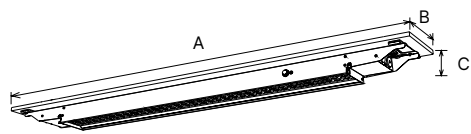

Linear light DB211 is SMD design, high lumen efficiency 180lm/W, available with symmetric and asymmetric beam. The integral driver can do on/off and DALI dim. Quick installation with loop-in loop-out, 5 terminal (on/off) and 7 terminal (DALI). Replaceable modular design makes it more flexible.

Materials of Housing : Zinc coated steel

Materials of Optics : PC

- ▶ 20° 30° 60° 90° 30°x90°
- ▶ IP23
- ▶ DALI Flicker Free
- ▶ AC 200-240V PF $\geq$ 0.9 CRI $\geq$ 80
- ▶ SAA RoHS CE

| Code             | Watt             | Size(AxBxCmm) | Lumen(±5%) | N.W/pc(kgs) | Q'ty/CTN |
|------------------|------------------|---------------|------------|-------------|----------|
| DB211A-1200-56W  | 30W/42W/50W/56W  | 1200x98x54    | 10347lm    | 2.80        | 4PCS     |
| DB211A-1200-80W  | 50W/56W/70W/80W  | 1200x98x54    | 13589lm    | 2.80        | 4PCS     |
| DB211A-1500-115W | 60W/76W/90W/115W | 1500x98x54    | 19931lm    | 3.25        | 2PCS     |

CCT ——— 3000K 4000K 5700K

Finish ——— White

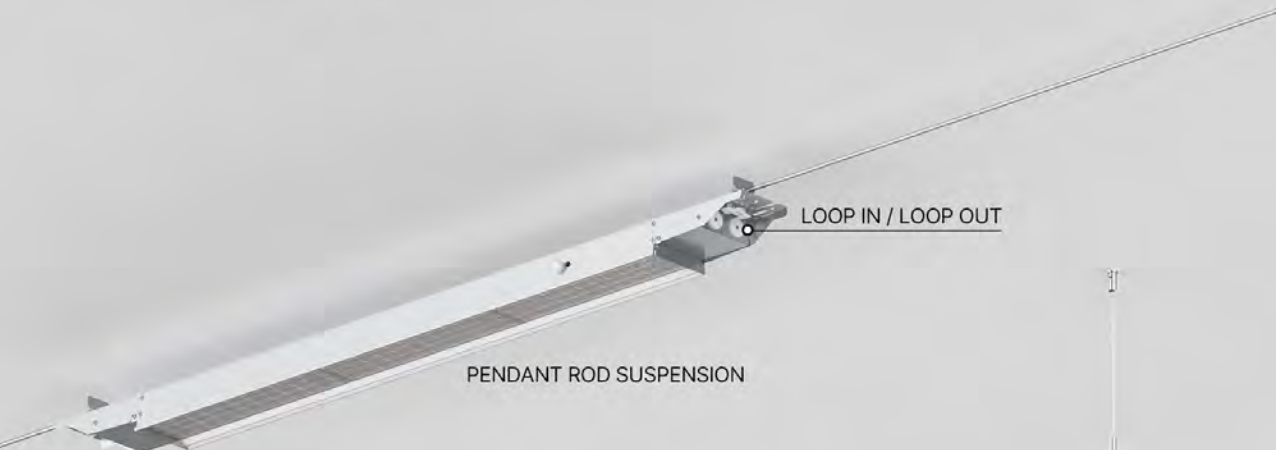

LED Linear & Batten light

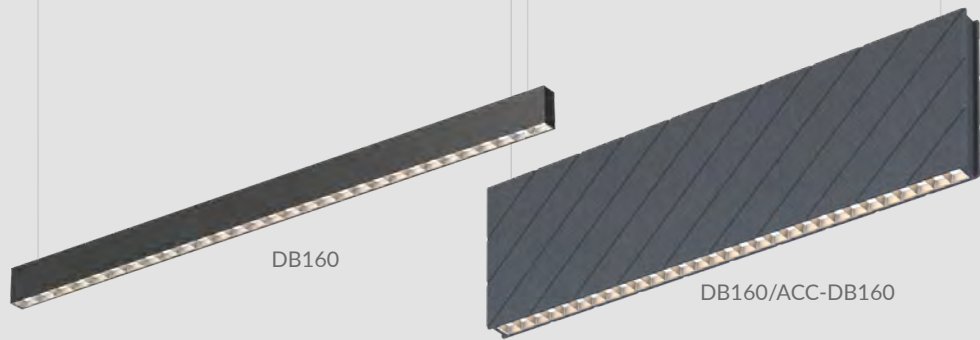

# DB160 Acoustic linear light

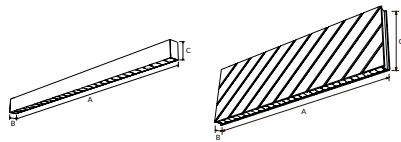

DB160 is an integrated acoustic linear system that offers unmatched possibilities to control noise and provide optimal lighting in commercial environments. For optic design, DB160 adopts high lumen SMD, direct and indirect lighting design, offering a uniform light distribution. For sound management, the polyester fiber sound-absorbing board is with striped grooves, and the concave-convex structure can fully diffuse excess sound rays, which can realize frequency sound absorption and diffusion, making the sound clearer and fuller, better integration of acoustics and modern lamps together. It supports CCT adjustable and DALI dim.

- 20% 110° 110° 110°  
80% 80°x50° 105° 90°
- IP20 UGR<19
- DALI Flicker Free SMD 3 in 1 Bluetooth CASAMBI
- AC 220-240V PF≥0.9 CRI≥80
- SAA RoHS CE

Materials of Housing : Polyester fibre+Aluminium

Materials of Optics : PC

| Code                      | Watt                      | Size(AxBxCmm) | Lumen(±5%) | N.W/pc(kgs) | Q'ty/CTN |
|---------------------------|---------------------------|---------------|------------|-------------|----------|
| DB160A-1200-36W           | 36W                       | 1252x45x80    | 3800lm     | 2.23        | 6PCS     |
| DB160A-1500-50W           | 50W                       | 1480x45x80    | 5000lm     | 2.83        | 6PCS     |
| DB160B-1200-36W           | 36W                       | 1252x45x80    | 4550lm     | 2.23        | 6PCS     |
| DB160B-1500-50W           | 50W                       | 1480x45x80    | 6200lm     | 2.83        | 6PCS     |
| DB160C-1200-36W           | 36W                       | 1252x45x80    | 3800lm     | 2.23        | 6PCS     |
| DB160C-1500-50W           | 50W                       | 1480x45x80    | 5800lm     | 2.83        | 6PCS     |
| DB160A-1200-46W/ACC-DB160 | 36W(Direct)               | 1292x64x400   | 3800lm     | 5.28        | 1PCS     |
| DB160A-1200-46W/ACC-DB160 | 10W(Indirect)+36W(Direct) | 1292x64x400   | 5000lm     | 5.28        | 1PCS     |
| DB160A-1500-65W/ACC-DB160 | 50W(Direct)               | 1500x64x400   | 5000lm     | 5.95        | 1PCS     |
| DB160A-1500-65W/ACC-DB160 | 15W(Indirect)+50W(Direct) | 1500x64x400   | 6800lm     | 5.95        | 1PCS     |
| DB160B-1200-46W/ACC-DB160 | 36W(Direct)               | 1292x64x400   | 4550lm     | 5.28        | 1PCS     |
| DB160B-1200-46W/ACC-DB160 | 10W(Indirect)+36W(Direct) | 1292x64x400   | 5750lm     | 5.28        | 1PCS     |
| DB160B-1500-65W/ACC-DB160 | 50W(Direct)               | 1500x64x400   | 6200lm     | 5.95        | 1PCS     |
| DB160B-1500-65W/ACC-DB160 | 15W(Indirect)+50W(Direct) | 1500x64x400   | 8000lm     | 5.95        | 1PCS     |
| DB160C-1200-46W/ACC-DB160 | 36W(Direct)               | 1292x64x400   | 3800lm     | 5.28        | 1PCS     |
| DB160C-1200-46W/ACC-DB160 | 10W(Indirect)+36W(Direct) | 1292x64x400   | 4800lm     | 5.28        | 1PCS     |
| DB160C-1500-65W/ACC-DB160 | 50W(Direct)               | 1500x64x400   | 5800lm     | 5.95        | 1PCS     |
| DB160C-1500-65W/ACC-DB160 | 15W(Indirect)+50W(Direct) | 1500x64x400   | 7500lm     | 5.95        | 1PCS     |

CCT ——— 3000K ——— 4000K ——— 5700K      Finish ——— White Black

Installation accessories ——— Acoustic lighting fixture DB160/ACC-DB160-1200/1500 ——— Upward LED module ACC-DB160-1200/1500 Round ceiling plate ACC-DB160-(DA/D0)-BK(WT)-0200

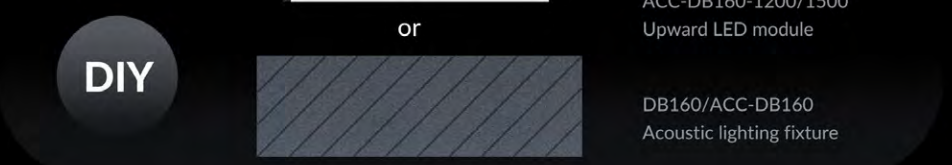
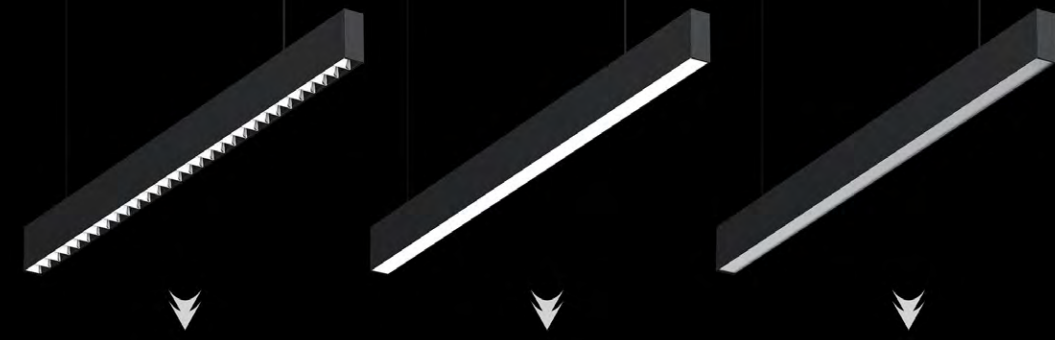

**DB160A**  
Grill reflector  
UGR<19 95lm/w @White 4000K

**DB160B**  
Opal diffuser  
120lm/w @White 4000K

**DB160C**  
Prismatic diffuser  
95lm/w @White 4000K



CCT switch & Up module switch

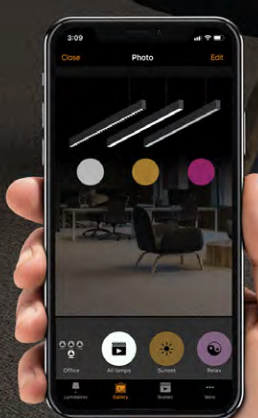

LED Linear & Batten light

LED Linear DB160 UPSHINE | CASAMBI

# Acoustic Lighting

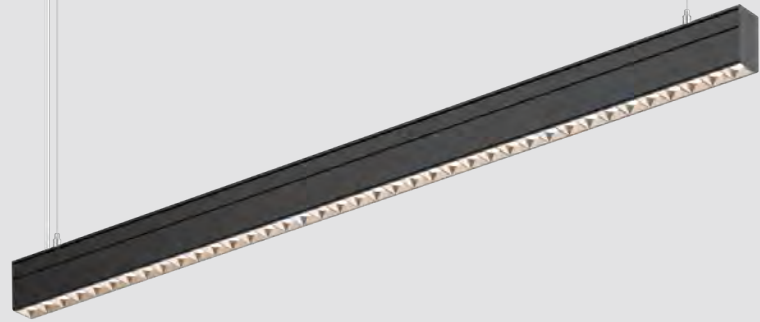

## DB165 Linear light

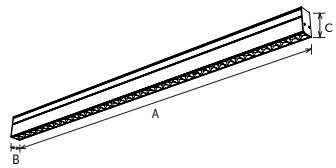

DB165 linear light is anti-glare optic design with multiple beam angles, offering various light distribution options. It adopts internal driver and high lumen SMD, also supports seamless splicing and DALI dim.

Materials of Housing : Aluminium  
Materials of Optics : PC

- ▶ 15° 24° 38° 50° 35°x55° IP20
- ▶
- ▶
- ▶

| Code               | Watt | Size(AxBxCmm) | Lumen(±5%) | N.W/pc(kgs) | Q'ty/CTN |
|--------------------|------|---------------|------------|-------------|----------|
| DB165-1200-42W     | 42W  | 1180x40x75    | 4100lm     | 2.06        | 6PCS     |
| ACC-DB165-1200-42W | 42W  | 1226x40x75    | 4100lm     | 1.84        | 6PCS     |

CCT — 3000K — 4000K — 5700K

Finish — White — Black

## DB166 Linear light

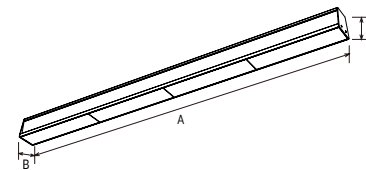

DB166 linear light is 120lm/W high lumen design, that achieves energy saving conception. It has multiple beam angles, offering various light distribution options. It adopts internal driver and high lumen SMD, also supports seamless splicing and DALI dim.

Materials of Housing : Aluminium  
Materials of Optics : PC

- ▶ 30° 60° 90° IP20
- ▶
- ▶
- ▶

| Code               | Watt | Size(AxBxCmm) | Lumen(±5%) | N.W/pc(kgs) | Q'ty/CTN |
|--------------------|------|---------------|------------|-------------|----------|
| DB166-1200-40W     | 40W  | 1152x66x73    | 5000lm     | 2.73        | 6PCS     |
| ACC-DB166-1200-40W | 40W  | 1198x66x73    | 5000lm     | 2.45        | 6PCS     |
| DB166-1200-60W     | 60W  | 1152x66x73    | 7000lm     | 2.73        | 6PCS     |
| ACC-DB166-1200-60W | 60W  | 1198x66x73    | 7000lm     | 2.45        | 6PCS     |

CCT — 3000K — 4000K — 5700K

Finish — White — Black

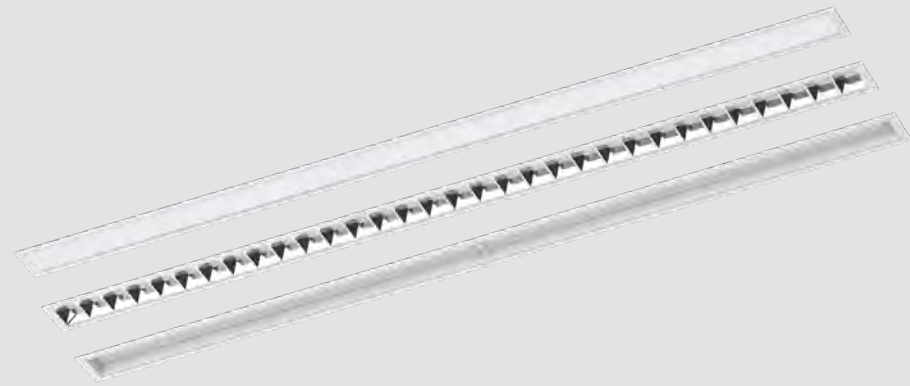

# DB151 Linear light

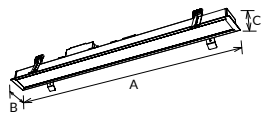

DB151 series LED Batten Light is a functional recessed batten light which could do different length customization, no limitation for splicing quantity. Special structure design with different covers, splicing shapes, recessed ways. Recessed with N-shape, T-shape and H-shape accessories as per installation demands. Interchangeable CCT with slide switch. Support non-dim and DALI dimming. DB151A with PC/prismatic diffusers, six kinds of connectors for choice. DB151B with grille design, DB151C with lens design, both of their straight splicing with magnetic end cap.

Materials of Housing : Aluminium  
Materials of Optics : PC

- ▶ 60° 90° 110° 36°x20° IP40
- ▶ DALI Flicker Free SILENCE SWITCH
- ▶ AC 220-240V PF≥0.9 CRI≥80
- ▶ SAA RoHS CE

| Code              | Watt | Size(AxBxCmm) | Cut-out(±5mm) | Lumen(±5%)    | N.W/pc(kgs) | Q'ty/CTN |
|-------------------|------|---------------|---------------|---------------|-------------|----------|
| DB151A/B-600-15W  | 15W  | 615x62x29     | 607x54        | 1600lm        | 0.67/0.71   | 12PCS    |
| DB151A/B-1200-30W | 30W  | 1208x62x29    | 1201x54       | 3400lm/3200lm | 1.21/1.26   | 6PCS     |
| DB151A/B-1500-37W | 37W  | 1505x62x29    | 1498x54       | 4200lm        | 1.48/1.54   | 6PCS     |
| DB151A/B-1800-45W | 45W  | 1802x62x29    | 1794x54       | 5000lm        | 1.78/1.85   | 6PCS     |
| DB151A/B-2400-60W | 60W  | 2395x62x29    | 2388x54       | 6600lm/6200lm | 2.27/2.36   | 6PCS     |
| DB151C-600-15W    | 15W  | 615x62x29     | 607x54        | 1600lm        | 0.75        | 12PCS    |
| DB151C-1200-30W   | 30W  | 1208x62x29    | 1201x54       | 3200lm        | 1.37        | 6PCS     |
| DB151C-1500-37W   | 37W  | 1505x62x29    | 1498x54       | 4200lm        | 1.69        | 6PCS     |
| DB151C-1800-45W   | 45W  | 1802x62x29    | 1794x54       | 5000lm        | 2.02        | 6PCS     |
| DB151C-2400-60W   | 60W  | 2395x62x29    | 2388x54       | 6200lm        | 2.62        | 6PCS     |

CCT ——— 3000K ——— 4000K ——— 5700K

Finish ——— White Black

Installation accessories



Recessed N-shape



Recessed clips

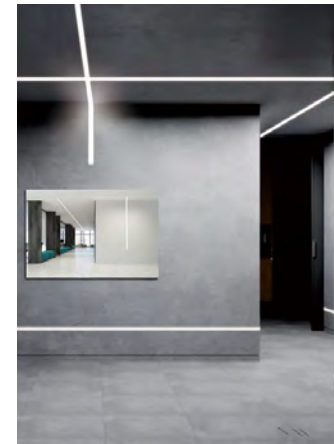

DB151A



DB151B

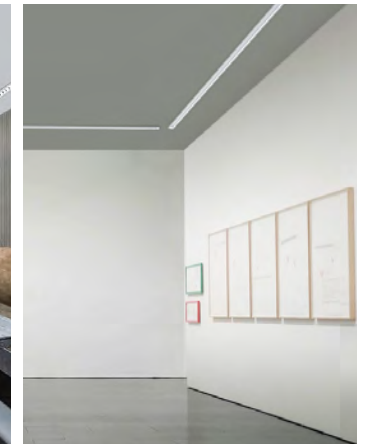

DB151C

PC diffuser



Prismatic diffuser

Satin louver

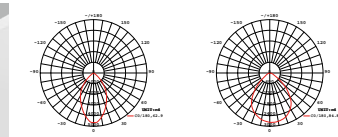

Silver reflector (60°)

White reflector (80°)

Wall washer

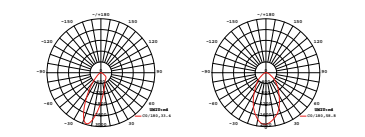

36 degree with 20 degree polarization

60 degree

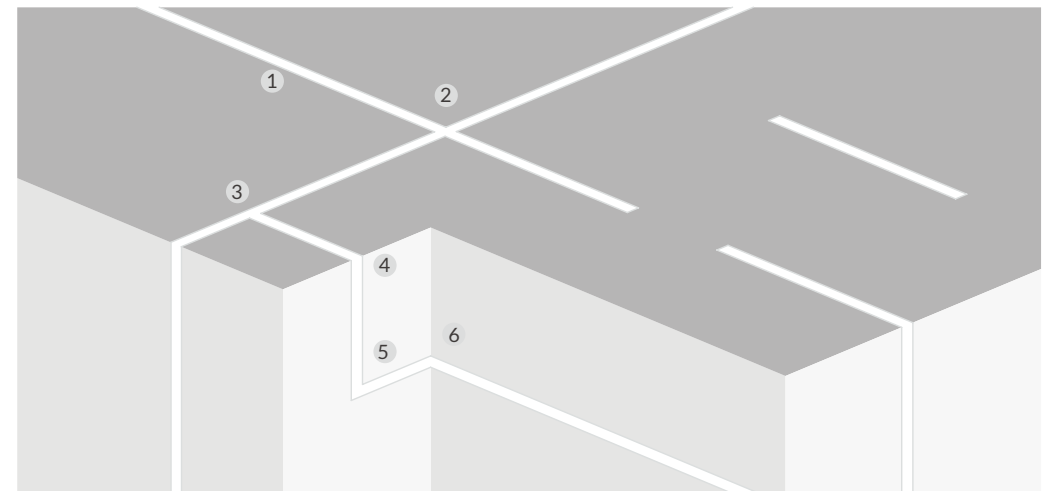

ACC-DB151-SL-50

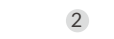

ACC-DB151-WT-110-02



ACC-DB151-WT-110-04



ACC-DB151-WT-110-0351



ACC-DB151-WT-110-03



ACC-DB151-WT-110-0350

LED Linear & Batten light





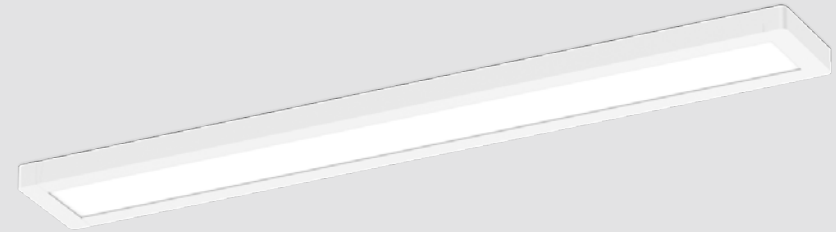

# DB05 Batten

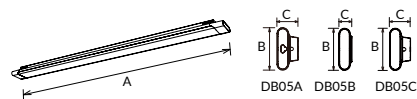

DB05 is an elegant design with low cost and super slim construction. Surface mounted and suspended installation available.

Materials of Housing : Aluminium  
Materials of Optics : PC

- ▶ IP20
- ▶ 120°
- ▶ DIM
- ▶ Flicker Free
- ▶ AC 100-240V
- ▶ AC 200-240V
- ▶ PF≥0.9
- ▶ CRI≥80
- ▶ SAA
- ▶ RoHS
- ▶ CE

| Code             | Watt | Size(AxBxCmm) | Lumen(±5%) | N.W/pc(kgs) | Q'ty/CTN |
|------------------|------|---------------|------------|-------------|----------|
| DB05A/C-600-20W  | 20W  | 600X90X46     | 1710lm     | 0.86        | 12PCS    |
| DB05A/C-900-30W  | 30W  | 900X90X46     | 2630lm     | 1.30        | 12PCS    |
| DB05A/C-1200-40W | 40W  | 1200X90X46    | 3540lm     | 1.98        | 12PCS    |
| DB05B-600-20W    | 20W  | 600X90X28     | 1710lm     | 0.82        | 20PCS    |
| DB05B-900-30W    | 30W  | 900X90X28     | 2630lm     | 0.95        | 12PCS    |
| DB05B-1200-40W   | 40W  | 1200X90X28    | 3540lm     | 1.50        | 12PCS    |

CCT — 3000K — 4000K — 5700K

Finish — White — Black

Installation accessories — Suspension kit ACC-DB05B-0200

Surface mounted kit ACC-DB05B-0100

# DB179 Batten

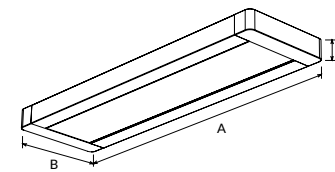

DB179 ceiling luminaire is slim and modern design with high lumen SMD, an ideal replacement for traditional T8 luminaire. Four sizes for option: 550/850/1150/1450mm. Supports triac/ DALI dim, surface mounted and pendant installation.

Materials of Housing : Aluminium  
Materials of Optics : PC

- ▶ IP20
- ▶ 110°
- ▶ DIM
- ▶ DALI
- ▶ Flicker Free
- ▶ AC 200-240V
- ▶ PF≥0.9
- ▶ CRI≥80
- ▶ SAA
- ▶ RoHS
- ▶ CE

| Code           | Watt | Size(AxBxCmm) | Lumen(±5%) | N.W/pc(kgs) | Q'ty/CTN |
|----------------|------|---------------|------------|-------------|----------|
| DB179-550-20W  | 20W  | 550x160x35    | 2800lm     | 0.94        | 12PCS    |
| DB179-850-30W  | 30W  | 850x160x35    | 4200lm     | 1.37        | 6PCS     |
| DB179-1150-40W | 40W  | 1150x160x35   | 5600lm     | 1.82        | 6PCS     |
| DB179-1450-47W | 47W  | 1450x160x35   | 5700lm     | 1.82        | 6PCS     |
| DB179-1450-50W | 50W  | 1450x160x35   | 6900lm     | 2.16        | 4PCS     |

CCT — 3000K — 4000K — 5700K

Finish — White — Black

Installation accessories — Suspension kit

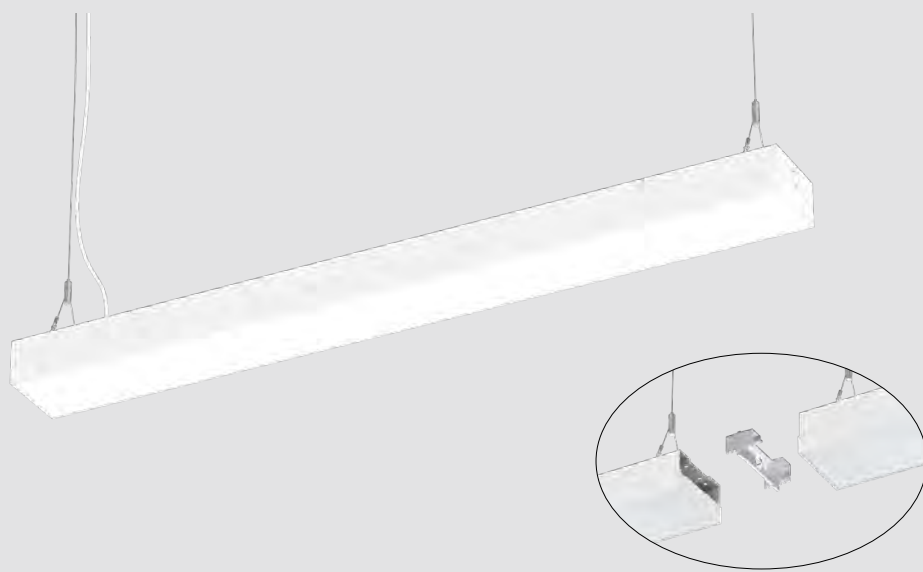

## DB105A Batten

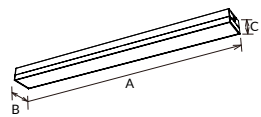

DB105A is a newly seamless splicing batten design, which adopts high lumen SMD reaching 120lm/W, prism lamp shade to offer a uniform light output and flicker free driver inside. Interchangeable CCT with slide switch is available. Surface mounted, pendant and splicing installation for options.

Materials of Housing : Aluminium

Materials of Optics : PMMA

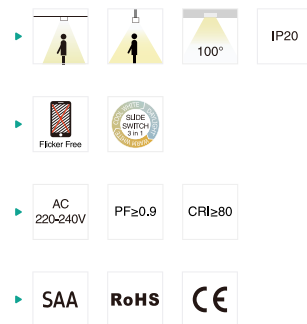

| Code                                | Watt | Size(AxBxCmm) | Lumen(±5%) | N.W/pc(kgs) | Q'ty/CTN |
|-------------------------------------|------|---------------|------------|-------------|----------|
| DB105A-600-24W-C3<br>Surface mount  | 24W  | 600×120×70    | 3000lm     | 1.26        | 12PCS    |
| DB105A-1200-38W-C3<br>Surface mount | 38W  | 1200×120×70   | 5000lm     | 2.35        | 6PCS     |
| DB105A-1500-55W-C3<br>Surface mount | 55W  | 1500×120×70   | 7000lm     | 2.88        | 4PCS     |
| DB105A-600-24W-C3<br>Pendant        | 24W  | 600×120×70    | 3000lm     | 1.38        | 12PCS    |
| DB105A-1200-38W-C3<br>Pendant       | 38W  | 1200×120×70   | 5000lm     | 2.47        | 6PCS     |
| DB105A-1500-55W-C3<br>Pendant       | 55W  | 1500×120×70   | 7000lm     | 3.00        | 4PCS     |



## DB157 Batten

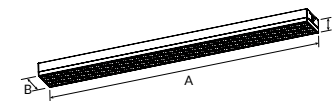

DB157 grill batten light is a low glare and seamless splicing design, which adopts internal flicker free driver and high lumen SMD. It is screwless and quick buckle assembly design for easy and convenient installation, and supports CCT adjustable, power adjustable.

Materials of Housing : Aluminium

Materials of Optics : PC

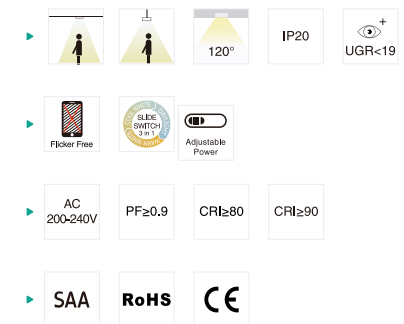

| Code                           | Watt            | Size(AxBxCmm) | Lumen(±5%)  | N.W/pc(kgs) | Q'ty/CTN |
|--------------------------------|-----------------|---------------|-------------|-------------|----------|
| DB157-1200-40W-A4C2            | 40W/35W/30W/25W | 1200X120X59   | 3200-5400lm | 2.92        | 6PCS     |
| DB157-1200-40W-A4C2<br>Pendant | 40W/35W/30W/25W | 1200X120X59   | 3200-5400lm | 3.03        | 6PCS     |
| DB157-1500-50W-A4C2            | 50W/45W/40W/35W | 1500X120X59   | 4600-6600lm | 3.52        | 4PCS     |
| DB157-1500-50W-A4C2<br>Pendant | 50W/45W/40W/35W | 1500X120X59   | 4600-6600lm | 3.62        | 4PCS     |





# DB08 Batten

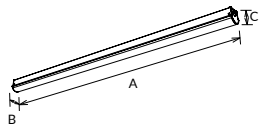

The DB08 batten achieves low cost with an internal driver and adopts high lumen SMD LED, resulting in a simple construction and superior capability, making it suitable for a potentially large market.

Materials of Housing : SPCC/IRON  
Materials of Optics : PC

- ▶
- ▶
- ▶
- ▶

| Code          | Watt | Size(AxBxCmm)  | Lumen(±5%) | N.W/pc(kgs) | Q'ty/CTN |
|---------------|------|----------------|------------|-------------|----------|
| DB08-600-20W  | 20W  | 625X58.5X58.5  | 2060lm     | 0.78        | 10PCS    |
| DB08-1200-40W | 40W  | 1225X58.5X58.5 | 3960lm     | 1.50        | 10PCS    |
| DB08-1500-45W | 45W  | 1525X58.5X58.5 | 4860lm     | 1.90        | 6PCS     |

CCT ——— 3000K ——— 4000K ——— 5700K

Installation accessories ——— Suspension kit

Finish ——— White Black

# DB76 Batten

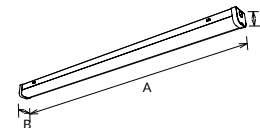

DB76, with an iron lamp body, provides excellent heat dissipation. It is made of high lumen 2835 SMD LED chips and has an internal driver. The new snap-on button design allows for easy installation.

Materials of Housing : PC / IRON  
Materials of Optics : PC

- ▶
- ▶
- ▶
- ▶

| Code           | Watt | Size(AxBxCmm) | Lumen(±5%) | N.W/pc(kgs) | Q'ty/CTN |
|----------------|------|---------------|------------|-------------|----------|
| DB76-600-20W   | 20W  | 603x71x64     | 2200lm     | 0.65        | 12PCS    |
| DB76-1200-40W  | 40W  | 1203x71x64    | 4600lm     | 1.28        | 12PCS    |
| DB76-1500-50W  | 50W  | 1503x71x64    | 6000lm     | 1.56        | 12PCS    |
| DB76-1500-58W  | 58W  | 1503x71x64    | 6500lm     | 1.56        | 12PCS    |
| DB76-1800-58W  | 58W  | 1803x71x64    | 7000lm     | 2.16        | 6PCS     |
| DB76-1800-72W  | 72W  | 1803x71x64    | 8350lm     | 2.16        | 6PCS     |
| DB76D-600-20W  | 20W  | 603x68.5x64   | 2150lm     | 0.65        | 12PCS    |
| DB76D-1200-40W | 40W  | 1203x71x64    | 4500lm     | 1.28        | 12PCS    |
| DB76D-1500-50W | 50W  | 1503x71x64    | 5100lm     | 1.56        | 12PCS    |

CCT ——— 3000K ——— 4000K ——— 5700K

Installation accessories ——— Suspension kit

Finish ——— White Black



# DB186 Batten

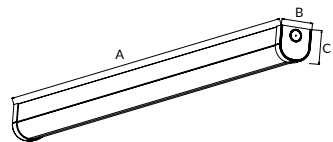

This is a high quality LED batten with 150lm/w efficiency and plug in/plug out modular with multiple functions can be stocked as accessory. Easy installation offers more possibility for wider applications.

Materials of Housing : PC / SPCC  
Materials of Optics : PC

- ▶ 120° IP40 IK06
- ▶
- ▶
- ▶

| Code                 | Watt            | Size(AxBxCmm) | Lumen(±5%) | N.W/pc(kgs) | Q'ty/CTN |
|----------------------|-----------------|---------------|------------|-------------|----------|
| DB186A-600-10W(ECO)  | 10W             | 600x65x66     | 1450lm     | 0.65        | 12PCS    |
| DB186A-600-20W(ECO)  | 20W             | 600x65x66     | 2850lm     | 0.65        | 12PCS    |
| DB186A-1200-20W(ECO) | 20W             | 1200x65x66    | 2850lm     | 1.28        | 12PCS    |
| DB186A-1200-38W(ECO) | 38W             | 1200x65x66    | 5400lm     | 1.28        | 12PCS    |
| DB186A-1500-30W(ECO) | 30W             | 1500x65x66    | 4300lm     | 1.56        | 12PCS    |
| DB186A-1500-50W(ECO) | 50W             | 1500x65x66    | 7400lm     | 1.56        | 12PCS    |
| DB186A-1800-30W(ECO) | 30W             | 1800x65x66    | 4300lm     | 2.16        | 6PCS     |
| DB186A-1800-50W(ECO) | 50W             | 1800x65x66    | 7400lm     | 2.16        | 6PCS     |
| DB186A-600-20W(STD)  | 20W/18W/15W/10W | 600x65x66     | 2850lm     | 0.65        | 12PCS    |
| DB186A-1200-40W(STD) | 40W/35W/30W/20W | 1200x65x66    | 5700lm     | 1.28        | 12PCS    |
| DB186A-1500-50W(STD) | 50W/40W/32W/25W | 1500x65x66    | 7100lm     | 1.56        | 12PCS    |
| DB186A-1800-60W(STD) | 60W/50W/40W/30W | 1800x65x66    | 8500lm     | 2.16        | 6PCS     |
| DB186A-600-18W(PRO)  | 18W/15W/13W/9W  | 600x65x66     | 3250lm     | 0.65        | 12PCS    |
| DB186A-1200-30W(PRO) | 30W/25W/20W/15W | 1200x65x66    | 5450lm     | 1.28        | 12PCS    |
| DB186A-1500-38W(PRO) | 38W/33W/28W/29W | 1500x65x66    | 6900lm     | 1.56        | 12PCS    |
| DB186A-1800-48W(PRO) | 48W/40W/32W/24W | 1800x65x66    | 8700lm     | 2.16        | 6PCS     |

CCT ——— 3000K ——— 4000K ——— 5700K

Finish ——— White

Installation accessories ——— Suspension kit ACC-DB121-0201

## SIMPLE MODULAR DESIGN WITH HIGH LUMEN 150/180LM/W



PIR Sensor



Interchangeable CCT with slide switch



3000K 4000K 5700K

LED Linear & Batten light



# DB121 Batten

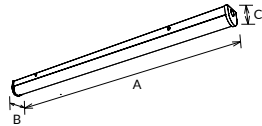

DB121 Batten light adopts high lumen SMD LED with 120lm/w and high light transmittance PC shade, loop in/out and fast connector design for easier wire connection, it's with multiple installation: surface mounted, suspended, splicing as well 1-10V, DALI and 3CCT function available.

Materials of Housing : PC/SPCC  
Materials of Optics : PC

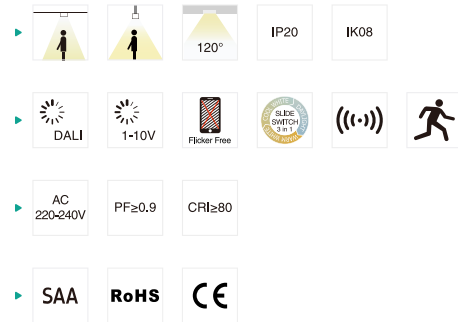

| Code            | Watt | Size(AxBxCmm) | Lumen(±5%) | N.W/pc(kgs) | Q'ty/CTN |
|-----------------|------|---------------|------------|-------------|----------|
| DB121A-600-17W  | 17W  | 603x65x66     | 2200lm     | 0.88        | 6PCS     |
| DB121A-1200-22W | 22W  | 1203x65x66    | 2900lm     | 1.37        | 6PCS     |
| DB121A-1200-38W | 38W  | 1203x65x66    | 5000lm     | 1.37        | 6PCS     |
| DB121A-1500-35W | 35W  | 1503x65x66    | 4600lm     | 1.71        | 6PCS     |
| DB121A-1500-58W | 58W  | 1503x65x66    | 7600lm     | 1.71        | 6PCS     |
| DB121A-1800-55W | 55W  | 1803x65x66    | 7200lm     | 2.13        | 6PCS     |
| DB121A-1800-70W | 70W  | 1803x65x66    | 9000lm     | 2.13        | 6PCS     |
| DB121B-600-17W  | 17W  | 603x65x66     | 2200lm     | 0.88        | 6PCS     |
| DB121B-1200-22W | 22W  | 1203x65x66    | 2900lm     | 1.37        | 6PCS     |
| DB121B-1200-38W | 38W  | 1203x65x66    | 5000lm     | 1.37        | 6PCS     |
| DB121B-1500-35W | 35W  | 1503x65x66    | 4600lm     | 1.71        | 6PCS     |
| DB121B-1500-58W | 58W  | 1503x65x66    | 7600lm     | 1.71        | 6PCS     |
| DB121B-1800-55W | 55W  | 1803x65x66    | 7200lm     | 2.13        | 6PCS     |
| DB121B-1800-70W | 70W  | 1803x65x66    | 9000lm     | 2.13        | 6PCS     |

CCT — 3000K — 4000K — 5700K

Finish — White

Installation accessories — Suspension kit ACC-DB121-0201



# DB138 Batten

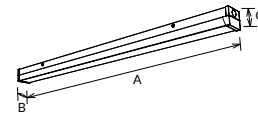

DB138 LED batten light is a perfect replacement for traditional tube or high cost tri-proof light. Adopts high lumen SMD LED and high light transmittance PC shade. It realizes simple disassembly with 4 fast buttons, easier installation and maintenance with high cost performance, Besides, it has 600mm, 1200mm, 1500mm size optional, interchangeable CCT or power by slide switch. Microwave sensor, emergency functions for more application area demand.

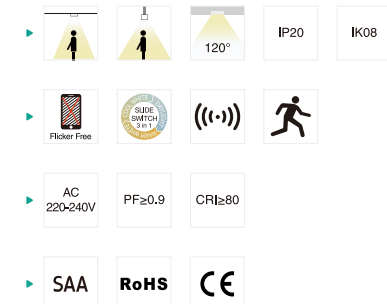

| Code               | Watt    | Size(AxBxCmm) | Lumen(±5%)            | N.W/pc(kgs) | Q'ty/CTN |
|--------------------|---------|---------------|-----------------------|-------------|----------|
| DB138-600-20W-A2   | 10W/20W | 603x65x66     | 10W:1300lm/20W:2600lm | 0.88        | 6PCS     |
| DB138-1200-40W-A2  | 20W/40W | 1203x65x66    | 20W:2600lm/40W:4600lm | 1.37        | 6PCS     |
| DB138-1500-60W-A2  | 35W/60W | 1503x65x66    | 35W:4300lm/60W:6500lm | 1.71        | 6PCS     |
| DB138-1200-40W-EA2 | 20W/40W | 1203x65x66    | 20W:2500lm/40W:4500lm | 1.37        | 6PCS     |
| DB138-1500-60W-EA2 | 35W/60W | 1503x65x66    | 35W:4200lm/60W:6500lm | 1.71        | 6PCS     |

CCT — 3000K — 4000K — 5700K

Finish — White

Installation accessories — Suspension kit ACC-DB121-0201





# SUPER SLIM BATTEN

## DB49 Batten

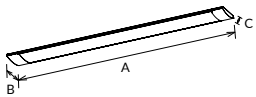

DB49 is a full size slim batten with uniform light and excellent heat dissipation, adopting high lumen SMD LED and internal driver. CCT changeable by adjusting the slide switch. Easier installation without installing bracket.

Materials of Housing : Aluminium  
Materials of Optics : PC

- ▶ 120°
- ▶
- ▶
- ▶

| Code           | Watt | Size(AxBxCmm) | Lumen(±5%) | N.W/pc(kgs) | Q'ty/CTN |
|----------------|------|---------------|------------|-------------|----------|
| DB49A-600-20W  | 20W  | 600X80X34     | 2300lm     | 0.60        | 10PCS    |
| DB49A-900-30W  | 30W  | 900X80X34     | 3500lm     | 0.86        | 10PCS    |
| DB49A-1200-35W | 35W  | 1200X80X34    | 3950lm     | 1.12        | 10PCS    |
| DB49A-1500-40W | 40W  | 1500X80X34    | 4500lm     | 1.40        | 6PCS     |
| DB49B-600-25W  | 25W  | 600X124X42    | 2950lm     | 0.84        | 10PCS    |
| DB49B-900-35W  | 35W  | 900X124X42    | 4300lm     | 1.25        | 10PCS    |
| DB49B-1200-45W | 45W  | 1200X124X42   | 5600lm     | 1.67        | 10PCS    |
| DB49B-1500-50W | 50W  | 1500X124X42   | 5650lm     | 2.00        | 6PCS     |

CCT ——— 3000K ——— 4000K ——— 5700K

Finish ——— White ——— Black

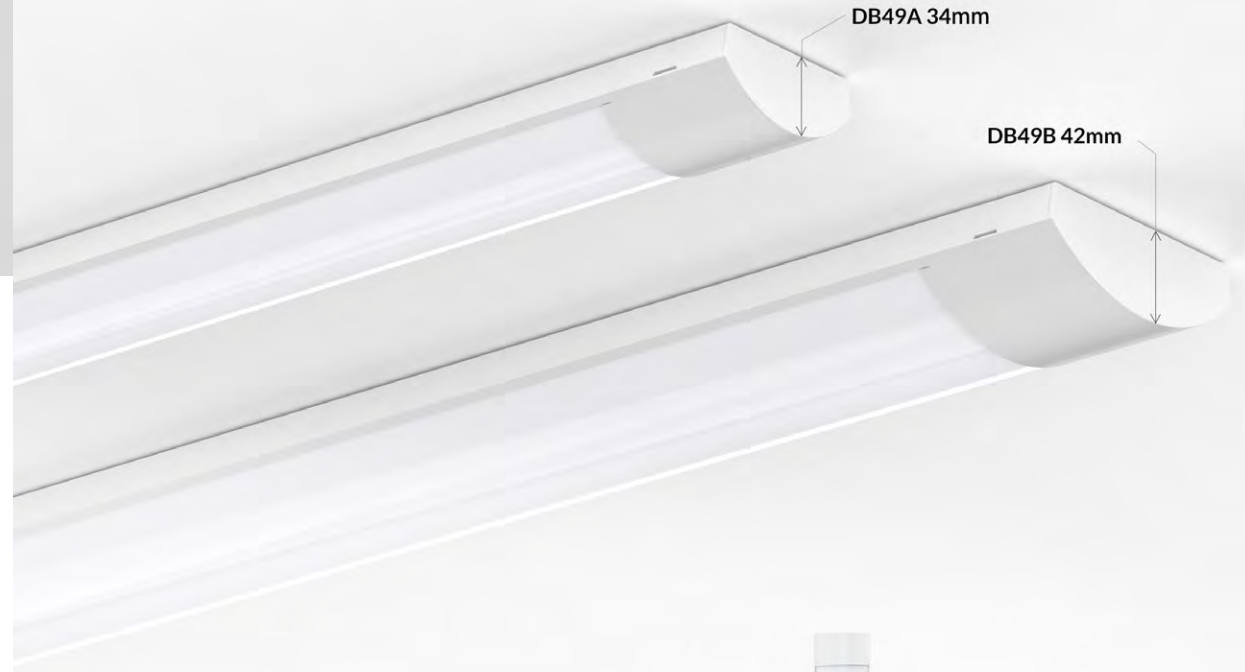

LED Linear & Batten light



# DB199 Batten

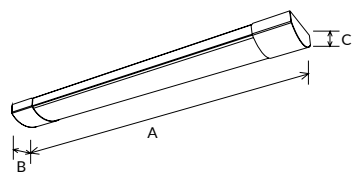

DB199 is a recessed batten light, which adopts high lumen SMD and internal driver . It can also support interchangeable CCT&power.

Materials of Housing : PC  
Materials of Optics : PC

- ▶
- ▶
- ▶
- ▶

| Code           | Watt | Size(AxBxCmm) | Lumen(±5%) | N.W/pc(kgs) | Q'ty/CTN |
|----------------|------|---------------|------------|-------------|----------|
| DB199-600-18W  | 18W  | 600x82x35     | 2160lm     | 0.60        | 10PCS    |
| DB199-1200-40W | 40W  | 1200x82x35    | 4800lm     | 0.90        | 10PCS    |

CCT — 3000K — 4000K — 5700K

Finish — White

# DB124 Batten

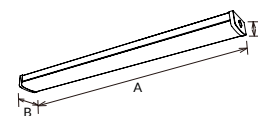

DB124 is a compact design, it adopts 2835 SMD chip to create a high light output. 130 degrees large lighting area and multiple functions,like CCT changeable, microwave sensor available. Installation: pendant/surface mounted.

Materials of Housing : PC/SPCC  
Materials of Optics : PC

- ▶
- ▶
- ▶
- ▶

| Code           | Watt | Size(AxBxCmm) | Lumen(±5%) | N.W/pc(kgs) | Q'ty/CTN |
|----------------|------|---------------|------------|-------------|----------|
| DB124-600-20W  | 20W  | 600x124x60    | 1900lm     | 1.18        | 6PCS     |
| DB124-1200-38W | 38W  | 1200x124x60   | 3800lm     | 2.14        | 6PCS     |
| DB124-1500-50W | 50W  | 1500x124x60   | 5000lm     | 2.71        | 6PCS     |
| DB124-1500-60W | 60W  | 1500x124x60   | 6000lm     | 2.71        | 6PCS     |

CCT — 3000K — 4000K — 5700K

Finish — White

Installation accessories — Suspension kit



# DB144 Batten

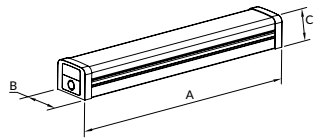

The DB144 batten light is easy to disassemble and install due to its snap-joint design. It features an internal flicker-free driver and high lumen SMD for uniform light output, as well as support for CCT adjustment.

Materials of Housing : SPCC  
Materials of Optics : PC

- ▶
- ▶
- ▶
- ▶

| Code              | Watt | Size(AxBxCmm) | Lumen(±5%) | N.W/pc(kgs) | Q'ty/CTN |
|-------------------|------|---------------|------------|-------------|----------|
| DB144-600-20W-C3  | 20W  | 600X83X68     | 2300lm     | 0.91        | 6PCS     |
| DB144-1200-40W-C3 | 40W  | 1200X83X68    | 4600lm     | 1.70        | 6PCS     |

CCT — 3000K — 4000K — 5700K

Finish — White — Black

# DB41 Batten

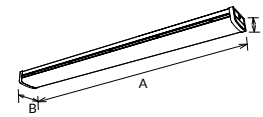

DB41 batten lamp adopts separated module design and internal driver, has been improved to have a wider lighting emitting area; color temperature and wattage both switchable. Suspended, surface mounted and splicing installation optional.

Materials of Housing : Aluminium+SPCC  
Materials of Optics : PC

- ▶
- ▶
- ▶
- ▶

| Code          | Watt | Size(AxBxCmm) | Lumen(±5%) | N.W/pc(kgs) | Q'ty/CTN |
|---------------|------|---------------|------------|-------------|----------|
| DB41-600-25W  | 25W  | 600x124x68    | 2500lm     | 1.50        | 12PCS    |
| DB41-1200-42W | 42W  | 1200x124x68   | 4780lm     | 2.90        | 6PCS     |

CCT — 3000K — 4000K — 5700K

Finish — White — Black

Installation accessories — Suspension kit





# DB74 Batten

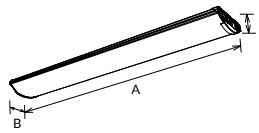

DB74 batten light is a compact design, it adopts high lumen 2835 SMD chip and flicker free branded driver ensure a long lifespan. Screwless design on back side with better looking, large lighting area with high lumen efficiency. It's a great option for various applications.

Materials of Housing : IRON  
Materials of Optics : PC

- ▶
- ▶
- ▶
- ▶

| Code          | Watt | Size(AxBxCmm) | Lumen(±5%) | N.W/pc(kgs) | Q'ty/CTN |
|---------------|------|---------------|------------|-------------|----------|
| DB74-600-17W  | 17W  | 595x171x63    | 1870lm     | 1.55        | 12PCS    |
| DB74-1200-30W | 30W  | 1195x171x63   | 3500lm     | 2.88        | 6PCS     |
| DB74-1500-36W | 36W  | 1495x171x63   | 4250lm     | 3.52        | 6PCS     |
| DB74-1500-50W | 50W  | 1495x171x63   | 6000lm     | 3.52        | 6PCS     |

CCT — 3000K — 4000K — 5700K

Finish — White



# DB175 Batten

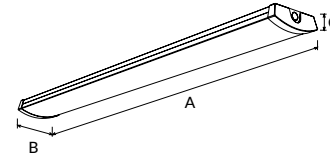

DB175 is a slim batten light with big lighting area, available with 3CCT, DALI dim, emergency, and sensor function. High lumen efficiency 130lm/W and 160lm/W.

Materials of Housing : PC  
Materials of Optics : PC

- ▶
- ▶
- ▶
- ▶

| Code           | Watt | Size(AxBxCmm) | Lumen(±5%) | N.W/pc(kgs) | Q'ty/CTN |
|----------------|------|---------------|------------|-------------|----------|
| DB175-600-20W  | 20W  | 600x148x50    | 2600lm     | 1.10        | 12PCS    |
| DB175-1200-40W | 40W  | 1200x148x50   | 5200lm     | 2.00        | 6PCS     |
| DB175-1500-55W | 55W  | 1500x148x50   | 7150lm     | 2.40        | 6PCS     |
| DB175-600-20W  | 20W  | 600x148x50    | 3200lm     | 1.10        | 12PCS    |
| DB175-1200-40W | 40W  | 1200x148x50   | 6400lm     | 2.00        | 6PCS     |
| DB175-1500-55W | 55W  | 1500x148x50   | 8800lm     | 2.40        | 6PCS     |

CCT — 3000K — 4000K — 5700K

Finish — White



# DB106B Batten

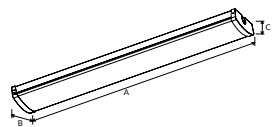

DB106B batten light is a compact design with internal branded flicker free driver. Screwless design on back side with better looking, large lighting area with high lumen efficiency. It supports emergency, microwave sensor, CCT adjustable and DALI dim.

Materials of Housing : SPCC/PC  
Materials of Optics : PC

- ▶
- ▶
- ▶
- ▶

| Code            | Watt | Size(AxBxCmm) | Lumen(±5%) | N.W/pc(kgs) | Q'ty/CTN |
|-----------------|------|---------------|------------|-------------|----------|
| DB106B-600-20W  | 20W  | 600x207x80    | 2300lm     | 1.40        | 4PCS     |
| DB106B-1200-20W | 20W  | 1200x207x80   | 2400lm     | 2.60        | 2PCS     |
| DB106B-1200-40W | 40W  | 1200x207x80   | 4800lm     | 2.60        | 2PCS     |
| DB106B-1500-30W | 30W  | 1500x207x80   | 3800lm     | 3.30        | 2PCS     |
| DB106B-1500-58W | 58W  | 1500x207x80   | 7000lm     | 3.30        | 2PCS     |

CCT ——— 3000K ——— 4000K ——— 5700K

Finish ——— White ——— Black

# DB212 NEW Batten

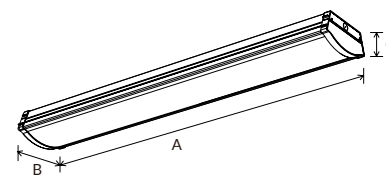

DB212 Batten light is with wide body design with uniform and wider light output, high lumen SMD 125lm/w, anti-glare design, 3CCT, DALI dimmable, sensor and emergency available. It can be surface mounted and suspending installation for option.

Materials of Housing : SPCC  
Materials of Optics : PC

- ▶
- ▶
- ▶
- ▶

| Code                 | Watt    | Size(AxBxCmm) | Lumen(±5%) | N.W/pc(kgs) | Q'ty/CTN |
|----------------------|---------|---------------|------------|-------------|----------|
| DB212A-1200-40W-A2C3 | 20W/40W | 1200x200x96   | 5000lm     | 4.20        | 2PCS     |
| DB212A-1500-50W-A2C3 | 30W/50W | 1500x200x96   | 6250lm     | 5.09        | 2PCS     |
| DB212B-1200-30W-DAC3 | 30W     | 1200x200x96   | 3300lm     | 4.20        | 2PCS     |
| DB212B-1500-35W-DAC3 | 35W     | 1500x200x96   | 3850lm     | 5.09        | 2PCS     |

CCT ——— 3000K ——— 4000K ——— 5700K

Finish ——— White

Installation accessories ——— Suspension kit ACC-DB05B-0200

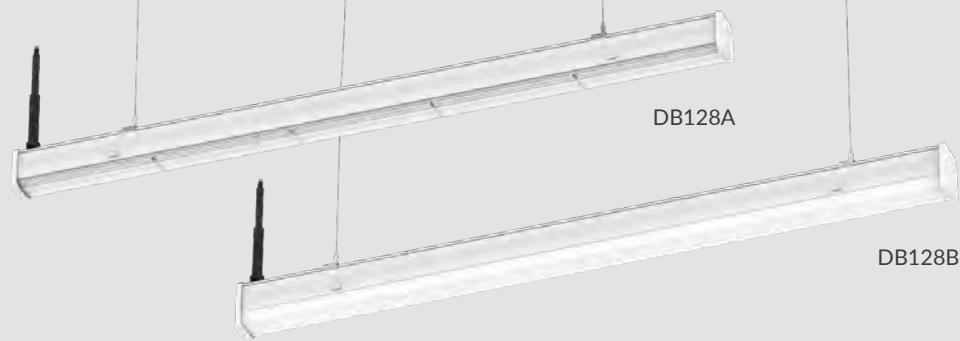

# DB128 Trunking System

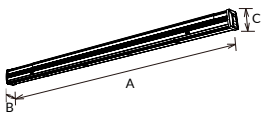

DB128 LED Linear Track Light adopts high lumen SMD and internal driver. Its separated module design can support a flexible installation. For track, 5-wire/8-wire/12-wire selectable, splicing with L/T/X node connector and different entry hole. Power selectable by dip switch. DALI dimming, Emergency, Sensor for more application demands. Multifit for Surface mounting, steel wire suspension, rod suspension and chain suspension.

Materials of Housing : Steel  
Materials of Optics : PMMA

- ▶
- ▶
- ▶
- ▶
- ▶
- ▶

| Code               | Watt            | Size(AxBxCmm)  | Lumen(±5%)                     | N.W/pc(kgs) | Q'ty/CTN |
|--------------------|-----------------|----------------|--------------------------------|-------------|----------|
| DB128A-1500-40W-A4 | 28W/33W/36W/40W | 1498x71.4x71.5 | 6150lm/7050lm/7500lm/8400lm    | 2.00        | 4PCS     |
| DB128A-1500-60W-A4 | 45W/50W/55W/60W | 1498x71.4x71.5 | 9550lm/10550lm/11550lm/12550lm | 2.00        | 4PCS     |
| DB128A-1500-74W-A3 | 62W/68W/74W     | 1498x71.4x71.5 | 12200lm/13600lm/14650lm        | 2.00        | 4PCS     |
| DB128B-1500-40W-A4 | 28W/33W/36W/40W | 1498x71.4x86.5 | 4400lm/5150lm/5500lm/6000lm    | 1.50        | 4PCS     |
| DB128B-1500-60W-A4 | 45W/50W/55W/60W | 1498x71.4x86.5 | 7050lm/7700lm/8300lm/8900lm    | 1.50        | 4PCS     |
| DB128B-1500-74W-A3 | 62W/68W/74W     | 1498x71.4x86.5 | 9350lm/10200lm/10500lm         | 1.50        | 4PCS     |

CCT

Finish

Installation accessories Surface mounted kit



# LED LINEAR LIGHTING SYSTEM

Separated module design with track, linear light and functional modules

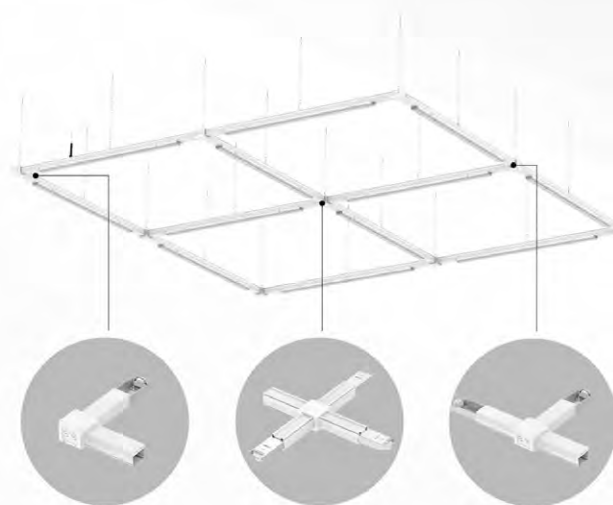

Suspension kit



LED Linear & Batten light



# DB68 Vapor proof

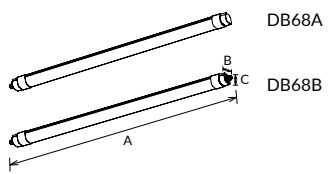

DB68 is an IP66 waterproof IK10 rated luminaire. Adopt high lumen SMD ,internal driver and 3x2 poles push in wire terminal block. It provides through-wiring for further luminaires (safety class II) connection. Tool free mains cable installation on both sides.

Materials of Housing : PC  
Materials of Optics : PC

- ▶
- ▶
- ▶
- ▶

| Code           | Watt | Size(AxBxCmm)  | Lumen(±5%) | N.W/pc(kgs) | Q'ty/CTN |
|----------------|------|----------------|------------|-------------|----------|
| DB68A-700-20W  | 20W  | 700x78.3x58.6  | 2300lm     | 0.50        | 12PCS    |
| DB68A-1300-40W | 40W  | 1300x78.3x58.6 | 4680lm     | 0.80        | 8PCS     |
| DB68A-1600-50W | 50W  | 1600x78.3x58.6 | 6000lm     | 0.95        | 6PCS     |
| DB68B-700-20W  | 20W  | 700x78.3x58.6  | 2300lm     | 0.50        | 12PCS    |
| DB68B-1300-40W | 40W  | 1300x78.3x58.6 | 4680lm     | 0.80        | 8PCS     |
| DB68B-1600-50W | 50W  | 1600x78.3x58.6 | 6000lm     | 0.95        | 6PCS     |

CCT ——— 3000K 4000K 5700K      Finish ——— White Black

Installation accessories ——— Suspension kit

Linkable suggested luminaires Qty (200-240V) ——— 20W-52PCS 40W-26PCS 50W-21PCS

# DB18 Vapor proof

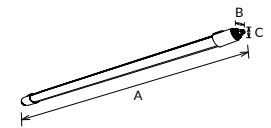

DB18 adopts high quality LED batten with high luminous efficacy 115lm/w and flicker free driver. With a reliable and robust housing structure (IK10 & IP66). Three options of length (700mm/1300mm/1600mm), and various lumen package, let it to be an ideal replacement for traditional fluorescent batten.

Materials of Housing : PC  
Materials of Optics : PC

- ▶
- ▶
- ▶
- ▶

| Code          | Watt | Size(AxBxCmm) | Lumen(±5%) | N.W/pc(kgs) | Q'ty/CTN |
|---------------|------|---------------|------------|-------------|----------|
| DB18-700-20W  | 20W  | 700x78x53.5   | 2300lm     | 0.60        | 12PCS    |
| DB18-1300-25W | 25W  | 1300x78x53.5  | 3050lm     | 0.80        | 8PCS     |
| DB18-1300-30W | 30W  | 1300x78x53.5  | 3450lm     | 0.80        | 8PCS     |
| DB18-1300-40W | 40W  | 1300x78x53.5  | 4680lm     | 0.80        | 8PCS     |
| DB18-1600-40W | 40W  | 1600x78x53.5  | 4680lm     | 1.00        | 6PCS     |
| DB18-1600-50W | 50W  | 1600x78x53.5  | 6000lm     | 1.00        | 6PCS     |

CCT ——— 3000K 4000K 5700K      Finish ——— White Black

Installation accessories ——— Suspension kit

Linkable suggested luminaires Qty (200-240V) ——— 20W-52PCS 40W-26PCS 50W-21PCS

LED Linear & Batten light



# DB169 Vapor proof

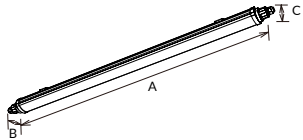

DB169 vapor batten adopts high lumen efficiency SMD light source reach to 120lm/W, and flicker free driver. Tool free mains cable installation on both sides through twist lock fastener cover at both sides. With a reliable and robust housing structure (IK08 & IP65). 3-CCT changeable is available and DB169A can splicing to 1200W max.

Materials of Housing : PC  
Materials of Optics : PC

- ▶ Flicker Free, Sleep Switch, 120°, IP65, IK08
- ▶ AC 100-277V, AC 220-240V, PF≥0.9, CRI≥80
- ▶ SAA, RoHS, CE

| Code            | Watt | Size(AxBxCmm) | Lumen(±5%) | N.W/pc(kgs) | Q'ty/CTN |
|-----------------|------|---------------|------------|-------------|----------|
| DB169A-600-18W  | 18W  | 600x66x54     | 2100lm     | 0.42        | 12PCS    |
| DB169A-600-18W  | 18W  | 600x66x54     | 2400lm     | 0.42        | 12PCS    |
| DB169A-1200-33W | 33W  | 1200x66x54    | 4000lm     | 0.75        | 12PCS    |
| DB169A-1200-33W | 33W  | 1200x66x54    | 4550lm     | 0.75        | 12PCS    |
| DB169A-1500-46W | 46W  | 1500x66x54    | 6000lm     | 0.91        | 12PCS    |
| DB169A-1500-46W | 46W  | 1500x66x54    | 6350lm     | 0.91        | 12PCS    |
| DB169B-600-18W  | 18W  | 538x66x54     | 2100lm     | 0.37        | 12PCS    |
| DB169B-600-18W  | 18W  | 538x66x54     | 2400lm     | 0.37        | 12PCS    |
| DB169B-1200-33W | 33W  | 1138x66x54    | 4000lm     | 0.69        | 12PCS    |
| DB169B-1200-33W | 33W  | 1138x66x54    | 4550lm     | 0.69        | 12PCS    |
| DB169B-1500-46W | 46W  | 1438x66x54    | 6000lm     | 0.84        | 12PCS    |
| DB169B-1500-46W | 46W  | 1438x66x54    | 6350lm     | 0.84        | 12PCS    |

CCT ——— 3000K ——— 4000K ——— 5700K

Linkable suggested luminaries Qty (200-240V) ——— 18W-66PCS ——— 40W-30PCS  
46W-26PCS

Finish ——— Grey

Installation accessories ——— Suspension kit

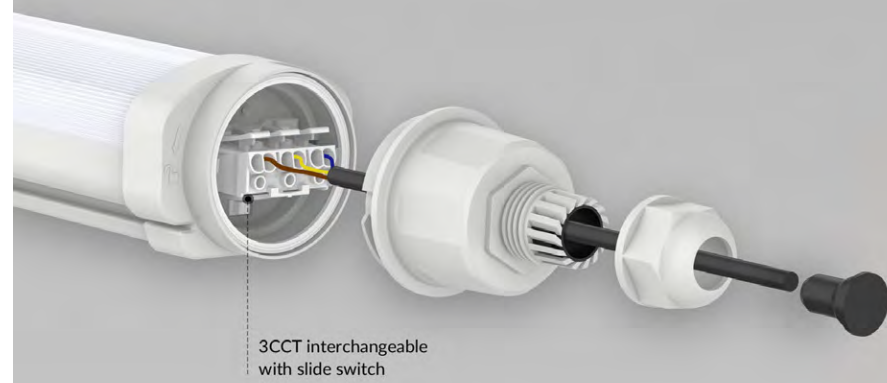
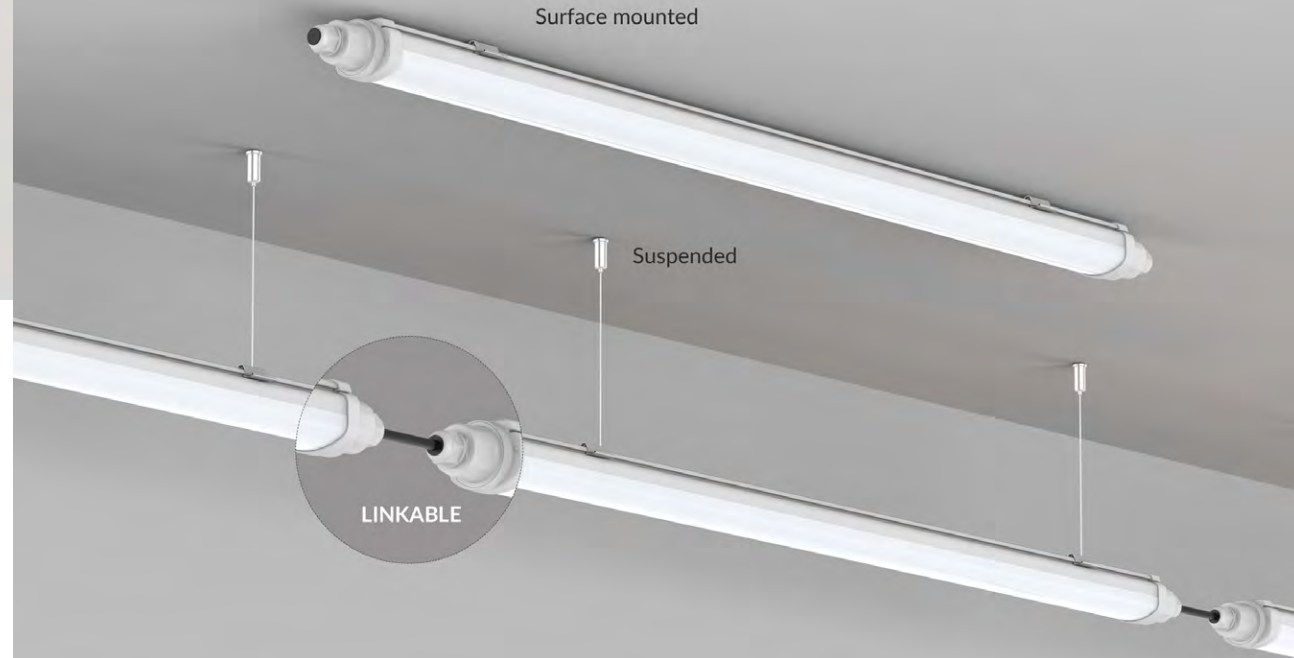

Wall mounted (DB169B non-linkable)



## IP65 IK08 DB169

LED Linear & Batten light



# DB145 Vapor proof

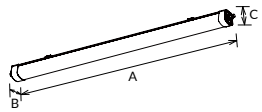

DB145 adopts high quality LED batten with high luminous efficacy 150lm/w, and flicker free driver. With a reliable and robust housing structure (IK08 & IP65), this maximizes the endurance and contributes to its long lifetime. With its flexible installation accessories, it can be installed for surface mount, pendant and splicing installation ways. 1200mm, 1500mm, 1800mm are available, it's an ideal replacement for traditional fluorescent batten.

Materials of Housing : PC

Materials of Optics : PC

- ▶
- ▶
- ▶
- ▶

| Code           | Watt | Size(AxBxCmm) | Lumen(±5%) | N.W/pc(kgs) | Q'ty/CTN |
|----------------|------|---------------|------------|-------------|----------|
| DB145-1200-38W | 38W  | 1200x77x69    | 5700lm     | 1.70        | 6PCS     |
| DB145-1500-52W | 52W  | 1500x77x69    | 8000lm     | 2.10        | 6PCS     |
| DB145-1500-68W | 68W  | 1500x77x69    | 9800lm     | 2.10        | 6PCS     |
| DB145-1800-68W | 68W  | 1800x77x69    | 10000lm    | 2.30        | 6PCS     |

CCT ——— 3000K ——— 4000K ——— 5700K

Finish ——— White

Installation accessories ——— Suspension kit

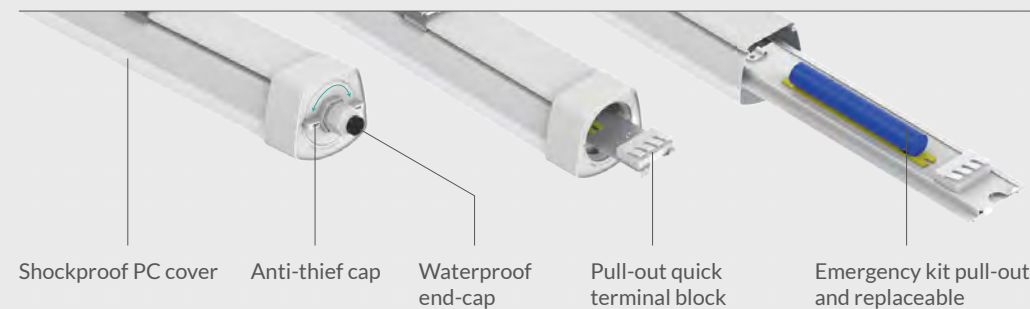

# TRP12 Vapor proof

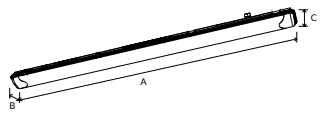

TRP12 LED tri-proof batten series adopts high lumen SMD to achieve 120lm/W. It is with width 89mm, IP65 waterproof and IK08 rating for special application. It can be two installations as surface mounted and suspended. Multiple functions: interchangeable power, emergency and microwave sensor.

Materials of Housing : PC  
Materials of Optics : PC

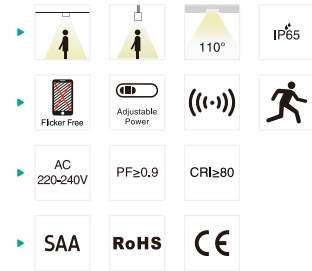

| Code              | Watt            | Size(AxBxCmm) | Lumen(±5%) | N.W/pc(kgs) | Q'ty/CTN |
|-------------------|-----------------|---------------|------------|-------------|----------|
| TRP12-600-20W-A4  | 20W/18W/15W/12W | 650x89x70     | 2450lm     | 0.80        | 12PCS    |
| TRP12-1200-40W-A4 | 40W/35W/30W/25W | 1260x89x70    | 5120lm     | 1.40        | 12PCS    |
| TRP12-1500-60W-A4 | 60W/55W/45W/35W | 1560x89x70    | 7800lm     | 1.70        | 9PCS     |
| TRP12-1800-72W-A4 | 72W/60W/55W/45W | 1824x89x70    | 9300lm     | 2.00        | 9PCS     |

CCT — 3000K — 4000K — 5700K

Installation accessories — Suspension kit

Finish — White

# TRP13 Vapor proof

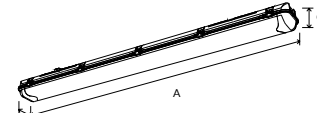

TRP13 LED tri-proof batten series adopts high lumen SMD to achieve 120lm/W and 150lm/W. It is with width 125mm, IP65 waterproof and IK08 rating for special application. It can be two installations as surface mounted and suspended. Multiple functions: interchangeable power, emergency and microwave sensor.

Materials of Housing : PC  
Materials of Optics : PC

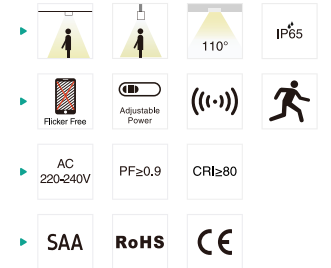

| Code              | Watt            | Size(AxBxCmm) | Lumen(±5%) | N.W/pc(kgs) | Q'ty/CTN |
|-------------------|-----------------|---------------|------------|-------------|----------|
| TRP13-600-20W     | 20W             | 680x125x86    | 120lm/w    | 1.00        | 8PCS     |
| TRP13-600-30W     | 30W             | 680x125x86    | 120lm/w    | 1.00        | 8PCS     |
| TRP13-600-30W-A4  | 17W/21W/26W/30W | 680x125x86    | 120lm/w    | 1.00        | 8PCS     |
| TRP13-1200-30W    | 30W             | 1280x125x86   | 120lm/w    | 1.80        | 6PCS     |
| TRP13-1200-50W    | 50W             | 1280x125x86   | 120lm/w    | 1.80        | 6PCS     |
| TRP13-1200-50W-A4 | 28W/35W/42W/50W | 1280x125x86   | 120lm/w    | 1.80        | 6PCS     |
| TRP13-1500-30W    | 30W             | 1580x125x86   | 120lm/w    | 2.20        | 6PCS     |
| TRP13-1500-60W    | 60W             | 1580x125x86   | 120lm/w    | 2.20        | 6PCS     |
| TRP13-1500-60W-A4 | 34W/42W/51W/60W | 1580x125x86   | 120lm/w    | 2.20        | 6PCS     |
| TRP13-600-10W     | 10W             | 680x125x86    | 150lm/w    | 1.00        | 8PCS     |
| TRP13-600-20W     | 20W             | 680x125x86    | 150lm/w    | 1.00        | 8PCS     |
| TRP13-600-20W-A4  | 12W/14W/17W/20W | 680x125x86    | 150lm/w    | 1.00        | 8PCS     |
| TRP13-1200-20W    | 20W             | 1280x125x86   | 150lm/w    | 1.80        | 6PCS     |
| TRP13-1200-40W    | 40W             | 1280x125x86   | 150lm/w    | 1.80        | 6PCS     |
| TRP13-1200-40W-A4 | 22W/28W/34W/40W | 1280x125x86   | 150lm/w    | 1.80        | 6PCS     |
| TRP13-1500-30W    | 30W             | 1580x125x86   | 150lm/w    | 2.20        | 6PCS     |
| TRP13-1500-60W    | 60W             | 1580x125x86   | 150lm/w    | 2.20        | 6PCS     |
| TRP13-1500-60W-A4 | 34W/42W/51W/60W | 1580x125x86   | 150lm/w    | 2.20        | 6PCS     |

CCT — 3000K — 4000K — 5700K

Installation accessories — Suspension kit

Finish — White



# TRP06 Vapor proof

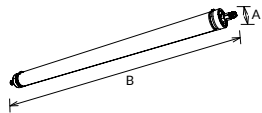

TRP06 adopts high lumen SMD chip and internal flicker free driver. With waterproof joint at both ends, it can be linkable. Special clip-on bracket design makes an easier installation. The installation angle is adjustable with different scales. A type as non-linkable, B type as linkable.

Materials of Housing : PC  
Materials of Optics : PC

- ▶ 140°
- ▶ IP69K IP66 IK10
- ▶ DALI 0-10V Flicker Free
- ▶ AC 220-240V PF≥0.9 CRI≥80
- ▶ SAA RoHS CE

| Code            | Watt | Size(AxBmm) | Lumen(±5%) | N.W/pc(kgs) | Q'ty/CTN |
|-----------------|------|-------------|------------|-------------|----------|
| TRP06A-600-20W  | 20W  | Ø75.2x600   | 2350lm     | 0.96        | 6PCS     |
| TRP06A-1200-33W | 33W  | Ø75.2x1200  | 4150lm     | 1.65        | 6PCS     |
| TRP06A-1500-45W | 45W  | Ø75.2x1500  | 5500lm     | 2.00        | 6PCS     |
| TRP06B-600-20W  | 20W  | Ø75.2x600   | 2350lm     | 0.96        | 6PCS     |
| TRP06B-1200-33W | 33W  | Ø75.2x1200  | 4150lm     | 1.65        | 6PCS     |
| TRP06B-1500-45W | 45W  | Ø75.2x1500  | 5500lm     | 2.00        | 6PCS     |

CCT — 3000K 4000K 5700K

Installation accessories — Suspension kit

Finish — White



# WL143 LED Cornice Fitting

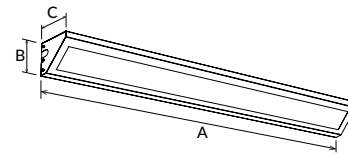

WL143 cornice luminaire gives a downward, angled light output. It has three cable entry holes on backward and knock hole in end cap which supports more possibility for different application cable connection.

Materials of Housing : Iron  
Materials of Optics : PC

- ▶ 110°
- ▶ IP20
- ▶ Flicker Free
- ▶ AC 220-240V PF≥0.9 CRI≥80
- ▶ SAA RoHS CE

| Code           | Watt | Size(AxBxCmm) | Lumen(±5%) | N.W/pc(kgs) | Q'ty/CTN |
|----------------|------|---------------|------------|-------------|----------|
| WL143-1500-40W | 40W  | 1460x110x110  | 4450lm     | 6.5         | 2PCS     |

CCT — 3000K 4000K 5700K

Finish — White





# LED Tube Light

/Series/

LED tube light more energy saving and high brightness are the first goal we are pursuing of all the time. Generous, simple and practical are what we have been working for. Brand Chip, CRI>80/90, high brightness more than 85LM/W, PC cover, Aluminium holder, EMI, EMC passed driver, high light transmittance are the main reason we win our reputation.



# T8-S NEW Tube light

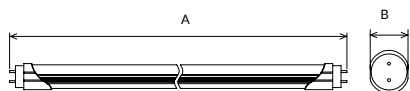

Tube is an integrated design, adopts 2835 SMD light source and CRI>80, combine with 94-V2 fire-rated PC shade to ensure a high transmittance and create a uniform light output. Environment friendly, without Mercury or any other hazardous substances.

Materials of Housing : Aluminium  
Materials of Optics : PC

- ▶ 120°
- ▶
- ▶
- ▶

| Code          | Watt | Size(AxBxCmm) | Lumen(±5%) | N.W/pc(kgs) | Q'ty/CTN |
|---------------|------|---------------|------------|-------------|----------|
| TB-10W-600-S  | 10W  | 603x32x29     | 1300lm     | 0.16        | 30PCS    |
| T8-18W-1200-S | 18W  | 1213x32x29    | 2350lm     | 0.26        | 30PCS    |

CCT ——— 3000K ——— 4000K ——— 5700K

Cover ——— Frosted



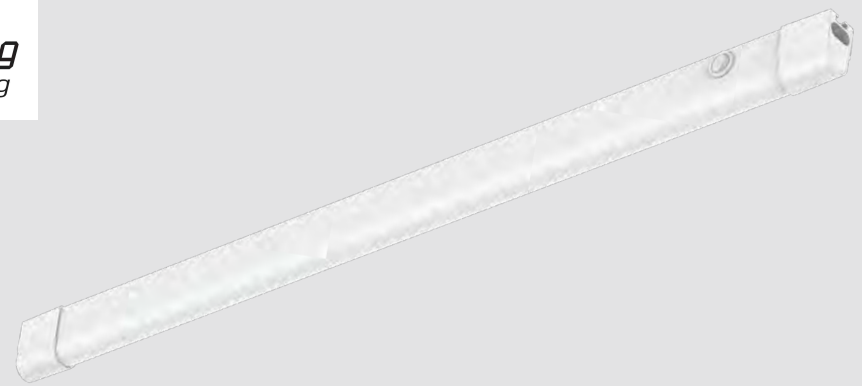

## T8-AL+PC Tube light

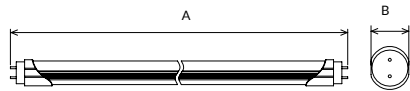

Upspine AL+PC LED Tube light adopts SMD LED with high brightness and slight light decay and V0 fire-rated PC cover, up to 95% light transmittance. Reliable LED driver with branded high quality capacitor and IC solution ensures excellent working performance.

Materials of Housing : Aluminium  
Materials of Optics : PC

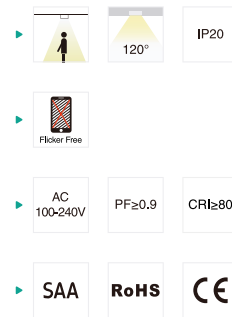

| Code        | Watt | Size(Ax Bmm) | Lumen(±5%) | N.W/pc(kgs) | Q'ty/CTN |
|-------------|------|--------------|------------|-------------|----------|
| T8-600-10W  | 10W  | 603xØ29.3    | 120lm/W    | 0.18        | 25PCS    |
| T8-1200-18W | 18W  | 1211xØ29.3   | 120lm/W    | 0.31        | 25PCS    |
| T8-1500-25W | 25W  | 1514xØ29.3   | 120lm/W    | 0.38        | 25PCS    |
| T8-600-6W   | 6W   | 603xØ29.3    | 150lm/W    | 0.18        | 25PCS    |
| T8-1200-12W | 12W  | 1211xØ29.3   | 150lm/W    | 0.31        | 25PCS    |
| T8-1500-15W | 15W  | 1514xØ29.3   | 150lm/W    | 0.38        | 25PCS    |
| T8-600-9W   | 9W   | 603xØ28.5    | 140lm/W    | 0.18        | 25PCS    |
| T8-900-10W  | 10W  | 907xØ28.5    | 140lm/W    | 0.21        | 24PCS    |
| T8-1200-18W | 18W  | 1211xØ28.5   | 140lm/W    | 0.31        | 25PCS    |
| T8-1500-23W | 23W  | 1514xØ28.5   | 140lm/W    | 0.38        | 25PCS    |
| T8-600-8W   | 8W   | 603xØ28.5    | 160lm/W    | 0.18        | 25PCS    |
| T8-900-9W   | 9W   | 907xØ28.5    | 160lm/W    | 0.21        | 24PCS    |
| T8-1200-16W | 16W  | 1211xØ28.5   | 160lm/W    | 0.31        | 25PCS    |
| T8-1500-20W | 20W  | 1514xØ28.5   | 160lm/W    | 0.38        | 25PCS    |
| T8-600-7W   | 7W   | 603xØ28.5    | 180lm/W    | 0.18        | 25PCS    |
| T8-900-8W   | 8W   | 907xØ28.5    | 180lm/W    | 0.21        | 24PCS    |
| T8-1200-14W | 14W  | 1211xØ28.5   | 180lm/W    | 0.31        | 25PCS    |
| T8-1500-16W | 16W  | 1514xØ28.5   | 180lm/W    | 0.38        | 25PCS    |

CCT — 3000K — 4000K — 5700K

Cover — Clear — Frosted

## T5-S Tube light

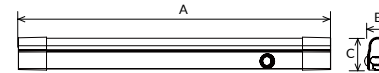

Integrated complete PC LED tube T5-S is a successful economic design. Adopt high lumen SMD LED as light source, full PC cover (pass 750C° glow-wire test) ensures high light transmittance and safe installation. Changeable CCT and IP42 protection level also make it easier maintenance. Special installation: Surface mounted and wall mounted with different accessories. Linkable design with connect wires or connect accessories, which is suitable for a wider application.

Materials of Housing : PC  
Materials of Optics : PC

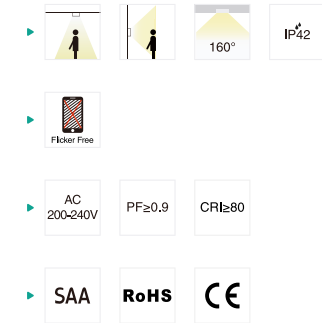

| Code         | Watt | Size(AxBxCmm)  | Lumen(±5%) | N.W/pc(kgs) | Q'ty/CTN |
|--------------|------|----------------|------------|-------------|----------|
| T5-5W355-S   | 5W   | 355x22.3x37.4  | 535lm      | 0.18        | 50PCS    |
| T5-8W600-S   | 8W   | 600x22.3x37.4  | 980lm      | 0.25        | 50PCS    |
| T5-18W1200-S | 18W  | 1200x22.3x37.4 | 2205lm     | 0.37        | 30PCS    |
| T5-25W1500-S | 25W  | 1500x22.3x37.4 | 3045lm     | 0.43        | 30PCS    |

CCT — 3000K — 4000K — 5700K

Cover — Frosted