



FLOS

COLLECTION CATALOGUE 2026

ENGLISH / ESPAÑOL

FEATURED PRODUCTS	SOPHISTICATED COMMODITIES	SOFT ARCHITECTURE
12 • THE GLOWING TRACK	606 IN-FINITY	632 JUNCOS
52 MY CIRCUIT	610 CIRCLE OF LIGHT	634 SOFT SPUN
76 BELT	611 LIGHT CUT MINI	636 ABAJOURD'HUI
98 INFRA-STRUCTURE	612 LIGHT BELL	638 USO
122 GUSTAVE	614 THIN LED	640 USO COVE LIGHTING
140 EMI	616 LIGHT SUPPLY	642 G-O IN
164 OBLIQUE	618 JOHNNY	644 TEARDROP
186 • ZERO TRACK PRO	622 WAN	646 ROUND, SQUARE & VERTICAL LIGHT
220 ZERO TRACK	624 G-O	
238 THE MICRO RUNNING MAGNET	624 THEBLOCKOFLIGHT	
264 THE RUNNING MAGNET		
294 THE TRACKING MAGNET		
322 THE TRACKING POWER EVO		
338 THE FAST TRACK		
352 • WORKMATES		
378 • LIGHT SHADOW MINI		
398 LIGHT SHADOW		
420 LIGHT SHADOW DOTS & PRO		
444 ECLECTIC		
458 LIGHT SHADOW SPOT		
472 • MY SPOT		
488 SUPER LINE & SUPERLINE PRO		
506 KAP		
540 C1		
556 FIND ME		
570 UT		
588 BON JOUR		
596 FORT KNOX		

- New product/Novedad

Flos aim is to offer always the best reliable technology available, constantly reviewing our products and upgrading them as soon as technologic evolutions offers benefits for our partners and clients. Thus, when you need technical details and the most recent product information, please browse the product section of our daily updated website flos.com.

El objetivo de Flos es ofrecer siempre la tecnología más fiable disponible, revisando constantemente nuestros productos y actualizándolos en cuanto la evolución tecnológica ofrece beneficios para nuestros socios y clientes. Por lo tanto, si necesita datos técnicos y la información de producto más actualizada, navegue por la sección de productos de nuestra página web flos.com, que se actualiza todos los días.



THE GLOWING TRACK
12



OBLIQUE
OBLIQUE FLOOR
164



MY CIRCUIT
52



ZERO TRACK PRO
186

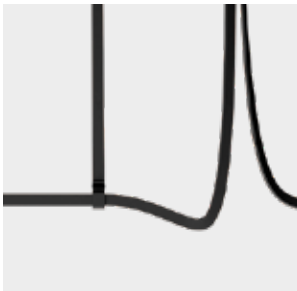

BELT
76

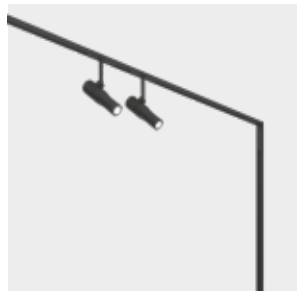

ZERO TRACK
220

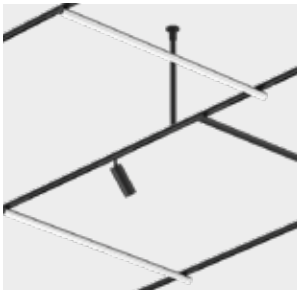

INFRA-STRUCTURE
98



THE MICRO RUNNING
MAGNET
238



GUSTAVE
122



THE RUNNING MAGNET
264



EMI
140



THE TRACKING MAGNET
294

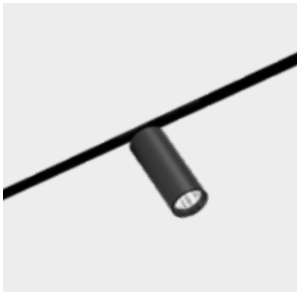

THE TRACKING POWER
EVO
322

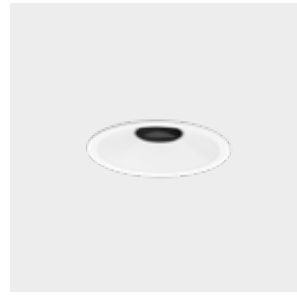

ECLECTIC
444



THE FAST TRACK
338



LIGHT SHADOW SPOT
458



WORKMATES
352



MY SPOT
472

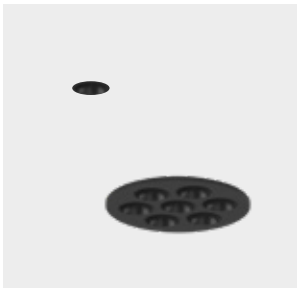

LIGHT SHADOW MINI
378

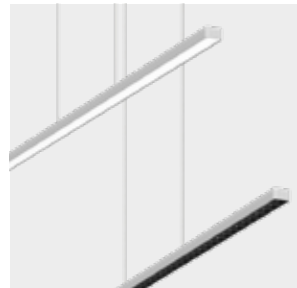

SUPER LINE
SUPER LINE PRO
488



LIGHT SHADOW
398



KAP
EASY KAP
KAP SURFACE
KAP SUSPENSION
506



LIGHT SHADOW PRO
LIGHT SHADOW DOTS
420

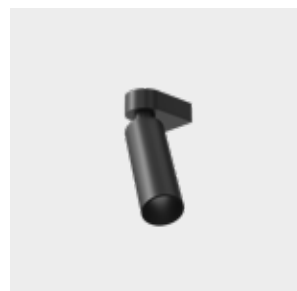

C1
540



FIND ME
556



LIGHT CUT MINI
611

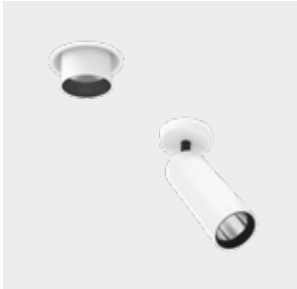

UT SPOT
UT DOWNLIGHT
UT PRO SURFACE
570

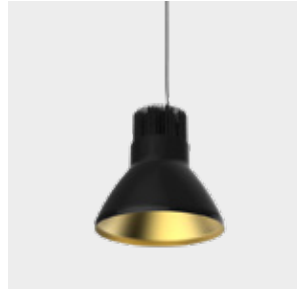

LIGHT BELL
612



BON JOUR
588



THIN LED
614



FORT KNOX WALL
FORT KNOX WALL MINI
596



LIGHT SUPPLY
616

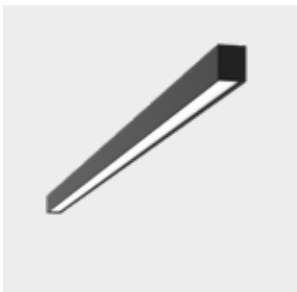

IN-FINITY
606



JOHNNY
618



CIRCLE OF LIGHT
610

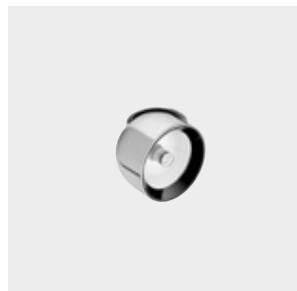

WAN SPOT
622

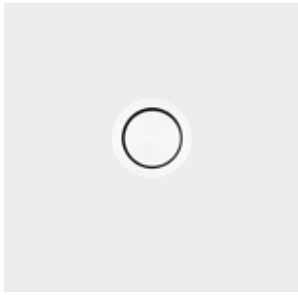

G-O
624

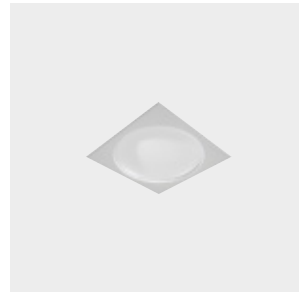

USO COVE LIGHTING
640

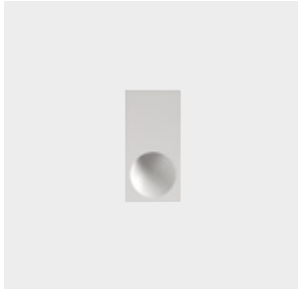

THEBLOCKOFLIGHT
624



G-O IN
642



JUNCOS
632

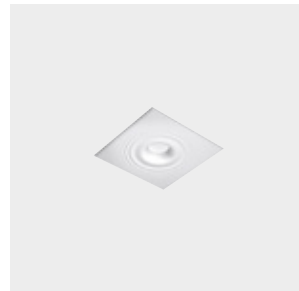

TEARDROP
644



SOFT SPUN
634

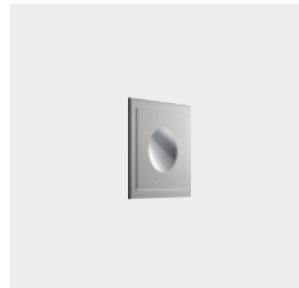

ROUND, SQUARE &
VERTICAL LIGHT
646



ABAJOURD'HUI
636



USO
638

The Glowing Track, My Circuit, Belt, Infra-Structure, Gustave, EMI, Oblique, Zero Track, Zero Track Pro, The Micro Running Magnet, The Running Magnet, The Tracking Magnet, The Tracking Power EVO, The Fast Track, Workmates, Light Shadow Mini, Light Shadow, Light Shadow Dots, Light Shadow Pro, Eclectic, Light Shadow Spot, My Spot, Super Line, Super Line Pro, Kap, C1, Find Me, UT, Bon Jour, Fort Knox Wall.

FEATURED PRODUCTS

THE

GLOWING
GLOWING
GLOWING
GLOWING
GLOWING
GLOWING
GLOWING
GLOWING
GLOWING
GLOWING
GLOWING
GLOWING

TRACK

Modular and versatile lighting system that combines innovation, high performance and sophisticated design into a single solution. It offers immersive ambient lighting that integrates harmoniously into the environment, providing homogeneous and balanced illumination.

Sistema de iluminación modular y versátil que combina innovación, alto rendimiento y diseño sofisticado en una única solución. Ofrece una iluminación ambiental envolvente que se integra armoniosamente en el entorno, proporcionando una iluminación homogénea y equilibrada.

THE GLOWING TRACK







The Glowing Track is available in suspended and surface-mounted versions (with or without integrated driver), adaptable to various conditions, making it the ideal choice for any architectural project.

El Glowing Track está disponible en versiones suspendidas y de superficie (con o sin conductor integrado), adaptables a diversas condiciones, lo que lo convierte en la opción ideal para cualquier proyecto arquitectónico.



- 1 SURFACE REMOTE DRIVER
- 2 SURFACE
- 3 SUSPENSION







1. The Glowing Track Surface Remote Driver
2. The Glowing Track Suspension
3. The Glowing Track Suspension 360°
4. The Glowing Track Vertical 360°
5. Linear Joint
6. Corner Joint 2
7. Corner Joint 3

Profiles are designed with an efficient assembly system that ensures precise and secure connections, ideal for projects requiring versatile and scalable solutions without compromising on quality or aesthetics.

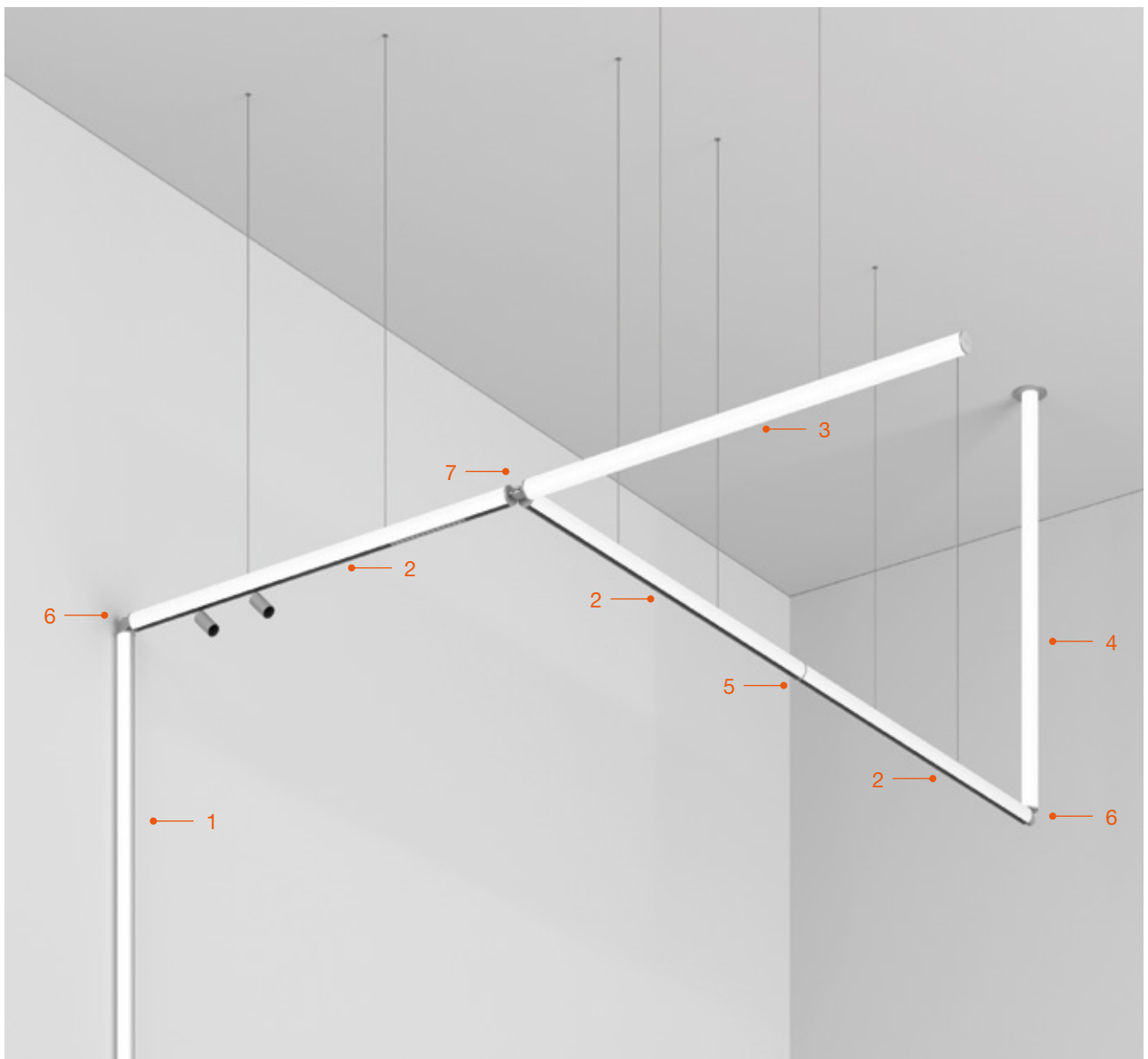
Los perfiles están diseñados con un sistema de ensamblaje eficiente que asegura conexiones precisas y seguras, ideales para proyectos que requieren soluciones flexibles y escalables sin comprometer la calidad o la estética.





Designed to offer maximum flexibility, this profile pairs the functionality of a hidden track with a sophisticated lateral light distribution that creates a warm and immersive atmosphere. A wide range of projectors and accent lighting modules is available to meet any project requirements.

Diseñado para ofrecer máxima flexibilidad, este perfil combina la funcionalidad de una guía oculta con una distribución de luz lateral sofisticada que crea un ambiente cálido e inmersivo. Está disponible una amplia gama de proyectores y módulos de iluminación de acento para satisfacer cualquier requisito del proyecto.





Equipped with a special multi-ribbed diffuser that provides even, balanced light, it minimises glare and softens shadows by design.

Equipado con un difusor especial de múltiples nervaduras que proporciona una luz uniforme y equilibrada, minimiza el deslumbramiento y suaviza las sombras de manera intencionada.

For accent lighting, choose between invisible MultiSpot mini modules hidden within the profile or ultra-flexible spots to highlight objects in any space.

Para la iluminación de acento, elige entre los módulos del Multi Spot Mini, invisibles dentro del perfil o los spots ultra-flexibles para resaltar objetos en cualquier espacio.

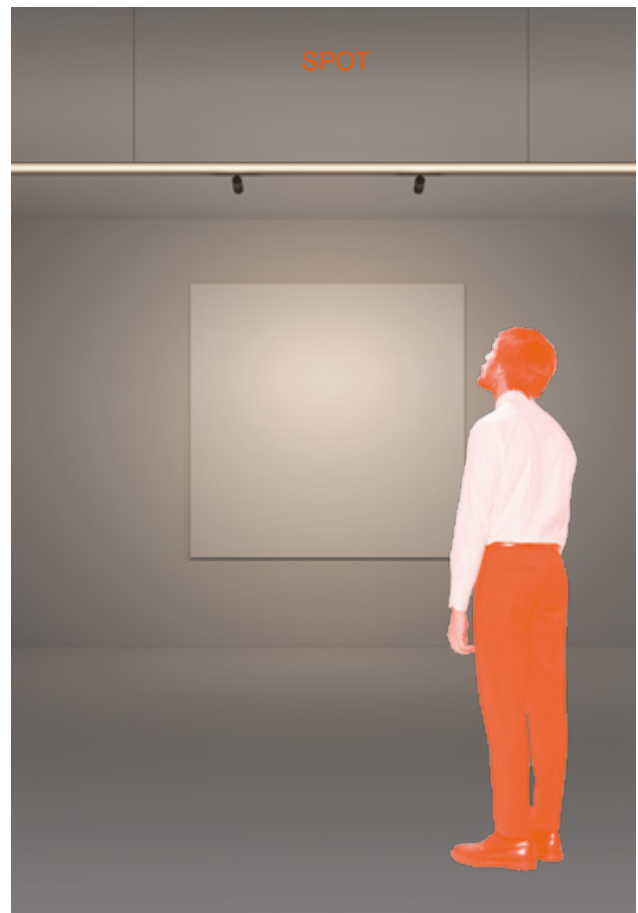
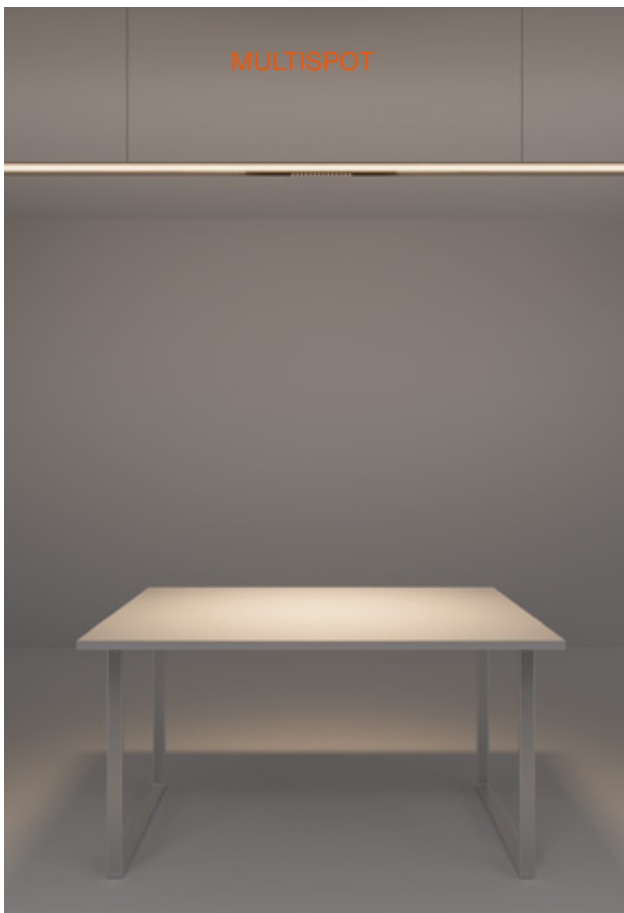







THE GLOWING TRACK 360

The 360° profile creates cosy and balanced spaces, enhancing the architecture with a soft, pleasant light, ideal for fostering a sense of wellbeing and comfort in any environment.

El perfil de 360° crea espacios acogedores y equilibrados, realizando la arquitectura con una luz suave y agradable, ideal para fomentar una sensación de bienestar y confort en cualquier entorno.

A 360° light ensures uniform illumination in all directions, eliminating harsh shadows and providing consistent brightness.

Una luz de 360° asegura una iluminación uniforme en todas direcciones, eliminando sombras duras y proporcionando un brillo constante.

THE GLOWING TRACK BLIND

Developed for areas where ambient lighting is not required, focusing on accent illumination through spotlights and accent lighting modules that can be installed on the track, providing dynamic solutions to highlight architectural features and emphasize specific areas.

Desarrollado para áreas donde no se requiere iluminación ambiental, centrándose en la iluminación de acento mediante focos y módulos de iluminación de acento que se pueden instalar en la vía, proporcionando soluciones dinámicas para resaltar características arquitectónicas y enfatizar áreas específicas.

The profile serves as a decorative element thanks to its exclusive range of finishes.

Sirve como un elemento decorativo gracias a su variedad de acabados y se enfoca exclusivamente en iluminar el espacio.





All profiles are available in three lengths (1200 mm, 1800 mm and 2400 mm), with a diameter of just 47 mm. They come in three models: Light + Track, 360° Light and Track Only.

Todos los perfiles están disponibles en tres longitudes (1200 mm, 1800 mm y 2400 mm), con un diámetro de solo 47 mm. Se ofrecen en tres modelos: Luz + Carril, Luz 360° y Solo Carril.

MODELS



THE GLOWING TRACK



THE GLOWING TRACK 360



THE GLOWING TRACK BLIND

SIZES

*600 mm



1200 mm



1800 mm



2400 mm



*Available only in The Glowing Track 360° Surface Remote Driver.

*Disponible solo en The Glowing Track 360° Surface Remote Driver.









SUSPENDED INSTALLATION

The suspended installation offers extraordinary design freedom, providing various solutions for driver management. You can choose a remote kit for a minimalist finish, a surface kit, or a recessed kit with an integrated driver.

La instalación suspendida brinda una extraordinaria libertad de diseño, ofreciendo diversas soluciones para la gestión del driver. Es posible optar por un kit remoto para lograr un acabado minimalista, un kit de superficie o un kit empotrado con driver integrado.



SURFACE MOUNTED

Surface installation offers the option of an integrated or remote driver. The driver compartment remains out of view thanks to a sleek, unobtrusive design, ensuring the profile appears elegant and compact. Its versatile design enables quick, seamless integration into a variety of settings.

La instalación en superficie ofrece la opción de un controlador integrado o remoto. El compartimento del controlador permanece fuera de la vista gracias a un diseño elegante y discreto, que garantiza un perfil elegante y compacto. Su diseño versátil permite una integración rápida y perfecta en diversos entornos.

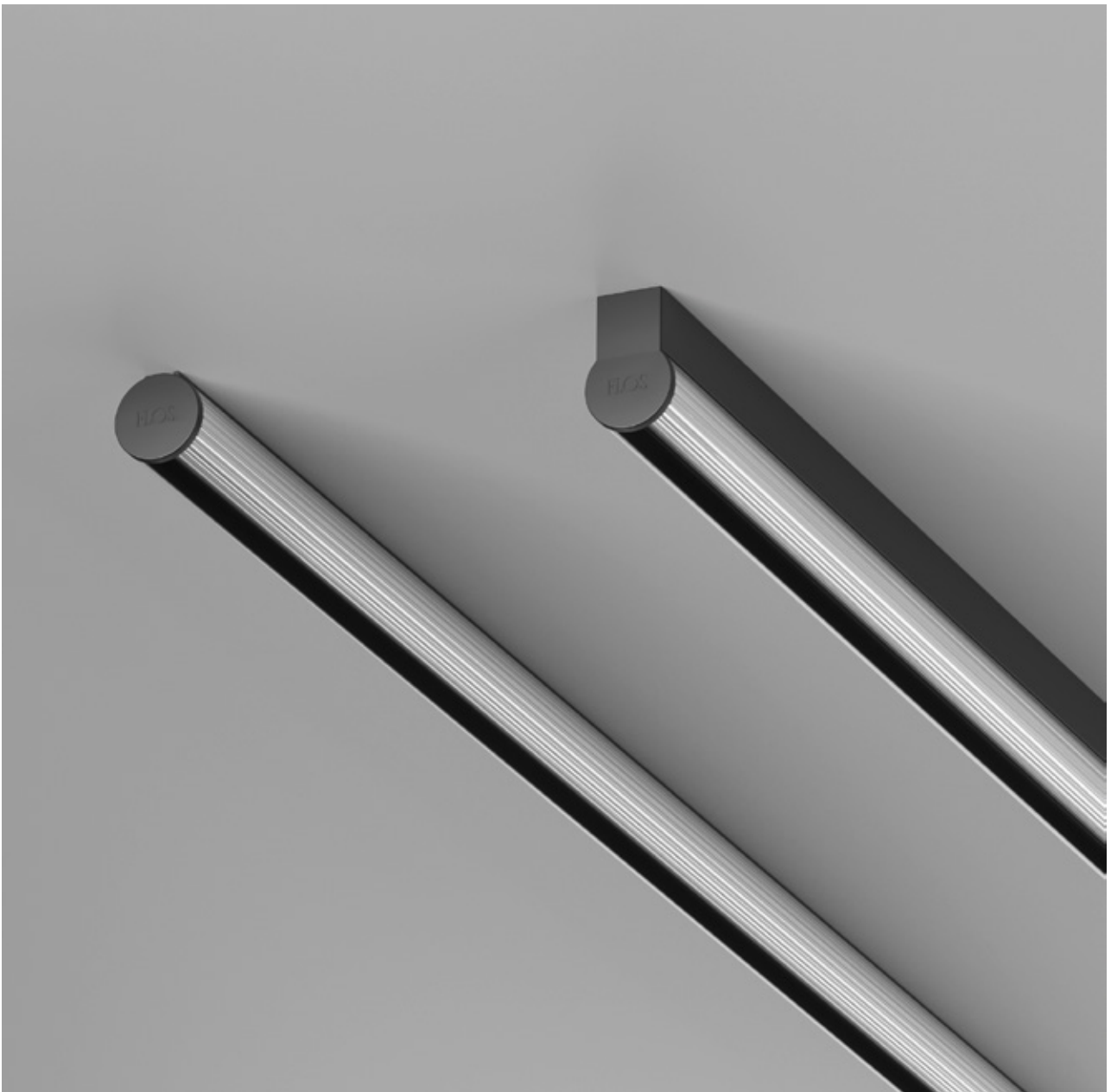

Installation examples

- 1 Surface version with remote driver
- 2 Surface version with integrated driver

Ejemplos de instalación

- 1 Versión de superficie con driver integrado
- 2 Versión de superficie con driver remoto

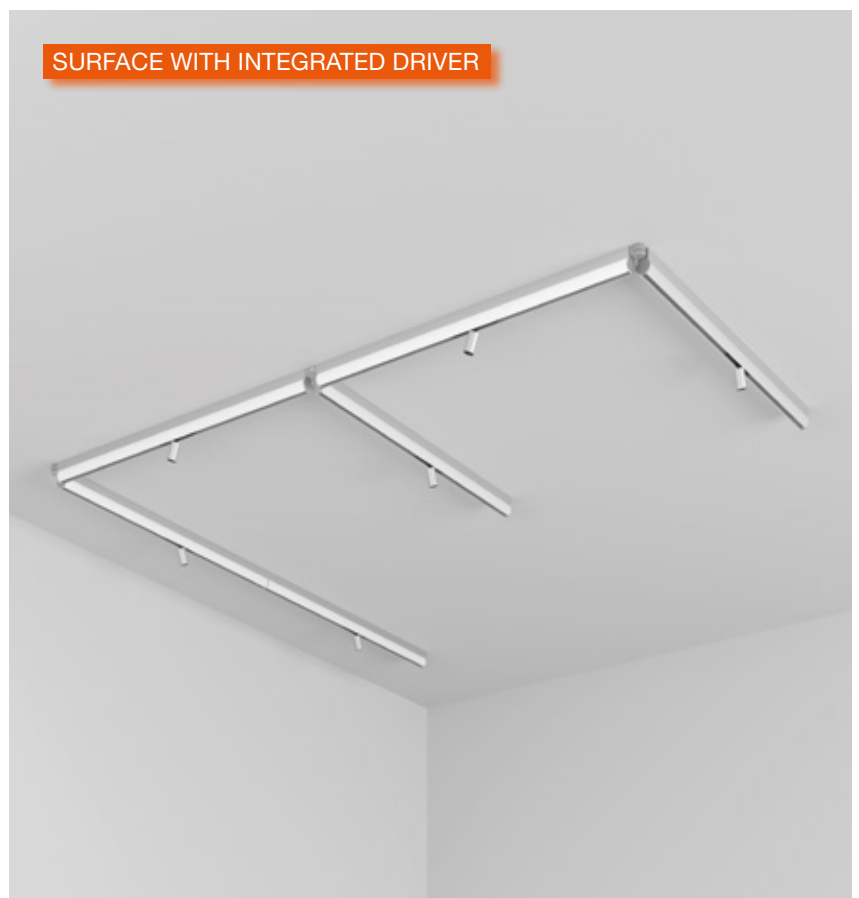





VERTICAL INSTALLATION

Vertical modules can redefine the aesthetics of an interior, playing with heights and shaping spaces with new immersive lighting atmospheres. This configuration integrates effortlessly into architectural designs, using the Glowing Track as a ceiling-suspended lighting column to open up endless possibilities.

Los módulos verticales pueden redefinir la estética de un interior, jugando con las alturas y configurando los espacios con nuevas atmósferas de iluminación inmersivas. Esta configuración se integra sin esfuerzo en los diseños arquitectónicos, utilizando The Glowing Track como una columna de iluminación suspendida del techo para abrir un sinfín de posibilidades.







FLUSH ACCENT LIGHTING

Accent lighting modules can be fully recessed into the track, maintaining a uniform, refined aesthetic. This seamless integration allows for continuous, uninterrupted light, making it ideal for projects that demand a clean design and homogeneous ambient lighting with impeccable task illumination.

Los módulos de iluminación de acento pueden encastrarse totalmente en el carril, manteniendo una estética uniforme y refinada. Esta integración perfecta permite una luz continua e ininterrumpida, por lo que es ideal para proyectos que exigen un diseño limpio y una iluminación ambiental homogénea con una iluminación de tareas impecable.

SPOTLIGHTS SOLUTIONS

Alongside a cosy, diffused lighting effect, the Glowing Track also accommodates compact projectors, offering even greater flexibility in lighting design. These tools stand out for their precision and adaptability, enabling focused, high-performance lighting that enhances architectural elements or defined zones.

Además de un efecto luminoso acogedor y difuso, The Glowing Track también admite proyectores compactos, lo que ofrece una flexibilidad aún mayor en el diseño de la iluminación. Estas herramientas destacan por su precisión y adaptabilidad, permitiendo una iluminación focalizada y de alto rendimiento que realza los elementos arquitectónicos o las zonas definidas.



FIND ME

The Glowing Track luminaire range includes the Find Me spots designed by Jorge Herrera, available in three sizes.

La gama de luminarias para The Glowing Track incluye los proyectores Find Me diseñados por Jorge Herrera, disponibles en tres tamaños.

ATOM

With the distinctive design flair of Piero Lissoni, Atom is a series of spotlights in two different sizes, perfect for accent lighting.

Con el inconfundible estilo de diseño de Piero Lissoni, Atom es una serie de focos en dos tamaños diferentes, perfectos para la iluminación de acento.





Thanks to the unique patented optical solution, Light Shadow Spot controls extreme cut-off angles without altering the high efficiency and incredible versatility of the product.

Gracias a la exclusiva solución óptica patentada, Light Shadow Spot controla ángulos de cut-off extremos, sin sacrificar la alta eficiencia y la increíble versatilidad del producto.



The Multi Spot Mini is a 12-LED module with low glare, combining a compact design with powerful lighting capabilities. This module offers an elegant and efficient solution with precise light control, directing brightness outward without unwanted reflections.

Multi Spot Mini es un módulo de 12 LED de bajo deslumbramiento que combina un diseño compacto con potentes prestaciones de iluminación. Este módulo ofrece una solución elegante y eficiente con un control preciso de la luz, dirigiendo el brillo hacia el exterior sin reflejos no deseados.



Available in an exclusive high-quality finish palette – White, Black, Bronze and Steel – the Glowing Track integrates seamlessly into high-end interiors, elevating the aesthetics of any space with quiet sophistication.

Disponible en una exclusiva gama de acabados de alta calidad (blanco, negro, bronce y acero), The Glowing Track se integra a la perfección en interiores de alta gama, elevando la estética de cualquier espacio con una elegancia sutil.

Track Finish / Acabado del Perfil



White

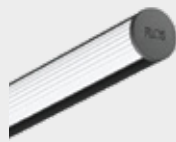

Black

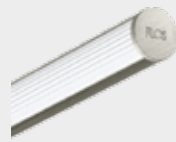

Brushed Steel

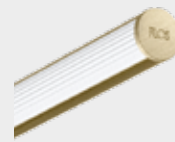

Brushed Bronze

Spot Finish / Acabado del Spot



White



Black



Brushed Steel



Brushed Bronze

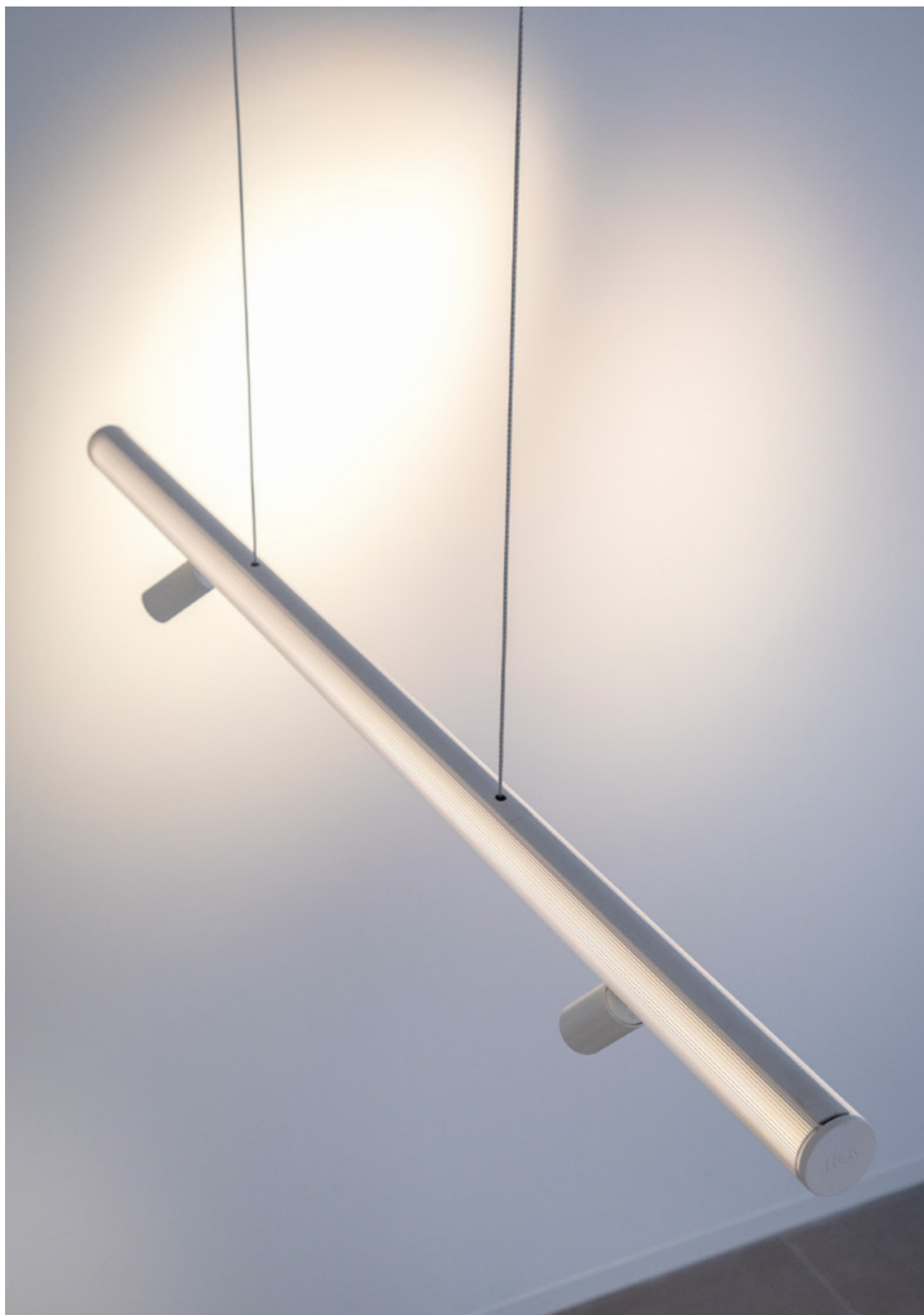

Thanks to the control options, the profiles can be adjusted independently, managing each side separately, as well as the modules installed on the track.

Gracias a las opciones de control, los perfiles pueden ajustarse de manera independiente, gestionando cada lado por separado, así como los módulos instalados en el carril.

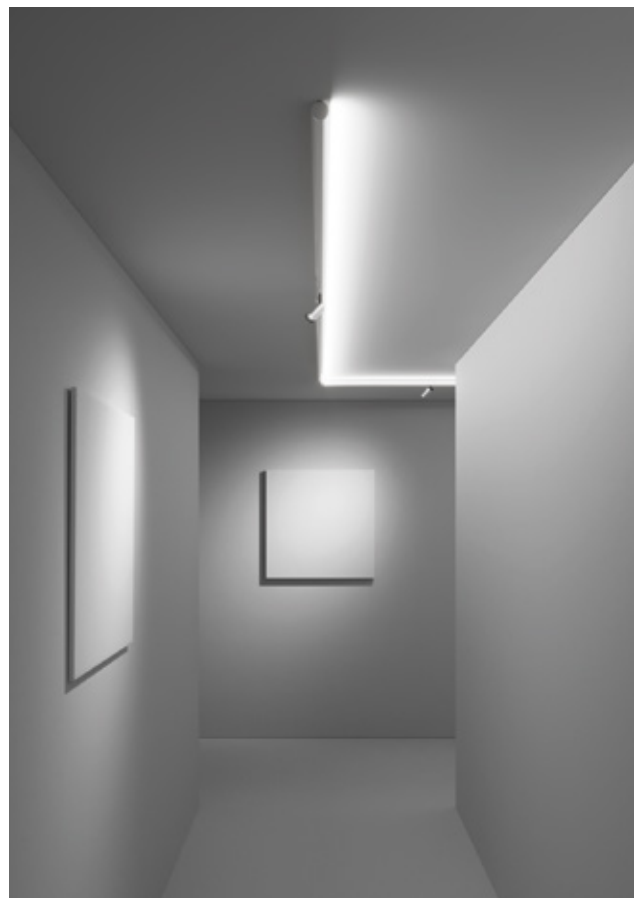
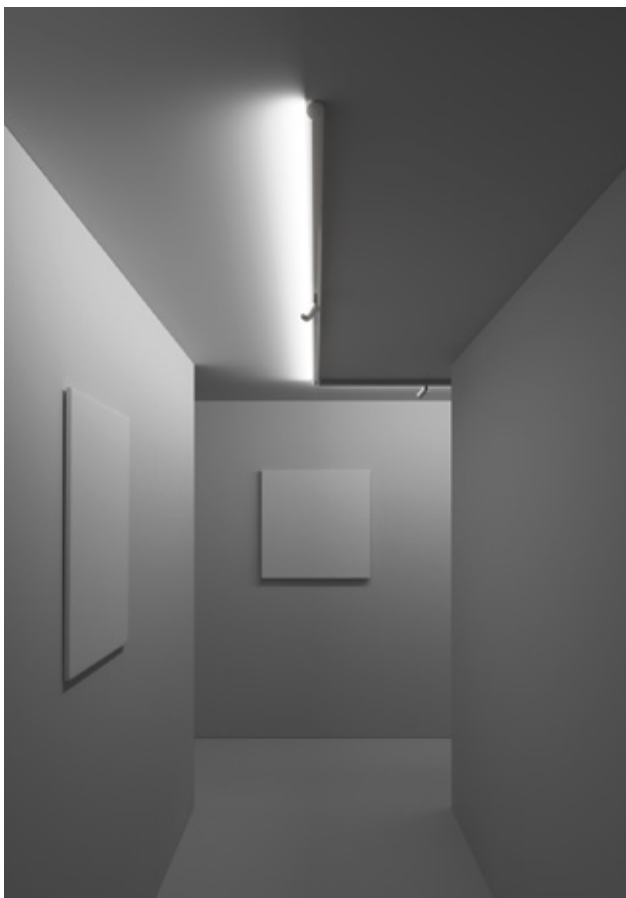
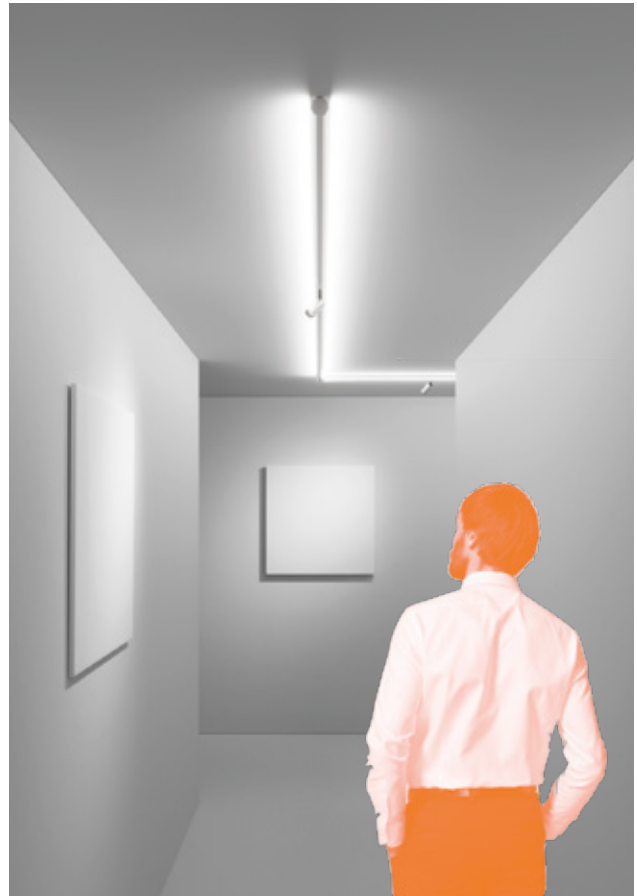

Different dimming control options for The Glowing Track, available for models with remote driver or surface versions with integrated driver.

Diferentes opciones de control de regulación para The Glowing Track, disponibles para los modelos con driver remoto o versiones de superficie con driver integrado.

DALI	Standard protocol for integration with any control system.	Protocolo estándar para la integración con cualquier sistema de control.
CASAMBI	Track control trough a dimmer device. Track wireless control trough the FLOS Control®, available iOS and Android devices.	Control de pista a través de un dispositivo dimmer. Control inalámbrico de la pista a través de la aplicación FLOS Control®, disponible para dispositivos iOS y Android.

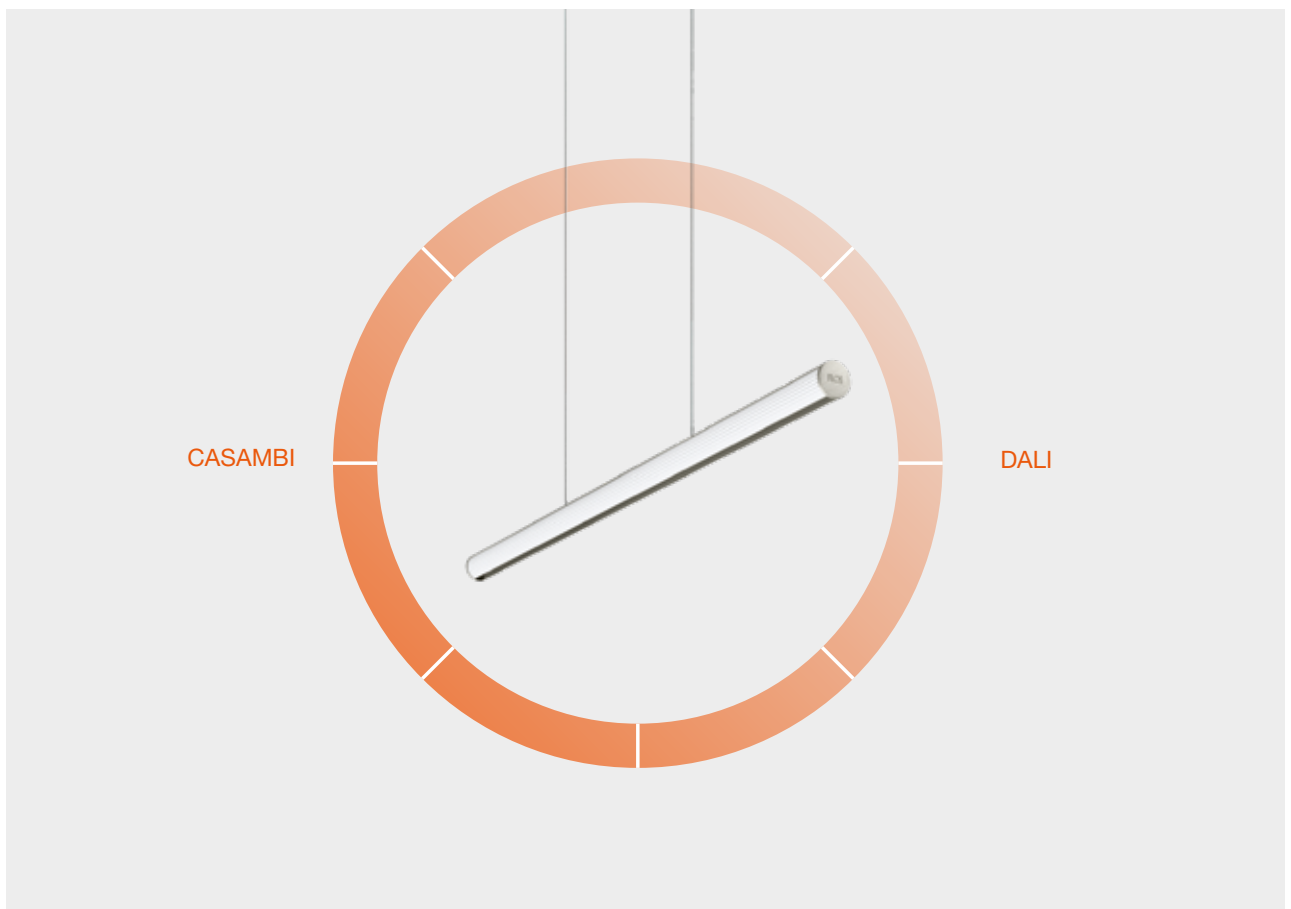

LIGHT MODULES

FIND ME 0



POWER LED
3,5W

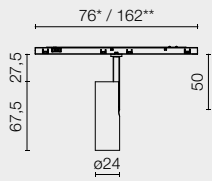

FIND ME 1



POWER LED
5,5W

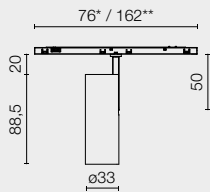

FIND ME 2



POWER LED
10,5W

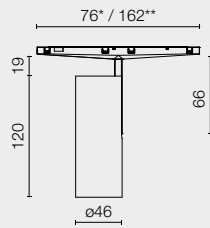

MULTI SPOT MINI



POWER LED
6,1W

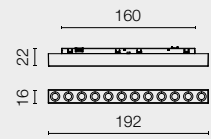

LIGHT SHADOW
SPOT 30



POWER LED
4,7W

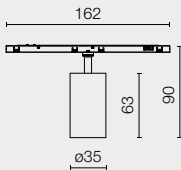

LIGHT SHADOW
SPOT 45



LED ARRAY
11W

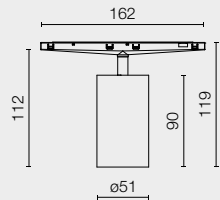

ATOM 90



POWER LED
5,5W

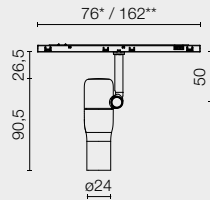

ATOM 120



POWER LED
8W

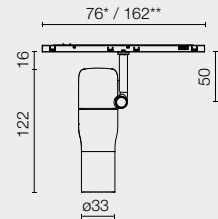

* Non Dimmable, Casambi / ** Dali



Spot



Medium



Flood



Wide Flood

TRACK MODULES

SURFACE
REMOTE DRIVER



SURFACE
INTEGRATED DRIVER

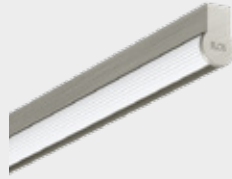

SUSPENSION

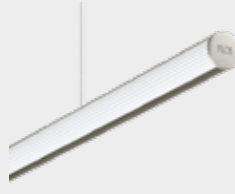

VERTICAL



360 SURFACE
REMOTE DRIVER



360 SURFACE
INTEGRATED DRIVER



360 SUSPENSION



360 VERTICAL



BLIND SURFACE
REMOTE DRIVER

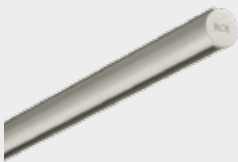

BLIND SURFACE
INTEGRATED DRIVER



BLIND SUSPENSION

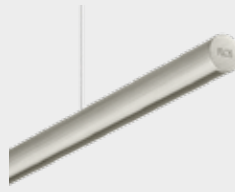

BLIND VERTICAL



TOP LED
Up to 49,6W

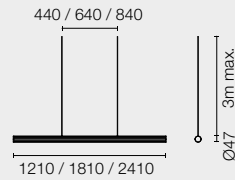
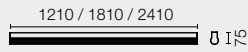

My Circuit, designed by Michael Anastassiades, is the first structure for indoor lighting consisting of a flexible profile that allows the drawing of continuous and completely free paths on the ceiling, combining linear sections with curves of various radii.

MyCircuit, diseñado por Michael Anastassiades, es la primera estructura para iluminación de interiores compuesta por un perfil flexible que permite dibujar en el techo recorridos continuos y completamente libres, combinando formas de línea recta con curvas de diferente radio.

MY CIRCUIT

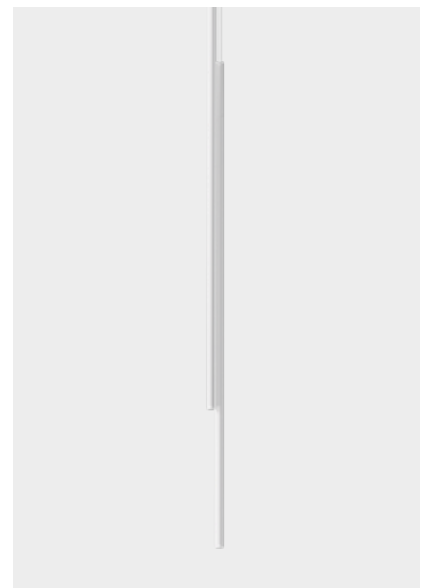
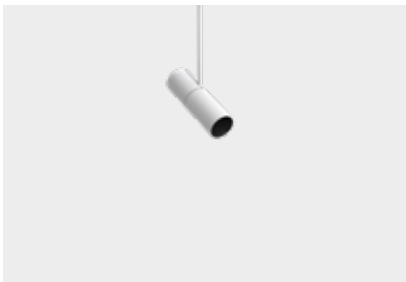

When designing a layout, the fixing modules to be joined together must be chosen and combined consecutively until a central spine is drawn up that is mounted on the ceiling and defines the shape of My Circuit.

Once this layout is completed and installed on the ceiling, you obtain the total length of the central spine. The flexible profile is then installed onto this. Finally come the accessories and luminaires.

Para diseñar un trazado se deben seleccionar y combinar de manera consecutiva los módulos de fijación que se unirán entre sí hasta dibujar una espina central que se fija en el techo y define la forma de MyCircuit. Completado el trazado -e instalado éste en el techo-, se obtiene la longitud total del recorrido de la espina central. Sobre ella se instalará el perfil flexible. Por último, los accesorios y luminarias.

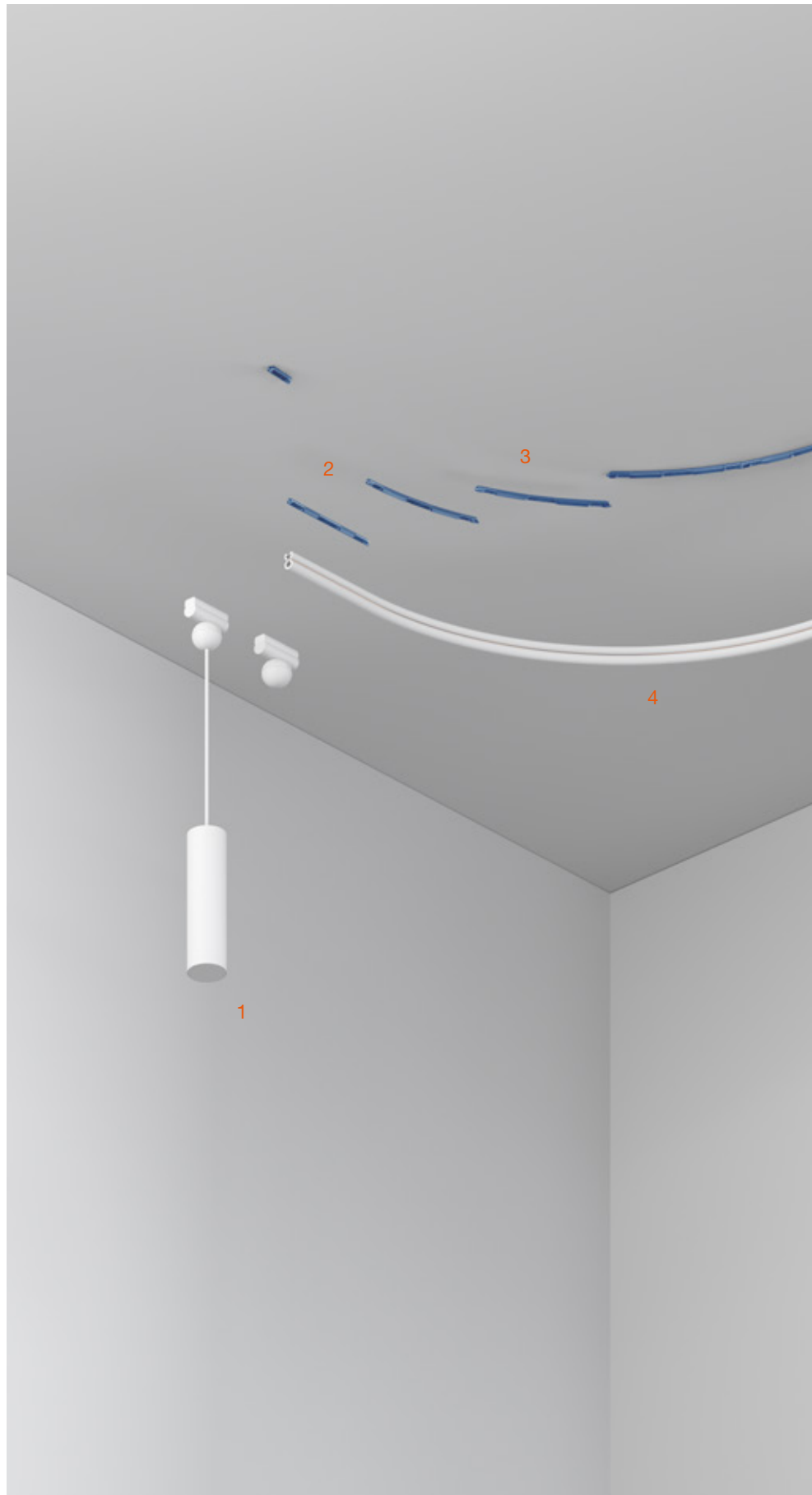

- 1 POWER SUPPLY END
- 2 FIXATION STRAIGHT
- 3 FIXATION CURVES
- 4 MY CIRCUIT PROFILE
- 5 POWER SUPPLY MIDDLE
- 6 MIDDLE CAP
- 7 SPOTS
- 8 SUSPENSION FIXTURES
- 9 END CAP

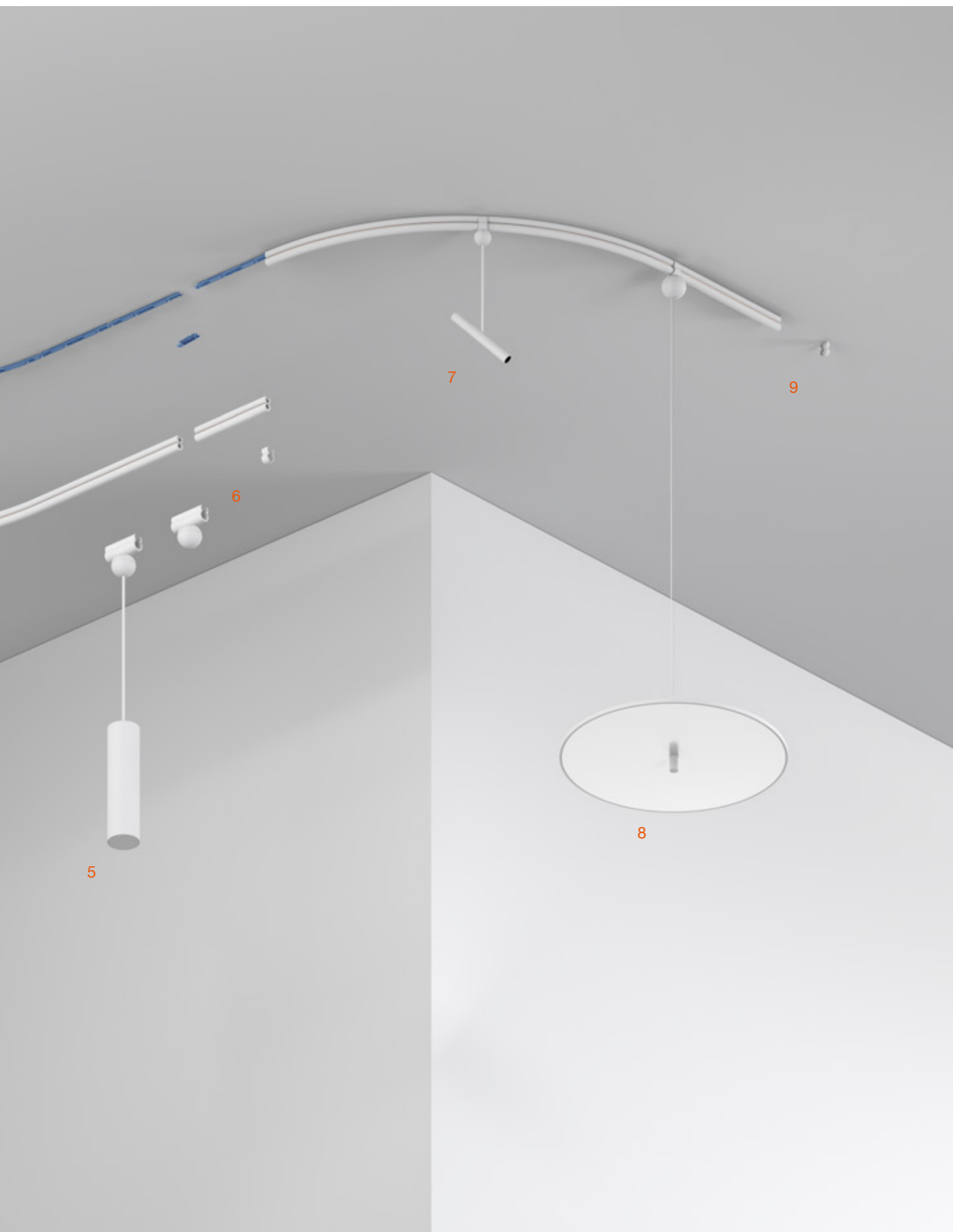

My Circuit offers a functional approach to decorative lighting. A flexible ceiling system, My Circuit is inspired by electric slot cars from Anastassiades' childhood, whose elements are used to redesign a contemporary, minimalist take on plaster motifs found on the ceiling of period homes.

My Circuit ofrece un enfoque funcional de la iluminación decorativa. El sistema de techo flexible My Circuit está inspirado en los coches de slot eléctricos de la infancia de Anastassiades, cuyos elementos se han utilizado para rediseñar una versión contemporánea y minimalista de los motivos de yeso característicos de los techos de las casas de época.









SPOTS

My Circuit comes with two projector families: the elegant My Spots, designed by Michael Anastassiades, and the My Light Shadow Spots, with the well-known technical features of the Light Shadow family of products.

My Circuit cuenta con dos familias de proyectores: los elegantes My Spots, diseñados por Michael Anastassiades, y los My Light Shadow Spots, con las conocidas prestaciones técnicas de la familia de productos Light Shadow.

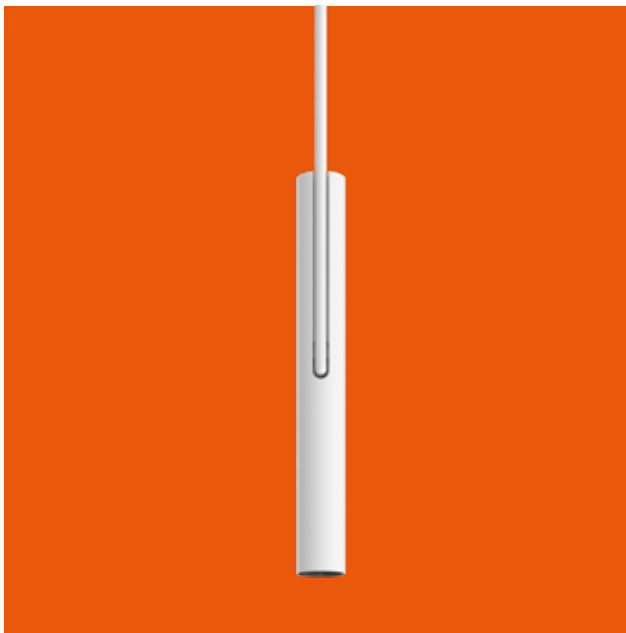

MY DISC & MY LINES

My Disc is a slim Down emission luminaire for downlight and ambient illumination. My Lines allows you to suspend a luminaire from My Circuit, which in functional terms acts as a floor lamp in the space.

My Disc es una esbelta luminaria de emisión Down para obtener una iluminación downlight y ambiental.

My Lines permite suspender de My Circuit una luminaria que -funcionalmente- actúa en el espacio como una lámpara de pie.

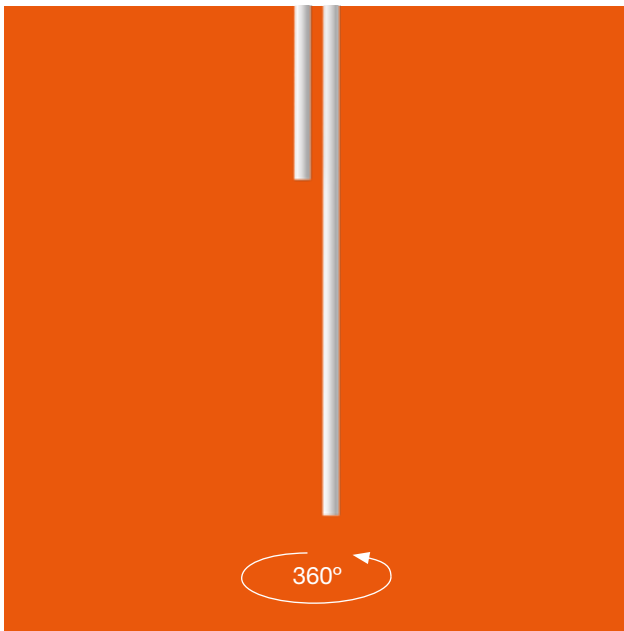

MY DOME & MY SPHERE

My Dome offers the classic suspension piece for downlight illumination reinterpreted with the poetry of Michael Anastassiades. My Sphere is the My Circuit solution with an aesthetic presence characterised by its form and omnidirectional light emission.

My Dome ofrece la clásica pieza de suspensión para iluminación downlight reinterpretada desde la poética de Michael Anastassiades.

My Sphere es la solución de My Circuit con una presencia estética más destacada por su forma y su emisión de luz omnidireccional.









My Circuit fixations are concatenated like track sections on a Scalextric racing car set. The union of the necessary sections draws the designed route.

The innovative My Circuit flexible track is inserted into the fixations like a central spine. A sort of internal 'soul' that gives the modellable profile its final form.

Las fijaciones de My Circuit se concatenan como tramos de una pista de coches Slot de juguete. Con la unión de los tramos necesarios, se dibuja el recorrido diseñado.

El innovador carril flexible My Circuit se inserta en las fijaciones a modo de espina central. Una suerte de 'alma' interna que dará al perfil moldeable su forma final.



My Circuit luminaires have adapters specially designed to link with the flexible track by grasping it from the outside.

Las luminarias de My Circuit cuentan con adaptadores diseñados especialmente para vincularse con el carril flexible abrazándolo exteriormente.

FLEXIBLE PROFILE



L: 8000 / 15000 / 20000









Michael Anastassiades' revolutionary flexible track offers a new approach to illuminating a space, serving as an architectural tool that offers a combination of diffused ambient lighting and sophisticated accent lighting.

El carril flexible y revolucionario de Michael Anastassiades ofrece una nueva forma de iluminar un espacio al ser una herramienta arquitectónica que ofrece una combinación de iluminación ambiental difusa e iluminación de acento sofisticada.

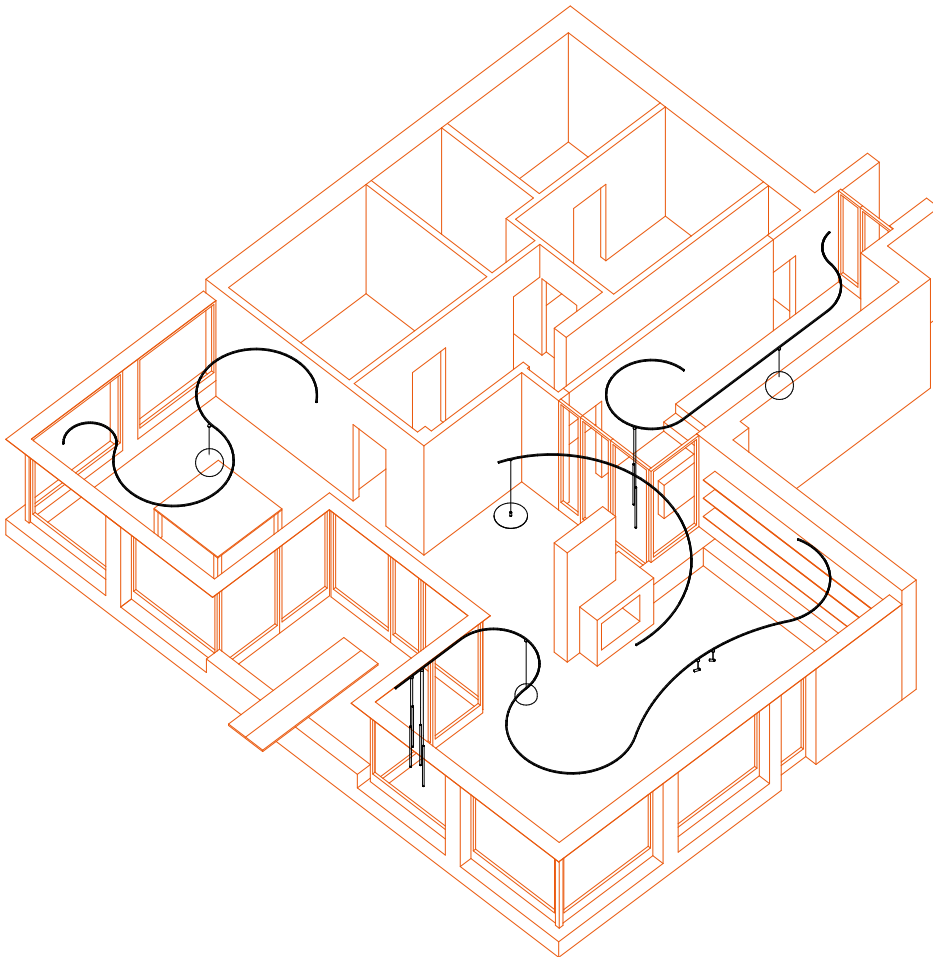

ENDLESS LAYOUTS

Connecting to the sinuous ceiling track is a series of illuminating options that include high performance and decorative spotlights, pendants shaped like circular domes or discs, and suspended floor to ceiling lamps, all defined by Anastassiades' poetic approach to form.

There is seemingly no end to what My Circuit can achieve, thanks to the playful approach to modularity of its track and its rich portfolio of lighting objects that can enhance its presence or leave it as a functional, discreet tool.

The extreme simplicity of the elements and the versatility with which they can be combined allows you to unleash the creativity of a project in countless combinations.

DISEÑOS INFINITOS

Cuenta con una serie de opciones de iluminación para conectar al sinuoso carril del techo que incluye focos decorativos y de alto rendimiento, lámparas colgantes con forma de cúpulas o discos circulares y lámparas suspendidas de suelo a techo, todas ellas definidas por el poético enfoque de las formas de Anastassiades.

Aparentemente no hay límites para My Circuit, gracias al enfoque lúdico de la modularidad de su carril y a su amplio catálogo de objetos de iluminación que pueden realzar su presencia o dejarla como una herramienta funcional y discreta.

La extrema sencillez de los elementos y la versatilidad con la que se pueden combinar permite liberar la creatividad del proyecto consiguiendo innumerables combinaciones.

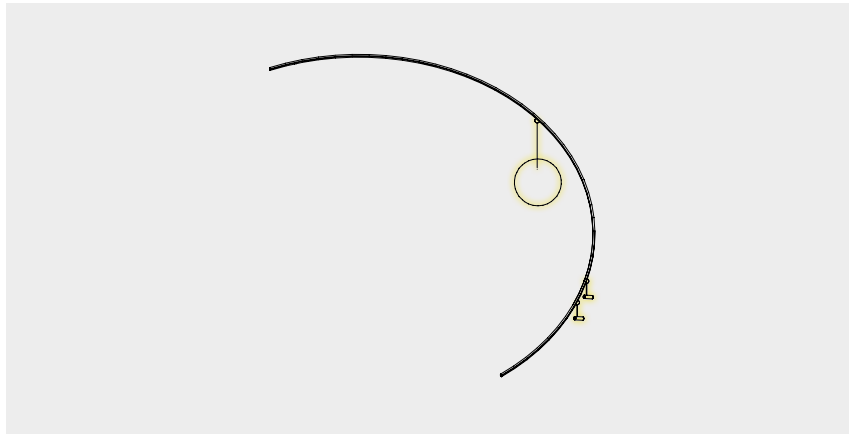
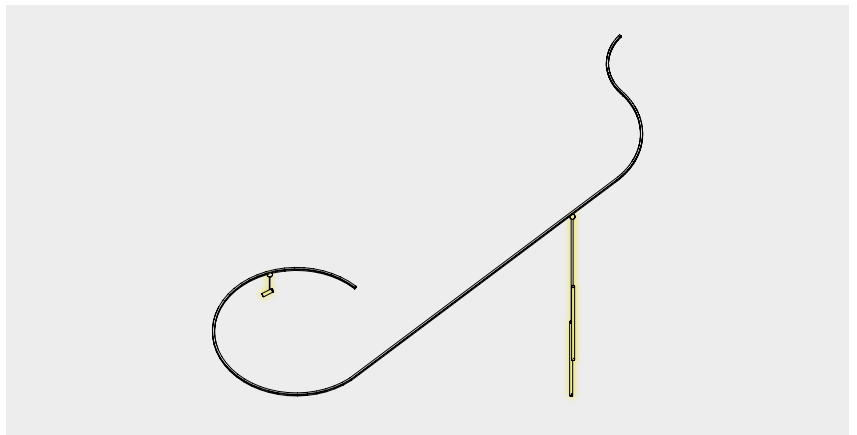
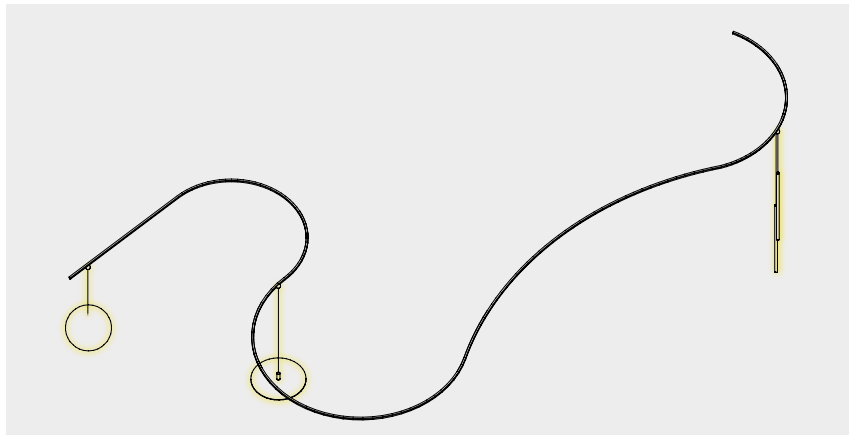
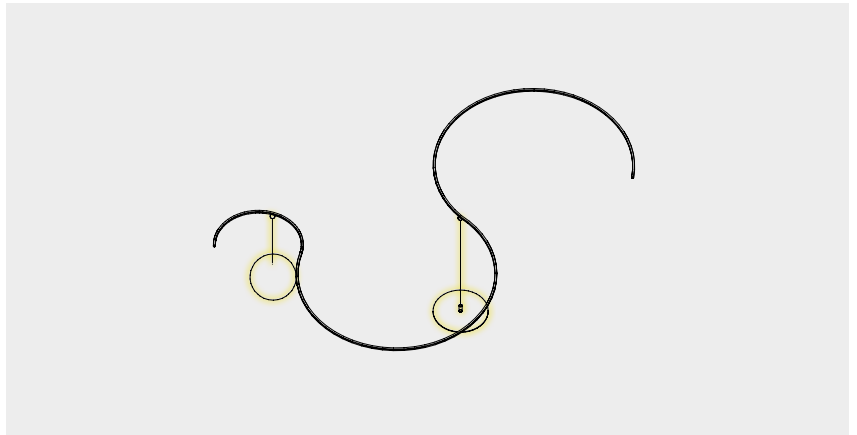



CASAMBI

Individual control of each luminaire directly through a tablet or smartphone application (FLOS Control®).

Control individual de cada luminaria a través de una aplicación para tablet o smartphone (FLOS Control®).



FLOS CONTROL®
BY CASAMBI

The FLOS Control® application allows you to control the system's luminaires as a group, controlling scenes and programming.

With a traditional electrical installation and the Gateway connected by Bluetooth, you obtain total control of the ambience.

Available for iOS and Android

La aplicación FLOS Control®, permite controlar las luminarias del sistema en grupo, controlando escenas y programación.

Con tan sólo una instalación eléctrica tradicional y el Gateway conectado por Bluetooth se obtiene un control total del ambiente.

Disponible en iOS y Android

MY CIRCUIT PROFILE

- C5 White
- C5 Blanco



MY CIRCUIT PROFILE LIGHT MODULES

MY CIRCUIT
LIGHT SHADOW
SPOT Ø30



POWER LED
4W

MY CIRCUIT
LIGHT SHADOW
SPOT Ø45



LED ARRAY
8W

MY CIRCUIT
SPOT Ø25



POWER LED
4W

MY CIRCUIT
SPOT Ø35



LED ARRAY
8W

MY CIRCUIT PROFILE LIGHT MODULES

MY CIRCUIT
DOME



TOP LED
40W

MY CIRCUIT
SPHERE



TOP LED
40W

MY CIRCUIT
DISC

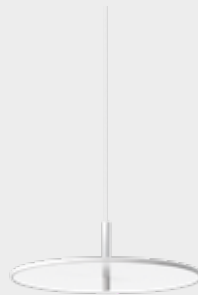

TOP LED
42W

MY CIRCUIT
LINES



TOP LED
2 x 23W



Spot



Medium



Flood



Wide Flood



Diffused

B

B

E

E

L

L

T

Technical lighting line covered in a sewn to measure, fine leather or textile fabric cover that integrates all elements of the composition. The innovative connection system has been developed to achieve a sinuous line without apparent interruptions.

Línea de luz técnica envuelta en una fina capa de tejido (cuero natural o textil) cosido a medida para integrar cada elemento de la composición. El innovador sistema de conexión ha sido desarrollado para conseguir una línea sinuosa sin interrupciones aparentes.

BELT

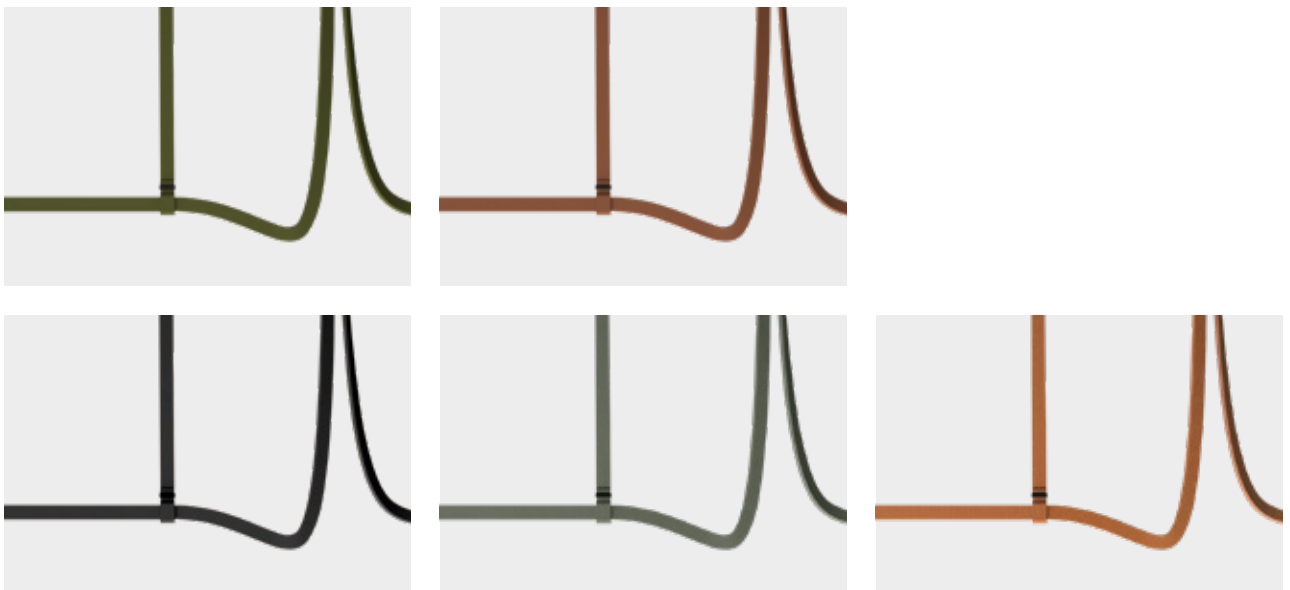





The leather or textile fabric is the heart of the project. A soft and warm material that guarantees freedom in the space but, at the same time, is characterized by certain rigidity. The result is a harmonious final composition. Belt is covered in fine leather, treated with natural dyes to obtain the three finishes available in the range: black, green and natural leather. Belt Fabric is covered in a special technical fabric offering two decorative finishes with a knitted texture: grey olive and copper brown.

El tejido (de cuero o tela) representa el corazón del proyecto. Un material suave y cálido que garantiza libertad en el espacio pero al mismo tiempo se caracteriza por una cierta rigidez que crea armonía en el resultado de la composición final. Belt está recubierta con cuero fino, tratado con tintes naturales para obtener los tres acabados disponibles en la gama: negro, cuero natural y verde. Por su parte, la versión Belt Fabric está recubierta de una tela técnica especial en dos acabados decorativos con una textura tejida: grey olive y copper brown.

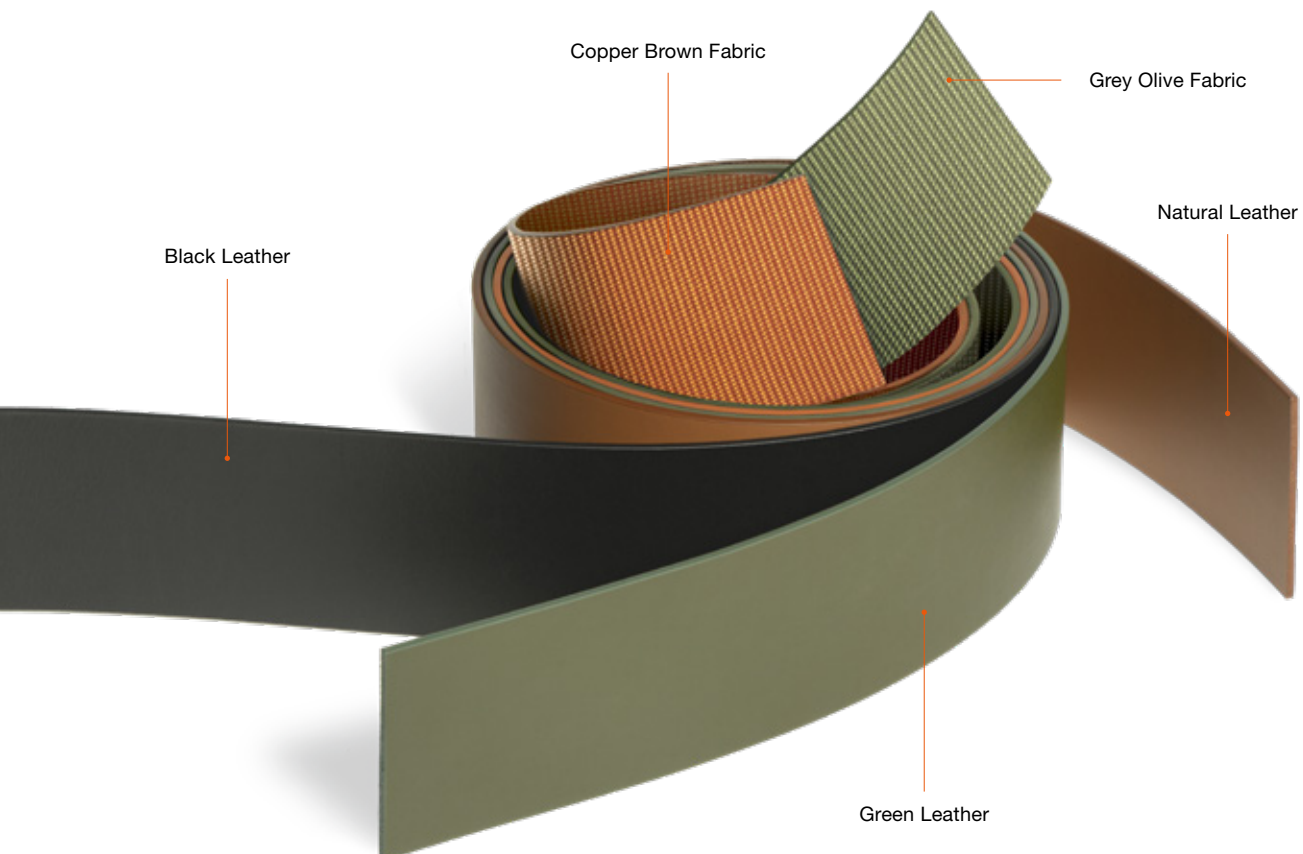



Belt is pure flexibility, a sinuous line whose nature is in balance between the softness of the leather or the fabric and the rigidity of aluminium. The soft element is represented by the connection to the electrical grid, while the rigid parts correspond to the light sources, which are long lighting lines.

Belt es pura flexibilidad, una línea sinuosa cuya naturaleza está en equilibrio entre la suavidad del tejido de cuero o tela y la rigidez del aluminio. El elemento blando está representado por la conexión a la red eléctrica, mientras que las partes rígidas corresponden a las fuentes de luz: unas largas líneas de luz.

- 1 CEILING FEEDING BASE
- 2 ELECTRICAL LOOP CONNECTOR
- 3 CEILING MOUNTING
- 4 SUSPENSION BELTS
- 5 LIGHT PROFILE







Each element of the product is controlled by leather or textile fabric straps. Some of them support the weight of the device, some carry electricity and some contain light. The initial section of each composition descends from the ceiling or rises from the wall, or even from the floor, and then hangs thanks to dedicated straps.

Cada elemento del producto se controla con tiras de tejido (de cuero o tela). Algunas soportan el peso del aparato, otras llevan electricidad y algunas contienen luz. La sección inicial de cada composición desciende desde el techo o se eleva desde la pared o incluso desde el suelo y luego se cuelga gracias a unas tiras específicas para ello.

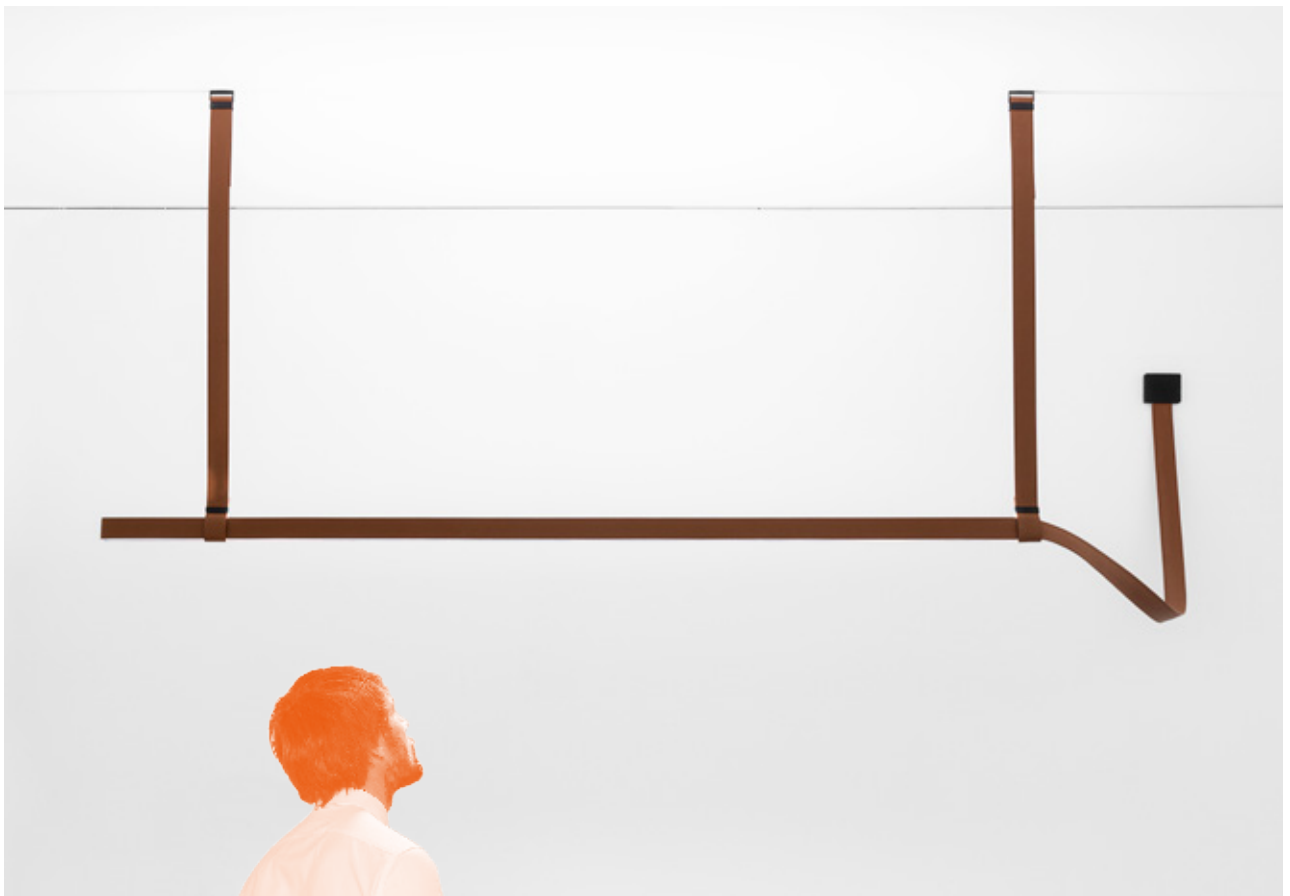
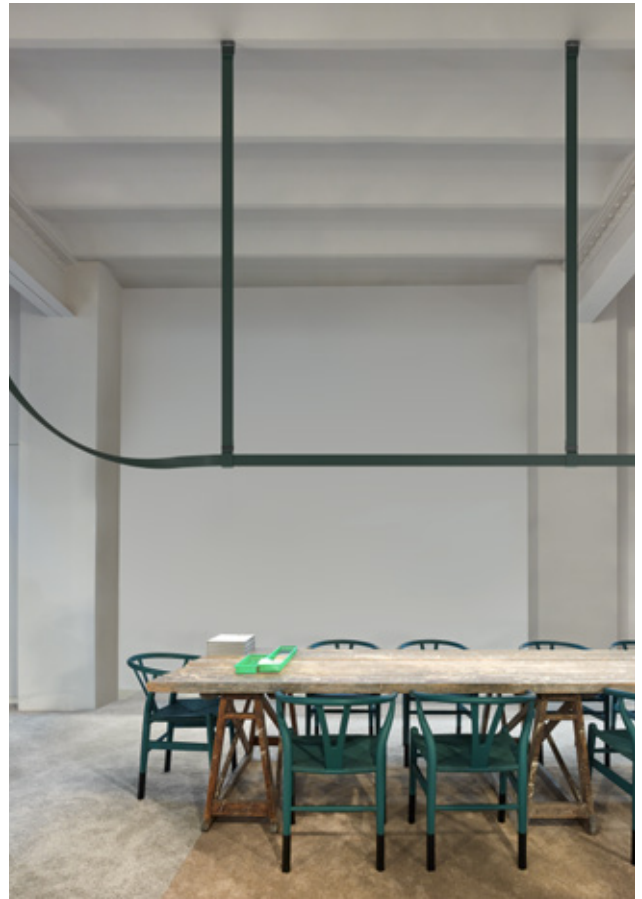

FULL VISUAL COMFORT

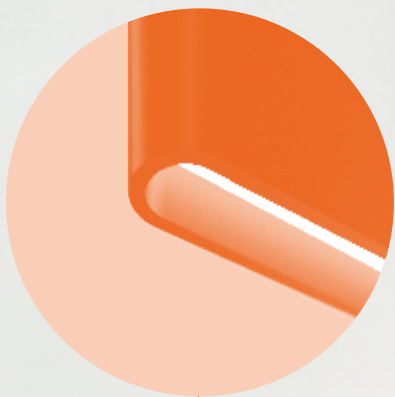

As for fastening a belt, the installation of the straps used to hang the lighting profile is done by sliding the straps through dedicated metal buckles that act as ceiling hooks. Each strap can be adjusted to respect the configuration of the environment.

Como para abrochar un cinturón, la instalación de las tiras utilizadas para colgar el perfil luminoso se realiza deslizando las correas a través de hebillas metálicas específicas que actúan como ganchos de techo. Cada tira se puede ajustar para respetar la configuración del entorno.

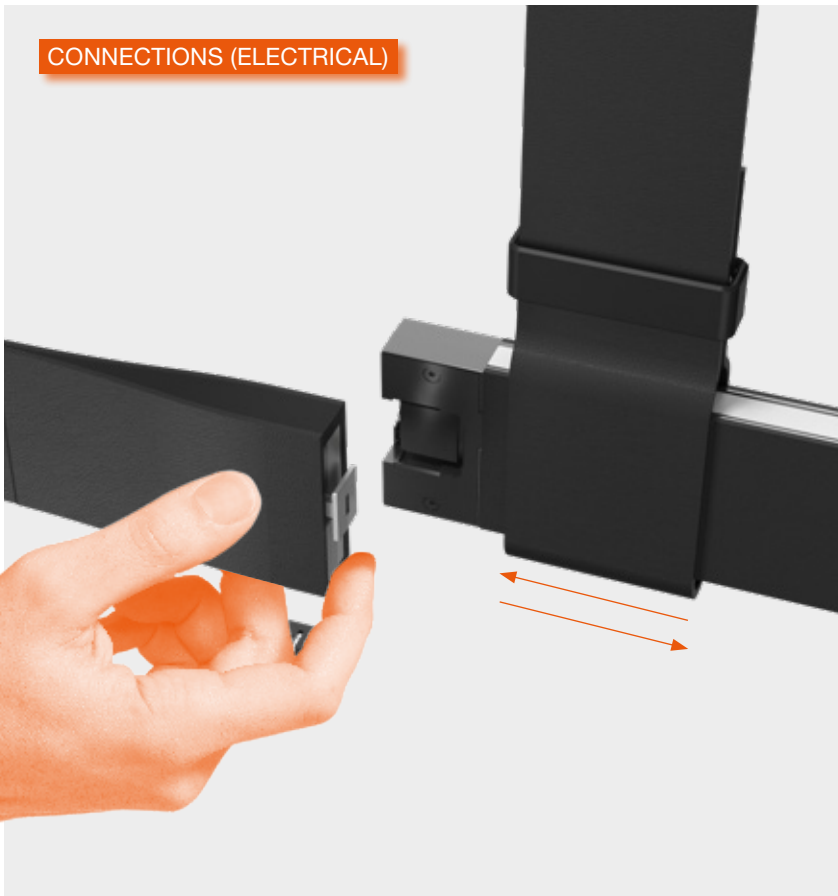

CONNECTIONS (ELECTRICAL)

The special micro-connector integrated in the terminal of the lighting profile allows the electrical connection to be made with a simple click. The connection element is hidden inside the strap that acts as a suspension to support the composition.

El microconector especial integrado en el terminal del perfil luminoso permite realizar la conexión eléctrica con un simple clic. El elemento de conexión está oculto dentro de la tira que actúa como una suspensión para soportar la composición.

CONNECTIONS (ELECTRICAL)







The length of the lighting profiles and the straps can be changed according to the requirements of the project. The range offers six different lengths so the composition can be adapted to the space by growing, rotating, rising or descending in three dimensions.

La longitud de los perfiles luminosos y de las tiras puede cambiar según los requisitos del proyecto. Hay seis longitudes diferentes disponibles en la gama, para permitir que la composición se adapte al espacio al crecer, rotar, elevarse o descender en tres dimensiones.

PROFILES

3000 mm



2000 mm



STRAPS

3000 mm



2000 mm



1500 mm



1000 mm











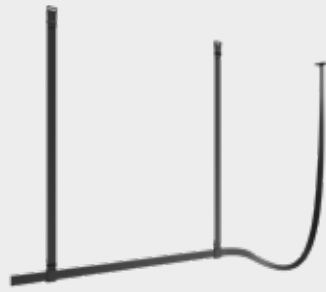

TOP LED
27,5W/m

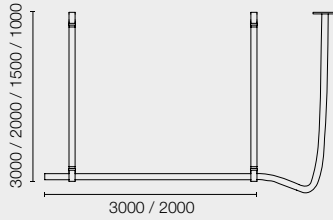

■ GN Green



■ 18 Natural Leather



■ 14 Black



■ GO Grey Olive



■ M5 Copper Brown



Flood
Up&Down

INFRA-STRUCTURE

INFRA-STRUCTURE
INFRA-STRUCTURE

INFRA-STRUCTURE

INFRA-STRUCTURE

INFRA-STRUCTURE
INFRA-STRUCTURE

INFRA-STRUCTURE

INFRA-STRUCTURE

INFRA-STRUCTURE

INFRA-STRUCTURE
INFRA-STRUCTURE

INFRA-STRUCTURE
INFRA-STRUCTURE
INFRA-STRUCTURE

INFRA-STRUCTURE

Tubular structure compatible with a wide range of light fixtures with magnetic fastening and mechanical safety locking. Regulation and control with universal protocols and using the FLOS Control® application.

Estructura tubular compatible con una amplia gama de luminarias con fijación magnética y bloqueo mecánico de seguridad. Regulación y control mediante protocolos universales y a través de la aplicación FLOS Control®.

INFRA-STRUCTURE





The Conran Shop, Seoul

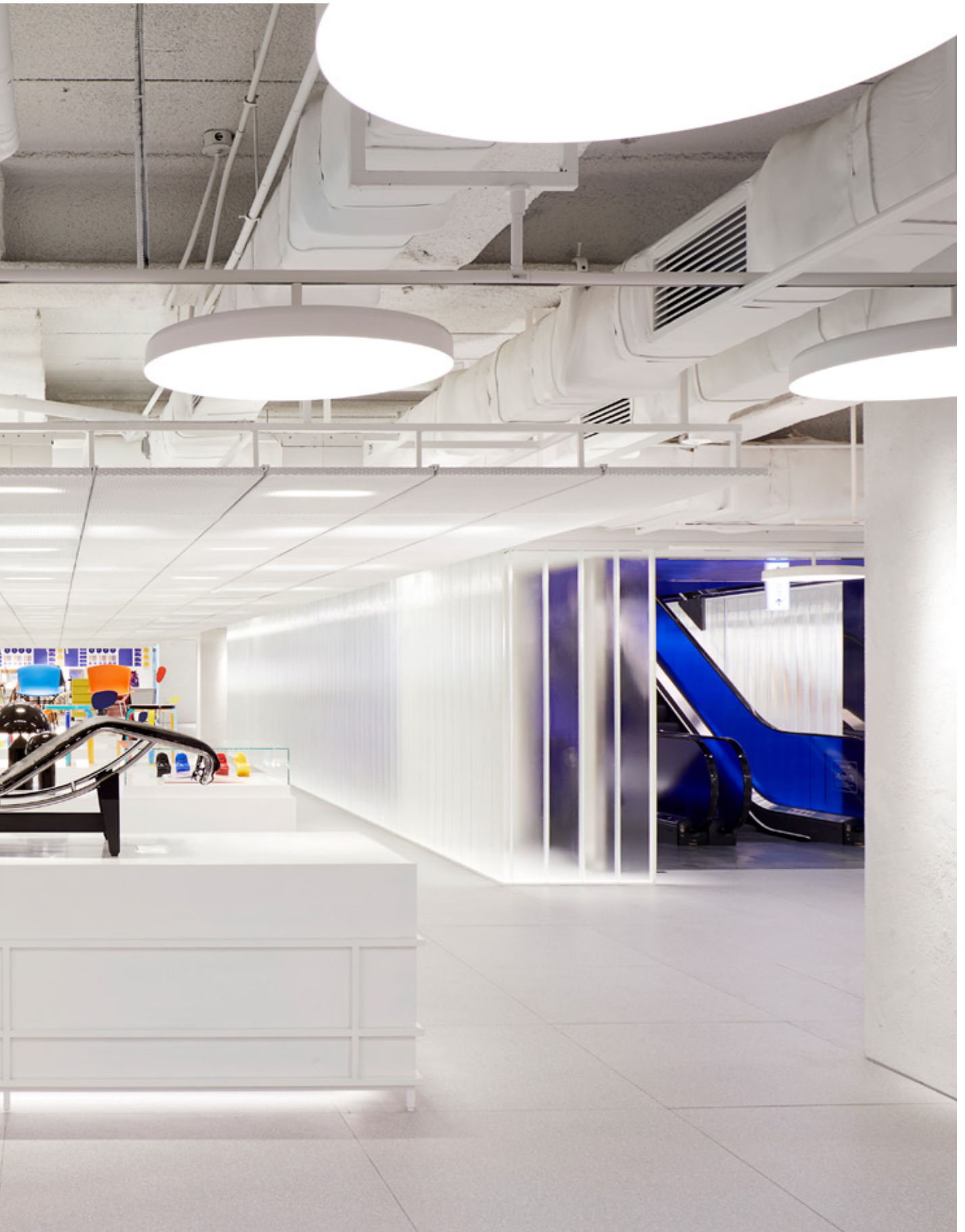

The new icon in lighting structures: thanks to its unique design and magnetic technology Infra-Structure offers a singular way to grow your lighting design in the architectural space. Compatible with all control systems and FLOS Control®.

El nuevo icono en estructuras de iluminación: gracias a su diseño exclusivo y tecnología magnética, Infra-Structure ofrece un sistema único para desarrollar su diseño de iluminación en el espacio arquitectónico. Compatible con todos los sistemas de control y con FLOS Control®.



- 1 SPOT / LIGHT SHADOW SPOT
- 2 MULTI SPOT MINI
- 3 LIGHT TUBE
- 4 SUSPENSION PANEL
- 5 SUSPENSION GLASS DOWNLIGHT
- 6 MULTIFUNCTION SMART DEVICE









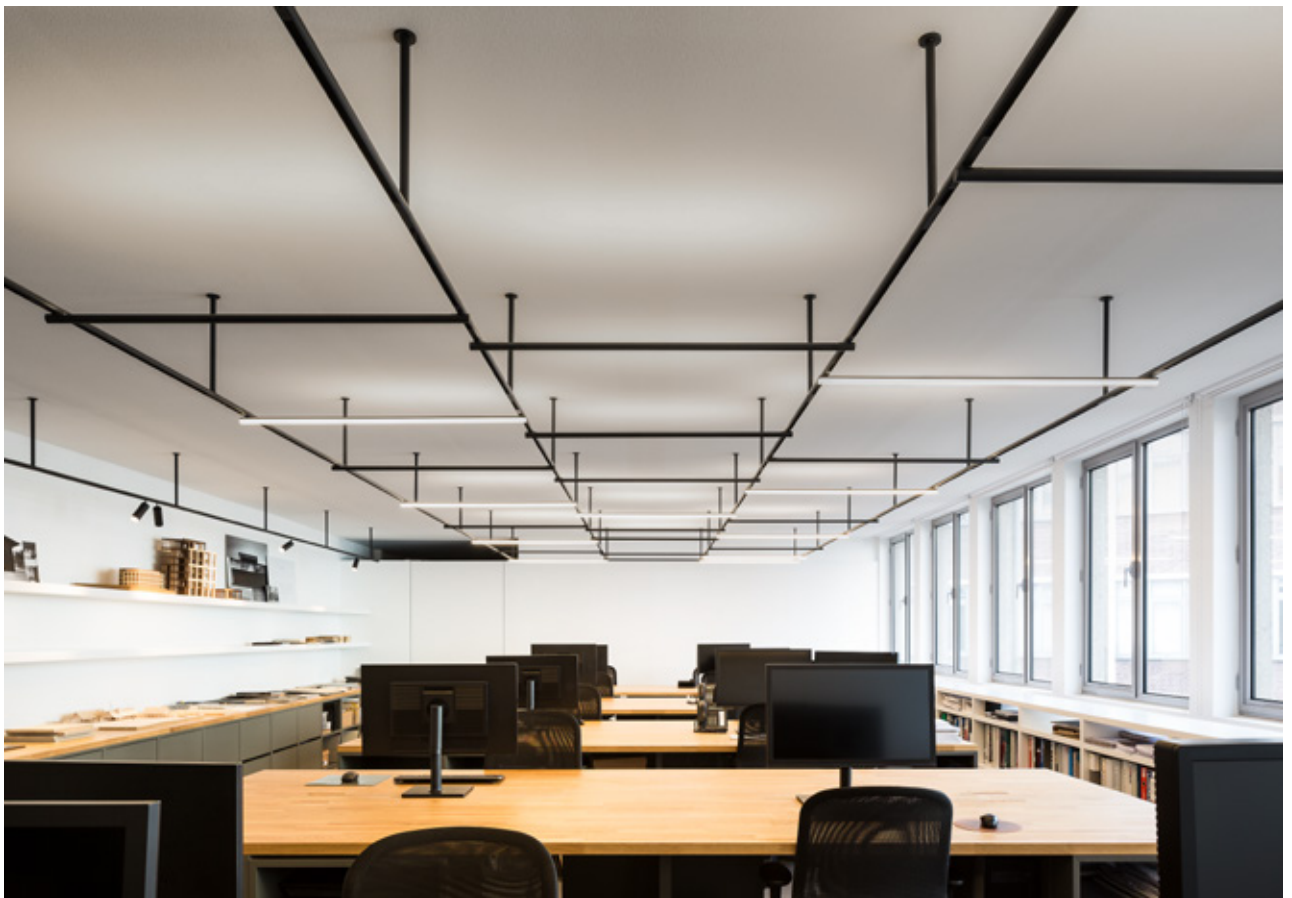

Vincent Van Duysen
Offices, Belgium
Bottom

Cantina 51 - Parc 51,
Belgium
Top

LIGHT TUBE / SUSPENSION PANEL 600

Highly efficient opal diffuser, which allows for uniform distribution and guarantees high levels of visual comfort.

Difusor opal de alta eficiencia que permite distribución uniforme garantizando elevado confort visual.

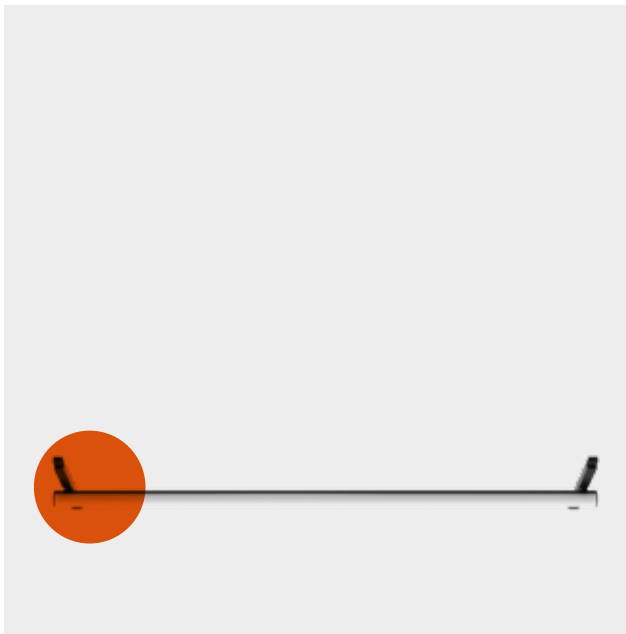

SPOT / LIGHT SHADOW SPOT

Infra-Structure has *Spot* and *Light Shadow Spot* projectors. Spot light modules feature high-efficiency reflectors, while *Light Shadow Spots* benefit from their own patented and exclusive optical technology, with dual-focus lenses. (1)

Infra-Structure cuenta con proyectores *Spot* y *Light Shadow Spot*. Los 'light modules' Spot disponen de reflectores de alta eficiencia, mientras que los *Light Shadow Spot* disfrutan de su propia tecnología óptica patentada y exclusiva -con lentes de doble focal-. (1)

SUSPENSION GLASS DOWNLIGHT 110

Decorative bell in blown glass. Available in transparent, fumeed and red finishes.

Campana decorativa en vidrio soplado y disponible en acabados transparente, fumé y rojo.

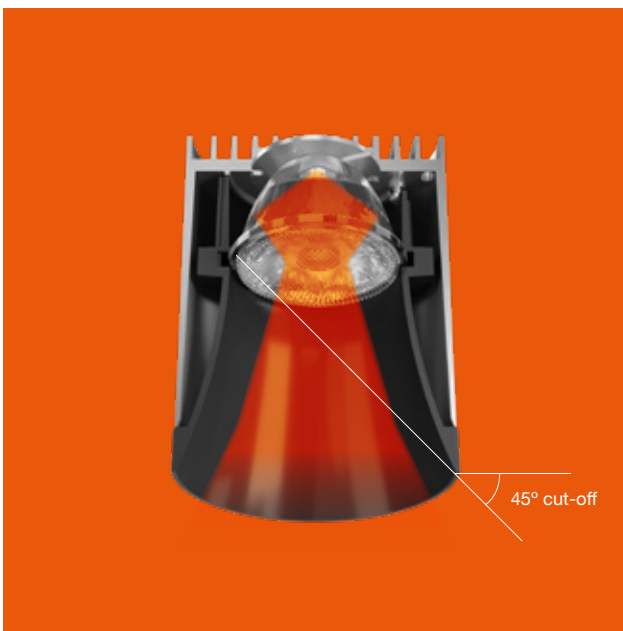

MULTI SPOT MINI

The Multi Spot Mini is a 14-spot LED lighting module with low glare, combining a compact design with powerful lighting capability. This module provides an elegant and efficient solution, with beam control ensuring that brightness is focused directly outward, avoiding unnecessary reflections.

El Multi Spot Mini es un módulo de iluminación LED de 14 focos y bajo deslumbramiento que combina un diseño compacto con una potente capacidad de iluminación. Este módulo ofrece una solución elegante y eficiente, con un control del haz de luz que asegura que la luminosidad se enfoque directamente en el exterior, sin reflejos innecesarios.



















	Different control options that can be adapted to any need.	Diferentes opciones de control que pueden adaptarse a cualquier necesidad.
ON BOARD DIMMING	Each luminaire has its own integrated dimmer for direct and individual control.	Cada luminaria lleva su dimmer integrado, para control directo e individual.
DALI	Individual control of each luminaire.	Control individual de cada luminaria.
1-10V	Broadcasting remote control (dimming of all the luminaires in a single group).	Control remoto en broadcasting (dimado de todas las luminarias en grupo).
CASAMBI	Individual control of each luminaire directly through a tablet or smart-phone application (FLOS Control®).	Control individual de cada luminaria a través de una aplicación para tablet o smartphone (FLOS Control®).



FLOS CONTROL®
BY CASAMBI

The FLOS Control® application allows you to control the system's luminaires individually or as a group, controlling scenes and programming.

With a traditional electrical installation and the Gateway connected by Bluetooth, you obtain total control of the ambience.

Available for iOS and Android

La aplicación FLOS Control®, permite controlar las luminarias del sistema de modo individual o en grupo, controlando escenas y programación.

Con tan sólo una instalación eléctrica tradicional y el Gateway conectado por Bluetooth se obtiene un control total del ambiente.

Disponible en iOS y Android

LIGHT MODULES

MULTI SPOT MINI

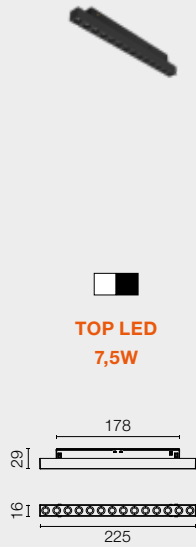

SUSPENSION
PANEL 600

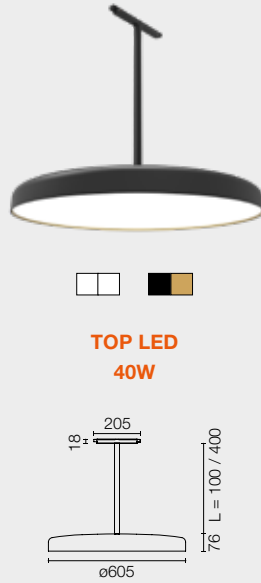

SUSPENSION
GLASS DOWNLIGHT 110

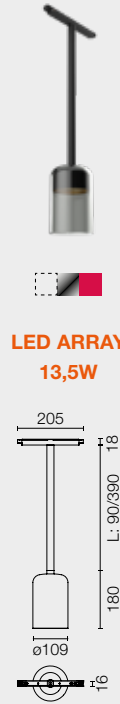

- 40 White
 40 Blanco
- 14 Black
 14 Negro



MULTIFUNCTION
SMART DEVICE



FLOS CONTROL®
by Casambi

GUSTAVE GUSTAVE

GUSTAVE GUSTAVE

GU AVE

GUSTAV USTAVE

GUSTAV USTAVE

GUSTAV USTAVE

GUSTAV USTAVE

GUSTAV USTAVE

GUST TAVE

GUSTAVE GUSTAVE

GUSTAVE GUSTAVE

Elegant portable luminaire for tabletop lighting.
360° asymmetric light emission with wide coverage.
Circular design conceived to prevent obsolescence
and reduce environmental impact.

Elegante luminaria portátil para iluminación de
sobremesa. Emisión de luz asimétrica 360°, de
amplio alcance. Diseño circular concebido para
evitar la obsolescencia y reducir el impacto
ambiental.

GUSTAVE



ASYMMETRIC LIGHT

Up to 1 meter of perfect light homogeneity. Optimized reach for archetypal applications for tables hosting up to 4 guests. Unbeatable visual comfort.

LUZ ASIMÉTRICA

Homogeneidad de luz perfecta hasta 1 metro. Alcance optimizado para aplicaciones arquetípicas en mesas de hasta 4 comensales. Inmejorable confort visual.

ILLUMINATED AREA
OF 1 METER IN DIAMETER

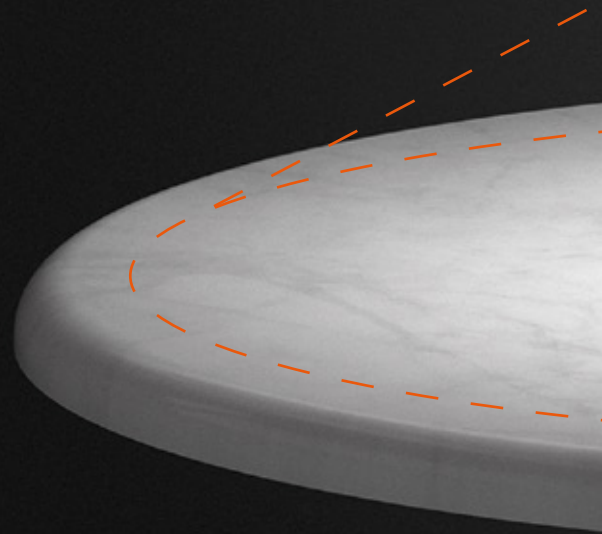



HIGH VISUAL CONFORT

360°
ASYMMETRIC
EMISSION

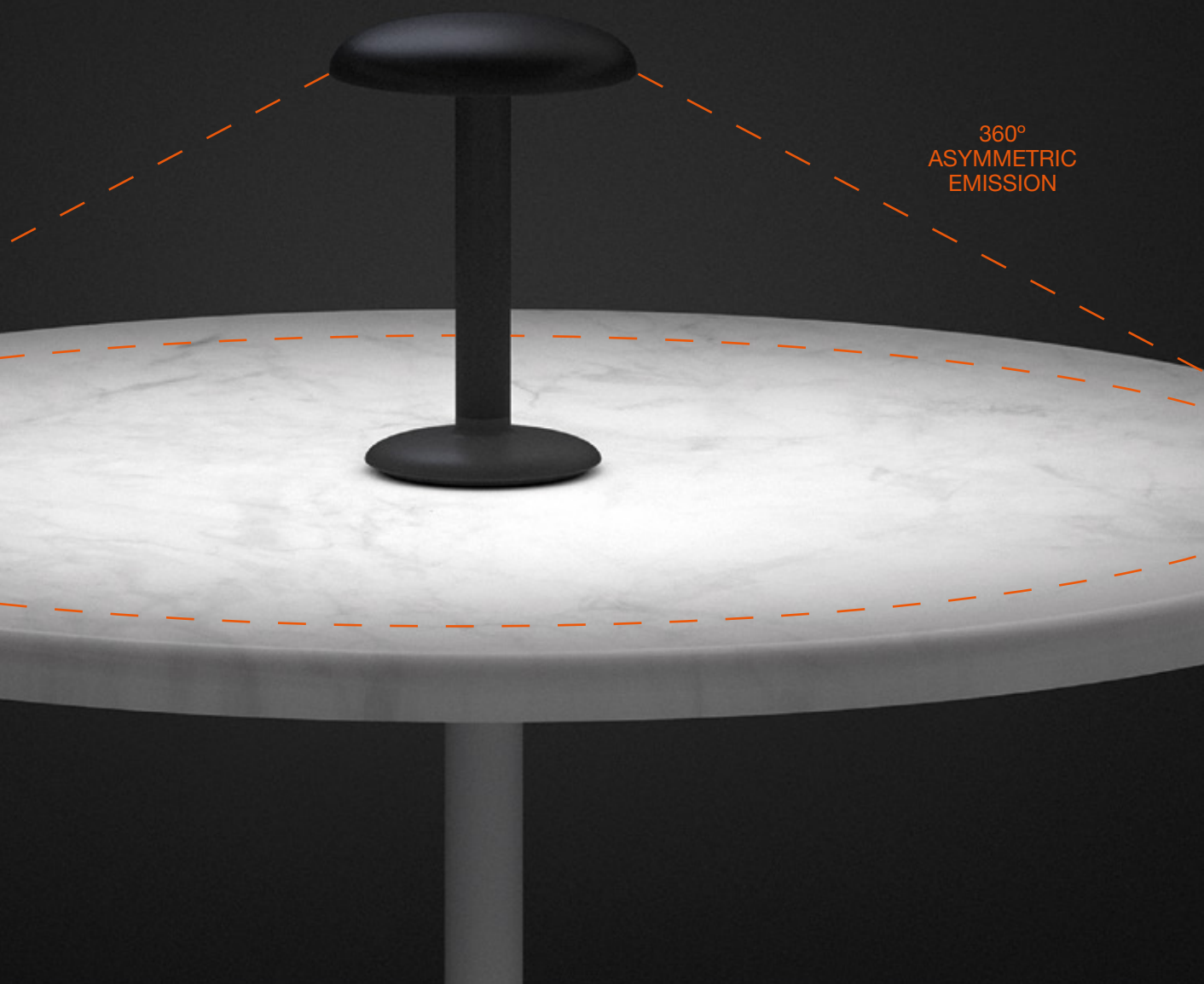







Exclusive optical system patented by Flos. Lenses arranged in revolution for a 360° asymmetrical emission. Wide extension of the illuminated area with minimum space taken. Excellent light quality on the work surface.

Sistema óptico exclusivo y patentado por Flos. Lentes dispuestas en revolución para emisión asimétrica 360°. Amplia extensión del área iluminada, con mínima ocupación del espacio. Calidad lumínica excelente en el plano de trabajo.

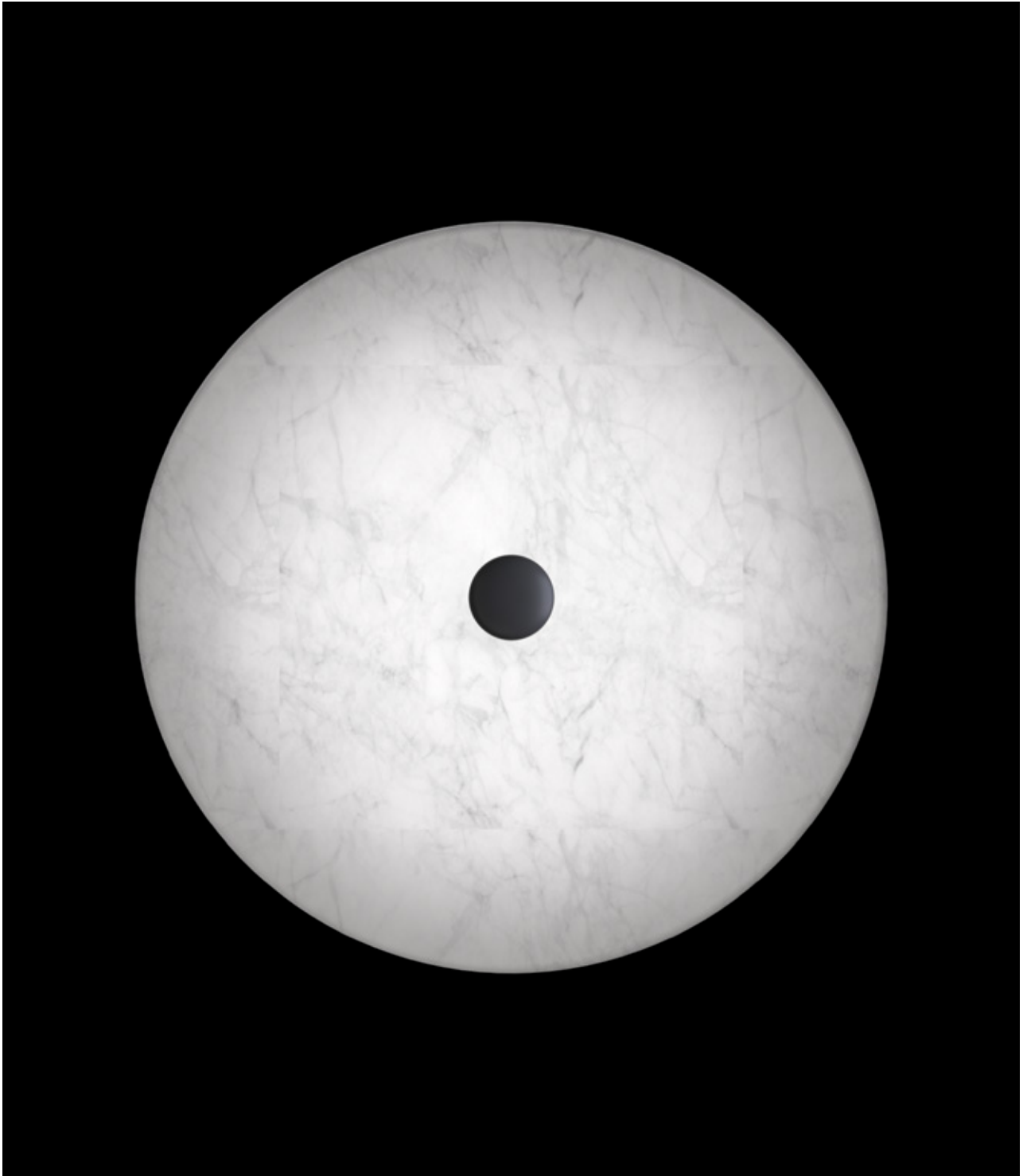





RESIDENTIAL VERSION

The ideal household partner.

VERSIÓN RESIDENTIAL

La compañera ideal para el hogar.

1. Charging via USB-C cable. LED indicator for charge and autonomy management. Charging time: 5h to 6h. Autonomy: 6h at 100%, 10h at 50% and 18h at 25%.

Carga mediante cable USB-C. LED indicador para la gestión de la carga y la autonomía. Tiempo de carga: de 5h a 6h. Autonomía: 6h al 100%, 10h al 50% y 18h al 25%.

2. Integrated operating protocol to optimize product autonomy in case of low battery.

Protocolo de funcionamiento integrado para optimizar la autonomía del producto en caso de batería baja.

3. 0-100% sequential regulation by means of capacitive touch button. Flashing light indicates when the maximum or minimum intensity is reached. Last position memory.

Regulación secuencial 0-100% mediante pulsador táctil capacitativo. El parpadeo de la luz indica que la intensidad llega al máximo o al mínimo. Memoria de última posición.



HAPTIC CONTROL & LED INDICATOR

CONTROL HÁPTICO & LED INDICADOR

Capacitive touch button for interaction with the luminaire: switching on, off and dimming. Advanced haptics, high quality perceived sensation.
LED indicator for autonomy management. In the Residential version, it also informs about the charging status of the product.

Pulsador táctil capacitativo para la interacción con la luminaria: encendido, apagado y regulación. Háptica avanzada, sensación percibida de alta calidad.
LED indicador para la gestión de la autonomía. En la versión Residential, también informa sobre el proceso de carga del producto.

HIGH WATERTIGHTNESS

ALTA ESTANQUEIDAD

IP54 protection rating against dust and water ingress. Resistant to splashes, light rain and dirt in normal use. Created to provide lighting both for dinners at home and services on the terrace or in the dining room of a restaurant.

Índice IP54 de protección ante el ingreso de polvo o agua. Resistente a salpicaduras, lluvia leve y suciedad de uso normal. Creada para iluminar tanto una cena en casa, como los servicios en la terraza o sala de un restaurante.





CIRCULAR DESIGN. ENGINEERING AGAINST OBSOLESCENCE

Gustave (Hospitality & Residential) is powered by replaceable lithium-ion batteries. Thus, the life of the product is not linked to the life of the batteries. When the batteries reach the end of their life cycle, they can be replaced with new ones. The product continues to function as it did on the first day.

Moreover, when the product comes to an end, its circular design concept allows all parts to be easily disassembled and separated for recycling. All without the need for tools: it is manufactured without glues, screws or welding.

DISEÑO CIRCULAR. INGENIERÍA CONTRA LA OBSOLESCENCIA

Gustave (Hospitality & Residential) funciona con pilas de ion-litio reemplazables. Así, la vida del producto no está vinculada a la vida de las baterías. Cuando las pilas agoten su ciclo de vida, se pueden reemplazar por unas nuevas. El producto sigue funcionando como el primer día.

Por otra parte, cuando el producto llegue a su fin, su concepto de diseño circular permite desmontar y separar fácilmente todas sus partes para ser reciclado. Todo, sin necesidad de herramientas: está fabricado sin colas, tornillos, ni soldaduras.

FLOS *for Planet*



Range of five finishes. A carefully curated selection designed for Gustave to blend into interiors of any kind. Pure style and distinction.

Gama de cinco acabados. Una selección cuidada para que Gustave viva en interiorismos de cualquier tipo. Puro estilo y diferenciación.



5 colors

Exclusive matte and glossy finishes selected by Vincent Van Duysen: 1. Matt White, 2. Matt Anthracite, 3. Laquered Brown, 4. Laquered Green, 5. Polished Silver.

5 colores

Acabados exclusivos en mate o brillante, seleccionados por Vincent Van Duysen: 1. Matt White, 2. Matt Anthracite, 3. Laquered Brown, 4. Laquered Green, 5. Polished Silver.



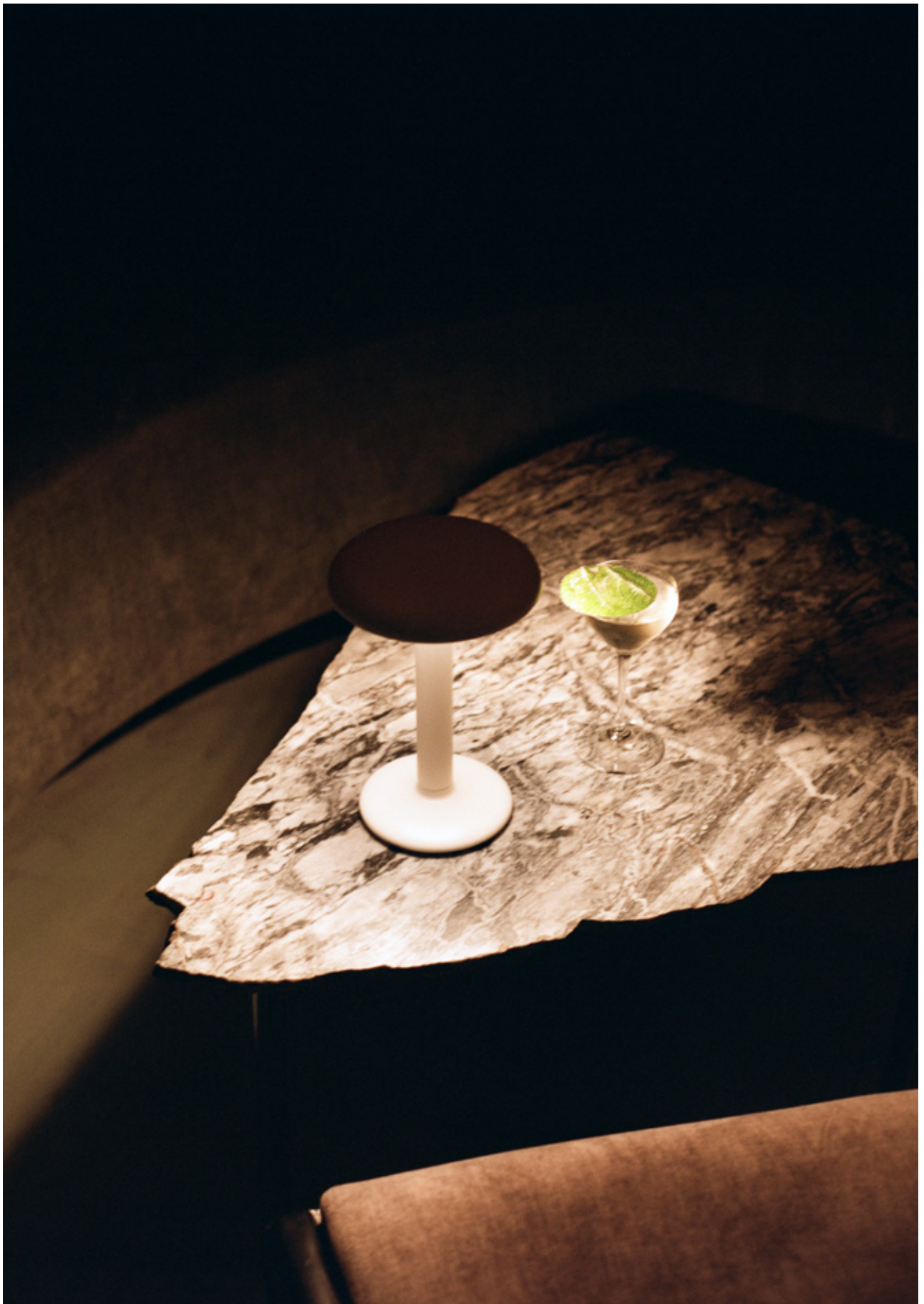

GUSTAVE RESIDENTIAL
(USB-C cable)



TOP LED
2,5W

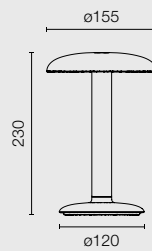

□ Matt White



■ Matt Anthracite



■ Laquered Brown



■ Laquered Green



▒ Polished Silver



Asymmetric
Flood 360°

EMI

EMI

EMI

EMI

EMI

EMI

EMI

EMI

EMI

EMI

EMI

Emi, designed by Erwan Bouroullec, combines different light sources with a high level of visual comfort to create a unique experience of light and shadow. The design of this collection comes from grouping together three light modules inside compact, linear extrusions that give the lamp a triangular shape which is reflected all throughout its design.

Emi, diseñada por Erwan Bouroullec, combina diferentes fuentes de luz de alto confort visual para crear una experiencia única de luces y sombras. El diseño de esta colección se concreta a partir de la agrupación de tres módulos luminosos dentro de extrusiones lineales y compactas, que dan a la lámpara su forma triangular que se refleja en todo su diseño.

EMI



EMI FLOOR & TABLE

The floor version seems to float in the air, disencumbered by a stem that connects to the base. The two-way lighting offered by this model is highly adapted to contemporary life: the upper light is powerful enough to illuminate the entire space without dazzling, thanks to a specific beam conformation. The lower light is soft and subdued, perfect for use with other sources such as a television or appliance. The table version operates in the same way but is smaller in size and fits perfectly on any horizontal surface.

La versión de pie parece flotar en el aire, elevada con un vástago que se conecta a la base. La iluminación que ofrece este modelo en dos direcciones se adapta a la vida contemporánea: la luz superior es lo suficientemente potente como para iluminar todo el espacio sin deslumbrar, gracias a una forma específica del haz de luz. La luz inferior es suave y tenue, perfecta para utilizarla con otras fuentes de luz, como la televisión u otros dispositivos. La versión de mesa funciona de la misma forma pero es más pequeña y encaja a la perfección en cualquier superficie horizontal.

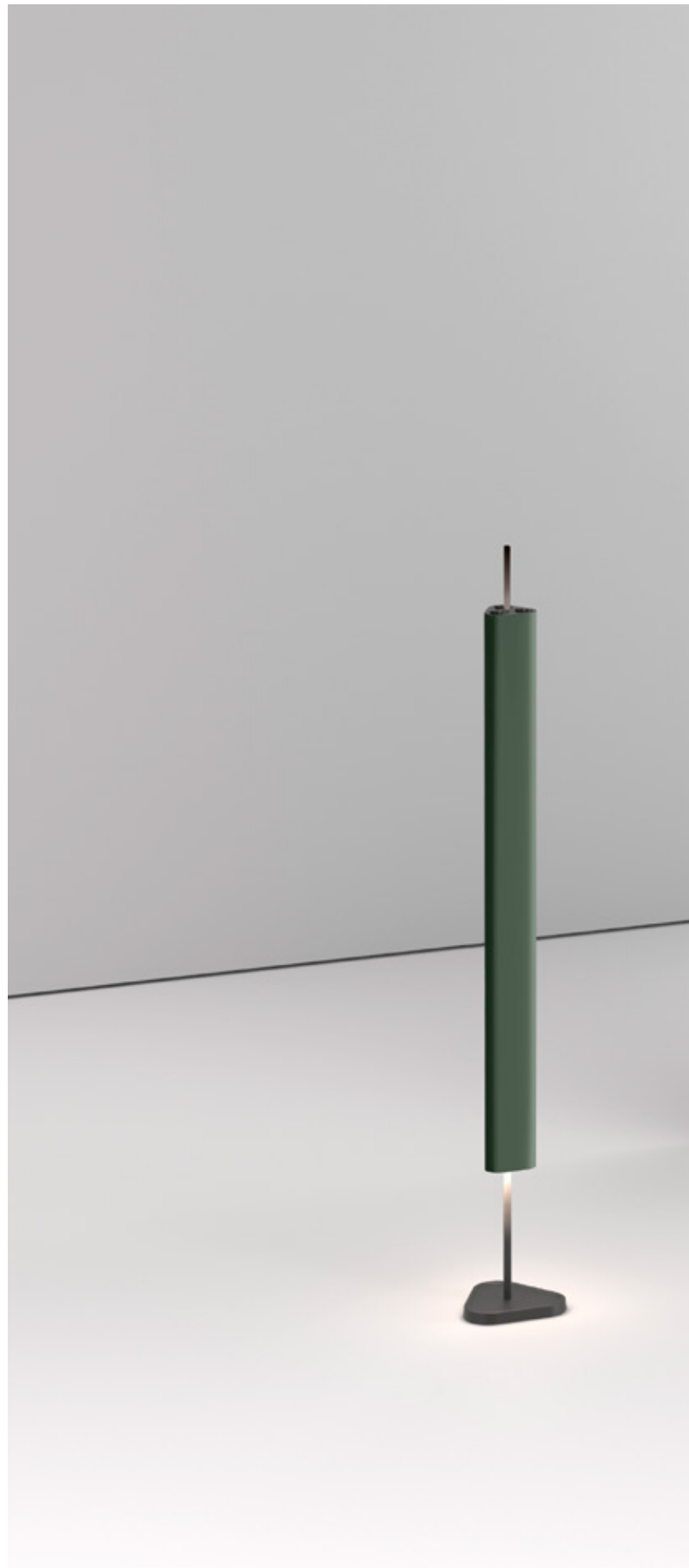



Emi exploits the benefits of an innovative silicone lens that allows absolute beam control with an extreme efficiency, heat resistance and maximum quality light distribution.

Emi aprovecha los beneficios de una innovadora lente de silicona que permite un control extremo del haz además de proporcionar una eficiencia absoluta, resistencia al calor y máxima calidad en la distribución de la luz.



1 Micro-textured silicone lenses.
Lentes de silicona microtexturadas.

2 Integrated full cut-off attenuator.
Atenuador de cut-off completo
integrado.

3 Spare parts.
Repuestos.

FLOS TECHNOLOGY

The technological heart of Emi combines with an exquisitely crafted base made of cast iron. Imperfections present on the surface of the base are the result of a manual production process that makes each product unique.

El corazón tecnológico de Emi se combina con una base exquisitamente elaborada en hierro fundido. Las imperfecciones presentes en la superficie de la base son el resultado de un proceso de producción manual que hace que cada producto sea único.

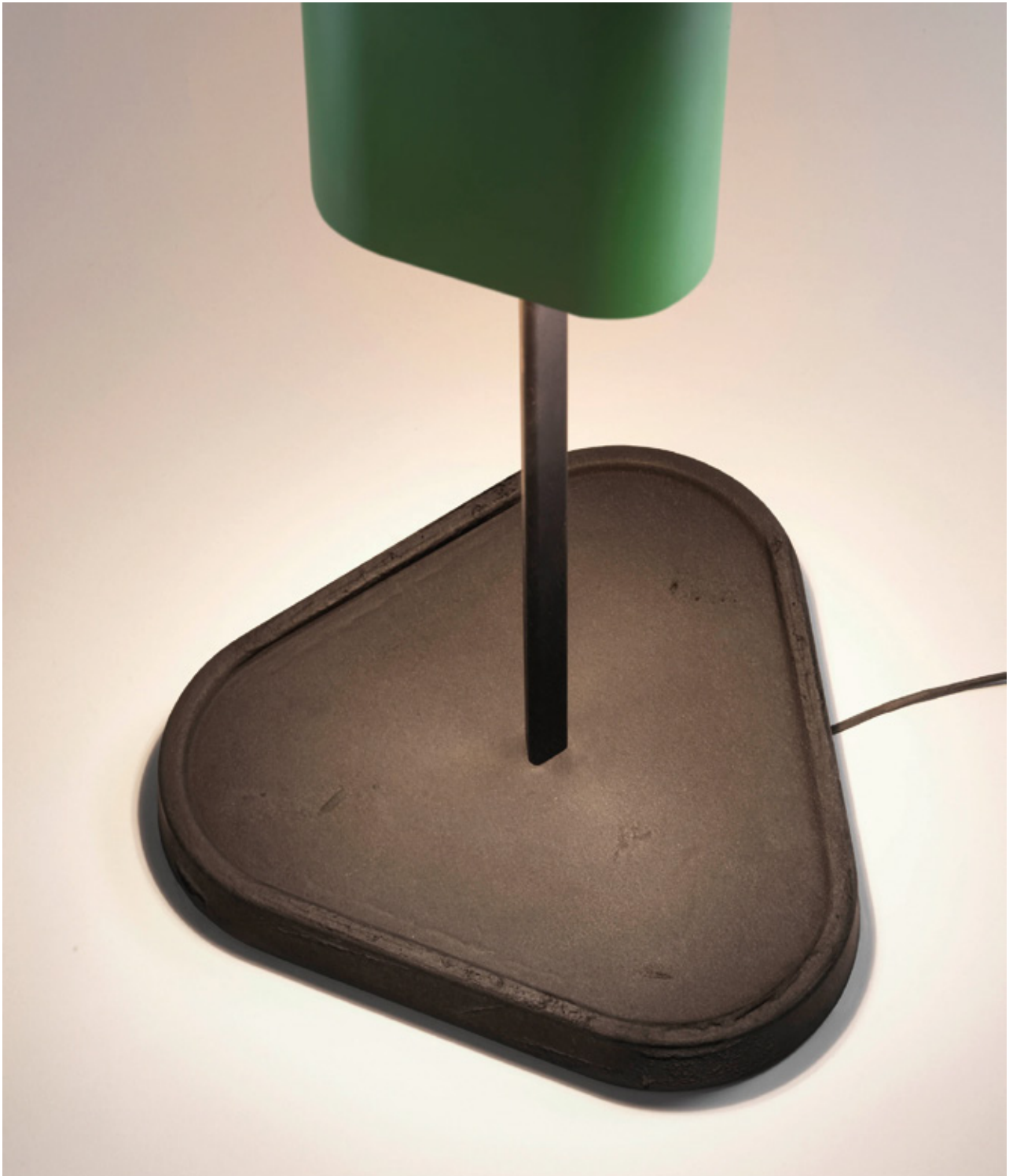

Even when on, EMI hides its light source and generates a magnificent visual effect: the space is illuminated without showing where the light source is.

Aún encendida, EMI no revela su fuente luminosa y genera un mágico efecto visual: el espacio se ilumina sin apreciar de dónde procede el origen de la luz.

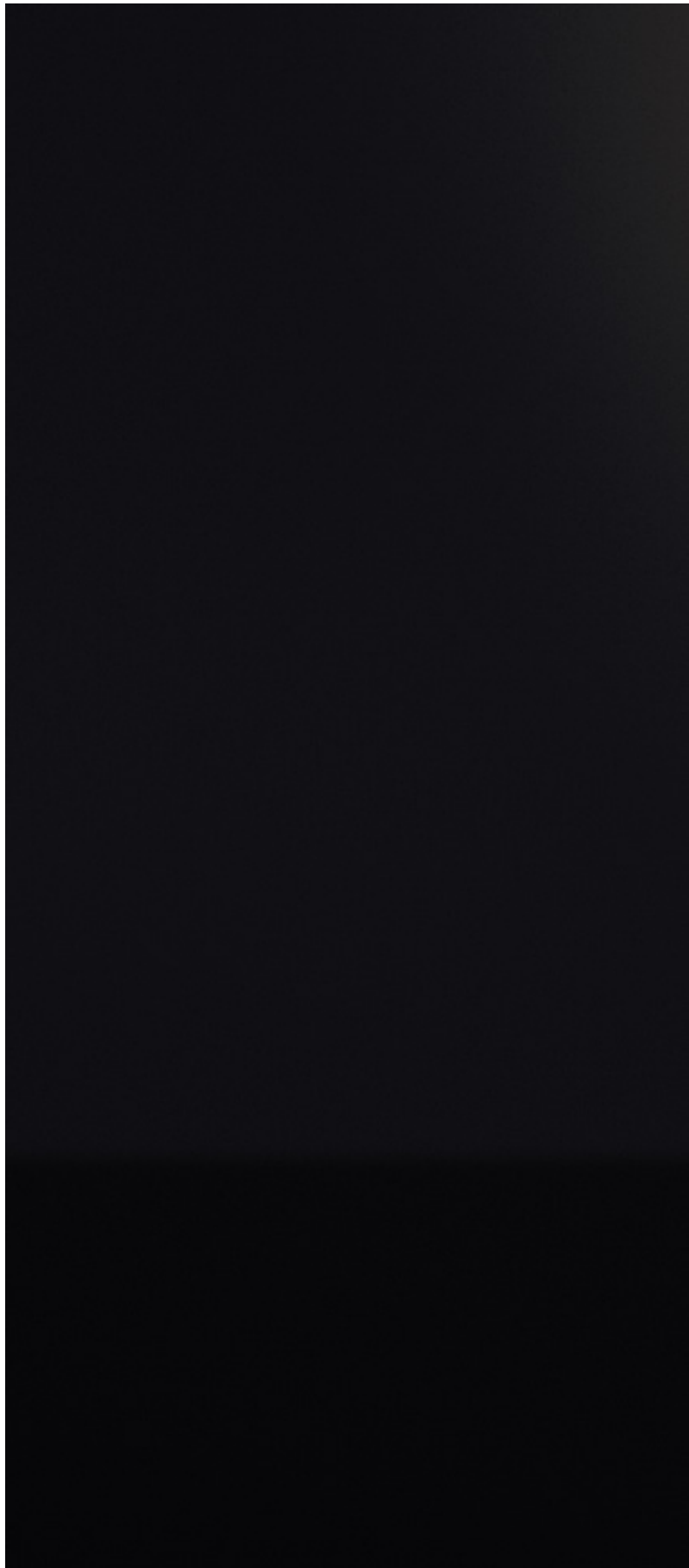



Thanks to the unique patented optical solution, EMI controls extreme cut-off angles without altering the high efficiency and incredible versatility of the product.

Gracias a la exclusiva solución óptica patentada, EMI controla ángulos de cut-off extremos, sin sacrificar la alta eficiencia y la increíble versatilidad del producto.

UGR<10

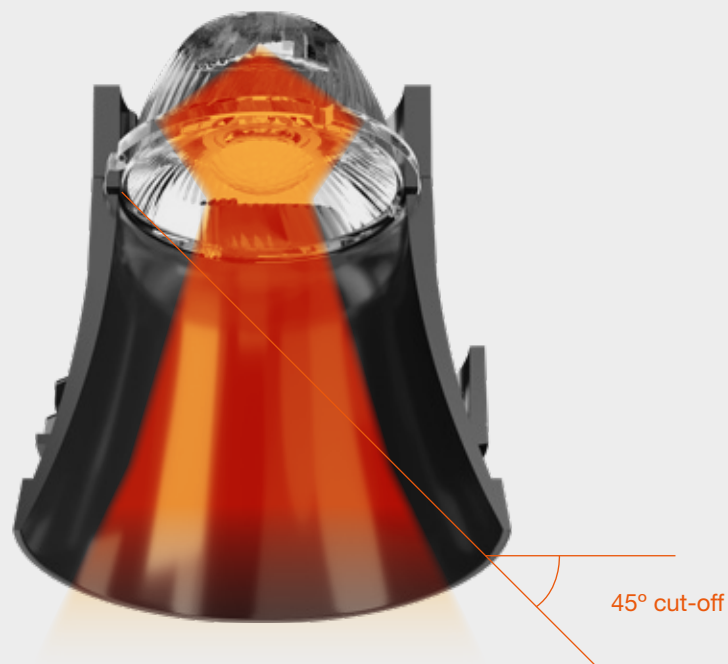

Dual-focus lens developed by FLOS specifically for this product. It ensures maximum optical control and exceptional light beam homogeneity.

Lente de doble foco desarrollada por FLOS específicamente para este producto. Garantiza el máximo control óptico y una homogeneidad excepcional del haz de luz.









Its design allows Emi to blend seamlessly into different interiors while providing the right light where it is needed. Offering greater flexibility in placement and use, making it suitable for a variety of settings.

Su diseño permite que Emi se integre en diversos interiores a la vez que proporciona la luz adecuada allí donde se necesita. Ofreciendo una mayor flexibilidad en la colocación y el uso de la luz, haciéndola adecuada para distintos entornos.



The available colour palette has been commissioned specifically by Erwan Bouroullec to cover EMI's design in four stylish shades that add a magical, sculptural presence to this "architectural reed".

La paleta de colores disponible ha sido especialmente comisariada por Erwan Bouroullec para vestir el diseño de EMI de una piel con cuatro elegantes colores, que dotan de una presencia mágica y escultórica a este 'junco arquitectónico'.







EMI has *Spare Parts* for maintenance or replacement of its lens units. Every lens unit can be replaced individually to make maintenance easier, while the absence of glues and welding simplifies the disassembly and correct disposal of individual parts at the useful end of the product's life.

EMI dispone de *Spare Parts* para el mantenimiento, cambio o reemplazo de sus grupos ópticos. Cada unidad óptica se puede reemplazar individualmente para facilitar el mantenimiento, mientras que la ausencia de pegamentos y soldaduras simplifica el desmontaje y la eliminación adecuada de las piezas individuales al final de la vida útil del producto.





The *Floor* and *Table* versions can be adjusted with Touch Dimming capacitive sensors in the top part of the central rod.

Las versiones *Floor* y *Table*, se pueden regular mediante sensores capacitivos Touch Dimming ubicados en la parte superior del tallo central.

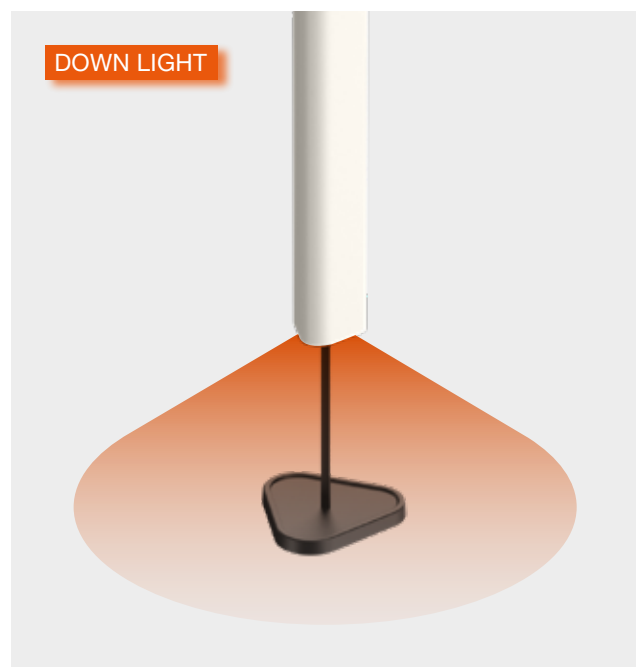





Control option for EMI regulation.

Opción de control para la regulación de EMI.

TOUCH DIMMING

The *Floor* and *Table* versions have a built-in capacitive button panel to control the light.

Las versiones *Floor* y *Table* cuentan con una botonera capacitativa integrada para el control de la luminaria.

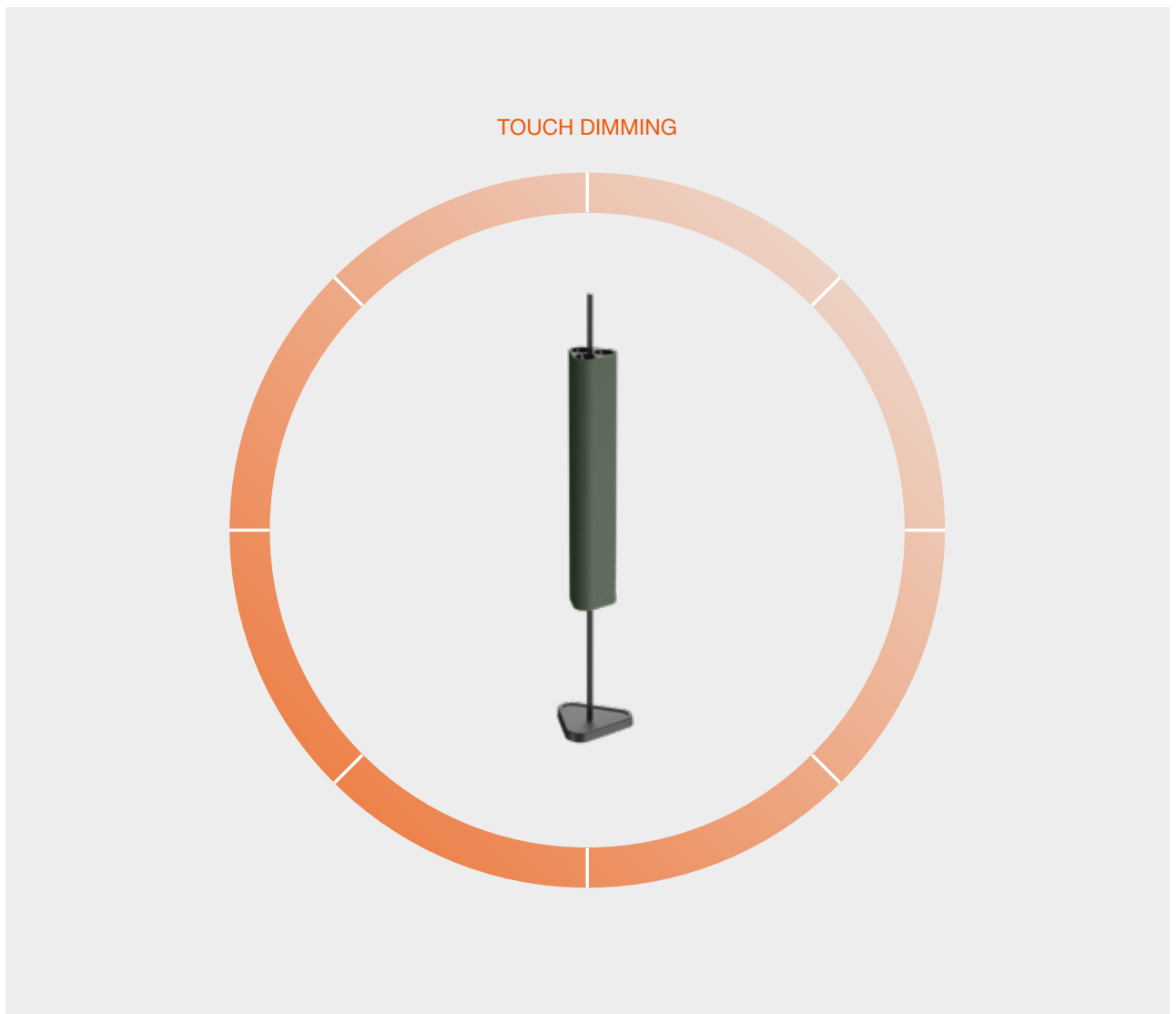



EMI FLOOR



UP
LED ARRAY / 38,5W

DOWN
POWER LED / 13W

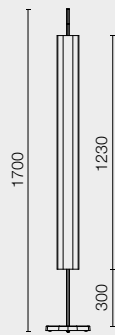

EMI TABLE



UP
LED ARRAY / 28W

DOWN
POWER LED / 13W

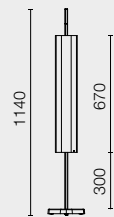

EMI TABLE & FLOOR

OW Off White

OW.XX All Off White

RY Deep Red

GY Deep Green

ZY Deep Blue



Flood

OBLIQUE

BB

L L

I I

Q Q

U U

E E

Oblique is a revolutionary lamp: produces a controlled asymmetric light beam which UGR is lower than 10 for an exceptional anti-glare protection. Besides the table model (for desktop applications), Oblique Floor fulfills its function in an analogous way in task lighting applications for reading chairs, lounge chairs and other spaces, both domestic and professional.

Oblique es una luminaria revolucionaria: produce un halo de luz asimétrico y controlado cuyo UGR es inferior a 10, lo que proporciona una protección antideslumbramiento excepcional. Además del modelo de sobremesa (para aplicaciones de escritorio), Oblique Floor cumple su función de manera análoga en aplicaciones de luz de apoyo para sillones de lectura, butacas de salón y otros espacios, tanto domésticos como profesionales.

OBLIQUE

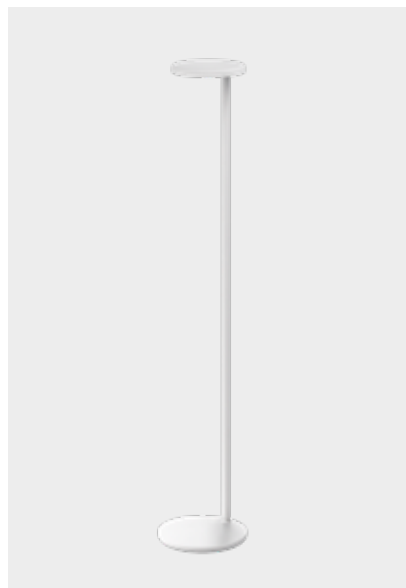



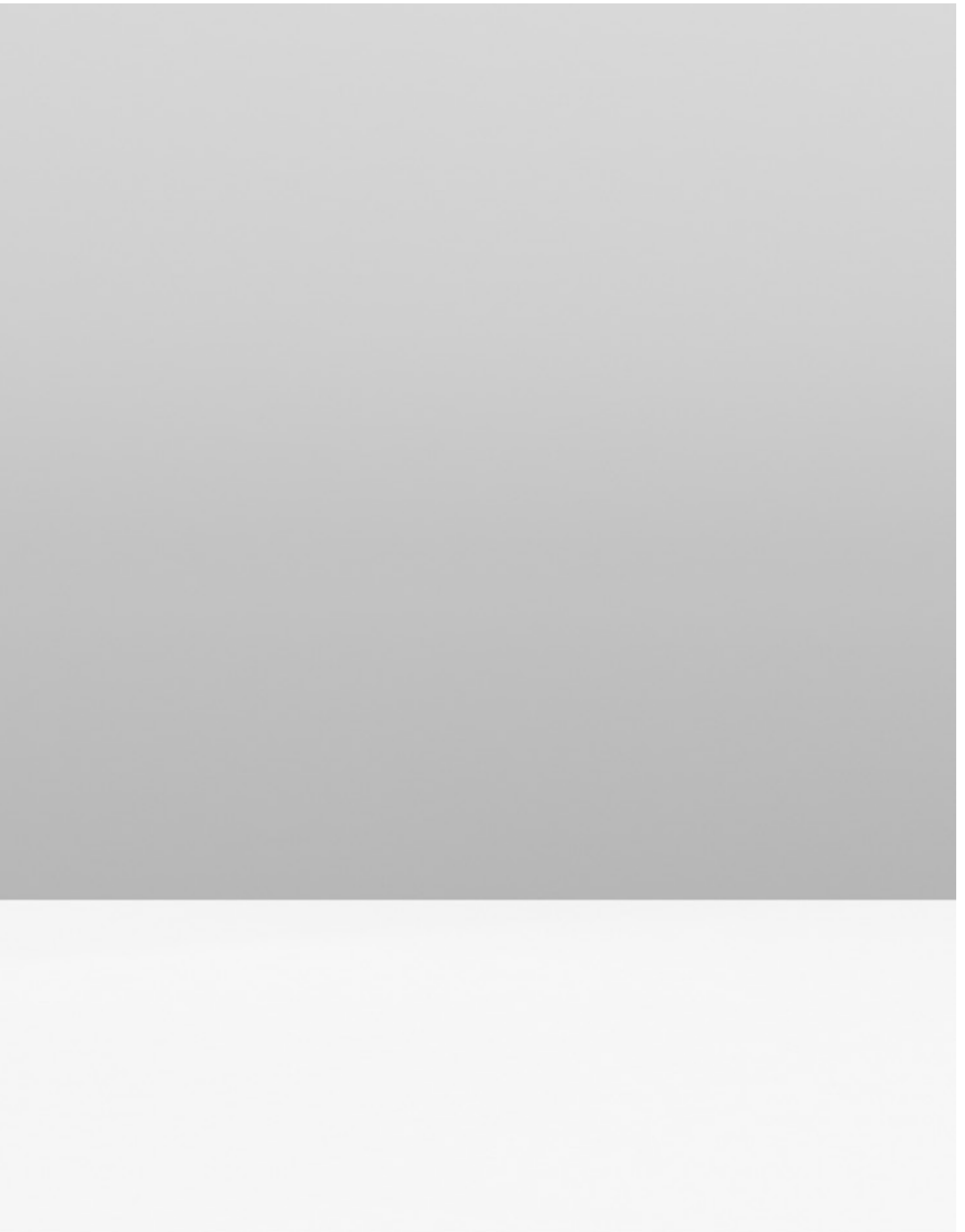

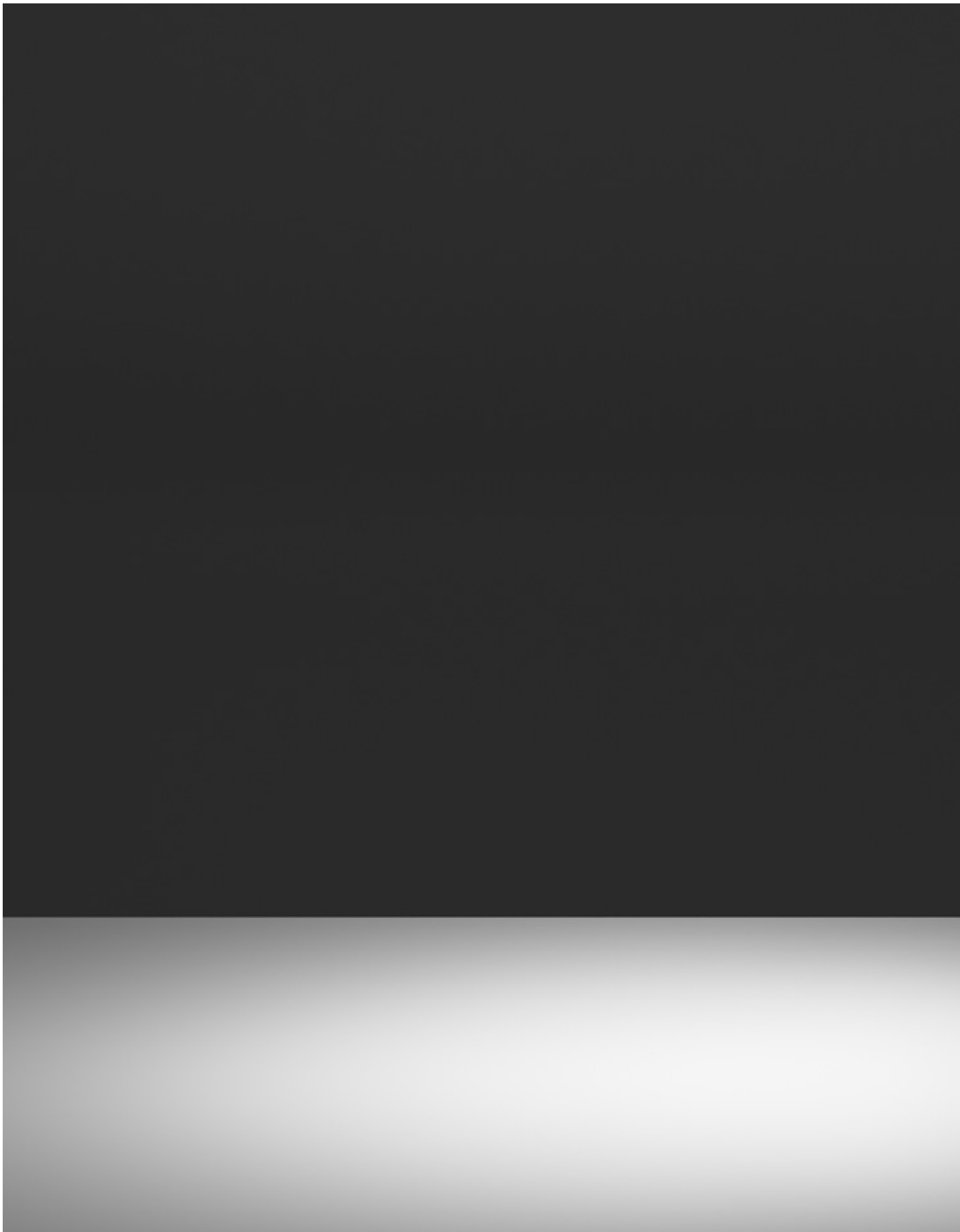





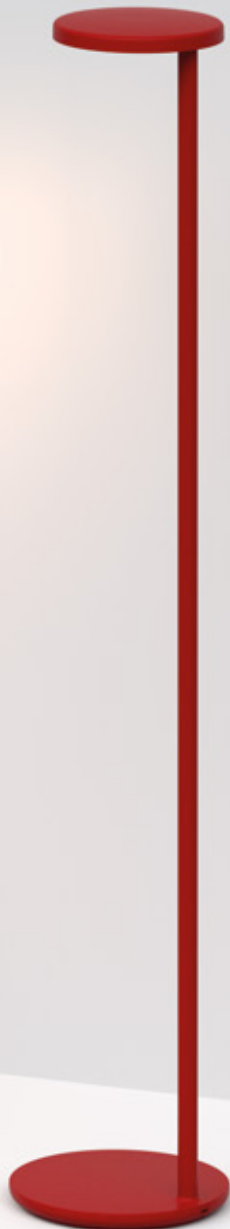

Oblique reformulates tabletop lighting in workspaces. In contrast to the traditional archetype of the desktop luminaire with an articulated arm, Oblique is an immobile piece, almost a sculpture. The light is projected towards the work area by an asymmetrical emission of the beam, maintaining the static nature of the piece, its formal purity and its elegant presence. Technical avant-garde and Flos beauty go hand in hand.

The same philosophy is followed by Oblique Floor, which fulfills its function in an analogous way in task lighting applications for reading chairs, lounge chairs and other spaces, both domestic and professional.

Oblique reformula la iluminación para sobremesa en espacios de trabajo. Frente al arquetipo tradicional de luminaria de escritorio con brazo articulado, Oblique es una pieza inmóvil -casi una escultura-. La proyección de la luz hacia el área de trabajo se realiza mediante una emisión asimétrica del haz, manteniendo la estaticidad de la pieza, la pureza formal y su elegante presencia. La vanguardia técnica y la belleza Flos, se dan la mano.

La misma filosofía sigue Oblique Floor, que cumple su función de manera análoga en aplicaciones de luz de apoyo para sillones de lectura, butacas de salón y otros espacios -tanto domésticos como profesionales-.



The heart of this lamp is the result of a real technological challenge. The LEDs and lenses can generate an extremely powerful and controlled light beam from the inside of a just 5 mm thick space.

El corazón de esta lámpara es el resultado de un verdadero desafío tecnológico. Encerrados en un grosor de tan solo 5 mm, los LEDs y las lentes son capaces de generar un haz de luz extremadamente potente y controlado.



The excellence of comfort: UGR is lower than 10 for an exceptional anti-glare protection, homogeneity of light distribution and lux performance, in accordance to the strictest industry standards.

La excelencia del confort: UGR inferior a 10 para una protección antideslumbrante excepcional, homogeneidad en la distribución de la luz y rendimiento en cuanto a lux, de acuerdo con los estándares más estrictos de la industria.







Patented ultra-flat lens with a very high efficiency of 97%. Rounded flat head for minimum visual intrusion.

Lente ultraplana patentada a altísima eficiencia de 97%. Cabeza plana redondeada para la mínima intrusión visual.

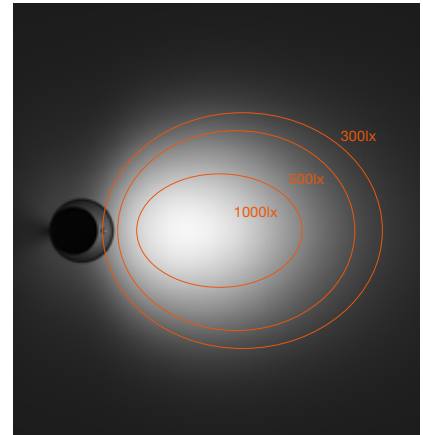

Base with integrated wireless charging system. Allows you to charge your smartphone while freeing your desk from unsightly crossed cables.

Base con sistema de carga inalámbrica integrado. Permite cargar su smartphone al liberar el escritorio de cables y enredos antiestéticos.



Oblique always features a USB-C port integrated in the back of the base that can be used to charge additional devices.

Oblique dispone siempre de un puerto USB-C integrado en la parte trasera de la base que puede ser usado para la carga de dispositivos externos.











The capacitive button at the bottom of the luminaire head offers the highest quality haptic interaction and allows control of the functioning and dimming of Oblique Floor.

El botón capacitativo situado en la parte inferior de la cabeza de la luminaria ofrece una interacción háptica de máxima calidad y permite el control del funcionamiento y la regulación de Oblique Floor.



Due to its chosen height and the studied asymmetrical angle of Oblique Floor, this is an ideal luminaire for reading lighting next to armchairs or reading chairs.

Por su escogida altura y el estudiado ángulo asimétrico de Oblique Floor, esta es una luminaria ideal para la iluminación de lectura junto a butacas o sillones de lectura.

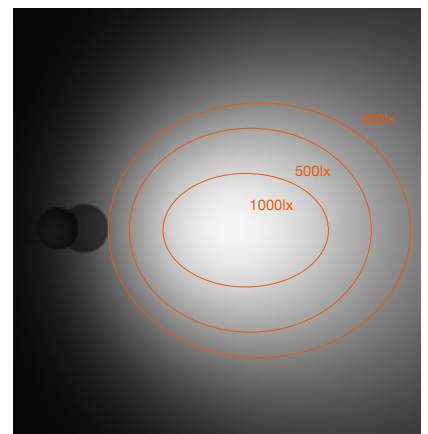

The collection is available in different finishes, from the classic white, grey and anthracite, to the most sophisticated pastel shades, specifically created to customize the working environment.

Colección disponible en diferentes acabados, desde el clásico blanco, gris y antracita hasta los más sofisticados tonos pastel, creados específicamente para permitir la personalización del entorno de trabajo.

White / Grey / Rust / Brown / Anthracite / Salvia







OBLIQUE

OBLIQUE FLOOR



POWER LED
8W

POWER LED
8W

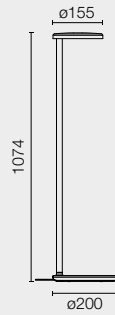
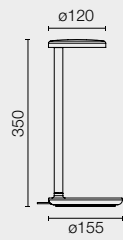

□ Matt White
Blanco Mate

■ Gloss Grey
Gris Brillo

■ Matt Rust
Óxido Mate

■ Matt Brown
Marrón Mate

■ Matt Anthracite
Antracita Mate

■ Gloss Salvia
Salvia Brillo



Asymmetric
Flood

ZERO TRACK

ZERO TRAC

ZERO TRA

ZERO TR

ZERO T

ZERO

ZER

ZE

Z PRO

Zero Track Pro is a low-voltage (24V) profile available in two versions: recessed and surface-mounted, allowing it to integrate seamlessly into different types of spaces. Its sleek and elegant design provides a modern and minimalist aesthetic.

Zero Track Pro es un perfil de bajo voltaje (24 V) disponible en dos versiones: empotrado, y de superficie, lo que le permite integrarse a la perfección en distintos tipos de espacios. Su diseño estilizado y elegante aporta una estética moderna y minimalista.

ZERO TRACK PRO

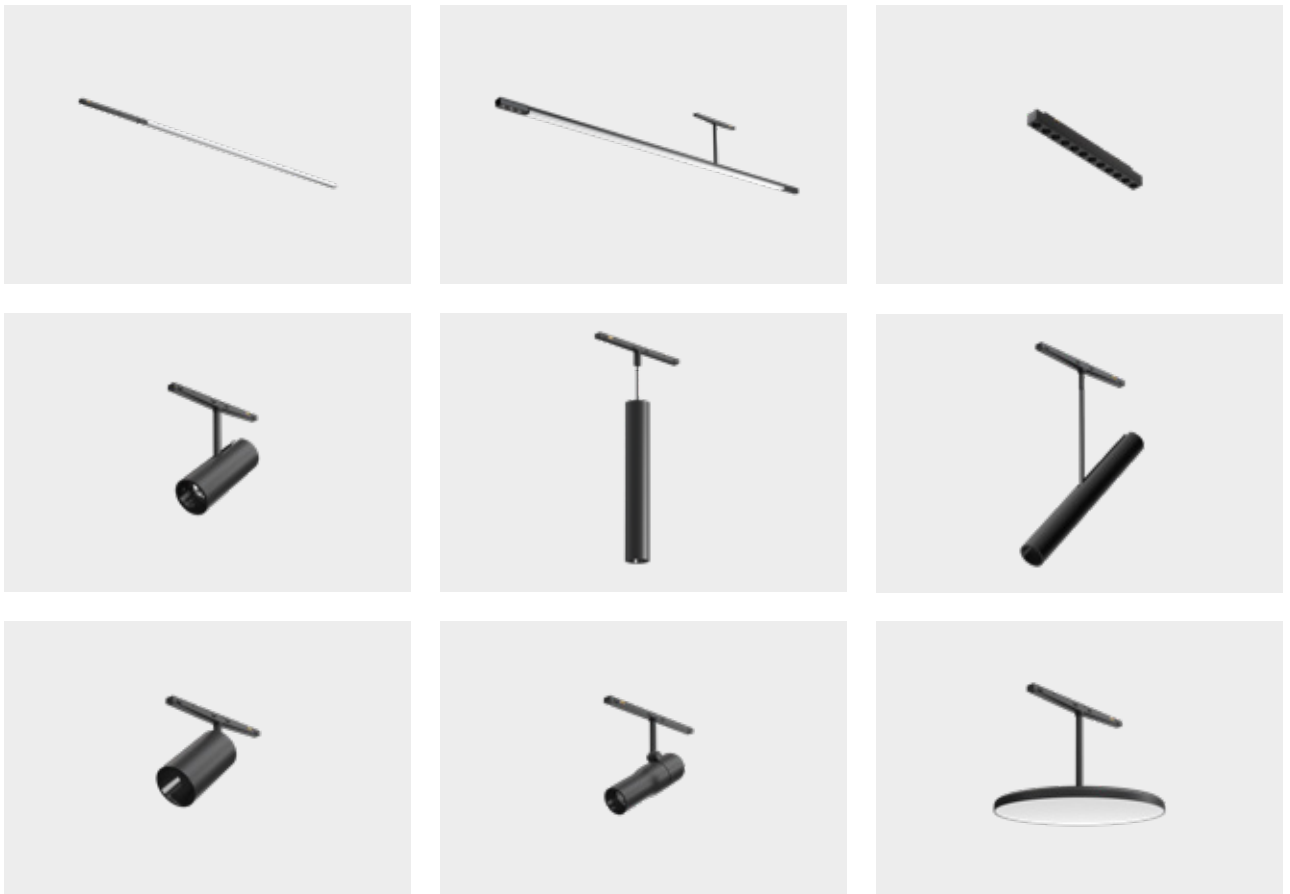





The system consists of low-voltage (24V) profiles designed to accommodate a wide and varied selection of luminaires, making it a flexible and efficient solution. These profiles are suitable for surface or recessed installation on both ceilings and walls.

El sistema consta de perfiles de baja tensión (24 V) diseñados para alojar una amplia y variada selección de luminarias, lo que lo convierte en una solución flexible y eficaz. Estos perfiles son aptos para su instalación en superficie o empotrada, tanto en techos como en paredes.



1 RECESSED

2 SURFACE

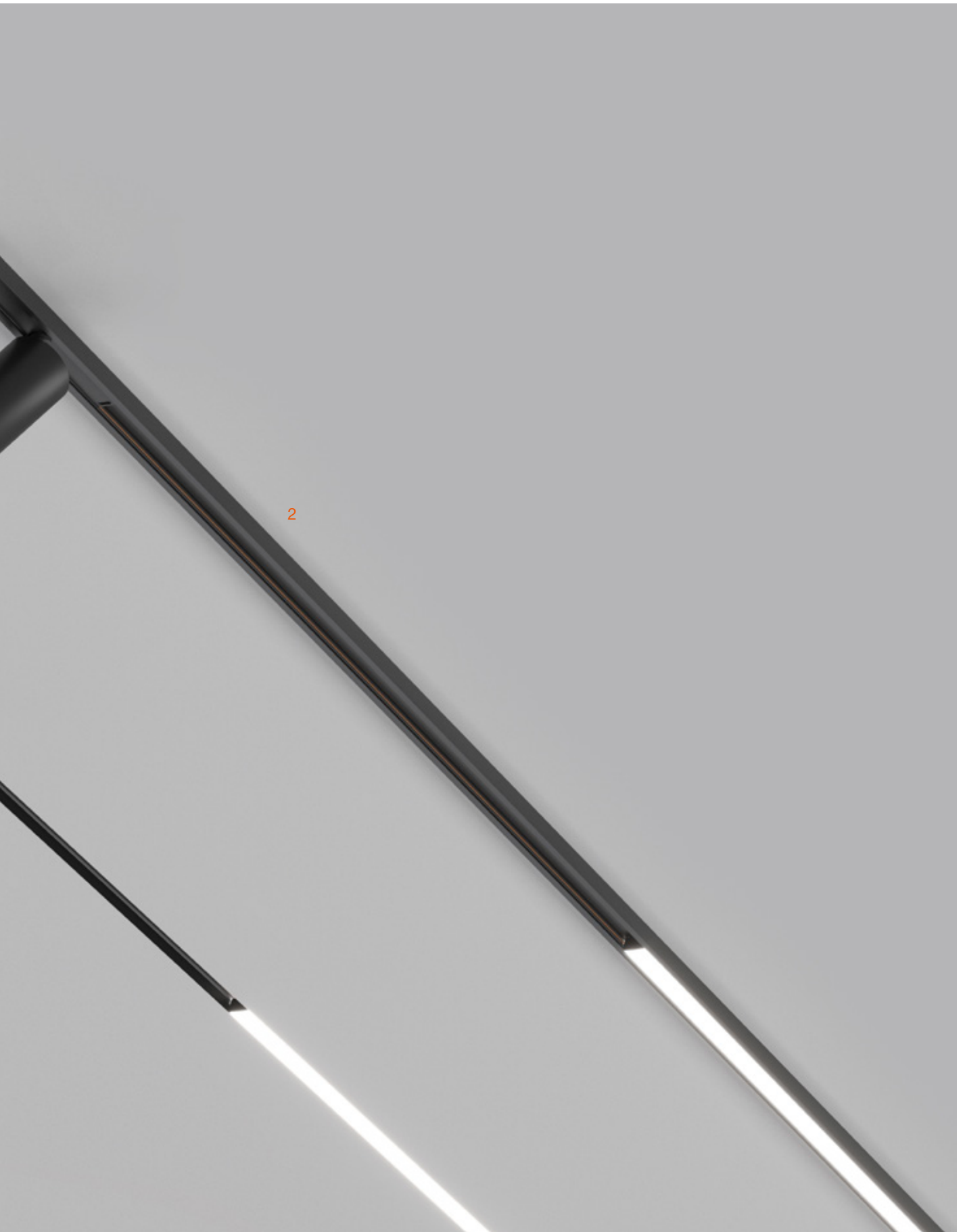

Compact dimensions, optimal integration.
Zero Track Pro's dimensions ensure seamless architectural integration. The recessed version appears as a subtle, minimalist line, while the surface-mounted variant offers a refined and discreet presence.

Dimensiones compactas, integración óptima.
Las dimensiones de Zero Track Pro garantizan una integración arquitectónica perfecta. La versión empotrada se presenta como una línea sutil y minimalista, mientras que la variante de superficie ofrece una presencia refinada y discreta.

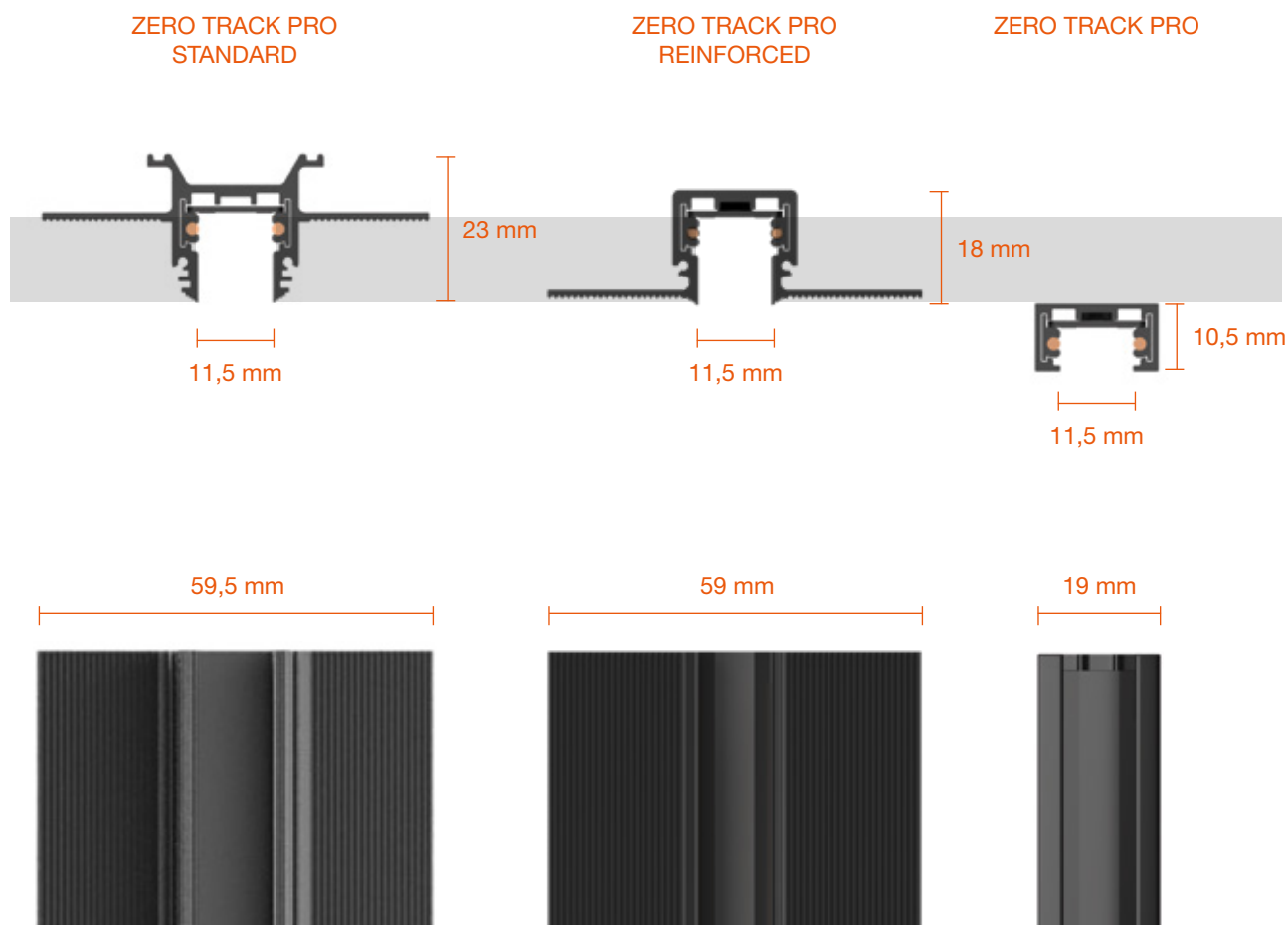





1. Blind End
2. Linear Conector Feed
3. Straight Connector
4. X Connector Feed
5. 90° Corner Feed
6. T Connector Feed
7. Power Supply Surface End
8. Power Supply Surface Middle
9. Inner Corner
10. Live End Feed

Zero Track Pro Surface offers ideal integration with architectural spaces, providing flexibility in track and path layouts. A complete set of connectors (T, X and L), along with dihedral corner joints, ensures seamless transitions between ceiling and wall or across different walls.

Zero Track Pro Surface ofrece una integración ideal con los espacios arquitectónicos, proporcionando flexibilidad en la disposición de las vías y los recorridos. Un juego completo de conectores (T, X y L), junto con juntas de esquina diedro, garantizan transiciones perfectas entre techo y pared o a través de distintas paredes.

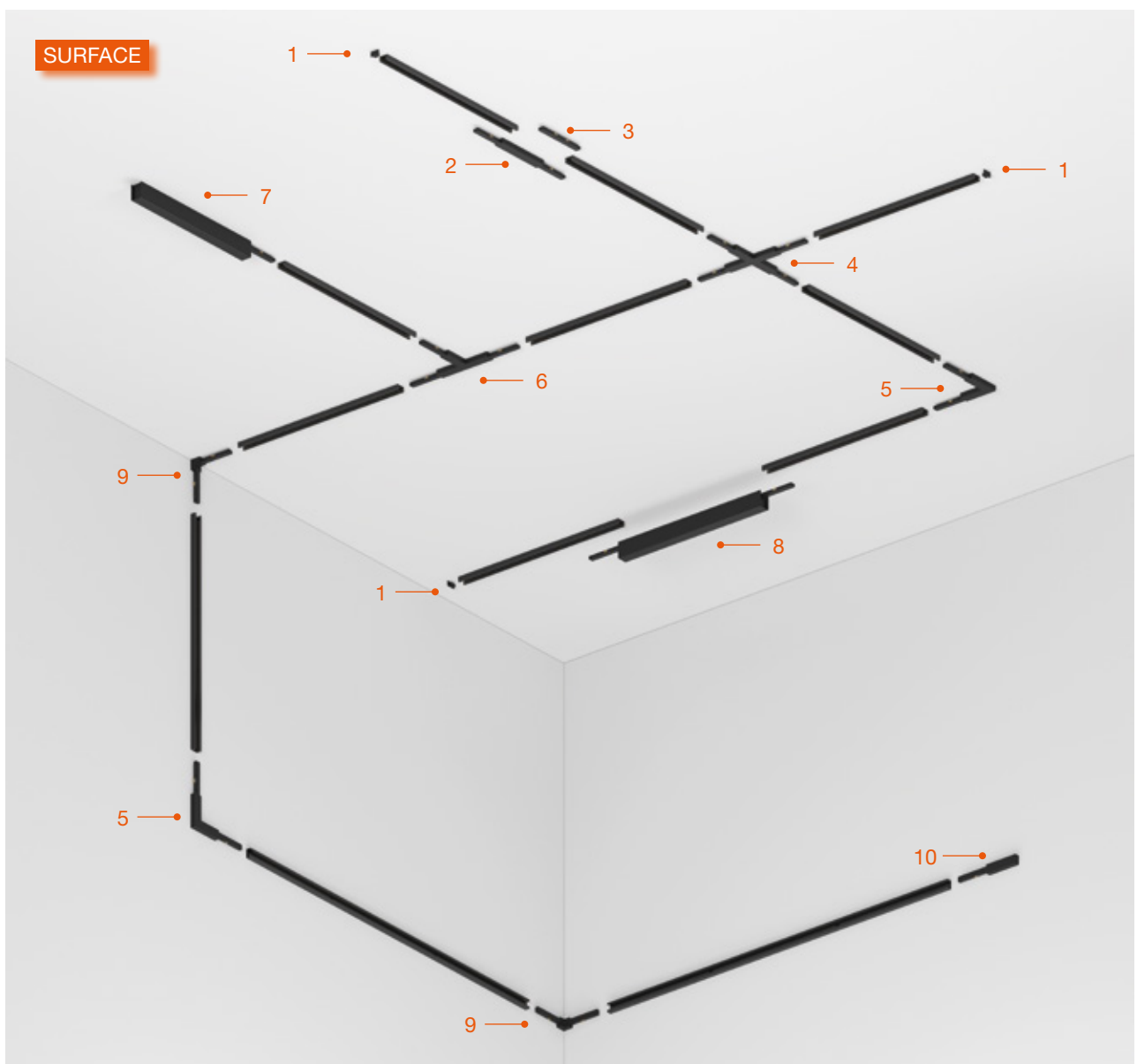



1. Live End Feed
2. Profile
3. Straight Connector
4. X Connector
5. T Connector
6. Inner Corner
7. 90° Corner
8. Blind End

Zero Track Pro Recessed merges effortlessly with the architecture – an elegant yet accessible solution that expands design possibilities for tracks and pathways. Featuring T, X and L junctions, along with dihedral corner elements, it allows smooth, continuous transitions between walls and ceilings or across multiple walls.

Zero Track Pro Recessed se fusiona sin esfuerzo con la arquitectura: una solución elegante pero accesible que amplía las posibilidades de diseño de vías y caminos. Con uniones en T, X y L, junto con elementos de esquina diedros, permite transiciones suaves y continuas entre paredes y techos o a través de varias paredes.

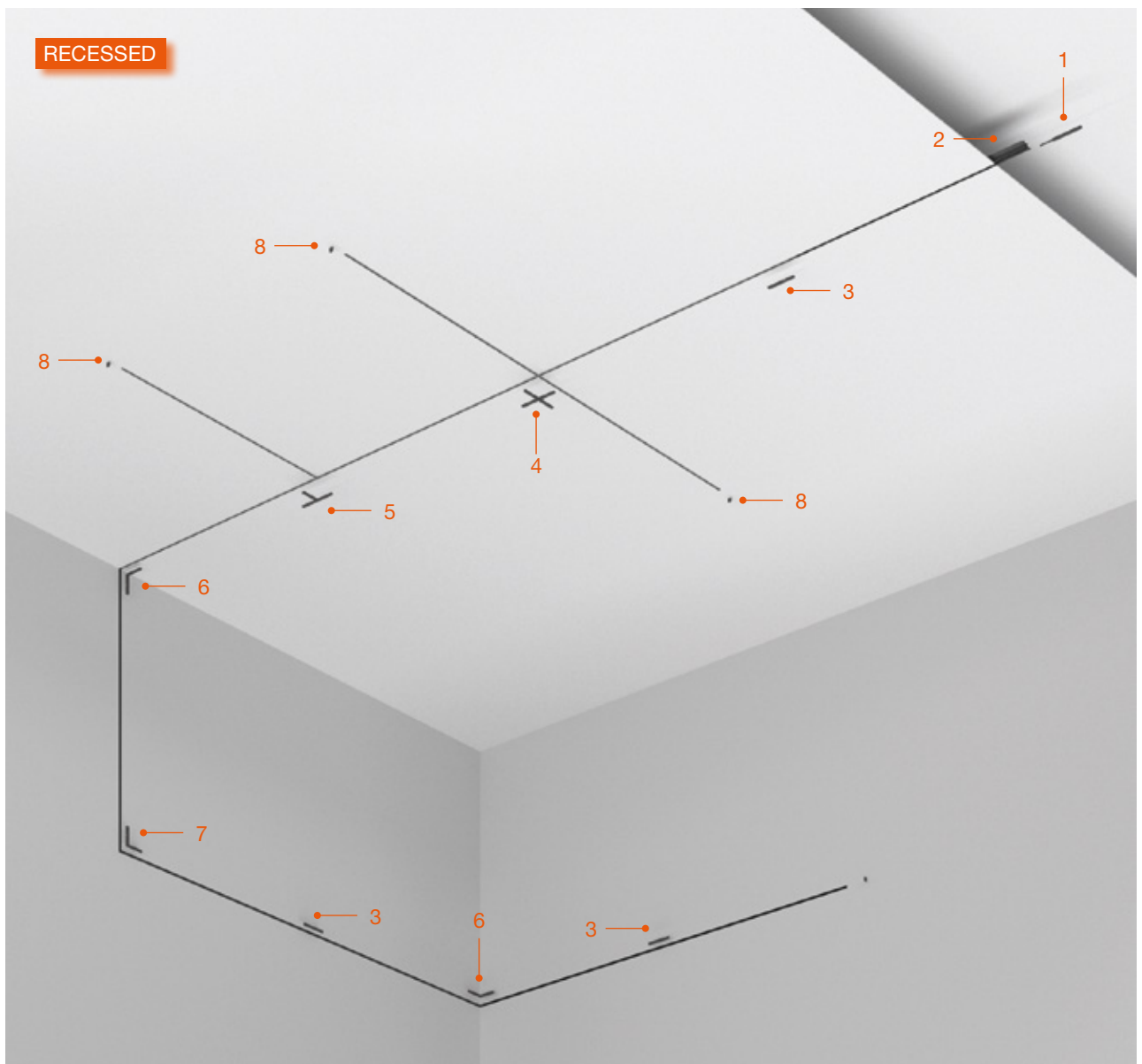

ZERO TRACK PRO SURFACE

In its surface version, with dimensions reduced to the minimum, it combines a minimalist design with maximum functionality. Its easy installation makes it an ideal solution for any space, offering versatility and seamless architectural integration without the need for recessing.

En su versión de superficie, con dimensiones reducidas al mínimo, combina un diseño minimalista con la máxima funcionalidad. Su fácil instalación la convierte en una solución ideal para cualquier espacio, ofreciendo versatilidad y una perfecta integración arquitectónica sin necesidad de empotrar.

ZERO TRACK PRO RECESSED

Zero Track Pro redefines lighting with its simple design and clean, sophisticated aesthetic. It is designed to integrate smoothly into the ceiling, preserving the purity of architectural lines. Two alternative profiles are available to suit any type of ceiling construction.

Zero Track Pro redefine la iluminación con su diseño sencillo y su estética limpia y sofisticada. Está diseñada para integrarse suavemente en el techo, preservando la pureza de las líneas arquitectónicas. Hay dos perfiles alternativos disponibles para adaptarse a cualquier tipo de construcción de techo.

1 Zero Track Pro Recessed Standard.

The track can be installed with top access when the false ceiling or mounting surface is accessible from above, allowing the track to be fixed before closing the ceiling.

El carril se puede instalar con acceso superior cuando el falso techo o la superficie de montaje es accesible desde la parte superior, lo que permite fijar el carril antes de cerrar el techo.

2 Zero Track Pro Recessed Reinforced.

Top access is not possible, so the track must be fixed from below. No es posible acceder a la parte superior del techo, por lo que el carril debe fijarse desde abajo.





ZERO TRACK & PRO SYSTEM



1 Data transmission BUS*.
BUS* para la transmisión de datos.

2 Low voltage electric conductors.
Conductores eléctricos de baja tensión.

3 Casambi wireless control electronics,
incorporated in the light. (* See models).
Electrónica de control inalámbrico Casambi,
integrada en la luminaria. (* Consultar
modelos).

Zero Track Pro features a small section with electric conductors and data transmission BUS*. The result is a compact solution with the most selective control system for managing lights individually (point to point) via DALI* protocol or wireless Casambi control. Similarly, 1-10V* broadcast control is possible.

Zero Track Pro cuenta en su diminuta sección con conductores eléctricos y BUS* para la transmisión de datos. Esto hace de él una solución compatible con los sistemas de control más exigentes para gestionar las luminarias individualmente (punto a punto), bien bajo protocolo DALI* o a través de control inalámbrico Casambi. Así mismo, es posible la gestión broadcast 1-10V*.

TRADITIONAL SYSTEM

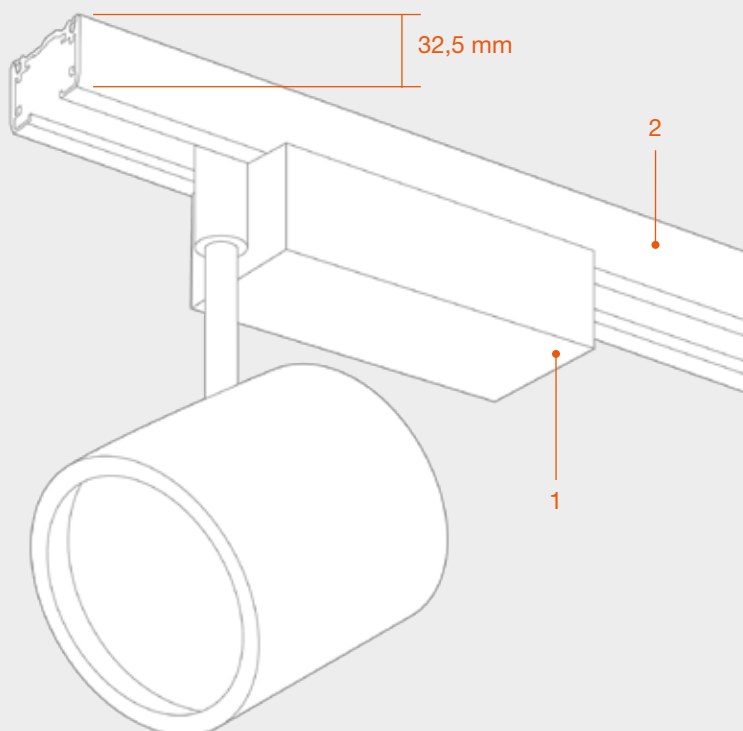

1 Traditional Engine
Motor Tradicional

2 Traditional Track
Track Tradicional

In addition to the remote power supply option, Zero Track & Pro features an alternative with the system powered from a surface power supply box offered as an accessory.

Además de la opción de alimentación con equipo remoto, Zero Track & Pro cuenta con la alternativa de alimentar el sistema desde un equipo en superficie junto al carril, gracias a las 'Surface power supply box' que se ofrecen como accesorio.



FIND ME

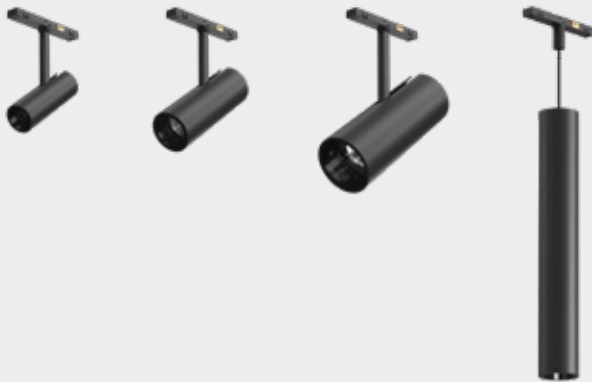

The Zero Track luminaire collection includes Find Me spotlights, designed by Jorge Herrera. With an innovative, cutting-edge approach, the design stands out not only for its minimalist aesthetic but also for its versatility. Available in three sizes, including a suspended version.

La colección de luminarias Zero Track incluye los proyectores Find Me, diseñados por Jorge Herrera. Con un enfoque innovador y vanguardista, el diseño destaca no sólo por su estética minimalista, sino también por su versatilidad. Disponible en tres tamaños, incluida una versión suspendida.

ATOM



With the distinctive design flair of Piero Lissoni, Atom also features in the Zero Track Pro system: a series of spotlights available in three sizes that are perfect for accent lighting and complemented by a round-shaped luminaire for more general illumination.

Con el inconfundible estilo de diseño de Piero Lissoni, Atom también forma parte del sistema Zero Track Pro: una serie de focos disponibles en tres tamaños que son perfectos para la iluminación de acento y se complementan con una luminaria de forma redonda para una iluminación más general.









The high visual comfort technology and dual-focus lenses of the Light Shadow family are also incorporated into Zero Track Pro, with Light Shadow Spot models available in two sizes: 30 and 45.

La tecnología de alto confort visual y las lentes de doble enfoque de la familia Light Shadow también se incorporan a la Zero Track Pro, con modelos Light Shadow Spot disponibles en dos tamaños: 30 y 45.



Light Stripe is a diffuse light strip designed for seamless integration into the Zero Track Pro system. It delivers soft, uniform illumination, ideal for creating pleasant, modern atmospheres.

Light Stripe es una tira de luz difusa diseñada para integrarse perfectamente en el sistema Zero Track Pro. Proporciona una iluminación suave y uniforme, ideal para crear ambientes agradables y modernos.

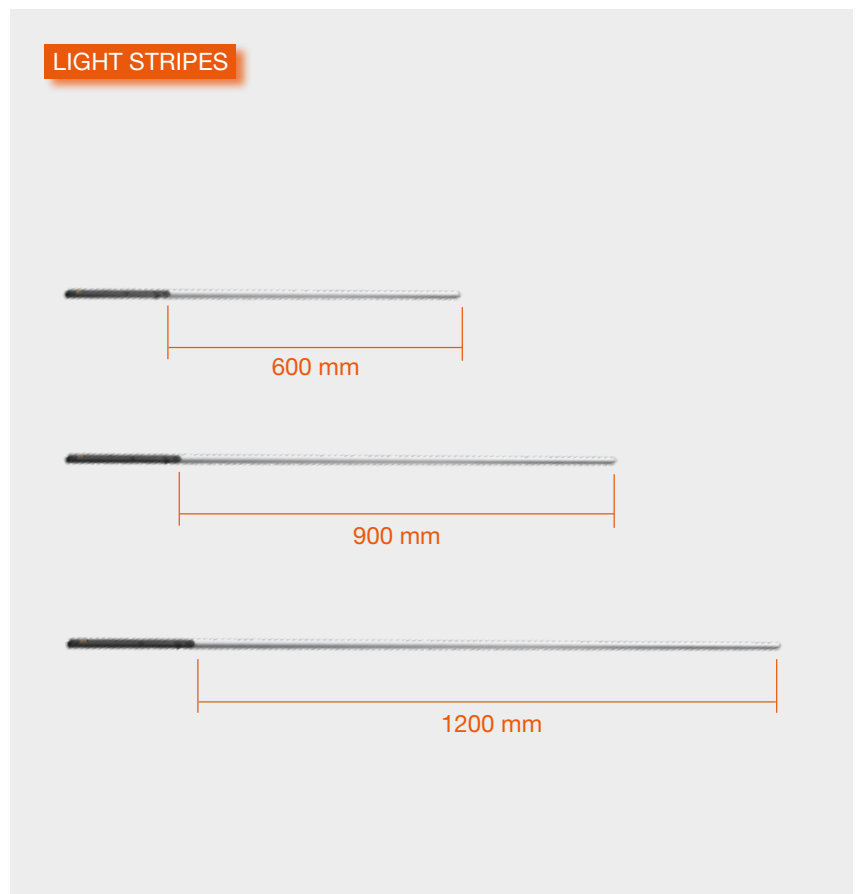



Designed by Jorge Herrera, Magic Stick is a unique luminaire that offers the flexibility to transform any space through bold, custom visual compositions.

Diseñada por Jorge Herrera, Magic Stick es una luminaria única que ofrece la flexibilidad necesaria para transformar cualquier espacio mediante composiciones visuales audaces y personalizadas.

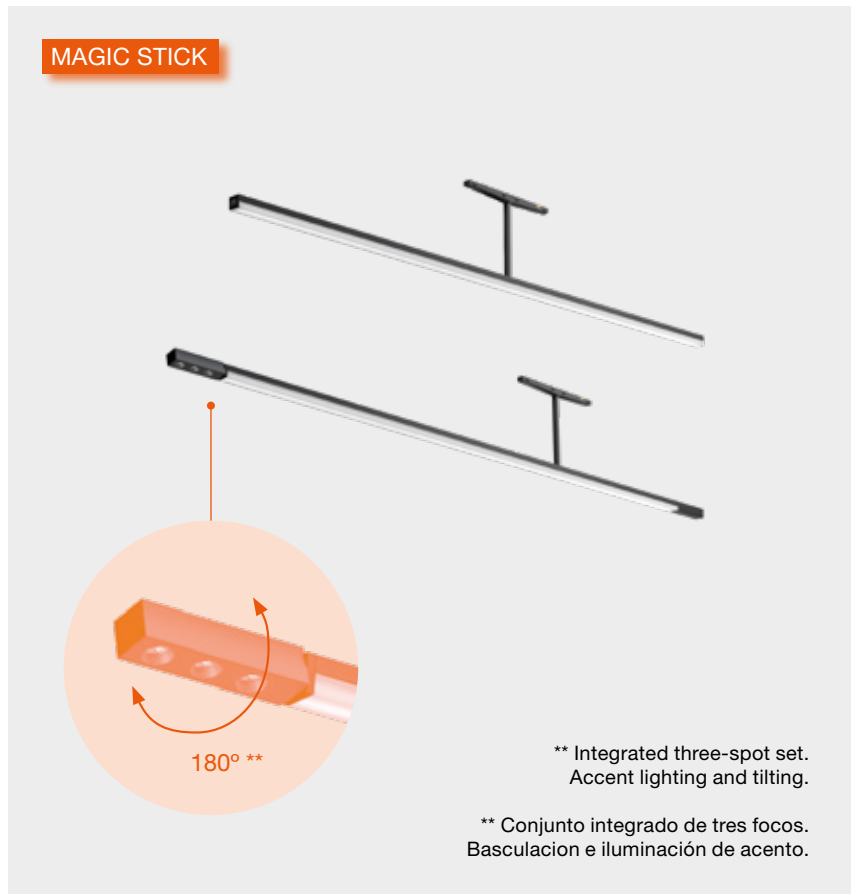

Thanks to Magic Stick, Zero Track Pro provides a unique experience that transforms any space, through its ability to create bold and unparalleled visual compositions. The examples presented only represent some of its many possibilities.

Gracias a Magic Stick, Zero Track Pro ofrece una experiencia única que transforma cualquier espacio, a través de su capacidad para crear composiciones visuales atrevidas e incomparables. Los ejemplos expuestos solamente representan algunas de sus múltiples posibilidades.



MY SPOT



My Spot, the projector designed by Michael Anastassiades, integrates effortlessly into Zero Track Pro with its elegant and discreet design. Together, they offer absolute flexibility and the ability to create sophisticated, one-of-a-kind lighting solutions.

My Spot, un proyector diseñado por Michael Anastassiades, se integra sin esfuerzo en Zero Track Pro con su diseño elegante y discreto. Juntos, ofrecen una flexibilidad absoluta y la capacidad de crear soluciones de iluminación sofisticadas y únicas.

MULTI SPOT MINI



The Multi Spot Mini is a compact module that combines low glare with powerful lighting capabilities. It offers an elegant and efficient solution, ensuring precise light control that directs brightness outward without unwanted reflections.

El Multi Spot Mini es un módulo compacto que combina un bajo deslumbramiento con una potente capacidad de iluminación. Ofrece una solución elegante y eficiente, garantizando un control preciso de la luz que dirige el brillo hacia el exterior sin reflejos no deseados.



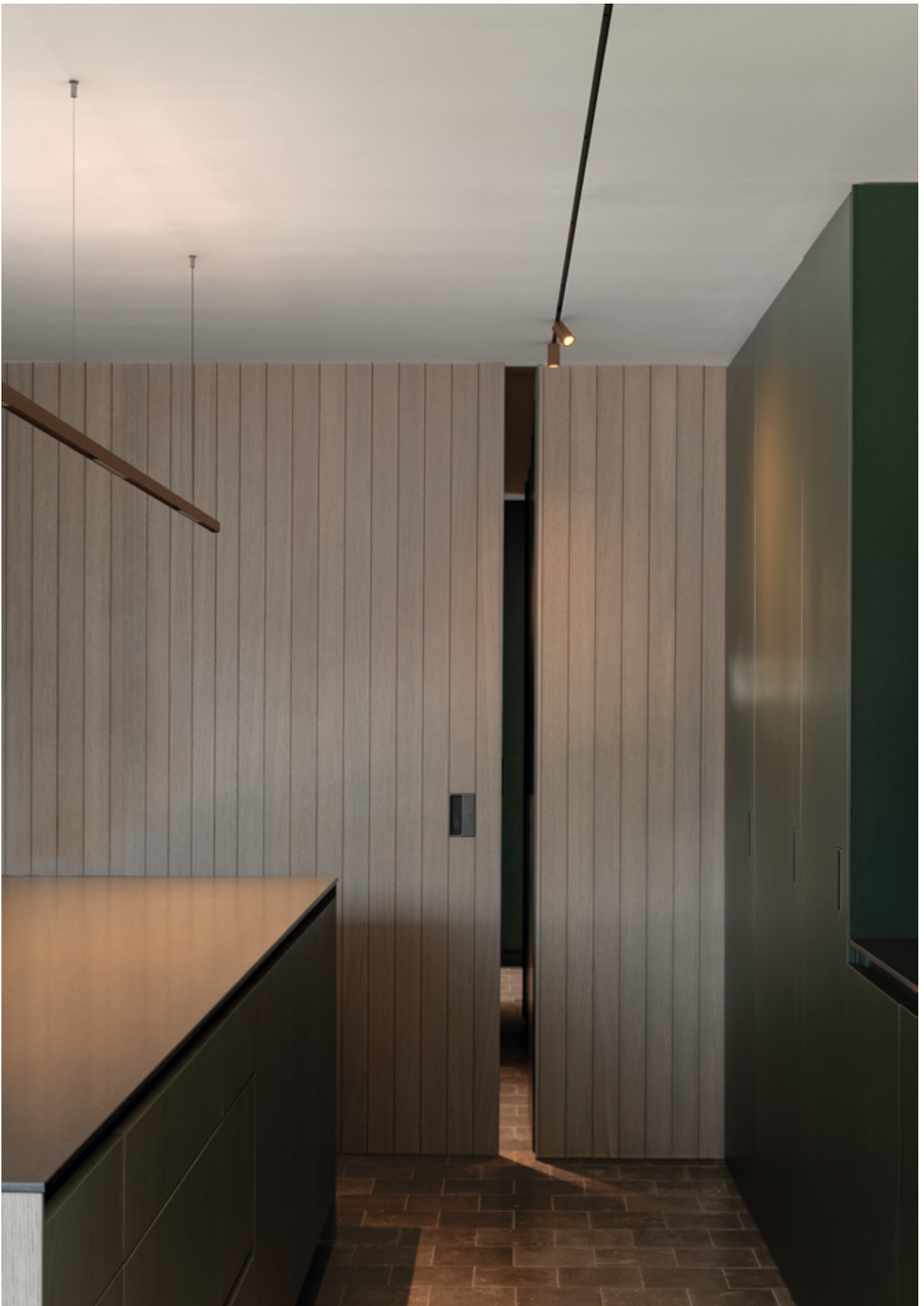

Zero Track Pro incorporates exclusive Flos metallic finishes in steel and bronze, with a brushed texture. This premium aesthetic is available for both the Zero Track Pro profiles and their compatible luminaires.

Zero Track Pro incorpora los exclusivos acabados metálicos de Flos en acero y bronce, con una textura cepillada. Esta estética exclusiva y elegante está disponible tanto para los perfiles Zero Track Pro como para sus luminarias compatibles.

Track Finish / Acabado del Perfil

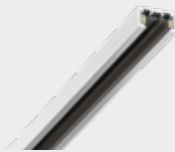

White



Black



Brushed Steel



Brushed Bronze

Spot Finish / Acabado del Spot



White



Black



Brushed Steel



Brushed Bronze

	Different control options for dimming the Zero Track Pro.	Diferentes opciones de control para la regulación de Zero Track Pro.
DALI	Standard protocol for integration with any control system.	Protocolo estándar para la integración con cualquier sistema de control.
1-10V BROADCAST	Track control through a dimmer device.	Control de la pista a través de un dispositivo de regulación.
CASAMBI	Track wireless control through the FLOS Control®, available iOS and Android devices.	Control inalámbrico de la pista a través de la aplicación FLOS Control®, disponible para dispositivos iOS y Android.





LIGHT MODULES

LIGHT STRIPE
600 / 900 / 1200



TOP LED
Up to 13,5W

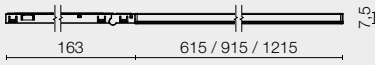

MAGIC STICK



POWER LED
10,5W

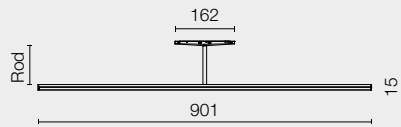

Rod: 100 / 145 / Custom

MAGIC STICK
ASYMMETRIC



POWER LED
12W

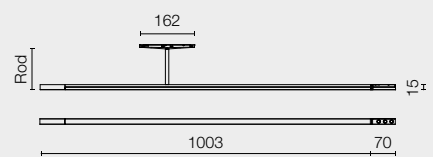

Rod: 100 / 145 / Custom

ATOM 90



POWER LED
5,5W

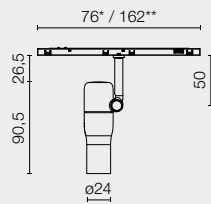

ATOM 120



POWER LED
8W

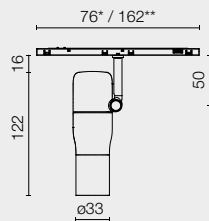

ATOM 200



TOP LED
10,5W

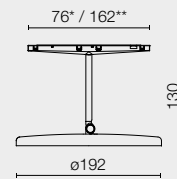

* Non Dimmable, Casambi / ** Dali, 1-10V



Spot



Medium



Flood



Wide Flood

LIGHT MODULES

MULTI SPOT MINI

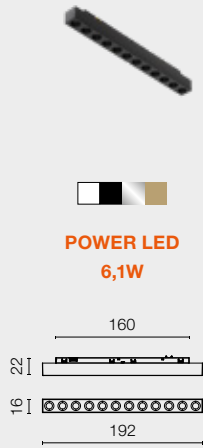

POWER LED
6,1W

LIGHT SHADOW
SPOT 30

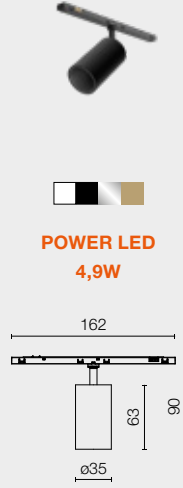

POWER LED
4,9W

LIGHT SHADOW
SPOT 45

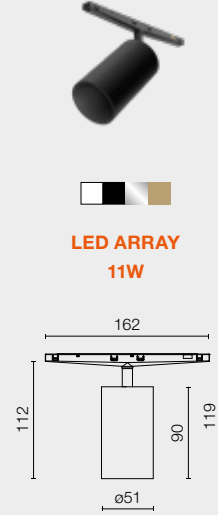

LED ARRAY
11W

FIND ME 0

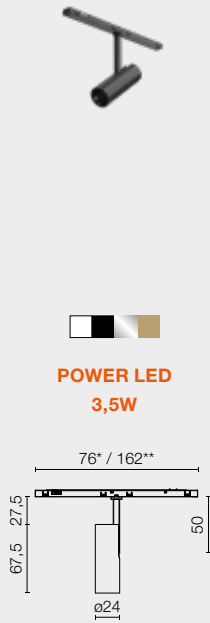

POWER LED
3,5W

FIND ME 1

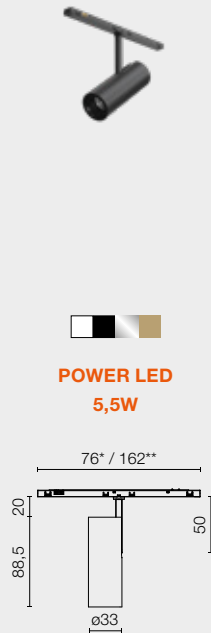

POWER LED
5,5W

FIND ME 2

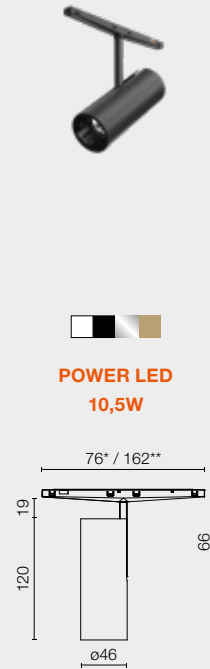

POWER LED
10,5W

FIND ME 1
SUSPENSION

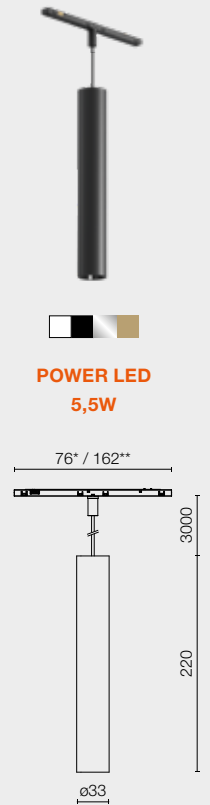

POWER LED
5,5W

* Non Dimmable, Casambi / ** Dali, 1-10V

LIGHT MODULES

MY SPOT Ø25
SHORT



POWER LED
Up to 4,7W

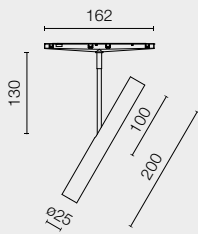

MY SPOT Ø25
LONG



POWER LED
Up to 4,7W

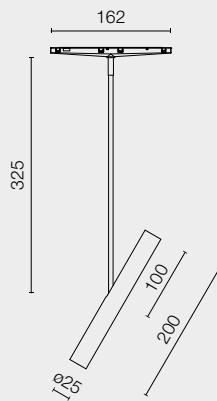

MY SPOT Ø35
SHORT



LED ARRAY
Up to 11W

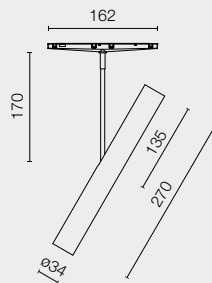

MY SPOT Ø35
LONG



LED ARRAY
Up to 11W

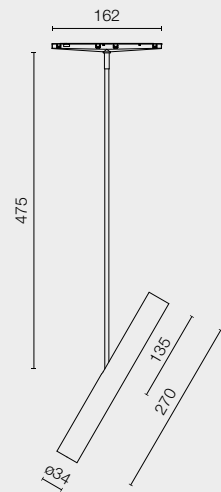

Spot



Medium



Flood

SURFACE PROFILES

□ 40 White
40 Blanco

■ 14 Black
14 Negro

▒ ER Brushed Steel
ER Acero Cepillado

■ ES Brushed Bronze
ES Bronce Cepillado

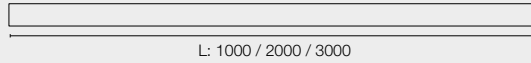

RECESSED PROFILES

ZERO TRACK PRO STANDARD

■ 14 Black
14 Negro

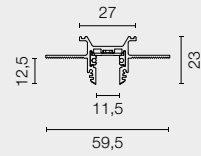
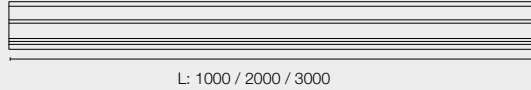
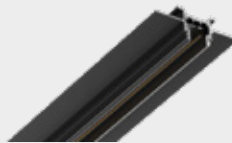

ZERO TRACK PRO REINFORCED

■ 14 Black
14 Negro

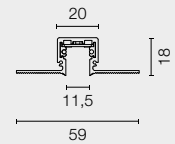
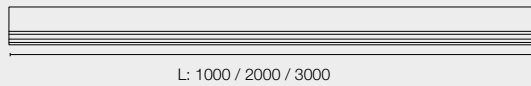

ZERO TRACK

ZERO TRAC

ZERO TRA

ZERO TR

ZERO T

ZERO

ZER

ZE

Z

Surface low voltage (24V) profile with a sleek, streamlined design to create a visual-flush solution for walls and ceilings. Zero Track combines the easy application of a surface structure with the sleek elegance of a flush installation.

Sistema de perfilera de bajo voltaje (24V) y de implementación en superficie que, gracias a su miniaturización y sencillez geométrica, genera el efecto visual de estar enrasado en el techo / pared. Zero Track aúna la facilidad de aplicación de una estructura superficial con la elegancia estética de una instalación empotrada.

ZERO TRACK

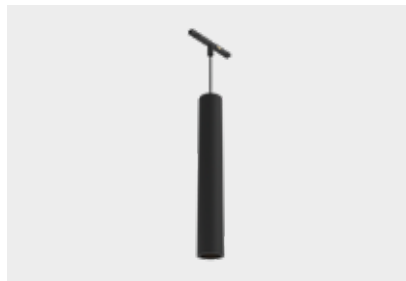
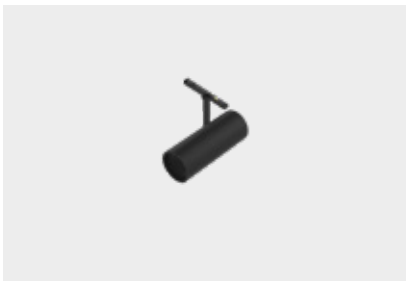



Restaurant Hert, Belgium





1. Blind End
2. Linear Conector Feed
3. Staight Connector
4. X Connector Feed
5. 90° Corner Feed
6. T Connector Feed
7. Power Supply Surface End
8. Power Supply Surface Middle
9. Inner Corner
10. Live End Feed

Perfect integration with the Zero Track architecture also enables considerable versatility with tracks and lines with T, X and L joints, plus interior angles for ceiling-wall and wall-wall plane variations.

La perfecta integración con la arquitectura que logra Zero Track permite además una gran versatilidad de recorridos y trazos con sus uniones en forma T, X, L y esquinas interiores diédricas para cambios de plano techo-pared, pared-pared y viceversa.

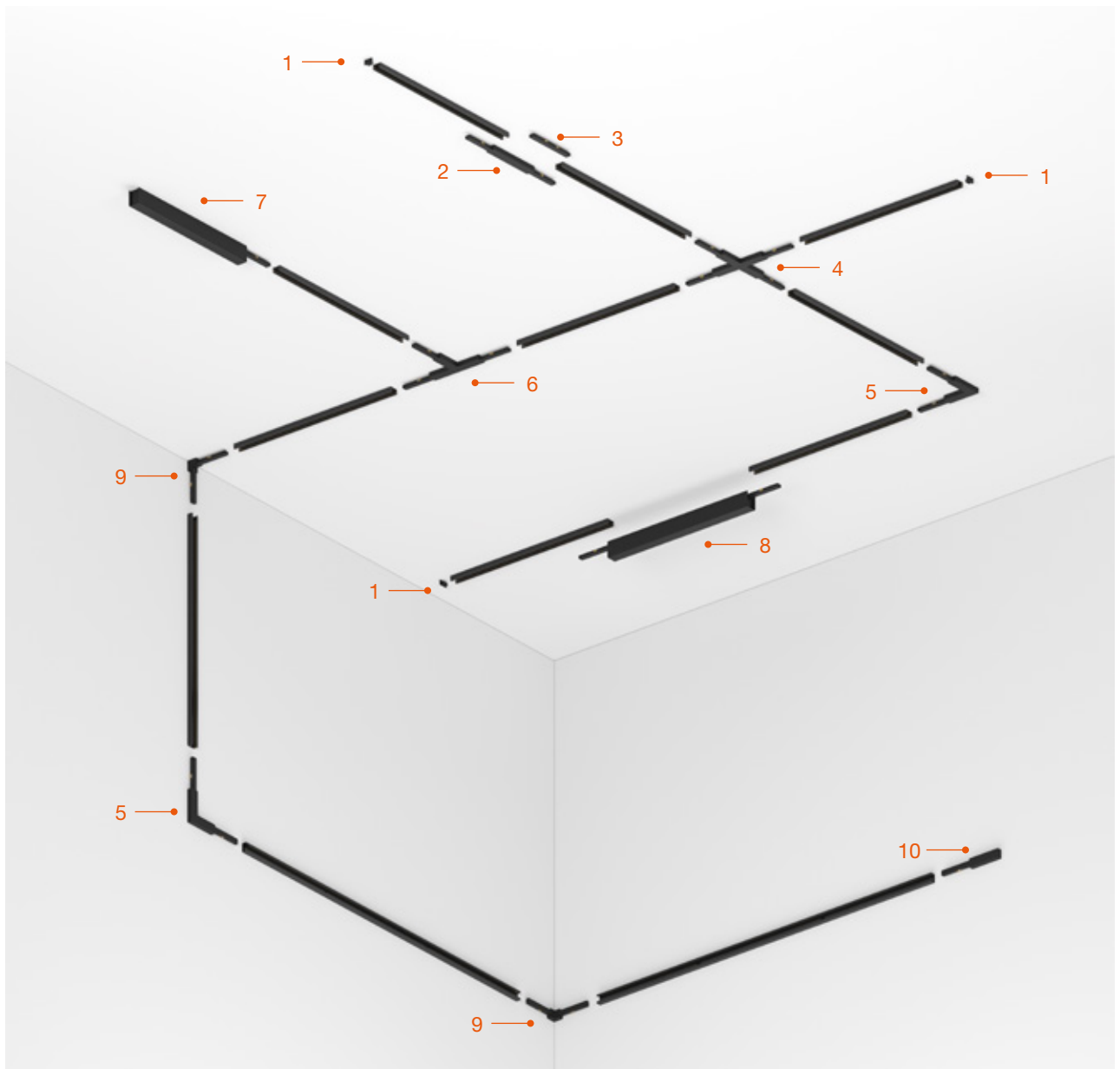





The dimensions of Zero Track ensure that visually its three-dimensionality is almost not perceived at the normal distance at which this type of product is installed. The Zero Track solution therefore looks like a trimless profile.

Las dimensiones de Zero Track permiten que, visualmente, su tridimensionalidad casi no se aprecie a la distancia normal de observación a la que se instala esta tipología de producto. Así, Zero Track es -estéticamente- un perfil de apariencia trimless.

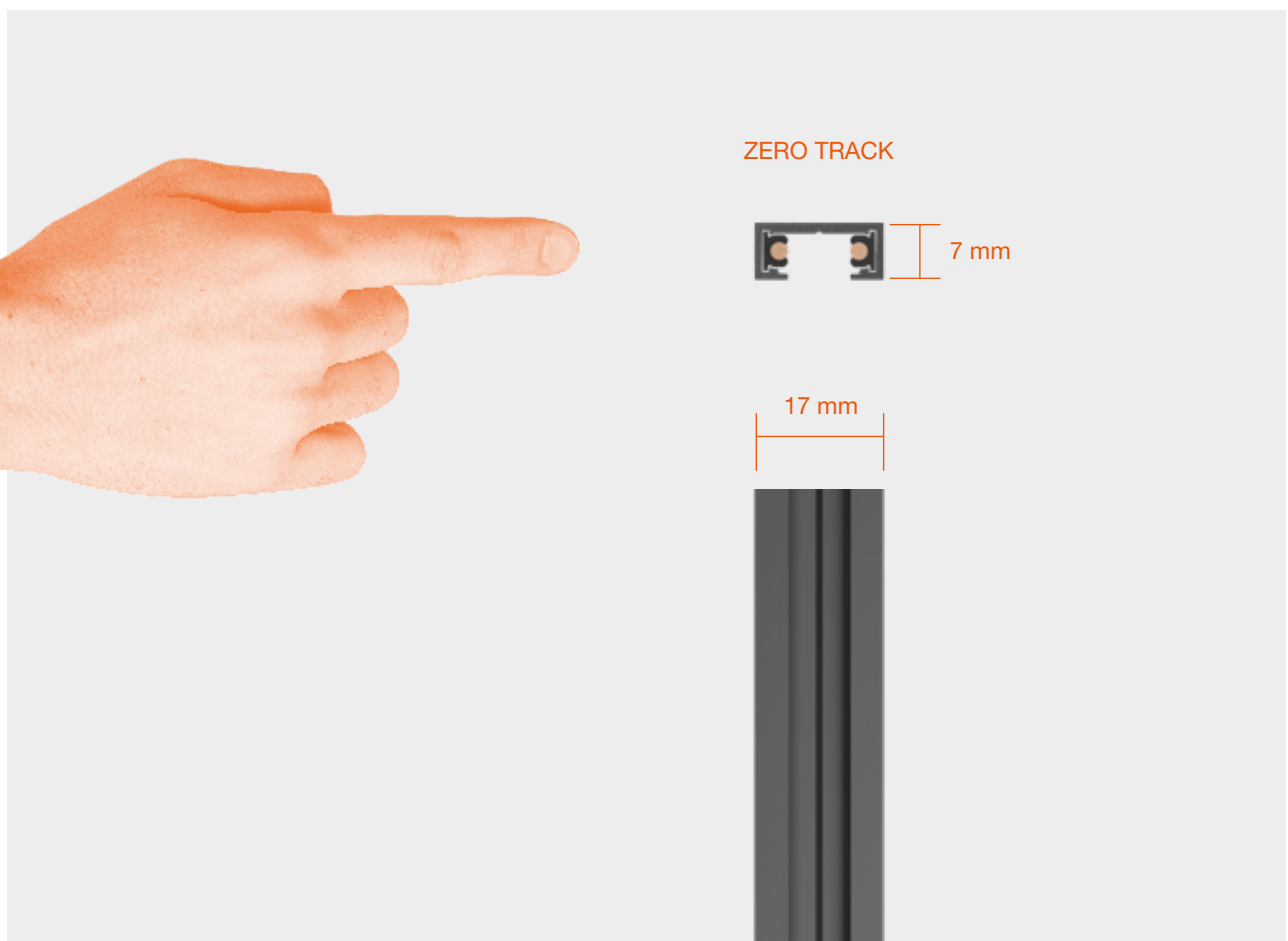



FIND ME

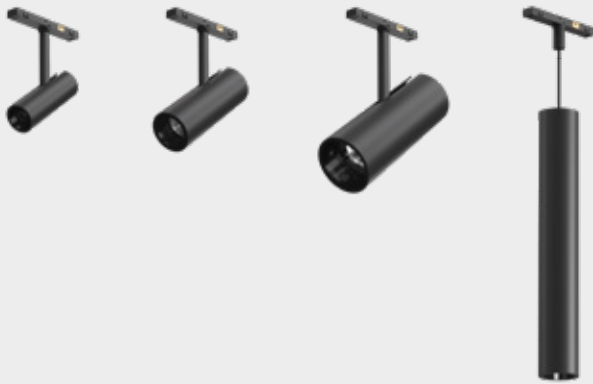

The Zero Track luminaire range includes the Find Me spots designed by Jorge Herrera. This innovative design embraces three different sizes, including the new Find Me 0, which brings the minimal designs of the successful Find Me collection.

La gama de luminarias Zero Track incluye los spots Find Me, diseñados por Jorge Herrera. Este innovador diseño abarca tres tamaños diferentes, incluyendo el nuevo Find Me 0, el cual brinda los diseños más minimalistas de la exitosa colección Find Me.

ATOM



With the exquisite design touch of Piero Lissoni, the Zero Track system offers Atom: a series of spotlights in three different sizes, perfect for an accent lighting.

The Zero Track system provides the highest comfort level thanks to the deep position of the optic and the screening accessories included with each spot, completed by a round shape luminaire for a general lighting.

Con el excelente toque de diseño de Piero Lissoni, el sistema Zero Track ofrece Atom: una serie de focos en tres tamaños diferentes, perfectos para una iluminación de acento.

El sistema Zero Track proporciona el máximo nivel de confort gracias a la posición profunda de la óptica y a los accesorios de apantallamiento incluidos en cada spot, completados por una luminaria de forma redonda para una iluminación más general.









Different control options that can be adapted to any need.

Diferentes opciones de control que pueden adaptarse a cualquier necesidad.

CASAMBI

Individual & Broadcast control through a tablet or smartphone application (FLOS Control®).

Control individual y broadcast a través de una aplicación para tablet o smartphone (FLOS Control®).

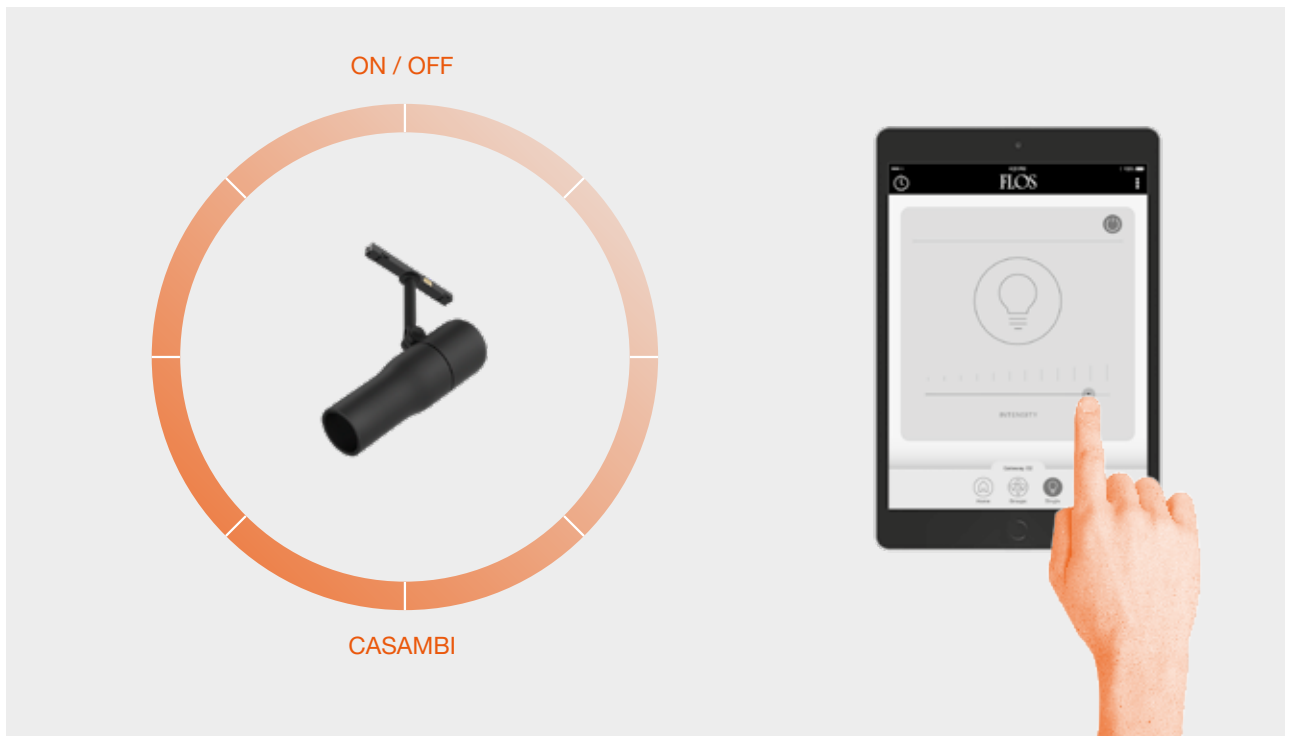

FLOS CONTROL® BY CASAMBI

The FLOS Control® application allows you to control the system's luminaires controlling scenes and programming.

La aplicación FLOS Control®, permite controlar las luminarias del sistema controlando escenas y programación.

With a traditional electrical installation and the Gateway connected by Bluetooth, you obtain total control of the ambience.

Con tan sólo una instalación eléctrica tradicional y el Gateway conectado por Bluetooth se obtiene un control total del ambiente.

Available for iOS and Android

Disponible en iOS y Android

LIGHT MODULES

FIND ME 0



POWER LED
3,5W

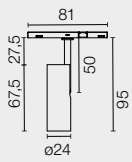

FIND ME 1



POWER LED
5,5W

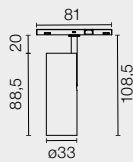

FIND ME 2



POWER LED
10,5W

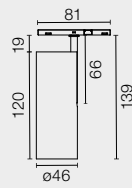

FIND ME 1
SUSPENSION



POWER LED
5,5W



ATOM 90



POWER LED
5,5W

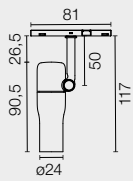

ATOM 120



POWER LED
8W

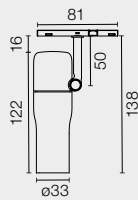

ATOM 200



POWER LED
10,5W

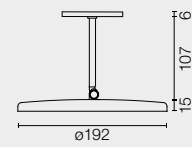

Spot



Medium



Flood

SURFACE PROFILES

□ 40 White
40 Blanco

◻ 05 Polished Silver
05 Plata Pulida

■ 14 Black
14 Negro

■ CZ Bronze
CZ Bronze

■ 18 Deep brown
18 Deep brown

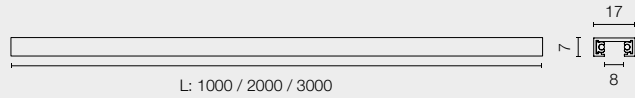

THE MICRO THE MICRO THE MICRO THE MICRO

RUNNING MAGNET

THE MICRO THE MICRO THE MICRO THE MICRO

RUNNING MAGNET

THE MICRO THE MICRO THE MICRO THE MICRO

RUNNING MAGNET

THE MICRO THE MICRO THE MICRO THE MICRO

RUNNING MAGNET

THE MICRO THE MICRO THE MICRO THE MICRO

RUNNING MAGNET

THE MICRO THE MICRO THE MICRO THE MICRO

RUNNING MAGNET

THE MICRO THE MICRO THE MICRO THE MICRO

RUNNING MAGNET

THE MICRO THE MICRO THE MICRO THE MICRO

RUNNING MAGNET

Innovative program of ultra-miniaturized structures in recessed and surface versions. Compatible with a wide range of professional lighting solutions by means of magnetic fixing. The ultimate solution for exhibition lighting.

Innovador programa de estructuras ultraminia-turizadas en versión empotrada y de superficie. Compatible con una amplia gama de soluciones de iluminación profesional mediante fijación magnética. La solución definitiva para la iluminación de exposición.

THE MICRO RUNNING MAGNET







The quintessence of integrated light, obtained thanks to a profile of only 5 mm that allows the total integration of micro-devices designed to be combined with the structure until they disappear almost completely.

La quintaesencia de la luz integrada, obtenida gracias a un perfil de solo 5 mm que permite la integración total de microdispositivos diseñados para combinarse con la estructura hasta casi desaparecer.



1 RECESSED

2 SURFACE



The incredibly small profile size that characterizes the program enhances the light's flexibility and its relationship with the architecture. The lighting bodies are installed by means of a magnetic support inside the profile, providing an unparalleled ease of use.

El increíble tamaño reducido del perfil que caracteriza el programa realza la flexibilidad de la luz y su relación con la arquitectura. La instalación de los cuerpos iluminantes se realiza mediante un soporte magnético dentro del perfil para una facilidad de uso sin igual.

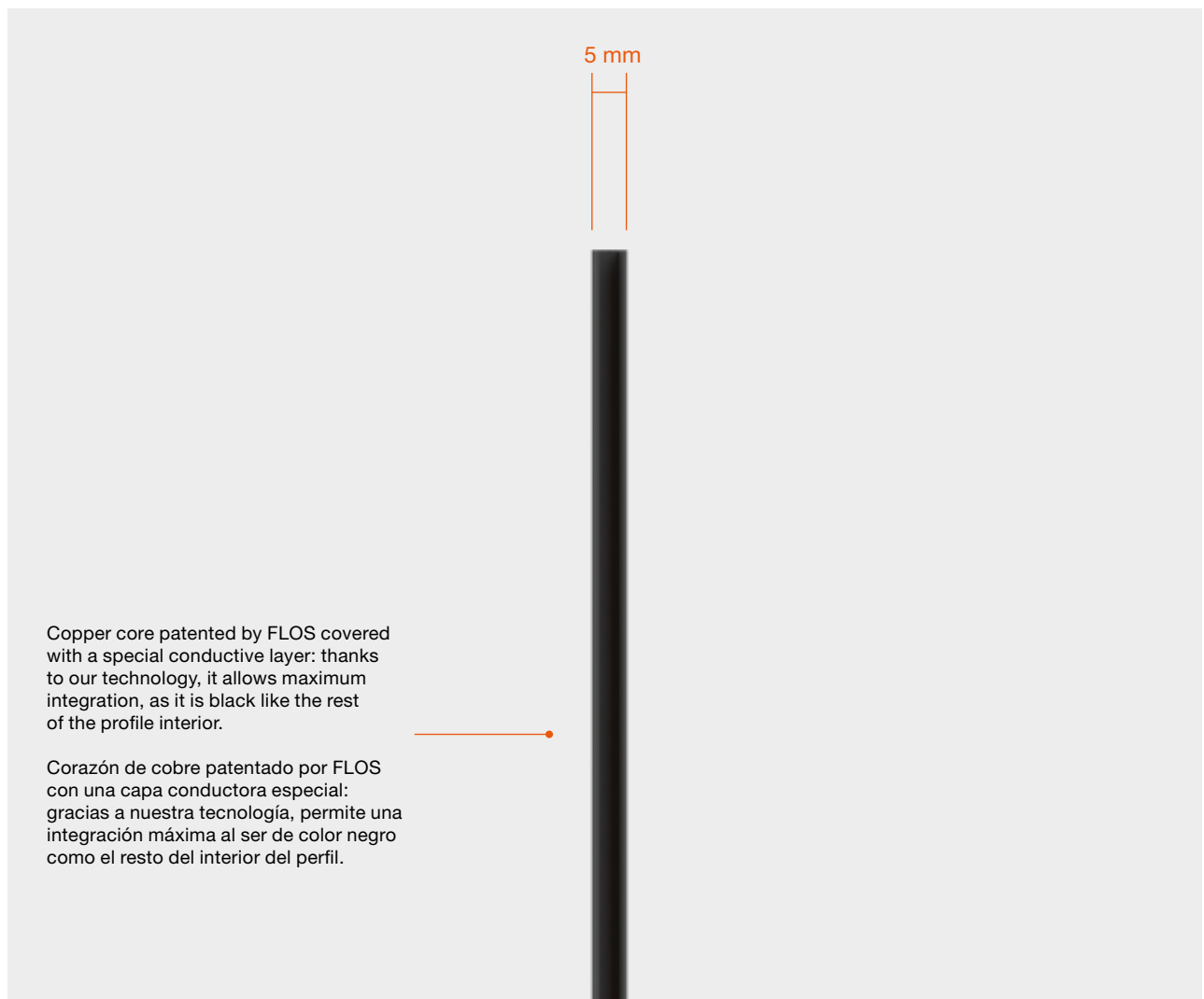





Magnetic fixing of the luminaires, which allows hot handling. The lighting bodies can be moved when they are still on, achieving enormous flexibility and adaptability in the configuration at any time.

Fijación magnética de las luminarias, lo que permite su manipulación en caliente. Los cuerpos iluminantes se pueden mover estando encendidos, consiguiendo así una gran flexibilidad y adaptabilidad de la configuración en cualquier momento.

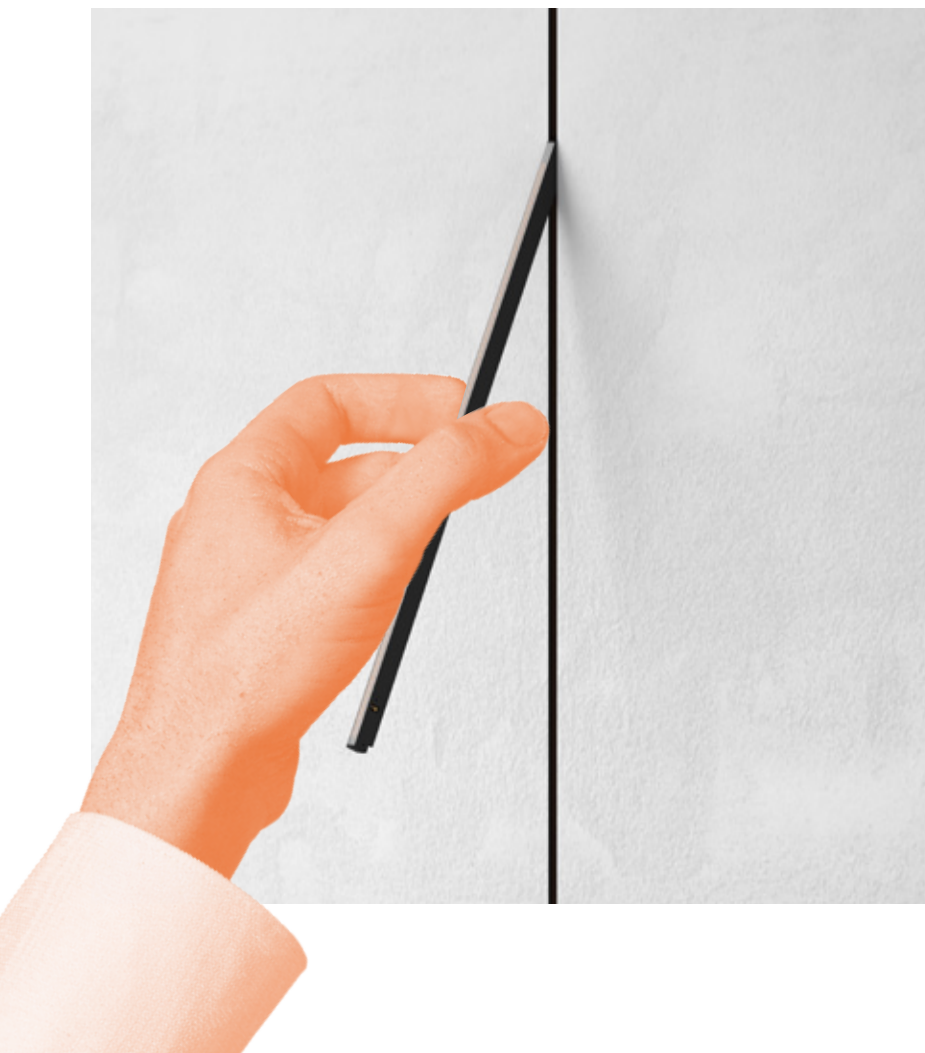







NANO SPOT

With a diameter of only 12 mm, this incredible projector guarantees high intensity values and allows you to easily resolve the most complex focal points while remaining invisible even from short distances.

Con un diámetro de solo 12 mm, este increíble proyector garantiza valores de alta intensidad y permite resolver fácilmente las focalizaciones más complejas mientras permanece invisible incluso desde distancias cortas.

SPOT MODULES

Complete range of micro-projectors available in various powers and sizes. They all include professional acrylic stabilized micro-lenses for a maximum control of lighting effects.

Gama completa de microproyectores disponibles en varias potencias y tamaños. Todos incluyen microlentes profesionales estabilizadas en acrílico para un control máximo de los efectos de iluminación.



LIGHT SHADOW SPOT

This ultra-compact projector uses the same optical unit as Light Shadow. Invisible source, integrated cut-off for unparalleled visual comfort and formal elegance.

Este proyector ultracompacto utiliza el mismo grupo óptico que el Light Shadow. Fuente invisible, cut-off integrado para un confort visual y una elegancia formal sin igual.

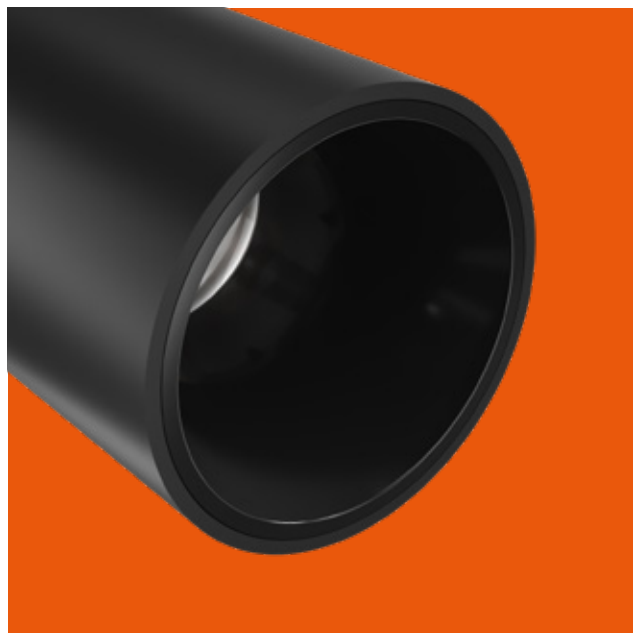

FIND ME

Interior lighting projector with LED light source, consisting of a cylindrical body that acts as a downlight when set in its upper position and becomes an adjustable projector when set in its lower position.

Proyector de iluminación interior con fuente de luz LED, consistente en un cuerpo cilíndrico que en posición superior hace función de downlight y en su posición inferior se convierte en un proyector orientable.



LIGHT STRIPE DIFFUSED / WALL-WASHER

Linear micro-profile with an integrated miniature wall-washer optic. The special patented lens emits an extremely uniform and enveloping vertical lighting. It is ideal for creating a soft, non-contrasting light background within an exhibition niche.

Microperfil lineal con óptica wall-washer integrada en miniatura. La lente especial patentada emite una iluminación vertical extremadamente uniforme y envolvente y es ideal para crear un fondo de luz suave y sin contraste dentro de un nicho de exposición.

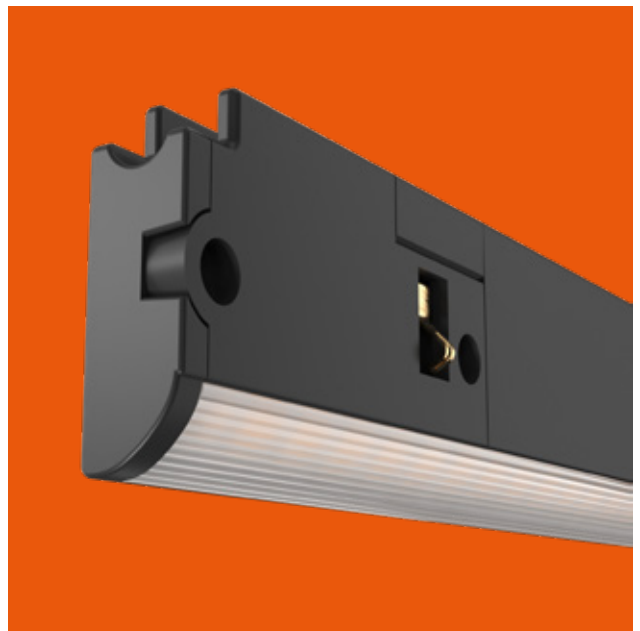

CONNECTIONS (RECESSED)

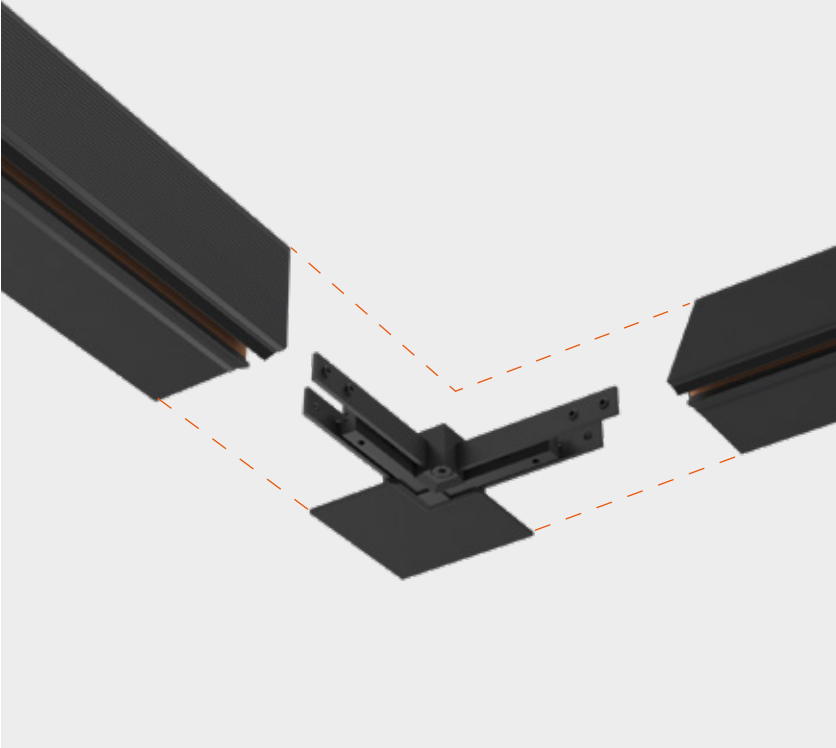

The recessed profile guarantees a flawless final result thanks to the special blocking sides that allow the installation to be finished with high-quality details.

El perfil empotrado garantiza un resultado final impecable gracias a las aletas de tope laterales especiales que permiten el acabado de la instalación con detalles de alta calidad.

CONNECTIONS (SURFACE)



Installed on the surface, the profile is so small that it disappears from the eye, becoming a very thin line that crosses the rooms and characterizes them with sophisticated lighting effects that invade walls, ceilings, corridors and showcases.

Instalado en superficie, el perfil es tan pequeño que desaparece de la vista, una línea muy delgada que cruza los ambientes y permite caracterizarlos con sofisticados efectos de luz que invaden paredes, techos, pasillos y vitrinas.



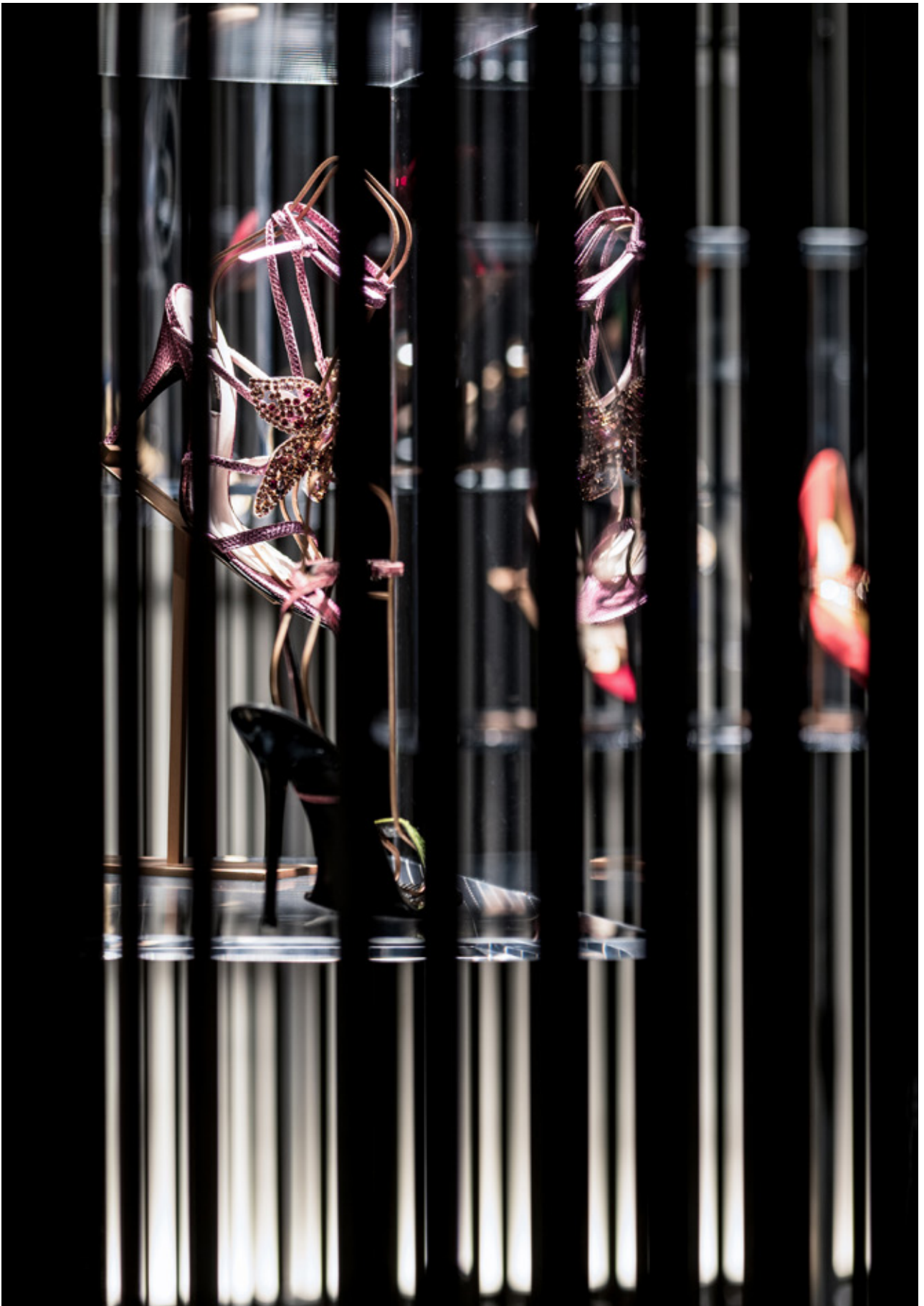

Sergio Rossi Showroom,
Milan



Sergio Rossi Showroom,
Milan

The Micro Running Magnet is the ultimate solution for exhibition lighting. A complete and professional program that, in addition to its reduced dimensions, provides a balanced and attractive light to highlight each object in the best way and in 360°.

The Micro Running Magnet es la solución definitiva para la iluminación de exposiciones. Un programa completo y profesional que además de dimensiones reducidas proporciona una luz equilibrada y atractiva para resaltar cada objeto de la mejor manera en 360°.

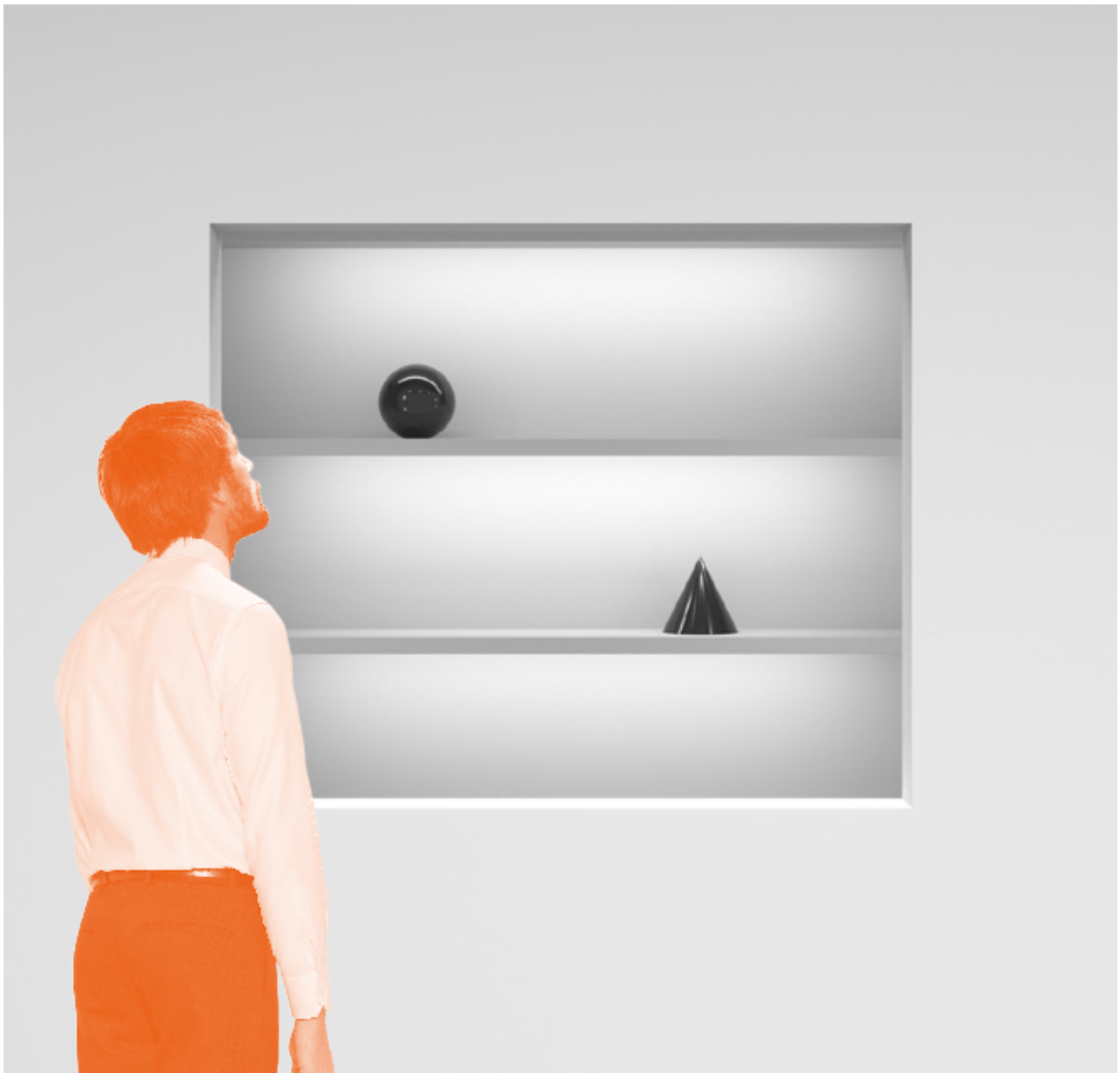

1 LED micro-projectors with integrated cut-off solutions and dedicated lenses to create contrasts and light accents.
Microproyectores LED con soluciones cut-off integradas y lentes específicas para crear contrastes y acentos de luz.

2 Complete linear micro-profile with opal diffuser screen for diffused light details.
Microperfil lineal completo con pantalla difusora opal para detalles de luz difusa.

3 Linear wall-washer micro-profile with patented lens for controlled asymmetric light effects.
Microperfil lineal wall-washer con lente patentada para efectos de luz asimétrica controlada.





New Kvadrat Soft Cells
Showroom, London

	Different control options that can be adapted to any need.	Diferentes opciones de control que pueden adaptarse a cualquier necesidad.
DALI	Broadcast control of each luminaire.	Control broadcast de cada luminaria.
1-10V	Broadcasting remote control (dimming of all the luminaires in a single group).	Control remoto en broadcasting (dimado de todas las luminarias en un grupo).
CASAMBI	Individual & Broadcast control through a tablet or smartphone application (FLOS Control®).	Control individual y broadcast a través de una aplicación para tablet o smartphone (FLOS Control®).

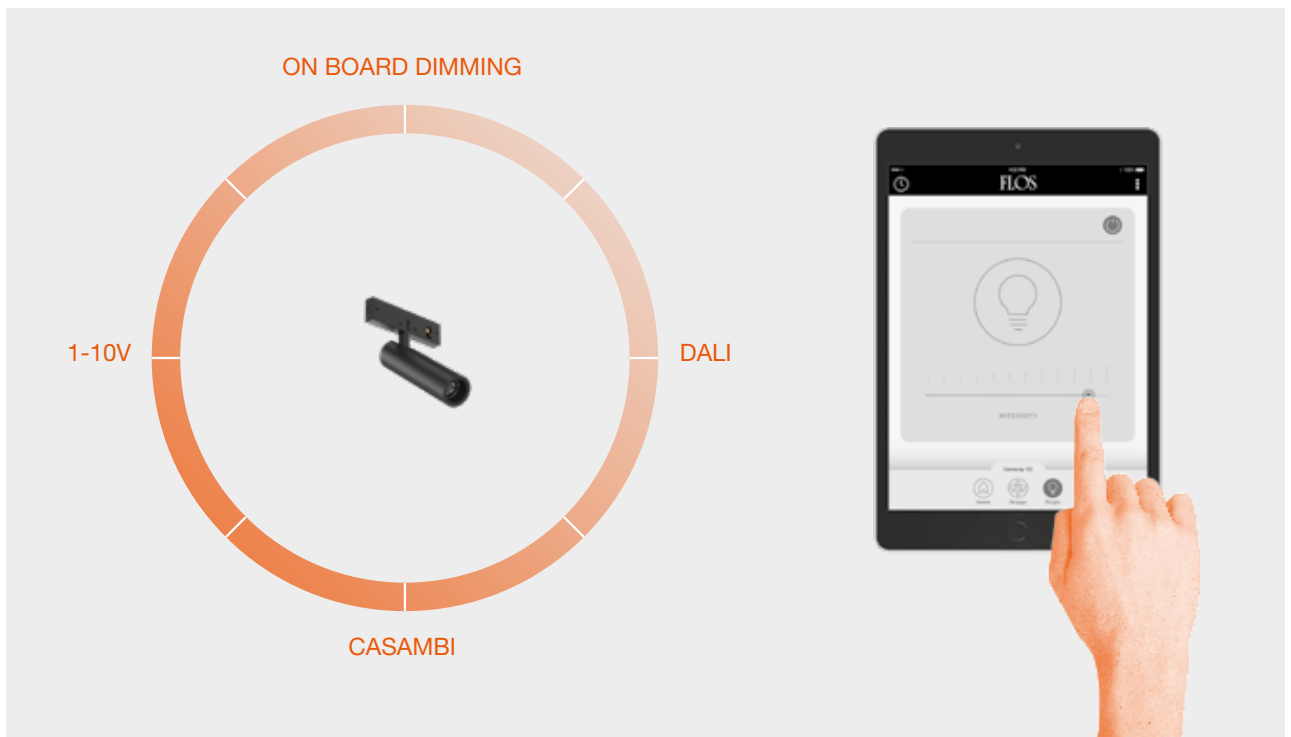

FLOS CONTROL®
BY CASAMBI

The FLOS Control® application allows you to control the system's luminaires controlling scenes and programming.

With a traditional electrical installation and the Gateway connected by Bluetooth, you obtain total control of the ambience.

Available for iOS and Android

La aplicación FLOS Control®, permite controlar las luminarias del sistema controlando escenas y programación.

Con tan sólo una instalación eléctrica tradicional y el Gateway conectado por Bluetooth se obtiene un control total del ambiente.

Disponible en iOS y Android

FLOS
CONTROL BY CASAMBI





LIGHT MODULES

NANO SPOT

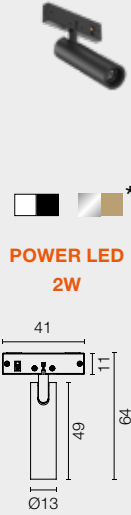

MICRO SPOT

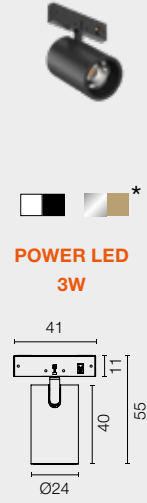

SPOT



LIGHT SHADOW SPOT

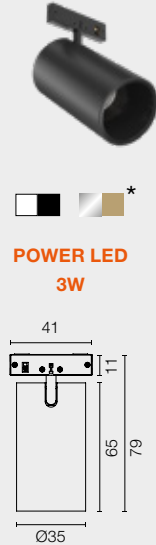

FIND ME 0

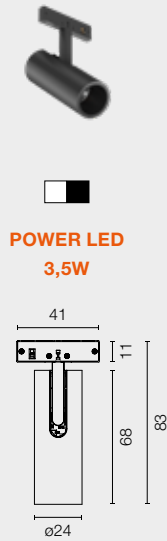

FIND ME 1

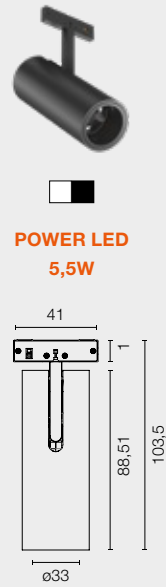

LIGHT STRIPE
DIFFUSED

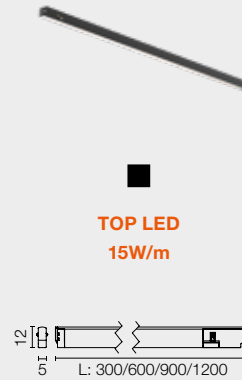

LIGHT STRIPE
WALL-WASHER

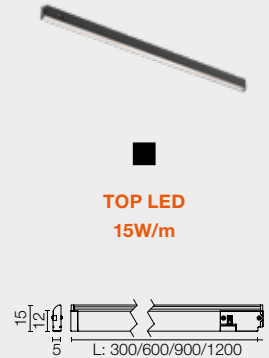

Spot



Medium



Flood



Wall-Washer



Diffused

RECESSED



■ 14 Black
■ 14 Negro

SURFACE



□ 40 White
□ 40 Blanco
■ 14 Black
■ 14 Negro

THE RUNNING

MAGNET

THE RUNNING

MAGNET

THE RUNNING

MAGNET

THE RUNNING

MAGNET





The range consists of special 24V-powered magnetic profiles on which the LED lighting modules are placed. The profiles are suitable for surface, suspended or recessed installations in walls or plasterboard ceilings. The Running Magnet is completed by ambient and accent lighting modules with different optics, plus a selection of decorative lighting accessories originating and adapted from the FLOS Home Collection.

La gama está compuesta por perfiles magnéticos especiales alimentados a 24V en los que se colocan los módulos de iluminación LED. Los perfiles son aptos para instalación en superficie, suspendida o empotrada en paredes o techos de pladur. El Running Magnet se completa con módulos de iluminación ambiental y de acento con diferentes ópticas, además de una selección de accesorios de iluminación decorativos extraídos y adaptados de la FLOS Home Collection.

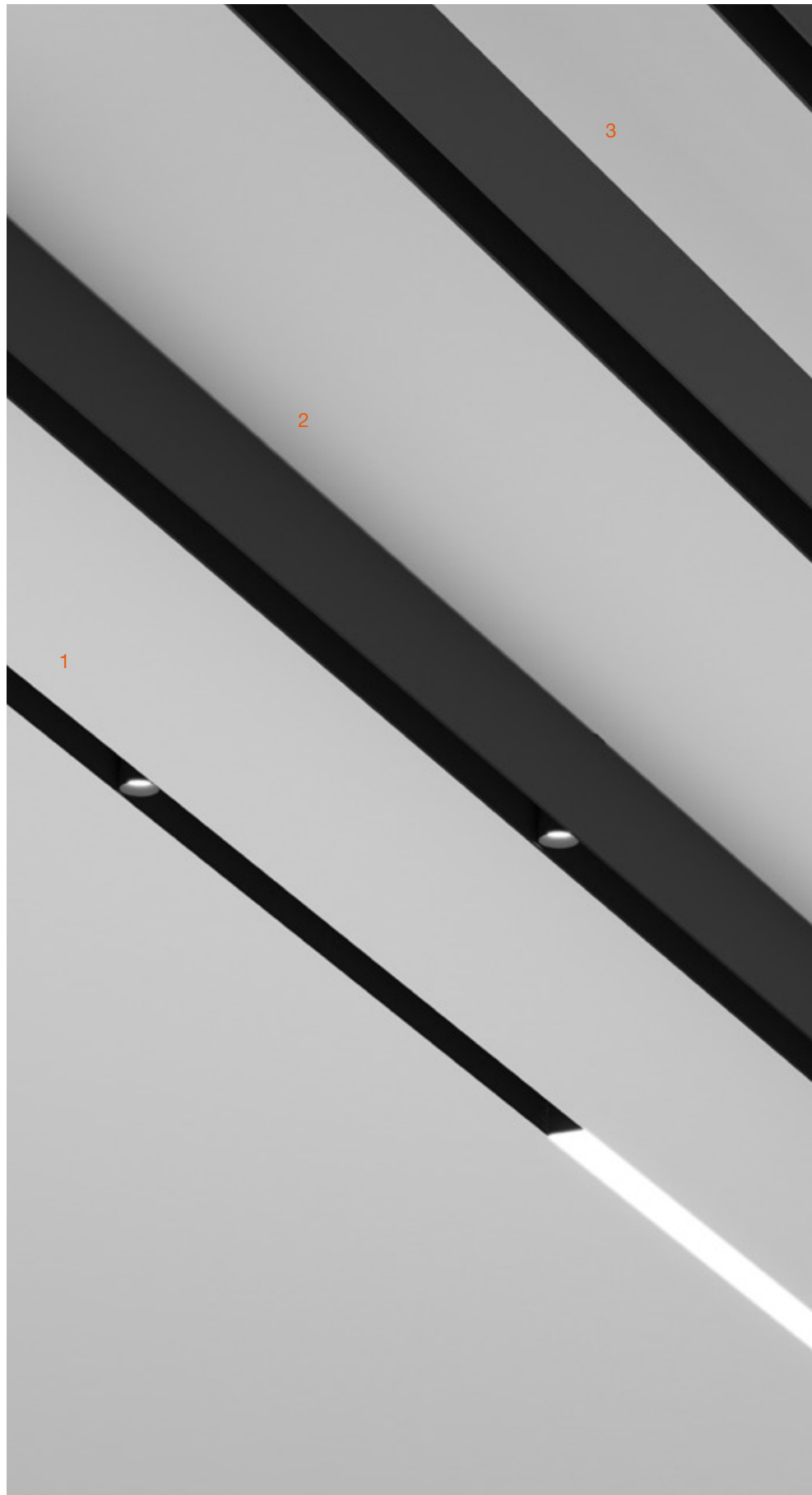

- 1 RECESSED
- 2 SURFACE
- 3 SUSPENSION DOWN
- 4 SUSPENSION UP&DOWN

4

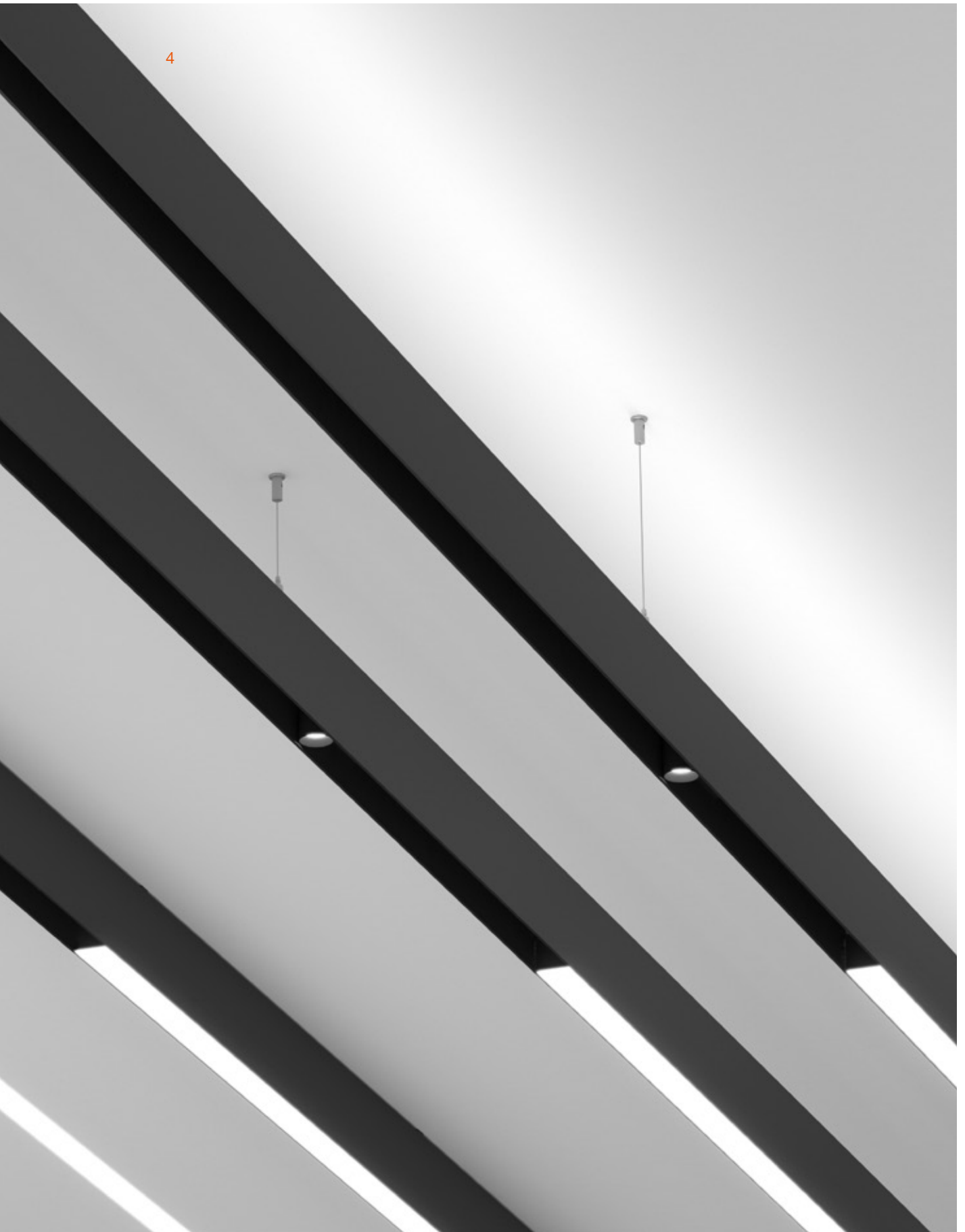





The solution for a total fusion with architecture, achieved thanks to the total integration of luminaries that can disappear inside surfaces. Its magnetic installation offers super easy way to design the light in space. Compatible with all main control systems and FLOS Control®.

La solución para una fusión total con la arquitectura, lograda gracias a la integración total de las luminarias que pueden desaparecer en el interior de las superficies. Su instalación magnética permite diseñar la luz en el espacio con la mayor facilidad. Compatible con los principales sistemas de control y con FLOS Control®.

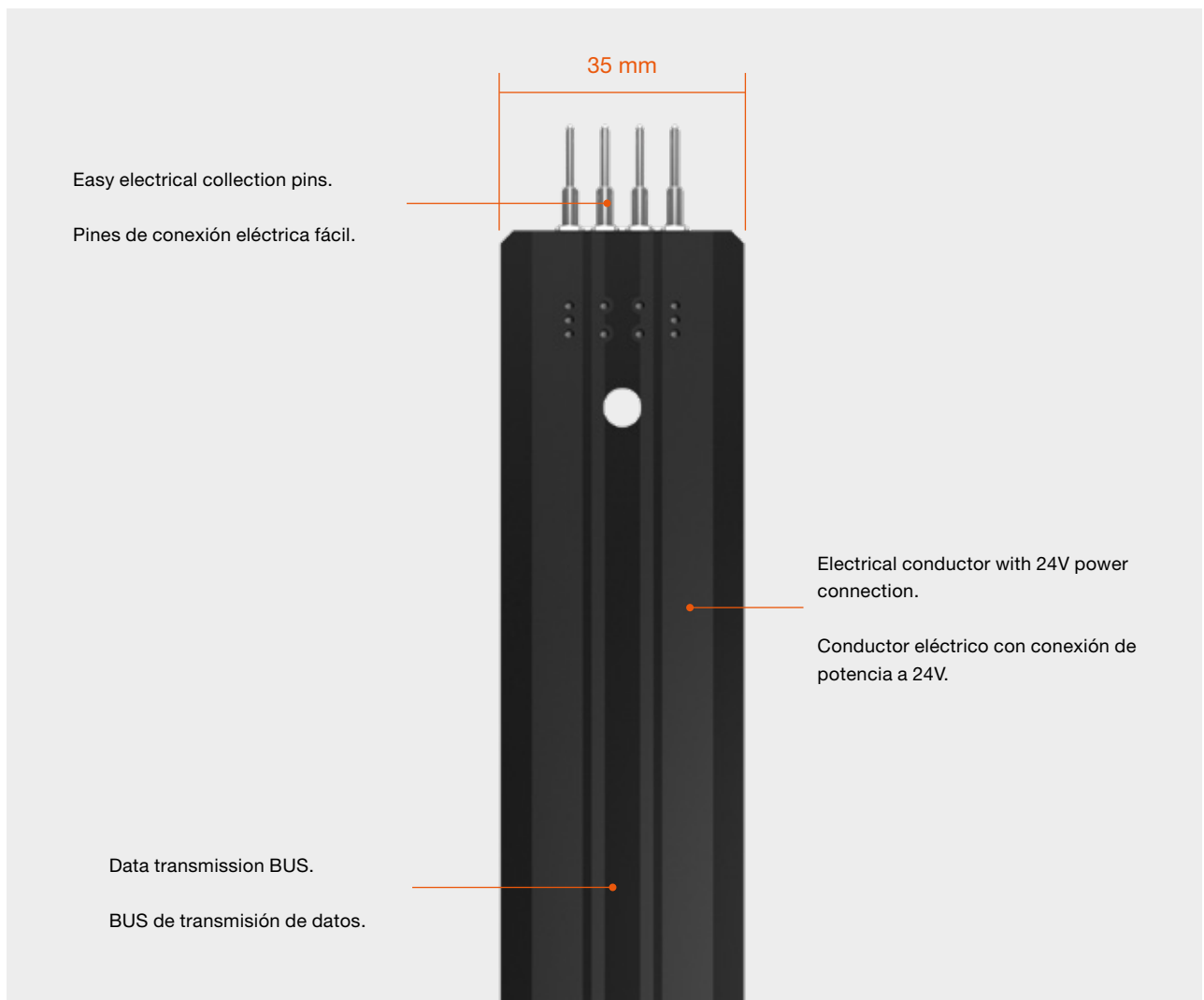





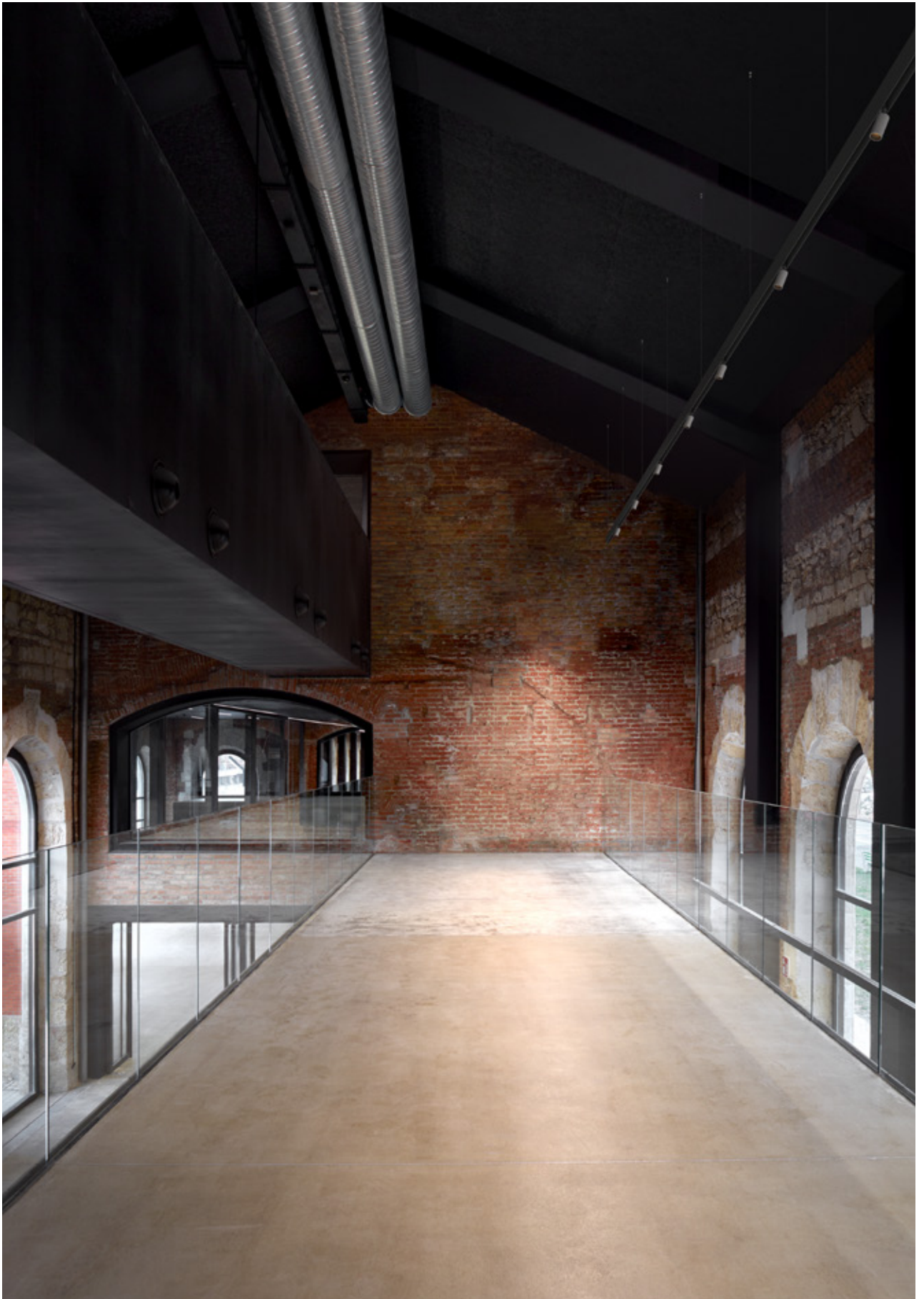



Magnetic fixing of the luminaires, which allows hot handling. They can be moved while they are still on, achieving enormous flexibility and adaptability in the configuration at any time.

Fijación magnética de las luminarias que permiten manipulado en caliente. Se pueden trasladar mientras siguen encendidas consiguiendo una enorme flexibilidad y adaptabilidad de la configuración en cualquier momento.





Cassina + Siematic
Showroom, Japan

SPOT MODULE

Spot module with far back positioned lens for optimal visual comfort.

Módulo spot con lente posicionada más atrás para un confort visual óptimo.

1 Exterior shield cylinder.
Cilindro exterior apantallador.

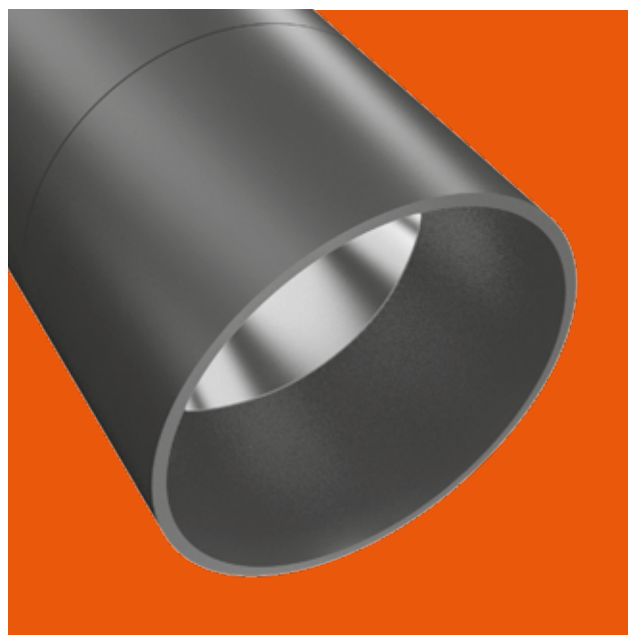

1

LIGHT SHADOW SPOT 30 / 45

Thanks to the unique patented optical solution, Light Shadow Spot controls extreme cut-off angles without altering the high efficiency and incredible versatility of the product.

Gracias a la exclusiva solución óptica patentada, Light Shadow Spot controla ángulos de cut-off extremos, sin sacrificar la alta eficiencia y la increíble versatilidad del producto.

2 Dual-focus lens developed by FLOS specifically for this product. It ensures maximum optical control and exceptional light beam homogeneity.

Lente de doble foco desarrollada por FLOS específicamente para este producto. Garantiza el máximo control óptico y una homogeneidad excepcional del haz de luz.

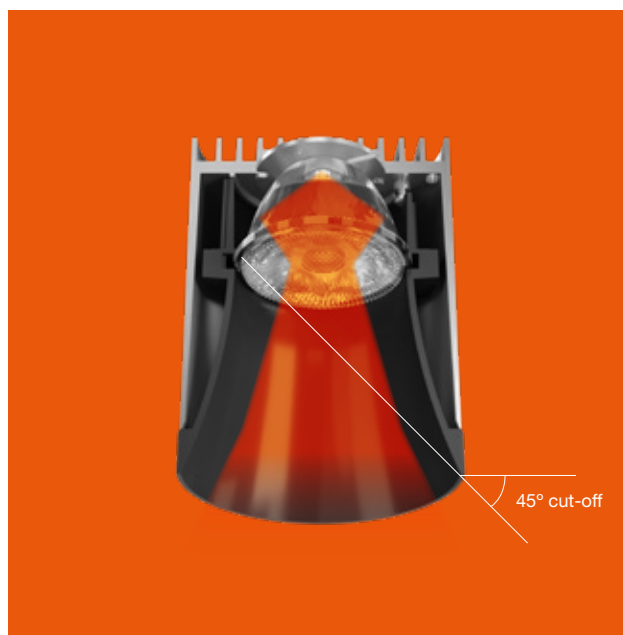

2

SPOT 120

Power projector with minimal design.
Maximum visual comfort.

Proyector de potencia con diseño minimal.
Máximo confort visual.

3 Shielding accessories available in all projectors, to
always offer maximum visual comfort.
Accesorios de apantallamiento disponibles en todos
los proyectores, para ofrecer siempre el máximo
confort visual.

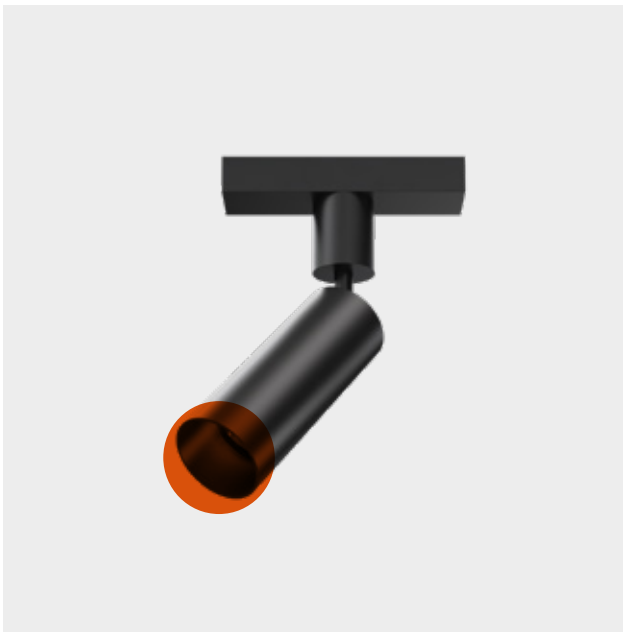

ANTHONY SPOT

Anthony Spot designed by Antonio Citterio: a form with
a touch of avant-garde design, simple yet elegant, which
is distanced from traditional looks.

Anthony Spot diseñado por Antonio Citterio: una forma
con toque de diseño vanguardista, simple y al mismo
tiempo elegante que se distancia de los cánones
tradicionales.

4 Novel heat dissipater design.
Novedoso diseño de disipador de calor.

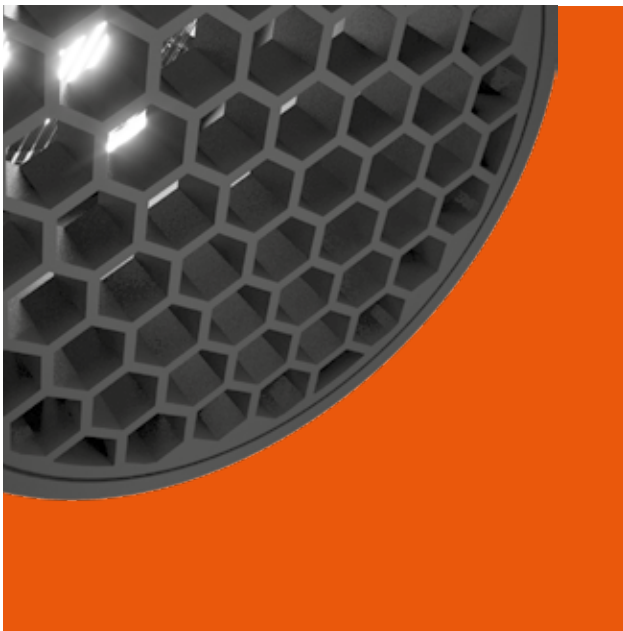





Parc 51, Belgium
Bottom

1410 Broadway,
New York
Top

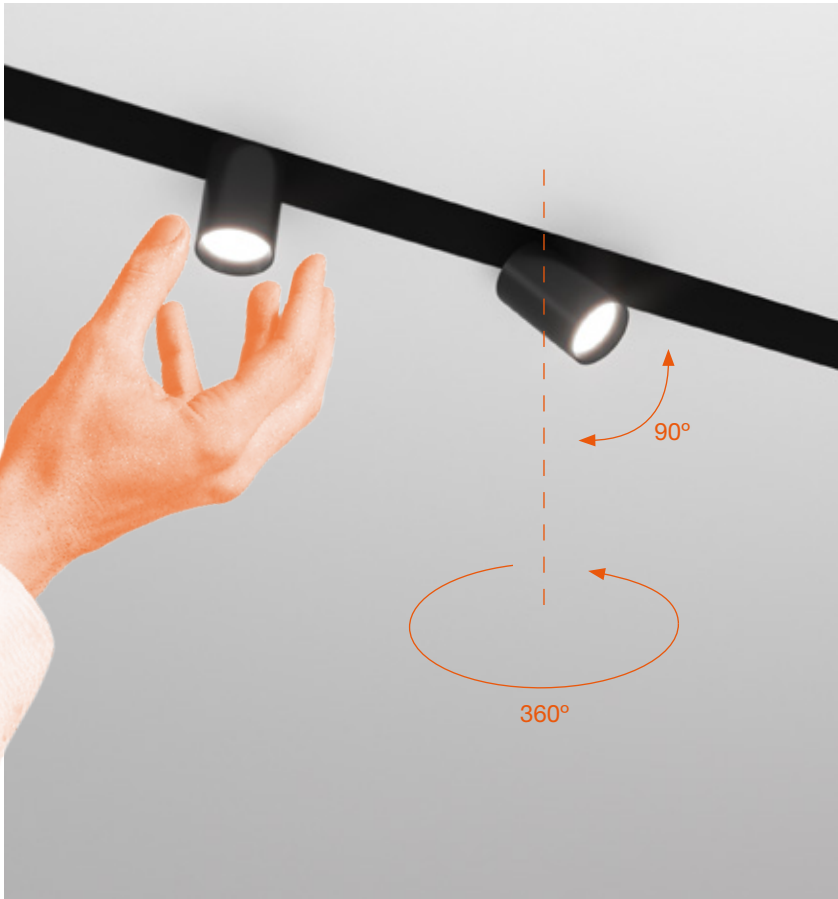

SPOT MODULE

Projector created for maximum flexibility and integration, as it can be fitted flat to the profile. Zenithally light or its extraction and orientation to 360 degrees and tilting to 90 degrees.

Proyector creado para la máxima flexibilidad e integración ya que permite su colocación enrasada al perfil. Luz cenital o su extracción y orientación a 360 grados y basculación 90 grados.



FIND ME SUSPENSION

Extremely compact and subtle suspension module, ideal for high-contrast lighting effects.

Módulo de suspensión extremadamente compacto y simple, ideal para efectos de iluminación de alto punto de contraste.







Magnetic light bar available in different lengths, which offers the possibility of joining and eliminating the gap effect, even in corners. The specially developed opal diffuser guarantees both efficiency and homogeneity in architectural integration.

Disponible barra de luz magnética en diferentes longitudes que ofrece la posibilidad de juntarlas y eliminar el efecto de GAP (elimina el efecto de interrupción de la luz en la unión) incluso en esquinas. El difusor opal especialmente desarrollado, garantiza tanto eficiencia como homogeneidad en la integración arquitectónica.



LIGHT STRIPE

303 mm



603 mm

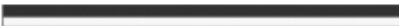

903 mm



1203 mm







	Different control options that can be adapted to any need.	Diferentes opciones de control que pueden adaptarse a cualquier necesidad.
ON BOARD DIMMING	Each luminaire has its own integrated dimmer for direct and individual control.	Cada luminaria lleva su dimmer integrado, para control directo e individual.
DALI	Individual control of each luminaire.	Control individual de cada luminaria.
1-10V	Broadcasting remote control (dimming of all the luminaires in a single group).	Control remoto en broadcasting (dimado de todas las luminarias en grupo).
CASAMBI	Individual control of each luminaire directly through a tablet or smart-phone application (FLOS Control®).	Control individual de cada luminaria a través de una aplicación para tablet o smartphone (FLOS Control®).



FLOS CONTROL®
BY CASAMBI

The FLOS Control® application allows you to control the system's luminaires individually or as a group, controlling scenes and programming.

With a traditional electrical installation and the Gateway connected by Bluetooth, you obtain total control of the ambience.

Available for iOS and Android

La aplicación FLOS Control®, permite controlar las luminarias del sistema de modo individual o en grupo, controlando escenas y programación.

Con tan sólo una instalación eléctrica tradicional y el Gateway conectado por Bluetooth se obtiene un control total del ambiente.

Disponible en iOS y Android

LIGHT MODULES

LIGHT STRIPE



TOP LED
25W/m



SPOT MODULE



POWER LED
8W

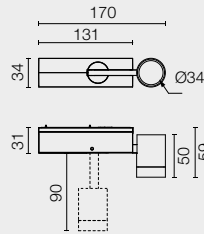

SPOT 120



POWER LED
12,5W/14W DALI

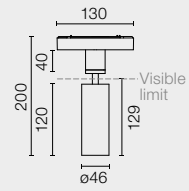

LIGHT SHADOW SPOT 30



POWER LED
4W

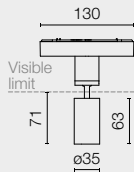

LIGHT SHADOW SPOT 45



LED ARRAY
10W

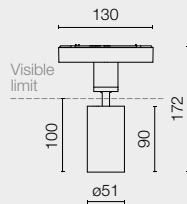

ANTHONY SPOT TRACK



POWER LED
14W

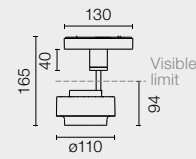

LIGHT MODULES

WORKMATES SMALL



TOP LED
Up to 10,5W

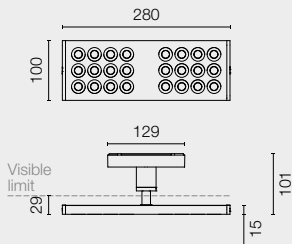

WORKMATES LARGE



TOP LED
Up to 13,5W

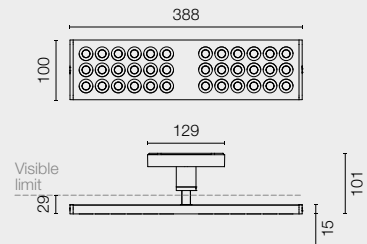

MULTI SPOT 4



POWER LED
10W



LIGHT SHADOW



POWER LED
10,8W

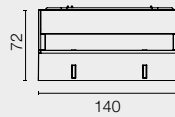

LIGHT SHADOW
WALL-WASHER



POWER LED
10,8W

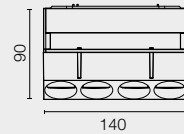

LIGHT MODULES

STRING LIGHT



POWER LED
14W

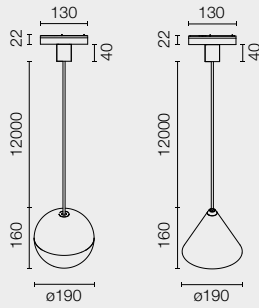

MINI GLO-BALL



POWER LED
3,5/7W

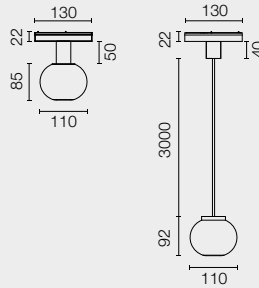

FIND ME
SUSPENSION



POWER LED
8W

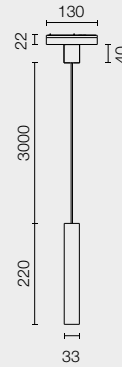

Spot



Medium



Flood



Wide Flood



Oval



Wall-Washer



Diffused

PROFILES

RECESSED



■ 14 Black
■ 14 Negro

SURFACE



□ 40 White
□ 40 Blanco

SUSPENSION
UP&DOWN / DOWN



■ 14 Black
■ 14 Negro

MULTIFUNCTION
SMART DEVICE



FLOS CONTROL®
by Casambi

THE TRACKING

MAGNET

WAGNIEL

MAGNET

WAGNIEL

MAGNET

WAGNIEL

Compact profile, compatible with magnetic fastening light fixtures. The program has recessed, surface and suspended versions. Regulation and control with universal protocols and using the FLOS Control® application.

Perfil compacto y compatible con luminarias de fijación magnética. El programa cuenta con versiones empotrada, de superficie y suspendida. Regulación y control mediante protocolos universales y a través de la aplicación FLOS Control®.

THE TRACKING MAGNET

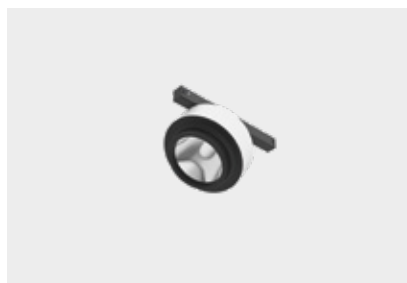
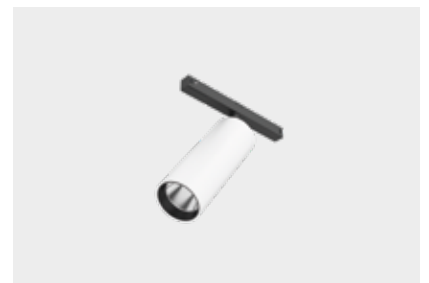





The system consists of magnetic profiles powered at 48V where the LED lighting modules are placed. The profiles are suitable for surface, suspended or recessed installations in walls or plasterboard ceilings. The Tracking Magnet is completed by ambient and accent lighting modules with different optics, as well as by a special module for spot lighting on walls.

El sistema está compuesto por perfiles magnéticos alimentados a 48V en los que se colocan los módulos de iluminación LED. Los perfiles son adecuados para instalación en superficie, suspendida o empotrada en paredes o techos de pladur. The Tracking Magnet se completa con módulos de iluminación ambiental y de acento con diferentes ópticas, además de un módulo especial para iluminación puntual en pared.



- 1 RECESSED
- 2 SURFACE
- 3 SUSPENSION DOWN
- 4 SUSPENSION UP&DOWN

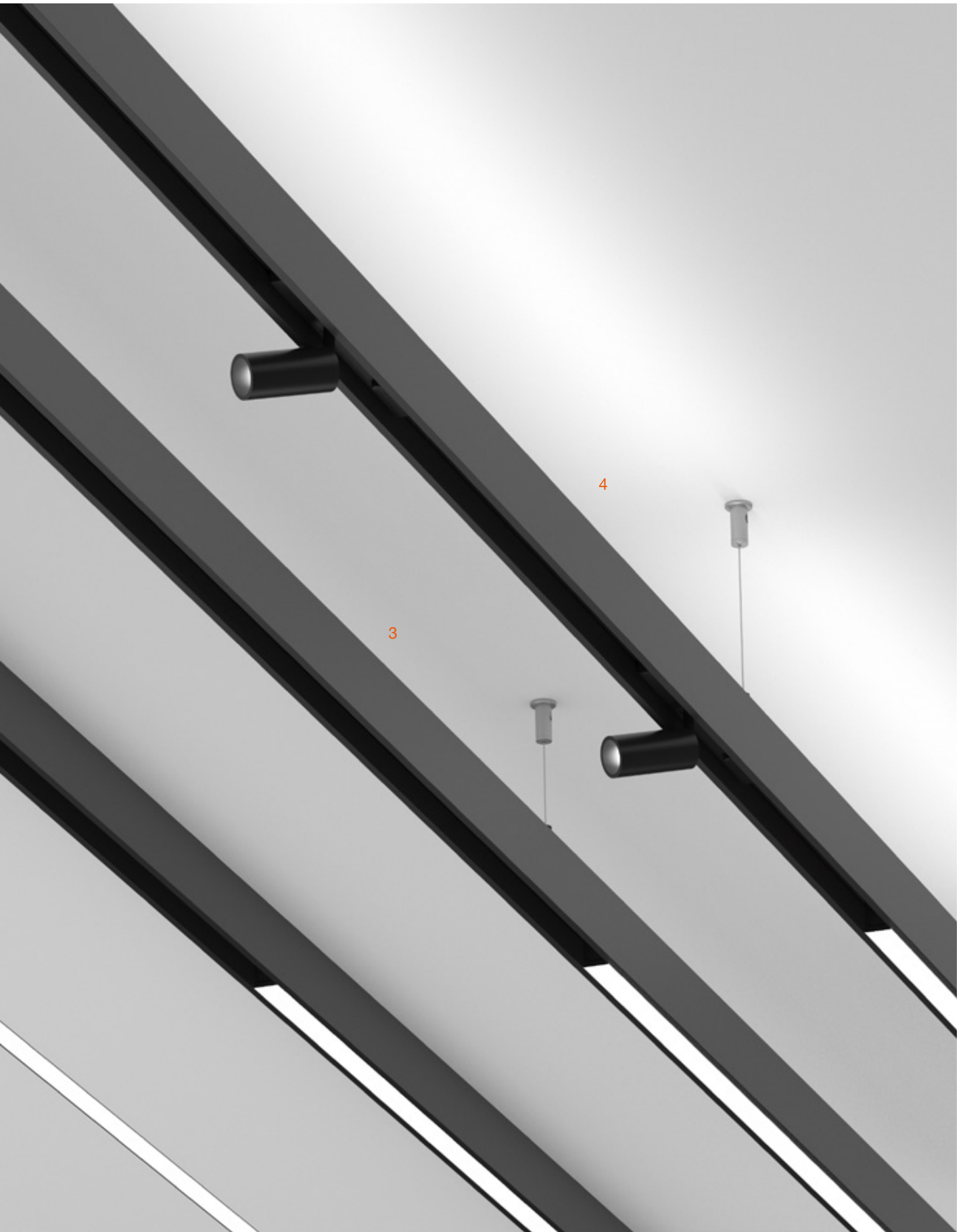









A minimal line only 15 mm wide, achieved through the extreme miniaturization of the electronics and the optical bodies. The Tracking Magnet offers a complete collection of lighting tools for any need, compatible with all main control systems and FLOS Control®. Its magnetic installation gives total freedom to be configured in space.

Una línea mínima de solo 15 mm de ancho, lograda gracias a la extrema miniaturización de los cuerpos electrónicos y ópticos. Tracking Magnet ofrece una completa colección de soluciones de iluminación para satisfacer todas las necesidades. Compatible con los principales sistemas de control y con FLOS Control®. Su instalación magnética permite configurarla en el espacio con una total libertad.











Magnetic fixing of the luminaires, which allows hot handling. They can be moved while the track is connected, achieving enormous flexibility and adaptability in the configuration at any time.

Fijación magnética de las luminarias que permiten manipulado en caliente. Se pueden trasladar mientras siguen encendidas consiguiendo una enorme flexibilidad y adaptabilidad de la configuración en cualquier momento.





Bulb Millenium Offices,
Czech Republic

Magnetic light bar available in different lengths, which offers the possibility of joining and eliminating the gap effect, even in corners. The specially developed opal diffuser guarantees both efficiency and homogeneity in architectural integration.

Disponible barra de luz magnética en diferentes longitudes que ofrece la posibilidad de juntarlas y eliminar el efecto de GAP (elimina el efecto de interrupción de la luz en la unión) incluso en esquinas. El difusor opal especialmente desarrollado, garantiza tanto eficiencia como homogeneidad en la integración arquitectónica.



303 mm

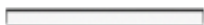

603 mm



903 mm



1203 mm



1503 mm





Carbonado Energy, South
Africa

LIGHT SHADOW SPOT 30 / 45 / 60

Thanks to the unique patented optical solution, Light Shadow Spot controls extreme cut-off angles without altering the high efficiency and incredible versatility of the product.

Gracias a la exclusiva solución óptica patentada, Light Shadow Spot controla ángulos de cut-off extremos, sin sacrificar la alta eficiencia y la increíble versatilidad del producto.

1 Dual-focus lens developed by FLOS specifically for this product. It ensures maximum optical control and exceptional light beam homogeneity.

Lente de doble foco desarrollada por FLOS específicamente para este producto. Garantiza el máximo control óptico y una homogeneidad excepcional del haz de luz.

SPOT TRACKING 50 / 90 / 120 / 150

Family of spots with different powers and optics for any need.

Familia de spots de diferentes potencias y ópticas para cualquier necesidad.

2 Spot versions 120 and 150 with reflector optics available, to offer wider and more powerful light beams.

Disponibles versiones de spot 120 y 150 con óptica de reflectores, para ofrecer haces de luz más abiertos y más potencia.

LIGHT SHADOW SPOT 30

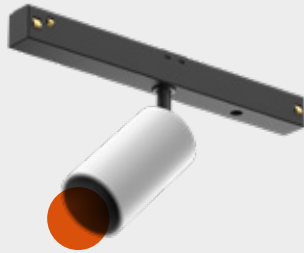

SPOT 150

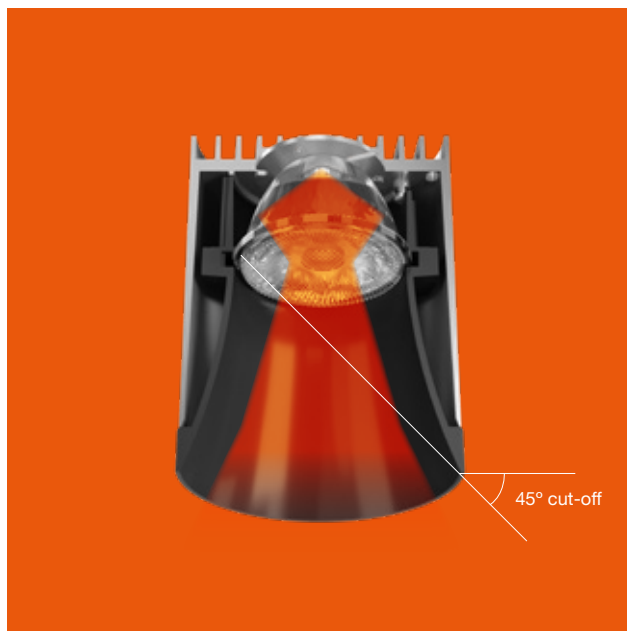

1



2

WALLEE

Luminaire designed especially by Niels Bendtsen for lighting frames and walls, thanks to its homogenous and elegant distribution of high-quality light.

Luminaria diseñada especialmente por Niels Bendtsen para iluminación de cuadros y paredes, gracias a su distribución homogénea y elegante de luz de alta calidad.

3 Head adjustable to 50 degrees for the perfect light setting.
Cabezal orientable 50 grados para el perfecto ajuste lumínico.

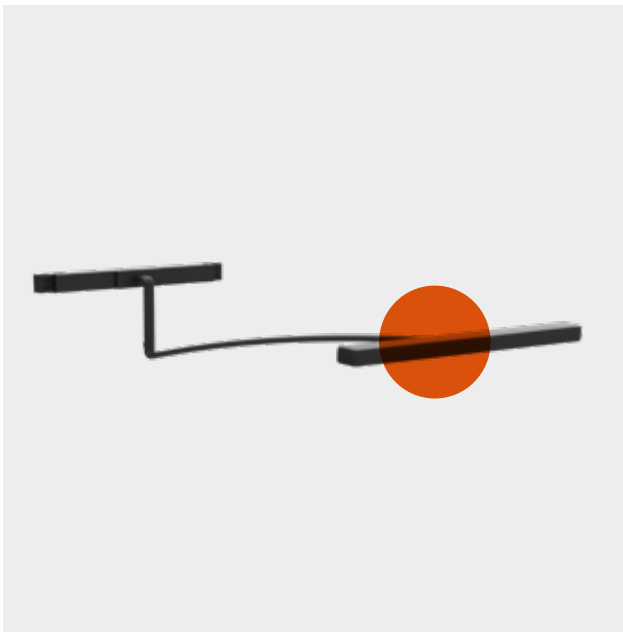

ANTHONY SPOT

Anthony Spot designed by Antonio Citterio: a form with a touch of avant-garde design, simple yet elegant, which is distanced from the traditional looks.

Anthony Spot diseñado por Antonio Citterio: una forma con toque de diseño, simple y al mismo tiempo elegante que se distancia de los cánones tradicionales.

4 Novel heat dissipater design.
Novedoso diseño de disipador de calor.

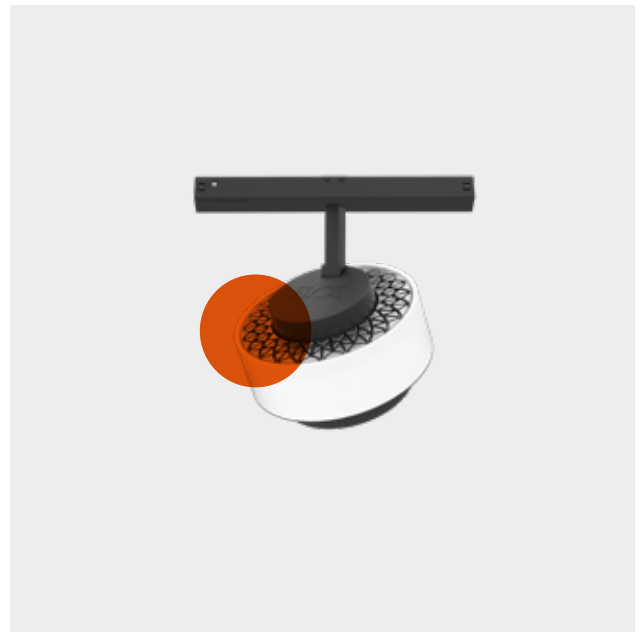

MULTI SPOT MINI

The Multi Spot Mini is a 14-spot LED lighting module with low glare, combining a compact design with powerful lighting capability. This module provides an elegant and efficient solution, with beam control ensuring that brightness is focused directly outward, avoiding unnecessary reflections.

El Multi Spot Mini es un módulo de iluminación LED de 14 focos y bajo deslumbramiento que combina un diseño compacto con una potente capacidad de iluminación. Este módulo ofrece una solución elegante y eficiente, con un control del haz de luz que asegura que la luminosidad se enfoque directamente en el exterior, sin reflejos innecesarios.

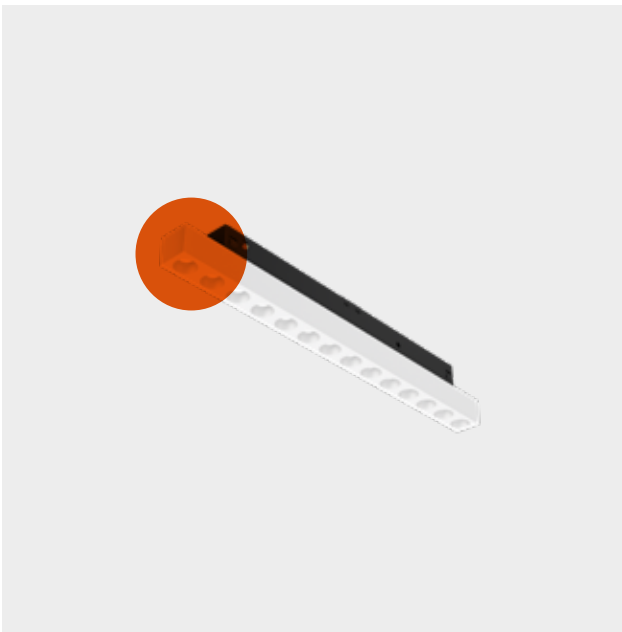









Sergio Rossi, London

	Different control options that can be adapted to any need.	Diferentes opciones de control que pueden adaptarse a cualquier necesidad.
ON BOARD DIMMING	Each luminaire has its own integrated dimmer for direct and individual control.	Cada luminaria lleva su dimmer integrado, para control directo e individual.
DALI	Individual control of each luminaire.	Control individual de cada luminaria.
1-10V	Broadcasting remote control (dimming of all the luminaires in a single group).	Control remoto en broadcasting (dimado de todas las luminarias en grupo).
CASAMBI	Individual control of each luminaire directly through a tablet or smart-phone application (FLOS Control®).	Control individual de cada luminaria a través de una aplicación para tablet o smartphone (FLOS Control®).



FLOS CONTROL®
BY CASAMBI

The FLOS Control® application allows you to control the system's luminaires individually or as a group, controlling scenes and programming.

With a traditional electrical installation and the Gateway connected by Bluetooth, you obtain total control of the ambience.

Available for iOS and Android

La aplicación FLOS Control®, permite controlar las luminarias del sistema de modo individual o en grupo, controlando escenas y programación.

Con tan sólo una instalación eléctrica tradicional y el Gateway conectado por Bluetooth se obtiene un control total del ambiente.

Disponible en iOS y Android

LIGHT MODULES

LIGHT STRIPE



TOP LED
20W/M

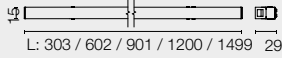

SPOT 50



POWER LED
3,5W

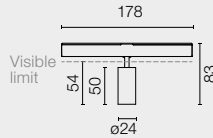

SPOT 90



POWER LED
8,5W

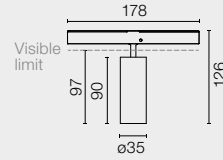

SPOT 120



POWER LED
12W

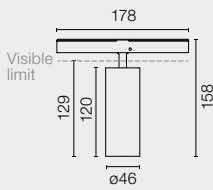

SPOT 120



LED ARRAY
12,5W

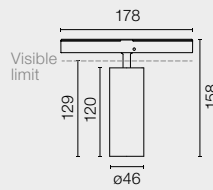

SPOT 150



LED ARRAY
22,5W

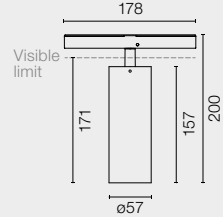

LIGHT SHADOW SPOT 30



POWER LED
4,5W

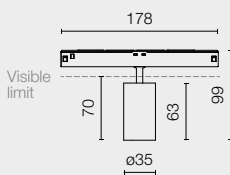

LIGHT SHADOW SPOT 45



LED ARRAY
10W

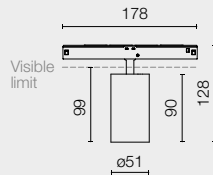

LIGHT SHADOW SPOT 60



LED ARRAY
Up to 20W

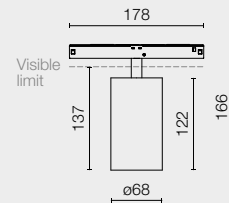

Super Spot



Spot



Medium



Flood



Wide Flood

LIGHT MODULES

MULTI SPOT MINI

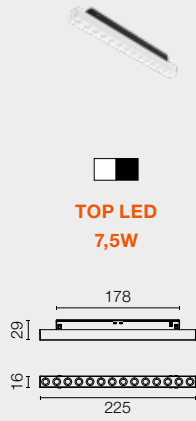

WALLEE

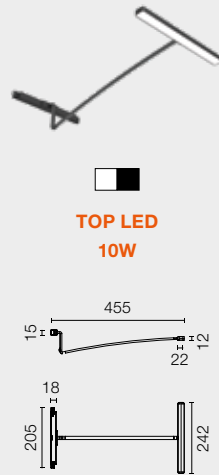

ANTHONY SPOT TRACK



RECESSED



- 14 Black
- 14 Negro

SURFACE



- 40 White
- 40 Blanco
- 05 Polished Aluminium
- 05 Aluminio Pulido

SUSPENSION
UP&DOWN / DOWN



- 14 Black
- 14 Negro

MULTIFUNCTION
SMART DEVICE



FLOS CONTROL®
by Casambi

EVO

POWER

**THE TRACKING
THE TRACKING
THE TRACKING
THE TRACKING
THE TRACKING
THE TRACKING
THE TRACKING
THE TRACKING
THE TRACKING
THE TRACKING
THE TRACKING
THE TRACKING
THE TRACKING
THE TRACKING
THE TRACKING**

POWER

3-phase rail with reduced dimensions in its recessed version. Compatible with a compact and powerful light fixture program.

Carril trifásico de reducidas dimensiones en su versión empotrada. Compatible con un programa de luminarias compactas y potentes.

THE TRACKING POWER EVO

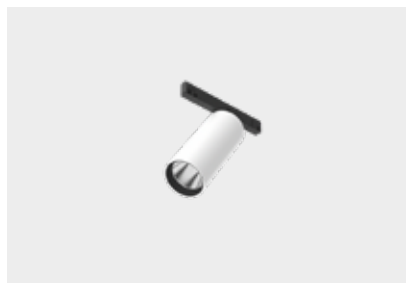
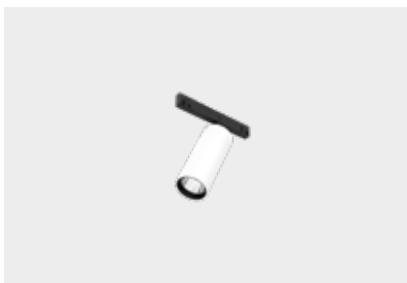



Issey Miyake Store,
Germany



The Tracking Power is equipped with electric tracks on which the luminaries are installed through an exclusive Flos fixing system.

The Tracking Power está equipado con pistas eléctricas en las que las luminarias se instalan a través de un exclusivo sistema de fijación Flos.





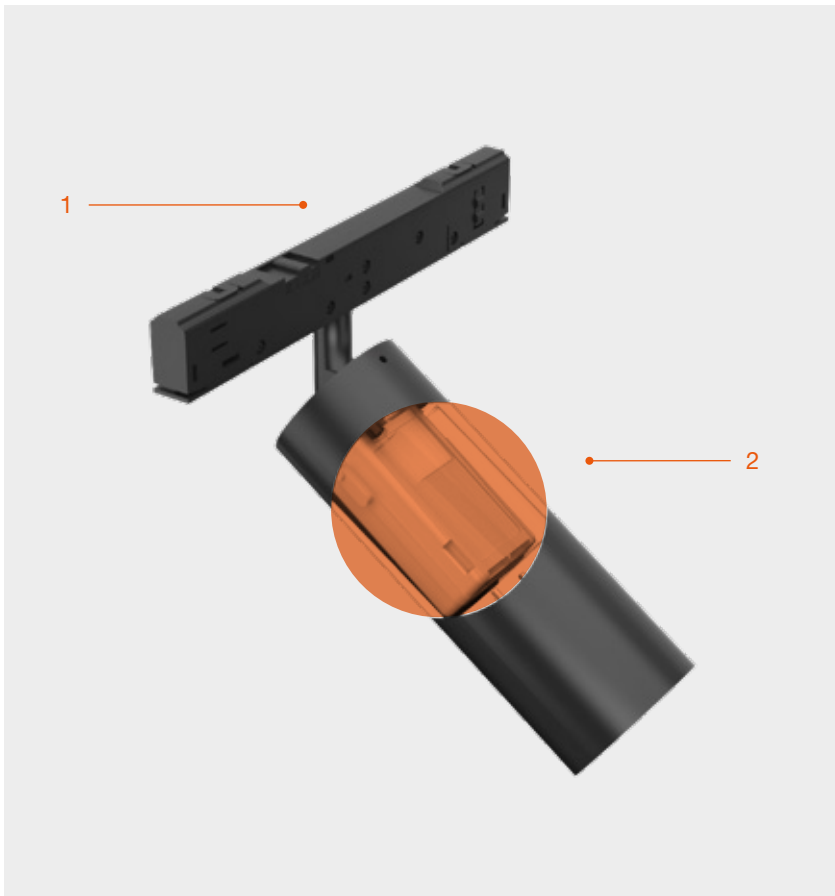

The three-phase rail according to Flos. Thanks to its miniaturized anchorage system it is capable to host in a small space a complete range of high power lighting tools for professional applications.

El carril trifásico acorde a Flos. Gracias a su sistema de anclaje miniaturizado puede albergar en un espacio reducido una completa gama de soluciones de iluminación de alta potencia para usos profesionales.

UT SPOT MODULES

1 Revolutionary track design that allows a total integration.
Revolucionario diseño de track que permite una integración total.

2 Control electronics totally integrated into the projector head.
Electrónica de control totalmente integrada en la cabeza del proyector.

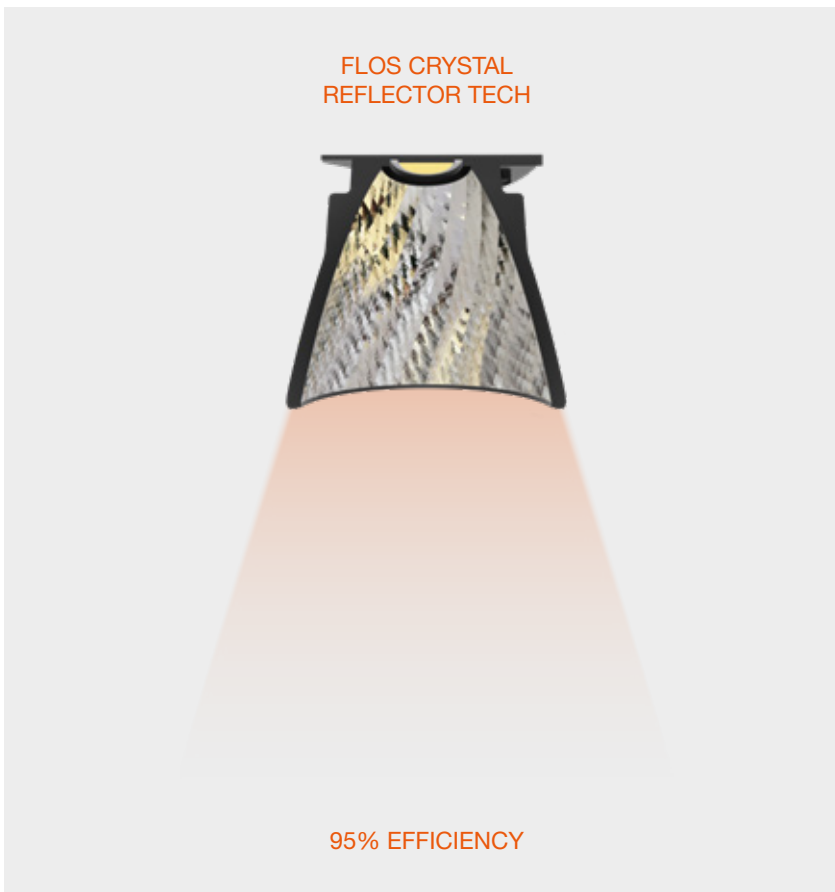

Revolutionary reflector in borosilicate glass that offers light efficiency of up to 95%. Thanks to its faceting, it guarantees total control of the light beam.

Revolucionario reflector en cristal de borosilicato que ofrece una eficiencia lumínica de hasta el 95%. Gracias a su facetado garantiza un control total del haz de luz.







SPOT 150 / SPOT 175

Projectors with minimal design which can be integrated into all aesthetics and with different angle and power options.

Proyectores de diseño minimal que se integran en todas las estéticas y con diferente opciones de ángulos y potencias.

1 On-board Dimming for individual intensity control for each luminaire.

Potenciómetro incorporado para control de intensidad individual de cada luminaria.

2 Shielding accessories available for all projectors.

Accesorios de apantallamiento para todos los proyectores.



WALL-WASHER

New wall-washer which, thanks to its reflector designed by FLOS, offers an extra compact size together with impeccable levels of light homogeneity.

Nuevo bañador de pared que gracias a su reflector diseñado por FLOS ofrece un tamaño extra compacto junto a unos niveles de homogeneidad lumínica impecables.

3 Back projection light source for maximum visual comfort and homogeneity.

Fuente de luz por retroproyección para el máximo confort visual y homogeneidad.

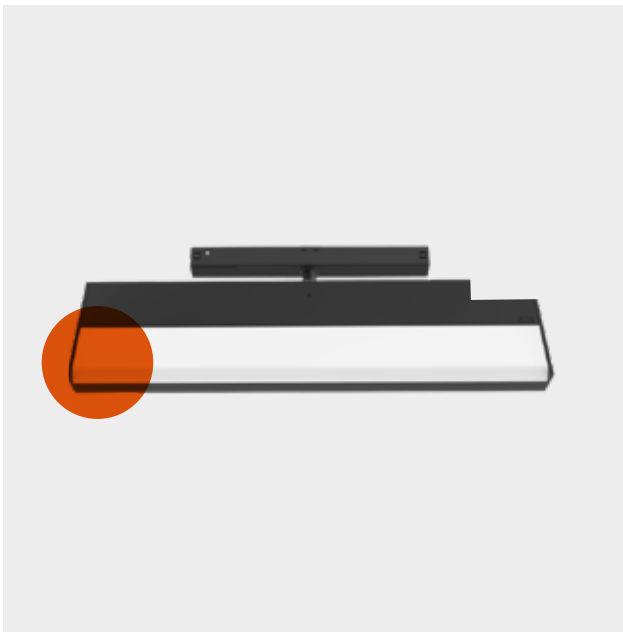

WORKMATES SMALL / LARGE

Workmates is fitted with *High Efficiency* and *Full Spectrum* LED light sources. With the former, you get excellent performance in terms of lm/W, while with the *Full Spectrum* option, you get the perfect *NLAS (Natural Light Average Secondment)* index.

Workmates se ofrece con fuentes de luz LED *High Efficiency* y *Full Spectrum*. Con la primera de ellas se obtiene un rendimiento excelente en términos de lm/W. Con la opción *Full Spectrum* se consigue un índice *NLAS (Natural Light Average Secondment)* inmejorable.





Kvadrat Showroom,
Copenhagen



Exhibition Hall, Spain

RECESSED



■ 14 Black
■ 14 Negro

LIGHT MODULES

UT PRO 150



LED ARRAY
20W

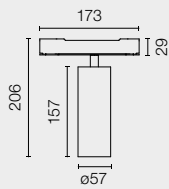

UT PRO 175



LED ARRAY
35,3W

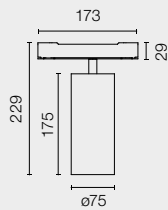

UT PRO WALL-WASHER



TOP LED
25,5W

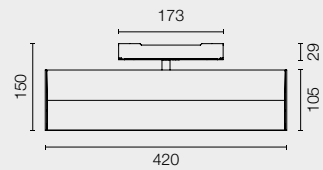

Super Spot



Spot



Medium



Flood



Wide Flood



Oval

LIGHT MODULES

WORKMATES IN-TRACK
SMALL



POWER LED
Up to 15,5W

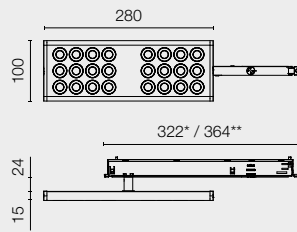

Non Dimming* / Dali**

WORKMATES IN-TRACK
LARGE



POWER LED
Up to 22W

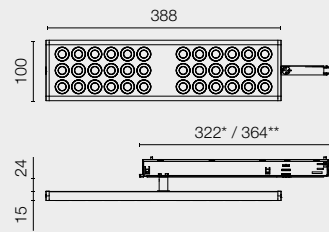

Non Dimming* / Dali**



**THE
THE
THE
THE**

**FAST
FAST
FAST
FAST**

**TRACK
TRACK
TRACK
TRACK**

A system capable of moving and guide motorised projectors along a structure. High efficiency versions with optics from superspot to flood. Easy handling through the exclusive FLOS Control®.

Sistema capaz de trasladar y orientar proyectores motorizados a lo largo de una estructura. Versiones de alta eficiencia con ópticas desde super spot a flood. Fácil manejo gracias al exclusivo FLOS Control®.

THE FAST TRACK







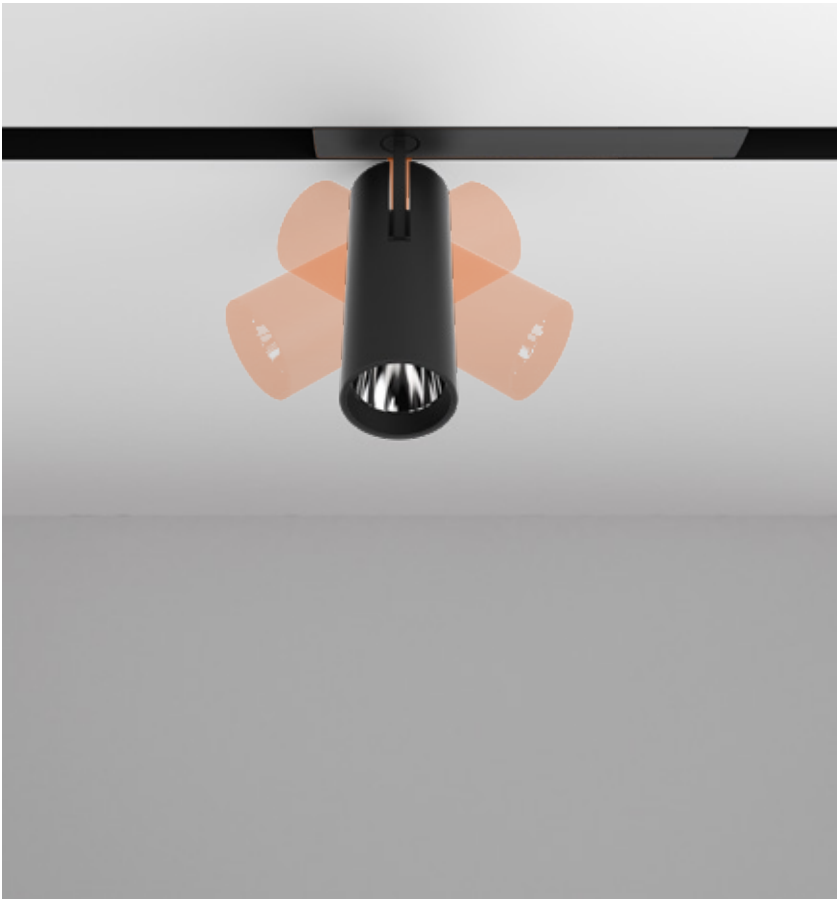

Revolutionary product that allows movement management in the three axes: rotation, tilting and translation.

Producto revolucionario que permite gestión de movimiento en los los tres ejes: rotación, inclinación y traslación.



Easy light control from the FLOS Control® application available for IOS and Android. Friendly interface with bluetooth connection.

Fácil control de la luz desde la aplicación FLOS Control® disponible en IOS y Android. Sencilla conexión por bluetooth.





Flos moves to an unprecedented level. Exclusive translation and orientation movement of a projectors system capable of being programmed and controlled remotely with FLOS Control®. Extreme technology & simplicity of service.

Flos llega hasta donde nunca se había llegado. Exclusivo movimiento de traslación y orientación de un sistema de proyectores que puede programarse y controlarse a distancia con FLOS Control®. Tecnología extrema y simplicidad de servicio.

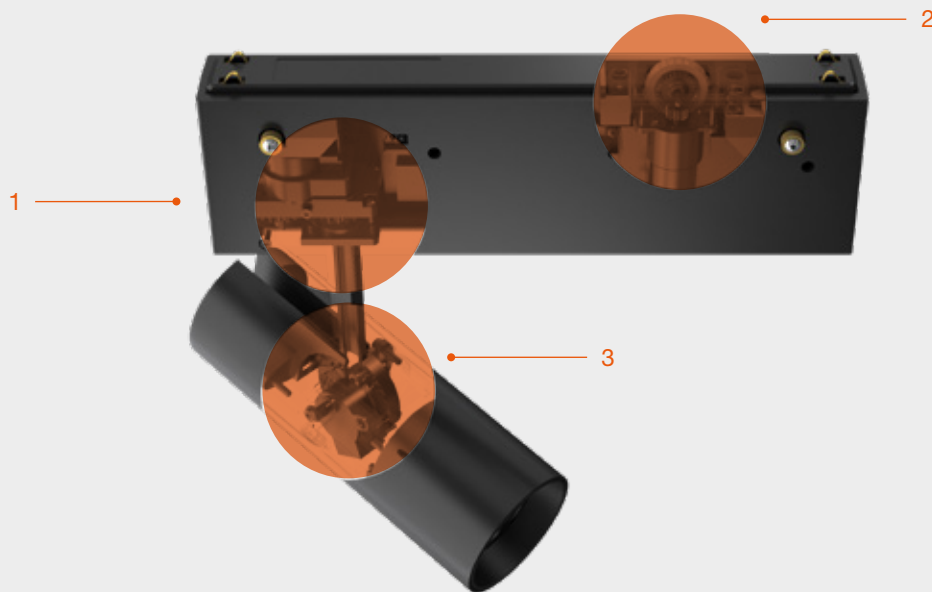

1 Rotation motor. Optical sensor that detects the spot position in the profile at any time.
Motor de rotación. Sensor óptico que detecta en cualquier momento la posición del spot en el perfil.

2 Translation motor. Rubber bearing equipped with a shock absorber that ensures constant contact with the profile for an excellent translation.
Motor de traslación. Rodamiento de goma equipado con un amortiguador que garantiza el contacto constante con el perfil para una impecable traslación.

3 Tilt motor. Limit switch sensor.
Motor de basculación. Sensor de final de recorrido.

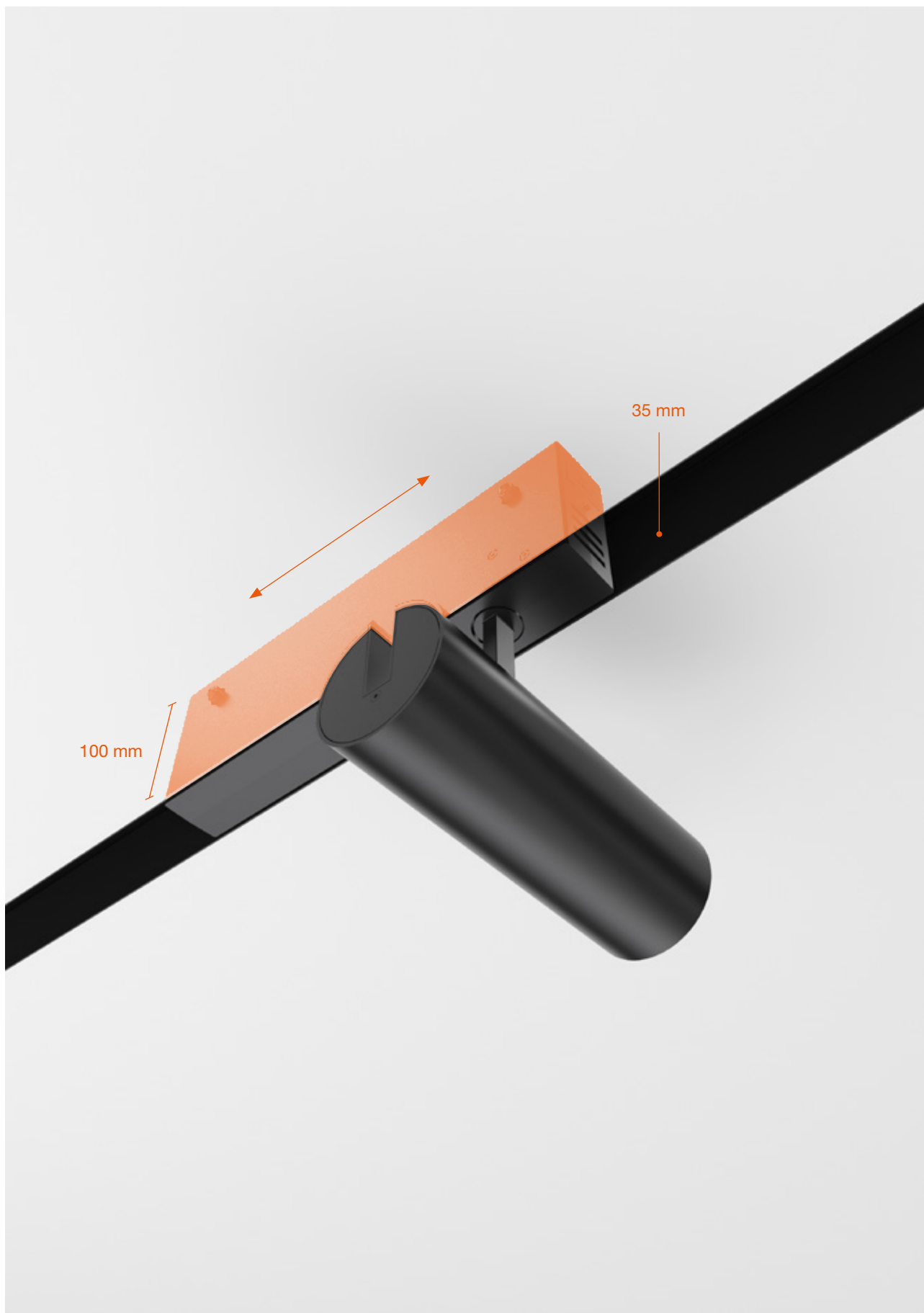



THE FAST TRACK 100

A complete range of professional spotlights: various power options, and optic from super spot to flood.

Una gama completa de proyectores profesionales: diversas opciones de potencias y ópticas desde super spot hasta flood.

1 Versions with high-efficiency multi-lens optics with up to 4-degree angles are available.

Dispone de versiones con óptica multilente de alta eficiencia con ángulos de hasta 4 grados.

THE FAST TRACK 150

2 Honeycomb accessory for a perfect visual control and shielding.

Accesorio honeycomb para garantizar el perfecto control visual y apantallamiento.





Thanks to the application you can set up each luminaire, save their orientation and generate a lighting scenario.

Gracias a la aplicación se puede configurar cada una de las luminarias, guardar su orientación y generar una escena personalizada.

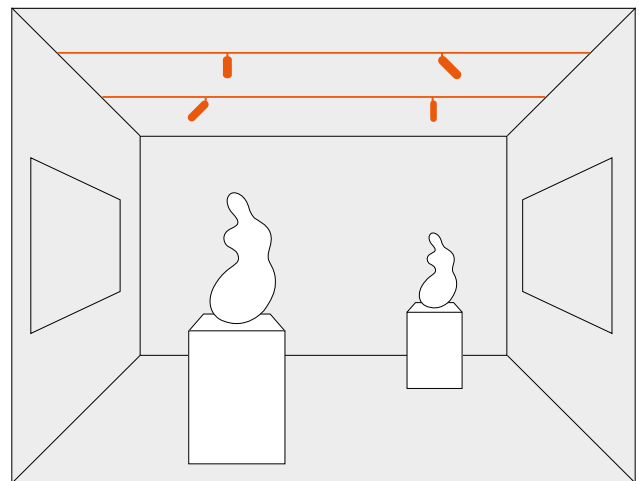
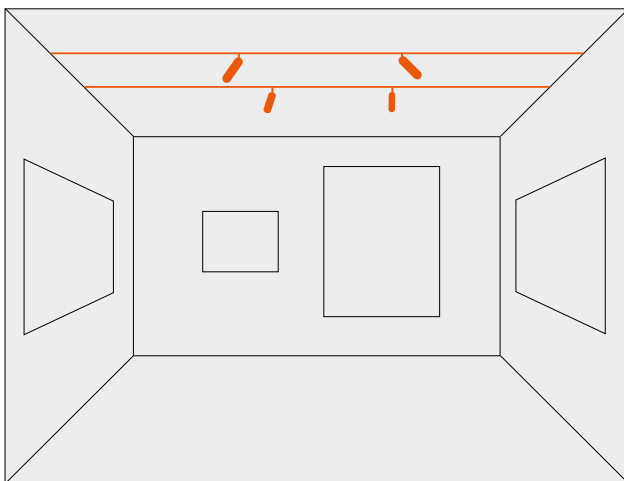

The application also offers the possibility of scenario management and scheduled activation.

La aplicación también permite la gestión de las escenas con una programación temporizada.

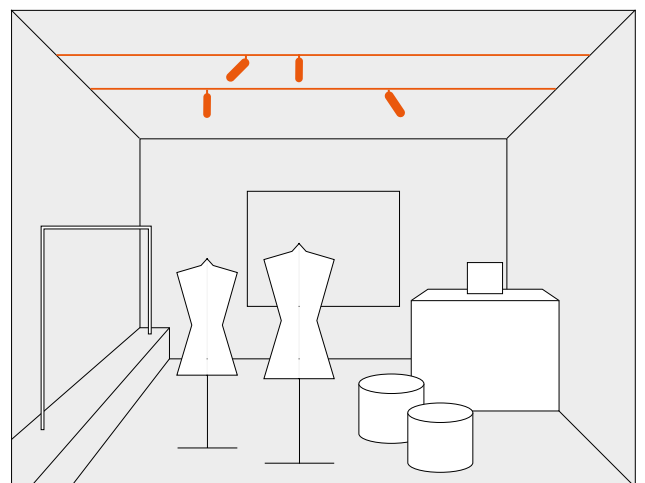
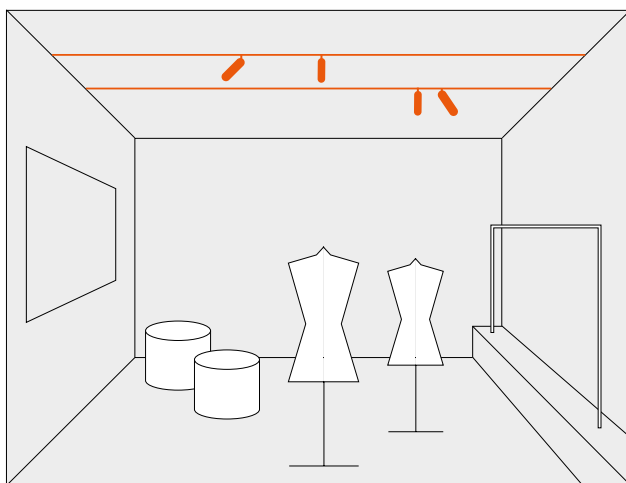
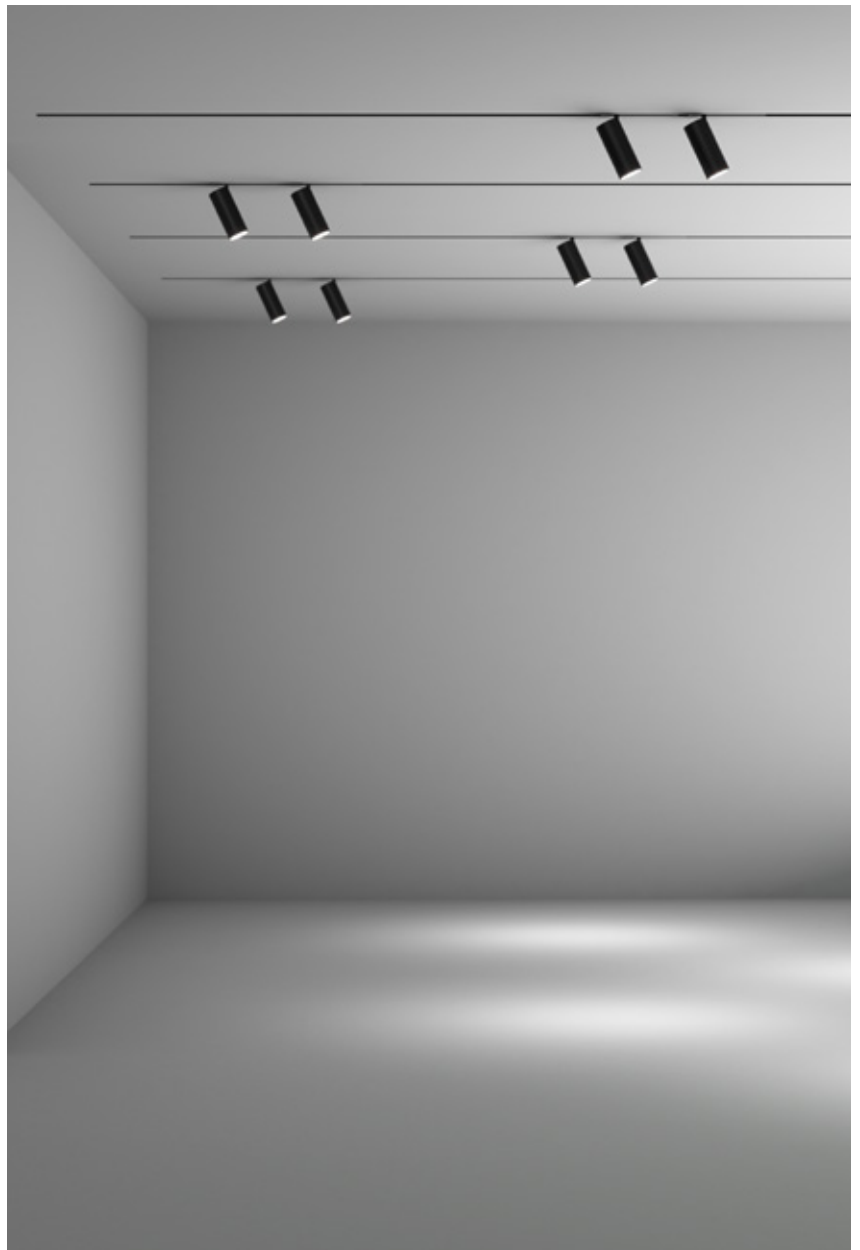



Arclinea Showroom, Italy

LIGHT MODULES

THE FAST TRACK
SPOT 100



POWER LED
13W

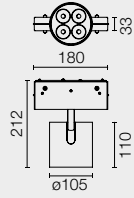

THE FAST TRACK
SPOT 150



LED ARRAY
25,5W

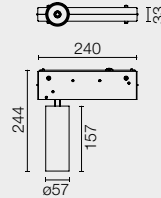

Super Spot



Spot



Medium



Flood

RECESSED



■ 14 Black
14 Negro

SURFACE



□ 40 White
40 Blanco ■ 14 Black
14 Negro



■ 14 Black
14 Negro



□ BW White
BW Blanco

MULTIFUNCTION
SMART DEVICE



FLOS CONTROL®
by Casambi

**W
WORKMATES
M**

The traditional office paradigm is no longer the *statu quo* for professional spaces. New hybrid models of working have redefined their architectures, uses and functionalities. Workmates is Flos' luminaire ecosystem for new contemporary and multidisciplinary work spaces.

El paradigma de la oficina clásica ha dejado de ser el *statu quo* para los espacios profesionales. Los nuevos modelos de trabajo híbrido han redefinido sus arquitecturas, sus usos y funcionalidades. Workmates es el ecosistema de luminarias de Flos para los nuevos espacios de trabajo: contemporáneos y multidisciplinares.

WORKMATES

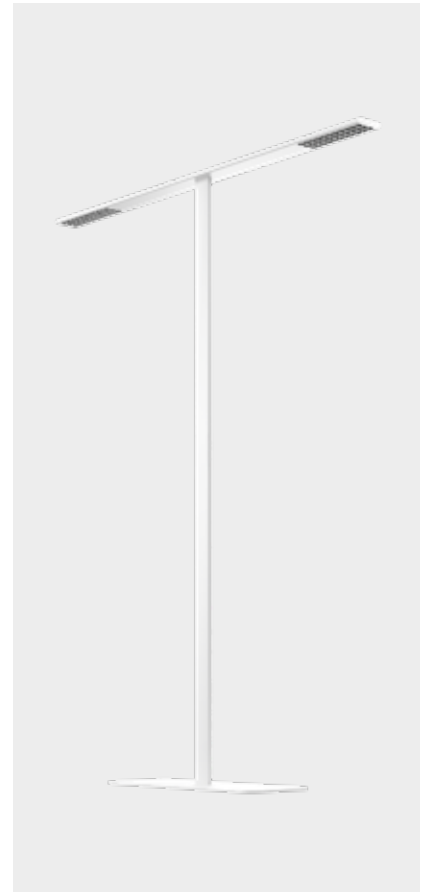
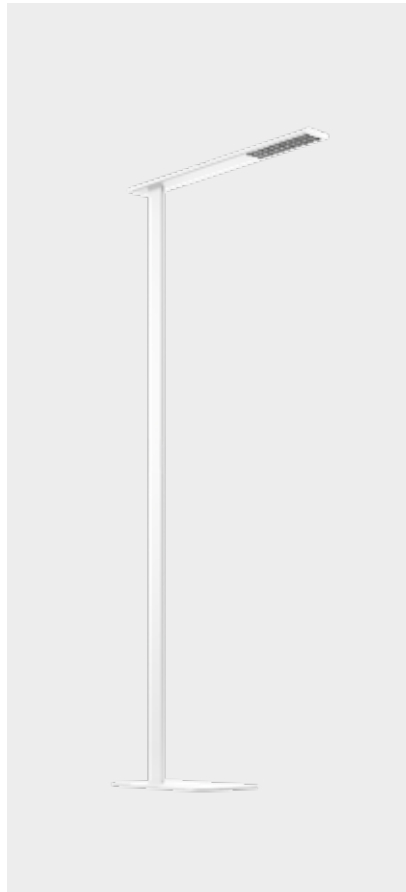
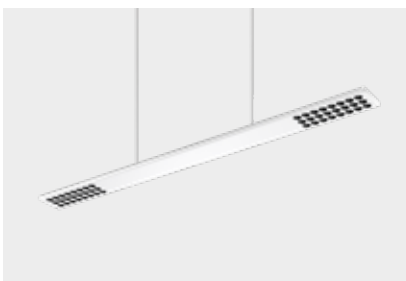

A collection of products designed to answer any lighting need with versatility. A lighting concept that places personal well-being at the very core of its technical development and adds careful attention to the aesthetics and details that emanate from the differential identity of the Flos design. Workmates comes in 4 installation options (ceiling surface, suspension, floor and track), in order to adapt to the installation requirements of any space.

Una colección de productos diseñados para responder con versatilidad a cualquier necesidad lumínica. Un concepto de iluminación que sitúa el bienestar de la persona en el centro de su desarrollo técnico y añade un esmerado cuidado de la estética y los detalles que emana de la identidad diferencial del diseño de Flos. Workmates se deriva en 4 opciones de implementación (superficie de techo, suspensión, suelo y carril), para adaptarse a las necesidades de instalación de todos los espacios.

- 1 CEILING
- 2 TRACK
- 3 SUSPENSION
- 4 FLOOR DOUBLE
- 5 FLOOR SINGLE

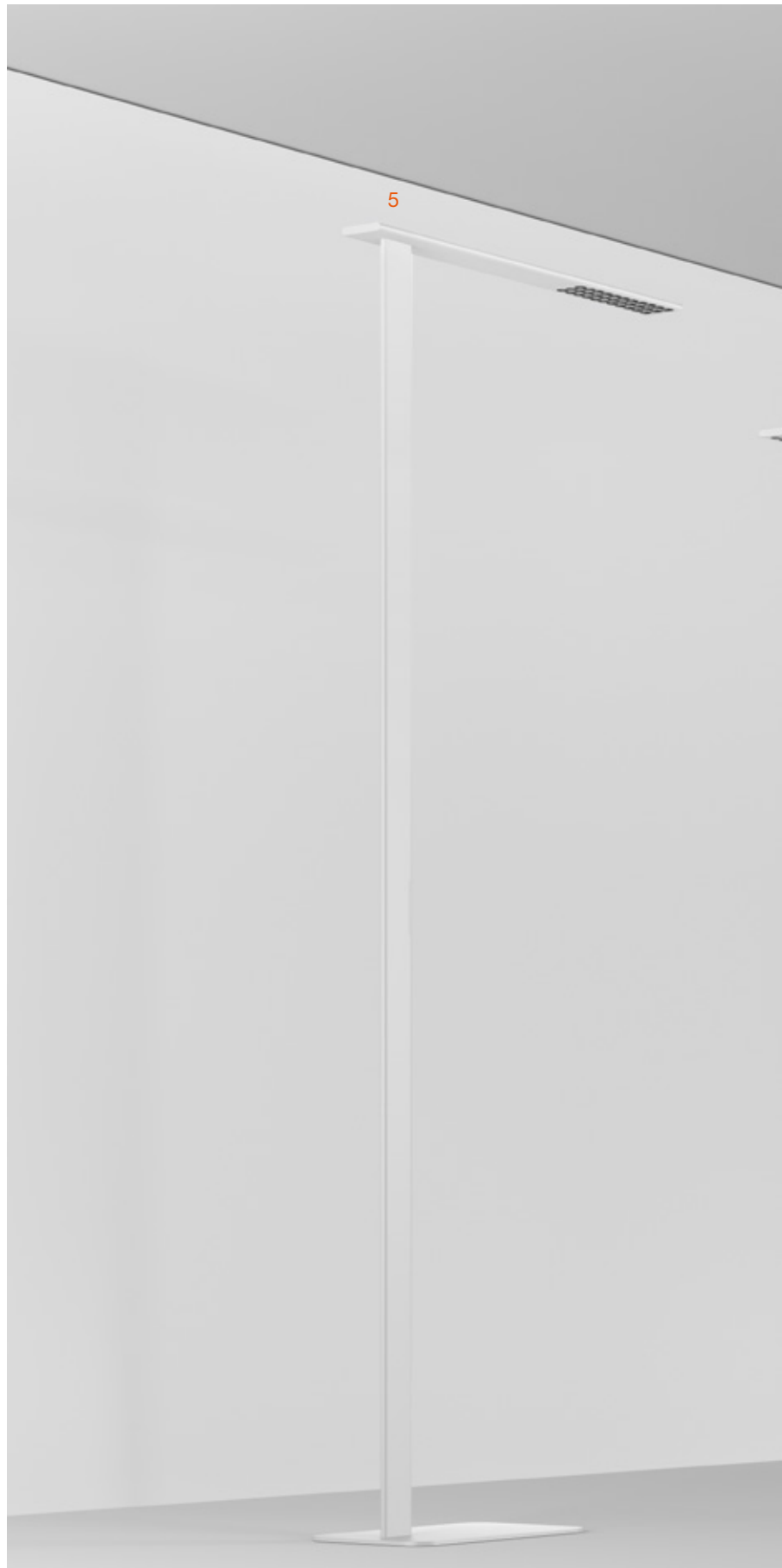



The workspace is no longer at odds with the beauty of optimal design. Details matter, and that is why Workmates is pure Flos. With its magnetic presence, it is slim, minimalist, subtle...

Workmates comes in a range of select finishes: All White, White and Black. In addition, the attractive Anodized Silver finish is available in all models except the floor option.

El espacio de trabajo ha dejado de estar reñido con la belleza del mejor diseño. Los detalles importan, por ello Workmates es puro Flos. Con una presencia magnética, es esbelto, minimalista, sutil...

Workmates se ofrece en una gama de escogidos acabados: All White, White y Black. Además, en todos los modelos salvo en la opción de suelo, se añade la atractiva terminación Anodized Silver.



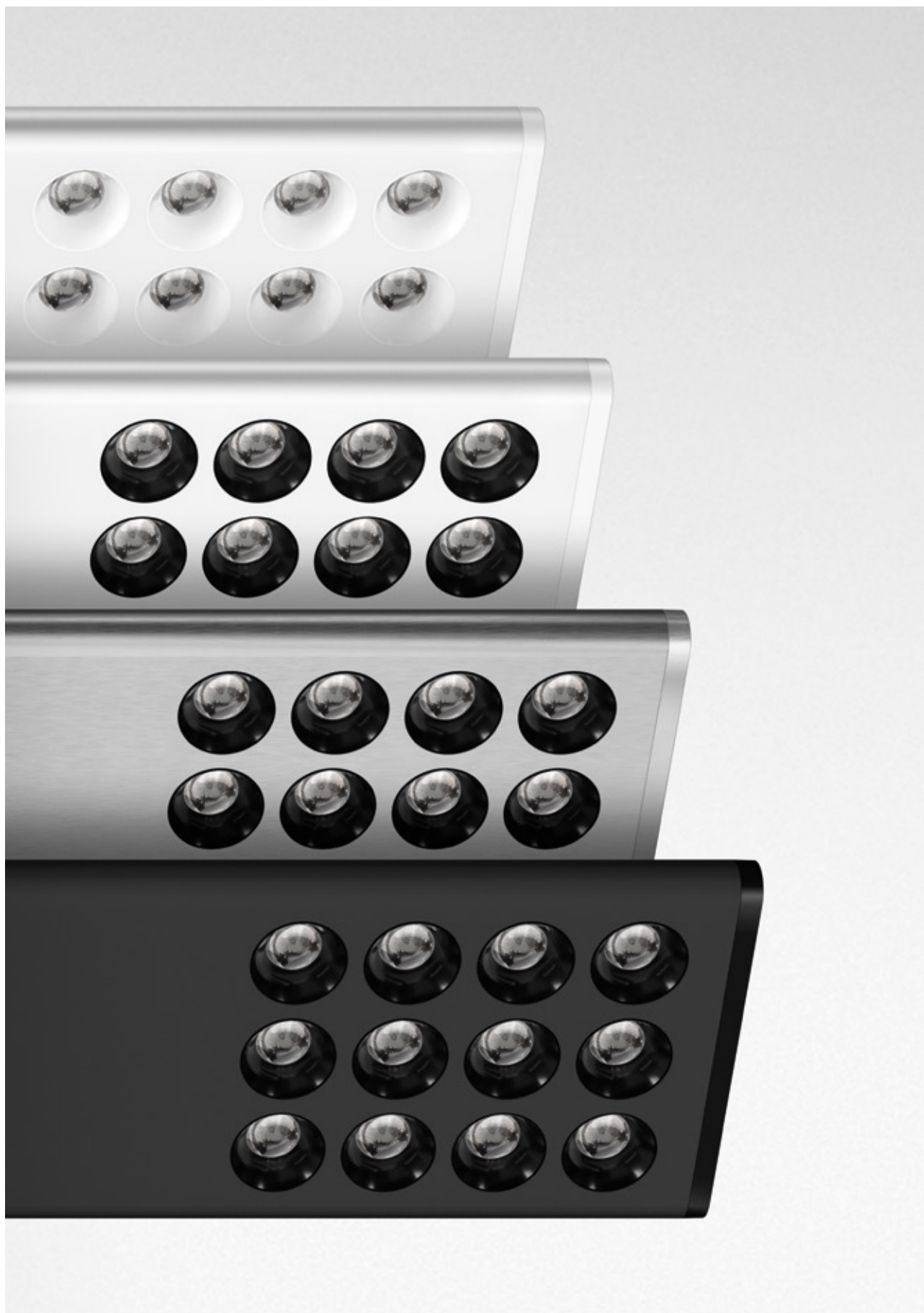

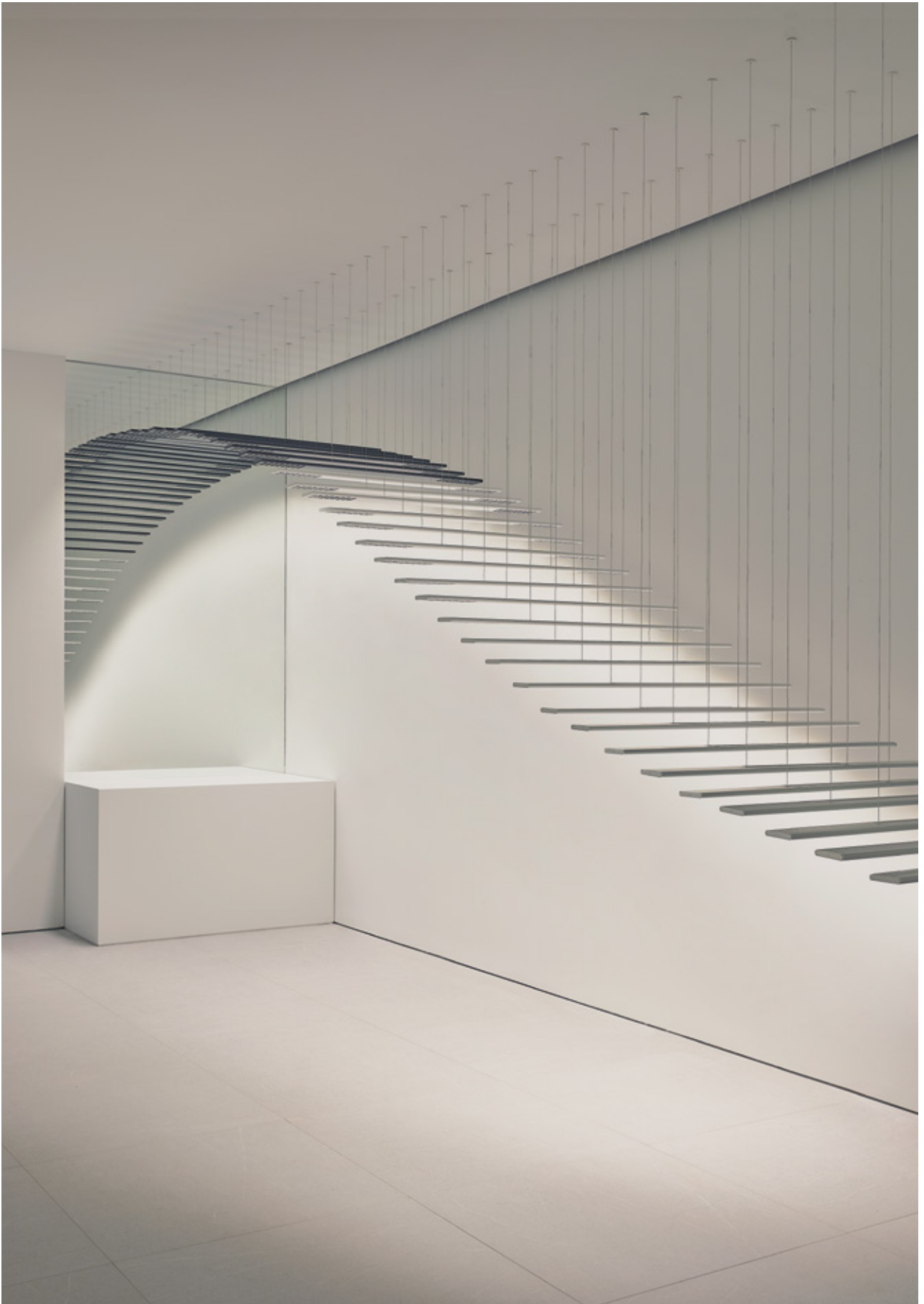











HUMAN CENTRIC LIGHTING

Smart models with indirect *Tunable White* variable CCT emission enable the *Smart* modulation of the light's colour temperature to assist with circadian entrainment depending on time of day, promoting well-being and health at work.

Los modelos *Smart*, con emisión indirecta de CCT variable *Tunable White*, permiten la modulación inteligente de la temperatura de color de la luz para ajustarse al ritmo circadiano según la hora del día y favorecer el bienestar y la salud en el trabajo.

VISUAL COMFORT · OFFICE REGULATIONS COMPLIANCE

Workmates meets the strictest standards in terms of visual comfort for offices. This ensures a comfortable working environment for the eyes, reducing glare and eyestrain, which promotes a more productive and healthy working environment.

Workmates cumple con los estándares más estrictos en términos de confort visual para oficinas. Esto garantiza un entorno de trabajo cómodo para la vista, reduciendo el deslumbramiento y la fatiga visual, lo que fomenta un ambiente de trabajo más productivo y saludable.

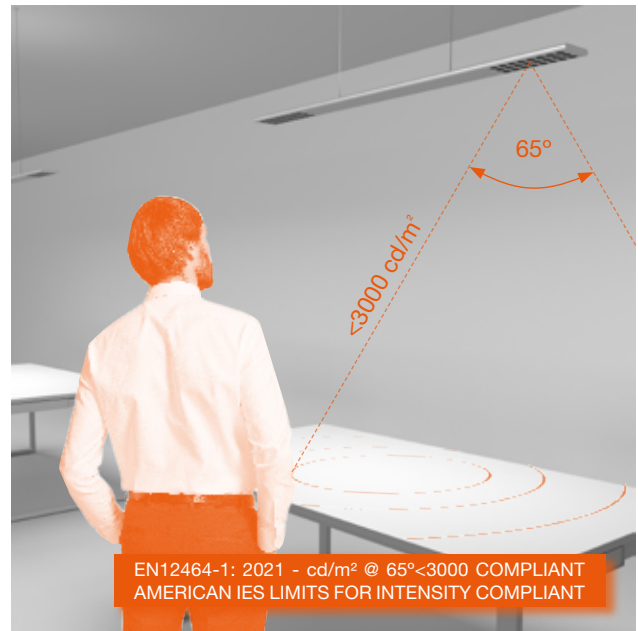
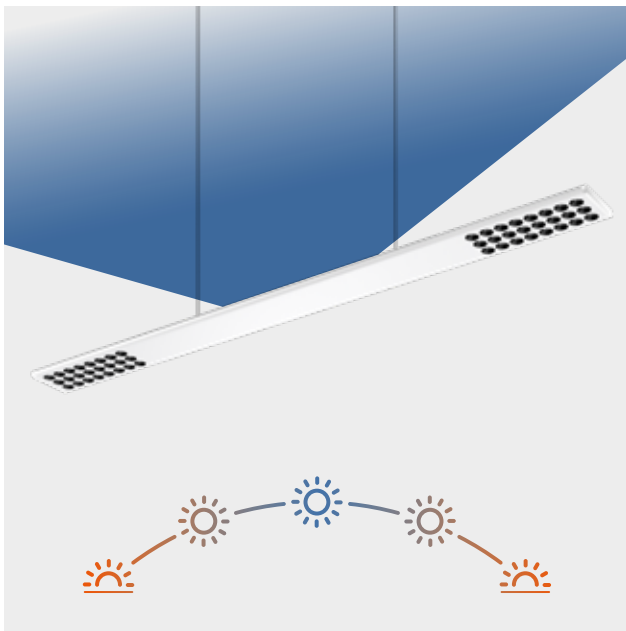

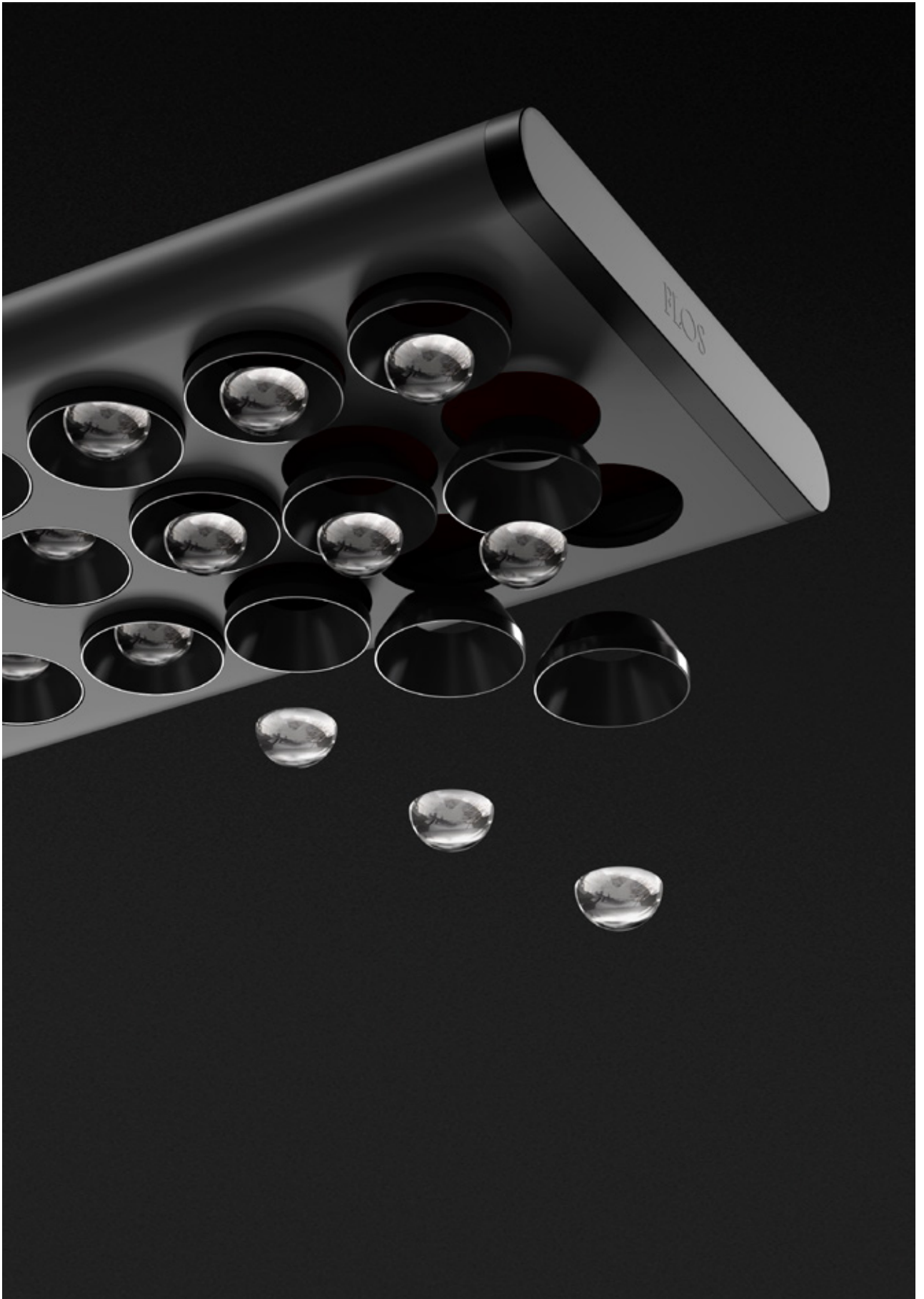

SMART LIGHTING

With its *Dali* and wireless *Casambi* control systems, Workmates has built-in or external sensors to activate the desired lighting scenarios for each situation. All of it triggered by presence¹ or absence¹ detection, or the desired brightness² thresholds.

Con los sistemas de control *Dali* e inalámbrico *Casambi*, Workmates cuenta con sensores integrados o externos para activar las escenas de iluminación deseadas para cada situación. Todo, a reacción de la detección de presencia¹, ausencia¹ o de los umbrales de luminosidad² deseados.

DEDICATED LIGHT EMISSION

Each Workmates model offers of the necessary light distribution forms for applications that are required in workspaces. Depending on the model, *wide flood*, *oval* or *asymmetric* distributions are available for *Down* emission, and *Extra Wide flood* for *Up* emission.

Cada modelo de Workmates ofrece las formas de distribución lumínica necesarias para las aplicaciones que se exige en los espacios de trabajo. Según el modelo, existen distribuciones *wide flood*, *oval* o *asymmetric* para emisión *Down* y *Extra Wide flood* para emisión *Up*.

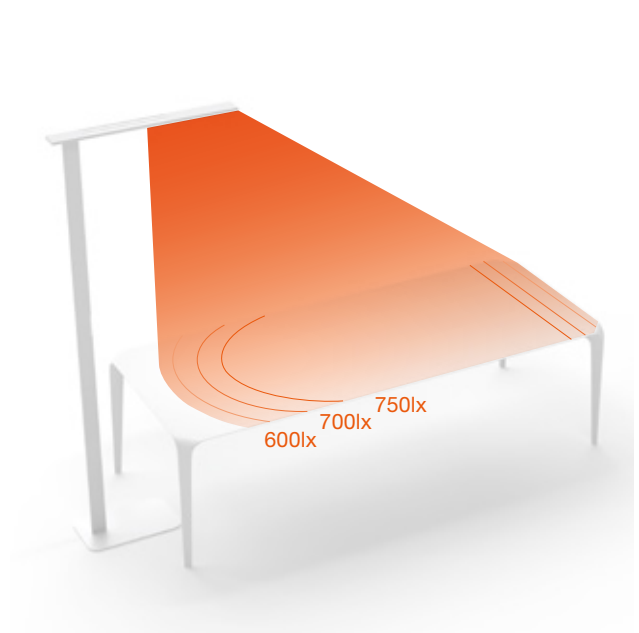
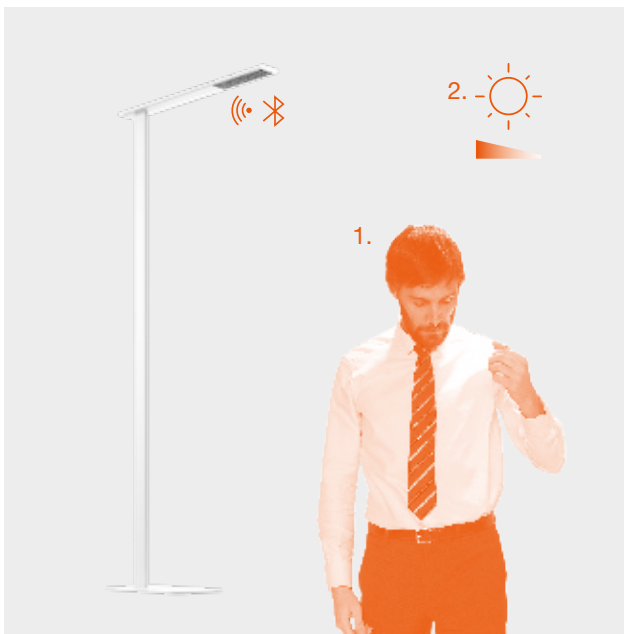









All the lights in the Workmates ecosystem are fitted with *High Efficiency* and *Full Spectrum* LED light sources. With the former, you get excellent performance in terms of lm/W, while with the *Full Spectrum* option, you get the perfect NLAS (Natural Light Average Secondment) index.

Natural light sets a very precise path within the visible light spectrum. The “*Full Spectrum*” LED option, available for Workmates, reflects the most accurate behaviour of artificial light compared with the performance of natural light. It therefore helps improve human well-being and respect the natural schemes of circadian lighting.

Todas las luminarias del ecosistema Workmates se ofrecen con fuentes de luz LED *High Efficiency* y *Full Spectrum*. Con la primera de ellas se obtiene un rendimiento excelente en términos de lm/W. Con la opción *Full Spectrum* se consigue un índice NLAS (*Natural Light Average Secondment*) inmejorable.

Dentro del espectro visible de la radiación luminosa, la luz natural describe un recorrido muy concreto. La opción de LEDs “*Full Spectrum*”, presente en Workmates, ofrece el comportamiento más fiel de una luz artificial, comparado con el rendimiento de la luz natural. De este modo, mejora el bienestar humano al respetar los esquemas naturales de iluminación circadiana.

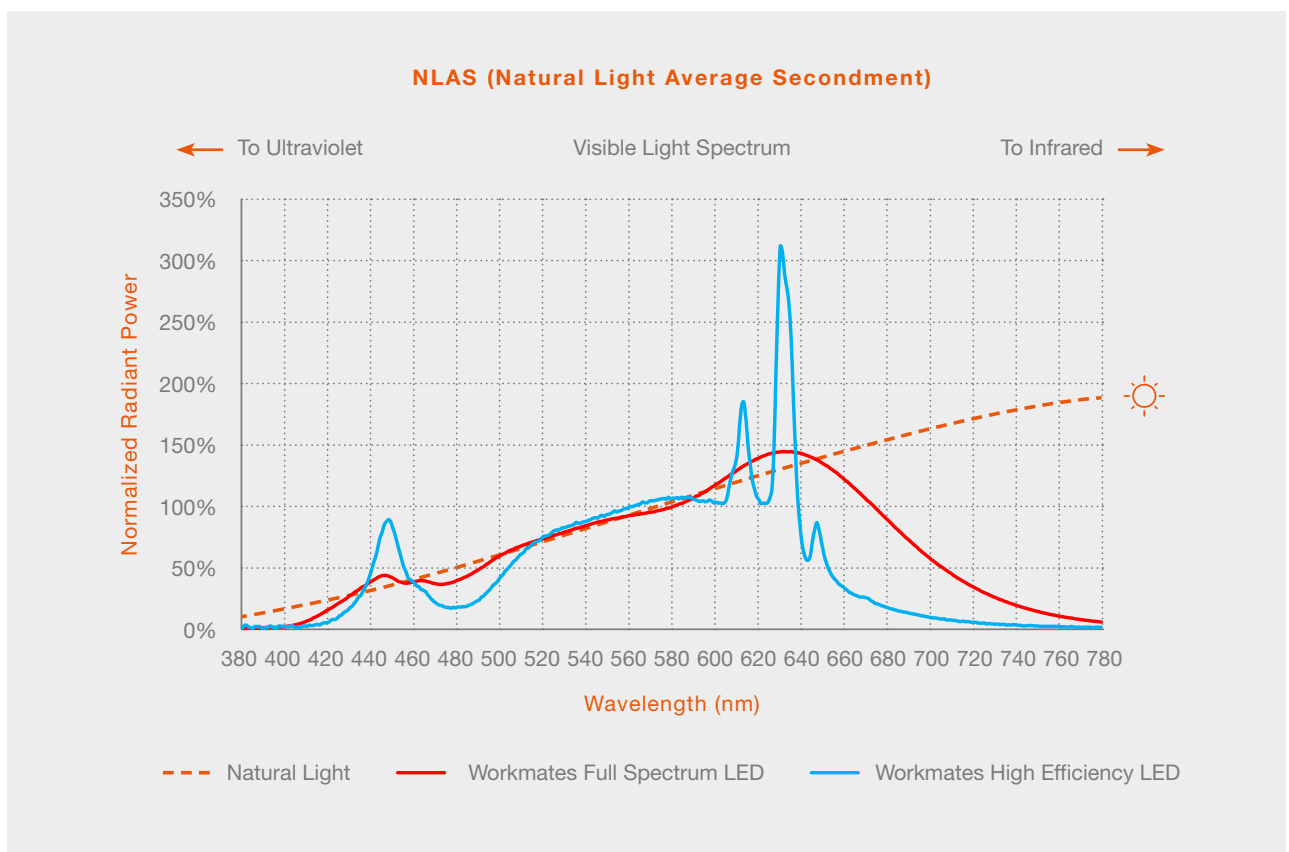



Different control options for dimming WORKMATES.

Diferentes opciones de control para la regulación de WORKMATES.

Touch Dimming

The floor versions have an integrated capacitive keypad to control the luminaire.

Las versiones de suelo cuentan con una botonera capacitiva integrada para el control de la luminaria.

DALI

Standard protocol for integration with any control system.

Protocolo standard para la integración con cualquier sistema de control.

CASAMBI

Control through a tablet or smartphone application (FLOS Control®).

Control a través de una aplicación para tablet o smartphone (FLOS Control®).

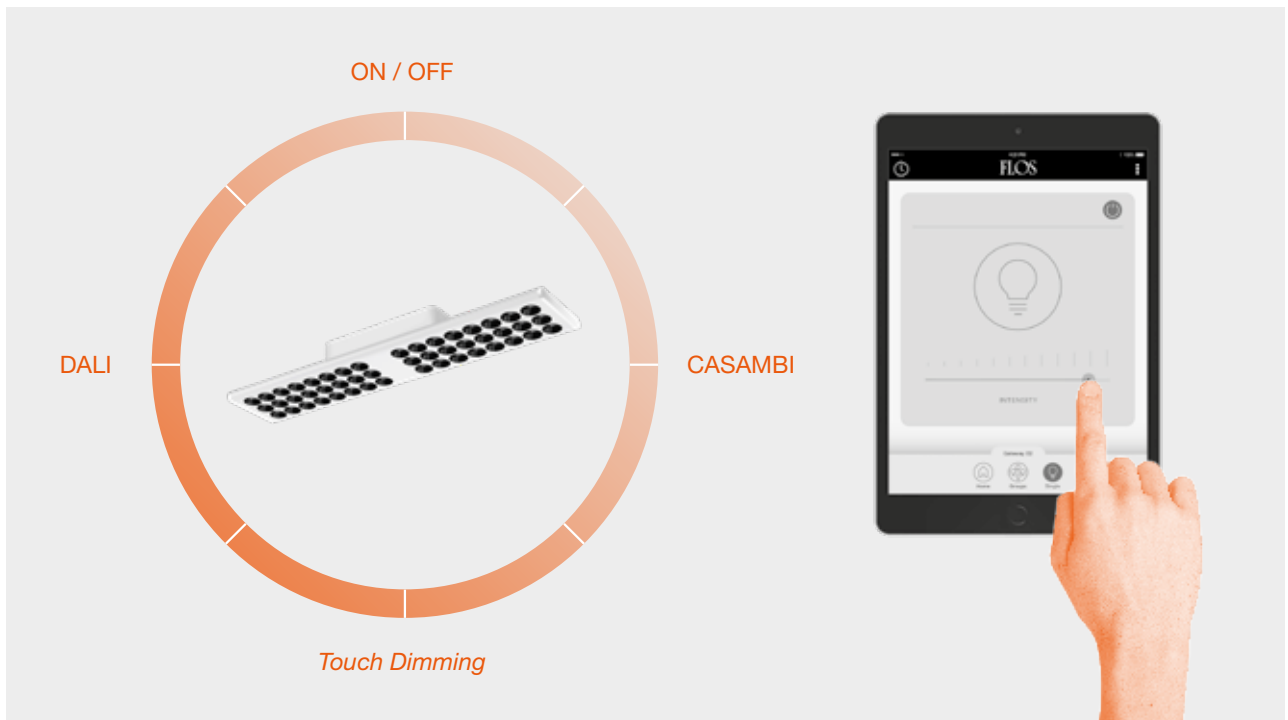

FLOS CONTROL®
BY CASAMBI

The FLOS Control® application allows you to control the system's luminaires as a group, controlling scenes and programming.

La aplicación FLOS Control®, permite controlar las luminarias del sistema en grupo, controlando escenas y programación.

With a traditional electrical installation and the Gateway connected by Bluetooth, you obtain total control of the ambience.

Con tan sólo una instalación eléctrica tradicional y el Gateway conectado por Bluetooth se obtiene un control total del ambiente.

Available for iOS and Android

Disponible en iOS y Android

WORKMATES SURFACE
SMALL



TOP LED
14W

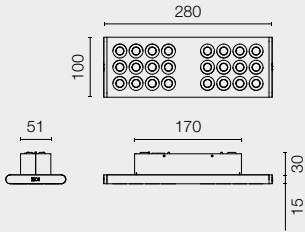

WORKMATES SURFACE
LARGE



TOP LED
28W

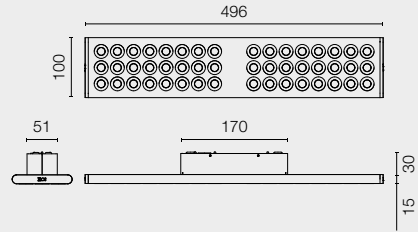

WORKMATES TRACK
SMALL



TOP LED
Up to 15,5W

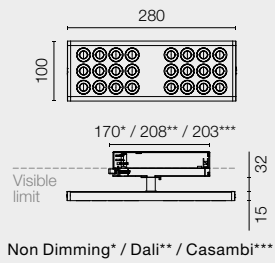

WORKMATES TRACK
LARGE



TOP LED
Up to 22W

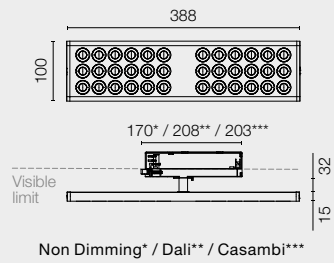

WORKMATES IN-TRACK
SMALL



TOP LED
Up to 15,5W

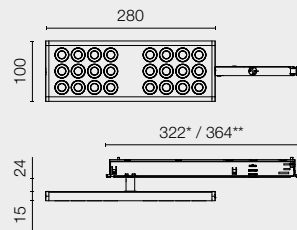

Non Dimming* / Dali**

WORKMATES IN-TRACK
LARGE



TOP LED
Up to 22W

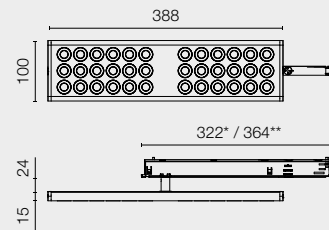

Non Dimming* / Dali**

THE RUNNING MAGNET

WORKMATES SMALL



WORKMATES LARGE



* Refer to The Running Magnet chapter / Ver capítulo The Running Magnet

WORKMATES SUSPENSION

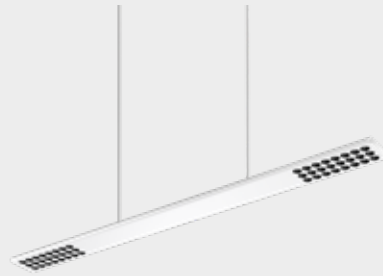

SUSPENSION DOWN
TOP LED
 Up to 28W

SUSPENSION UP&DOWN
TOP LED
 Up to 58,5W

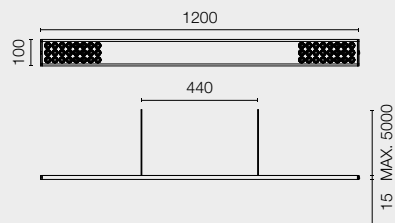

Wide Flood



Oval



High Comfort



Up&Down



Asymmetrical

WORKMATES FLOOR
SINGLE

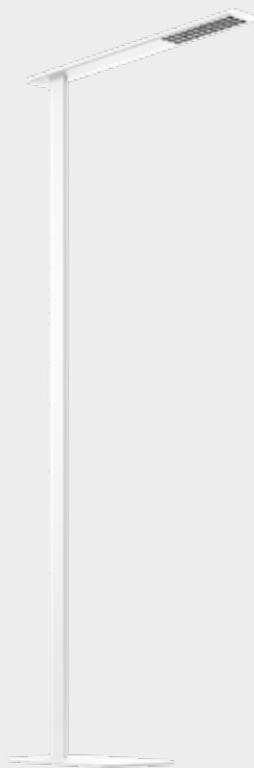

TOP LED
Up to 65,4W

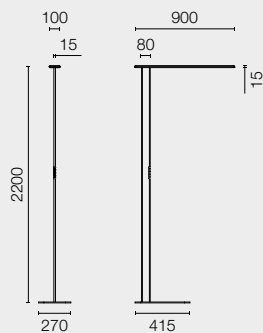

WORKMATES FLOOR
DOUBLE



TOP LED
Up to 112W

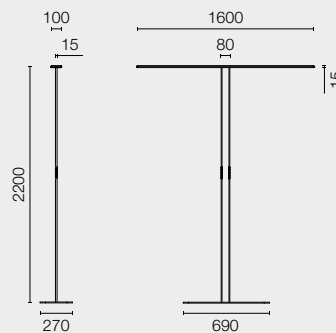

LIGHT SHADOW

SHADOW

SHADOW

SHADOW

SHADOW

SHADOW

SHADOW

SHADOW

SHADOW

SHADOW

MINI

SHADOW

Miniaturized downlight designed to provide exceptional visual comfort while ensuring optimal performance and high light quality. Its ability to precisely control light guarantees a glare-free experience, perfectly adapting to various spaces and specific requirements.

Downlight miniaturizado diseñado para proporcionar un confort visual excepcional, garantizando al mismo tiempo un rendimiento óptimo y una gran calidad de luz. Su capacidad para controlar la luz con precisión garantiza una experiencia sin deslumbramientos, adaptándose perfectamente a diversos espacios y requisitos específicos.

LIGHT SHADOW MINI



The compact design and revolutionary optical system provide a superior visual experience, eliminating unwanted reflections and enhancing visual comfort in any environment.

Su diseño compacto y su revolucionario sistema óptico proporcionan una experiencia visual superior, eliminando los reflejos no deseados y mejorando el confort visual en cualquier entorno.

SYSTÈME OPTIQUE
SISTEMA ÓPTICO

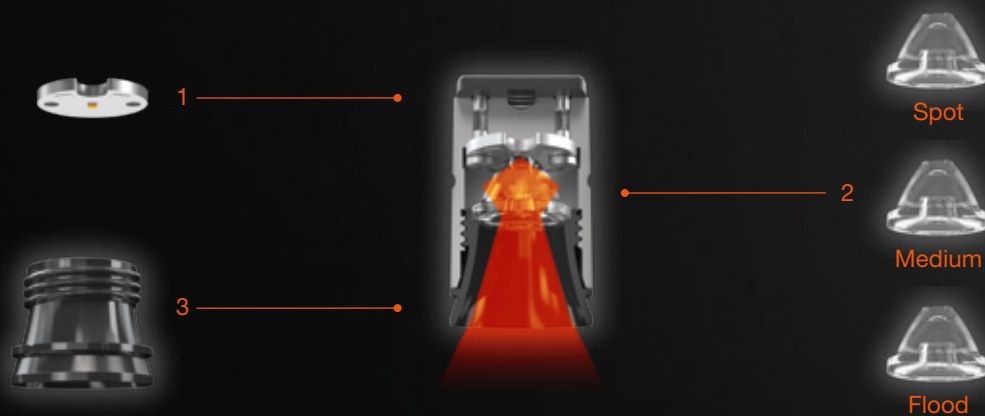

1 High-efficiency LED module by FLOS, featuring advanced technology for optimal performance, color accuracy, and durability.

1 Módulo LED de alta eficiencia de FLOS, con tecnología avanzada para un rendimiento, precisión cromática y durabilidad óptimos.

2 Custom-designed advanced lenses by FLOS, ensuring precise beam control and uniform distribution without energy loss.

2 Óptica avanzada diseñada a medida por FLOS, que garantiza un control preciso del haz y una distribución uniforme sin pérdida de energía.

3 Patented optical system with innovative cones and inverted curvature, reducing glare and enhancing visual comfort.

3 Sistema óptico patentado con conos innovadores y curvatura invertida, que reduce el deslumbramiento y mejora el confort visual.









Light Shadow Mini is available in multiple configurations, including Trim, No Trim, and fixed or adjustable models, adapting to any lighting need. This versatility allows it to integrate seamlessly into any space, providing solutions for both focused lighting and general applications.

Light Shadow Mini está disponible en múltiples configuraciones, incluyendo Trim, No Trim, y modelos fijos u orientables, adaptándose a cualquier necesidad de iluminación. Esta versatilidad le permite integrarse perfectamente en cualquier espacio, proporcionando soluciones tanto para iluminación focalizada como para aplicaciones generales.

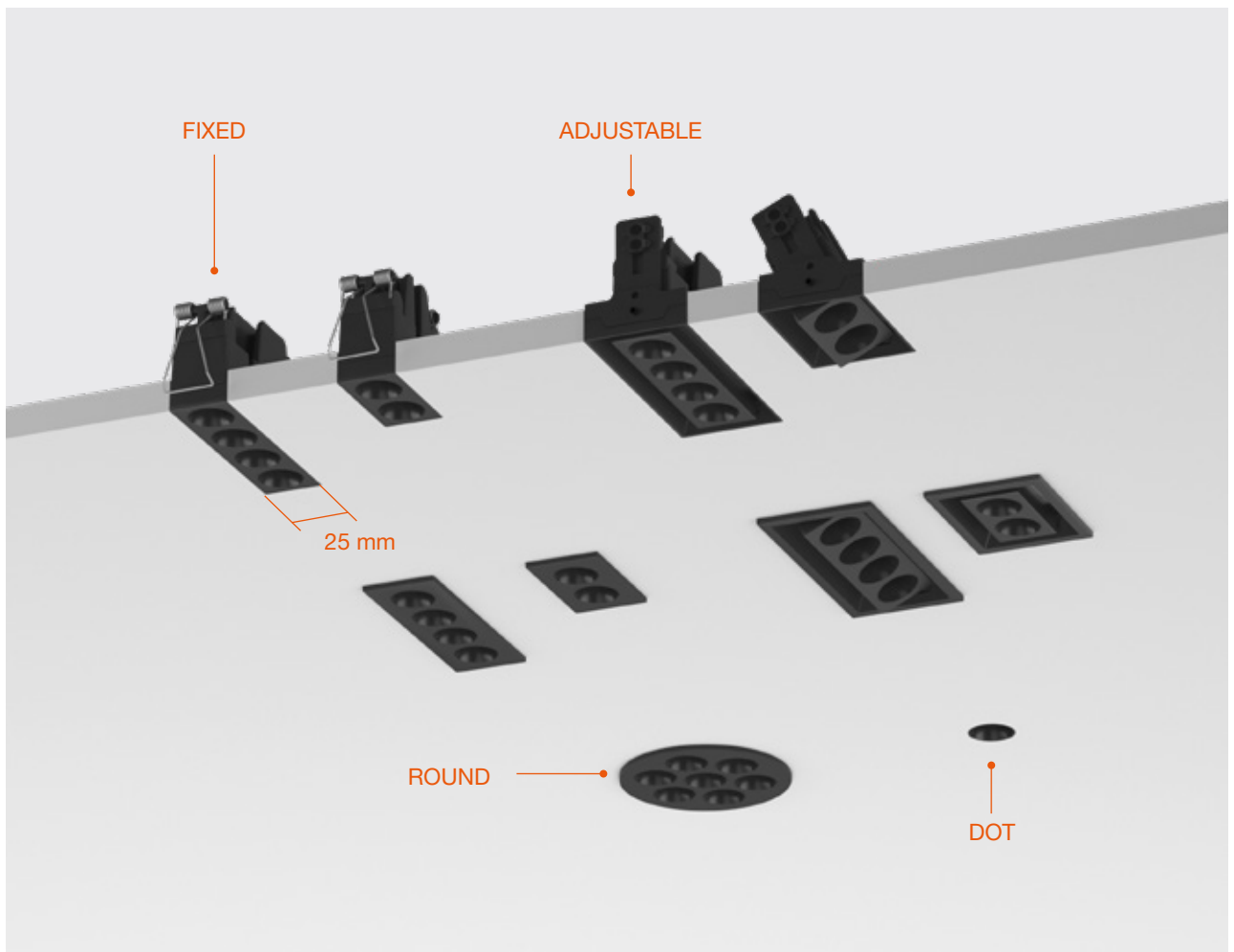

Light Shadow Mini stands out for its compact size, allowing for discreet integration without compromising lighting performance. Its versatile design adapts to a wide range of applications, delivering precise and comfortable illumination.

Light Shadow Mini destaca por su tamaño compacto, que permite una integración discreta sin comprometer el rendimiento de la iluminación. Su diseño versátil se adapta a una amplia gama de aplicaciones, proporcionando una iluminación precisa y cómoda.

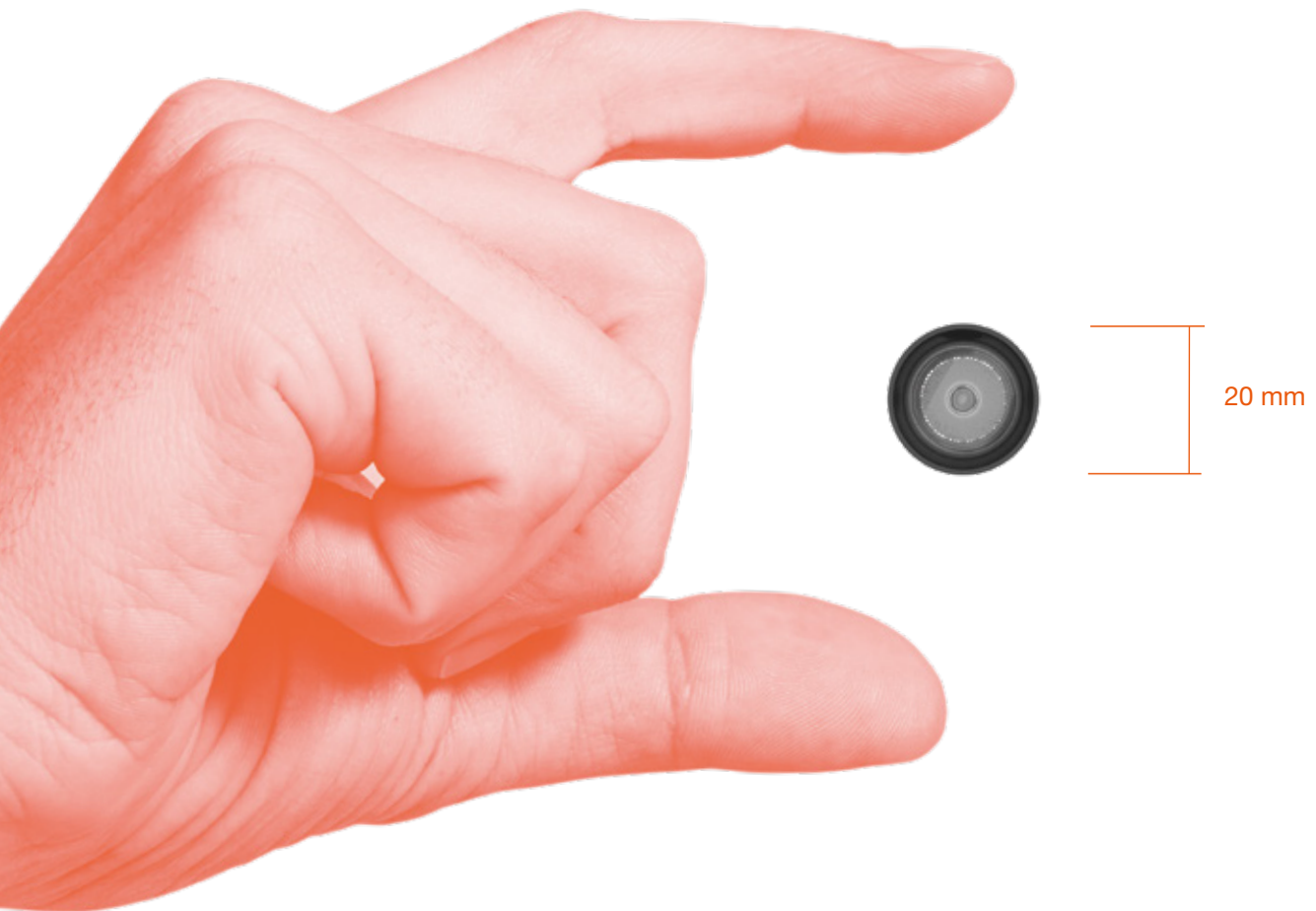

ULTIMATE COMFORT

With a UGR below 10, it offers optimal glare protection, enabling a more comfortable and natural visual experience. Its advanced optical technology ensures homogeneous light distribution, eliminating excessive contrasts and unwanted shadows.

Con un UGR inferior a 10, ofrece una protección óptima contra el deslumbramiento, permitiendo una experiencia visual más cómoda y natural. Su avanzada tecnología óptica garantiza una distribución homogénea de la luz, eliminando los contrastes excesivos y las sombras no deseadas.

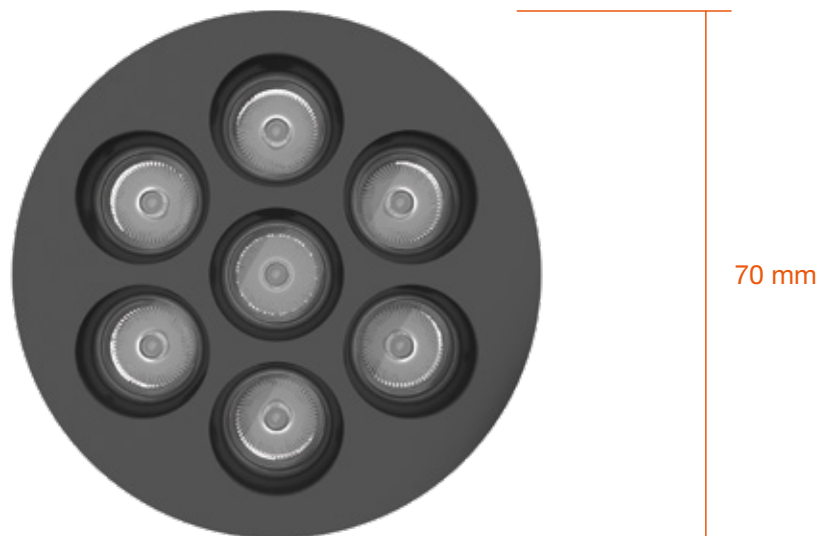

With a recessed depth of less than 30 mm, Light Shadow Mini represents a breakthrough in architectural lighting. Its ultra-compact design allows for versatile installation in a wide variety of ceilings, including those with minimal-depth false ceilings, where conventional solutions are not viable.

Con una profundidad de empotramiento inferior a 30 mm, Light Shadow Mini representa un gran avance en la iluminación arquitectónica. Su diseño ultracompacto permite una instalación versátil en una amplia variedad de techos, incluidos aquellos con falsos techos de profundidad mínima, donde las soluciones convencionales no son viables.

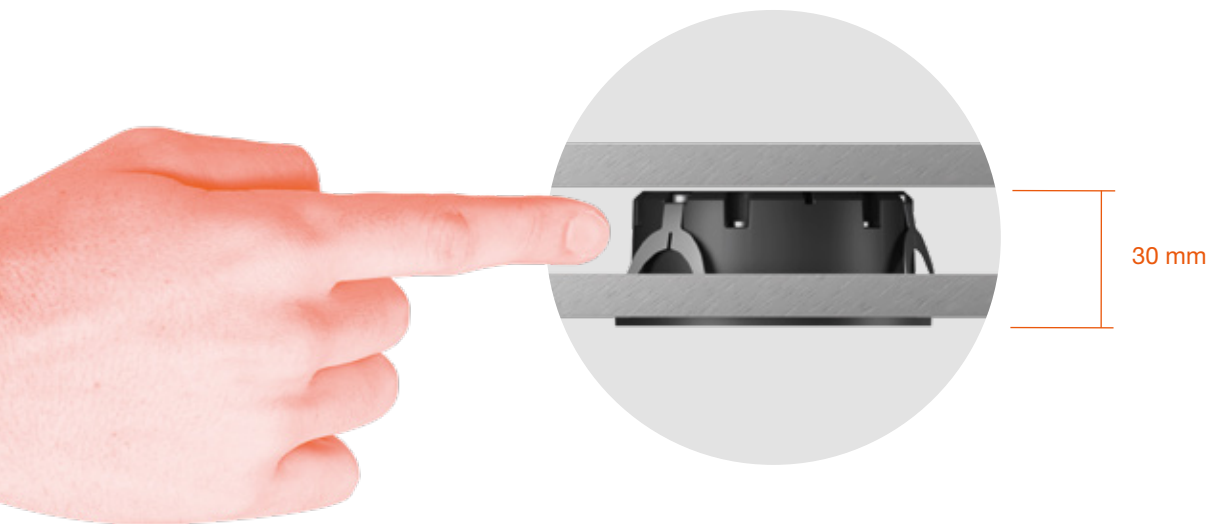

Less than 30 mm are needed to install the product, making it compatible with virtually any ceiling condition. The recess depth of the round version is a game changer in architectural lighting.

Se necesitan menos de 30 mm para instalar el producto, lo que lo hace compatible con prácticamente cualquier condición de techo. La profundidad de empotramiento de la versión redonda cambia las reglas del juego de la iluminación arquitectónica.







It is available in a variety of finishes, including sophisticated metallic options. These allow the luminaires to function not only as light sources but also as decorative elements, adding an elegant and distinctive design touch to any space.

Está disponible en diversos acabados, incluidas sofisticadas opciones metálicas. Estos permiten que las luminarias funcionen no sólo como fuentes de luz, sino también como elementos decorativos, añadiendo un toque de diseño elegante y distintivo a cualquier espacio:

Internal Finish / Acabado interior

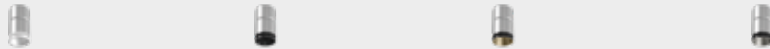

External Finish White / Acabado exterior Blanco

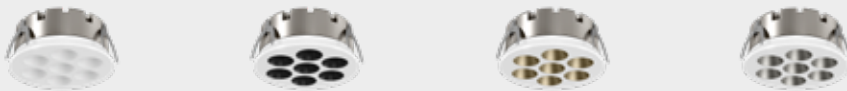

External Finish Black / Acabado exterior Negro

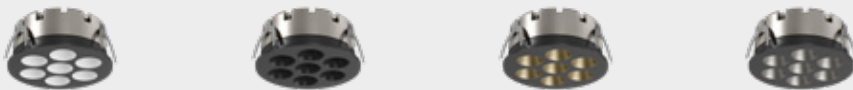

1. White, 2. Black, 3. Bronze, 4. Steel

1. Blanco, 2. Negro, 3. Bronce, 4. Acero





Different control options are available to make the most out of the product, providing flexibility or playing with personalised lighting scenarios.

Dispone de distintas opciones de control para sacar el máximo partido al producto, aportando flexibilidad o creando escenarios de iluminación personalizados.

MAINS DIMMING	Light intensity regulation through phase-cut dimming of the electrical network.	Regulación de la intensidad luminosa mediante corte de fase de la red eléctrica.
1-10V	Broadcast remote control (dimming all luminaires within a single group).	Control remoto por difusión (regulación de todas las luminarias de un mismo grupo).
DALI	Standard protocol for integration with any control system, allowing individual control of each luminaire.	Protocolo estándar para la integración con cualquier sistema de control, permitiendo el control individual de cada luminaria.
CASAMBI	Control through a tablet or smartphone application (FLOS Control®).	Control a través de una aplicación para tablet o smartphone (FLOS Control®).



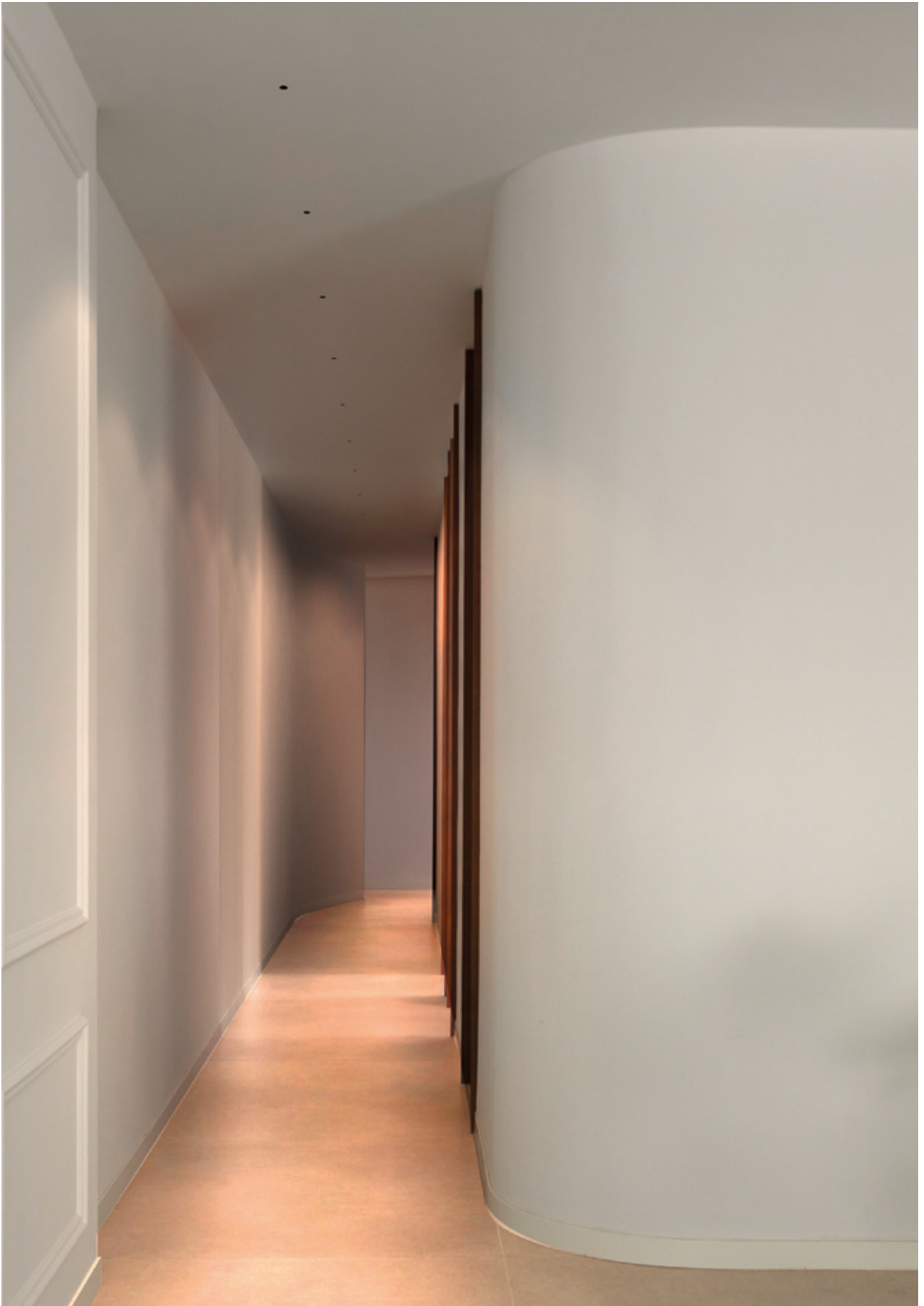

DOTS



POWER LED
1,5W

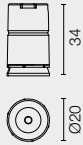

ROUND TRIM



POWER LED
6,1W

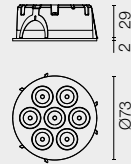

FIXED
TRIM / NO TRIM
2 SPOTS



POWER LED
3,1W

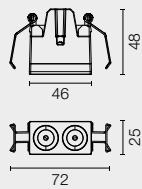
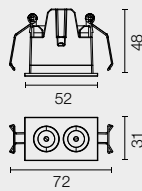

FIXED
TRIM / NO TRIM
4 SPOTS



POWER LED
6,2W

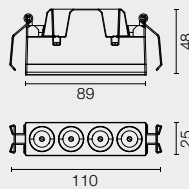
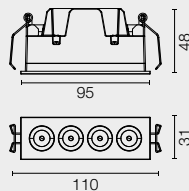

ADJUSTABLE
TRIM / NO TRIM
2 SPOTS



POWER LED
3,1W

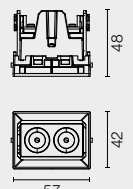
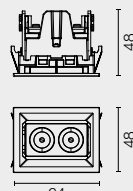

ADJUSTABLE
TRIM / NO TRIM
4 SPOTS



LED ARRAY
6,2W

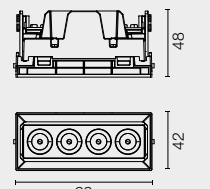
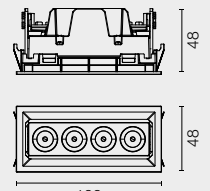

Spot



Medium



Flood

Compact size program designed to avoid glare.
Variety of optics, sizes and finishes. Great control
thanks to its patented optical group.

Programa de tamaño compacto diseñado para
evitar deslumbramientos. Variedad de ópticas,
tamaños y acabados. Gran control gracias a su
patentado grupo óptico.

LIGHT SHADOW

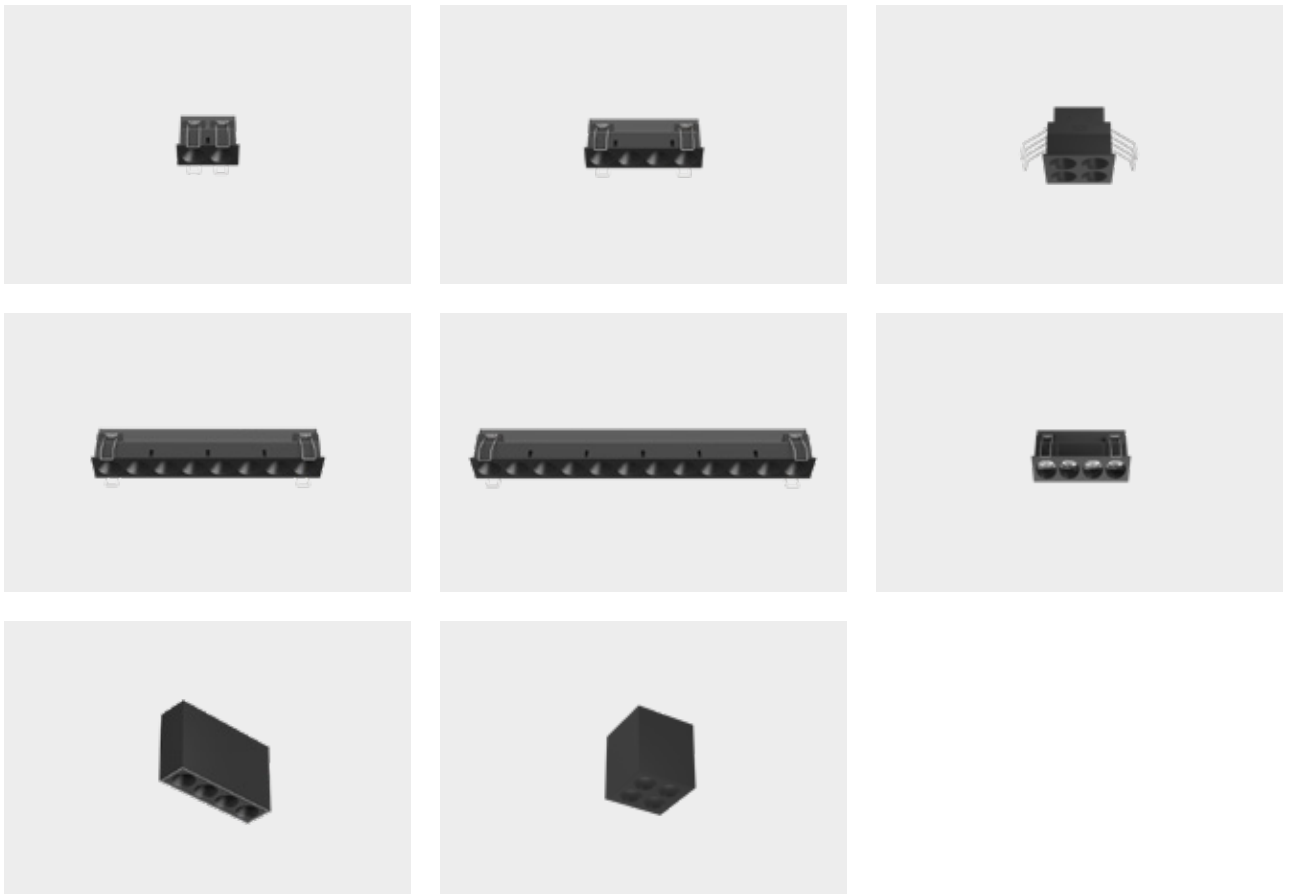





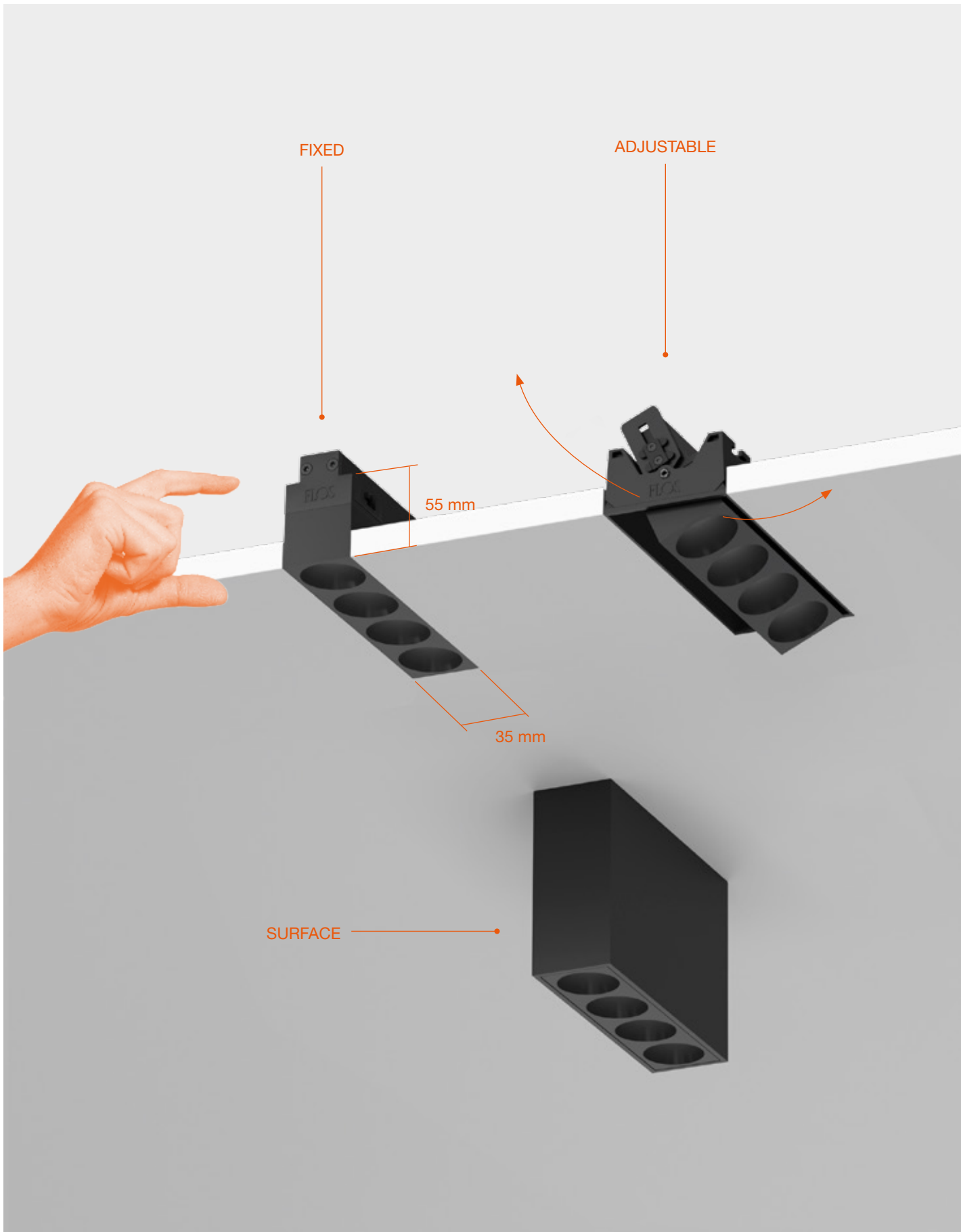

WALL-WASHER

SQUARE

SURFACE
SQUARE

Extra-compact size which allows embedded integration, even when there is minimum space available. The adjustable version allows the main body to be extracted to guarantee perfect integration with the architecture, and to make the most of the whole beam.

Tamaño extra compacto que permite integración empotrada incluso en los casos de mínimo espacio disponible. La versión ajustable permite extraer el cuerpo principal para garantizar una perfecta integración con la arquitectura y aprovechar todo el haz.

TRADITIONAL TECHNOLOGY

The traditional technology produces: a glare effect while the beam of light is not so precise. Integration with architecture is not achieved.

Con la tecnología tradicional se produce un efecto de deslumbramiento a la vez que el haz de luz no es tan preciso. La integración con la arquitectura no está conseguida.

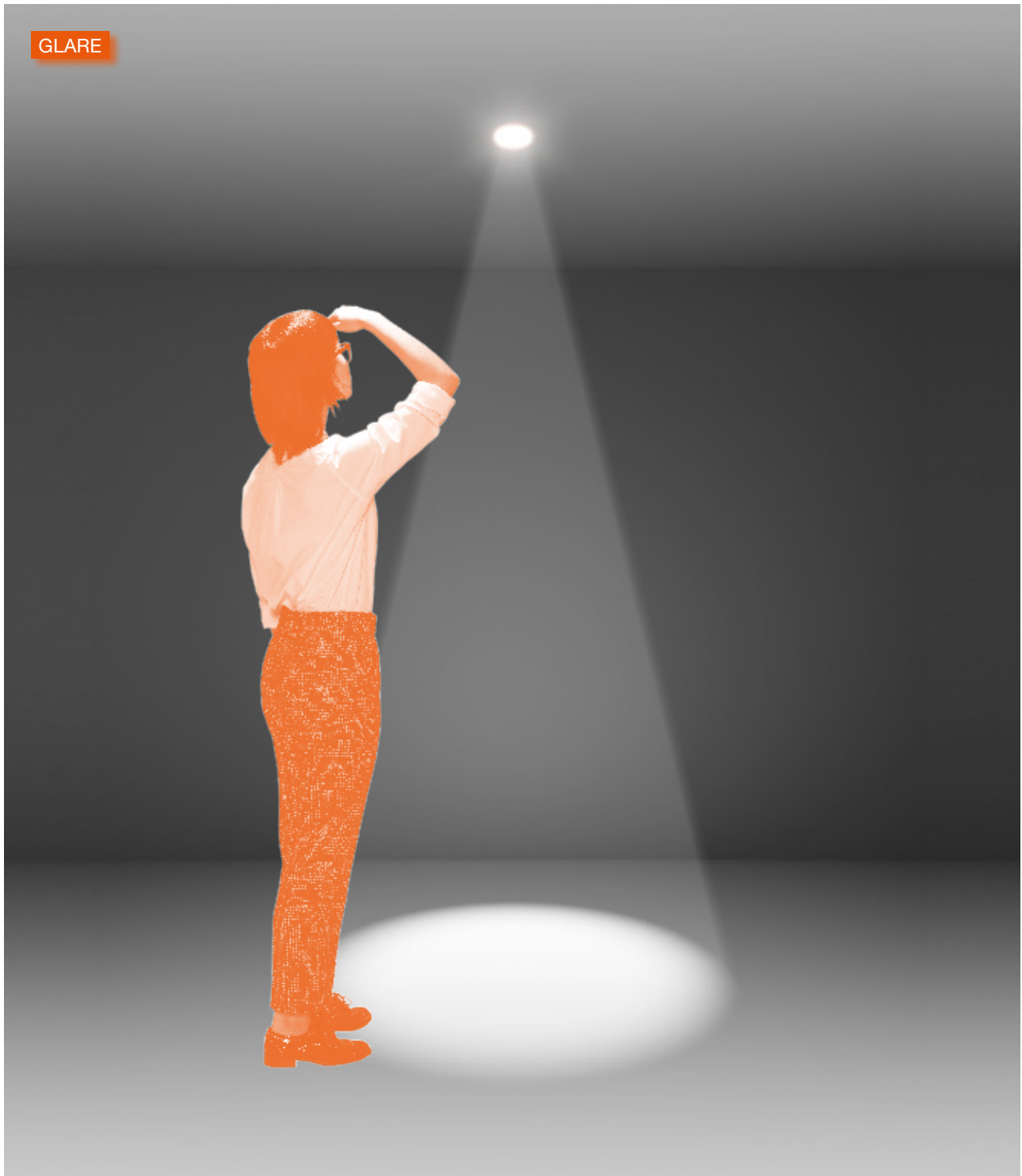

FLOS TECHNOLOGY

Light Shadow technology thanks to its cut off-of 45 degrees, maximum integration with architecture combines with the impeccable, defined beam of light and total shielding, which allows it to be placed almost in zenithally position with no glare.

Con la tecnología del Light Shadow que proporciona un cut-off de 45 grados, la máxima integración con la arquitectura se combina con el haz de luz definido e impecable y un apantallamiento total, lo que permite situarse en casi posición cenital y no ser deslumbrado.

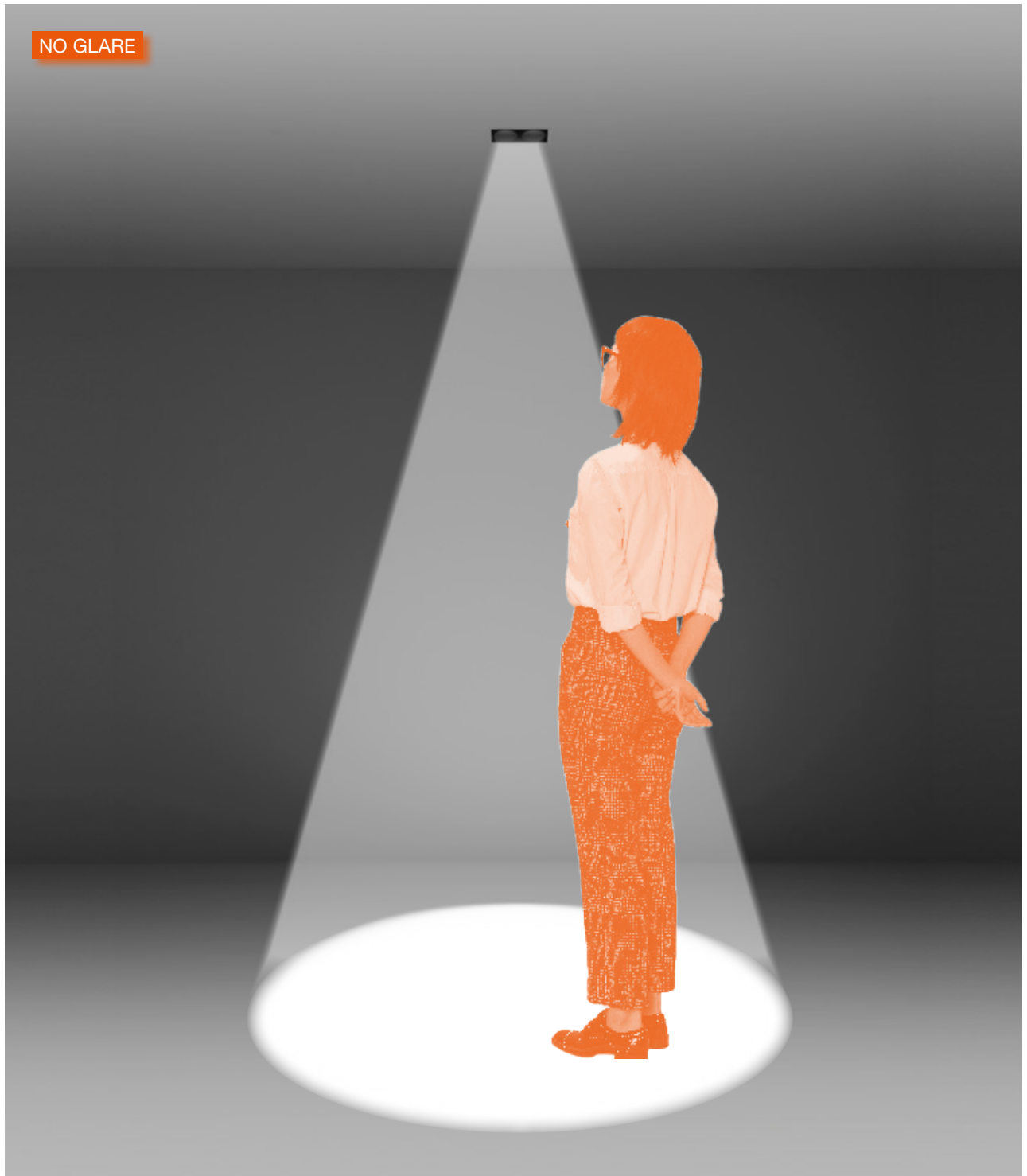

The revolution in low glare lighting. Thanks to its patented unique optical solution, Light Shadow reaches extreme cut-off angles without sacrificing high efficiency and very small dimensions.

La revolución en la iluminación de mínimo deslumbramiento. Gracias a su solución óptica exclusiva patentada, Light Shadow llega a ángulos cut-off extremos sin renunciar a una alta eficiencia y a dimensiones muy reducidas.



1 LED board designed by FLOS with state-of-the-art LED modules. High levels of quality and efficiency. Placa de LED diseñada por FLOS con módulos de LED de última generación. Alta calidad y eficiencia.

2 Lenses developed by FLOS especially for this product, to guarantee maximum control and a uniform beam. Lentes desarrolladas por FLOS específicamente para este producto que garantiza el máximo control y un haz homogéneo.

3 Innovative patented cones system that provides extreme shielding thanks to its inverted curve form. Sistema patentado de innovadores conos que proporcionan un apantallamiento extremo gracias a su forma curva invertida.

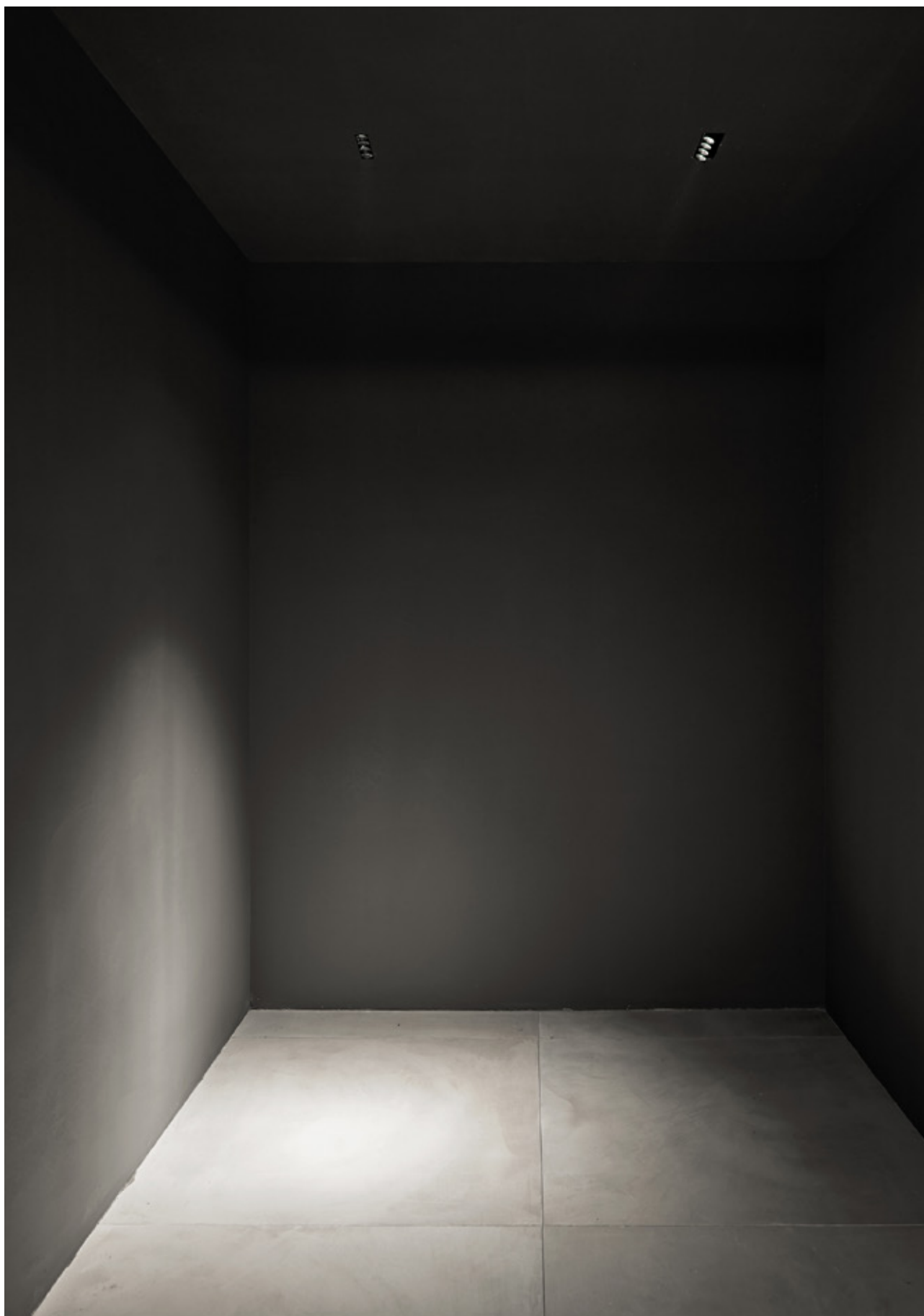



Light Shadow reaches extreme cut-off angles without sacrificing high efficiency and very small dimensions.

Light Shadow llega a ángulos cut-off extremos sin renunciar a una alta eficiencia y a dimensiones muy reducidas.

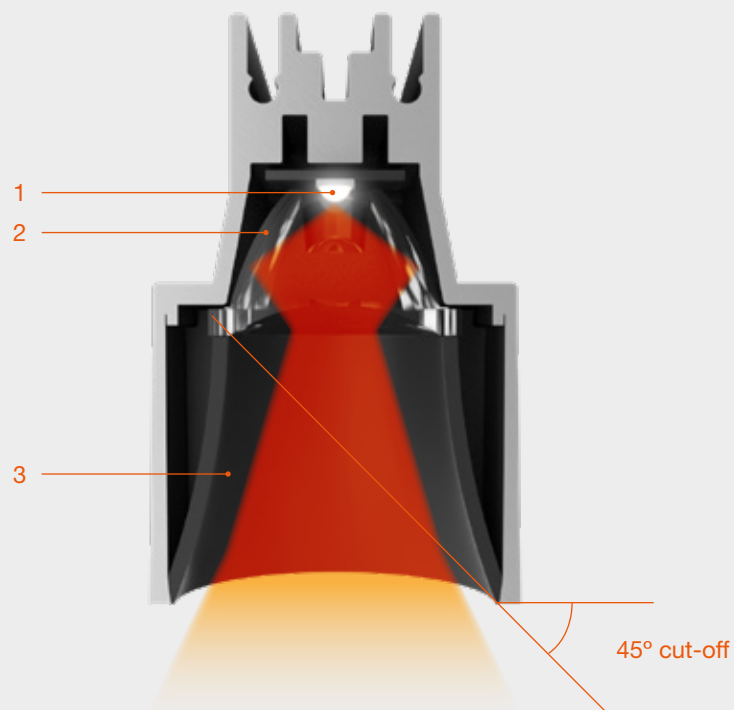

1 Integrated chip board.
Tarjeta chip integrada.

2 Lens.
Lente.

3 Screening cone.
Cono protector.

The excellence of comfort: UGR below 10 for outstanding glare protection, homogeneity in light distribution and delivered lux compliant to the most strict standards of the industry.

La excelencia del confort: UGR inferior a 10 para una protección excelente antideslumbramiento, homogeneidad en la distribución de la luz y número de lux proporcionados ajustado a las normas más exigentes del sector.

PROJECT TYPE

Ambient 20m x 10m, h 2.7m.
Version used: Light shadow 4L Flood Optic Dali dimmable.
Spacing between luminaries: 1.2 m

Technical brightness parameters:
UGR < 10 from any point of observation (UGR < 19 standard minimum value).
Average brightness: 551 lx
(500 lx standard minimum value).
Uniformity obtained: 0.655
(0.600 standard minimum value).
Reference standard:
UNI-EN 12464-1:2011

TIPO DE PROYECTO

Ambiente 20 m x 10 m, h 2,7 m.
Versión utilizada: Light shadow 4L Flood Optic Dali regulable.
Distancia entre dispositivos: 1,2 m

Parámetros luminotécnicos:
UGR < 10 desde cualquier punto de observación (UGR < 19 valor mínimo normativo).
Iluminación media: 551 lx
(500 lx valor mínimo normativo).
Uniformidad obtenida: 0,655
(0,600 valor mínimo normativo).
Norma de referencia:
UNI-EN 12464-1:2011

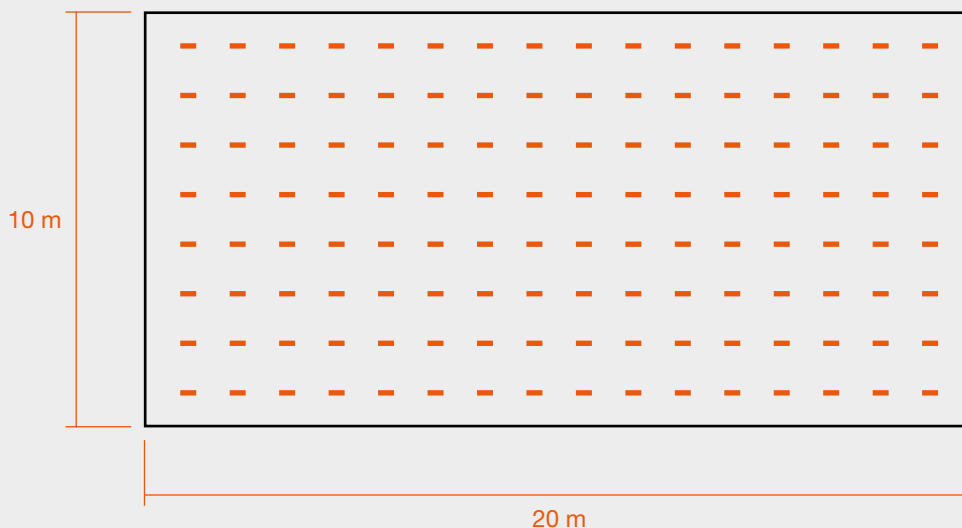

NO GLARE







Light Shadow is also available for magnetic installation in Flos exclusive The Running Magnet track: flexibility and adaptability at any time. See Flos catalogues for complete details about The Running Magnet collection.

Light Shadow también está disponible para su instalación magnética en el exclusivo carril de Flos The Running Magnet: flexibilidad y adaptabilidad en cualquier momento. Consulte los catálogos de Flos, donde podrá obtener todos los detalles sobre la colección The Running Magnet.



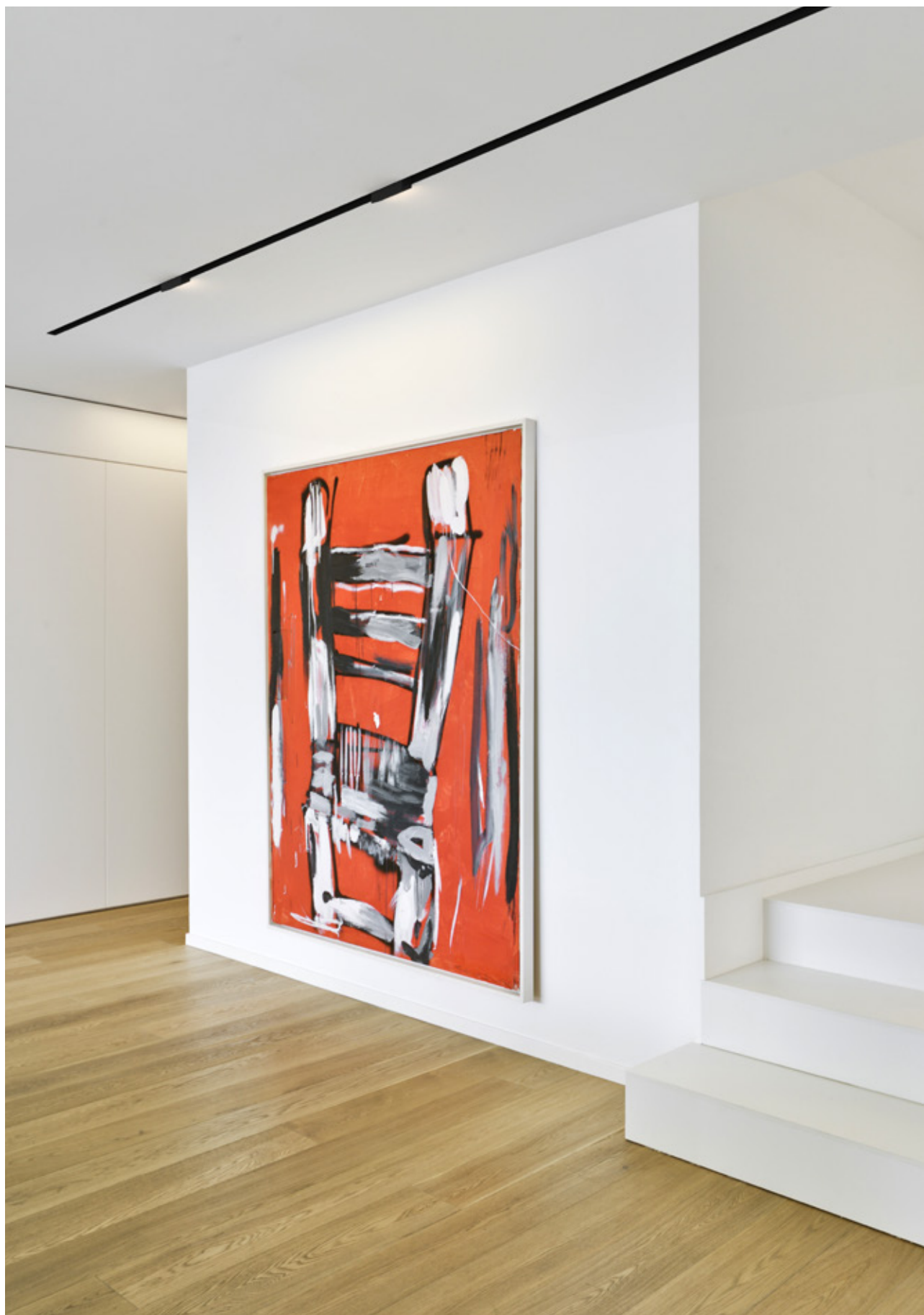

Soft and controlled lighting effect, developed to uniformly light up any vertical plane. The new wall-washer module completes the program with an extremely professional solution that preserves the high visual comfort that characterizes the program.

Efecto de luz suave y controlada, desarrollado para iluminar uniformemente cualquier plano vertical. El nuevo módulo wall-washer completa el programa con una solución extremadamente profesional que mantiene intacta la gran comodidad visual que caracteriza al programa.

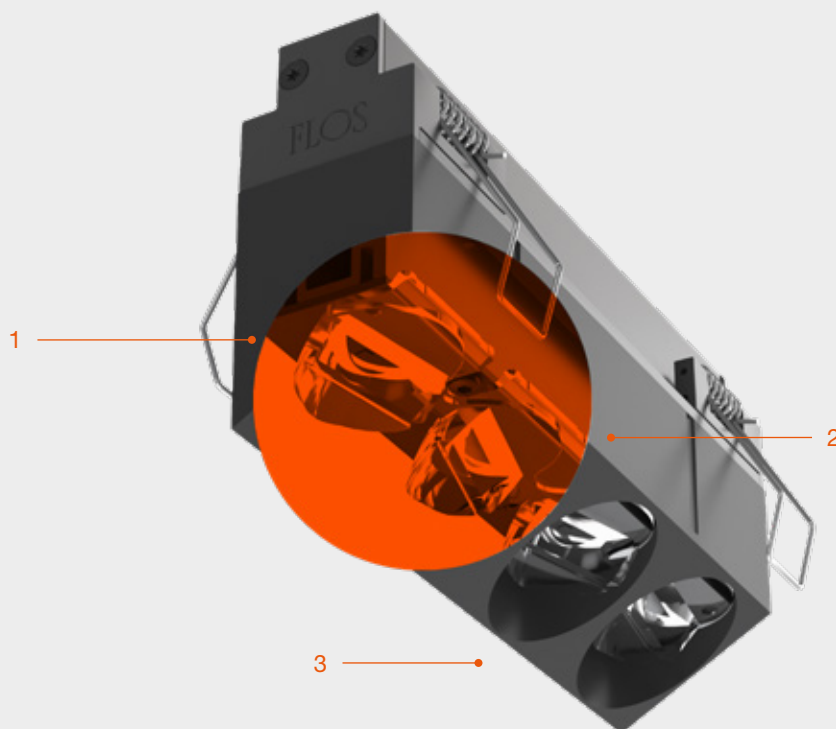

1 Special asymmetric lens, designed for a perfect vertical distribution of the light emission. Lente especial asimétrica diseñada para una perfecta distribución vertical de la emisión luminosa.

2 Individually rotated lenses in order to cover a larger lighting surface and to increase the homogeneity of the light. Lentes rotadas individualmente para cubrir una mayor superficie de iluminación y aumentar la homogeneidad de la luz.

3 Integrated screen that avoids undesirable glare effects. Pantalla integrada para evitar efectos de deslumbramiento no deseados.

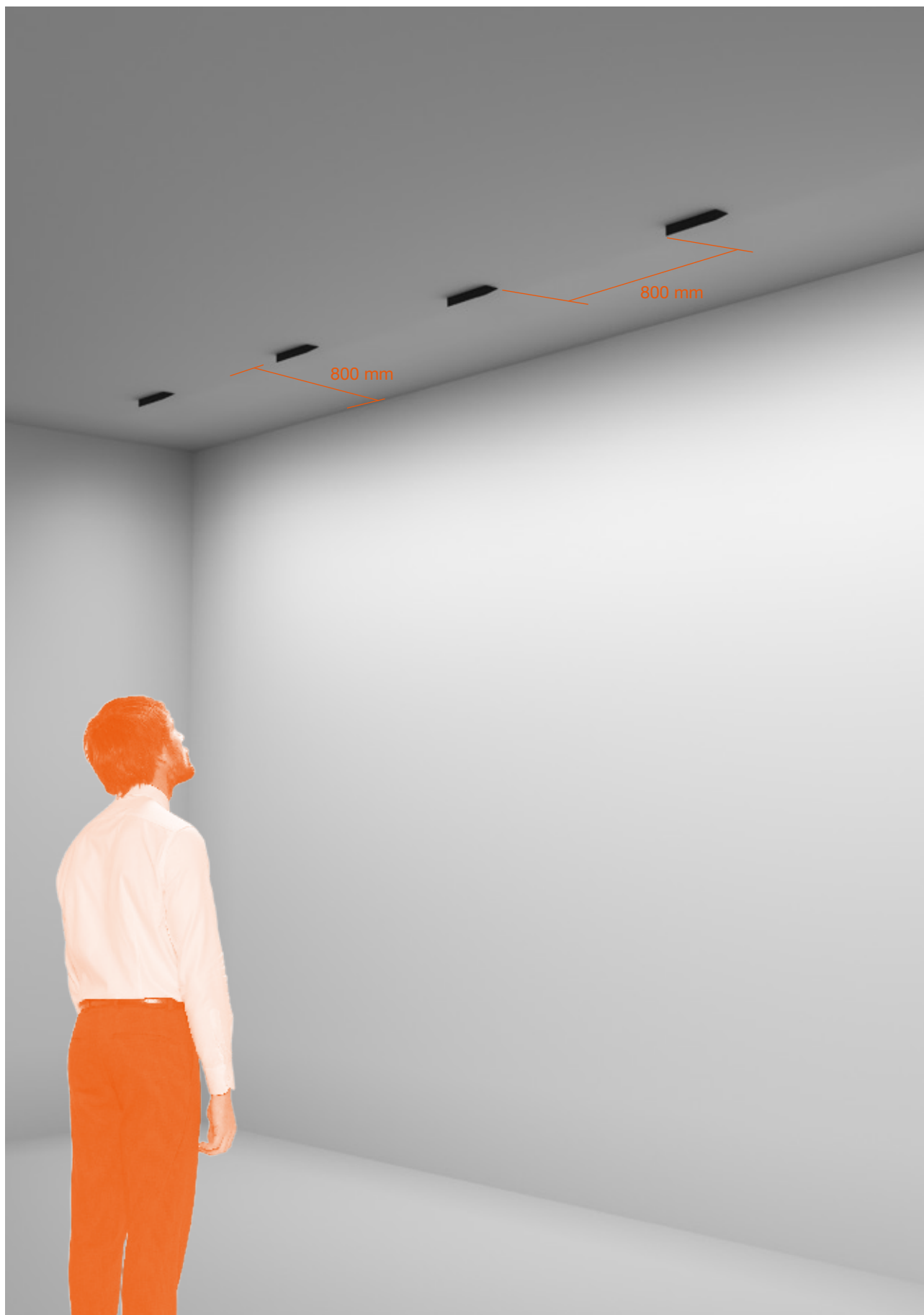

FIXED
TRIM / NO TRIM
2 SPOTS



POWER LED
3,5W x SPOT



FIXED
TRIM / NO TRIM
4 SPOTS



POWER LED
2,7W x SPOT

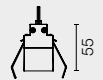
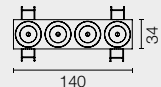
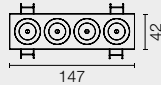

FIXED
TRIM / NO TRIM
4 SPOTS SQUARE



POWER LED
2,7W x SPOT

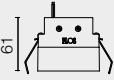
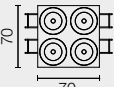
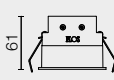
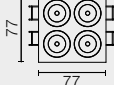

FIXED
TRIM / NO TRIM
8 SPOTS

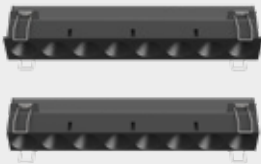

POWER LED
2,7W x SPOT

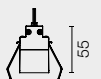
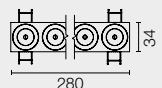
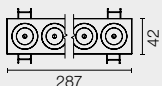

FIXED
TRIM / NO TRIM
12 SPOTS

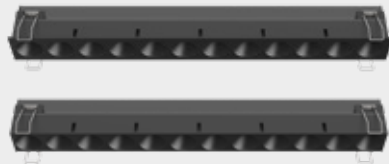

POWER LED
2,7W x SPOT

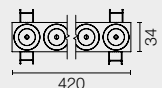
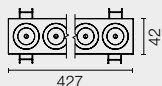

LIGHT SHADOW FIXED / ADJUSTABLE / SURFACE

Internal Finish

White
Blanco



Steel
Acero



HIGH COMFORT

Black
Negro



Bronze
Bronce



External Plate Finish

White
Blanco



Black
Negro



LIGHT SHADOW WALL-WASHER

External Plate Finish

White
Blanco



Black
Negro



LIGHT SHADOW SURFACE

Box Finish

White
Blanco



Black
Negro



Brushed Steel
Acero Cepillado



Brushed Bronze
Bronce Cepillado



Spot



Medium



Flood



Wide Flood



Wall-Washer

ADJUSTABLE TRIM / NO TRIM
2 SPOTS



POWER LED
3,5W x SPOT

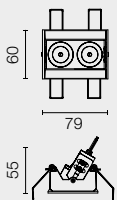
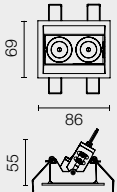

ADJUSTABLE TRIM / NO TRIM
4 SPOTS

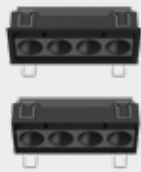

POWER LED
2,7W x SPOT

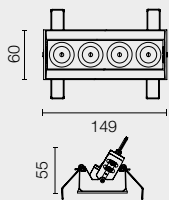
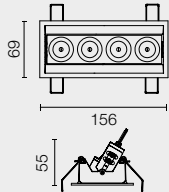

ADJUSTABLE TRIM / NO TRIM
8 SPOTS



POWER LED
2,7W x SPOT

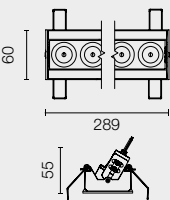
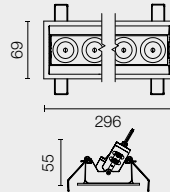

ADJUSTABLE TRIM / NO TRIM
12 SPOTS



POWER LED
2,7W x SPOT

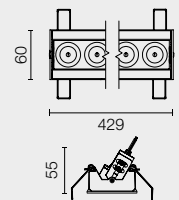
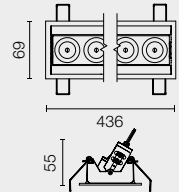

WALL-WASHER TRIM / NO TRIM
4 SPOTS



POWER LED
2,7W x SPOT

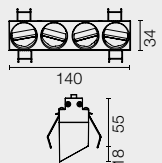
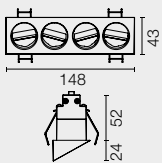

SURFACE 4 SPOTS



POWER LED
2,7W x SPOT

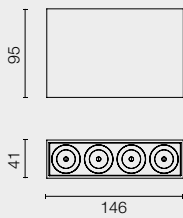

SURFACE SQUARE 4 SPOTS



POWER LED
2,7W x SPOT

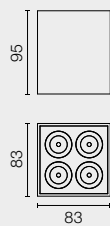

LIGHT SHADOW
*compatible module for
The Running Magnet



POWER LED
2,7W x SPOT

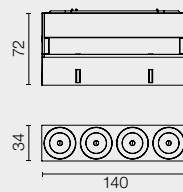

LIGHT SHADOW W-W
*compatible module for
The Running Magnet



POWER LED
2,7W x SPOT

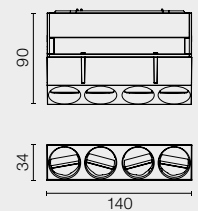

*See compatible modules for The Running Magnet collection /
Ver módulos compatibles para la colección The Running Magnet

LIGHT SHADOW
LIGHT SHADOW
LIGHT SHADOW
LIGHT SHADOW
LIGHT SHADOW
LIGHT SHADOW
LIGHT SHADOW
LIGHT SHADOW

U
O
T
S

O
R
P

LIGHT SHADOW
LIGHT SHADOW
LIGHT SHADOW
LIGHT SHADOW
LIGHT SHADOW

Revolutionary downlights program developed to control glare in countless applications. The unique patented optical system has been applied to multiple custom-made beamwidths for specific applications such as offices, shops and homes.

Revolucionario programa de downlights desarrollado para controlar el deslumbramiento en innumerables aplicaciones. El exclusivo sistema óptico patentado ha sido aplicado en múltiples aberturas de haz hechas a medida para aplicaciones específicas como oficinas, tiendas y entornos domésticos.

LIGHT SHADOW DOTS & PRO







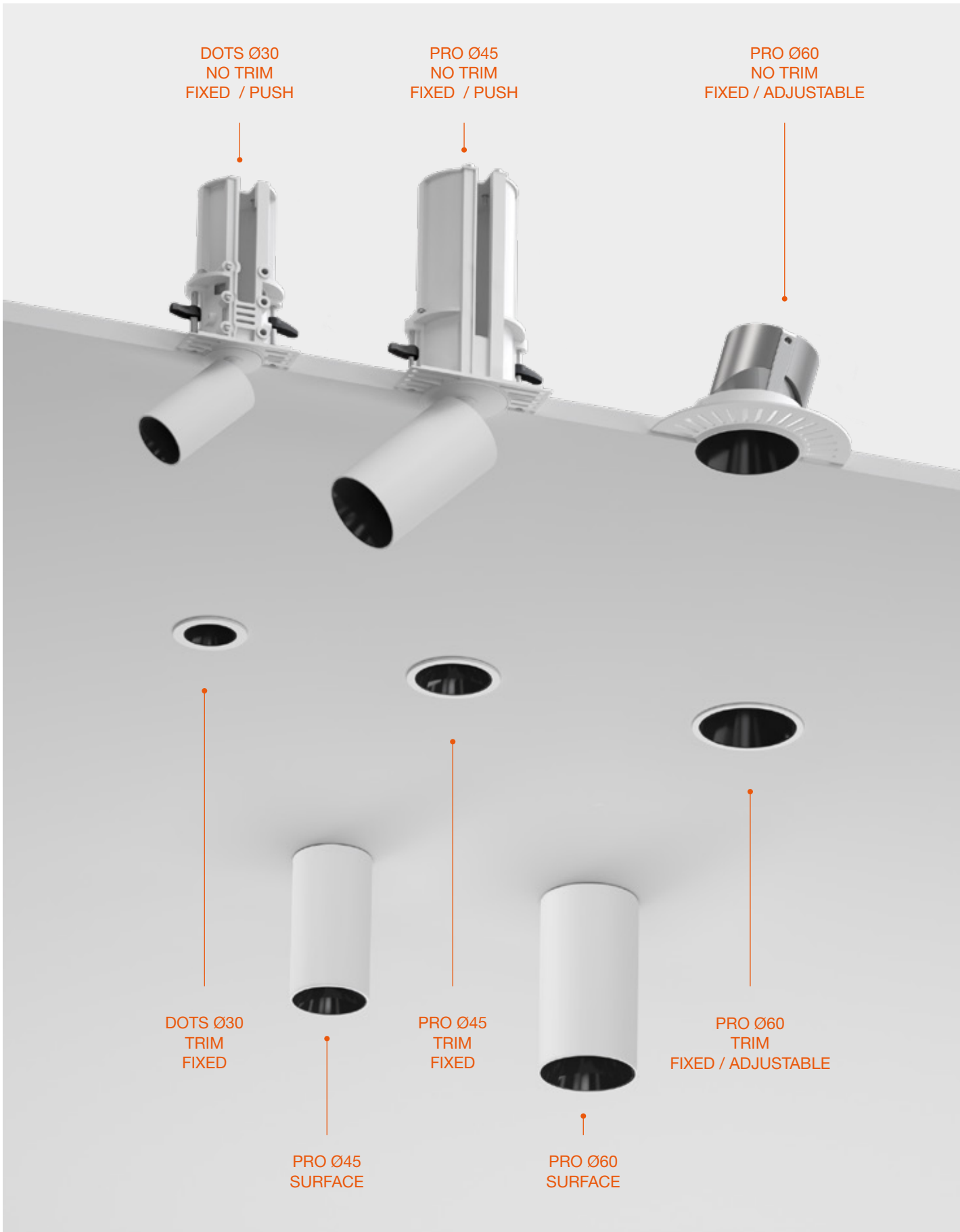

PRO Ø90
NO TRIM
FIXED / ADJUSTABLE

PRO Ø90
NO TRIM
WALL-WASHER



PRO Ø90
TRIM
FIXED / ADJUSTABLE

PRO Ø90
TRIM
WALL-WASHER

A completely new approach to architectural lighting. It takes glare control to the next level. Optical efficiency values are extremely high thanks to the use of the latest generation technologies and the light quality reaches even higher and more refined standards.

Un enfoque completamente nuevo en iluminación arquitectónica. Lleva el control del deslumbramiento a un nivel extremo donde los valores de eficiencia óptica son extremadamente altos gracias al uso de tecnologías de última generación y la calidad de la luz alcanza estándares aún más altos y refinados.

LIGHT SHADOW DOTS

The smallest downlight in the range. A 30 mm diameter and an extremely reduced recess depth are combined with a complex optical system that provides extreme shielding of the source thanks to the inverted shape of the cut-off cones that characterize it.

El downlight más pequeño del programa. Un diámetro de 30 mm y una profundidad de empotrado extremadamente reducida se combinan con un complejo sistema óptico que proporciona un apantallamiento extremo de la fuente gracias a la forma invertida de los conos de cut-off que la caracterizan.



1 Light Shadow Dots Fixed.
2 Light Shadow Dots Push.



1

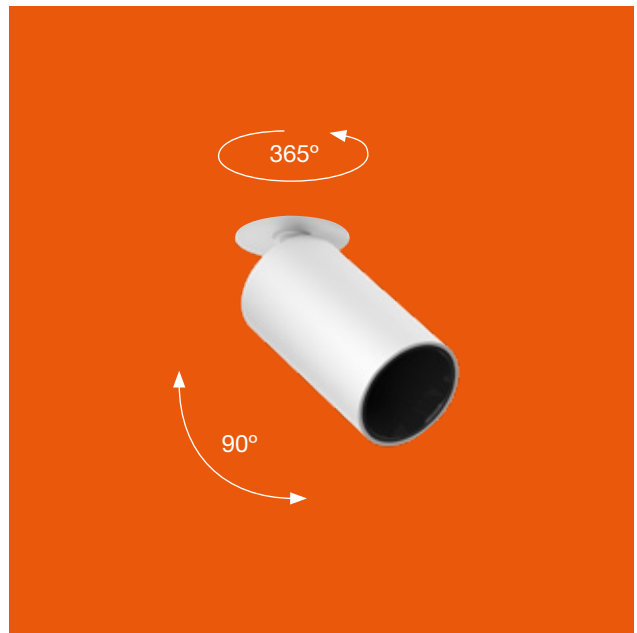

2

LIGHT SHADOW PRO

The natural evolution from the Light Shadow Dots. The new Pro versions are the result of careful optical research. They offer extremely high effectiveness despite their small size and compact body.

La evolución natural de Light Shadow Dots. Las nuevas versiones Pro son el resultado de una cuidadosa investigación óptica. Ofrecen una efectividad extremadamente alta a pesar de su pequeño tamaño y cuerpo compacto.



3 Light Shadow 90 Wall Washer.
4 Light Shadow 90 Adjustable.



3



4

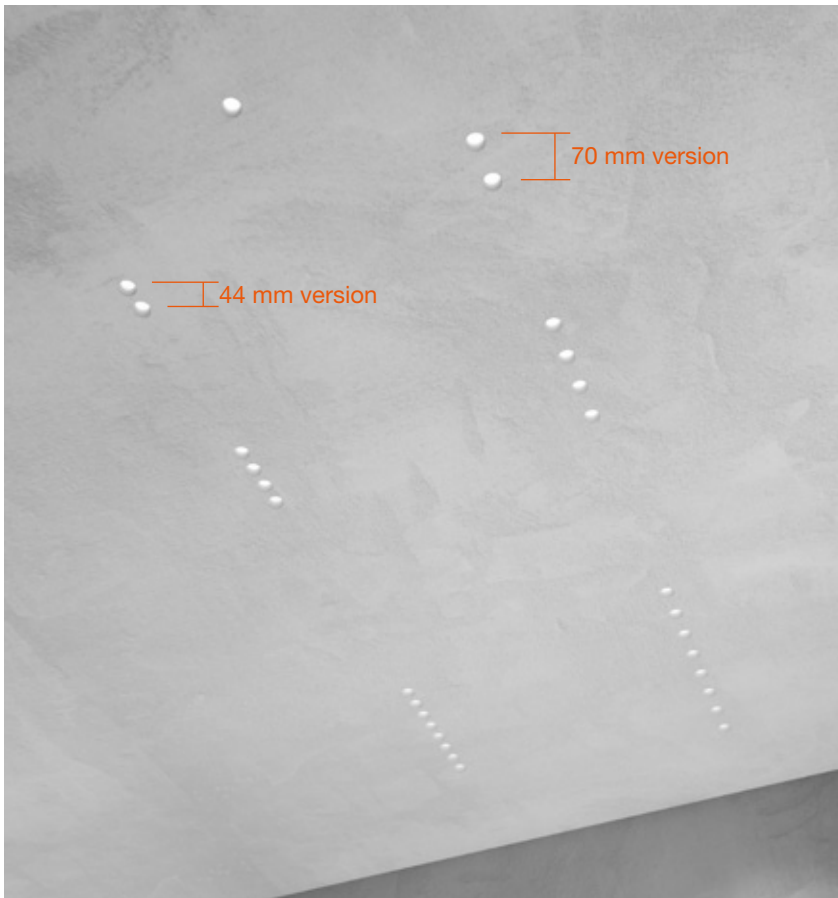

Light Shadow Dots is available in TRIM and NO TRIM versions. The frameless option allows perfect integration into plaster ceilings, resulting in a luminaire that is completely flush and integrated into the ceiling. In addition, it is possible to arrange it in modular in-line presentations, with two options of spacing between the points.

Light Shadow Dots está disponible en versión TRIM y NO TRIM. La opción sin marco permite una integración perfecta en techos de escayola; el resultado es una luminaria completamente enrasada e integrada en el techo. Además, es posible disponerla en presentaciones modulares en línea, con dos opciones de interdistancia entre los puntos.



Light Shadow Dots Fixed and Push No Trim pre-installation frames are compatible and can be installed continuously, maintaining the spacing. In this way, when the Push models are in recessed position, they are indistinguishable from the Fixed versions.

Los premarcos No Trim de Light Shadow Dots Fixed y Push son compatibles y se pueden instalar de manera continua, manteniendo la interdistancia. De este modo, cuando los modelos Push están en posición empotrada, son indistinguibles de las versiones Fixed.



Restaurant Het Vliegend
Tapijt, Belgium





Light Shadow Pro exploits the benefits of an innovative silicone lens that allows absolute beam control with an extreme efficiency, heat resistance and maximum quality light distribution.

Light Shadow aprovecha los beneficios de una innovadora lente de silicona que permite un control extremo del haz además de proporcionar una eficiencia absoluta, resistencia al calor y máxima calidad en la distribución de la luz.



FLOS TECHNOLOGY

The available optical kit includes 5 different beamwidths. Each one of them is developed for a specific application. The optical control is always exceptional and the stray light is totally absent whether for intensive beams or diffuse lighting effects.

El kit óptico disponible incluye 5 aberturas de haz diferenciadas, cada una desarrollada para una aplicación especial. Tanto si se trata de haces intensivos o efectos de luz difusa, el control óptico siempre es excepcional y la luz espuria está totalmente ausente.







Thanks to the unique patented optical solution, Light Shadow Pro controls extreme cut-off angles without altering the high efficiency and incredible versatility of the product.

Gracias a la exclusiva solución óptica patentada, Light Shadow Pro controla ángulos de cut-off extremos, sin sacrificar la alta eficiencia y la increíble versatilidad del producto.

UGR<10

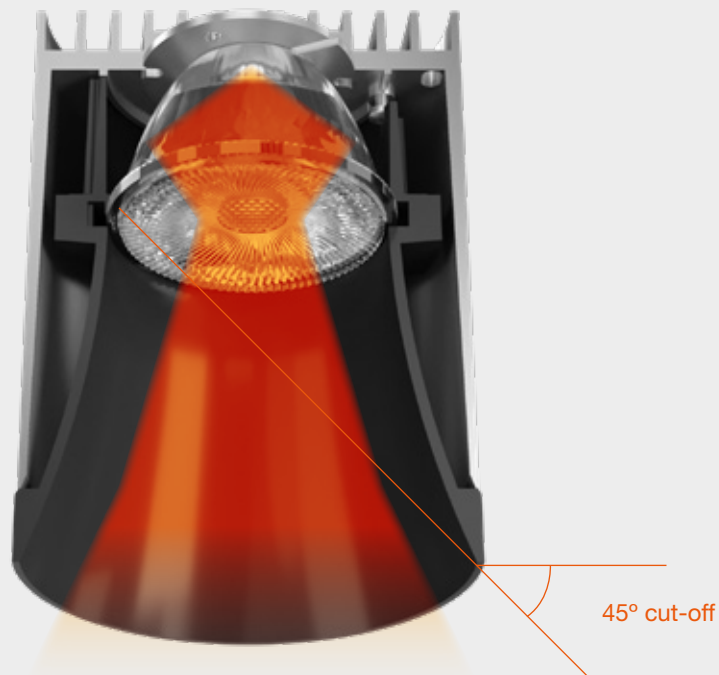

Dual-focus lens developed by FLOS specifically for this product. It ensures maximum optical control and exceptional light beam homogeneity.

Lente de doble foco desarrollada por FLOS específicamente para este producto. Garantiza el máximo control óptico y una homogeneidad excepcional del haz de luz.

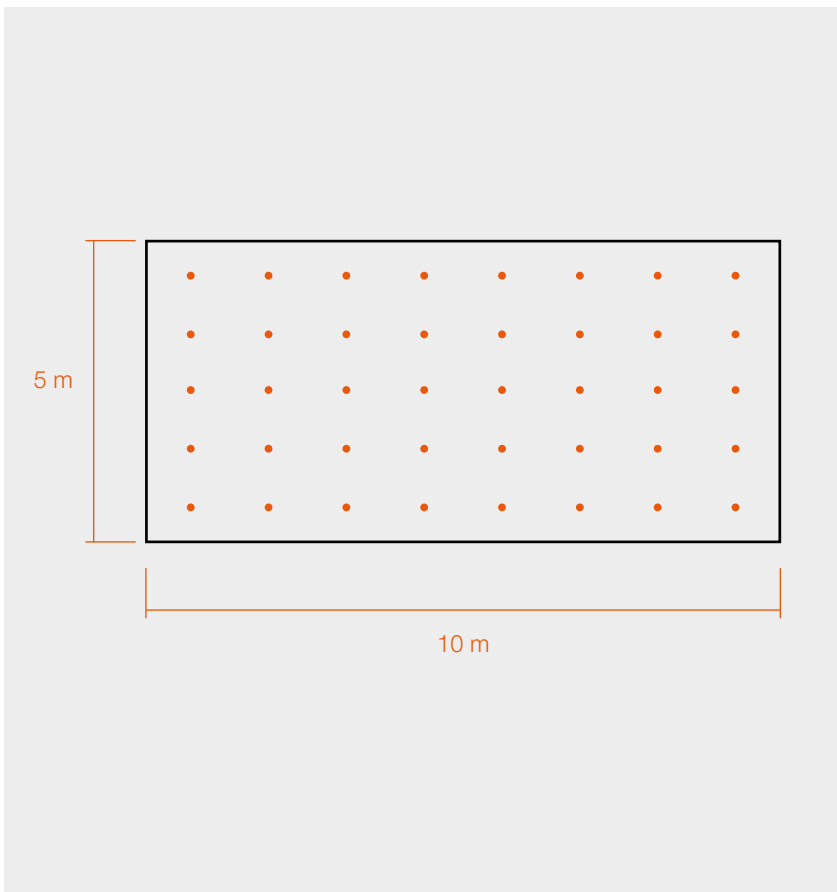
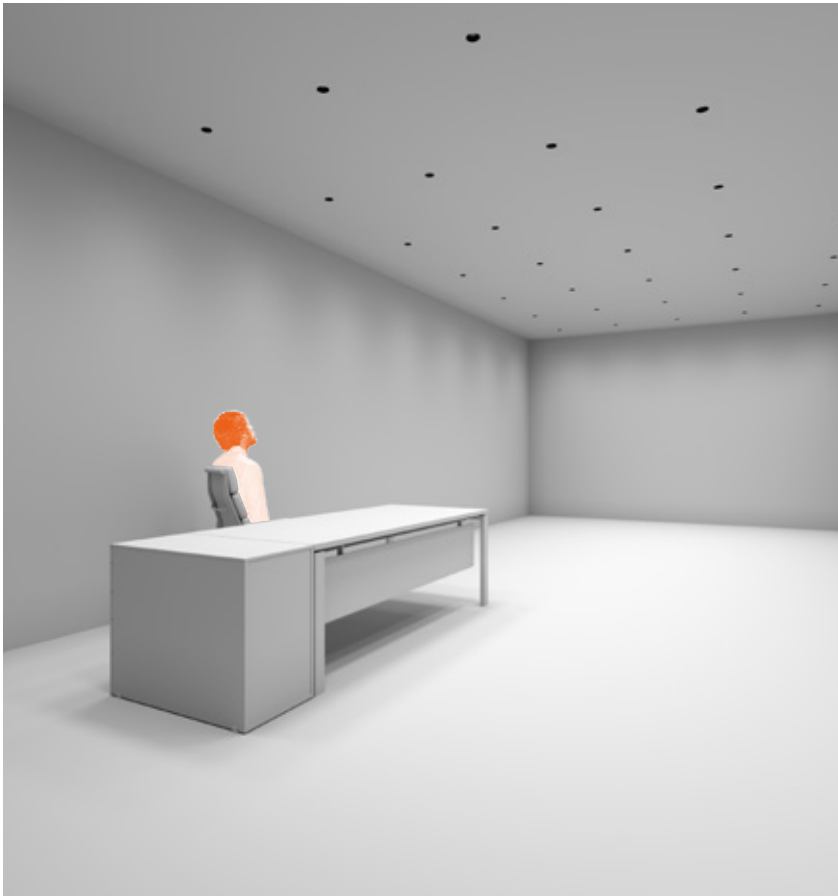

PROJECT TYPE

Ambient 5 m x 10 m, h 3 m.
Version used: Light shadow PRO 60
Flood Optic.
Spacing between luminaries: 1.2 m

Technical brightness parameters:
UGR < 10 from any point of observation
(UGR < 19 standard minimum value).
Average brightness: 1045 lx

Uniformity obtained: 0.68
(0.600 standard minimum value).
Reference standard:

UNI-EN 12464-1:2011

TIPO DE PROYECTO

Ambiente 5 m x 10 m, h 3 m.
Versión utilizada: Light shadow PRO 60
Óptica Flood.
Distancia entre dispositivos: 1,2 m

Parámetros luminotécnicos:
UGR < 10 desde cualquier punto de obser-
vación (UGR < 19 valor mínimo normativo).
Iluminación media: 1045 lx
Uniformidad obtenida: 0,68

(0,600 valor mínimo normativo).
Norma de referencia:

UNI-EN 12464-1:2011







	Different control options for dimming LIGHT SHADOW DOTS & PRO, all available for remote recessed or surface installation.	Diferentes opciones de control para la regulación de LIGHT SHADOW DOTS & PRO, todas disponibles para una instalación empotrada o de superficie.
PUSH DIMMING	Control through a simple pushbutton.	Control a través de un dispositivo de regulación.
DALI	Standard protocol for integration with any control system.	Protocolo standard para la integración con cualquier sistema de control.
1-10V	Broadcasting remote control (dimming of all the luminaires in a single group).	Control remoto en broadcasting (dimado de todas las luminarias en grupo).
CASAMBI	Broadcast control through a tablet or smartphone application (FLOS Control®).	Control broadcast a través de una aplicación para tablet o smartphone (FLOS Control®).



DOTS Ø30
FIXED



POWER LED
UP to 2,7W

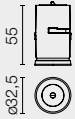

PRO Ø45
FIXED



LED ARRAY
8,5W

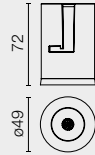

PRO Ø60
FIXED



LED ARRAY
UP to 15W

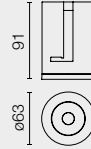

PRO Ø90
FIXED



LED ARRAY
UP to 22W

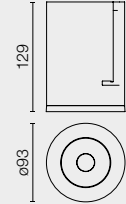

DOTS Ø30
PUSH



POWER LED
UP to 2,7W

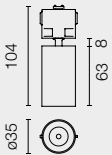

PRO Ø45
PUSH



LED ARRAY
8,5W

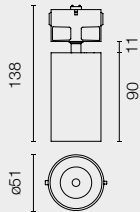

PRO Ø60
ADJUSTABLE



LED ARRAY
10,5W

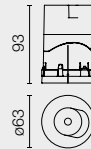

PRO Ø90
ADJUSTABLE



LED ARRAY
UP to 18W

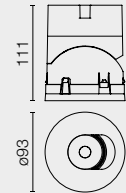

PRO Ø45
SURFACE



LED ARRAY
11W

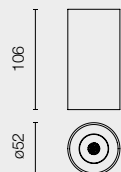

PRO Ø60
SURFACE



LED ARRAY
15W



PRO Ø90
WALL-WASHER



LED ARRAY
18W

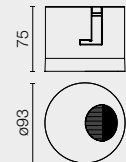

Rear Finish

Light Shadow Pro&Dots Push

40 White
40 Blanco

14 Black
14 Negro



External Finish

Light Shadow Dots Push / Light Shadow Pro Push & Surface

40 White
40 Blanco

14 Black
14 Negro

ER Brushed Steel
ER Acero Cepillado

ES Brushed Bronze
ES Bronce Cepillado



Internal Finish

40 White
40 Blanco

14 Black
14 Negro

ER Steel
ER Acero

ES Bronze
ES Bronce



HIGH COMFORT



Super Spot



Spot



Medium



Flood



Wide Flood



Wall-Washer

ECLECTIC

ECLEC

E

TIC

CLEC

ECLECTIC

Recessed in ceiling, indoor luminaire. A product with a modular concept that follows the principles of circular design and economy. Marketed as a complete luminaire, it can be broken down into modules that define its features. These modules are also offered as spare parts.

Luminaria de interior, empotrable en techo. Producto de concepto modular, según principios de diseño y economía circulares. Comercializado como luminaria completa, se descompone en módulos que definen sus características. Estos módulos se ofrecen también como repuestos / recambios.

ECLECTIC

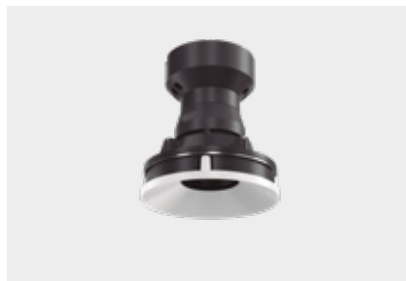
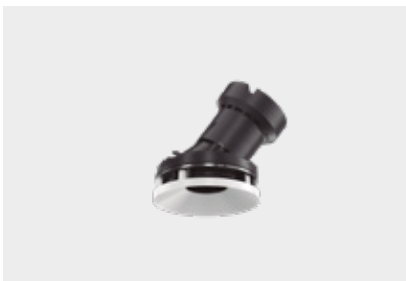
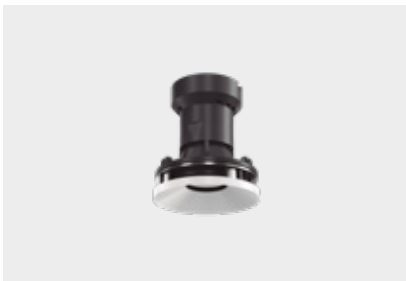

The Eclectic range comprises two sizes (Ø70 and Ø90) for which two models are available (fixed and adjustable). Two installation pre-frames (Trim and No Trim) and 3 style modules (Cone Flat and Soft) are available.

La gama de Eclectic la componen dos tallas (Ø70 y Ø90) que, a su vez, tienen dos modelos (Fijo y Orientable). Se ofrece con dos tipos de pre-marcos de instalación (Trim y No Trim) y 3 estéticas frontales (Cone Flat y Soft).

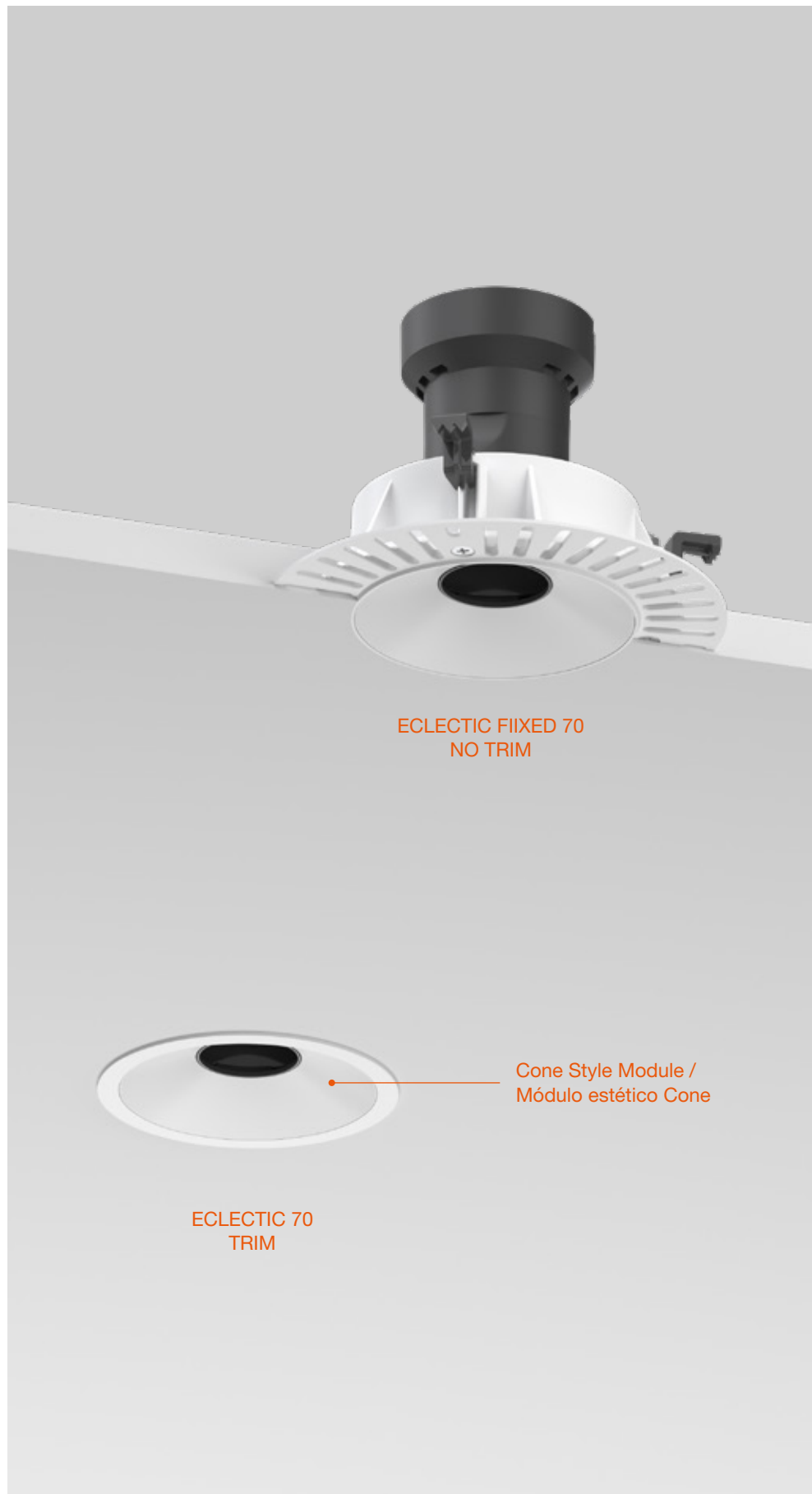

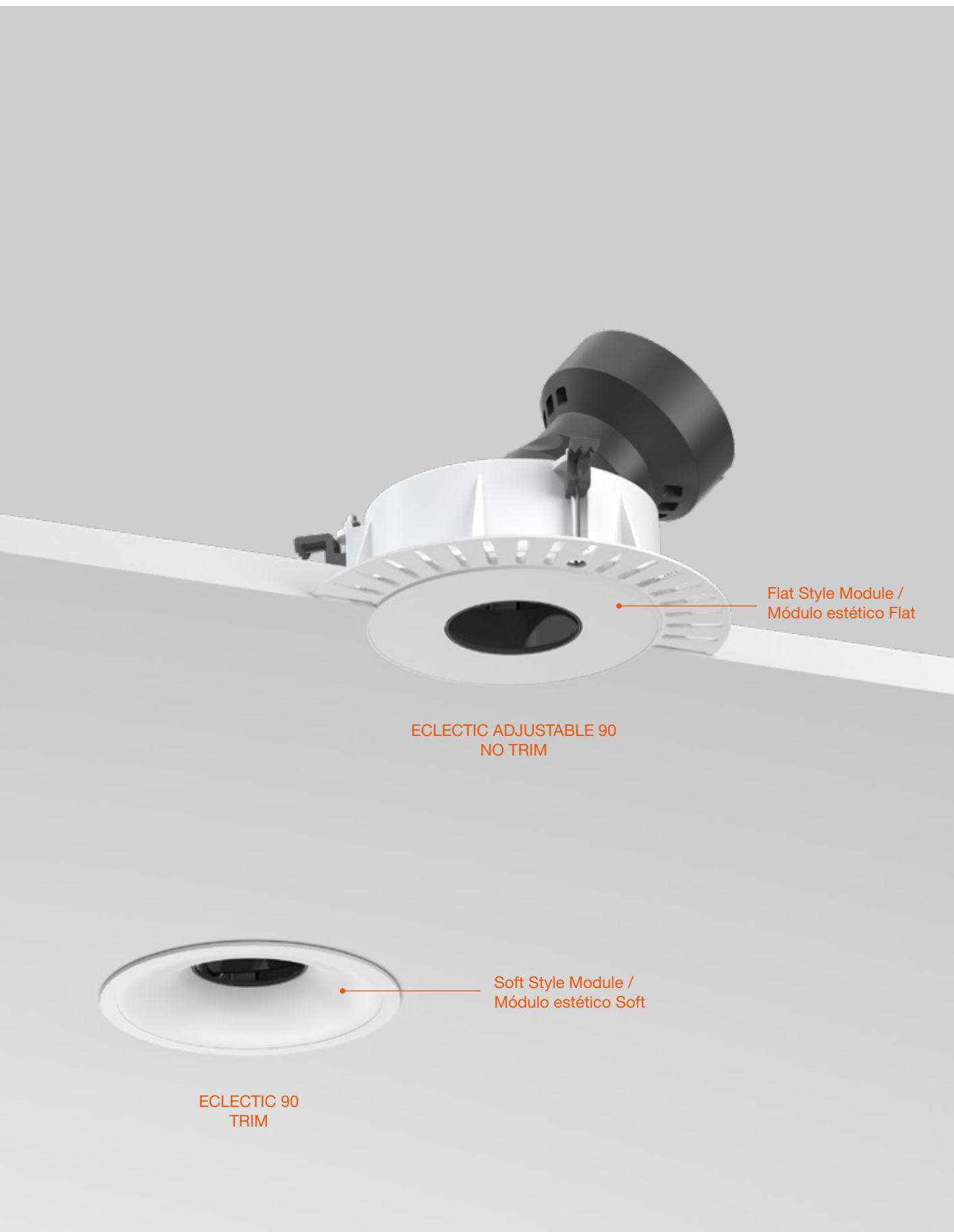







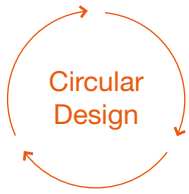

There are six modules and/or accessories available, marketed as individual products. Tool-free installation and replacement. Maximum versatility and modification possibilities, even after the product has been installed.

Seis módulos y/o accesorios disponibles, comercializados como artículos independientes. Montaje y sustitución sin herramientas. Máxima versatilidad y posibilidades de cambio, incluso después de la instalación del producto.



1 Installation pre-frames.
Premarcos de instalación
(Trim / no Trim).
2 Light engine.
Motor de luz.

3 Lenses.
Lentes.
4 Accessories.
Accesorios.

5. Orientation module
(fixed / adjustable).
Módulo de orientabilidad
(Fijo / Ajustable).
6. Style modules.
Módulos estéticos.

Modular "future-proof" design:
obsolescence-proof.

Diseño modular «future-proof»: a prueba de
obsolescencia.

1 La configuración inicial de Eclectic no limita al producto en sus características, gracias a las posibilidades de modificación y adaptabilidad de su concepto de diseño. Desde la estética, hasta la orientación o la apertura del haz, todo es susceptible de ser modificado para responder a nuevas necesidades.

1 La configuración inicial de Eclectic no limita al producto en sus características, gracias a las posibilidades de modificación y adaptabilidad de su concepto de diseño. Desde la estética, hasta la orientación o la apertura del haz, todo es susceptible de ser modificado para responder a nuevas necesidades.



1 All product parts are replaceable.
1 Todas la partes del producto son reemplazables.

Complete range of beam angles.

Completa oferta de aperturas de haz de luz.

2 Eclectic offers a variety of beam angles ranging from Super Spot to Wide Flood to meet any lighting specifier's needs.

2 Eclectic ofrece una variedad de aperturas que van desde Super Spot hasta Wide Flood para dar respuesta a cualquier necesidad de los especificadores lumínicos.

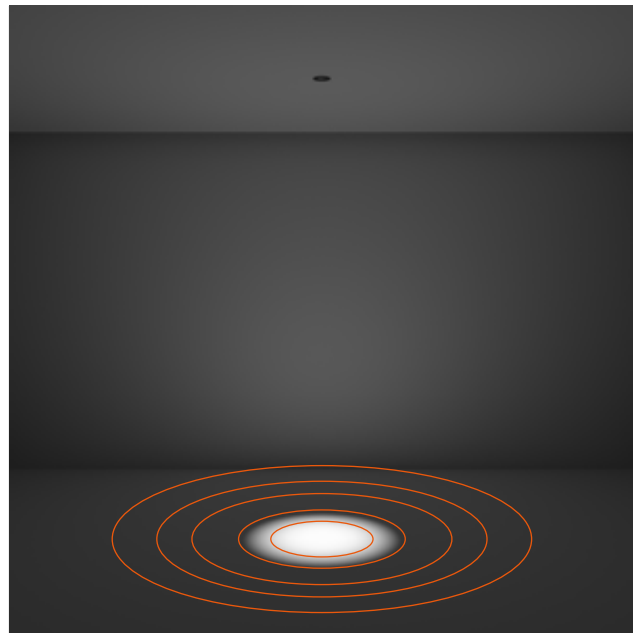

2 Five light beam angles available.
2 Disponibles 5 aperturas de haz de luz.

Magnetic installation and assembly.

Instalación y ensamblaje magnético.

3 Eclectic attaches to its installation pre-frames thanks to a high quality magnetic attachment system that has been tested and subjected to the most demanding stress, load and durability tests. This magnetic fixing, which is also the way the style façades are attached, facilitates the handling of the product for modification, replacement and upgrading.

3 Eclectic se acopla en sus pre-marcos de instalación gracias a un sistema de unión magnético de alta calidad que ha sido ensayado y sometido a las más exigentes pruebas de estrés, carga y duración. Esta sujeción magnética, que también es la forma de unión de los frontales estéticos, favorece la manipulación del producto para su modificación, sustitución y actualización.

One product, three different styles.

Un sólo producto, tres estéticas diferentes.

4 Renewing the appearance of Eclectic is as easy as replacing its style module with a new one, choosing among its three alternatives (Cone, Soft and Flat). In addition, in the No Trim versions, we can even change the finish of the luminaire (from black to white or vice versa), by simply replacing this part with its spare module in a different color.

4 Renovar la apariencia de Eclectic es tan fácil como sustituir su módulo estético por uno nuevo, que se puede elegir entre sus tres alternativas (Cone, Soft y Flat). Además, en las versiones No Trim, incluso podemos variar el acabado de la luminaria (de negro a blanco -o viceversa-), con solo reemplazar esta pieza por su módulo de repuesto de diferente color.



3 Magnetically attached for easy changeover and installation.
3 Fijación magnética para facilitar la instalación y las modificaciones.



4 Interchangeable style. Cone, Soft & Flat.
4 Estética intercambiable. Cone, Soft & Flat.

Thanks to the unique patented optical solution, Eclectic controls extreme cut-off angles without altering the high efficiency and incredible versatility of the product.

Gracias a la exclusiva solución óptica patentada, Eclectic controla ángulos de cut-off extremos, sin sacrificar la alta eficiencia y la increíble versatilidad del producto.

UGR<10

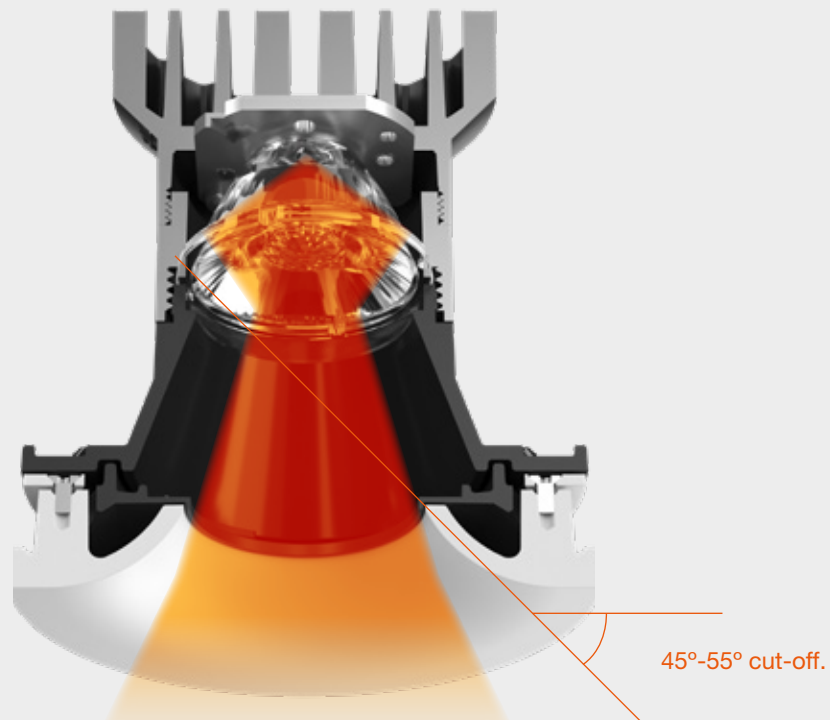

Dual-focus lens developed by FLOS specifically for this product. It ensures maximum optical control and exceptional light beam homogeneity.

Lente de doble foco desarrollada por FLOS específicamente para este producto. Garantiza el máximo control óptico y una homogeneidad excepcional del haz de luz.

LIGHT INTENSITY AND
TEMPERATURE, SWEETLY
SYNCHRONISED

Eclectic has a Dim to Warm dimming option, which links the intensity to the change in the colour of the light. Thus, the higher the flux, the cooler the light and the lower the light, the warmer. Versatility for soft and pleasant lighting.

INTENSIDAD Y TEMPERATURA
DE LUZ, DULCEMENTE
SINCRONIZADOS

Eclectic cuenta con opción de regulación Dim to Warm, que vincula la intensidad con el cambio del color de la luz. Así, a mayor flujo la luz es más fría y, a menor luz, más cálida. Versatilidad para una iluminación suave y agradable.

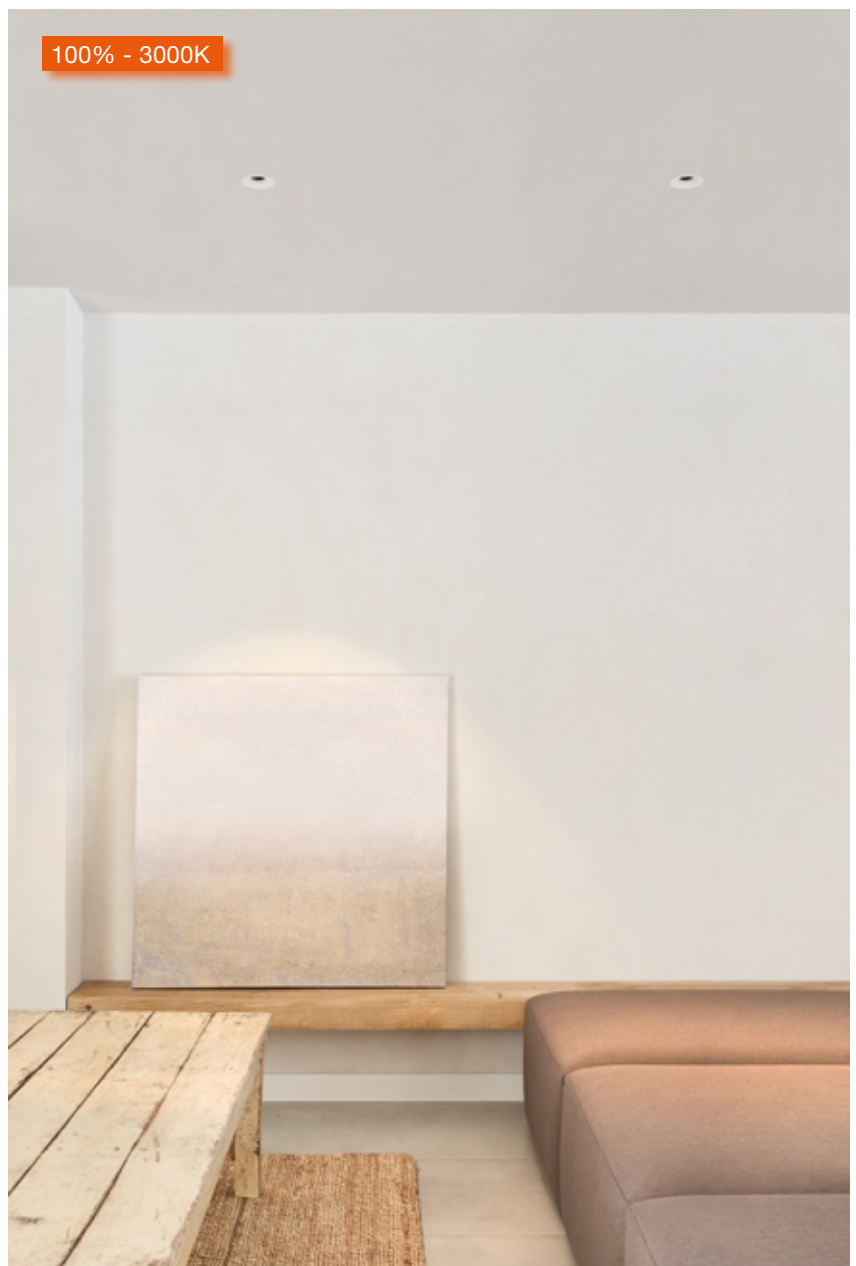
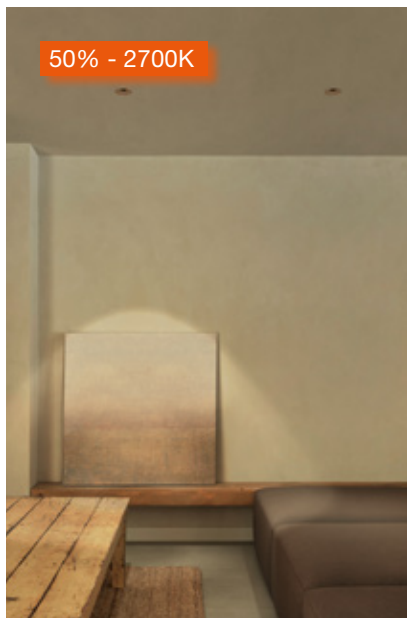
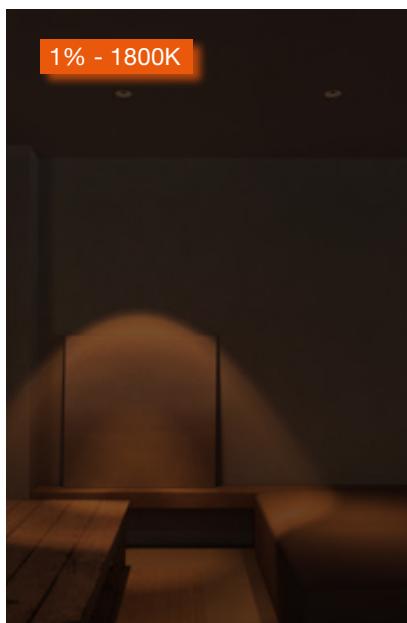

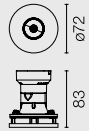
FIXED 70
TRIM / NO TRIMADJUSTABLE 70
TRIM / NO TRIM

LED ARRAY
7,5W

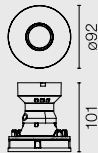
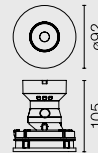
FIXED 90
TRIM / NO TRIMADJUSTABLE 90
TRIM / NO TRIM

LED ARRAY
10,5W

POWER LED
7W

LED ARRAY
DIM TO WARM
13W

The product pictures above represent Eclectic equipped with a Cone Style module, but you can refer to the options below to select the style you prefer to match your project.

Las imágenes superiores del producto muestran Eclectic equipado con un módulo estético 'Cone', pero puede consultar las opciones a continuación para elegir el estilo que mejor se adapta a su proyecto.

Cone



White
Blanco

Black
Negro

Flat



White
Blanco

Black
Negro

Soft



White
Blanco

Black
Negro

Can be rotated 360° and swivelled 35° for Ø70 version and 40° for Ø90 version.
Puede ser rotado 360° y orientado 35° para la versión Ø70 y 40° para versión Ø90.

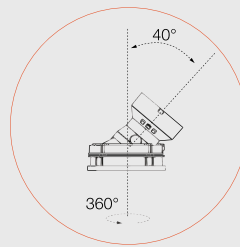
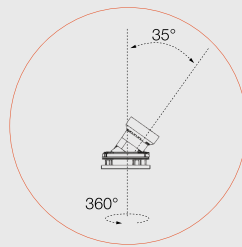

Super Spot



Spot



Medium



Flood



Wide Flood

FLOS
CONTROL BY CASAMBI



LIGHT SHADOW

S P O T

LIGHT SHADOW

S P O T

LIGHT SHADOW

S P O T

LIGHT SHADOW

S P O T

LIGHT SHADOW

S P O T

Light Shadow's optical system -with its dual-focus lens- is extended to this family of projectors to offer its exclusive and patented by Flos technology in this lighting fixture. A collection of spotlights in three sizes that are implemented in different systems, from standard three-phase tracks to Flos' own structures (The Tracking Magnet, The Running Magnet and Infra-Structure).

El sistema óptico de Light Shadow -con su lente de doble focal- se extiende a esta familia de proyectores para ofrecer su tecnología -exclusiva y patentada por Flos- en esta aplicación lumínica. Una colección de focos en tres tallas que se implementan en diferentes sistemas, desde carriles trifásicos estándar hasta las estructuras propias de Flos (The Tracking Magnet, The Running Magnet e Infra-Structure).

LIGHT SHADOW SPOT







Thanks to the unique patented optical solution, Light Shadow Pro controls extreme cut-off angles without altering the high efficiency and incredible versatility of the product.

Gracias a la exclusiva solución óptica patentada, Light Shadow Pro controla ángulos de cut-off extremos, sin sacrificar la alta eficiencia y la increíble versatilidad del producto.

1 Dual-focus lens developed by FLOS specifically for this product. It ensures maximum optical control and exceptional light beam homogeneity.

Lente de doble foco desarrollada por FLOS específicamente para este producto. Garantiza el máximo control óptico y una homogeneidad excepcional del haz de luz.

2 Light Shadow spots have an anti-glare honeycomb accessory to combine the high visual comfort technology of Light Shadow with this screen to further restrict visual access to the light source.

Light Shadow Spot cuenta con accesorio panel de abeja 'honeycomb' antideslumbramiento para combinar la tecnología de alto confort visual de Light Shadow con esta pantalla para restringir todavía más el acceso visual al origen de la luz.

LIGHT SHADOW SPOT Ø45

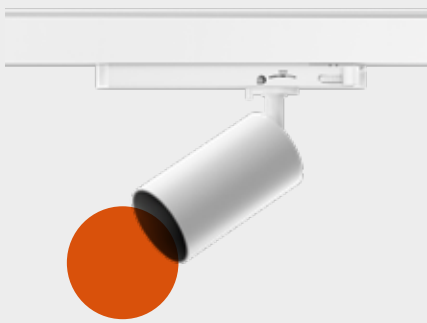

1

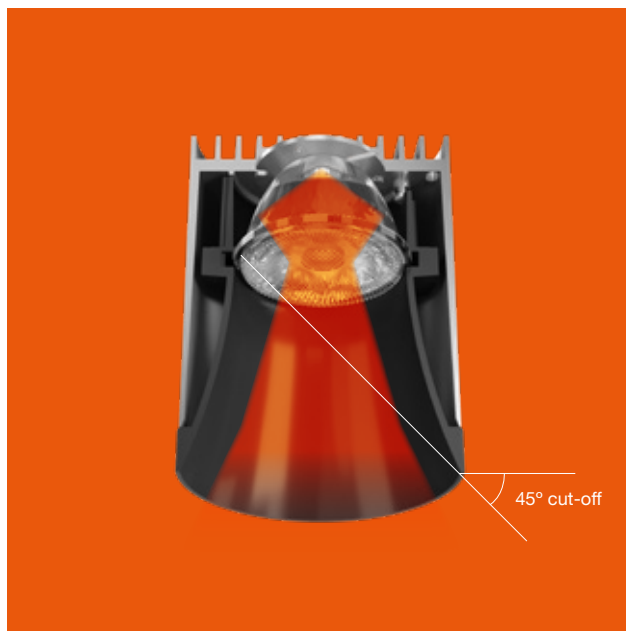

1

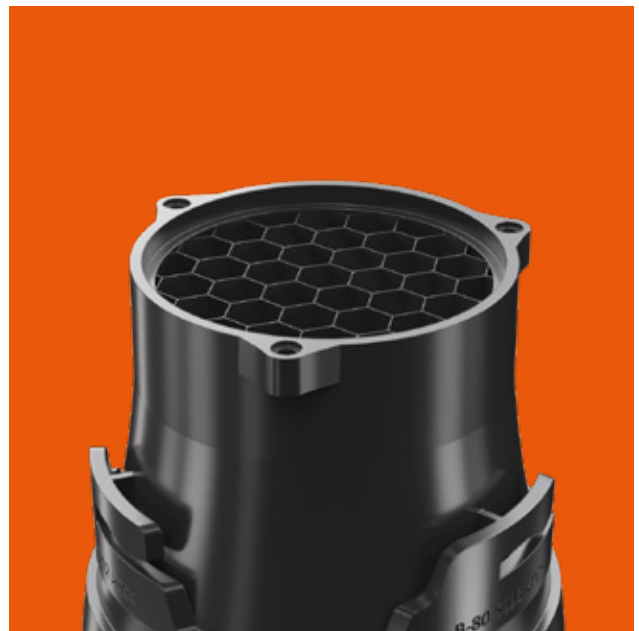

2

3 To obtain the desired light tone, CCT dichroic filters allow the color temperature of the Light Shadow projectors to be varied for cooler or warmer options.

Los filtros dicróicos CCT permiten variar la temperatura de color de los proyectores Light Shadow hacia opciones más frías o cálidas, para obtener el tono de luz deseado.

4 Available on request, Flos offers special finishes for both the body of the luminaires and for the back and rear arm of the product.

Disponibles bajo demanda, Flos ofrece acabados especiales tanto para el cuerpo de las luminarias como para la trasera y brazo posterior del producto.

LIGHT SHADOW SPOT Ø60

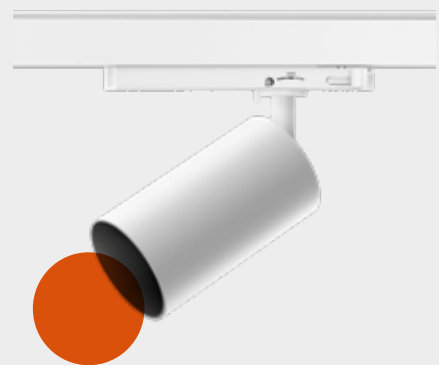

1



3



4

- 1 SUPER SPOT
- 2 SPOT
- 3 MEDIUM
- 4 FLOOD
- 5 WIDE FLOOD



BEAM ANGLES

The Light Shadow Spots collection offers a range of optics that provide the specifier with all the professional options needed for any project. From Super Spot to Wide Flood apertures, one product with all the solutions.

BEAM ANGLES

La colección de proyectores Light Shadow Spots ofrece una gama de ópticas que brinda al especificador todas las opciones profesionales necesarias para cualquier proyecto. Desde aperturas Super Spot hasta Wide Flood, un mismo producto con todas las soluciones.

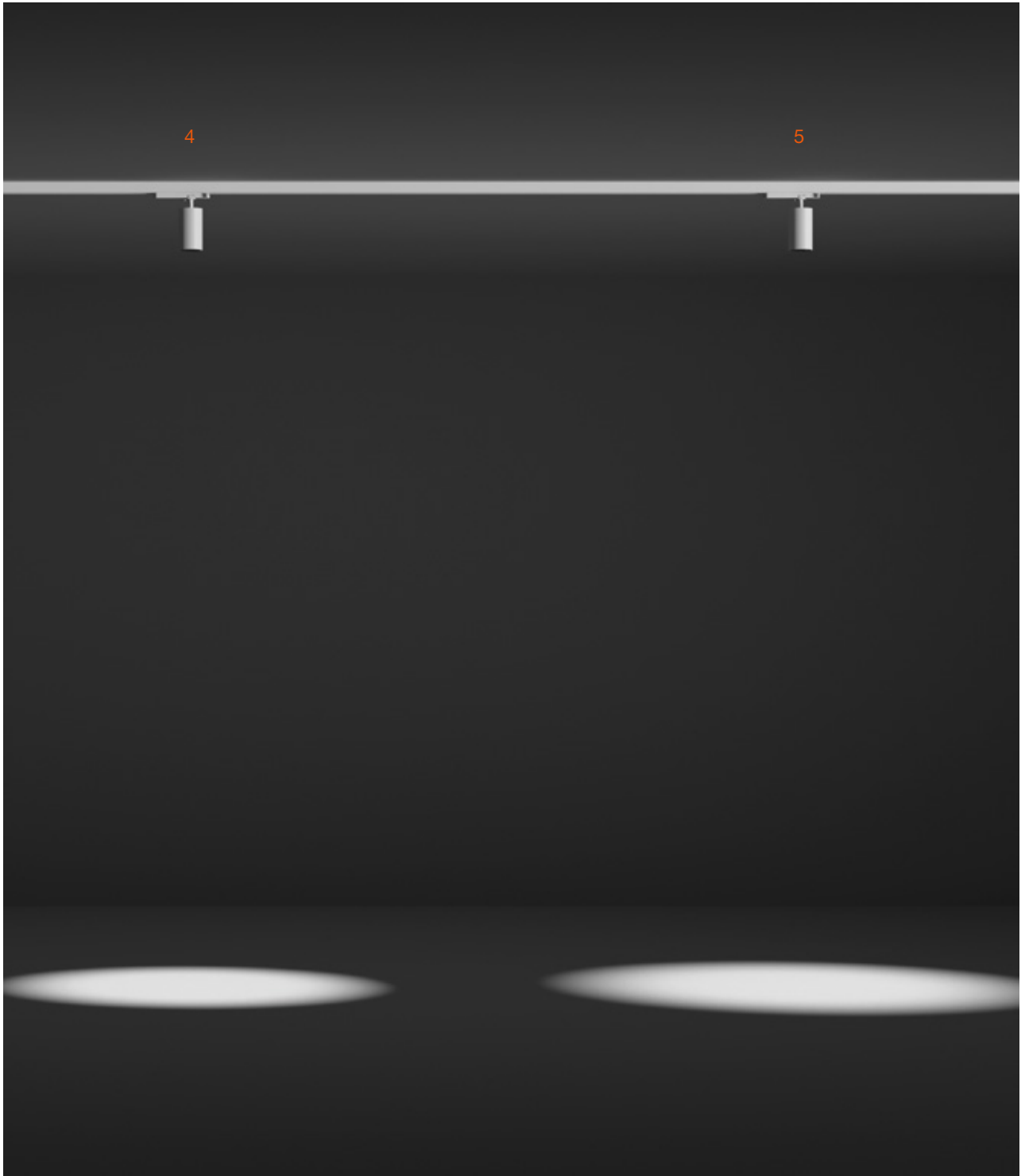



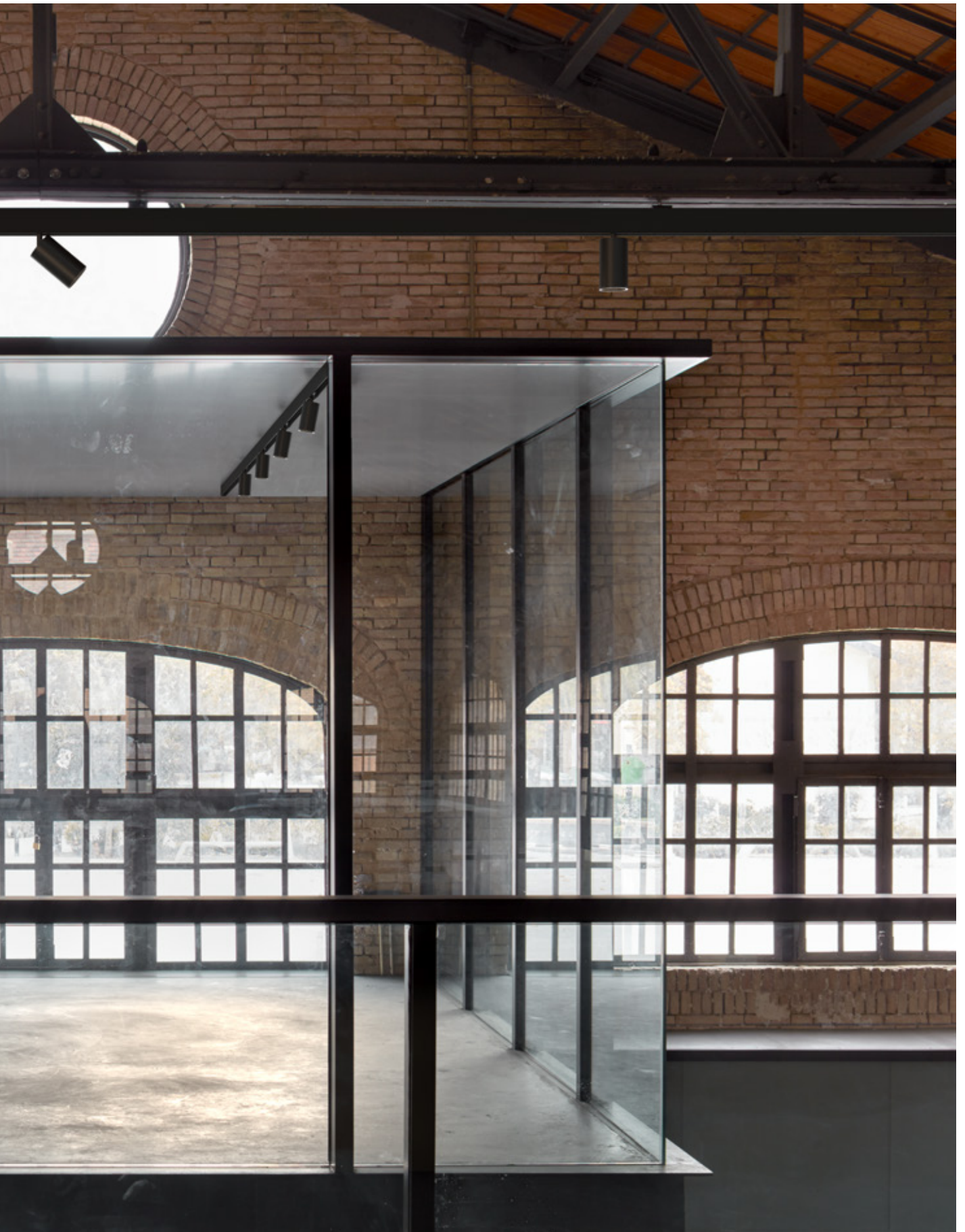



Different control options that can be adapted to any need.

Diferentes opciones de control que pueden adaptarse a cualquier necesidad.

DALI

Standard protocol for integration with any control system.

Control remoto broadcast (regulación de todas las luminarias en un mismo grupo).

CASAMBI

Individual control of each luminaire or broadcast remote control directly through a tablet or smartphone application (FLOS Control®).

Control individualizado de cada luminaria o control remoto broadcast directo mediante una aplicación para dispositivos móviles (Flos Control®).

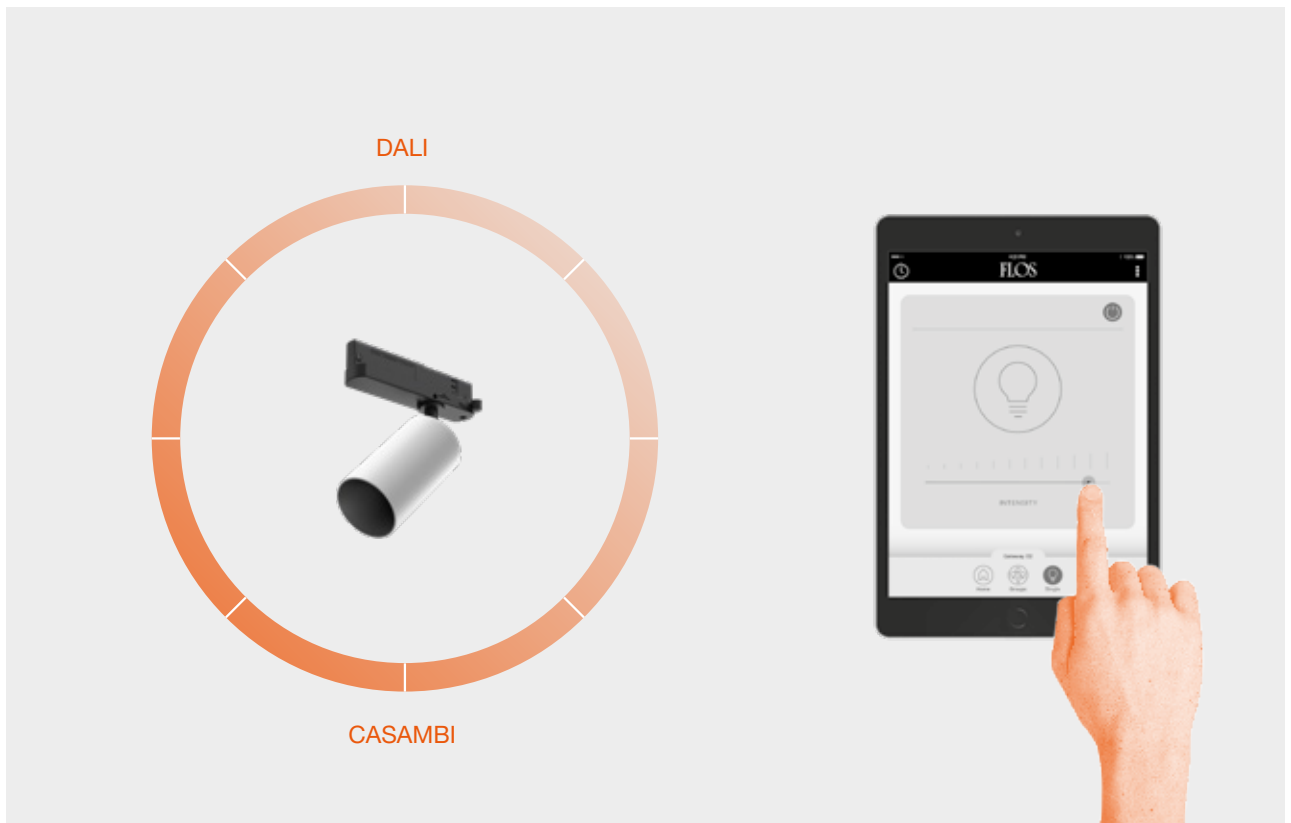

FLOS CONTROL®
BY CASAMBI

The FLOS Control® application allows you to control the system's luminaires individually or as a group, controlling scenes and programming.

La aplicación FLOS Control®, permite controlar las luminarias del sistema de modo individual o en grupo, controlando escenas y programación.

With a traditional electrical installation and the Gateway connected by Bluetooth, you obtain total control of the ambience.

Con tan sólo una instalación eléctrica tradicional y el Gateway conectado por Bluetooth se obtiene un control total del ambiente.

Available for iOS and Android

Disponible en iOS y Android

LIGHT SHADOW SPOT 45



LED ARRAY
11,5W

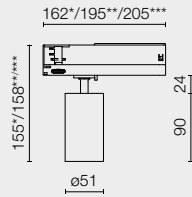

LIGHT SHADOW SPOT 60



LED ARRAY
Up to 22W

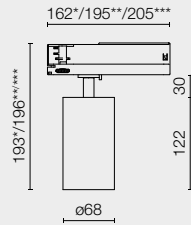

Non Dimming* / Casambi** / Dali***

Compatible with The Tracking Magnet & Infra-Structure.
Compatible con The Tracking Magnet & Infra-Structure.

LIGHT SHADOW
SPOT 30



LIGHT SHADOW
SPOT 45



LIGHT SHADOW
SPOT 60



Compatible with The Running Magnet.
Compatible con The Running Magnet.

LIGHT SHADOW
SPOT 30



LIGHT SHADOW
SPOT 45



40 White
40 Blanco

14 Black
14 Negro

40.78/YU/C6 All White



ER Brushed Steel
ER Acero Cepillado

ES Brushed Bronze
ES Bronce Cepillado



Super Spot



Spot



Medium



Flood



Wide Flood

FLOS
CONTROL BY CASAMBI



SPOT
SPOT
SPOT
SPOT
SPOT

NY

XY

YX

NY

SPOT
SPOT
SPOT
SPOT
SPOT

My Spot, the spotlight designed by Michael Anastassiades, is known for its unique and minimalist design. Now available in new recessed and surface-mounted versions, the possibilities for architectural integration become far greater.

My Spot, el proyector diseñado por Michael Anastassiades, destaca por su diseño único y minimalista. Ahora también disponible en versión de empotrar y superficie, ampliando sus posibilidades de integración arquitectónica.

MY SPOT



The range includes two different sizes of floodlight (Ø25 - Ø35) to suit a variety of lighting needs, as well as two different stem sizes to allow for customised installation according to the requirements of the space.

La gama incluye dos tamaños diferentes de proyector (Ø25 - Ø35) para adaptarse a diversas necesidades de iluminación, así como dos tamaños de tija que permiten una instalación personalizada según los requerimientos del espacio.

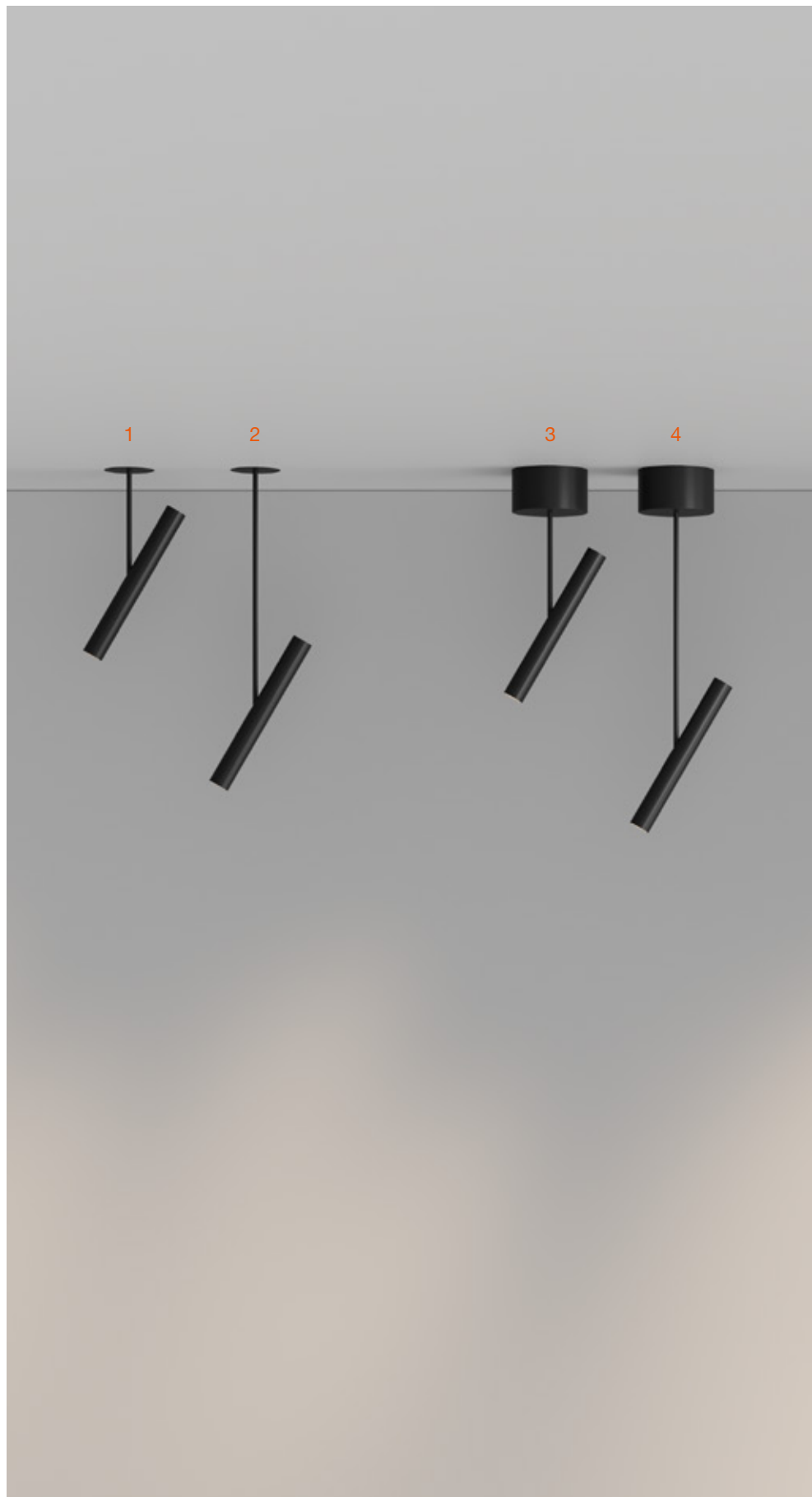

- 1 MY SPOT Ø25
SHORT RECESSED
- 2 MY SPOT Ø25
LONG RECESSED
- 3 MY SPOT Ø25
SHORT SURFACE
- 4 MY SPOT Ø25
LONG SURFACE
- 5 MY SPOT Ø35
SHORT RECESSED
- 6 MY SPOT Ø35
LONG RECESSED
- 7 MY SPOT Ø35
SHORT SURFACE
- 8 MY SPOT Ø35
LONG SURFACE

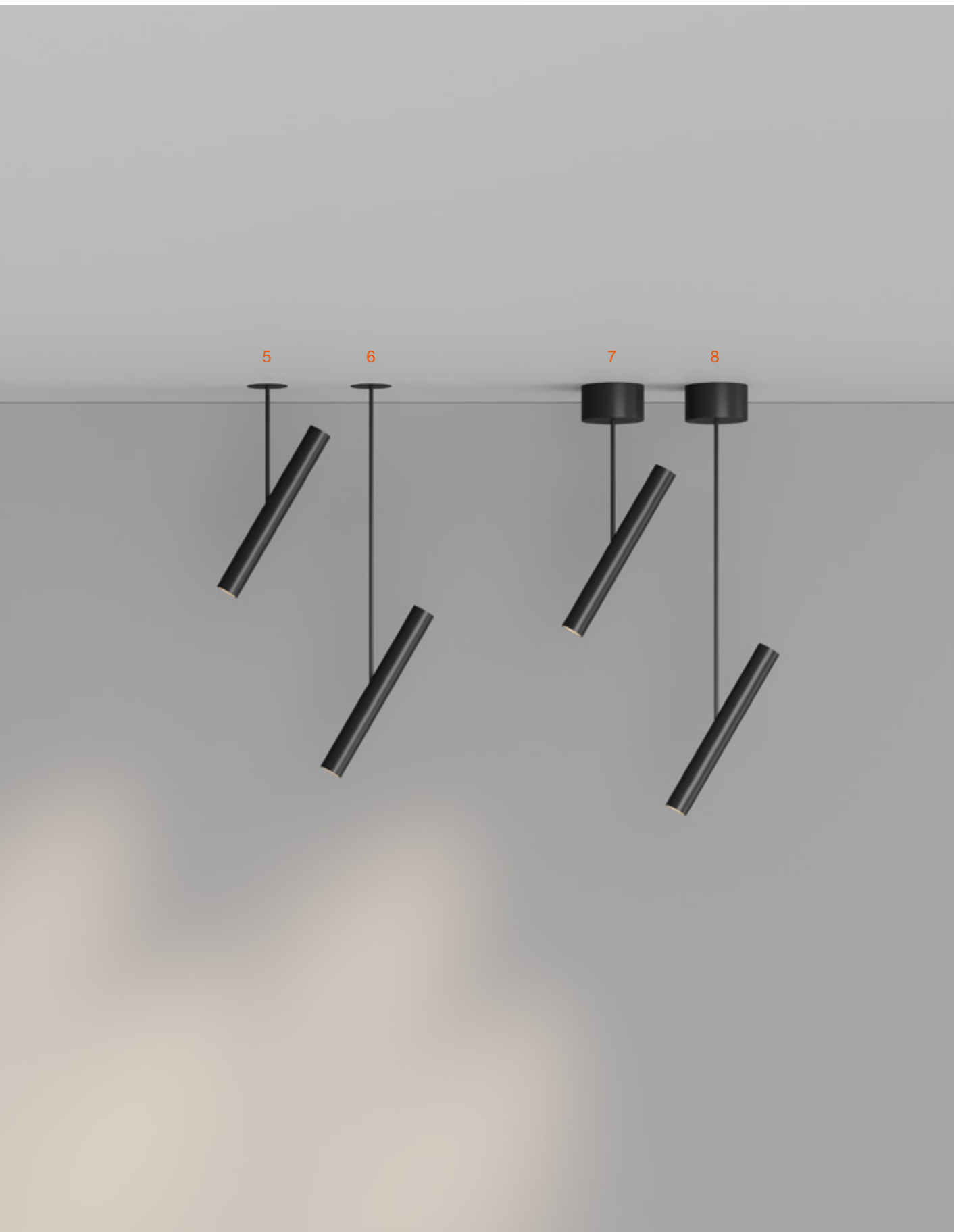

This configuration flexibility makes the floodlights suited to countless applications, from residential environments to high-demand commercial projects.

Esta flexibilidad de configuración asegura que los proyectores se ajusten a una amplia variedad de aplicaciones, desde ambientes residenciales hasta proyectos comerciales de alta exigencia.



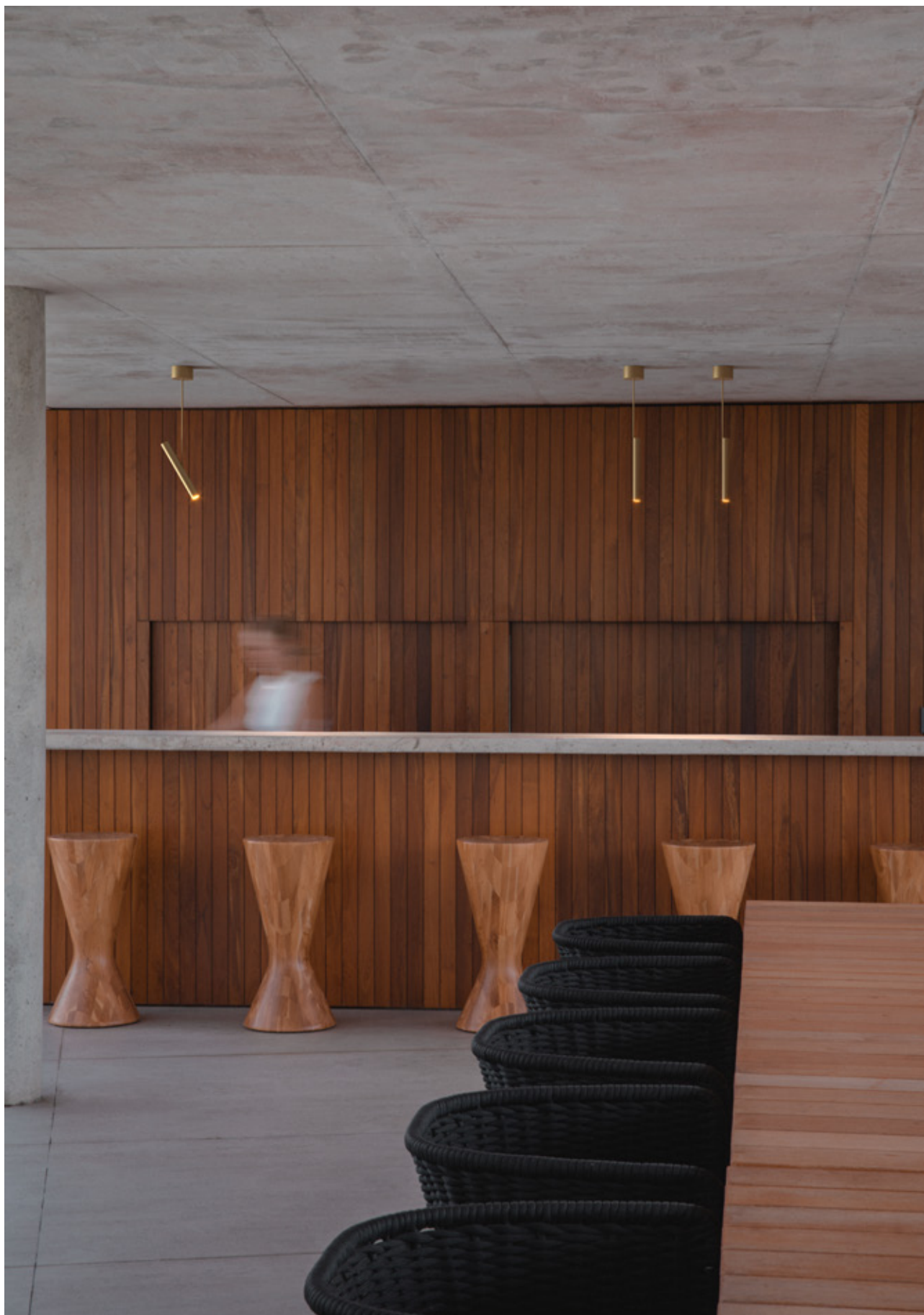

Equipped with advanced optics incorporating dual focal lens technology, these floodlights ensure high-quality uniform illumination, minimising glare and providing superior visual comfort.

Equipados con una óptica avanzada que incorpora tecnología de lentes de doble focal, estos proyectores garantizan una iluminación uniforme y de alta calidad, reduciendo al máximo el deslumbramiento y ofreciendo un confort visual superior.



The spotlights in the My Spot range are fully adjustable, allowing both swivelling and tilting movements and giving total flexibility for directing the light precisely where desired.

Los proyectores de la gama My Spot son completamente orientables, permitiendo movimientos tanto de giro como de basculación, lo que brinda una flexibilidad total para dirigir la luz con precisión hacia los puntos deseados.

In addition, when in a downlight position, the connection arm is perfectly flush with the product, maintaining a clean aesthetic free from visual interruptions.

Además, en su posición downlight, el brazo de conexión queda perfectamente enrasado con el producto, manteniendo una estética limpia y sin interrupciones visuales.

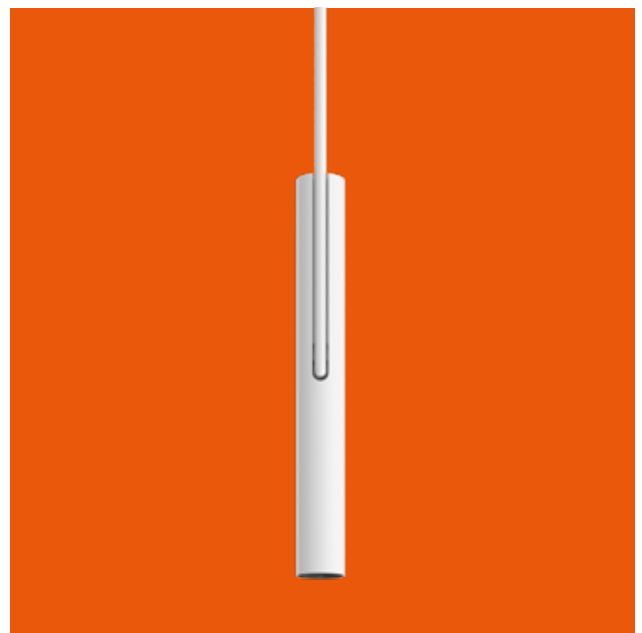
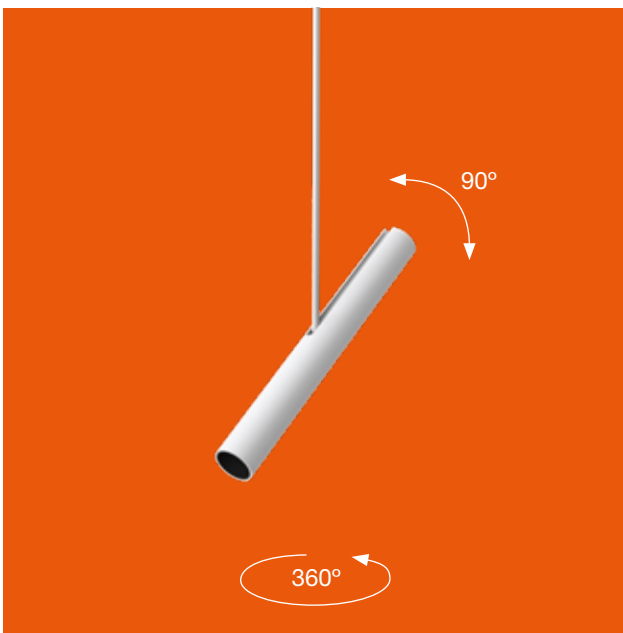



My Spot is available in multiple finishes, including sophisticated metallic options. These possibilities ensure the spotlights play not only a functional role but also become distinctive decorative elements with a personality of their own, adding a touch of refined design to any space.

My Spot se ofrece en diferentes acabados, entre los que destacan sofisticadas opciones metálicas. Estas posibilidades permiten que los proyectores no solo desempeñen un papel funcional, sino que también se conviertan en elementos decorativos distintivos con personalidad propia, agregando un toque de diseño refinado a cualquier espacio.



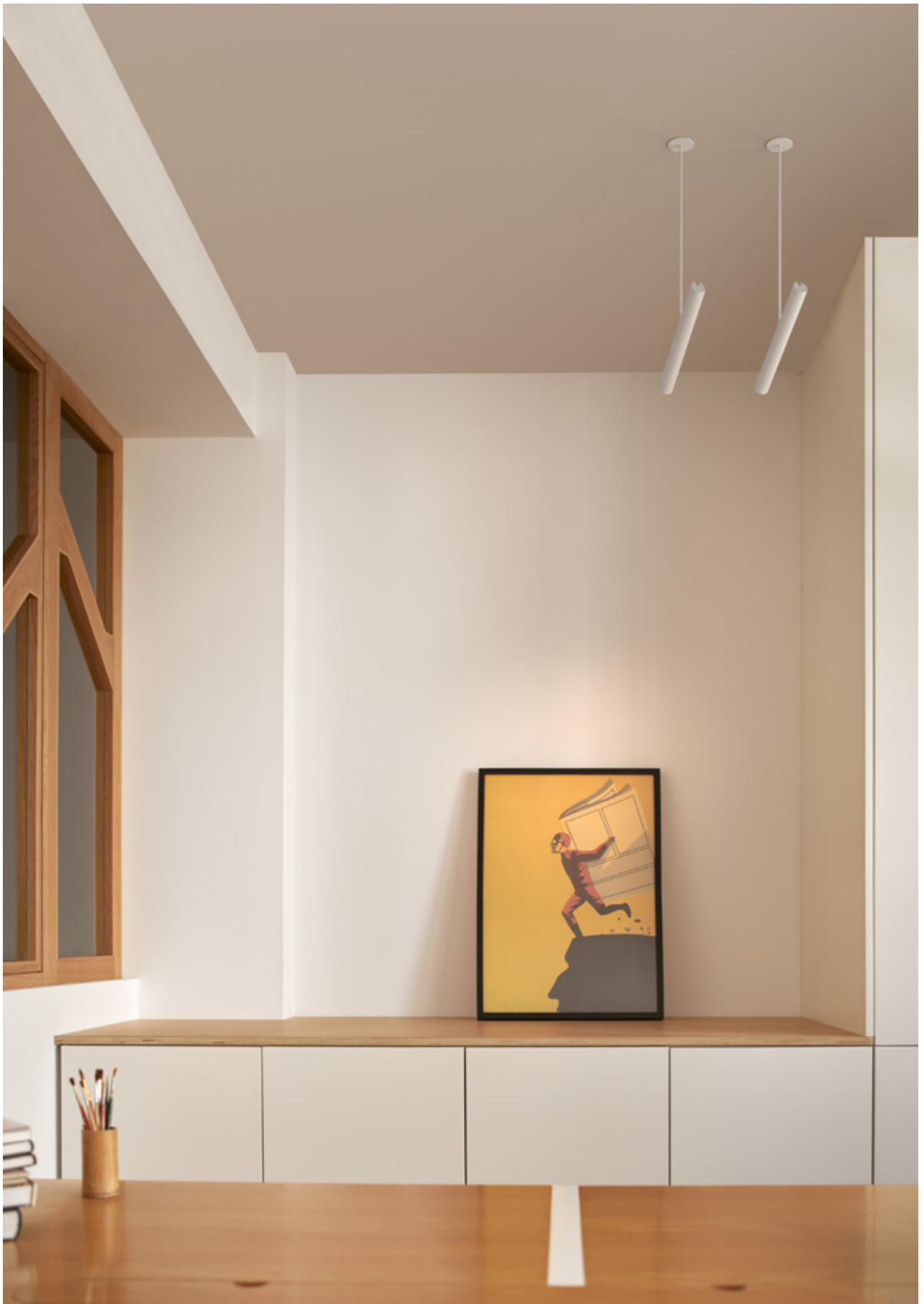

	Different control options for dimming MY SPOT. Recessed: No Dim, Mains Dimming, 1-10V, Dali/Push, Casambi. Surface: No Dim, Dali, Casambi.	Diferentes opciones de control para la regulación de MY SPOT. Empotrado: No Dim, Mains Dimming, 1-10V, Dali/Push, Casambi. Superficie: No Dim, Dali, Casambi.
MAINS DIMMING	Intensity regulation through phase-cut dimming of the electrical network.	Regulación de intensidad mediante el corte de fase de la red eléctrica.
DALI	Standard protocol for integration with any control system.	Protocolo standard para la integración con cualquier sistema de control.
1-10V	Broadcasting remote control (dimming of all the luminaires in a single group).	Control remoto en broadcasting (dimado de todas las luminarias en grupo).
CASAMBI	Control through a tablet or smartphone application (FLOS Control®).	Control broadcast a través de una aplicación para tablet o smartphone (FLOS Control®).

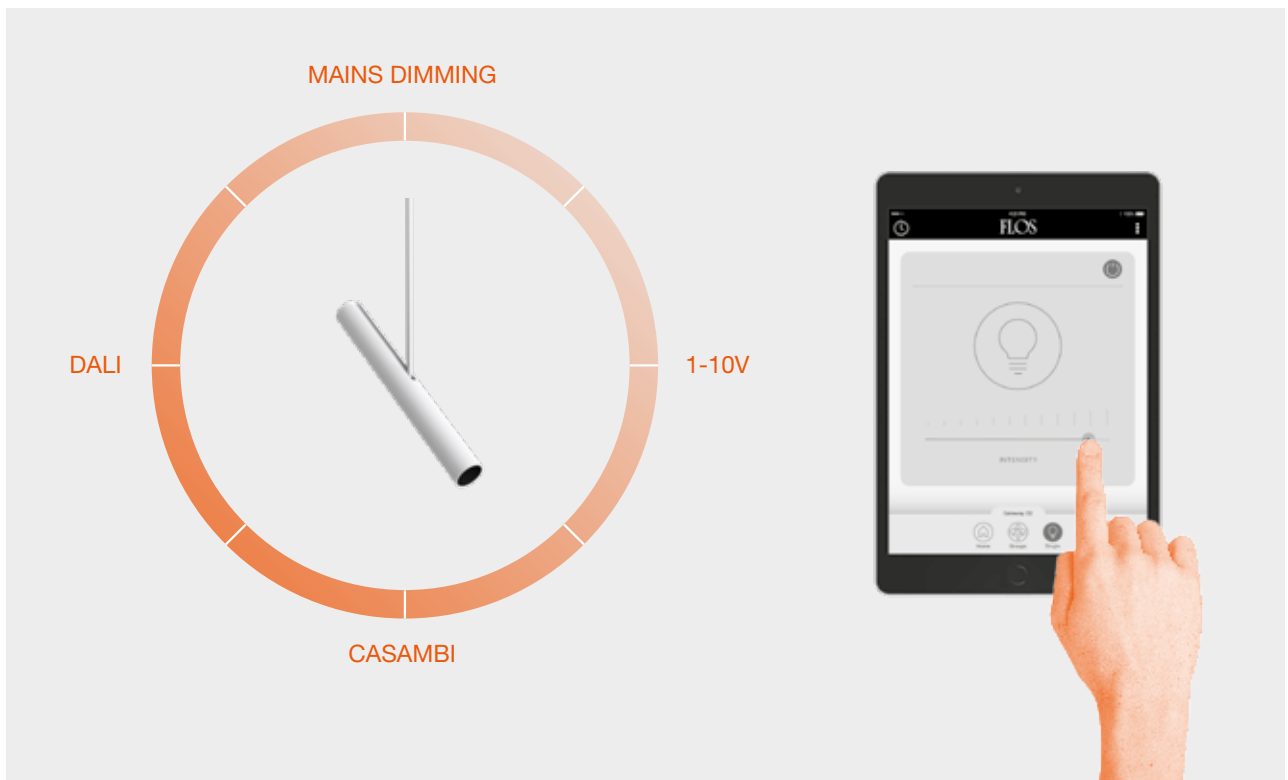

FLOS CONTROL®
BY CASAMBI

The FLOS Control® application allows you to control the system's luminaires as a group, controlling scenes and programming.

With a traditional electrical installation and the Gateway connected by Bluetooth, you obtain total control of the ambience.

Available for iOS and Android

La aplicación FLOS Control®, permite controlar las luminarias del sistema en grupo, controlando escenas y programación.

Con tan sólo una instalación eléctrica tradicional y el Gateway conectado por Bluetooth se obtiene un control total del ambiente.

Disponible en iOS y Android

MY SPOT RECESSED

MY SPOT Ø25
SHORT RECESSED



POWER LED
2,5W

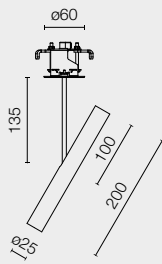

MY SPOT Ø25
LONG RECESSED



POWER LED
2,5W

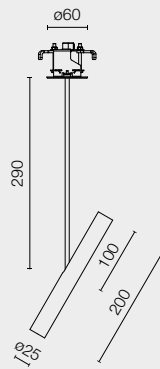

MY SPOT Ø35
SHORT RECESSED



LED ARRAY
7,2W

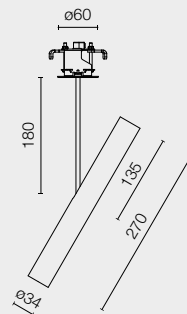

MY SPOT Ø35
LONG RECESSED



LED ARRAY
7,2W

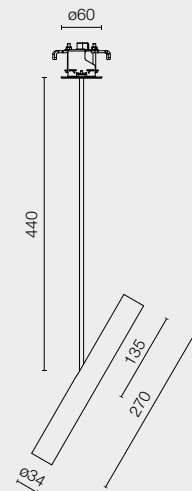

Spot



Medium



Flood

MY SPOT RECESSED

☐ 40 White
40 Blanco



■ 14 Black
14 Negro



▒ ER Brushed Steel
ER Acero Cepillado



■ ES Brushed Bronze
ES Bronce Cepillado



MY SPOT SURFACE

MY SPOT Ø25
SHORT SURFACE



POWER LED
4,7W

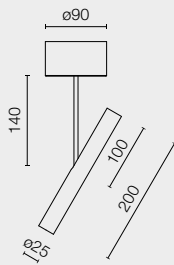

MY SPOT Ø25
LONG SURFACE



POWER LED
4,7W

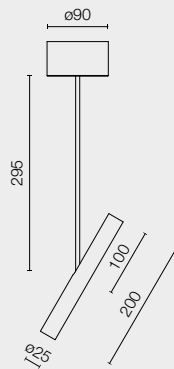

MY SPOT Ø35
SHORT SURFACE



LED ARRAY
Up to 11,5W

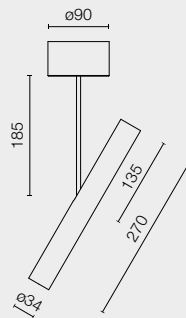

MY SPOT Ø35
LONG SURFACE



LED ARRAY
Up to 11,5W

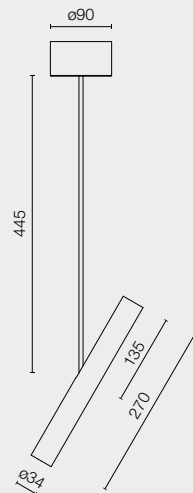

Spot



Medium



Flood

MY SPOT SURFACE

□ 40 White
40 Blanco



■ 14 Black
14 Negro



◻ ER Brushed Steel
ER Acero Cepillado



■ ES Brushed Bronze
ES Bronce Cepillado



ZERO TRACK PRO

MY SPOT Ø25
SHORT



MY SPOT Ø25
LONG



MY SPOT Ø35
SHORT



MY SPOT Ø35
LONG



* Refer to Zero Track Pro chapter / Ver capítulo Zero Track Pro

SUPER

& PRO LINE & PRO

LINE & PRO LINE

SUPER

& PRO LINE & PRO

LINE & PRO LINE

SUPER

Efficient and delicate luminaire featuring a high technological level. It is composed of a bar combining direct and indirect light and held by two coaxial cables that provide support and electrical wiring. Perfect for offices or places that require high lighting efficiency and comfort.

Luminaria de alto nivel tecnológico, eficiente y delicada, formada por una barra que combina la luz directa e indirecta sujeta por dos cables coaxiales que aportan sujeción y cableado eléctrico. Perfecta para oficinas o lugares que requieren de una gran eficiencia luminosa y un alto confort.

SUPER LINE & PRO







Super Line is equipped with a technical multi-layer diffuser filter that guarantees perfect light distribution and improves the optical effect and visual comfort. Super Line Pro is fitted with a black raster that ensures total control of the light distribution and maximum comfort in work environments.

Super Line está equipado con un filtro difusor técnico multicapa que asegura una distribución perfecta de la luz y mejora el efecto óptico y el confort visual. Super Line Pro monta un raster negro, que garantiza un control total de la distribución de luz y el máximo confort en ambientes de trabajo.

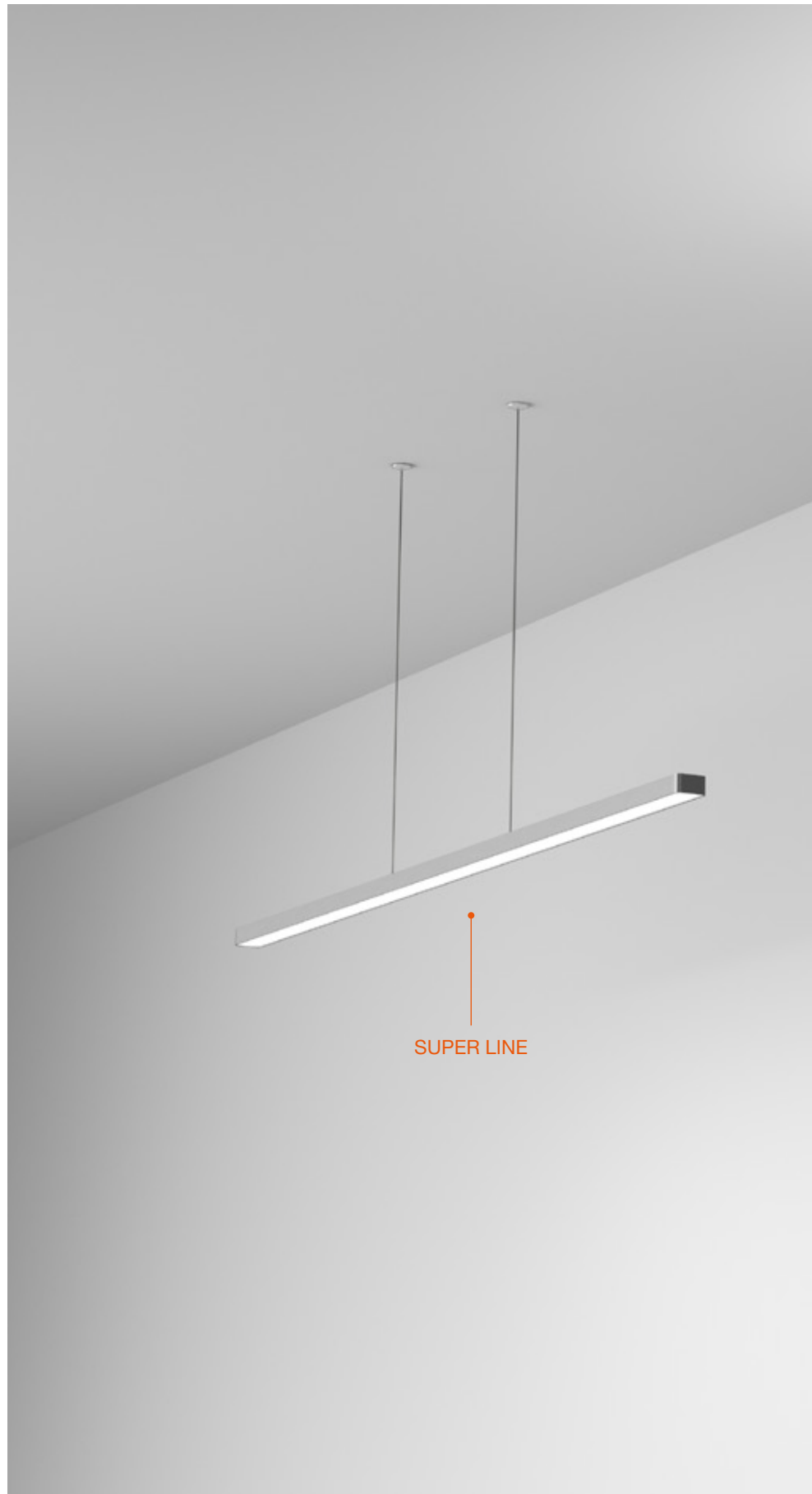

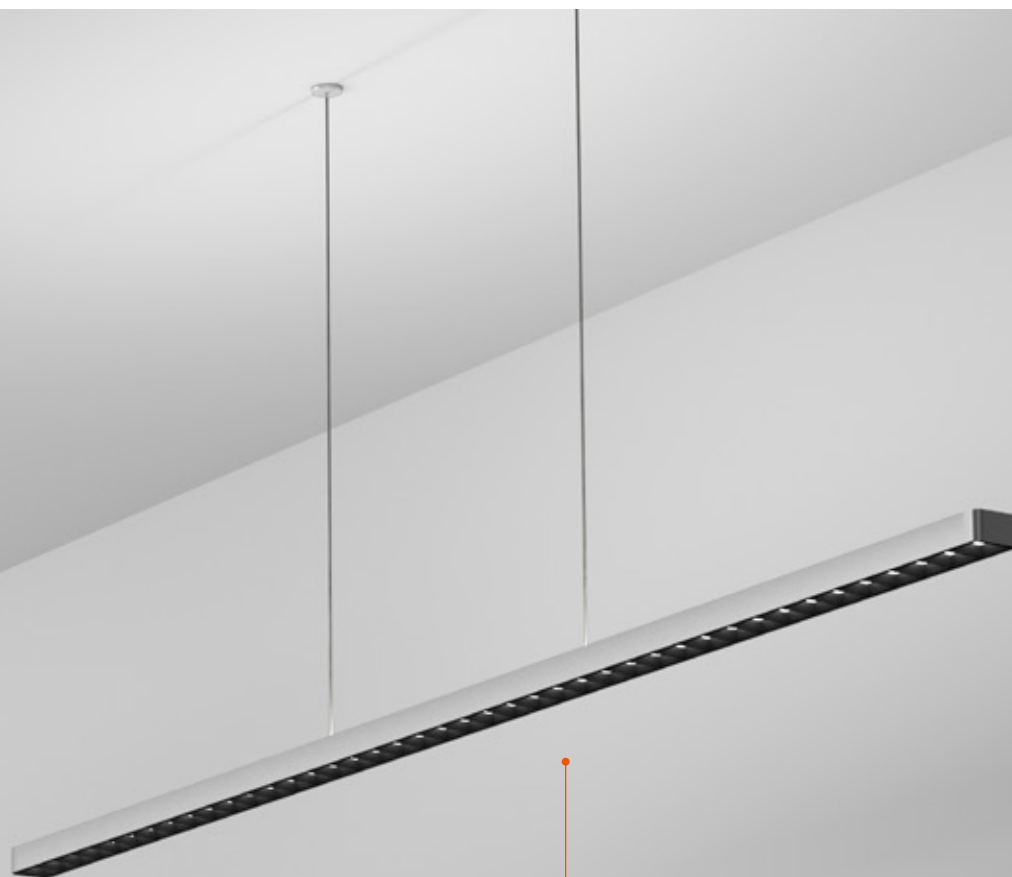

SUPER LINE PRO



The patented optical unit that characterizes Super Line Pro consists of a modular optical raster with four-sided cells combined with a primary lens.

El grupo óptico que caracteriza Super Line Pro está patentado y está compuesto por un raster óptico modular con celdas cuadrangulares combinadas con una lente primaria.



Powered by a coaxial cable.

Alimentada a través de cable coaxial.

1 The ceiling installation is carried out by means of a patented recessing system for quick adjustment that allows you to adjust the cables length during the installation.

La instalación a techo se realiza mediante un sistema de empotrado de ajuste rápido patentado que permite ajustar la longitud de los cables durante el montaje.

2 The device's cable outlet is individual for direct and indirect emission control, and is marked by a specific printed element showing the words "Up Light" and "Down Light".

La salida de los cables del dispositivo es individual para el control de emisión directa e indirecta y está marcada por un elemento impreso específico que lleva las palabras "Up Light" y "Down Light".

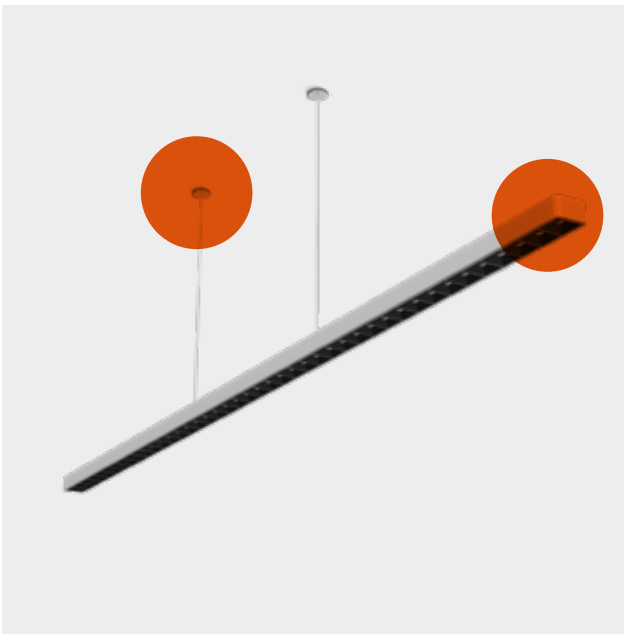

1



2



Exclusive patented optical solution.

Exclusiva solución óptica patentada.

3 The main lens is made of PMMA. It features a dedicated surface texturing and Frosted finish to guarantee the maximum homogeneity of the lighting effect. La lente principal está hecha de PMMA, con una texturización superficial específica y acabado Frosted para garantizar la máxima homogeneidad del efecto luminoso.

4 The upper profile of the luminaire has been developed in combination with the lens to prevent indirect light from hitting it, which would cause an unpleasant glare to the eye.

El perfil superior de la luminaria ha sido desarrollado en combinación con la lente para evitar que la luz indirecta la golpee, provocando un resplandor desagradable a la vista.



3

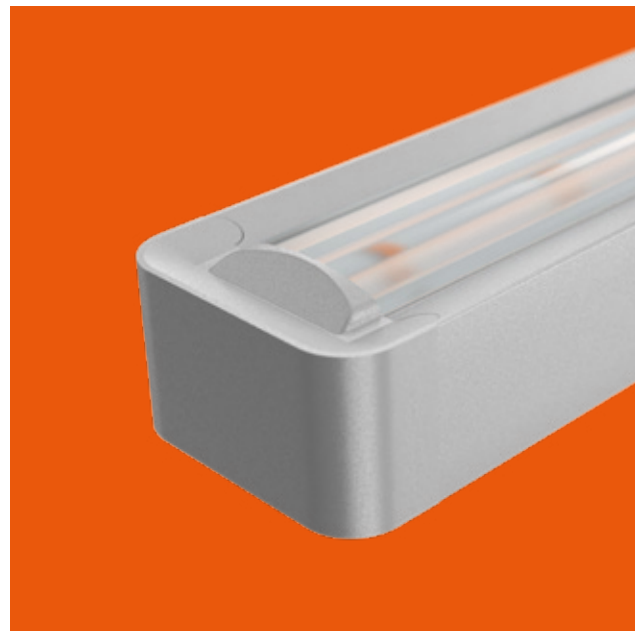

4

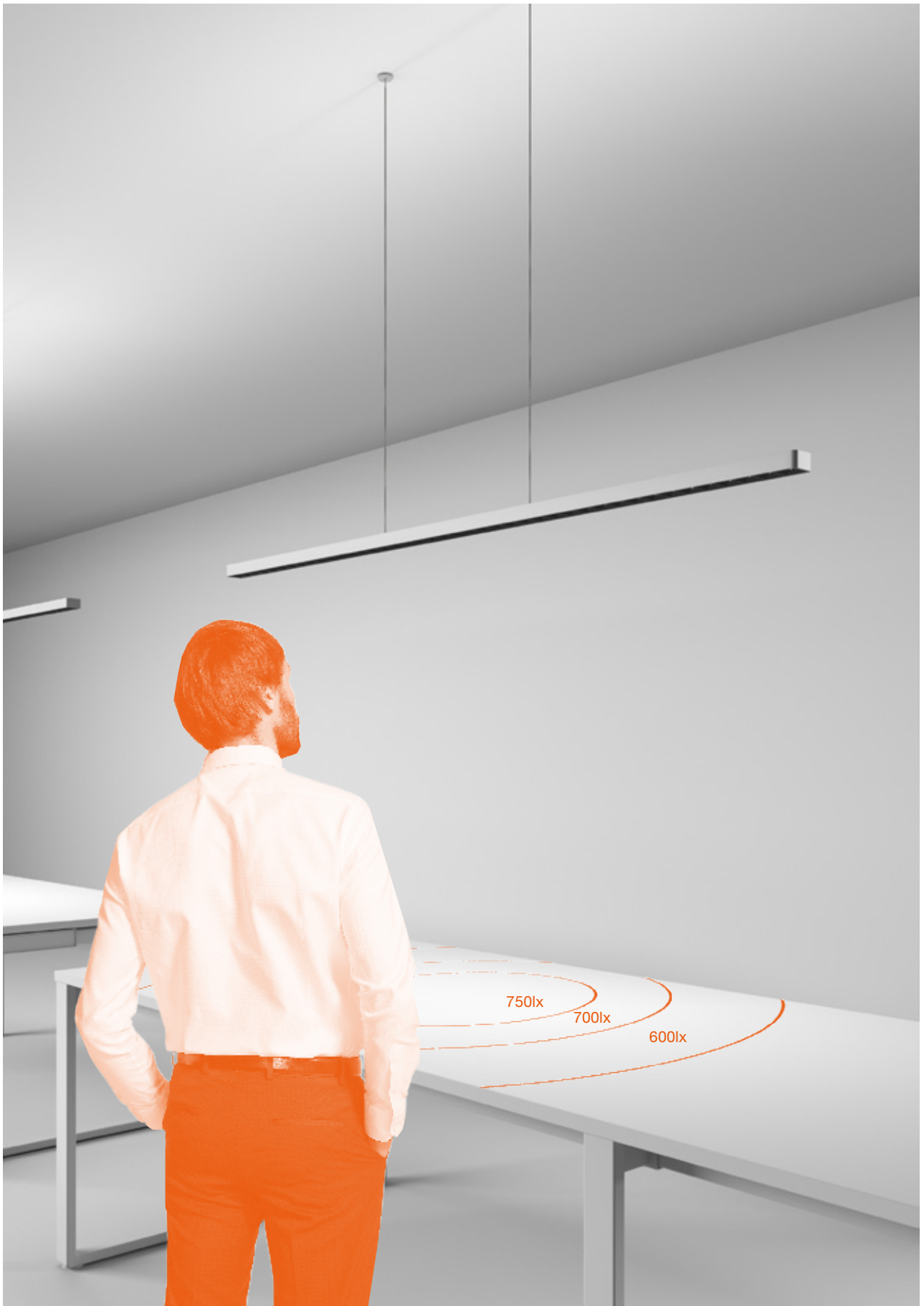

The light source used for managing the direct emission is positioned far back inside the profile in order to seize the maximum control of the direct glare. The patented optical unit was specifically developed for applications in Office environments.

La fuente de luz utilizada para la gestión de la emisión directa está colocada muy hacia atrás dentro del perfil, para aprovechar el máximo control del deslumbramiento directo. El grupo óptico patentado se desarrolló específicamente para aplicaciones en ambientes Office.

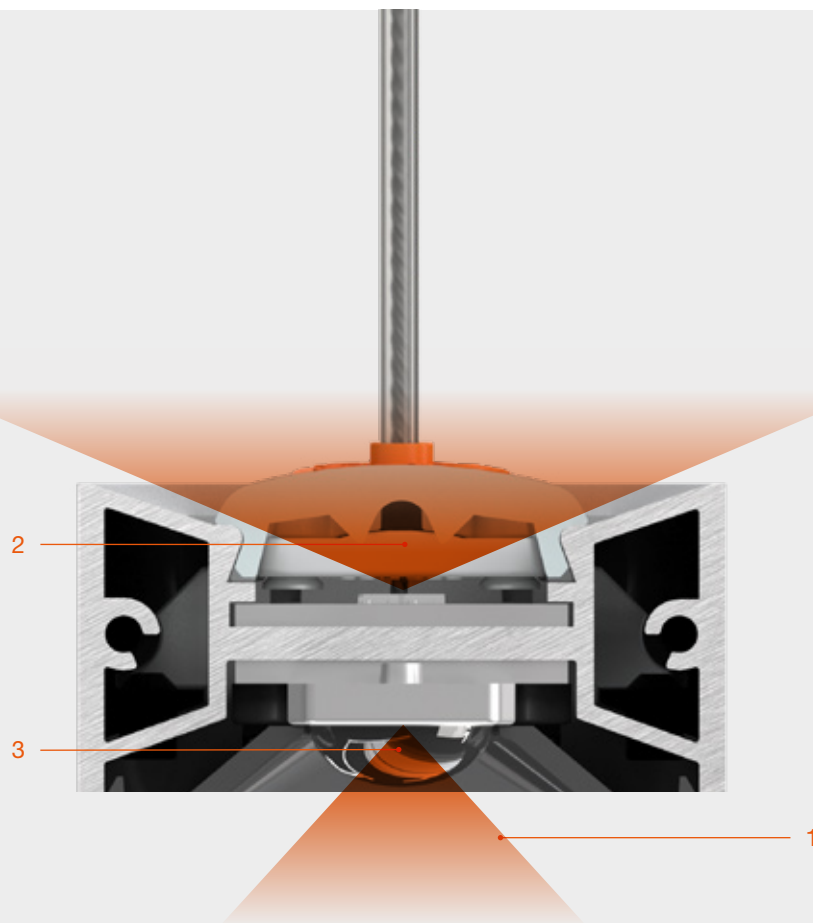

1 Extreme shielding angle that does not compromise the ultra-compact dimensions and high efficiency values. Ángulo de apantallamiento extremo, sin renunciar a las dimensiones ultracompactas y a elevados valores de eficiencia.

2 Integrated LED PCB. PCB LED integrada.

3 Textured primary lens. Lente primaria texturizada.





Embellishment for installation with remote equipment.

Embellecedor para la instalación con el equipo remoto.

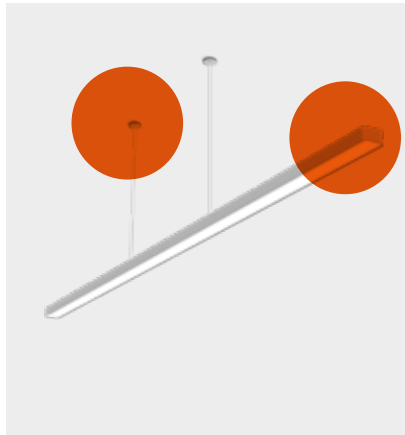

The special opal diffuser that completes the luminaire, characterizing the direct emission, ensures maximum uniformity and a practically Lambertian distribution.

El difusor opal especial que completa la luminaria, caracterizando la emisión directa, asegura la máxima uniformidad y una distribución prácticamente lambertiana.

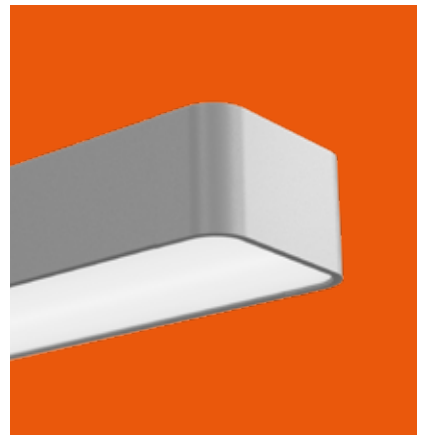

Although its dimensions are extra compact and the LED tips are close to the diffuser, it offers homogeneous light distribution. The LED tips are not visible.

Pese a sus dimensiones súper compactas y la cercanía de los puntos LED al difusor, se ofrece distribución homogénea de la luz. No se ven los puntos LED.

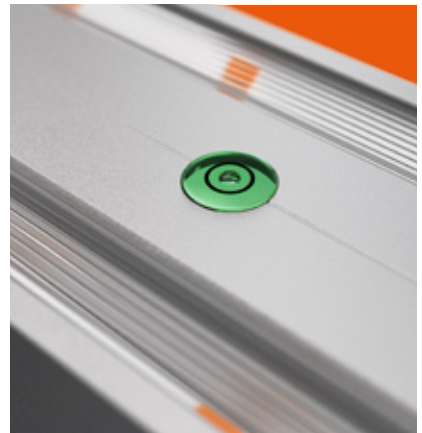
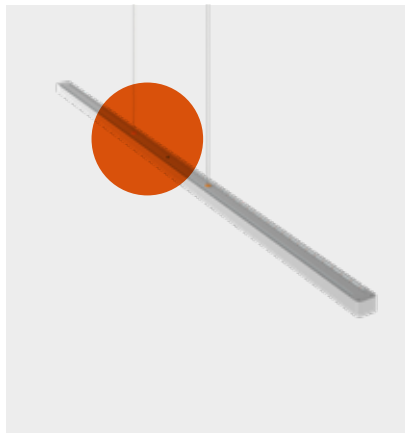

Detail of the coaxial cable that forms the electrical connection and can also be used for suspending.

Detalle del cable coaxial que hace la conexión eléctrica y sirve a la vez como suspensión.

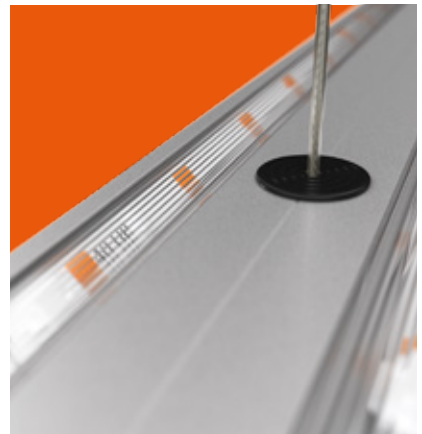



SUPER LINE
UP&DOWN
INDIRECT



TOP LED
58W

SUPER LINE
UP&DOWN
DIRECT



TOP LED
58W

SUPER LINE
DOWN



TOP LED
38,6W

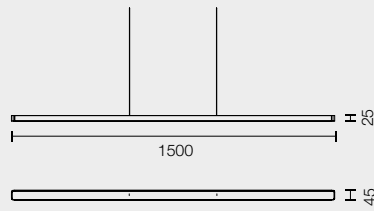

40 White
40 Blanco

02 Grey
02 Gris

14 Black
14 Negro

ET Brushed Brass
ET Latón Cepillado

EU Brushed Rose Gold
EU Oro Rosa Cepillado

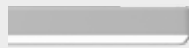
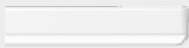

Flood
Up&Down



Flood

SUPER LINE PRO
UP&DOWN

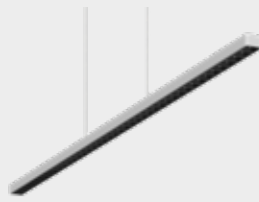

TOP LED
60W

SUPER LINE PRO
DOWN



TOP LED
40W

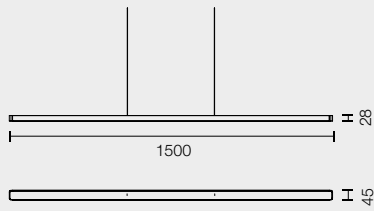

40 White
40 Blanco

02 Grey
02 Gris

14 Black
14 Negro

ET Brushed Brass
ET Latón Cepillado

EU Brushed Rose Gold
EU Oro Rosa Cepillado



Flood
Up&Down



Flood

FLOS
CONTROL BY CASAMBI



KAP

KAP

KAP

KAP

KAP

KAP

KAP

KAP

KAP

KAP

KAP

A collection of recessed elements for interior installations that include avant-garde LED solutions and luminaires with a traditional light source. A wide variety of sizes and finishes that ensure a perfect integration in all environments. Optic body to ensure an excellent visual comfort.

Colección de empotrables para instalaciones de interior, que incluye soluciones tanto en LED de última generación como luminarias con fuente de luz tradicional. Extensa variedad de tamaños y acabados que garantiza su perfecta integración en todos los ambientes. Cuerpo óptico diseñado para garantizar un gran confort visual.

KAP

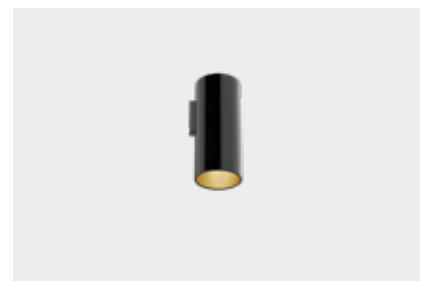
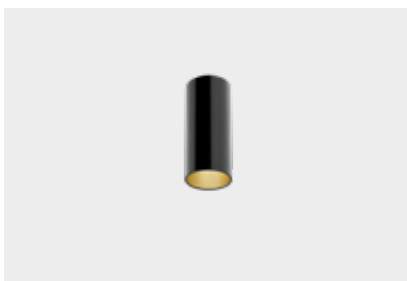
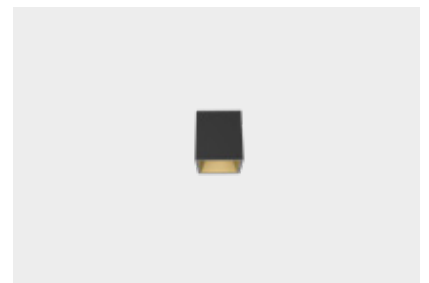
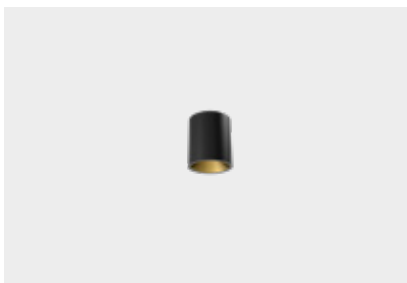



Private House, Geneva



A complete and versatile program capable of meeting innumerable project needs thanks to the incredible variety of sizes, powers, finishes and accessories available.

Un programa completo y versátil, capaz de resolver innumerables necesidades de proyectos gracias a la increíble variedad de tamaños, potencias, acabados y accesorios disponibles.



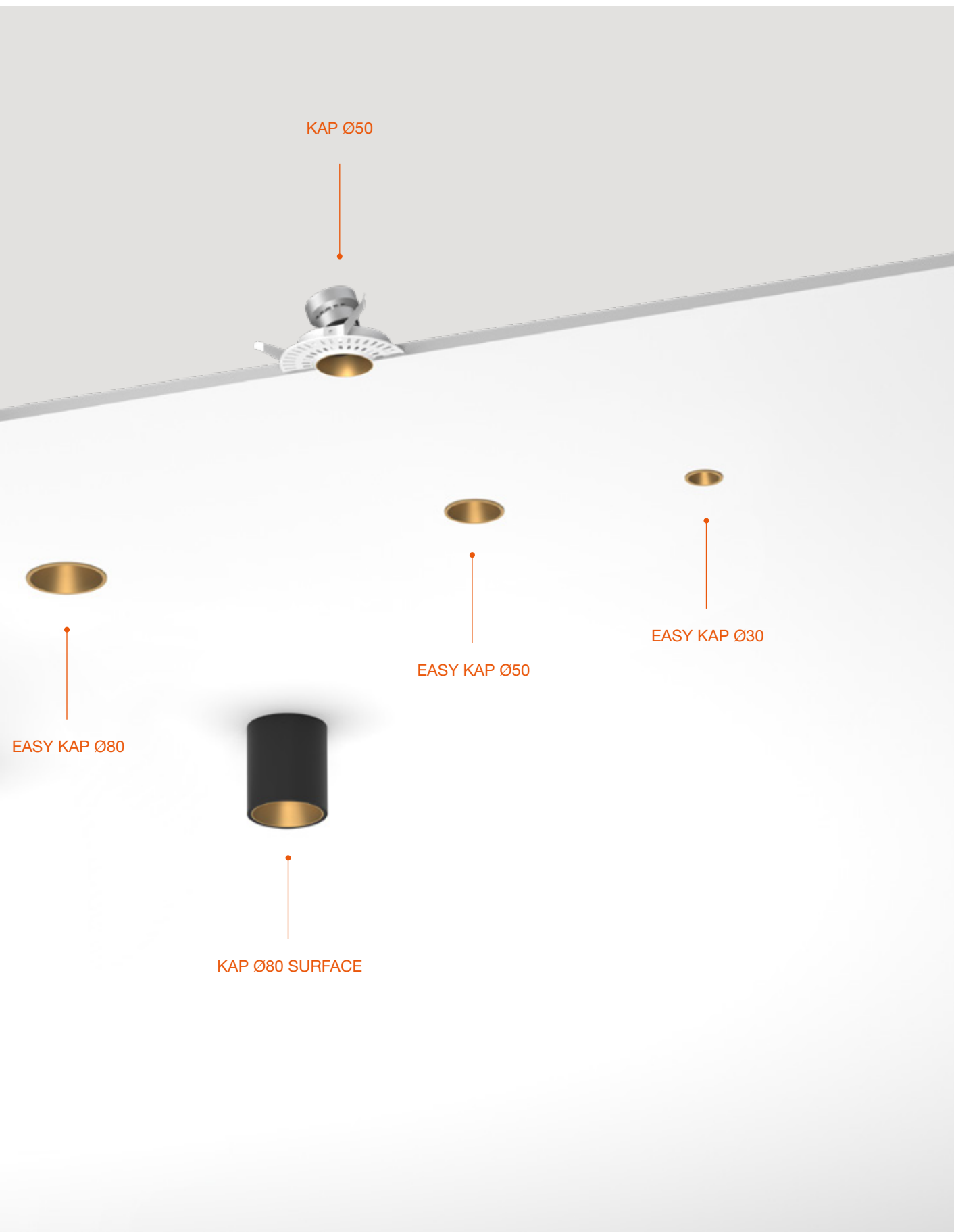





KAP

Form and function are combined in a technical device that completely merges with the architecture thanks to the details of the optical unit with no visible edges.

Forma y función combinadas en un dispositivo técnico capaz de fusionarse totalmente con la arquitectura gracias a los detalles de la unidad óptica sin bordes visibles.

1 The main body of the luminaire contains a radiator for temperature control.

La luminaria incluye en su cuerpo principal un elemento radiador con el fin de controlar la correcta temperatura de trabajo de la misma.



2 The housing includes a thermoplastic diffuser which ensures a perfect light distribution on horizontal surfaces.

El cuerpo incorpora un difusor realizado en material termoplástico para obtener una perfecta distribución de luz en planos horizontales.

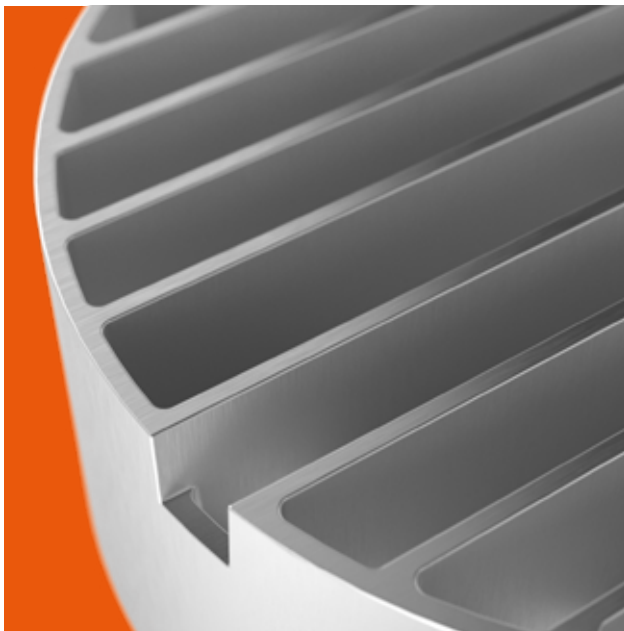

1



2

EASY KAP

The performance and finishes of Kap are applied to a more versatile and manageable model that increases the simplicity of installation thanks to the optical unit with a visible edge.

El rendimiento y los acabados de Kap, aplicados a un modelo más versátil y manejable que aumenta la simplicidad de instalación gracias al grupo óptico con borde visible.

3 High performance sink in die-cast aluminum.
Disipador de alto rendimiento en aluminio fundido a presión.

4 A thin, protruding edge helps hiding any imperfections in the ceiling and guarantees a flawless installation.
Un fino borde sobresaliente ayuda a ocultar cualquier imperfección en el techo y garantiza una instalación impecable.











KAP dim to warm represents the state of the art in color temperature control. The unique dim to warm technology covers a range from 2850K to 1800K with optimal color performance thanks to a flawless synchronized control of light intensity and color temperature. The system simulates the regulation of traditional incandescent lamps exploiting the best current LED technology.

KAP dim to warm representa la vanguardia en el control de la temperatura de color. La exclusiva tecnología dim to warm cubre un rango entre 2850K y 1800K con un rendimiento cromático óptimo, gracias a un impecable control sincronizado de la intensidad luminosa y la temperatura de color. El sistema simula la regulación de las tradicionales bombillas incandescentes, aprovechando lo mejor de la tecnología LED actual.

1800K  2850K



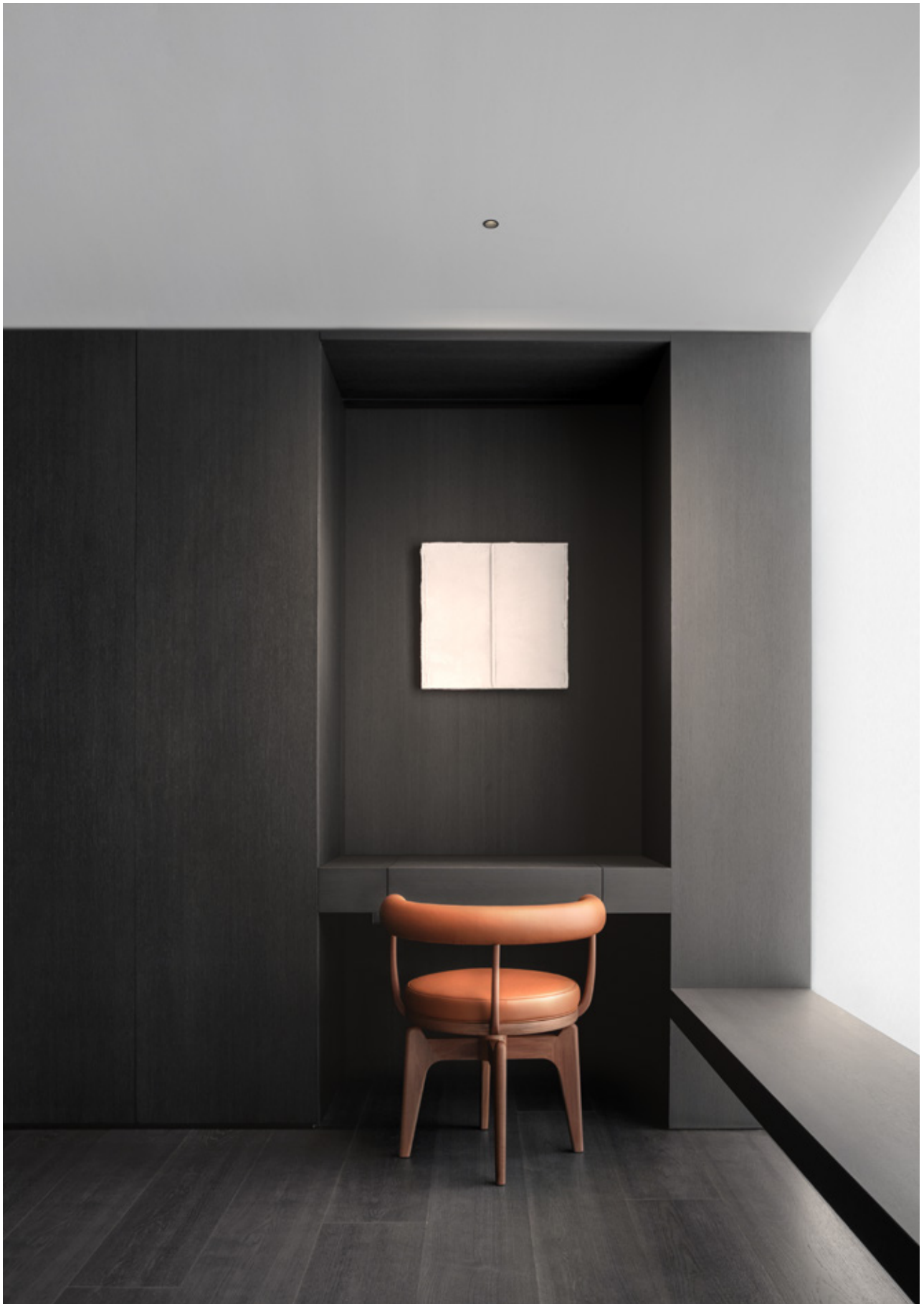

EASY KAP 30 FIXED

The Easy Kap 30 is the smallest model in the KAP product family. This is a small, sleek, understated ceiling light for general or focused lighting, taking up minimum space.

La talla 30 de Easy Kap es el modelo más pequeño de toda la familia KAP. Un pequeño, elegante y discreto punto de luz en el techo para iluminación general o de acento, con la mínima presencia en el espacio.

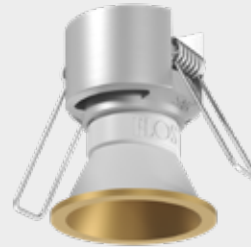

EASY KAP 30 ADJUSTABLE

With the adjustable Easy Kap 30 model the light beam can be slightly adjusted by an angle of 17° on both axes. The slight directionality featured in this model brings distinctive detail to the design of the light.

Con la variante orientable de Easy Kap 30 se puede ajustar ligeramente el haz de luz en un ángulo de 17° en ambos ejes. Una leve direccionalidad que permite a este modelo aportar el detalle diferencial en la iluminación del proyecto.

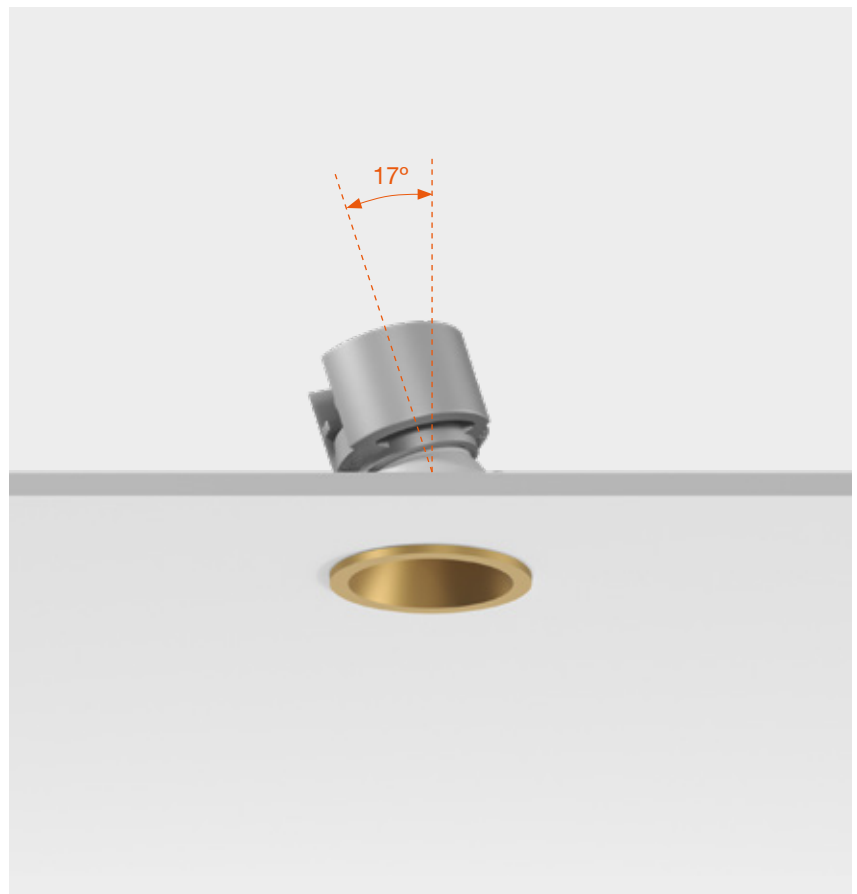



EASY KAP IP65

Easy Kap features IP65 certification in its 50, 80, and 80 Plus models (Fixed & Round), ensuring exceptional protection against dust and water. This version allows its use in more demanding environments, both indoors and in protected outdoor spaces. Its versatility expands lighting possibilities without compromising light quality or aesthetic harmony.

Easy Kap incorpora la certificación IP65 en sus modelos 50, 80 y 80 Plus (Fixed & Round), garantizando una protección excepcional frente al polvo y el agua. Esta versión permite su uso en entornos más exigentes, tanto en interiores como en exteriores protegidos. Su versatilidad amplía las posibilidades de iluminación sin comprometer la calidad de luz ni la armonía estética.





KAP 50

Kap 50 completes the range with a compact, high-performance solution that, thanks to new-generation LED technologies, guarantees optimal performance despite its small dimensions.

Kap 50 completa la oferta de la gama con una solución compacta y de gran rendimiento, que gracias a las tecnologías LED de nueva generación garantiza prestaciones óptimas a pesar de sus dimensiones reducidas.



KAP 50 ADJUSTABLE

Compact dimensions and great flexibility thanks to the mini adjustable versions, perfect for home and hotel applications.

Dimensiones compactas y gran flexibilidad, gracias a las versiones ajustables mini, perfectas para aplicaciones en hogares y hoteles.



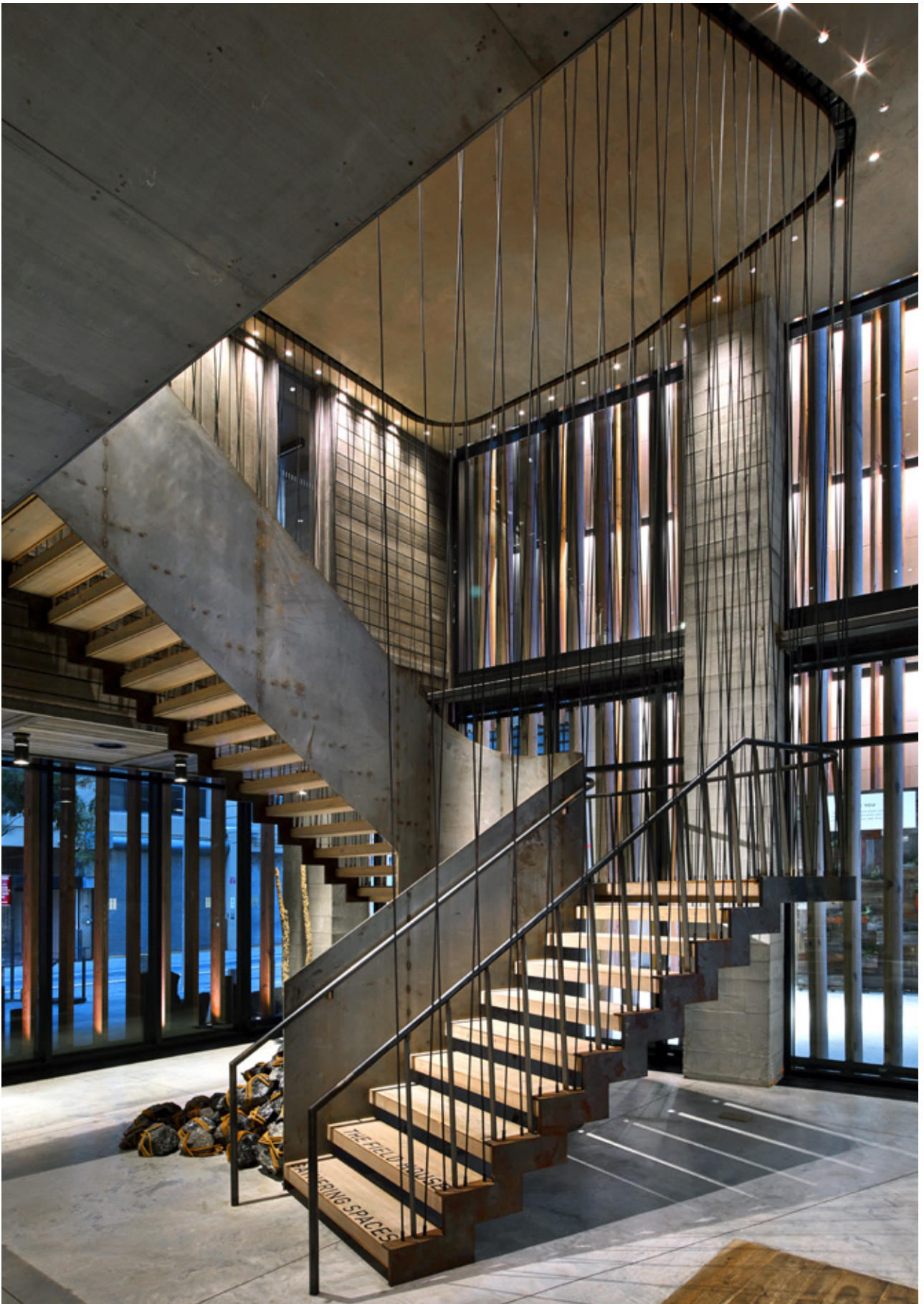

Hotel Brooklyn, New York

The recessed versions of KAP require individual installation accessories (pre-installation frames) available in Trim and No Trim versions (depending on the models, please consult). This recessed installation method is valid only for plasterboard ceilings.

Las versiones empotradas de KAP precisan de accesorios de instalación individual (premarcos) disponibles en versión Trim y No Trim (según los modelos, consultar). Este método de instalación empotrada es válido únicamente para techos de cartón-yeso (escayola).

Available can for the installation in cement ceilings.

Disponible can para instalación en techo de cemento.



KAP SQUARE

For all the solutions in the range, the purity of the square is available as an alternative to the classic version with a circular spotlight.

La pureza del cuadrado está disponible como alternativa a la versión clásica, con foco circular para todas las soluciones de la gama.

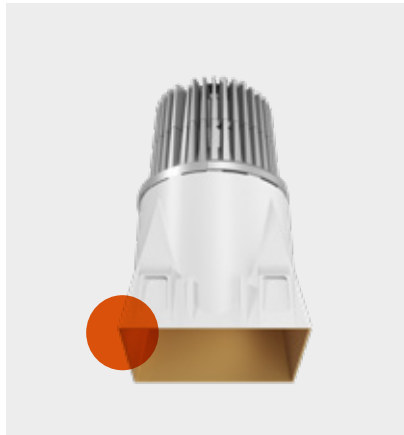

KAP ADJUSTABLE

Rotary body with integrated focal points locking mechanism. Perfect combined with intensive optics for flexible, high-contrast lighting controls.

Cuerpo giratorio con mecanismo de bloqueo de focalización integrado. Ideal en combinación con ópticas intensivas para controles de luz flexibles y de alto contraste.

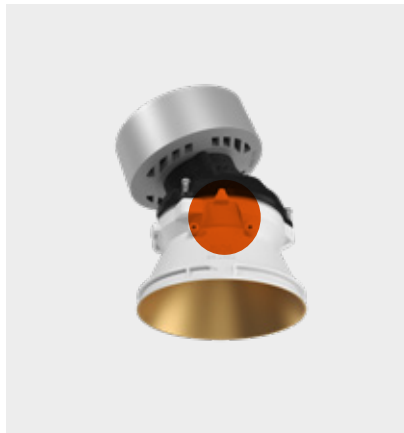

KAP DEEP

Dual-focus optics, ideal for managing environments with double volumes or high heights.

Óptica de doble foco, ideal para gestionar ambientes con volúmenes dobles o alturas elevadas.



KAP WALL-WASHER

Asymmetric optic for uniform lighting of vertical surfaces. Provides depth and greater perceived brightness to the room.

Óptica asimétrica para iluminación uniforme de superficies verticales. Proporciona profundidad y mayor brillo percibido al ambiente.

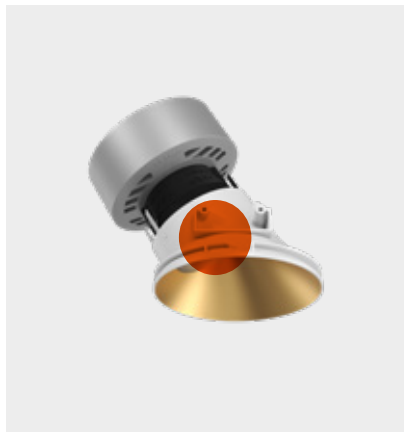



Arclinea Headquarters,
Italy



United Nations,
Geneva



With the same design as Kap 80, Kap 80 Plus stands out thanks to the exclusive dedicated sink, which improves the product's performance without altering the quality of the lighting effect.

Con el mismo diseño que Kap 80, Kap 80 Plus se destaca gracias al exclusivo disipador específico, el cual mejora el rendimiento del producto sin alterar la calidad del efecto luminoso.

All the Easy Kap 80 LED have an opaline diffuser that can be assembled to increase visual comfort and screening of the luminaire.

Todos los Easy Kap 80 LED llevan incluido un difusor opal que puede montarse para aumentar el confort visual y el apantallamiento de la luminaria.

Total No Trim effect achieved due to a new installation system. The bayonet-based assembly allows to replace the lamp without using any particular tools.

Efecto No Trim gracias a un nuevo sistema de montaje. Fácil mantenimiento de la lámpara sin necesidad de herramientas gracias a su montaje en bayoneta.

The luminaire includes a thermo-plastic diffuser which ensures a perfect light distribution on horizontal surfaces.

La luminaria incorpora un difusor realizado en material termoplástico para obtener una perfecta distribución de luz en planos horizontales.

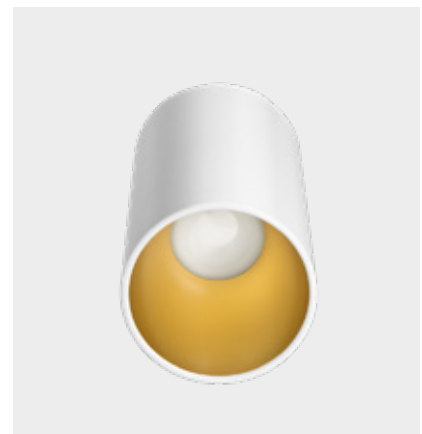

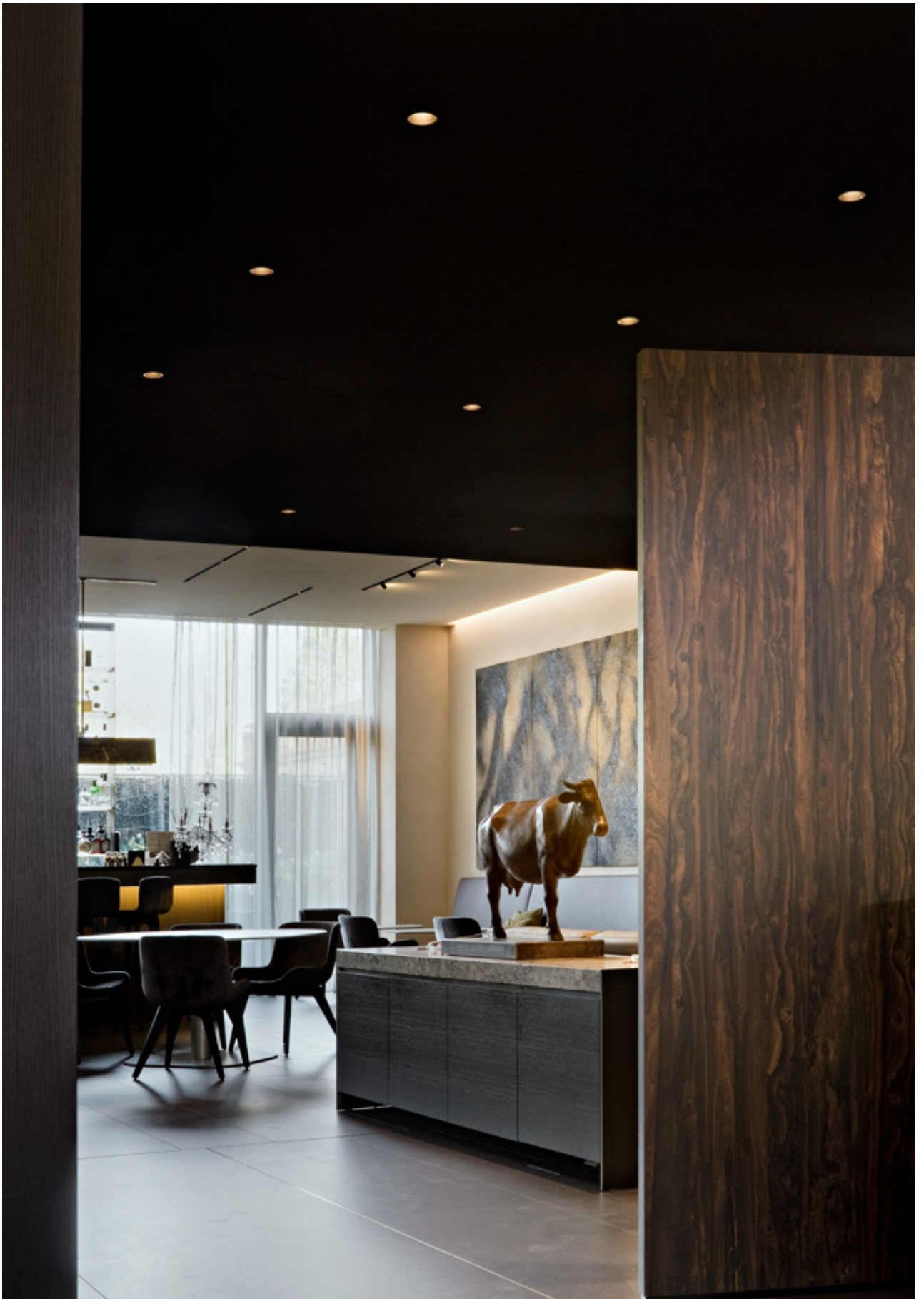

Viu Hotel, Italy



EASY KAP Ø30
FIXED



EASY KAP Ø30
ADJUSTABLE



EASY KAP Ø50
FIXED



EASY KAP Ø50
ADJUSTABLE



POWER LED
Up to 3,2W

LED ARRAY
7,5W



EASY KAP 80 / EASY KAP 80 PLUS
FIXED



EASY KAP 80 / EASY KAP 80 PLUS
ADJUSTABLE



EASY KAP 80 / EASY KAP 80 PLUS
WALL-WASHER



LED ARRAY
Up to 13W

LED ARRAY
Dim-To-Warm
13W

LED
QR-CBC 51
GX5.3

LED
PAR 16
GZ10

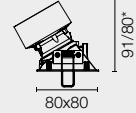
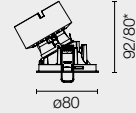
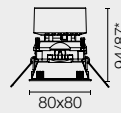
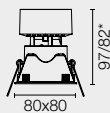
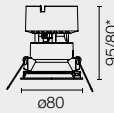

Easy Kap Plus / Easy Kap*

Easy Kap Plus / Easy Kap*

Easy Kap Plus / Easy Kap*

EASY KAP Ø105
FIXED



EASY KAP Ø105
ADJUSTABLE



EASY KAP Ø105
WALL-WASHER



LED ARRAY
23W

LED
QR-CBC 51
GX5.3

LED
PAR 16
GZ10

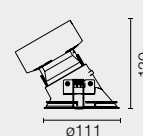
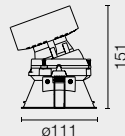
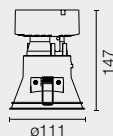

KAP Ø50
FIXED



KAP Ø50
ADJUSTABLE



LED ARRAY
7,5W



KAP 80 / KAP 80 PLUS
FIXED

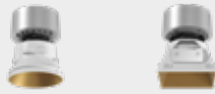

LED ARRAY
Up to 13W

LED ARRAY
Dim-To-Warm
13W

KAP 80 / KAP 80 PLUS
WALL-WASHER



LED
QR-CBC 51
GX5.3

LED
PAR 16
GZ10

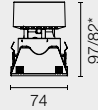
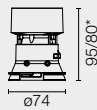

Kap Plus / Kap*

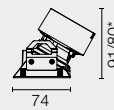
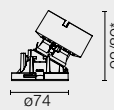

Kap Plus / Kap*

KAP 80 / KAP 80 PLUS
ADJUSTABLE



LED ARRAY
Up to 13W

LED ARRAY
Dim-To-Warm
13W

LED
QR-CBC 51
GX5.3

LED
PAR 16
GZ10

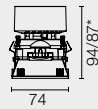
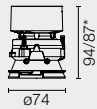

Kap Plus / Kap*

KAP Ø105
FIXED



LED ARRAY
23W

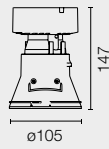

KAP Ø105
ADJUSTABLE



LED
QR-CBC 51
GX5.3

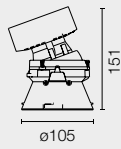

KAP Ø105
WALL-WASHER



LED
PAR 16
GZ10

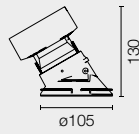

KAP Ø105
DEEP



LED ARRAY
23W

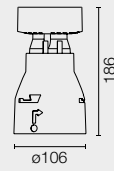

KAP 105
SQUARE



LED
QR-CBC 51
GX5.3

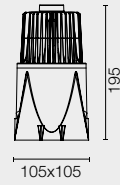

Spot



Medium



Flood



Wide Flood



Wall-Washer

□ B1 White
B1 Blanco



■ GL Matt Gold
GL Oro Mate



■ 74 Black
74 Negro





Spot



Medium



Flood

KAP 80 ROUND / SQUARE

Outside / Exterior

□ 11 White
11 Blanco

■ AN Black
AN Negro

■ 18 Deep Brown
18 Deep Brown

Inside / Interior

□ White
Blanco

■ Matt Gold
Oro Mate

■ Black
Negro



KAP Ø100

Outside / Exterior

□ 11 White
11 Blanco

■ AS Brushed Aluminium
AS Aluminio Satinado

■ B3 Brown
B3 Marrón

Inside / Interior

□ White
Blanco

■ Matt Gold
Oro Mate

■ Black
Negro

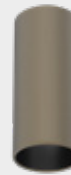

FLOS
CONTROL BY CASAMBI



c1 C

c1 c1 c1 c1 c1 c1 c1
c1 c1 c1 c1 c1 c1 c1

1 C1
C1

The simplicity of the cylinder hides an intelligent mechanism that allows for an amazing flexibility of the lighting body.

La sencillez del cilindro esconde un mecanismo inteligente que permite conseguir una asombrosa flexibilidad del cuerpo iluminante.

C1

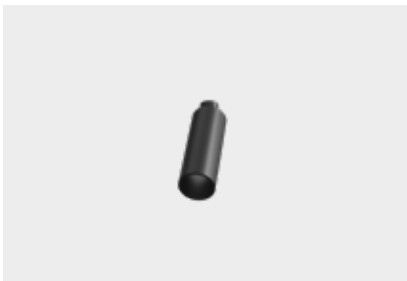

The range consists of two sizes, designed for ceiling or wall applications. The range of available powers and the dedicated optics kit make C1 ideal for applications in hotels and homes.

La gama está compuesta por dos tamaños, diseñados para aplicaciones en techo o en pared. La gama de potencias disponibles y el kit óptico específico convierten C1 en un producto ideal para aplicaciones en hoteles y ambientes domésticos.

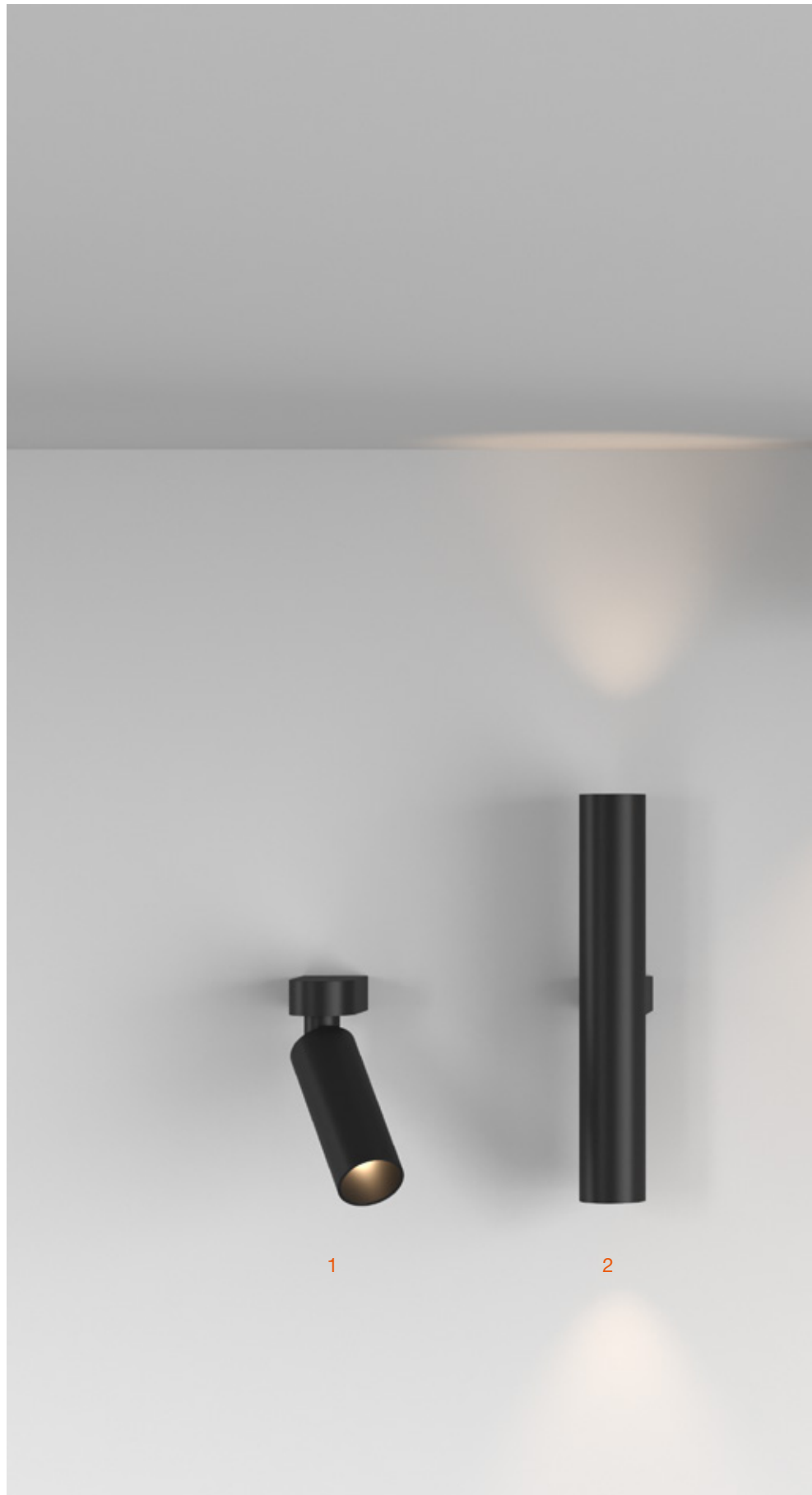

- 1 WALL DOWN
- 2 WALL UP&DOWN
- 3 CEILING
- 4 DOUBLE SURFACE









The optic group, placed far back on the body, hides the light source from the eye while controlling the direct illuminance for an absolute comfort effect. The special node, integrated into the product's body, allows it to be removed and directed at the base 60° on the vertical axis and 355° on the horizontal axis.

El grupo óptico colocado hacia atrás en el interior del cuerpo de la luminaria esconde la fuente de luz de la vista controlando la iluminación directa para un efecto confort total. La articulación especial, integrada en el cuerpo del producto, permite extraerlo y dirigirlo en la base de 60° en el eje vertical y 355° en el eje horizontal.



The wall-mounted versions are available for single and double emission applications. The lenses of the product guarantee a soft and diffuse light distribution for general room lighting.

Las versiones en pared están disponibles para aplicaciones de emisión simple o doble. Las lentes del producto garantizan una distribución de luz suave y difusa para la iluminación general de la estancia.



In applications where reading light is required, a concentrated spot emission is available, which is ideal for creating a relaxing scene during the night hours.

En las aplicaciones en las que se requiera una luz de lectura, está disponible una emisión puntual concentrada, ideal para crear un escenario relajante durante las horas nocturnas.







Villa La Saracena



This design features two extractable, adjustable spotlights and complements the existing recessed ceiling and wall models. The luminaire includes an integrated driver, it offers a versatile and sophisticated solution for any space with no need for drilling or building work.

Este diseño presenta dos focos extraíbles y orientables y complementa los modelos empotrados de techo y pared ya existentes. La luminaria incluye un driver integrado, lo que la convierte en una solución versátil y sofisticada para cualquier espacio sin necesidad de realizar perforaciones ni obras.





WALL UP&DOWN
SMALL



LED ARRAY
12W

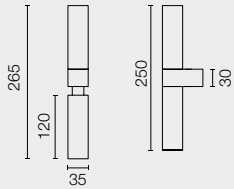

WALL DOWN
SMALL



LED ARRAY
6W

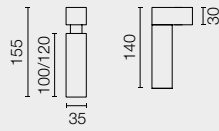

CEILING
SMALL



LED ARRAY
6W



DOUBLE SURFACE
SMALL



POWER LED
14,5W

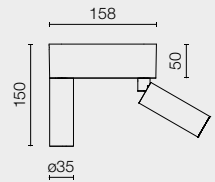

WALL UP&DOWN
LARGE



LED ARRAY
UP TO 28W

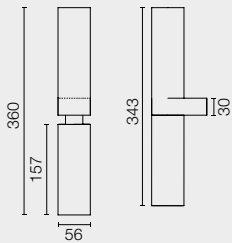

WALL DOWN
LARGE



LED ARRAY
UP TO 14W

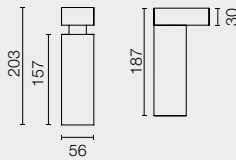

CEILING
LARGE



LED ARRAY
UP TO 14W



□ DY White
DY Blanco

■ DR Anthracite
DR Antracita

■ ER Brushed Steel
ER Acero Cepillado

■ ES Brushed Bronze
ES Bronce Cepillado



Can be rotated 180° and swivelled 60°.
Puede ser rotado 180° y orientado 60°.

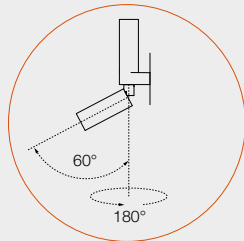

Wall

Can be rotated 355° and swivelled 60°.
Puede ser rotado 355° y orientado 60°.

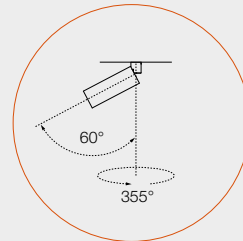

Ceiling & Surface



Spot



Medium



Flood



Wide Flood

FLOS
CONTROL BY CASAMBI



FIND

ME

ME

FIND

FIND

ME

ME

FIND

FIND

ME

ME

FIND

Indoor lighting projector with LED light source. Available in the Mono Point version (0, 1 and 2), featuring a removable cylindrical body that functions as a downlight or adjustable spotlight, and in the Suspension version, where the light point gains greater visual prominence.

Proyector de iluminación interior con fuente de luz LED. Disponible en versión Mono Point (0, 1 y 2), con cuerpo cilíndrico extraíble que actúa como downlight o proyector orientable, y en versión de Suspensión, donde el punto de luz adquiere mayor protagonismo visual.

FIND ME

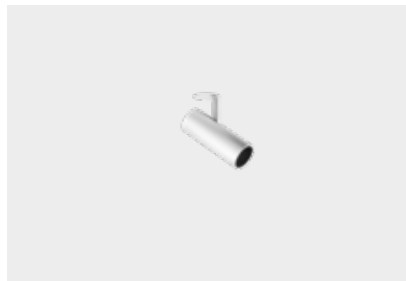
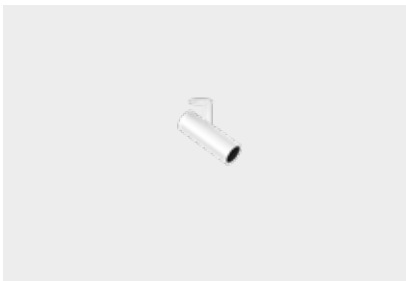

A timeless icon. Find Me reinterprets the traditional projector archetype through stylish and refined installation details that make it unique and inimitable.

Un icono atemporal. Find Me reinterpreta el arquetipo del proyector tradicional a través de detalles de estilo y refinamiento en la instalación que lo hacen único e inimitable.





This ingenious, recessed and adjustable indoor device features an ultra-minimalist design. Find Me 0 minimizes the size of the projector, reinterpreting the talent of its big brother Find Me on a small scale.

Este ingenioso aparato para interiores, empotrado y ajustable, encierra un diseño ultraminimalista. Find Me 0 reduce al mínimo el tamaño del proyector, reinterpretando a pequeña escala el talento de su hermano mayor Find Me.



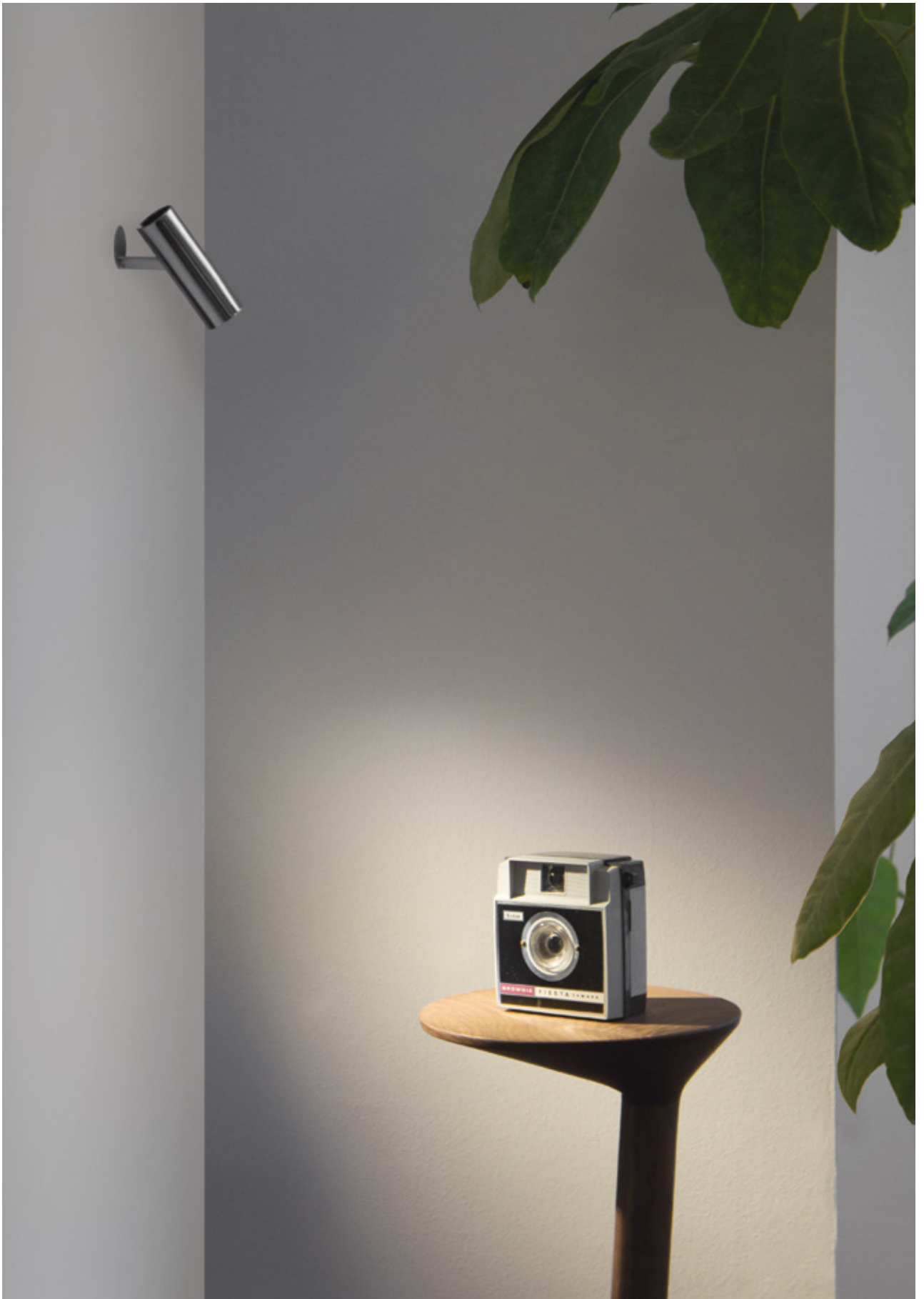



Il Sereno Hotel, Italy

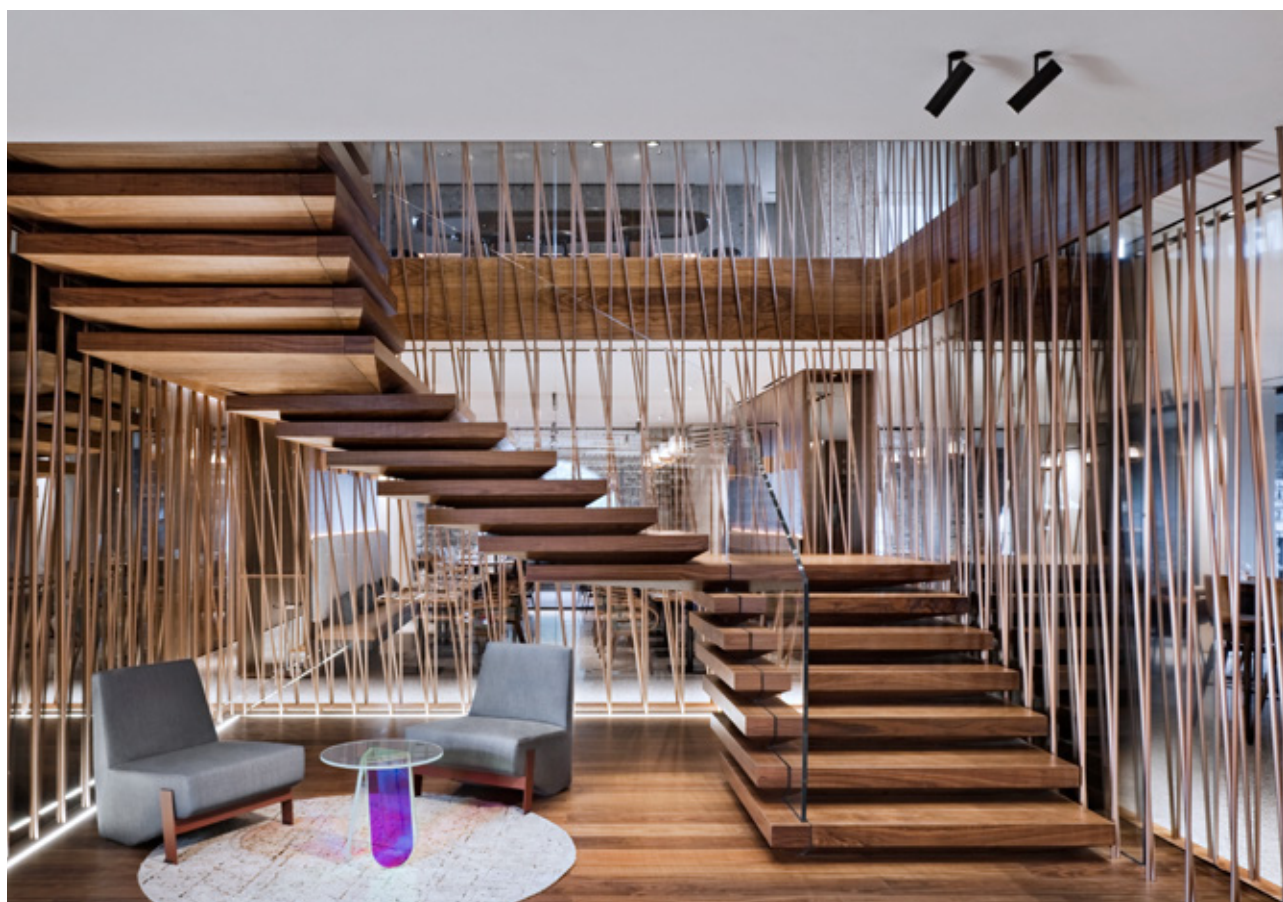
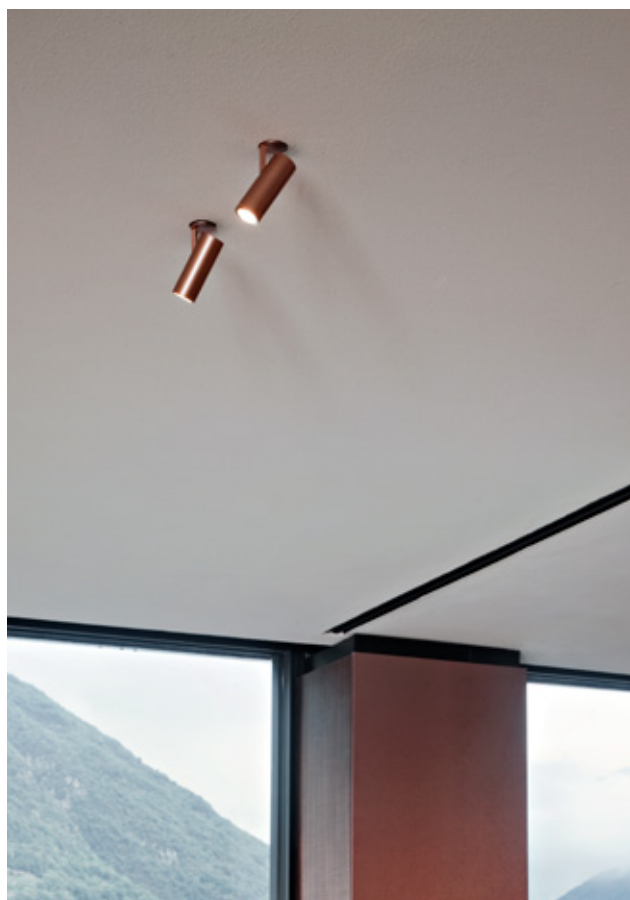



Directional and tilting thanks to its base with 360° rotation capacity and to its arm made of zamak, directional up to 70°.

Orientable y basculante gracias a su base con capacidad de rotación de 360° y a su brazo realizado en zamak orientable hasta 70°.

An adjustment system with elastic flanges on a toothed guide, permits concealing the spotlights, thus becoming totally integrated into the environment.

Sistema de desplazamiento mediante pestañas elásticas sobre una guía dentada que permite que los proyectores se escondan, quedando totalmente integrados en el entorno.



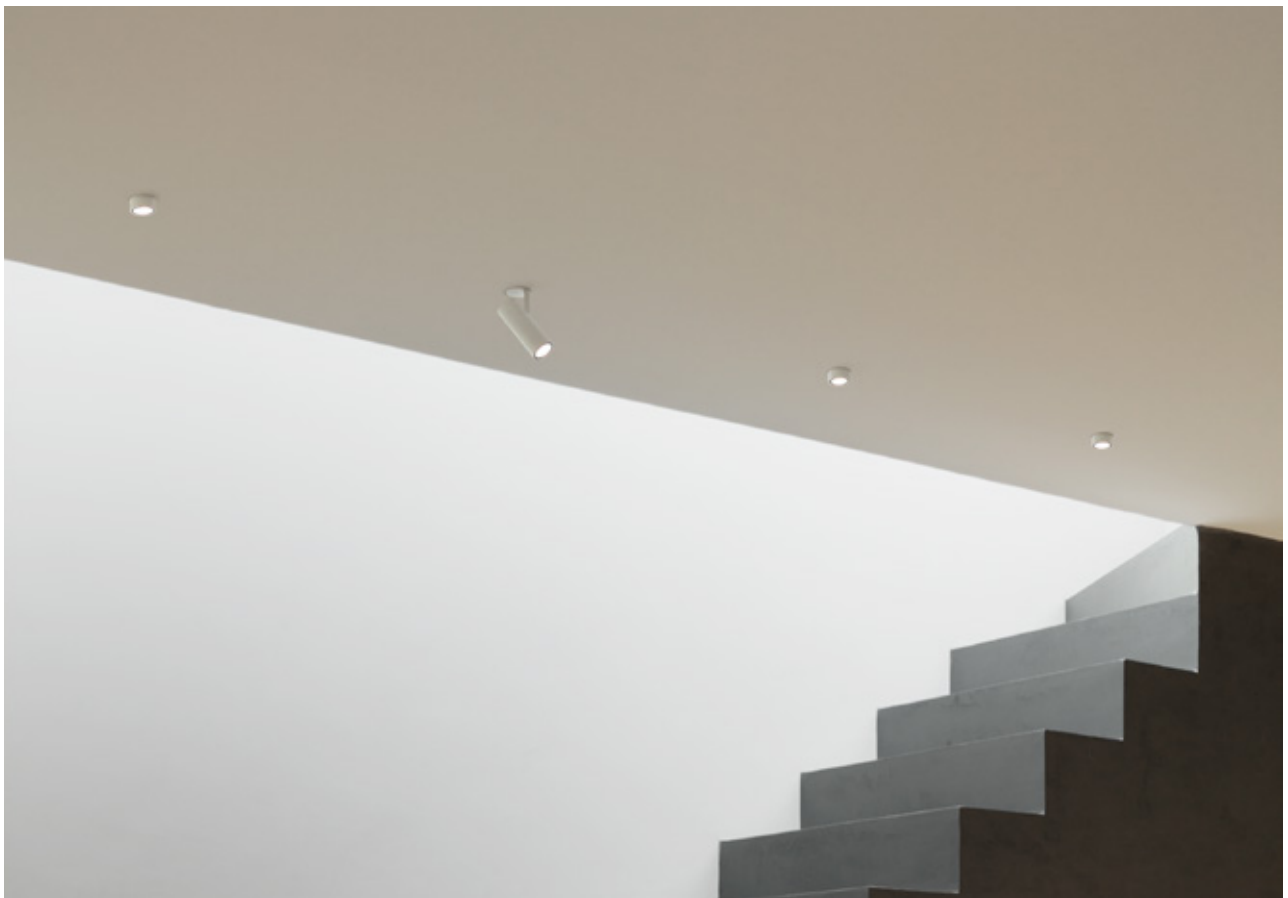

Hotel Colombo, Italy
Top



Carbonado Energy,
South Africa

FIND ME 0
TRIM / NO TRIM

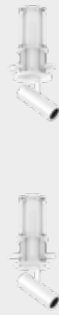

POWER LED
3,5W

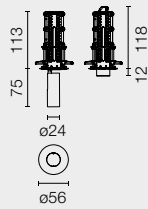

FIND ME 1
TRIM / NO TRIM

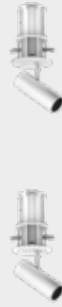

POWER LED
6W

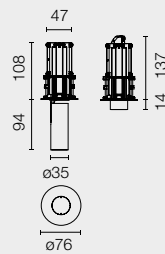

FIND ME 2
TRIM / NO TRIM



POWER LED
10W

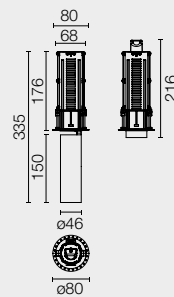

FIND ME 1
SUSPENSION



POWER LED
6W



FIND ME MONO POINT

□ 30 White
30 Blanco



◻ 05 Polished Silver
05 Plata Pulida



■ 14 Black
14 Negro



FIND ME SUSPENSION

□ 30 White
30 Blanco



◻ 05 Polished Silver
05 Plata Pulida



■ 14 Black
14 Negro



Screening Cylinder Colours (included)
Colores del Cilindro Apantallador (incluidos)

■ Orange
Naranja



■ Violet
Violeta



■ Black
Negro



Can be rotated 360° and swivelled 70°.
Puede ser rotado 360° y orientado 70°.

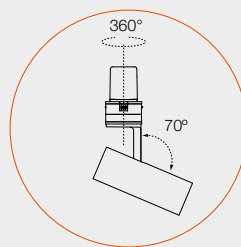

FLOS
CONTROL BY CASAMBI



UT

C

UT UT
UT UT

F

H

UT

D

UT



Victoria Beckham Store,
London



UT SPOT

High performance professional projector available with a wide range of lighting effects.

Proyector profesional de alto rendimiento disponible con un amplio abanico de efectos luminosos.

1 Multichip optical design to achieve very narrow beam angles.
Óptica multichip para conseguir ángulos de apertura muy cerrados.

2 A wall-washer version is available in Ø86 track version.
Versión wall-washer disponible en la versión track de Ø86.



1



2

UT SPOT ALL WHITE

New versions with the exclusive "all white" finish for the best possible integration into the environment.

Nuevas versiones realizadas con el exclusivo acabado "all white" para la mayor integración posible en el ambiente.

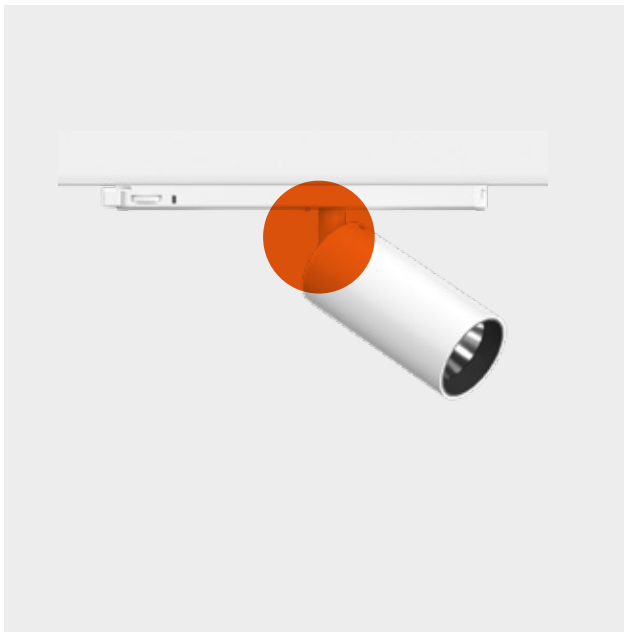

UT PRO SURFACE

Versions for surface installation with integrated base and power regulator included.

Versiones para instalación en superficie con placa integrada y regulador de potencia incluido.

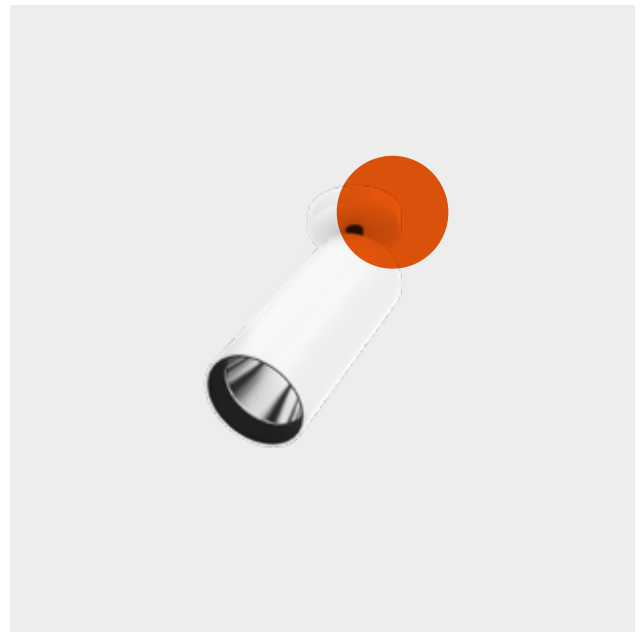



Flos Booth Euroshop Fair,
Germany



Central European University,
Budapest
Bottom

Boutek, Milan
Top

- 1 UT SPOT TRACK Ø57
- 2 UT SPOT TRACK Ø86 WALL-WASHER
- 3 UT DOWNLIGHT Ø86
- 4 UT PRO SURFACE 150

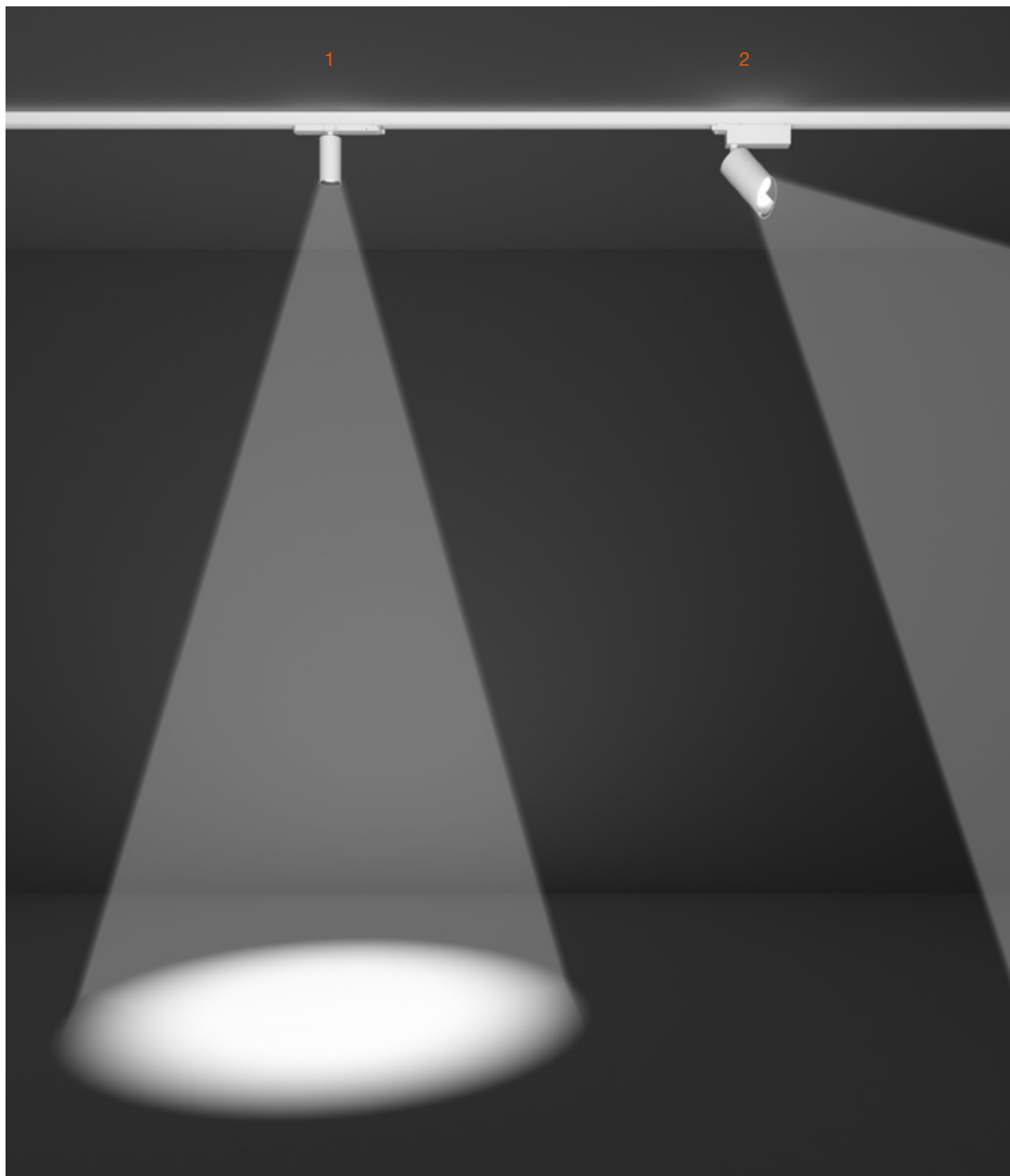

Complete professional program, ideal for controlling any retail application. The extended optics kit, powers and versatility that characterize each model make the UT range the perfect solution for any technical requirement of display areas.

Programa profesional completo, ideal para controlar cualquier aplicación de tienda. El kit de ópticas extendido, las potencias y la versatilidad que caracterizan cada modelo, hacen que la gama UT sea la solución perfecta para cualquier requerimiento técnico dentro de un espacio expositivo.

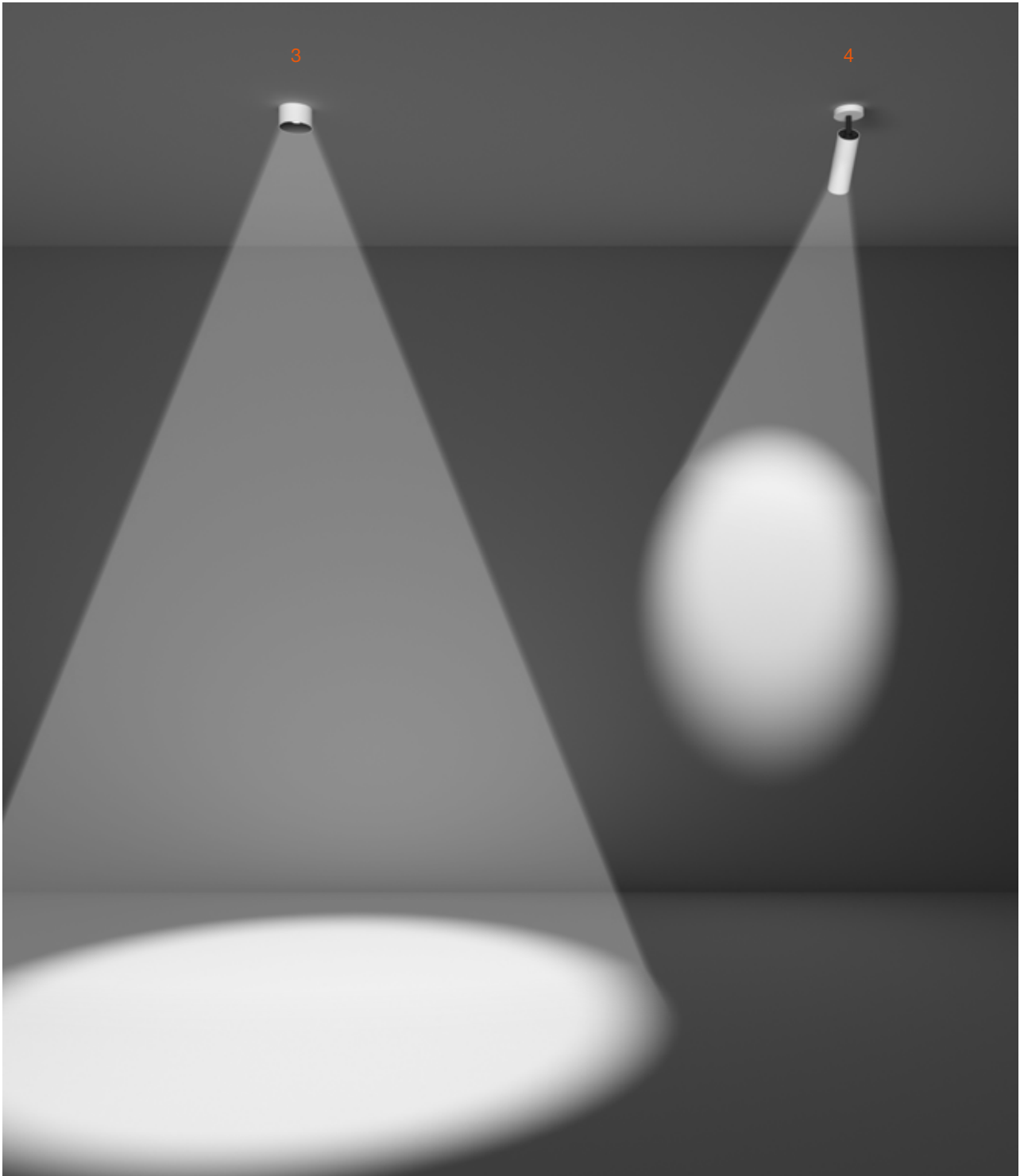



De Witte Duif,
Belgium

An adjustment system on a toothed guide permits concealing the spotlights, thus becoming integrated into the environment.

Sistema de ajuste mediante una guía dentada que permite que los proyectores se escondan, quedando integrados en el entorno.

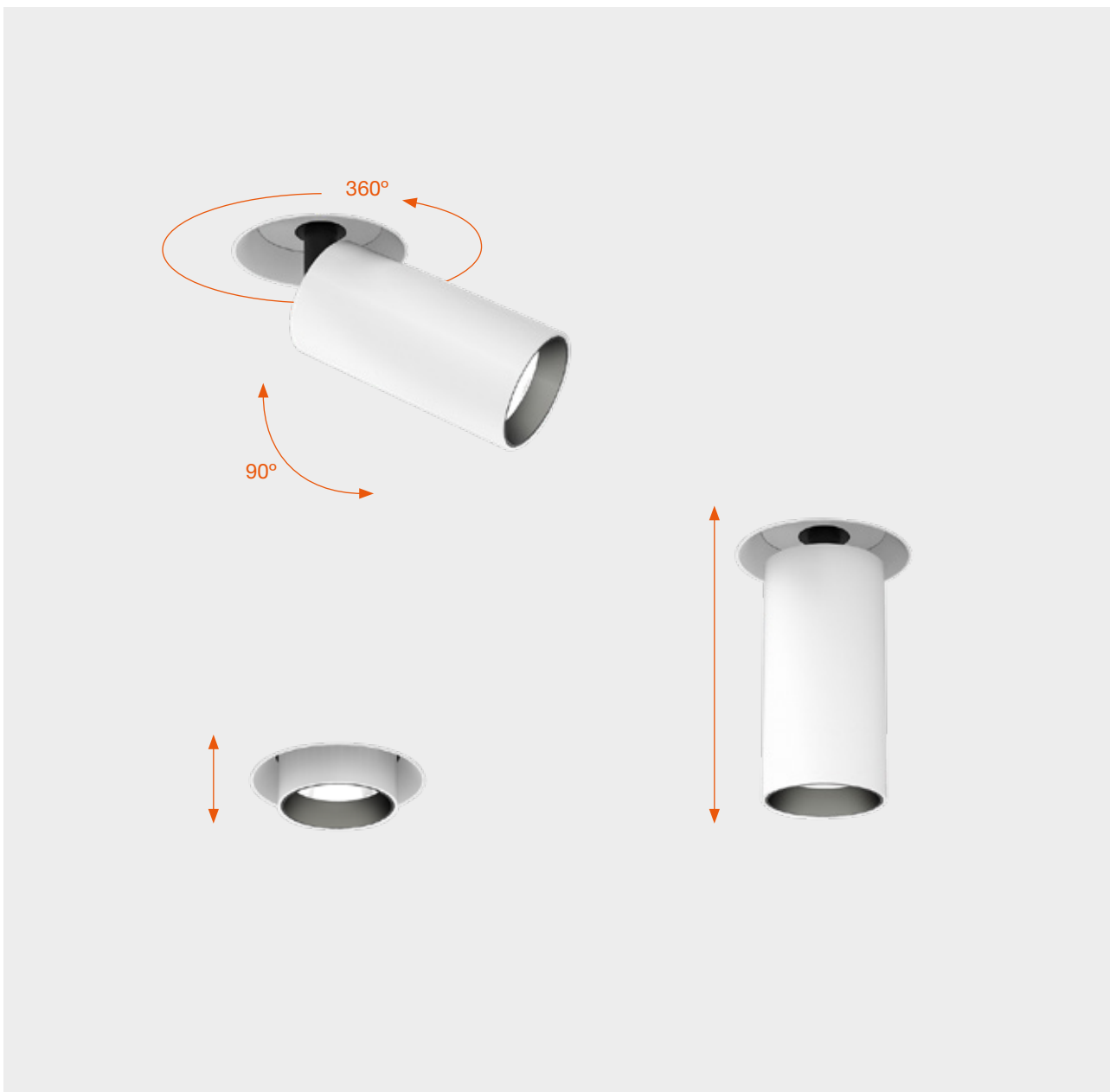





TRACK
Ø57

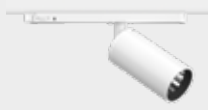

LED ARRAY
23,5W

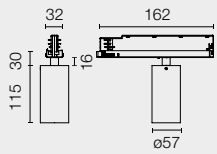

Dali Version

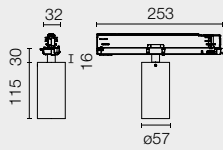

TRACK
Ø57



LED ARRAY
23,5W

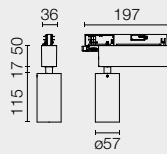

Dali Version

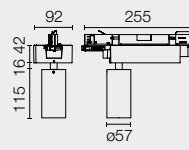

CEILING
Ø57



LED ARRAY
23,5W

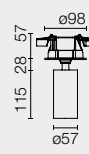

Super Spot



Spot



Medium



Flood

□ 30 White
30 Blanco

■ 14 Black
14 Negro

□ 30.78 All White
30.78 All White

□ 30 White
30 Blanco

■ 14 Black
14 Negro



Can be rotated 360° and swivelled 90°.
Puede ser rotado 360° y orientado 90°.

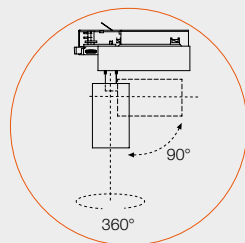

TRACK
Ø86

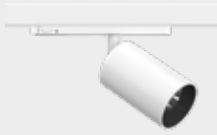

LED ARRAY
HIGH PERFORMANCES
33W

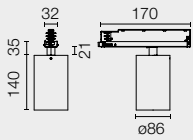

Dali Version

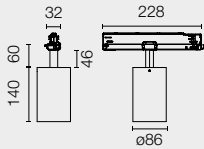

TRACK
WALL-WASHER
Ø86

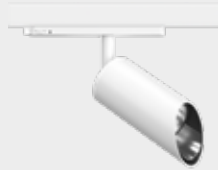

LED ARRAY
HIGH PERFORMANCES
33W

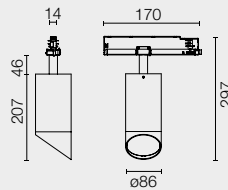

Dali Version

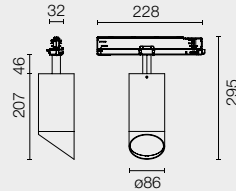

CEILING
Ø86



LED ARRAY
HIGH PERFORMANCES
33W

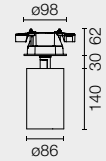

TRACK
Ø86



LED ARRAY
HIGH PERFORMANCES
33W

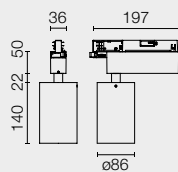

Dali Version

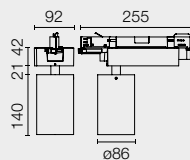

TRACK
WALL-WASHER
Ø86



LED ARRAY
HIGH PERFORMANCES
33W

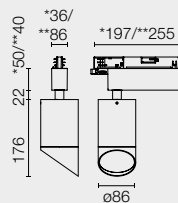

*Dimable/Non Dimable
**Dali Version

TRACK
MULTICHIP
Ø86

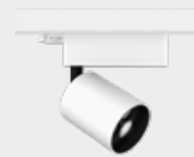

TOP LED
11,5W

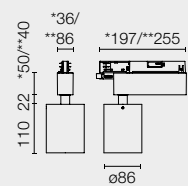

*Dimable/Non Dimable
**Dali Version

RECESSED

SURFACE

TRIM / NO TRIM
Ø57



LED ARRAY
18W

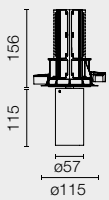
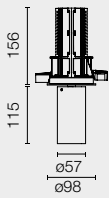

TRIM / NO TRIM
Ø86



LED ARRAY
HIGH PERFORMANCES
27W

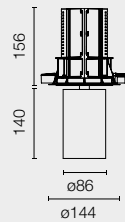
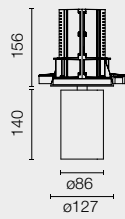

UT PRO SURFACE
150



LED ARRAY
21W

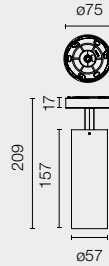

UT PRO SURFACE
175



LED ARRAY
35,3W

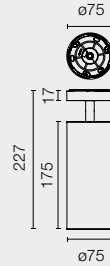

Can be rotated 360° and swivelled 90°.
Puede ser rotado 360° y orientado 90°.

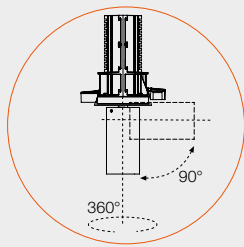

Spot



Medium



Flood

□ 30 White
30 Blanco



■ 14 Black
14 Negro



□ 30 White
30 Blanco



■ 14 Black
14 Negro



UT PRO 150
GA-69



LED ARRAY
20W

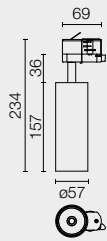

UT PRO 175
GA-69



LED ARRAY
35,3W

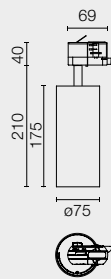

UT PRO 175 LENS
GA-69



LED ARRAY
35,3W

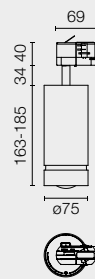

UT PRO WALL-WASHER
GA-69



TOP LED
25,5W

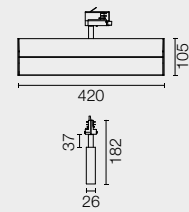

Compatible with The Tracking Power.
Compatible con The Tracking Power.



Spot



Medium



Flood



Wall-Washer

BON

BON JOUR

BON JOUR BON JOUR

BON JOUR BON JOUR

BON JOUR

BON JOUR BON JOUR

BON JOUR BON JOUR

JOUR

Recessed LED with an unusual design, thanks to the small edge that defines the presence of the luminaire. Comes in three sizes with different optics for a better personalisation. Pure lines highlighted with the refined finishes, in neutral and metal plated versions.

Empotrables LED de diseño peculiar, gracias al pequeño borde que define la presencia de la luminaria. Disponible en tres tamaños, con diferentes ópticas para mayor personalización. Líneas puras acentuadas por los refinados acabados, en versiones neutras y metalizadas.

BON JOUR



Bon Jour exploits an iconic conical light retriever visible after the installation. It is characterized by a unique internal geometry allowing it to completely eliminate visual glare and providing beautiful diffuse lighting at the same time.

Bon Jour aprovecha una emblemática pantalla cónica visible, caracterizada por una geometría interna exclusiva que le permite eliminar por completo el resplandor visual y proporcionar una maravillosa iluminación difusa al mismo tiempo.

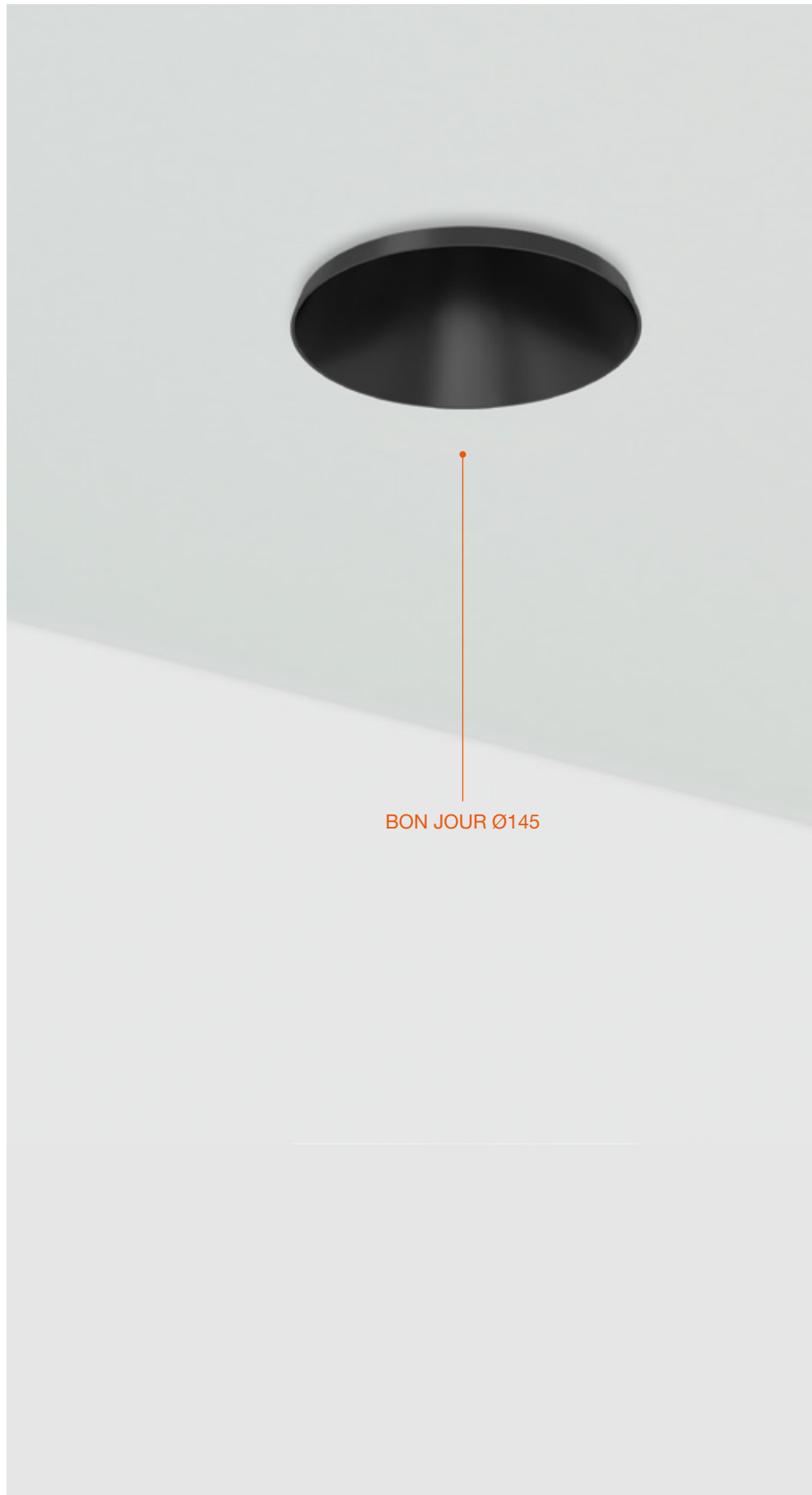

BON JOUR Ø145

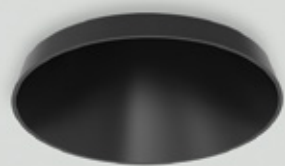

BON JOUR Ø90



BON JOUR Ø45

A unique product in its category, Bon Jour reinterprets the concept of downlighting through a remarkable design combined with the highest quality materials and finishes.

Producto exclusivo en su categoría, Bon Jour reinterpreta el concepto de downlight a través de un diseño único combinado con materiales y acabados de la más alta calidad.







BON JOUR
Ø45



POWER LED
6W



BON JOUR
Ø90



LED ARRAY
13,5W

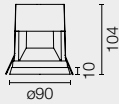

BON JOUR
Ø145



LED ARRAY
36W

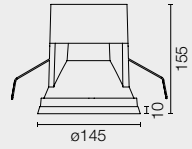

□ 01 White
01 Blanco

■ 14 Black
14 Negro



FLOS
CONTROL BY CASAMBI



Fort Knox Wall is a luminaire with coarse structure that produces an indirect and very powerful light beam, perfect for homes with protruding ceilings, working as natural diffuser.

Fort Knox Wall es una luminaria de estructura gruesa que produce un haz de luz indirecto muy potente, perfecto para hogares de techos prominentes utilizándolos como un difusor natural.

FORT KNOX



FORT KNOX WALL

Incredibly compact and discreet, Fort Knox Wall characterizes the environment with extremely controlled and homogeneous indirect light.

Increíblemente compacto y discreto, Fort Knox Wall caracteriza el entorno con una luz indirecta extremadamente controlada y homogénea.

Level for easy, integrated installation.
Highly efficient lens which directs the beam of light upwards.
Nivel para fácil instalación integrado.
Exclusiva lente de alta eficiencia que consigue orientar el haz de luz hacia arriba.

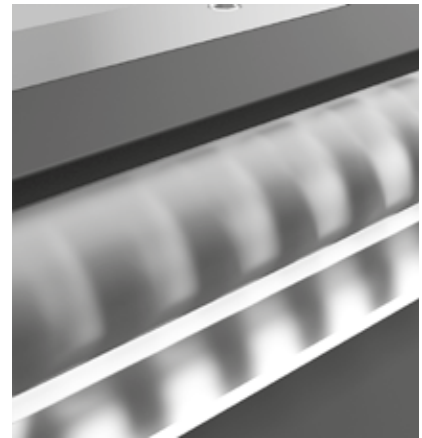

FORT KNOX WALL MINI

The strong asymmetry of the effect eases the management of the most complex spaces even in the new miniaturized version Fort Knox Wall Mini.

La fuerte asimetría del efecto permite administrar fácilmente los espacios más complejos incluso en la nueva versión miniaturizada Fort Knox Wall Mini.







Sensory Apartment
Palazzo Poste, Italy

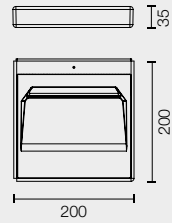
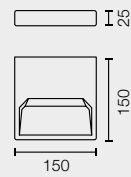

FORT KNOX
WALLPOWER LED
35WFORT KNOX
WALL MINIPOWER LED
25WAsymmetric
Flood

□ 40, 30 White
40, 30 Blanco



◊ 05 Polished Silver
05 Plata Pulida



■ 14 Black/RAL 9005
14 Negro



In-Finity, Circle of Light, Light Cut Mini, Light Bell,
Thin Led, Light Supply, Johnny, Wan Spot, G-O,
The BlockOfLight

SOPHISTICATED COMMODITIES

IN-FINITY

Designed by Flos Architectural

For lighting professionals looking for the backbone of a lighting installation for an office or public space project, the In-Finity LED lighting system offers coherent solutions suitable for any kind of installation, with luminaires designed for use as a single light source or arranged in an infinite light line. In-Finity delivers visual comfort and energy efficiency, combining high performance with impeccable aesthetics and top quality construction. All project needs can be satisfied with combinations of the three profile widths, the various installation options (recessed trim and no trim, surface-mounted and suspended) and diffuse or concentrated glare-free light versions to meet ambient design requirements.

Para profesionales que buscan una instalación de iluminación principal para oficinas o espacios públicos, In-Finity es un sistema de iluminación LED que ofrece soluciones adecuadas para cualquier tipo de instalación, con luminarias diseñadas para ser utilizadas como fuente de luz puntual o como línea continua de luz. In-Finity no solo proporciona un cómodo y eficiente confort visual, sino que combina prestaciones de alta calidad y estética. Todas las necesidades de un proyecto pueden satisfacerse combinando las tres anchuras del perfil, las diferentes alternativas de instalación (empotrada trim y no trim, superficie y suspensión) y las versiones de luz difusa o concentrada para responder a los requisitos ambientales del diseño.

Modular profile for recessed installation. Available in three different sections (35 and 70 mm). It can be adapted to any architectural environment thanks to its subtle and purely technical aesthetics. The profile's lighting emission can be customized thanks to the optional screens available for both diffuse and controlled light.

Perfil modular para instalación empotrada. Disponible en tres secciones diferentes (35 y 70 mm), puede ser adaptado a cualquier ambiente arquitectónico gracias a una estética esencial y puramente técnica. La emisión luminosa del perfil se puede personalizar gracias a las pantallas opcionales disponibles para luz difusa y luz controlada.



Find out more at
flos.com/infinity35



Find out more at
flos.com/infinity70

RECESSED



Porcelanosa Showroom,
Spain



Fantini Showroom, Italy



Gomarco Headquarters,
Spain

Modular profile for ceiling and wall installation. Available in three different sections (25, 35 and 70 mm). It can be adapted to any architectural environment thanks to its subtle and purely technical aesthetics. The profile's lighting emission can be customized thanks to the optional screens available for both diffuse and controlled light.

Perfil modular para instalación en techo y en pared. Disponible en tres secciones diferentes (25, 35 y 70mm), puede ser adaptado a cualquier ambiente arquitectónico gracias a una estética esencial y puramente técnica. La emisión luminosa del perfil se puede personalizar gracias a las pantallas opcionales disponibles para luz difusa y luz controlada.

SURFACE

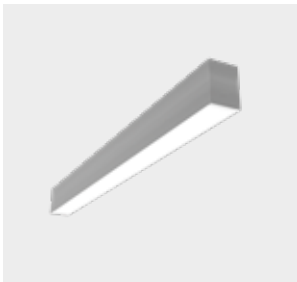

Modular profile for suspension installation. Available in three different sections (25, 35 and 70 mm). It can be adapted to any architectural environment thanks to its subtle and purely technical aesthetics. The profile's lighting emission can be customized thanks to the optional screens available for both diffuse and controlled light.

Perfil modular para instalación en suspensión. Disponible en tres secciones diferentes (25, 35 y 70mm), puede ser adaptado a cualquier ambiente arquitectónico gracias a una estética esencial y puramente técnica. La emisión luminosa del perfil se puede personalizar gracias a las pantallas opcionales disponibles para luz difusa y luz controlada.

SUSPENSION





CIRCLE OF LIGHT

Designed by Flos Architectural

Family of circular ceiling-mounted recessed luminaires, which are totally integrated owing to Soft Architecture technology. The Circle of Light is comprised of an outer frame made with composite that houses a metal structure. This, in turn, acts as support for the latest generation LED spotlights. Its lenses optimise the luminous performance of the luminaire together with anti-glare cones that guarantee high visual comfort.

Familia de luminarias circulares para empotrar en techo, que se integran totalmente gracias a la tecnología Soft Architecture. Circle of Light se compone de un marco exterior realizado en composite sobre el que se aloja una estructura metálica que sirve de soporte para los proyectores LED de última generación. Dispone de lentes que optimizan la eficiencia lumínica de la luminaria junto con conos anti deslumbramiento que garantizan un alto confort visual.

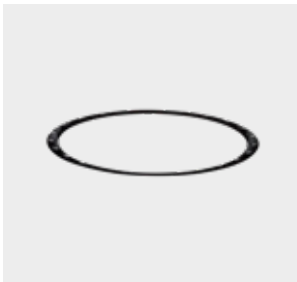

Find out more at
flos.com/circleoflight

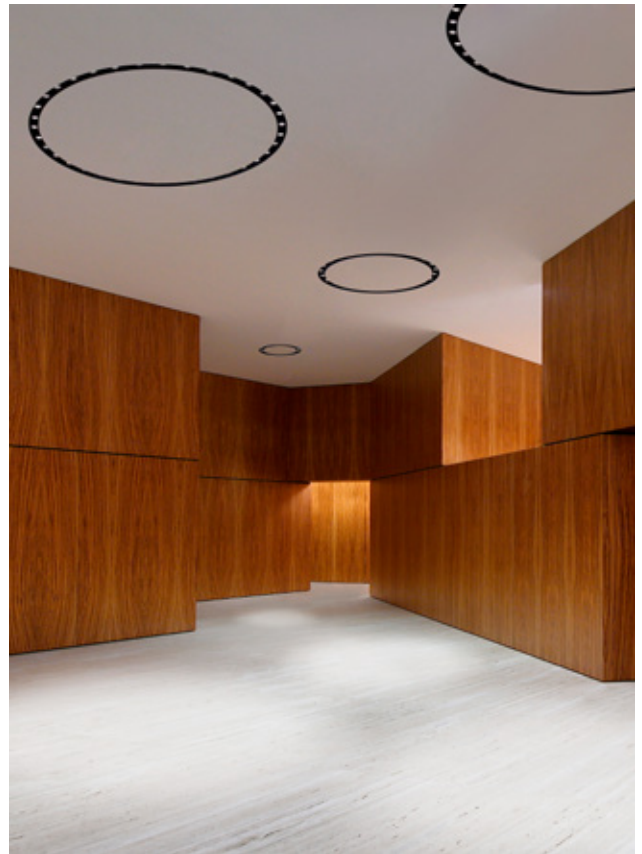

Private Hall Entrance,
Spain

LIGHT CUT MINI

Designed by Flos Architectural

A structural system integrated into the architecture, which permits mounting direct and indirect lighting gear. The Light Cut Mini system can be equipped with latest generation LED spotlights.

Sistema estructural integrado en la arquitectura que permite la instalación tanto de equipos de iluminación directa como de equipos de iluminación indirecta. El sistema Light Cut Mini se puede equipar con proyectores LED de última generación.

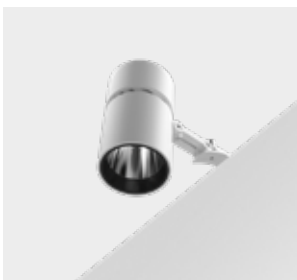

Find out more at
flos.com/lightcutmini

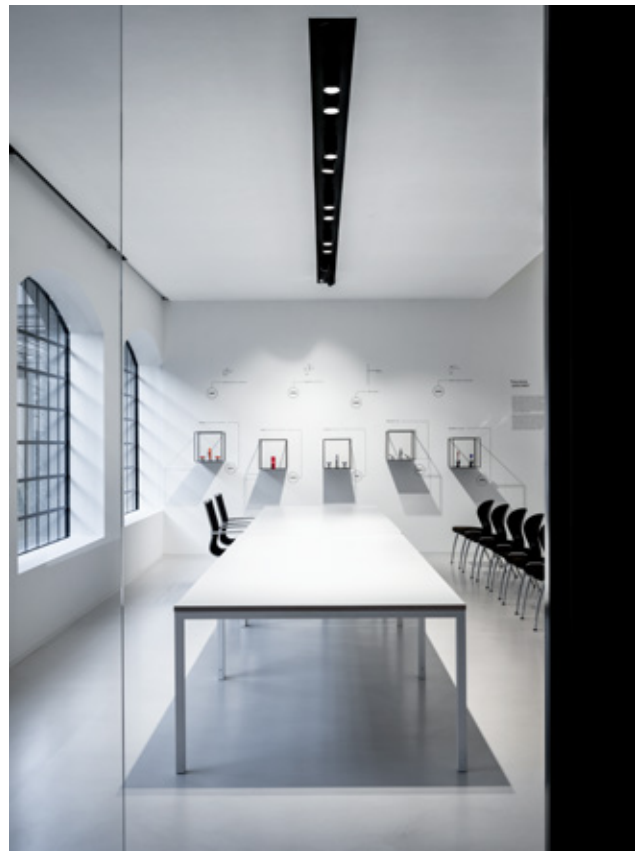

Fantini Showroom, Italy



LIGHT BELL

Designed by Piero Lissoni

Suspended general lighting luminaire for indoor mounting. It has a high efficiency, latest generation LED light source and a low-loss technical thermoplastic diffuser. The luminaire reflector is made of spun aluminium, available in different patterns inside as well as outside and in transparent glass.

Luminaria suspendida de iluminación general para ser instalada en interiores. Cuenta con una fuente de luz LED de última generación de alta eficiencia y difusor realizado en termoplástico técnico de bajas pérdidas. El reflector de la luminaria está realizado en aluminio repulsado, disponible en distintos decorados tanto interiores como exteriores y cristal transparente.



Find out more at
flos.com/lightbell





THIN LED

Designed by Flos Architectural

Wall-mounted profile for indirect lighting. Essential and minimal for perfect integration into the surrounding architectural space. Thin, but with really high lighting performances. A unique device for even and spotless asymmetrical lighting.

Perfil de pared para iluminación indirecta. Mínimo y esencial para una perfecta integración en el entorno arquitectónico. De reducidas dimensiones pero con un alto rendimiento luminoso. Un aparato único para una iluminación asimétrica perfectamente uniforme.



Find out more at
flos.com/thinled





LIGHT SUPPLY

Designed by Flos Architectural

High-power recessed elements with avant-garde LED modules. Compact size with maximum integration into the architecture. Comes in fixed, wall-washer and adjustable versions, with professional screening accessories.

Empotrables de alta potencia con módulos de LED de última generación. Tamaño compacto que supone la máxima integración en la arquitectura. Disponible en versiones fija, wall-washer y ajustable, también con accesorios profesionales de apantallamiento.



Find out more at
flos.com/lightsupply

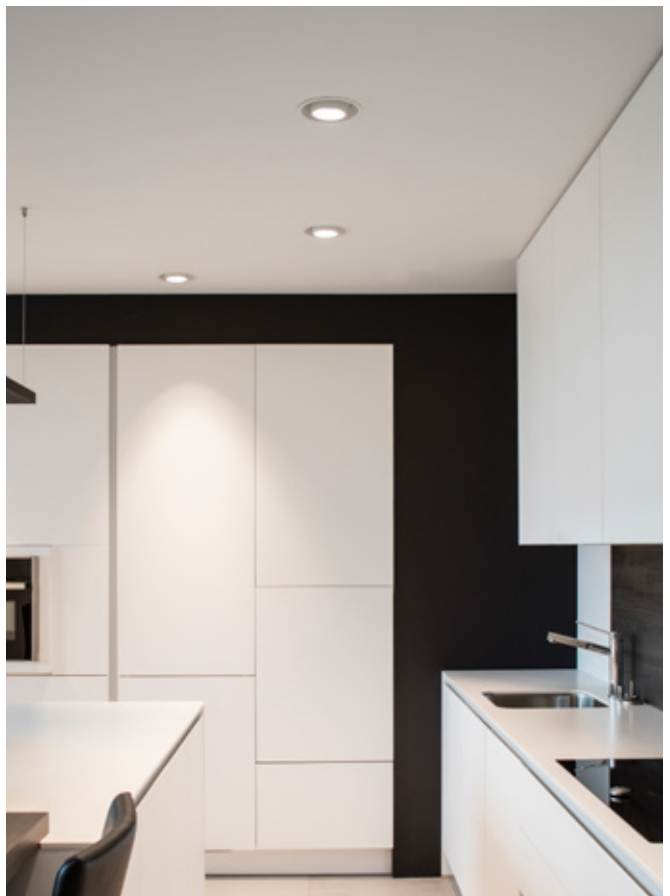

Sublime Store, Belgium

JOHNNY

Designed by Flos Architectural



Find out more at
flos.com/johnny

Versatile projector thanks to the two available sizes and the great variety of installation possibilities. Possibility of maximum integration in the recessed version, or of a stronger aesthetic presence in the semi-recessed versions with exclusive finishes. Fitted with a mechanical rotation system that ensures efficiency, integration and stability over time. Includes different versions for a fast frame-free installation with the Fast&Perfect system.

Proyector versátil gracias a los dos tamaños disponibles y a la gran variedad de posibilidades de instalación. Posibilidad de máxima integración en la versión empotrada, o de mayor presencia estética en las versiones semi-empotradas con acabados en materiales exclusivos. Dotado de sistema mecánico de rotación que garantiza su eficiencia, integración y estabilidad en el tiempo. Incluye versiones para instalación rápida sin marco con nuestro sistema Fast&Perfect.



ROUND 80 RECESSED



ROUND 120 RECESSED

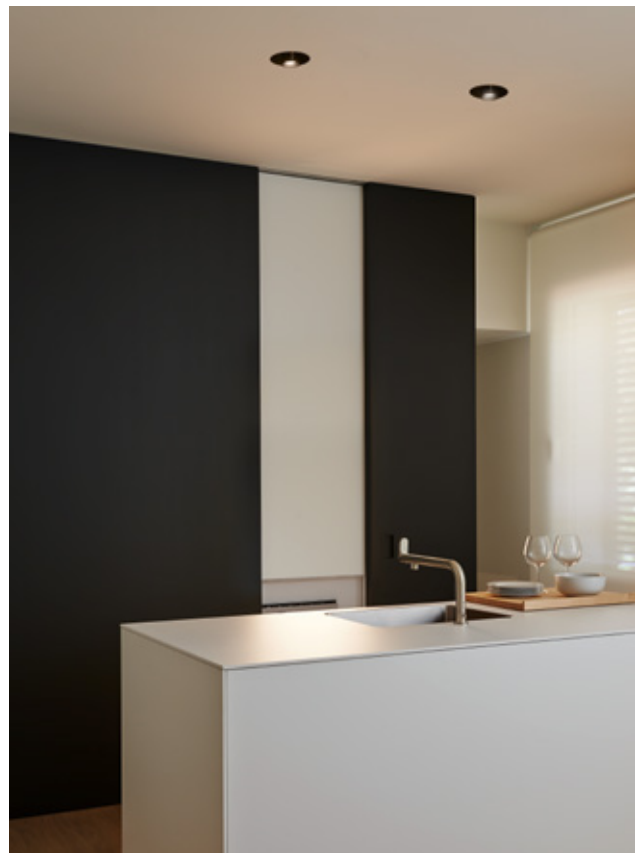

Johnny 80 / Johnny 80 Semi-recessed: with the tilt orientation system the spotlight head can be pulled and tilted in the desired direction.

Johnny 80 / Johnny 80 Semi-empotrado: sistema de orientación basculante que permite sacar la cabeza del proyector para su correcta orientación.

Box for semi-embedded installation. Available with cement, teak, white or black finishes, according to the versions.

Box para instalación semi-empotrada. Disponible en acabados cemento, teca, blanco o negro según las versiones.

SQUARE 80 RECESSED



SQUARE 80 SEMI-RECESSED



Johnny 120 / Johnny 120 Semi-recessed: a mechanic orientation system that enables pulling the head out of the projector for a correct orientation.

Johnny 120 / Johnny 120 Semi-empotrado: sistema de orientación mecánico que permite sacar la cabeza del proyector para su correcta orientación.

Box for semi-embedded installation. Available with cement, teak, white or black finishes, according to the versions.

Box para instalación semi-empotrada. Disponible en acabados cemento, teca, blanco o negro según las versiones.

SQUARE 120 RECESSED



SQUARE 120 SEMI-RECESSED

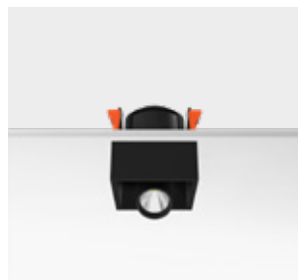



WAN

Designed by Johanna Grawunder

Family of lighting devices whose shape is inspired by the Japanese culture: in fact, "wan" means "cup" but in a figurative sense it is understood as a "life container". Two versions: one spot, equipped with a special beam directional system and a second one for recessed systems. Available with halogen or metal halide lamps to adapt to different situations, either in residential or professional sectors. Also available with the new LED lamp.

Familia de aparatos de iluminación cuya forma está inspirada en la cultura japonesa: "wan" de hecho significa taza, entendido en sentido figurado como "contenedor de la vida". Dos versiones: una spot, equipada de un especial sistema de orientación del haz luminoso, y otra empotrable. Disponible con lámparas halógenas o halogenuros metálicos para adaptarse a diversas situaciones, tanto en el ámbito residencial como en el profesional. También disponible con la nueva lámpara LED.

SPOT

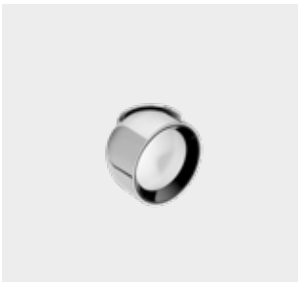

Find out more at
flos.com/wanspot



Private House, Italy



Private House, Italy

G-O

Designed by Jorge Herrera

Recessed luminaire with IP65 protection degree for indoors/outdoors use. Equipped with latest generation LED, G-O is especially designed as bollard lighting for pathways or steps. It is available in white, aluminium, stainless steel, bronze and black finishes. The optical equipment can transmit warm white or amber light thanks to the coloured diffusers on the inside.

Luminaria empotrada con grado de protección IP65 para uso interior/exterior. Equipada con LED de última generación, G-O está especialmente concebido para servir de señalización a lo largo de caminos de paso o escaleras. Está disponible en los acabados blanco, aluminio, acero inoxidable, bronce y negro. El equipo óptico puede emitir luz blanca cálida o ámbar gracias a los difusores coloreados de su interior.



Find out more at
flos.com/go

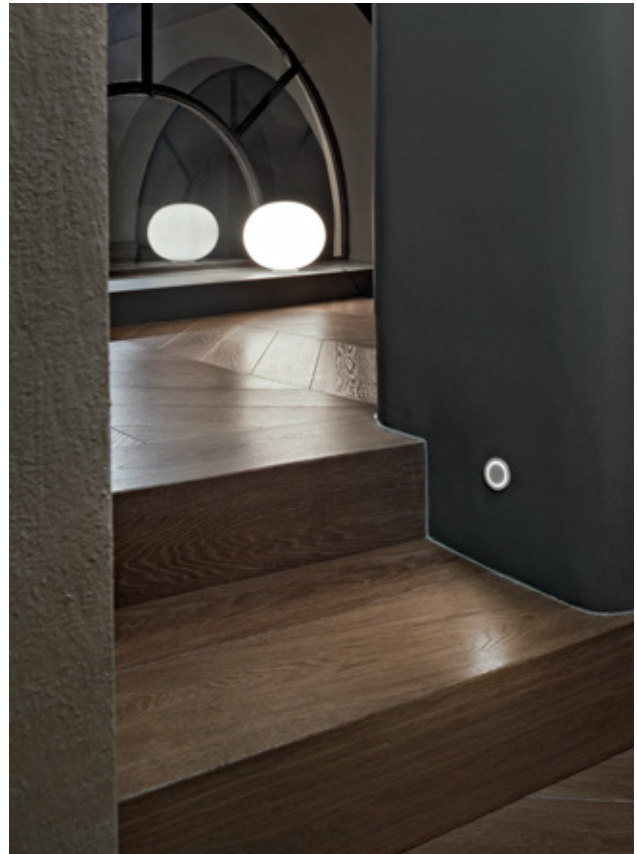

Montenapoleone Vip Lounge, Italy

THEBLOCKOFLIGHT

Designed by Knud Holscher

Recessed signage luminaire. Perfect for indoors/outdoors thanks to its IP65 protection degree. TheBlockofLight has a latest generation Power LED and an opal diffuser for optimal light distribution.

Luminaria empotrada de señalización. Perfecta para interiores/exteriores gracias a su grado de protección IP65. TheBlockofLight cuenta con un Power LED de última generación y un difusor opal que hace que la distribución luminosa sea óptima.



Find out more at
flos.com/theblockoflight

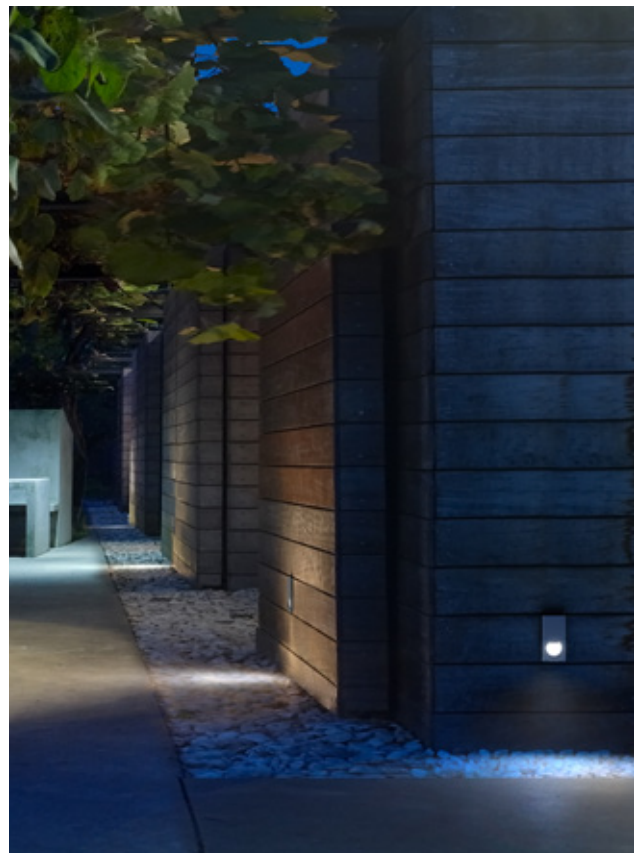



Juncos, Soft Spun, Abajourd'hui, Uso,
Uso Cove Lighting, G-O In, Teardrop,
Round, Square & Vertical Light.

SOFT ARCHITECTURE



A NATURAL FUSION OF SUBSTANCE AND ENERGY, BETWEEN LIGHT AND ARCHITECTURE
 UNA FUSIÓN NATURAL ENTRE MATERIA Y ENERGÍA, ENTRE LA LUZ Y LA ARQUITECTURA

Loving light and architecture, melting them in the most creative solutions, looking for the most advanced, lighting and technical aims and fully respecting the environment: Flos Soft-Architecture is the new philosophy to live poetically the fusion of substance and energy.

Amar la luz y la arquitectura, fundirlas con las soluciones más creativas, teniendo como objetivo la búsqueda de las técnicas de iluminación más avanzadas dentro del total respeto del ambiente: Flos Soft-Architecture es una nueva filosofía para vivir poéticamente la fusión entre materia y energía.

Respecting nature and its balance understanding its value and being inspired by its perfection: Flos Soft-Architecture is the result of an in-depth lighting and technical research on the use of eco-friendly materials with a low impact on the environment.

Respetar la naturaleza y su equilibrio, comprender su importancia y sacar inspiración de su perfección: Flos Soft-Architecture es el fruto de una profunda búsqueda sobre el uso de los materiales eco-compatibles de bajo impacto ambiental.

Flos Soft-Architecture is a perfect fusion of substance and energy and benefits of the most advanced energy saving sources (LED, Remote Phosphor LED, Power LED, cold cathode, compact fluorescent, halogens, IRC/ES) in order to grant a perfect integration of light, architecture and nature.

Unión perfecta de materia y energía, Flos Soft-Architecture utiliza las más avanzadas fuentes para el ahorro de energía (LED, LED a fósforo remoto, power LED, cátodo frío, fluorescencia compacta, halógena, IRC/ES) con el fin de garantizar una síntesis perfecta entre luz, arquitectura y naturaleza.



1 "Respecting Nature and its Balance".
 "Respeto por la Naturaleza y su Equilibrio".

2 Soft Architecture Manufacturing.
 Producción de Soft Architecture.

3 Sustainable Lifecycle.
 Ciclo de Vida Sostenible.

4 Relocation with no Environmental Impact.
 Reciclaje sin Impacto Ambiental.

5 Sale and Installation.
 Venta e Instalación.



In the Flos Architectural factory, traditional techniques and pioneering formulas blend together to create products that have never before existed. Making use of an innovative plaster composition, our Soft Architecture series of seamless lighting appliances comes to life through the hands of skilled local artisans. Flos Soft Architecture is a great example of contemporary, waste-free manufacturing, modelled by nature's very own processes.

En la fábrica de Flos Architectural, las técnicas tradicionales y las fórmulas pioneras se unen para crear productos completamente nuevos. Gracias a una composición innovadora de yeso, nuestra línea Soft Architecture de aplicaciones de iluminación integrada cobra vida a partir de las manos de nuestros talentosos artesanos locales. Soft Architecture de Flos es un magnífico ejemplo de producción contemporánea sin residuos, modelada por la misma naturaleza del proceso.





JUNCOS

Designed by Flos Soft Architecture

Luminaire inspired by 'bunches of reeds' hovering over the water surface. With a high power LED, the tube can be tilted and inserted or removed from the ceiling to direct the beam of light and create the desired artistic composition.

Luminaria inspirada en los grupos de juncos que asoman por la superficie del agua. Con un LED de alta potencia, el tubo se puede bascular e introducir o sacar del techo para orientar el haz de luz y crear la composición deseada.

JUNCOS 1L

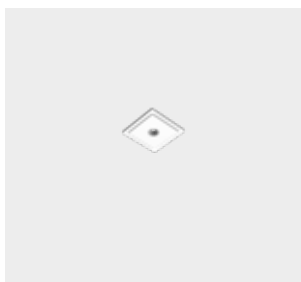

JUNCOS 6L

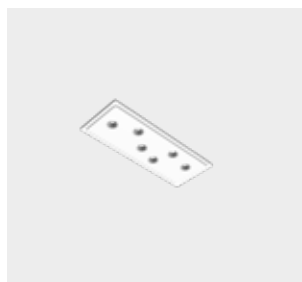

JUNCOS 250 mm



JUNCOS 3L



JUNCOS 9L

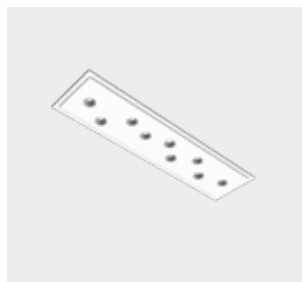

JUNCOS 400 mm



Find out more at
flos.com/juncos



SOFT SPUN

Designed by Sebastian Wrong

Lamp designed for minimal visual impact that is flush mounted to plasterboard walls. Available with halogen light sources connected directly to mains, fluorescent and LED lights sources. All of them include opal safety glass.

Lámpara diseñada para un mínimo impacto visual que se instala enrasada a pared de placas de yeso o escayola. Disponible con fuentes de luz halógena directa a red, fluorescente y LED. Todas ellas incluyen cristal de seguridad ópalo.

SMALL



LARGE



Find out more at
flos.com/softspun





Virgin Active, Portugal



ABAJOURD'HUI

Designed by Flos Soft Architecture

Lamp designed for minimal visual impact that is flush mounted to plasterboard walls. Available with halogen light sources connected directly to mains, fluorescent and LED lights sources. All of them include opal safety glass.

Lámpara diseñada para un mínimo impacto visual que se instala enrasada a pared de placas de yeso o escayola. Disponible con fuentes de luz halógena directa a red, fluorescente y LED. Todas ellas incluyen cristal de seguridad ópalo.

SMALL



Verbano Hotel, Italy

LARGE



Find out more at
flos.com/abajourd'hui

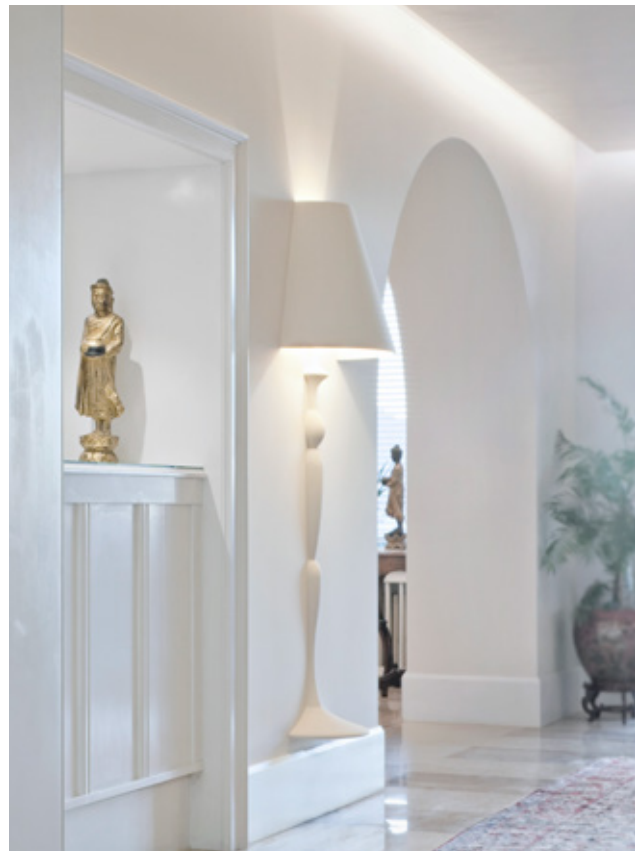

Beau Riage Hotel, France



Private House, Geneva

USO

Designed by Flos Soft Architecture

Family of luminaires manufactured with Soft Composite technology and designed to house FLOS architectural project. The Uso family offers a wide variety of lighting solutions, always guaranteeing total integration into the architectural space.

Familia de luminarias realizadas con la tecnología Soft Composite e ideadas para albergar proyectos de FLOS architectural. La familia Uso ofrece una gran variedad de soluciones de iluminación, asegurando siempre la total integración en el espacio arquitectural.

USO KAP 105/145

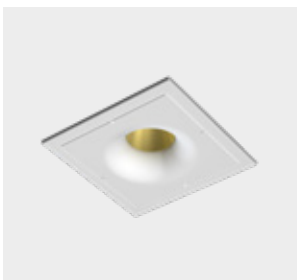

Find out more at
flos.com/uso

USO COVE LIGHTING

Designed by Flos Soft Architecture

Family of luminaires manufactured with Soft Composite technology and designed to house FLOS architectural project. Available in several sizes and shapes, as well as in 1L and 2L versions, the Uso family offers a wide variety of lighting solutions, always guaranteeing total integration into the architectural space.

Familia de luminarias realizadas con la tecnología Soft Composite e ideadas para albergar proyectos de FLOS arquitectural. Disponible en varios tamaños y formas así como en versión 1L y 2L, la familia Uso ofrece una gran variedad de soluciones de iluminación, asegurando siempre la total integración en el espacio arquitectural.

USO 900 COVE LIGHTING



USO 1700 COVE LIGHTING



USO 2200 COVE LIGHTING



USO 2500 COVE LIGHTING



USO 100 50 COVE LIGHTING



USO 140 90 COVE LIGHTING



Find out more at
flos.com/usocovelighting



G-O IN

Designed by Jorge Herrera

LED wall luminaire, specifically designed for indoor signage of corridors, stairs, etc. Fitting combined with Soft Composite technology integrates perfectly into the architecture. Available with white, amber or blue light depending on the needs of the lighting project.

Luminaria LED para pared, específicamente diseñada para la señalización de interiores tales como pasillos, escaleras, etc. Diseñada en tecnología Soft Composite, se integra perfectamente en el espacio arquitectural. Disponible en luz blanca, ámbar o azul, según necesidades del proyecto de iluminación.



Find out more at
flos.com/goin



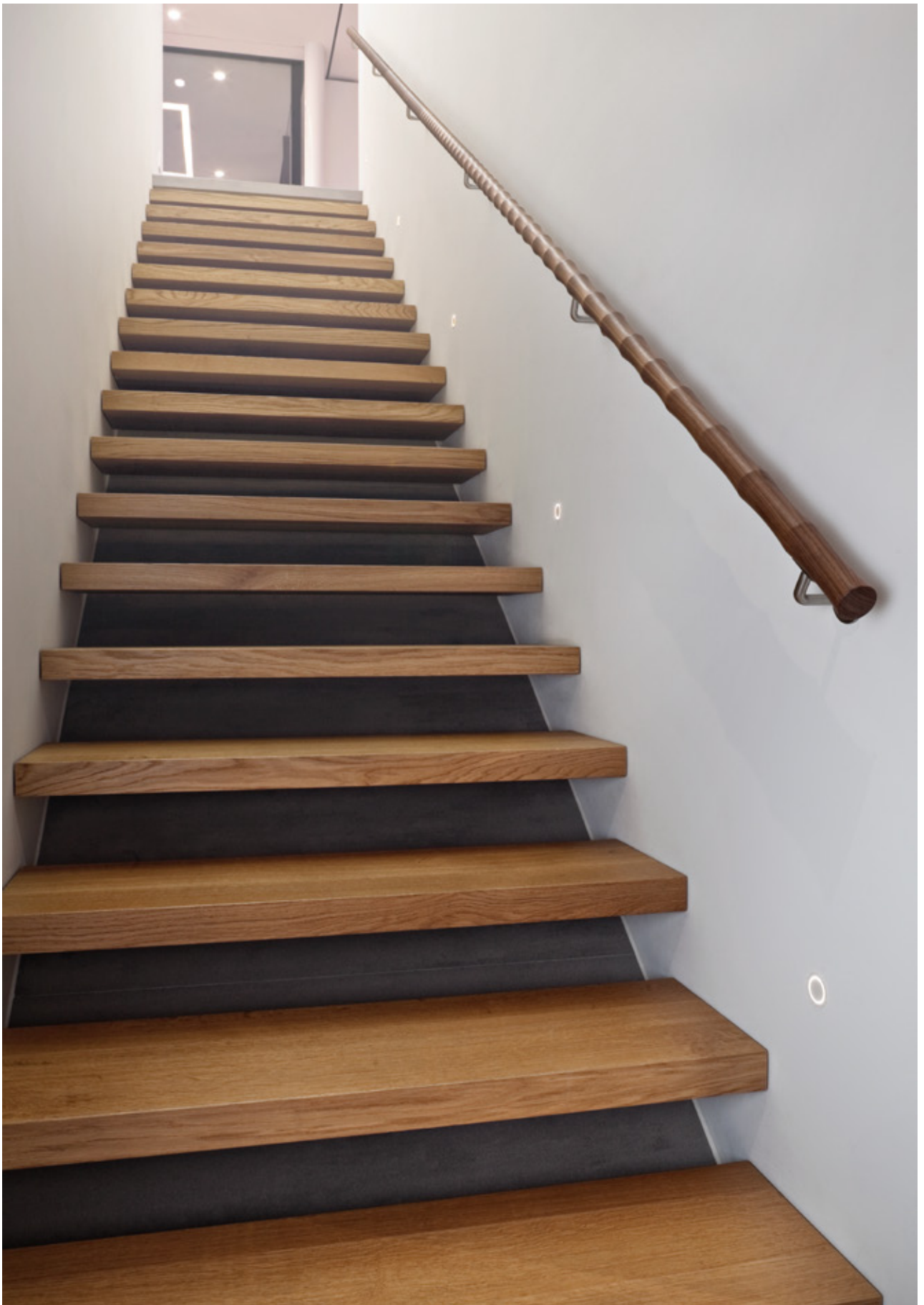

Private House, Holland



TEARDROP

Designed by Calvi Brambilla

Round downlight available in several diameters designed for minimal visual impact made of plaster. The light source is installed in a deep position, to achieve high visual comfort. Plasterboard ceiling-mounting.

Downlight redondo disponible en varios diámetros diseñado para un mínimo impacto visual realizado en escayola. La fuente de luz queda instalada en una posición profunda, para conseguir un alto confort visual. Instalación en techo realizado con placas de yeso o escayola.

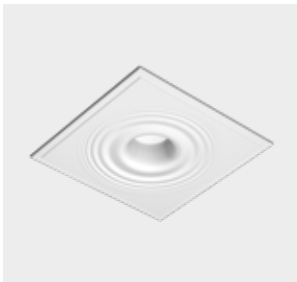

Find out more at
flos.com/teardrop



ROUND, SQUARE & VERTICAL LIGHT

Designed by Flos Soft Architecture

Recessed light fitting for interior wall and ceiling mounting. Available in round/square/rectangular versions. Designed to blend in with the surroundings and generate minimal visual impact, the Round, Square & Vertical Light family incorporates a screen on the inside as well as diffuser polycarbonate lens.

Aparato de iluminación empotrable para instalación en pared/techo de interiores. Disponible en versión redondo/cuadrado/rectangular. Diseñado para fundirse con el entorno y generar un mínimo impacto visual, la familia Round, Square & Vertical Light incorpora una pantalla integrada en su interior y una lente difusora realizada en policarbonato.

ROUND

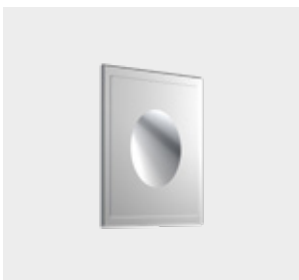

Find out more at
flos.com/roundlight

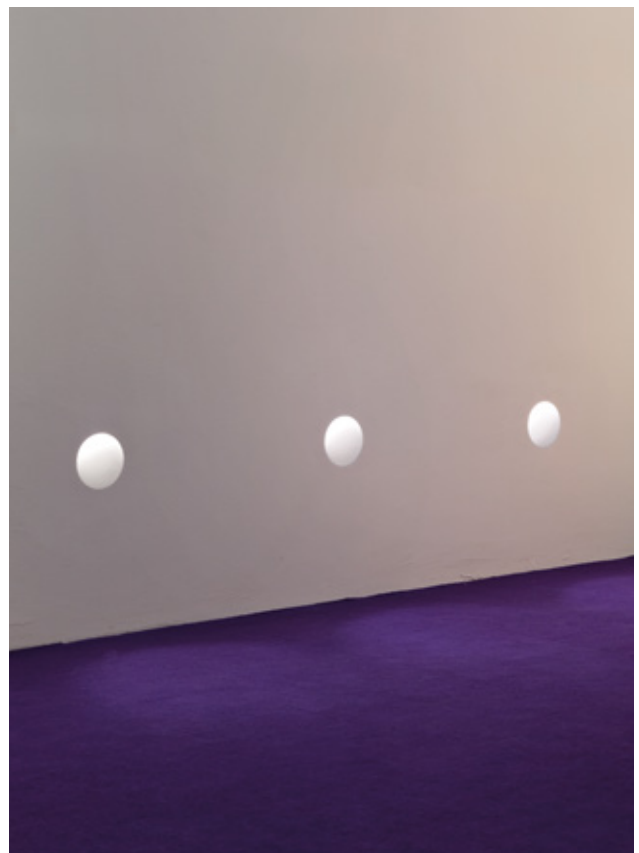

SQUARE



Find out more at flos.com/squarelight



VERTICAL



Find out more at flos.com/verticallight



Sempione Cafe, Italy

DISTRIBUTION

BELGIUM & LUXEMBOURG Flos Belux M +32 474 739 080 flosbelux@flos.com	JAPAN Flos Japan K.K. HulicAoyamaDai-ni bldg..2F 1-3-3 Shibuya, Shibuya-ku, Tokyo 150-0002 Tel +81 (0)3 6421 0840 Customerservice.flosjapan@ flos.com	MIDDLE EAST Antares Iluminacion S.A.U. Dubai Design District Building 1B, Office 303 Dubai, United Arab Emirates P.O. Box 333025 Tel +971 4 566 0123 info@flos.com HONG KONG M +852 9307 3713 flosasia@flos.com	PARIS 20-22, Passage Dauphine 75006 Paris Tel +33 (0) 1 40 64 17 44 flos.france@flos.com SHANGHAI Unit 101, Floor 1, Building B9 No.800 of Chang De road Jing An District, Shanghai, 200040, China Tel. +862162176187 floschina@flos.com
FRANCE Flos France 20-22, Passage Dauphine 75006 Paris Tel +33 (0) 1 40 64 17 44 flos.france@flos.com	FAR EAST Flos Representative Office info@flos.com	<u>SHOWROOMS</u>	<u>FLAGSHIP STORES</u>
GERMANY Architectural & Soft Architectural & Outdoor Collections Große Brinkgasse 26-28 50672 Köln, Germany Tel. +49 221 37 99 46 0 backoffice.gmbh@flos.com	CHINA Design Holding Shanghai Unit 101, Floor 1, building B9 No. 800 of Chang De road Jing An District Shanghai, 200040, China Tel +86 21 62880713 floschina@flos.com	MILANO Corso Monforte, 15 20122 Milano Tel +39 02 79 84 57 Fax +39 02 89 78 56 41 showroom.milano@flos.com	MILANO Corso Monforte, 9 20122- Milano Tel +39 02 37011080 Fax +39 02 780833 flosmilano@flos.com
UNITED KINGDOM FLOS UK Tel. +44 (0)7340831007 flos.uk@flos.com	SWEDEN Flos Sverige AB Kuglegårdsvej 15, 1434 Copenhagen, Denmark Tel +46 33886000 info.se@flos.com Orders retailorder.scandi@flos.com projectorder.scandi@flos. com	MADISON 135 Showroom Madison Ave, 135 10016 New York Tel. +1 718 706 05 83	PARIS 15, rue de Bourgogne 75007 - Paris Tel +33 (0) 1 53 85 49 93 Fax +33 (0) 1 53 85 49 99 shop@flos.fr
DENMARK Flos Scandinavia A/S Sydhavnsgade 28 DK-2450 København SV Tel +45 (0) 3388 60 00 Fax +45 (0) 3388 60 10 info@flos.dk	DENMARK - FINALDN ICELAND - THE FAROE ISLAND FLOS Scandinavia A/S Kuglegårdsvej 15, 1434 Copenhagen, Denmark Tel +45 3388 60 00 info.dk@flos.com Orders retailorder.scandi@flos.com projectorder.scandi@flos. com	COPENAGHEN Sydhavnsgade 28 DK-2450 København SV Tel +45 (0) 3388 60 00 Fax +45 (0) 3388 60 10 info@flos.dk	NEW YORK 152 Greene Street, New York, USA Tel. +212 941 4760 info.usa@flos.com
NORWAY Flos Norge A/S Drammensveien 120 0277 Oslo Tel +47 (0) 2212 86 00 contract.norge@flos.com retail.norge@flos.com	LATIN AMERICA Flos Latam M +34 697 79 57 22 samuel.ciaurriz@flos.com	OSLO Drammensveien 12002, 77 Oslo - Norway Tel +47 (0) 2212 86 00 Fax +47 (0) 2212 86 08 contract.norge@flos.com	AMSTERDAM Cruquiusweg 109S 1019 AG Amsterdam The Netherlands Tel +31 (0) 20 560 50 60 Fax +31 (0) 20 560 50 70 showroom.amsterdam@ flos.com
THE NETHERLANDS Flos BV Cruquiusweg 109S 1019 AG Amsterdam Tel +31 (0) 20 560 50 60 showroom.amsterdam@ flos.com	INDIA Flos India info@flos.com	TOKYO Flos Japan K.K. HulicAoyamaDai-ni bldg..2F 1-3-3 Shibuya, Shibuya-ku, Tokyo 150-0002 Tel +81 (0)3 6421 0840 showrooms.tokyo@flos.com	U. S. A. Flos USA Inc.: 36 E 31 Street, New York, NY 10016 Tel +1 718.706.0595 contract.usa@flos.com Bespoke bespoke.usa@flos.com Retail info.usa@flos.com

CONTACT

ITALY

Flos Spa
Via Angelo Faini, 2
25073 Bovezzo (Brescia)
Tel +39 0302438.1
Fax +39 0302438.250
info@flos.com

SPAIN

Antares Iluminación S.A.U.
Calle Mallorca, 1
Polígono Industrial Reva
46394 Ribarroja (Valencia)
Tel +34 96 166 95 20
Fax +34 96 166 82 86
flos.architectural@flos.com

ITALY

Flos Outdoor
Via dell'Artigianato, 24
20881 Bernareggio
(Monza)
Tel +39 0396900892
flos.outdoor@flos.com

ITALY

Flos S.p.A. - Sole share-
holder - Company
under management and
coordination of
Flos B&B Italia Group S.p.A
Via A. De Gasperi, 2
25060 Collebeato
(Brescia), Italy
Tel +39 0302512561
bespoke@flos.com

IN-PLACE
PHOTOGRAPHY

Adam Letch
Adrian Houston
Aleš Jungmann
Alexandros Pissourios
Anarchitect I
Andrew Krucko
Andrew Latreille
Andy Spain
Andy Stagg
Ángel Rosique
Photography
B2Ai – fotograaf Bart
Heijmans
Beeldpunt
Bernard Andre
BIS images
Bouroullec Studio
Boys Plays Nice
Brian W. Ferry
Bruno Rondinelli
C. Taylor Crothers (CTC)
Celine de Gussem
Cesare Chimenti
Chiel de Nooyer
Clarysse Valerie, HC
Connie Zhou
CTC Creative
David Frutos
Diana di Nitto
EK Yap Creative &
Photography
Erlantz Biderbost
Eugeni Pons
Fabio Gambina
Federica Cartlet
Federico Torra
Fernando Alda
Francesco Caredda
Fraser Marsden
Frederik Vercrusse
Germán Cabo
Germano Borrelli
Gionata Xerra
Héctor Santos
Jabali Studio
Javier Bravo
Javier Márquez
Javier Orive

Jesús Granada
Joao Morgado
Julian Walter
Killian O'Sullivan
Kris Dekeijser
LevaSaudargaite
Liesbeth Goudenhooff
Lindman Photography AB
Mariela Apollonio
Matt Chisnall
Mattia Greggi
MaxRommel
MCM and The Estee
Lauder Companies UK &
Ireland
Michel Giesbrecht &
Studio Bouroullec
Moriq interiors and Design
Consultans
Olivier Baco
Omar Sartor
Pere Peris
Petra Kleis
Pia Riverola
PIAGGIO Fast Forward
RBA / Eugeni Pons
RBA ImagesBIS images
Roland Halbe
Rubén P. Bescós
Santi Caleca
Schwarz – Licht
Shuhe
Simona Rota
Simone Bossi
Studio Moost / Studio
Tomorrow
Tamas Bujnovszky / BE
LIGHT!
Tommaso Sartori
Valerie Clarysse / Beelpunt
Photography
Victoria Muñoz
VIEW / Andy Stagg
VIEW / Ed Reeve
VIEW / Francesco Russo
Volker Conradus
Woo-Jin Park

CREDITS

ART DIRECTION

Apartamento Studios

GRAPHIC DESIGN

Apartamento Studios

PHOTO INTEGRATION

Mozing Studio

Jorge Herrera Studio

PHOTO PRODUCT

Piero Fasanotto

Alessandro Lourenço

LAYOUT

Flos Architectural Team

PRODUCT INFORMATION

UPDATE

15-04-2026

EDITION

15-04-2026

Copyright © Flos 2026

All rights reserved

ACKNOWLEDGEMENTS

05AM Arqtes	Issey Miyake	United Nations
Alex March	Itínere Baqueira	Val Office
Alfons & Damian	Jorge Herrera	Versace
Anarchitect	Kitoko	Viccarbe
Andreu World	Klaarchitectuur Offices	Víctor Bergnes
AntwerpPhoto	Kvadrat	Victoria Beckham
Arassociati	Lardini	VIEW Pictures Ltd / Alamy
Archiproducts	Lighting Workshop	Vincent Van Duysen Studio
Arclinea	Lightpoint	Vincenzo De Cotiis
Axiom Consulting Partners	Lissoni & Partners	Architects
Babel Studio	LOFT4C	Virgin Active
Barbara Balestreri	Lukas Lighting	Voltaire
BassamFellows Inc.	Luminae Lighting Design	White Houses
Beeldpunt	Marco Costanzi Architets	Zusa
B&B Italia	Marcos Catalán	
Bombas Gens	Maxime De Campenaer	
Bombi/Gómez	MCM	
Boubau	MLD	
Boys Plays Nice	Moba Showroom	
Budapest	Mobitec	
BURO B	Molteni	
Carbonado Energy	Moremas Arquitectos	
Carhartt	Mount Sinai Hospital	
Central European	Natixis	
University	Negre Estudio	
Claudio Castellini	O'Donnell + Tuomey Ltd.,	
Conran and Partners	Palazzo Reale Milano	
Cosín Showroom	Park 51	
COULON & Ass	Peia Associati	
Curiosity	Pepe Cabrera	
De Witte Duif	Piaggio Fast Forward	
Emilio Nanni	Pitsou Kedem	
Estee Lauder	Poliform	
EstudiHac	Porcelanosa	
Estudio Querencia	RBA / Eugeni Pons	
Fabio Fantolino	Renzo Piano	
Familia Parrón-Ortiz	RF Dubai	
Fantini	Ricardo de Landaluce	
Fogarty Finger	RNB	
Fran Silvestre	Roberto Falconi - Falconi	
Francesco Caredda	Architettura	
Franco Scaglia	Ronan & Erwan Bouroullec	
Gandía Blasco	Rossano Ferretti	
Gomarco	Sergio Rossi	
Gyro Toys	Studio Civico 46	
Hakei	Studio Tronconi Architetti	
Hans Abaton	Teampannon Kft	
IN56 Interiorismo	The Conran Shop & APT	
INC Architecture & Design	Design	
PLLC	The KaDeWe Group	
Iñigo Beguiristain	TPG Architecture	

As our world is in constant evolution, technical upgrades happens every day in our business.

Flos aim is to offer always the best reliable technology available, constantly reviewing our products and upgrading them as soon as technologic evolutions offers benefits for our partners and clients.

This philosophy means that our technical catalogue and product data sheets also are in constant evolution, requiring upgrades and constants reviewing.

Thus, when you need technical details and the most recent product information, please browse the product section of our Flos.com official website: it is updated daily, and there you'll find the latest product details, all available part numbers, all product documents available for immediate download.

www.flos.com

Nuestro mundo está en constante evolución. Diariamente se presentan avances técnicos en nuestro sector.

El objetivo de Flos es ofrecer siempre la mejor tecnología disponible, revisando nuestros productos constantemente y mejorándolos tan pronto como la evolución tecnológica ofrezca ventajas para nuestros socios y clientes.

Esta filosofía implica que nuestro catálogo y nuestras fichas técnicas de producto también se encuentren en constante evolución y requieran mejoras y revisiones constantes.

Por tanto, si necesita consultar detalles técnicos y la información más reciente, diríjase a la sección de productos de nuestra página web oficial Flos.com: se actualiza a diario y en ella encontrará los últimos detalles sobre los productos, los códigos de los artículos disponibles y los documentos para su descarga inmediata.

www.flos.com

COLLECTION CATALOGUE 2026
THE GLOWING TRACK , MY CIRCUIT, BELT,
INFRA-STRUCTURE, GUSTAVE, EMIL, OBLIQUE,
ZERO TRACK PRO , ZERO TRACK, THE MICRO
RUNNING MAGNET, THE RUNNING MAGNET, THE
TRACKING MAGNET, THE TRACKING POWER
EVO, THE FAST TRACK, WORKMATES, LIGHT
SHADOW MINI, LIGHT SHADOW, LIGHT SHADOW
DOTS & PRO, ECLECTIC, LIGHT SHADOW SPOT,
MY SPOT, SUPER LINE & SUPERLINE PRO, KAP,
C1, FIND ME, UT , BON JOUR, FORT KNOX, IN-
FINITY, CIRCLE OF LIGHT, LIGHT CUT MINI, LIGHT
BELL, THIN LED, LIGHT SUPPLY, JOHNNY, WAN ,
G-O, THEBLOCKOFFLIGHT, JUNGOS, SOFT SPUN,
ABAJOURD'HUI, USO, USO COVE LIGHTING, G-O
IN, TEARDROP, ROUND, SQUARE & VERTICAL
LIGHT