



HONGQI

OWNERS MANUAL HONGQI E-HS9



Foreword

Thank you for choosing Hongqi E-HS9!

The European version of Hongqi E-HS9 has obtained ECWVTA.

Hongqi E-HS9 is equipped with various luxury equipment and advanced technologies. To make full use of these equipment and technologies in your car life in the future, it is recommended that you read this manual carefully so that you can quickly and comprehensively understand Hongqi E-HS9. This manual provides detailed instructions on safe driving, car maintenance, and emergency countermeasures in addition to introducing how to use the car, aiming to enable you to use the car safely and comfortably, while maximizing the value of the car. This manual is compiled according to the condition of the product at the time of publication and is subject to subsequent product changes without notice. Thanks for understanding. If you have any other questions about the car or think that the information contained in the accompanying documents is not detailed, please consult an authorized Hongqi dealer, and we will be happy to help you! You can view or download the latest version of the Owner's Manual on the Hongqi official website. Before you use the car, it is recommended that you read the manual carefully.

The latest version of the user manual can be read on our [homepage](#). We recommend that you read the manual thoroughly before you start using the car.

Have a nice drive!

FAW Group

Contents

	Picture index	Search by illustration
1	Safety precautions	Be sure to read the safety instructions thoroughly
2	Instrument cluster	Read instrument information, various alarm lamps and indicators, etc.
3	Operating the components	Open and close doors and windows, adjust before driving, etc.
4	Driving	Necessary operations and suggestions when driving
5	Multimedia System	Operate the multimedia system
6	In-car equipment	Use in-car equipment, etc.
7	Service and maintenance	Vehicle service and maintenance steps
8	In case of failure	Countermeasures in case of failure or emergency
9	Vehicle specifications	Details of vehicle specifications
	Other information	List the abbreviations and other information contained in this manual

1 Safety precautions

3 Operating the components

1-1. Instructions for safety operation

Safe driving 19

Seat belt 20

Airbag 26

Child safety information 37

Child restraint system 38

Installing a child restraint system 41

High voltage safety 44

1-2. Charging/discharging

Methods and steps of charging/discharging 46

Notes for emergency charging 54

Display and settings of charging/discharging 55

Troubleshooting in charging/discharging 59

1-3. Immobilizer system

Shutdown system 61

Body immobilizer system 62

2 Instrument cluster

2. Instrument cluster

Instrument cluster 64

Alarm lamp 66

Indicator 68

Instrument cluster multi-function display information 70

3-1. Key information

Key 80

3-2. Opening, closing and locking the doors and trunk lid

Door 83

Trunk lid 87

Passive entry and passive start (PEPS) system 91

Auto lock 95

3-3. Adjusting the seat

Front seat 96

Rear seat 99

Headrest 102

Seat memory 104

3-4. Adjusting the steering wheel and rearview mirrors

Steering wheel 106

Exterior rearview mirror 109

3-5. Opening and closing windows

Power window 112

Panoramic sunroof 114

4-1. Before driving

Driving the vehicle	118
Cargo and luggage.....	124

4-2. Driving rules

Power (ignition) switch	125
Shift control	127
Driving mode.....	131
Air suspension *.....	135
Turn signal lamp control handle	139
Electric parking brake (EPB).....	140
AUTO HOLD	142

4-3. Operating lights and wipers

Headlamp ON/OFF	143
LED Matrix (ADB) *	145
Fog lamp switch.....	147
Front windshield wiper and washer	148
Rear windshield wiper and washer	151

4-4. Charging port cover

Open charging port cover	152
--------------------------------	-----

4-5. Operating other driving systems

Adaptive cruise control (ACC) *	154
Super adaptive cruise control (SACC)*	161
Front and rear parking sensor (PSS) *	168
AVM system	173
Tire pressure management system (TPMS)	178
LDW/LKA.....	180
Front collision warning (FCW) system	183
Autonomous emergency braking (AEB)	186
Blind spot detection (BSD) system	189
TSR system*	194
Auto parking assist (APA)	196
Driver assist system (DAS)	203

4-6. Driving information

Driving essentials in winter	206
------------------------------------	-----

Annex for trailer traction.....393

35 Multimedia System

5-1. Basic operation

Multimedia display209
 USB data interface213

5-2. Operating the multimedia system

Vehicle.....215
 Trailer mode.....223
 Navigation227
 Entertainment241

5-3. Operating the on-board Bluetooth phone

Hands-free system244
 Bluetooth® phone.....247

5-4. Operating the voice recognition

Voice recognition251

5-5. Operating Mobile APP

Hongqi Zhilian APP253

6 In-car equipment

6-1. Operating the air-conditioning (A/C) system

Fully automatic A/C system258
 Fully automatic A/C system — front control system.....259
 Fragrance.....263
 Fully automatic A/C system — second-row control system.....266

Third-row A/C control system 272
 Heat rear windshield 276

6-2. Operating the interior lights

List of interior lights 277

6-3. Operating storage box

List of storage boxes 280
 Trunk device 286

6-4. Other in-car equipment

On-board wireless charging system .. 287
 Sun visor 288
 File folder 289
 Make-up mirror 290
 Power socket 291
 220V power outlet 293
 Seat temperature controller * 295
 Seat massage function* 297
 Rear center armrest * 298
 Ceiling handle..... 299
 Coat hook 300

7 Service and maintenance

7-1. Service and maintenance

Cleaning and protecting vehicle exteriors 303
 Cleaning and protecting vehicle interiors 305

7-2. Maintenance

Maintenance instructions 307

7-3. Self-maintenance

Precautions for self-maintenance.....	309
Hood.....	311
Engine compartment.....	312
Tire.....	320
Tire pressure.....	323
Wheel.....	325
A/C filter.....	326
Replacing the key battery.....	329
Checking and replacing the fuse.....	331
Power battery.....	335

8 In case of failure

8-1. Important information

Hazard warning lamp.....	340
SOS alarm.....	341

8-2. Measures to be taken in case of emergency

If the vehicle needs to be towed.....	342
If the vehicle is found to be abnormal	345
If the alarm lamp lights up or the alarm speaker sounds.....	346
If a tire leaks.....	351
In case of power system failure to starter.....	353
If the key is lost.....	354
In case of key failure to work normally.....	355
If the door can not be locked properly	357

In case of low 12 V battery.....	359
If the vehicle is overheated.....	362
In case of an electrical fire.....	364
If a trap occurs.....	365
If driving on waterlogged roads.....	366
In the event of a flat tire.....	367
In the event of an accident.....	368
Emergency opening of trunk lid.....	369

9 Vehicle specifications

9-1. Specification

Service data.....	371
-------------------	-----

Other information

List of abbreviations.....	385
List of tools.....	388
Driving with a trailer.....	389

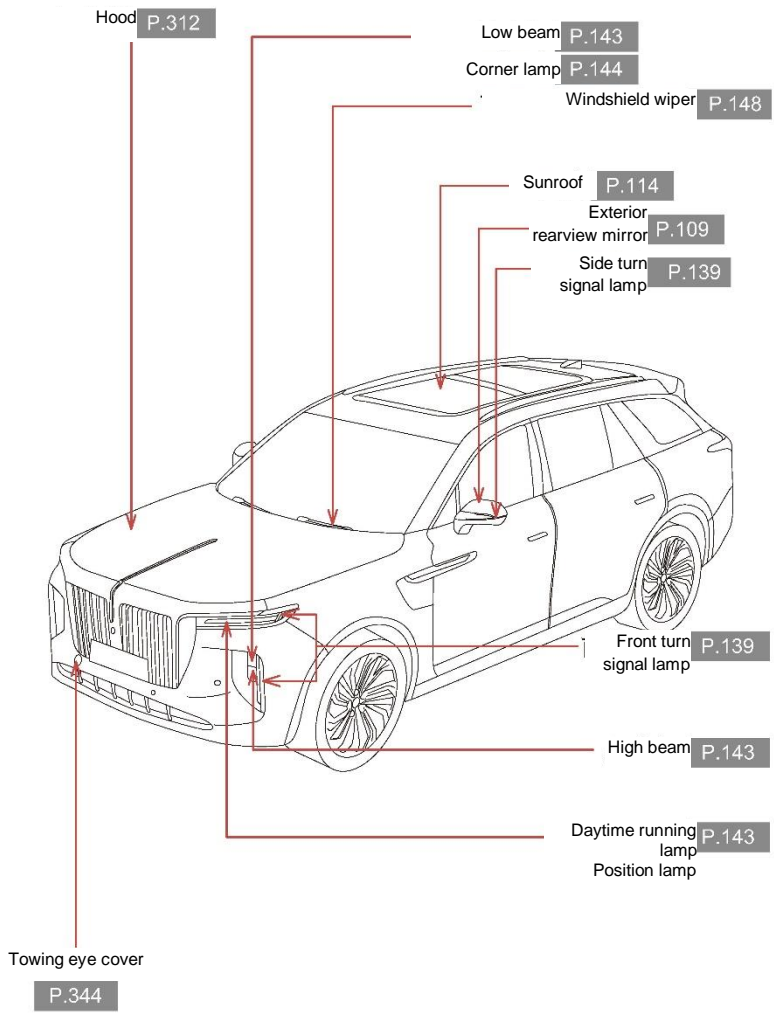

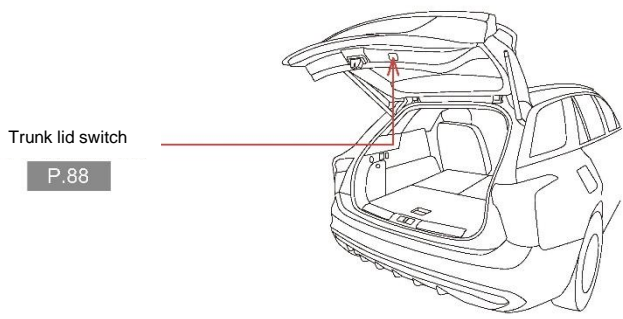
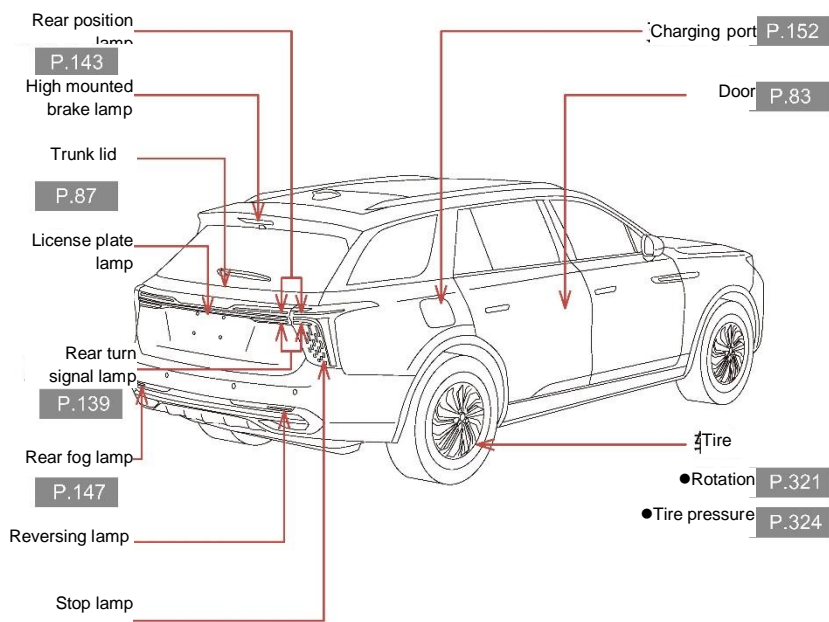

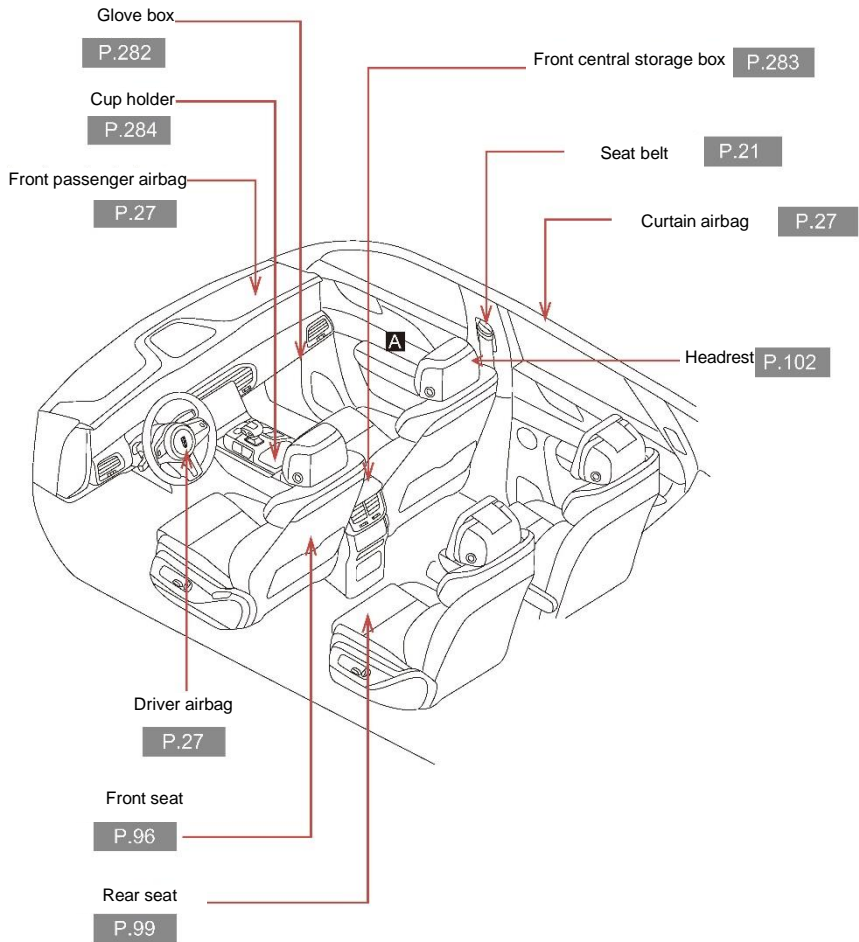

A

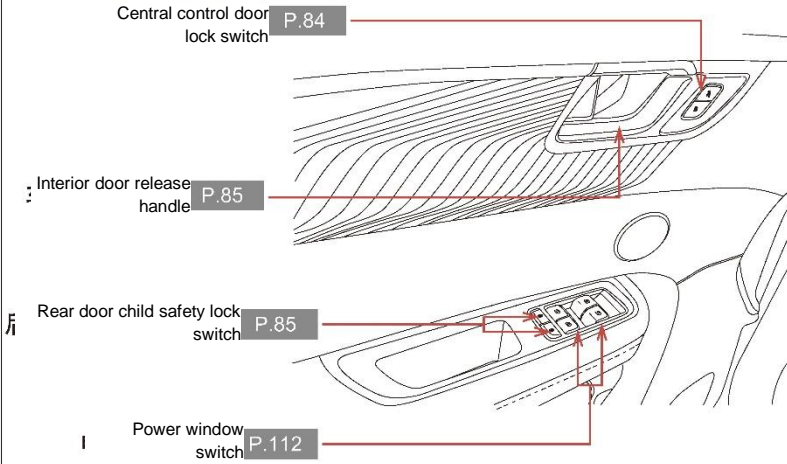

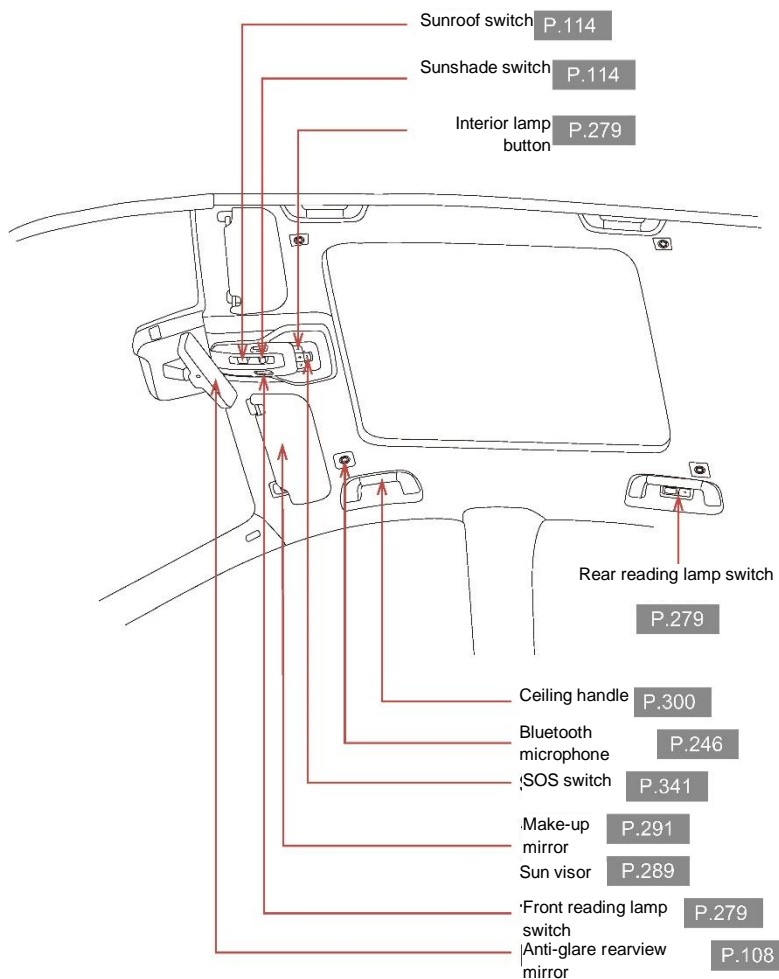

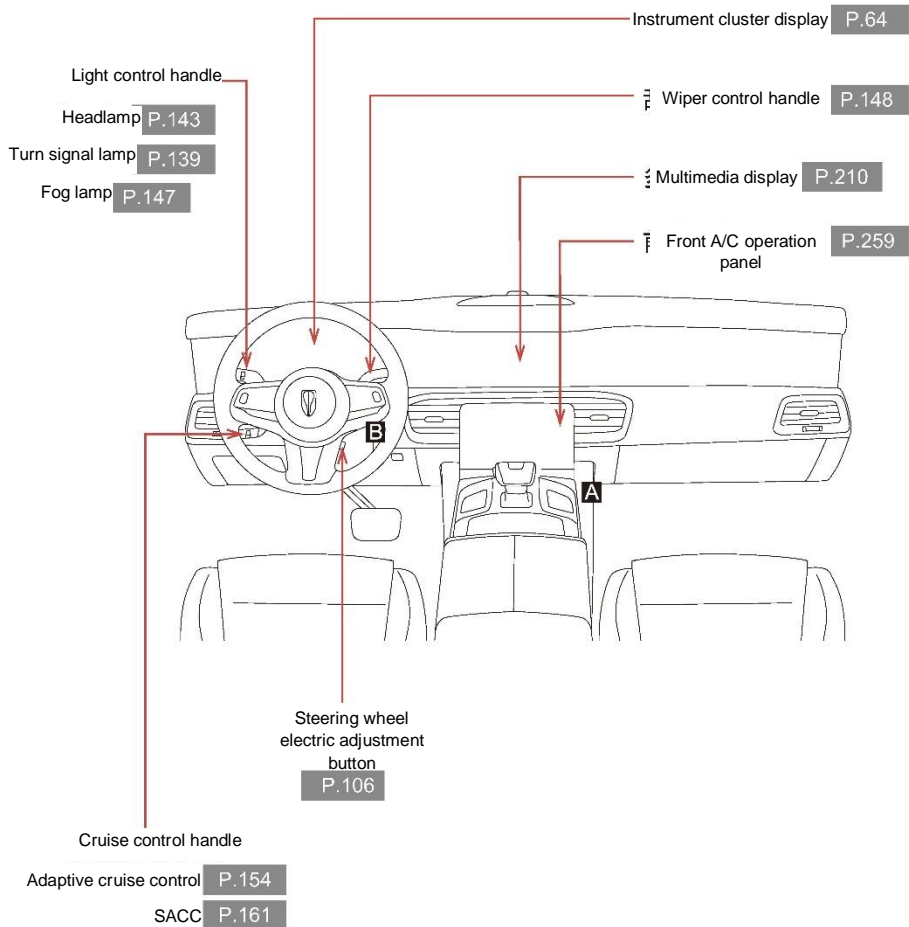

A

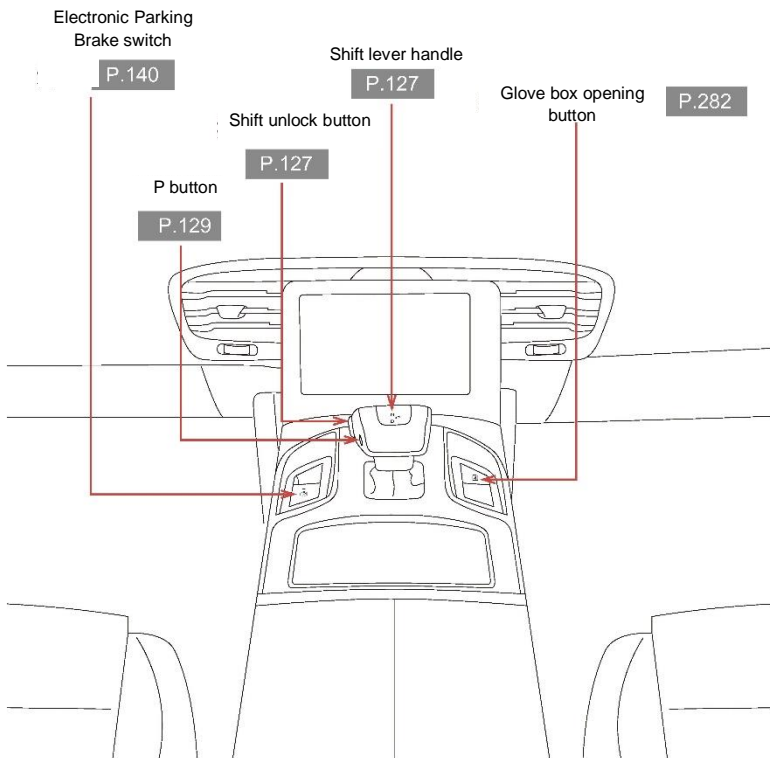

B

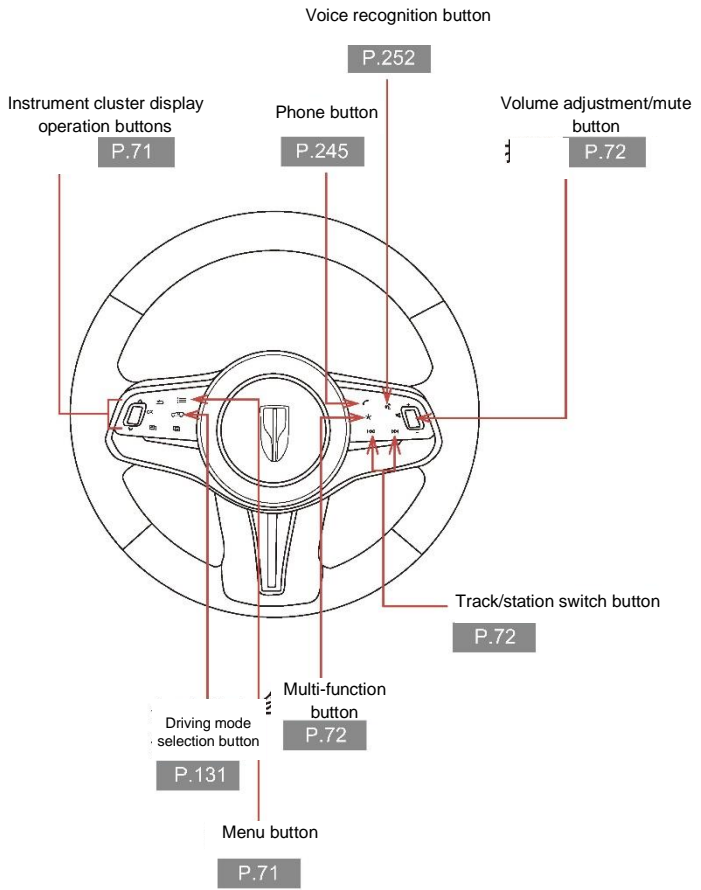

Reference information

Instructions for User Manual

The user must have a driving license to drive the vehicle on the road. This User Manual is specially written for such users.

In this manual, "*" means that the configurations and functions may vary from model to model and are only provided in certain models. Please refer to the actual vehicle for specific equipment information.

The pictures in this manual are only for illustration, which can help you understand the vehicle more intuitively. They may be slightly different from the pictures of your vehicle. Please refer to the actual vehicle during driving.

All specifications provided in this Manual are up to date until it is delivered for printing. However, in view of continuous modification and improvement of vehicles made by FAW, the equipment and performance of subsequent models will be changed. Therefore, the contents of this Manual will be updated at any time without further notice. Please do not compare the contents of other versions of the User Manual with the equipment and performance of the vehicle you purchased and put forward the requirements for supplementary equipment based on the differences between the two. If you have any questions about the purchased vehicle and the User Manual, please consult the authorized FAW Hongqi dealer.

Supplementary instructions on sales in countries other than China

The navigation, speech recognition, and some functions that can be used only when the AVN APP and mobile APP are connected to the Internet are unavailable in regions other than China and Europe for the time being. Such functions are mainly as follows in the Manual: 4-5 Other driver assistance systems - traffic sign recognition (TSR)* (and related functions, only used in Chinese mainland and Europe for the time being) 5-4 Speech recognition* (and related functions, only used in Chinese mainland and Europe for the time being) 5-5 Hongqi Zhilian APP* (and related functions, only used in Chinese mainland and Europe for the time being)

Accessories, spare parts and modification of vehicles

The authorized FAW Hongqi dealer has the advanced tools, equipment and pure spare parts required to provide maintenance and service for your vehicle. We strongly recommend that you use FAW genuine spare parts and accessories that meet the requirements of this vehicle.

For any non FAW genuine spare parts and accessories, whether used for replacement or installation, FAW does not assume any responsibility or provide any guarantee. In addition, vehicle damage and performance problems caused by the use of non FAW genuine spare parts or accessories are not included in the scope of warranty.

It is not allowed to use products not authorized by FAW to refit the vehicle, otherwise the controllability, safety and durability of the vehicle will be affected, and even the local government regulations may be violated. Additionally, any problems caused by modification are not included in the scope of warranty.

Reading vehicle identification number (VIN)

Use the scan tool to connect the vehicle OBD port, and read the VIN when reading HCU information. The reading tools can be purchased from the market, and they shall conform to the standards of ISO14229, ISO15765, ISO15031 and ISO11898.

Installation of RF transmitter system

The installation of RF transmitter system on the vehicle may affect the electronic systems, such as:

- Anti-lock Braking System (ABS)
- Cruise Control System (CCS)
- Supplemental Restraint System (SRS)
- Seat belt pretensioner system

Before installing the RF transmitter system, please consult the authorized FAW Hongqi dealer.

Scrapping of vehicles

The airbags and seat belt pretensioners in vehicles contain explosive chemicals. If the vehicle is scrapped without removing the airbags and seat belt pretensioners, it may cause personal injury, fire and other accidents. Before scrapping a vehicle, please contact a qualified enterprise or organization to remove and dispose of the airbags and seat belt pretensioners. The authorized FAW Hongqi dealer has an intimate knowledge of the relevant laws and regulations and can provide consulting services for you.

Event data recorder

The vehicle is equipped with event data recorder (EDR). The main function of EDR is to record data in the case of some collision or near collision (such as airbag deployment or road obstacles impact), so as to help understand the operation of vehicle system. EDR is specifically used to record data related to vehicle dynamic control and safety systems in a short period of time. However, the data may not be recorded depending on the severity and type of collision.

Data recorded by EDR of the vehicle, such as:

- Safety belt status of driver and vehicle occupant
- The extent to which the driver steps on the brake and accelerator pedals
- Working status of vehicle related systems
- Vehicle speed

These data can help to better understand the situation in case of collision and personal injury.

Note: EDR data will only be recorded when a certain degree of collision occurs; During normal driving, EDR does not record data and does not record personal data (such as name, gender, age and crash location). In order to read the data recorded by EDR, it is necessary to use the special equipment of vehicle manufacturer and access the vehicle EDR. In addition to vehicle manufacturers, third parties with special equipment (such as law enforcement departments) can also read information if they have access to vehicles or EDR.

Based on the statutory obligation of product monitoring, the company can use the data for environmental monitoring, research purposes and quality improvement of vehicle safety system. For the purpose of research needs, the company may provide anonymous data to relevant parties, that is, the data does not involve personal vehicle, owner or lessee information.

Model code

This Manual describes models E-HS9E01, E-HS9E02, E-HS9E03 and E-HS9E04



WARNING

■ Driving precautions

Drivers must drive soberly, carefully and attentively.

- Sober driving: Do not drive after drinking or taking medicine. Alcohol or some drugs will delay reaction time, affect judgment and coordination ability, which may lead to serious injury or even death.
- Careful driving: Be careful when driving. Pay attention to the movement of other vehicles and pedestrians at any time, so as to make timely judgment and prevent accidents.
- Attentive driving: Be sure to concentrate on driving. Anything that distracts the driver, such as adjusting the control buttons, making a call or reading, may lead to a collision accident and cause serious injury or even death.

■ Precautions for children's safety

- Do not leave children alone in the vehicle.
- Do not allow children to carry or use the key. Children may start the vehicle or operate the shift lever, which may cause safety hazards.
- Do not allow children to play with the doors, windows or other vehicle equipment, as this may injure them.
- Make sure that the temperature in the car is appropriate. If the temperature is too high or too low, it may cause fatal injury to children.

Reading this Manual

WARNING

Introduce the warnings. Failure to comply may result in serious injury or even death.

Notice

Introduce the precautions. Failure to comply may result in damage or failure of the vehicle.

STEP 1 Represents the operating or operation steps, which are carried out in numerical order.

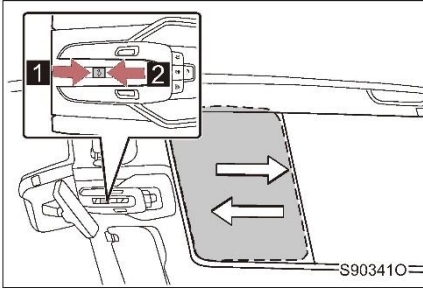

 Indicates the action (push, turn, press, etc.) used to operate switches and other devices.

 Indicates the result of the operation (e.g. lid open).



 Means "Do not," "Do not do this" or "Don't let that happen."

Safety precautions

1

1-1. Instructions for safety operation

Safe driving	20
Seat belt	21
Airbag	27
Child safety information.....	38
Child restraint system	39
Installing a child restraint system	42
High voltage safety	45

1-2. Charging/discharging

Methods and steps of charging/discharging	47
Display and settings of charging/discharging	54
Troubleshooting in charging/discharging.....	58

1-3. Immobilizer system

Shutdown system	60
Body immobilizer system	61

1-1. Instructions for safety operation

Safe driving

Before driving, adjust the seats, steering wheel and rearview mirrors to the proper position to ensure safe driving.

■ Correct driving posture

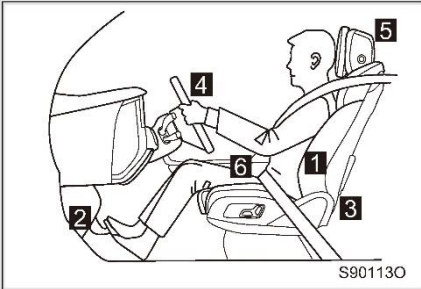

- 1 Sit up straight and lean on the backrest.
- 2 Adjust the seat position before and after, so as to ensure that the pedal can be stepped to the desired position.
- 3 Adjust the backrest so that the switches can be easily operated.
- 4 Adjust the steering wheel angle so that the airbag is facing the driver's chest.
- 5 Adjust and lock the headrest so that its center is flush with the upper part of the ears.
- 6 Fasten the seat belt correctly.

■ Correct use of seat belt

Before driving the vehicle, make sure that the driver and all occupants have fastened their seat belts. Children should use appropriate child restraint systems until they are large enough to use the seat belts on the vehicle.

■ Adjusting the rearview mirror

Adjust the interior and exterior rearview mirrors properly to ensure that the conditions behind the vehicle can be clearly observed.



WARNING

■ Precautions when driving

- Do not adjust the driver seating position during driving, otherwise the vehicle may lose control.
- Do not place a cushion between the body and the backrest, otherwise it is not conducive to maintain the correct sitting posture and may reduce the effectiveness of the seat belt and the headrest.
- Do not place any object under the front seats, otherwise the object may be caught between the seat rails.
- It is apt to get tired during long-distance driving, so you should have a proper rest. If you feel tired or sleepy during driving, do not force yourself to continue driving, but take a rest immediately.

■ Adjusting the seat position

- Care should be taken to adjust the seat position to ensure that no other occupant is injured when the seat is moving.
- Do not place your hand under the seat or near the moving parts when adjusting the seat, otherwise your fingers may be pinched by the seat adjuster.

1-1.Instructions for safety operation Seat belt

Before driving, make sure that the driver and all occupants in the vehicle have fastened their seat belts.

Correct use of seat belt



- Stretch the shoulder belt so that it straddles the entire shoulder, but do not touch the neck or slip off the shoulder.
- Place the waist belt as low as possible across the hip.
- Adjust the position of the backrest, sit up straight and lean on the backrest.
- Do not twist the seat belt.

Buckle up and unbuckle

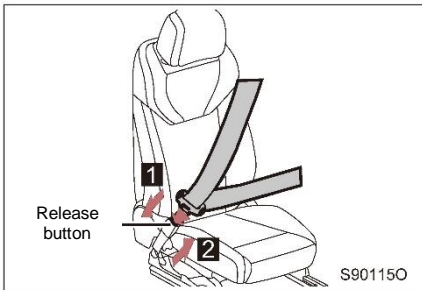

- 1** Buckle up
Insert the latch into the buckle until you hear an "click".
- 2** Unbuckle
Press the release button.

Notice

If the occupants have not fastened the seat belts, the instrument cluster will give an alarm when the vehicle reaches a certain speed.

Adjusting the height of the seat belt (front seat)

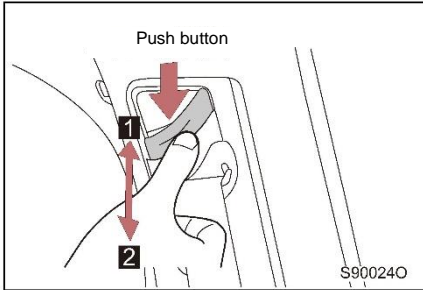

- 1 Move up
- 2 Move down

Press and hold the adjustment button and move the height adjuster up and down as required until you hear a "click".

Second-row middle seat belt*

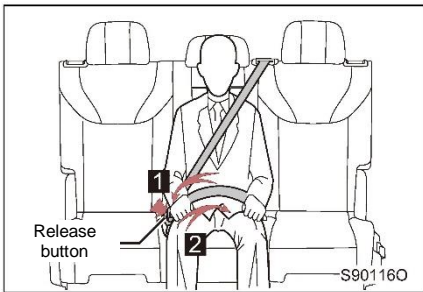

- 1 Buckle up
Insert the latch into the buckle until you hear an "click".
- 2 Unbuckle
Press the release button.

Seat belt pretensioner (front only)

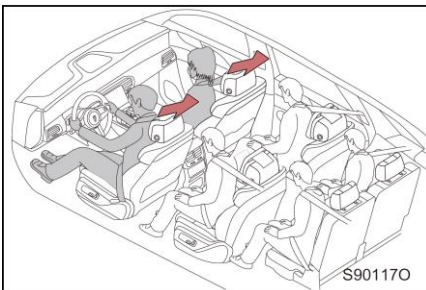

When the vehicle is in some serious front impact, the pretensioner will activate, tighten the seat belt, and quickly restrain the occupant to better protect the occupants.

However, the pretensioner will not activate in a minor front, side or rear impact.

■ **Emergency Locking Retractor (ELR)**

The retractor will lock the seat belt in case of emergency braking or collision. If you lean forward too fast, it will also lock the seat belt. Moving slowly and smoothly will lengthen the seat belt and allow you to move freely.

■ **Use of children seat belt**

The seat belt on the vehicle is mainly designed according to the adult body shape.

- Children should use appropriate child restraint systems unless they grow up to fit the seat belts on the vehicle.
- When children grow up to fit the seat belts on the vehicle, they should also follow the instructions for adult seat belt. (Refer to P.21)

■ **Replacing the seat belt after the pretensioner is activated**

- The seat belt pretensioner can only be activated once. In case of multiple vehicle collisions, the seat belt pretensioner will not be activated again after being activated once.
- When the seat belt pretensioner is activated in case of collision, please contact the authorized FAW Hongqi dealer to replace the seat belt in time.

■ **Regulations on seat belts**

If your country or region has relevant regulations on seat belts, please contact the authorized FAW Hongqi dealer for replacement or installation of seat belts.

**WARNING**

In order to reduce the risk of personal injury in case of emergency braking, emergency steering or accident, please observe the following precautions, otherwise serious personal injury or even death may be caused.

■ **Fasten the seat belt**

- Make sure that the driver and all occupants have fastened their seat belts.
- Always wear the seat belt correctly.
- Do not tilt the seat too much for comfort, because only when the occupant is sitting upright and leaning against the backrest, the seat belt will play the most protection.
- When wearing the shoulder belt, do not place the belt under the arm.
- Be sure to place the seat belt as low as possible across your hips.

■ **Pregnant woman**

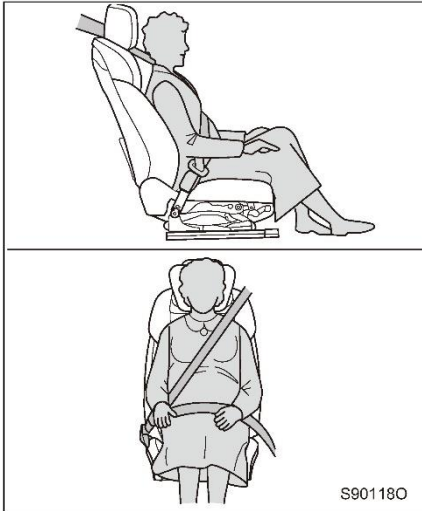

- Please fasten the seat belt correctly according to the doctor's advice.
- Like other occupants, the pregnant woman should also place the waist belt as low as possible across the hip. The shoulder belt should be stretched diagonally along the shoulder and across the chest to avoid touching the raised abdomen with the seat belt.
- If the safety belt is not properly fastened, the pregnant woman and fetus may be seriously injured or even die in case of emergency braking or collision.

■ **Patient**

Please follow the doctor's advice and fasten the seat belt correctly.

■ **When children are in the car**

Do not allow children to play with seat belts. If the seat belt is wrapped around the child's neck, it may cause suffocation or other serious injury leading to death.

If this happens and the lock cannot be released, cut the seat belt with scissors.



WARNING

In order to reduce the risk of personal injury in case of emergency braking or an accident, or avoid serious personal injury or even death, please observe the following precautions.

■ **Wear the seat belt correctly**

- It is very dangerous for the driver to ride in the wrong posture or wear the seat belt in the wrong way. If the seat belt is fastened improperly, the pretensioner and the load limit system can not provide enough protection, which may lead to serious personal injury.
- It's very dangerous not to fasten your seat belt. In the process of collision, the unbelted occupant may collide with other people or objects in the car, or even be thrown out of the car, resulting in serious injury or even death. In the same collision, the belted occupants will be safer.

■ **Do not wear twisted seat belt**

Twisted seat belts are very dangerous. In the process of collision, the safety belt will not be able to make full use of the full width to absorb the impact force, so that more force will be exerted on the bone under the safety belt, which may lead to serious injury or even death.

■ **Do not share one seat belt with multiple occupants**

It is very dangerous for multiple occupants (including children) to share a seat belt, because the seat belt can not properly disperse the impact force, the occupants will crash together, which will lead to serious injury and even death.

■ **Adjustable shoulder anchorage (front seat)**

Make sure the shoulder belt is across the middle of the shoulder. The safety belt should be kept away from the neck, but not from the shoulder. Otherwise, the protective effect of the safety belt will be reduced in case of an accident, and serious injury or even death will be caused in case of emergency braking, emergency steering or accident.

■ **Do not tilt the seat too much**

Do not tilt the seat too much for comfort, because only when the occupant is sitting upright and leaning against the backrest, the seat belt will play better protection.

■ **Do not drive with a damaged seat belt**

It is very dangerous to use a damaged seat belt. An accident may cause damage to the seat belt. A damaged seat belt cannot provide adequate protection in a collision. Before using the seat belt again after the accident, all seat belt systems shall be thoroughly inspected by the authorized FAW Hongqi dealer.

■ **Seat belt pretensioner**

In the event of a collision, please contact the authorized FAW Hongqi dealer to check the seat belt pretensioners and airbags. Like the airbag, the seat belt pretensioner can only be used once, and must be replaced after the collision. If it is not replaced, it will increase the risk of serious injury to the occupant in case of another collision.

**WARINING****■ Damage and wear of seat belt**

- Do not let the door clamp the seat belt or latch, or the seat belt may be damaged.
- Seat belt devices must be checked regularly. Check the seat belt for cuts, wear and looseness. Do not use the damaged seat belt. Replace it. The damaged seat belt can not protect the occupants, which may cause serious injury or even death.
- Make sure the belt latch and buckle are locked and the belt is not twisted. If the seat belt does not work properly, please contact the authorized FAW Hongqi dealer immediately.
- In the event of a serious vehicle accident, replace the seat belt with the seat assembly even if there is no obvious damage.
- Do not install, dismantle, refit, disassemble or dispose of seat belts without authorization. Please contact the authorized FAW Hongqi dealer for necessary treatment.

**Notice****■ Keep seat belts clean**

If the seat belt is dirty, it may be difficult for the seat belt to retract. Therefore, please keep the seat belt clean. (Refer to P.306)

1-1.Instructions for safety operation

Airbag

1

Airbag is a kind of passive safety protection device which is equipped to slow down or avoid the injury of occupants when the vehicle suffers some serious impact that may cause serious injury to the occupants. When the vehicle suffers some serious impact, the airbag will expand. The vehicle is equipped with multiple airbags, which are used together with seat belts to reduce the risk of serious injury and even death of occupants in the vehicle. (airbag deployment shape is for reference only)

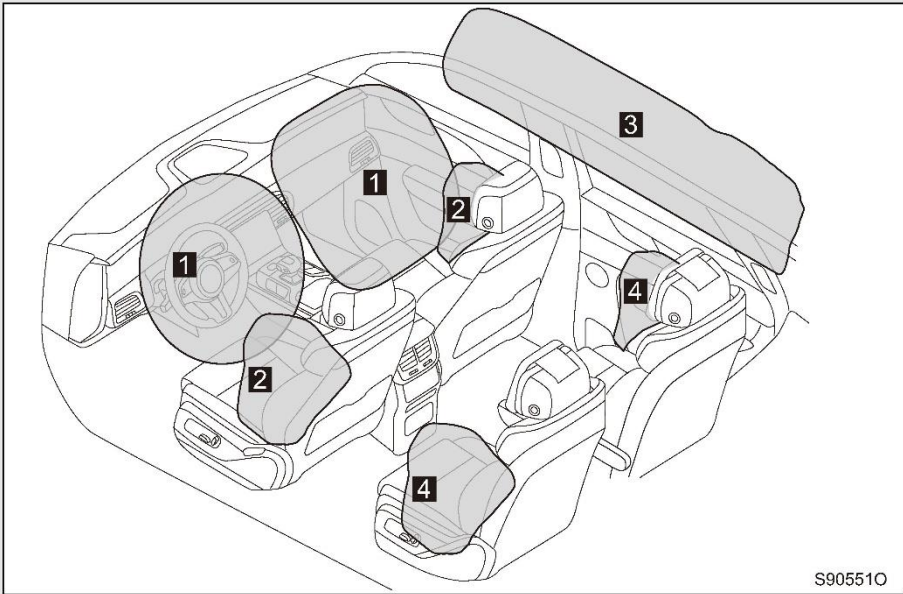

S90551O

1 Driver airbag/front passenger airbag

Protect the head and chest of the driver and the front passenger from the impact of the interior components.

2 Driver seat airbag/front passenger seat airbag

Protect the torso area of the driver and the front passenger.

3 Curtain airbag

Protect the head of the driver, front passenger and rear outer occupant.

4 Second-row seat airbag*

It can protect the torso of the occupants sitting on both sides of the second row.

Supplemental Restraint System (SRS) components

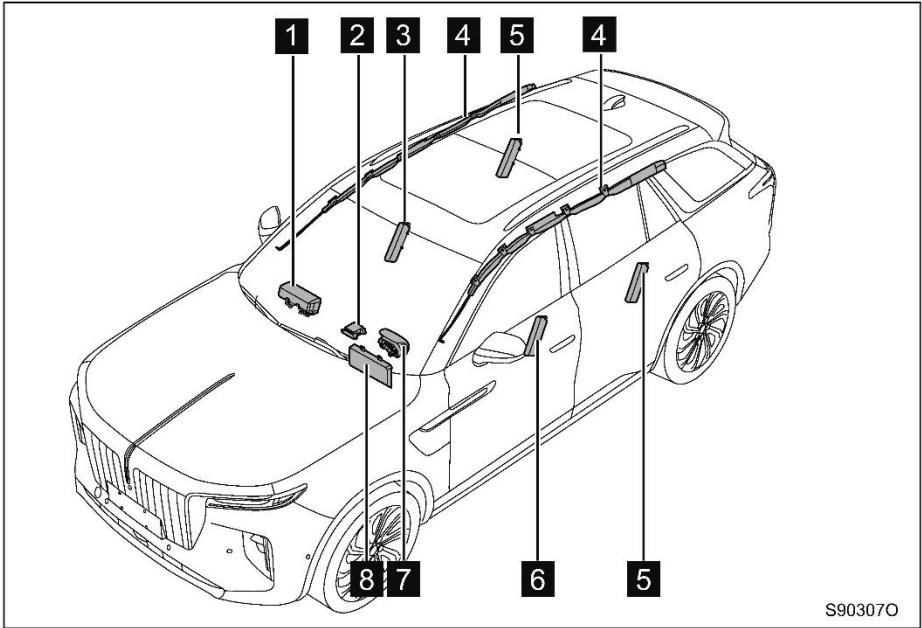

- | | |
|--------------------------------------|----------------------------------|
| 1 Front passenger airbag | 5 Airbag control unit |
| 2 Front passenger seat airbag | 6 Curtain airbag |
| 3 Second-row seat airbag* | 7 Driver's seat airbag |
| 4 Driver airbag | 8 Airbag fault alarm lamp |

The above are the main components of the Supplemental Restraint System (SRS).

In the event of some serious front or side impact, the SRS will trigger the airbag gas generator. The chemical reaction in the inflator makes the airbag filled with non-toxic gas quickly, so as to avoid injury to the occupants due to a secondary collision with internal parts of the vehicle.



WARNING

■ Precautions for airbag

Please observe the following precautions about the airbag, otherwise it may lead to serious personal injury or even death.

- The driver and all occupants in the vehicle must fasten the seat belt correctly. Airbag is an auxiliary device used with the seat belt.
- The impact force of the driver's airbag is considerable when it is deployed, and may lead to serious injury or death if the driver is too close to the airbag.
- When the driver's airbag is deployed, the front 0 - 100 mm deployment range is a high-risk area. There shall be a distance of at least 300 mm from the driver's airbag, which is the distance from the center of the steering wheel to the driver's sternum. If the distance after you sit is less than 300 mm, you can adjust the driving position by using the following methods:
 - Move the seat back as far as possible, but still subject to easy access to the pedals.
 - Tilt the backrest slightly back. If it is difficult to see the road ahead after the backrest is tilted, you can raise the seat or use the hard anti-skid cushion to raise your body.
 - Adjust the steering wheel to tilt it down as far as possible. This allows the airbag to be directed at the driver's chest rather than the head and neck.

When adjusting the driver seat according to the above suggestions, the pedal and steering wheel should be kept in the driver's control range, and the control switch of the instrument panel should also be kept in the driver's field of vision.

- When scrapping the components of vehicle or SRS and pre-tensioned seat belt, the relevant safety regulations must be observed.

■ Be sure to fasten your seat belt

Seat belts must be worn when driving vehicles equipped with airbags. It is very dangerous to rely only on airbag protection in an accident, The airbags alone may not prevent serious personal injury. Therefore, be sure to fasten the seat belt when riding.

WARNING
■ Precautions for airbag

- The impact force of the front passenger airbag is considerable when it is deployed, and may lead to serious injury or death if the front passenger is too close to the airbag. The front passenger seat should be as far away from the airbag as possible, and the backrest should be adjusted to make the front passenger sit upright.
- Improperly seated/protected infants can be seriously injured or even killed by the deployment of airbags. Infants who are too small to use seat belts should be protected with appropriate restraint using a child restraint system. We strongly recommend that infants and babies be placed in child seats which are fitted on the rear seats of the vehicle. For infants, the rear seat is safer than the front passenger seat.



- Please do not lean on the instrument panel, A-pillar, roof side sill, door area or seat edge, otherwise, when the front passenger airbag deploys, it may cause a strong head impact, which may lead to serious injury or even death (When there are children in the car, you should pay more attention).



- Do not allow children to stand in front of the front passenger airbag.
- Do not place any object or let any child sit on the front passenger's lap.



- Do not lean on the door, roof side sill, A-pillar and B-pillar.

⚠ WARNING

■ Precautions for airbag



- Do not kneel on the occupant seat with your face towards the door or extend your head or hands out of the vehicle.

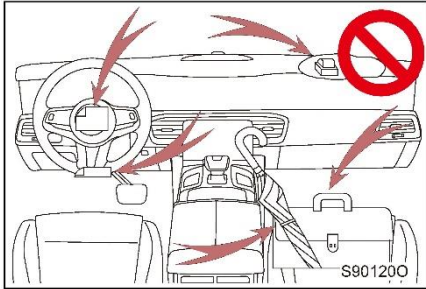

- Do not attach or lean any objects to the instrument panel or driver airbag cover. This is because these objects may be ejected when the driver airbag or front passenger airbag deploys.

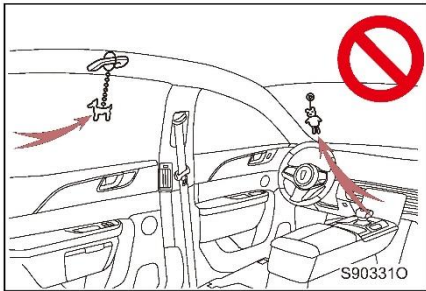

- Do not tether any objects to the doors, windshield, window glass, A-pillar, B-pillar, C-pillar, roof side sill or ceiling handle, etc.
- Do not hang hangers or other hard objects on coat hooks. If the curtain airbag deploys, these objects could be ejected and result in serious injury or death.

**WARINING**

■ **Precautions for airbag**

- Do not use seat accessories that may cover the airbag deployment area of the seat, as they may prevent the airbag from deploying.
- Do not strike the area where the airbag components are located or apply excessive force to them, as this may cause the airbag to malfunction.
- Do not touch the relevant parts immediately after the airbag has deployed (inflated) as they may be hot.
- If you feel difficulty breathing after the airbag deploys, open the doors or windows for ventilation or leave the vehicle if it is safe to do so. Residues on the body should be rinsed as soon as possible to avoid skin irritation.
- If the part where the airbag is located (such as the driver airbag cover and instrument panel) is damaged or ruptured, please contact an authorized FAW Hongqi dealer for replacement.

■ **Vehicle collision**

After the airbag is deployed, SRS can only provide one-time accident protection. After the airbag deploys in a vehicle collision, the airbag, airbag control unit and related parts need to be replaced by an authorized FAW Hongqi dealer, and the original parts are not allowed to be used.

■ **Modification and scrapping of SRS components**

Be sure to contact a qualified company or organization to scrap the airbag.

Do not do the following modifications to the vehicle without consulting the authorized FAW Hongqi dealer. Otherwise, the airbag may malfunction or deploy (inflate) unexpectedly, which may result in serious injury or even death.

- Installation, removal, disassembly and repair of airbags.
- Repair, modification, removal or replacement of steering wheel, instrument panel, seat or seat trim, A-pillar, B-pillar, C-pillar or roof side sills.
- Repair or modification of the front fender, front bumper or sides of the compartment.
- Add snow removal plows, winches and other tools to the front grille.
- Modification of vehicle suspension system.
- Installation of mobile two-way intercoms.

■ If the airbag deploys (inflates)

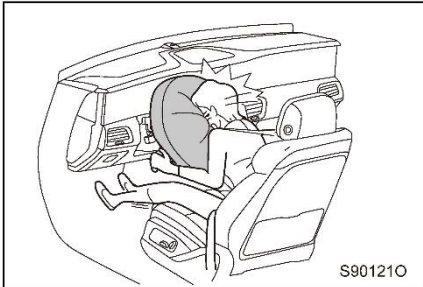

- The impact of an airbag is considerable when it is deployed and may lead to serious injury or death if you are too close to the airbag.
 - Airbag deployment will be accompanied by the sound of airbag detonation and smoke, but not fire. If people with respiratory airway diseases such as asthma inhale the gas, they may experience difficulty breathing. At this point, it is safer to escape from the car immediately. If you cannot escape to the outside of the car, open the windows or doors and inhale fresh air.
- Airbag deployment at very high speed may result in minor abrasion, burn, bruise, etc.
 - If residue (gas, etc.) from the airbag inflation and deployment splashes into the eyes or adheres to the skin, wash with water as soon as possible. People with sensitive skin may have allergic reactions.
 - The airbag module components (including airbag cover and gas generator) and the steering wheel, instrument panel, seats, A-pillar, B-pillar, C-pillar and roof side sill components may get very hot within a few minutes, as may the airbags themselves.
 - The windshield may break.
- ### ■ Airbag triggering factors
- The triggering range of airbags in various accidents can not be generally determined, because the specific circumstances of accidents are very different. For example, the nature of the object (soft and hard) hit by the vehicle, the angle of impact and the speed of the vehicle are important factors for the airbag to trigger.
 - The decisive factor for airbag triggering is the deceleration curve and pressure curve generated during the collision. The sensors installed on the vehicle identify the severity of the collision accident together with the electronic control unit, and selectively trigger the airbag in a timely manner. If the vehicle deceleration or pressure value generated and measured at the time of the collision is lower than the pre-set reference value in the control unit, the airbag will not deploy even though the vehicle may have been deformed to some extent during the accident.
- ### ■ Working conditions (driver airbag/front passenger airbag)
- In a severe front collision, the driver airbag/front passenger airbag will deploy when the level of impact exceeds the set threshold.
However, if the vehicle strikes a movable or deformable object (such as a parked vehicle or signal post) or an "under-run" (such as a collision in which the front of the vehicle under-runs the truck's cargo area), the airbag may not be activated at this time.
 - In some crashes, the vehicle forward deceleration is very close to the design threshold, but the frontal airbags and seat belt pre-tensioners may not activate.

■ Working conditions (seat airbag and curtain airbag)

- In the event of a violent side impact, the seat airbags and curtain airbags on the impact side will deploy when the level of impact exceeds the set threshold.
- In certain special accidents, the seat airbags and curtain airbags may deploy together with the driver airbag/front passenger airbag.

■ Other situations in which the airbags may deploy (other than in a collision)

The driver airbag and front passenger airbag may also deploy if the underside of the vehicle is severely impacted.

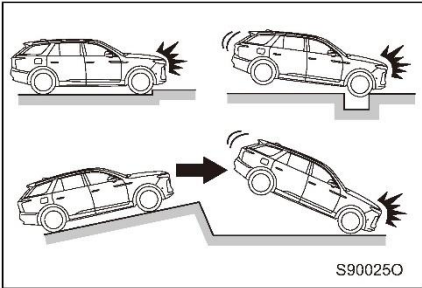

- Hitting a curb, sidewalk edge, or hard surface
- Falling into or crossing a deep pit
- Hard wheel landing or vehicle fall

■ Situations in which the airbags (driver airbag/front passenger airbag) may not deploy

The driver airbag/front passenger airbag may not deploy when the vehicle hits a pole, tree or other cylindrical objects, hits a wall or highway guardrail other than head-on, suffers a rear-end collision, rear-end collision under the rear of a truck or into the bottom of a truck, low-speed head-on collision, side collision, or rollover. However, it may deploy as long as it causes the vehicle to generate sufficient forward deceleration regardless of the type of collision.

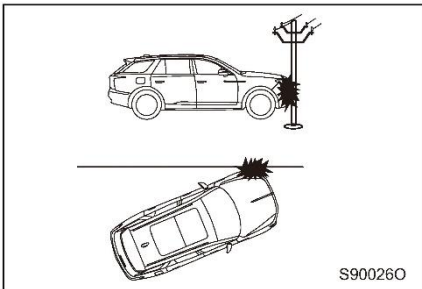

- Hitting a pole, tree or other cylindrical objects
- Hitting a wall or highway guardrail other than head-on

1-1.Instructions for safety operation

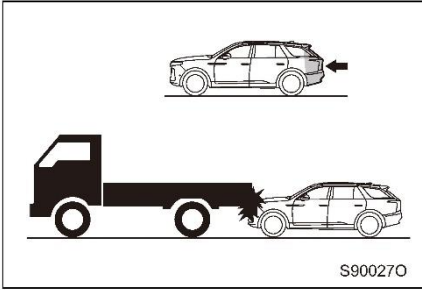

- Rear-end collision
- Rear-end collision under the rear of a truck or into the bottom of a truck

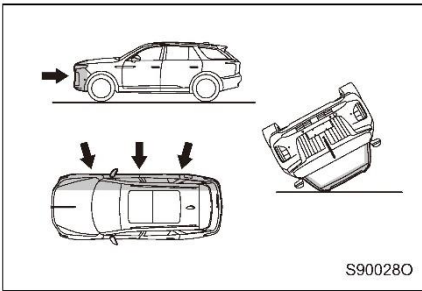

- Low-speed head-on collision
- Side collision
- Rollover

■ Situations in which the airbags (seat airbags or curtain airbags) may not deploy

If the vehicle suffers a side collision in a non-occupant compartment area or a side collision at an angle to the body, the seat airbags and curtain airbags may not deploy.

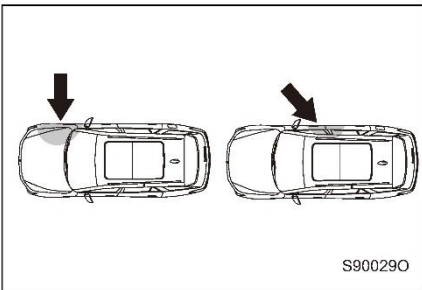

- Side collision in a non-occupant compartment area
- Side collision at an angle to the body

When the vehicle suffers a low-speed head-on collision, low-speed side collision, rear-end collision or rollover, the seat airbags and curtain airbags generally do not deploy.

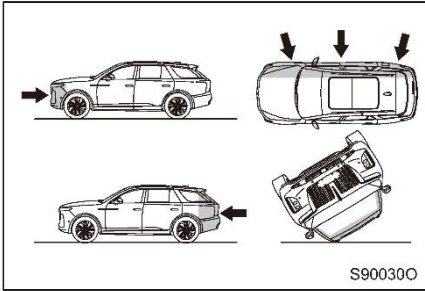

- Low-speed head-on collision
- Low-speed side collision
- Rear-end collision
- Rollover

■ **When should we contact the authorized FAW Hongqi dealer**

The vehicle needs to be inspected and/or repaired in the following cases. Please contact an authorized FAW Hongqi dealer as soon as possible.

- Any airbag has deployed.

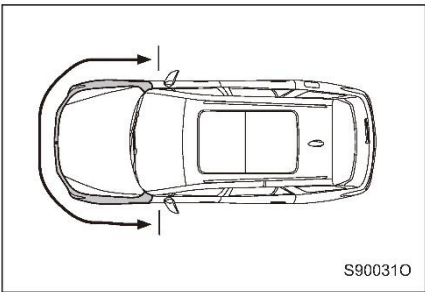

- The front of the vehicle is damaged or deformed, or there has been a crash in which the airbag did not deploy.

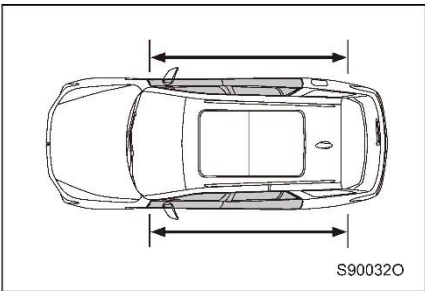

- The door section or the area around the door is damaged or deformed, or there has been a crash in which the seat airbag and curtain airbag did not deploy.

1-1.Instructions for safety operation

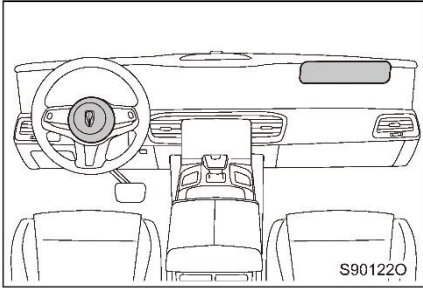

- There are scratches, cracks, or other damage to the driver airbag cover or the instrument panel near the front passenger airbag.

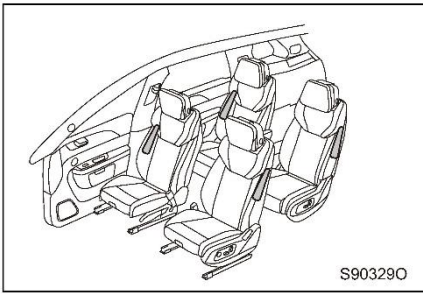

- There are scratches, cracks or other damage to the surface of the seat equipped with a seat airbag.

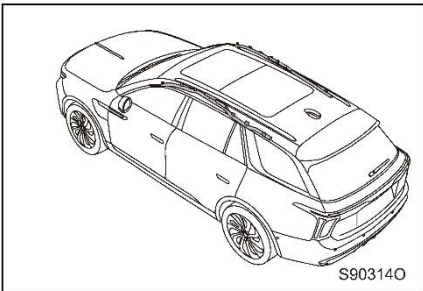

- There are scratches on the curtain airbag and cracks or damages on the A-pillar guard, B-pillar guard and C-pillar guard, ceiling, handle, reading lamp, microphone, etc.

When there are children in the car, please observe the following precautions.

Children should use appropriate child restraint systems until they are large enough to use the seat belts on the vehicle.

FAW recommends using child seats with ISOFIX for best possible safety for the children in the car. It's recommended for this car to secure the child restraint device to the seats in the second row via ISOFIX rigid anchor.

- It is recommended that children be allowed to sit in the rear seats to prevent accidental contact with the gearshift lever, wiper switch, etc.
- During driving, use the rear door safety lock to lock the doors and windows to prevent children from opening the doors and accidentally operating the power windows.
- Do not allow children to operate equipment that may trap body parts (e.g. power windows, hatch, trunk lid, seats, etc.).



WARNING

■ **Do not allow children to carry vehicle keys or play alone in the vehicle**

Do not leave children alone in the vehicle. Do not allow children to carry or use keys.

Children may start the vehicle or operate the shift lever. Children may also injure themselves when playing with windows, sunroofs or other vehicle equipment. In addition, too high or too low a temperature in a vehicle can be fatal to children.

■ **Always lock the vehicle and keep the keys out of the reach of children**

It is very dangerous to leave the vehicle unlocked or to leave the keys within the reach of children when getting out of the car. Children who enter the trunk through an open trunk are accidentally locked in the trunk. Especially in summer, this can lead to heat stroke and deficiency in children, which can cause brain damage or even death. Whether you have children or not, be sure to lock your car doors and trunk.

FAW recommends that you use a child restraint system.

Points to keep in mind

FAW recommends using child safety seats with ISOFIX system to ensure the safety of children in the car as much as possible; it is also recommended that the child safety seat be fixed on a second row seat with ISOFIX rigid anchors.

- Please choose the appropriate child restraint system according to the weight and size of the child.
- For installation details, please refer to the instructions that came with the child restraint system.

This Manual provides general installation instructions.

Types of child restraint systems

The child restraint systems can be classified into the following five groups:

Group 0: < 10 kg

Group 0+: < 13 kg

Group I: 9 - 18 kg

Group II: 15 - 25 kg

Group III: 22 - 36 kg

Information on the adaptability of child restraint system secured by ISOFIX in different ISOFIX positions

Mass group	Size category	Fixing module	ISOFIX position on the vehicle	
			Second-row left seat	Second-row right seat
Portable bed	F	ISO/L1	X	X
	G	ISO/L2	X	X
Group 0: < 10 kg	E	ISO/R1	✓	✓
Group 0+: < 13 kg	E	ISO/R1	✓	✓
	D	ISO/R2	✓	✓
	C	ISO/R3	✓	✓
Group I: 9 - 18 kg	D	ISO/R2	✓	✓
	C	ISO/R3	✓	✓
	B	ISO/F2	✓	✓
	B1	ISO/F2X	✓	✓
	A	ISO/F3	✓	✓

X: Indicates that the ISOFIX position does not apply to ISOFIX child restraint systems of this mass group and/or size category.

■ Selecting a suitable child restraint system

- Children should use appropriate child restraint systems unless they grow up to fit the seat belts on the vehicle.
- If a child is too large to use a child restraint system, the child should be seated in the second-row seat and secured with a seat belt.



WARNING

■ **Manufacturer's instructions for child restraint systems**

Pay attention to the manufacturer's instructions when selecting, installing and using a child restraint system, or you may not get the desired protection.

■ **When children are in the car**

Do not allow children to play with seat belts. If the seat belt is wrapped around the child's neck, it can cause suffocation or other serious injury or even death.

If this happens and the lock cannot be released, cut the seat belt with scissors.

■ **When not using a child restraint system**

- Even if a child restraint system is not used, it is important that it should be properly secured in the seat.

Do not place an unsecured child restraint system in the occupant compartment.

- If the child restraint system must be removed, remove it from the vehicle and place it in the trunk to secure it. If the headrest is raised when the child restraint system is installed, be sure to adjust the headrest to a proper position before driving. This will prevent injuries to occupants in the event of emergency braking or an accident.

■ **Use of child restraint systems**

If a child restraint system that is not suitable for this vehicle is used, the infant or child may not be properly protected. This may result in serious injury or death (in the event of emergency braking or an accident).

■ **Precautions for child restraint systems**

- A seat belt or child restraint system must be used to restrain and protect children according to their weight and size in order to effectively protect them in the event of an accident and emergency braking. Holding a child in your arms does not replace the role that a child restraint system plays. In an accident, the child may hit the windshield or be squeezed between you and the car.
- We recommend that you choose the right child restraint system for your child's size and install it in the second-row seat. Installing a child restraint system in the front passenger seat is strictly prohibited.
- Vehicles with seat airbags and curtain airbags: Even if a child is placed in a child restraint system, do not allow him/her to rest his/her head or any part of his/her body against the doors, seats, roof side sills (deployment area of the seat airbag or curtain airbag). Otherwise, seat airbags and curtain airbags can be very dangerous when they deploy, and their powerful impact can cause serious injury or even death to the child.
- Be sure to follow the instructions provided by the manufacturer and always ensure that the child restraint system is securely fastened. A child restraint system that is not securely fastened is very dangerous. In the event of emergency braking or a collision, the child restraint system can move, resulting in serious injury or even death to the child or other occupants.
- It is not recommended to use child seats only fastened with safety belts. Emergency braking or collision may lead to serious injury or death for child or another passenger.

1-1.Instructions for safety operation Installing a child restraint system

Please follow the instructions provided by the manufacturer of the child restraint system. Securely fix the child restraint system to the seat with the ISOFIX rigid anchorage. During the installation of the child restraint system equipped with top strap, the top strap shall be fixed.

Installation with ISOFIX rigid anchor

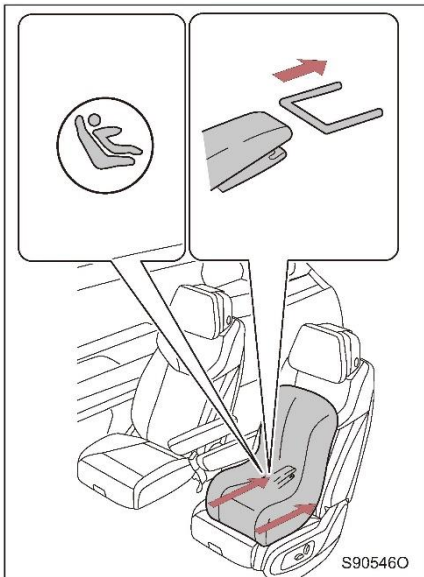

STEP 1 Slightly increase the gap between the seat cushion and the backrest.

STEP 2 Fit the child seat buckle to the ISOFIX rigid anchorage and lock securely.

If the headrest interferes with the child restraint system and cannot be installed correctly, rise the headrest and install the child restraint system.

If a child restraint system is equipped with a top strap, the top strap shall be secured to the anchor support.

Child restraint system with top strap

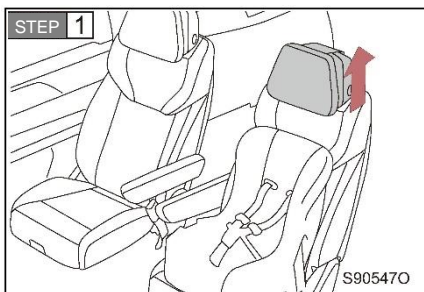

Fix the child restraint system with the ISOFIX rigid anchorage.

If the headrest interferes with the child restraint system and cannot be installed correctly, rise the headrest and install the child restraint system.

1-1.Instructions for safety operation

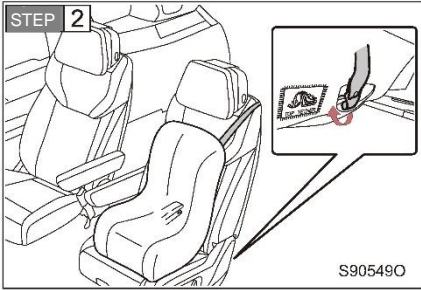

Fix the hook firmly to the anchor support and fasten the top strap.

Make sure to fasten the top strap securely.

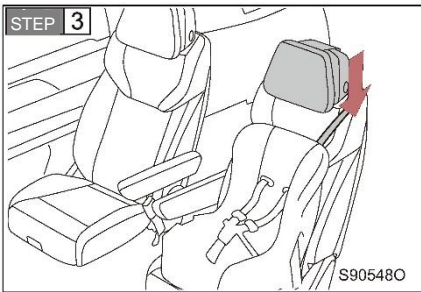

Restore the headrest to its correct position.

WARNING

■ When installing a child restraint system

Please observe the following precautions, otherwise it may lead to serious injury or even death.

- Tie the top strap securely and make sure the seat belt is not twisted.
- Do not tie the top strap to anything other than the anchorage bracket.
- Push and pull the child restraint system in different directions to ensure it is securely installed.
- Do not adjust the seat after installing the child restraint system. If the seat is adjusted, the safety of the child restraint system should be reconfirmed.
- Please follow the instructions for installation provided by the manufacturer of the child restraint system.



- There are labels on the inside and outside of the front passenger side sun visor reminding you never to install a rear-facing child restraint system in the seat that is protected by the airbag. Details about the label are shown in the figure.

■ Properly securing the child restraint system to the anchorages

When using the lower anchorages, make sure that there are no foreign objects around the anchorages and that the seat belt is not stuck behind the child restraint system.

1-1. Instructions for safety operation

High voltage safety

The electric vehicle is equipped with level B high-voltage systems. If the vehicle is used improperly, it may cause electric shock or fire hazards to occupants and operators.

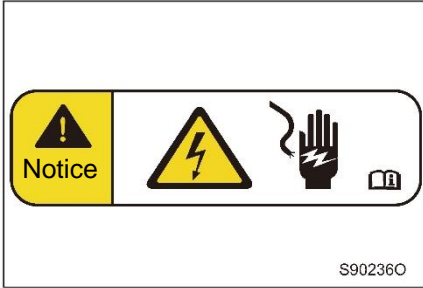

The high-voltage harness and the high-voltage connector are both marked in orange. The high-voltage components (except harnesses) are affixed with high-voltage marks.

■ Meaning of high-voltage marks

	Risk of electric shock		Notice
	Read the operating instructions		Electric shock

■ Active discharge of high-voltage system

After the power (ignition) switch is turned to OFF, the high-voltage system actively discharges and releases the remaining voltage of the high-voltage components to a safe voltage so as to prevent the occupants from being exposed to high voltage.

■ After vehicle collision

- High-voltage relay opens.
- The high-voltage circuit quickly enters an uncharged state to avoid electric shocks.
- The high-voltage components are actively discharged.
- It is forbidden to start or charge the vehicle again.

■ Self-protection measures against the electric shock of vehicle

- Think calmly, protect yourself, and don't put yourself at the risk of electric shock.
- Do not directly touch the electric shocked person.
- If possible, immediately cut off the power supply of the electrical equipment (power off at high voltage or disconnect low-voltage repair switch).
- Use non-conductive tools (wooden board, broomstick, etc.) to separate the injured from the current conductor or the power supply.

- **Medical protection measures against the electric shock of vehicle (the person who gets an electric shock cannot speak)**
 - Rescue on the site; when the person who gets an electric shock is disconnected from the power supply, immediately confirm its vital functions, such as pulse and breathing.
 - Call for help immediately and contact the emergency doctor.
 - Do artificial respiration and chest compression before the doctor arrives.
 - If the person who gets an electric shock stops breathing, use a defibrillator if possible.
- **Medical protection measures against the electric shock of vehicle (the person who gets an electric shock can still speak)**
 - Cool down the wound and cover it with a sterilized towel.
 - To avoid delayed sequelae, immediately send the injured to the doctor for help.
- **Rescue in the event of electrical fire**
 - Protect yourself and do not breathe fumes.
 - Call the fire department.
 - When extinguishing fires on electrical equipment, use CO2 fire extinguishers or foam fire extinguishers.
 - Do not use CO2 fire extinguishers to extinguish fires on persons. Because there is a danger of suffocation.
 - Place the fire extinguisher within a convenient range, and arrange persons to inspect it regularly.



WARNING

■ Precautions on high-voltage system

Please observe the following precautions, otherwise it may lead to serious injury or even death.

- Non-qualified high-voltage professionals are not allowed to remove and repair components affixed with high-voltage marks and high-voltage harnesses.
- Remember that the power battery has high voltage. Do not touch the power battery.
- Do not spray high-pressure components directly with spray pipes and high-pressure cleaning devices.
- When inspecting and repairing high-voltage conductive parts and accessories, the high-voltage system must be powered off.
- Do not use engine oil, lubricating oil, etc. on the high-voltage connector.

1-2. Charging/discharging

Methods and steps of charging/discharging

Charge through household or industrial electrical socket (230V)

Start charging

- STEP 1** Park the vehicle in an AC chargeable area, depress the brake pedal, turn the gear to P, and apply the parking brake.
- STEP 2** Take out the AC charging cable for the household or industrial electrical socket (230V), and check that the power plug and the power socket are clean and free of dirt.
- STEP 3** Connect the power plug of the charging cable for household or industrial power (230V) to the power socket. The power supply indicator of the control box is illuminated in green.
- STEP 4** Open the charging port cover. The charging indicator of the charging port remains on (in white). (Refer to P.152)
- STEP 5** Check that the charging plug and the charging socket are clean and free of dirt.

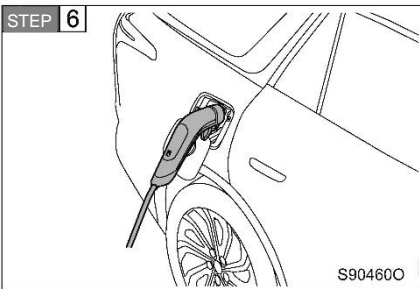

Connect the charging plug to the charging socket. At this time, the instrument cluster shows that the charging gun is connected, and the AC charging port indicator and the C-pillar charging indicator will remain on (in blue).

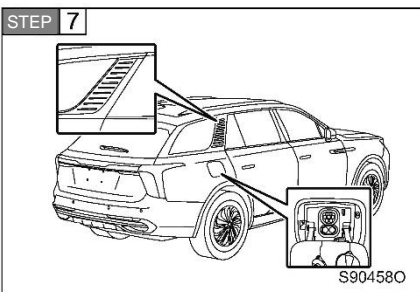

Charge according to the instructions of the AC charging device. If charging has started, the charging port indicator and the C-pillar charging indicator will flash (in green), and the instrument cluster will indicate that the AC charging is in progress.

After the charging is completed, the charging port indicator and the C-pillar charging indicator will remain on (in green).

Note: The vehicle can be charged when the power (ignition) switch is set to ON/OFF mode.

Stop charging

- STEP 1** Make sure that the charging electronic lock is unlocked. (page 152)

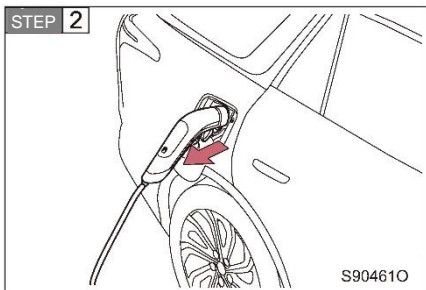

Unplug the charging plug on the vehicle end.

At this time, the charging connection indicator  on the instrument cluster will go out.

STEP 3 Close the charging port cover. (Refer to P.152)

STEP 4 Disconnect the power plug from the power socket and keep the AC charging cable for the household or industrial electrical socket (230V) properly.

DC charging

- **Start charging**

STEP 1 Stop the vehicle in the DC charging area, press the brake pedal, set the shift lever to P position, and apply the parking brake.

STEP 2 Open the vehicle inlet cover. The charging indicator lamp (white) at the vehicle inlet is always on. (See P.154)

STEP 3 Check and confirm that the vehicle connector and vehicle inlet are clean and free of dirt.

1-2. Charging/discharging

STEP 4

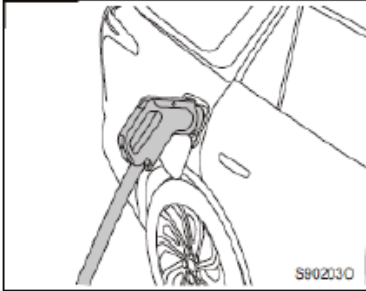

Connect the vehicle connector to the vehicle inlet, and lock the electronic lock. At this time, the instrument cluster shows that the charger is connected, and the charging indicator lamps (blue) at the DC vehicle inlet and C-pillar are always on.

STEP 5

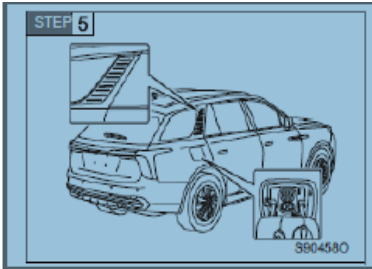

Charge the vehicle according to the instructions of the DC charging equipment. If the charging is started, the charging indicator lamps (green) at the DC vehicle inlet and C-pillar flash, and the instrument cluster shows that DC charging is in progress. After charging, the charging indicator lamps (green) at the DC vehicle inlet and C-pillar are always on.

Note: No matter the power (ignition) switch is set to ON or OFF, the vehicle can be charged.

● Stop charging

STEP 1 Stop charging according to the instructions of the DC charging equipment and ensure that the charging electronic lock is unlocked. (See P. 152)

Step 1: Press the open/close button to finish charging/discharging

Step 2: Press the open/close button again to unlock the charging lock.

STEP 2

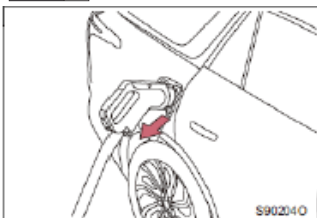

Remove the vehicle connector. At this time, the charging connection indicator lamp on the instrument cluster  goes out.

STEP 3 Close the vehicle inlet cover. (See P.152)

AC discharge

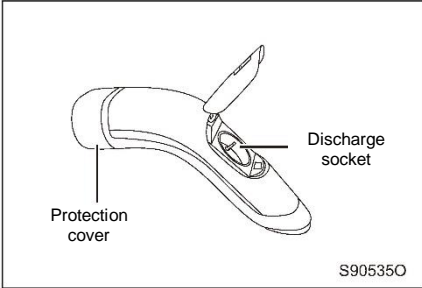

AC discharge gun.

■ Start to discharge

- STEP 1** Park the vehicle in an AC dischargeable area, depress the brake pedal, turn the gear to P, and apply the parking brake.
- STEP 2** Open the charging port cover. The charging indicator of the charging port remains on (in white). (Refer to P.152)
- STEP 3** Take out the AC discharge gun, and check that the discharging plug and the charging socket are clean and free of dirt.

1-2. Charging/discharging

STEP 4

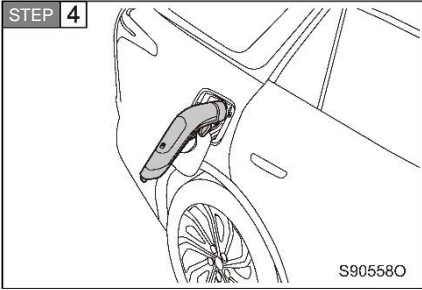

Connect the discharge plug to the AC charging socket, at this time the charging port and the C-pillar charging indicator will remain on (in blue).

STEP 5

When the charging port indicator and the C-pillar charging indicator remain on (in purple), it means that the vehicle is discharging.

Note: The vehicle can be discharged when the power (ignition) switch is set to ON or OFF mode.

■ Stop discharging

STEP 1

Make sure that the charging electronic lock is unlocked. (Refer to P.152)

STEP 2

Turn off the power supply of the household appliance and disconnect the household appliance plug from the discharge socket.

STEP 3

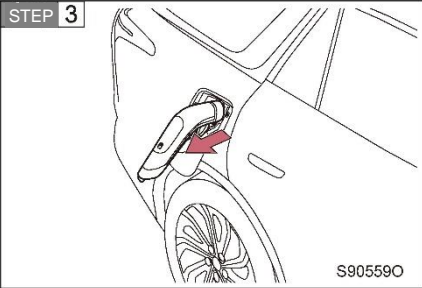

Disconnect the discharging plug.

STEP 4

Close the charging port cover. (Refer to P.152)

STEP 5

Keep the AC discharge gun properly.

Electronic charging lock

The charging electronic lock is used to lock the charging/discharging plug so as to prevent the user from disconnecting the live charging/discharging plug during charging/discharging and to avoid the charging cable from being stolen when charging in an unattended environment.

■ Locking of charging electronic lock

The electronic lock will be locked in case of any of the following conditions:

- When the user fully connects the charging/discharging plug to the charging port, the electronic lock is automatically locked.
- When the electronic lock is unlocked and the charging/discharging plug is maintained in connected state, the electronic lock will be automatically locked after 120 s.

- Unlocking of charging electronic lock

Step 1: Press the open/close button to finish charging/discharging

Step 2: Press the open/close button again to unlock the charging lock.

The electronic lock will be unlocked in case of any of the following conditions:

- Users carry the intelligent key and touch the charging port closing button (refer to P.152), and the electronic lock will be unlocked.
 - Touch the charging port cover open/close button on the multimedia system charging setting interface (refer to P.227), and the electronic lock will be unlocked.
- Emergency unlocking of charging electronic lock

When the charging electronic lock fails to be unlocked due to insufficient battery or other reasons, please contact the authorized FAW Hongqi dealer.

- **Remote charging**

The remote AC charging can be set through the mobile APP. (Refer to P.254)

- **Charging time**

The actual charging time is related to the environment and other factors. Please refer to the charging time reminder on the multi-function display of the instrument cluster or the mobile APP.

- **Charging port indicator**

The indicator is used to remind the user of the connection status of the charging/discharging plug and the charging/discharging status.

- When the charging port cover is opened and the charging/discharge plug is not connected, the white indicator of the charging port will be illuminated.
- When the charging/discharging plug is correctly connected to the charging port, the blue indicator of the charging port will be illuminated.
- When the charging/discharge plug is connected incorrectly, the yellow indicator of the charging port will be illuminated.
- During charging, the green indicator of the charging port flashes; When the charging is completed, the green indicator of the charging port remains on.
- The blue indicator will go out when the charging plug is connected for a while but the charging equipment is not operated.
- When the power supply equipment or the power socket stops supplying power, the charging port indicator will remain on in green for a period of time and then go out.
- The purple indicator of the charging port remains on during the AC discharging.
- When the vehicle fails and cannot be charged, the red indicator of the charging port will be illuminated.

- **C-pillar charging indicator**

Due to different configurations of models, the C-pillar charging indicator is only available for certain models.



WARNING

■ Precautions for charging

- Do not insert or pull out the plug with wet hands or standing in water, liquid or snow. Otherwise, it may cause electric shock, resulting in serious personal injury or even death.
- Make sure that there is no water or foreign object in the vehicle socket, charging plug or power plug, and they are free of damage or corrosion. Otherwise, it may cause a short circuit, electric shock or fire, resulting in serious personal injury or even death.
- Do not touch the metal contacts at the charging port, charging plug, and power plug.
- When lightning occurs, do not touch the vehicle or the charging equipment. Lightning strikes may be transmitted to the charging equipment, causing damage to the equipment and possible personal injury or death.
- Do not disassemble or modify the charging port and the AC charging cable, otherwise it may cause a fire.
- Do not pull, twist or drag the charging cable.
- Do not place the charging device near high-temperature objects.
- When unsupervised, unauthorized persons (for example, children at play) shall not touch the charging system or the vehicle. When using a household or industrial electrical socket (230V), it is recommended to use the AC charging cable suggested by FAW. If other charging cables are used for AC charging, it may cause damage to the vehicle or the charging equipment or even cause a fire.
- Do not use extended cables, cable reels, multiple sockets and travel adapters.
- If any part shows signs of damage, wear, cracking, or others, do not use it.
- When using the charging cable, handle it with care to avoid falling, and do not pull the wire or cable forcefully.
- The power socket and the power supply circuit must be grounded and protected by a special circuit breaker or fuse to avoid danger.
- The AC charging cables for household or industrial electrical sockets (230V) shall conform to NEK 502. It is prohibited to use other sockets.
- If you have any question about the power socket and power supply circuit, please consult a qualified technician.

■ Cases where possible electric shock can occur while charging

- The socket for charging is not grounded.
- Charge in rainy days.

■ Precautions for use of DC charging connection device

- Considering that the DC charging plug is heavy and the accidental fall of the charging plug may cause damage to the vehicle and the charging plug or personal injury, please pull out the charging plug carefully.

Notice

■ During AC discharging

- The discharge function can be activated when the power battery level is higher than the discharge limit, and deactivated when the power battery level is lower than the discharge limit.
- During AC discharging, the vehicle will automatically terminate AC discharging once the power battery level displayed on the instrument reaches the discharge limit.
- The rated discharge current of the discharge socket is 16 A. When using the AC discharge function, do not make the total current of the discharge socket exceed 16 A.

■ Electronic charging lock

- Before disconnecting the charging/discharging plug, make sure that the electronic lock is unlocked, otherwise the charging cable or the vehicle may be damaged.
- When charging in an unattended environment, please lock the charging electronic lock, otherwise the charging cable may be stolen.

■ Precautions for use of AC charging cable

- Ensure that the AC charging cable is stored properly and do not immerse it in water.
- Prevent foreign objects from entering the terminal of the AC charging cable plug.
- Do not step on, fold or knot cables and wires.
- Do not use AC charging cables during thunderstorms.
- Do not use AC charging cables in wet locations.
- Do not place heavy objects on the AC charging cable.



Notice

■ Precautions for use of AC charging cable

- When charging, the AC charging cable shall be kept away from high-temperature objects.
- When not in use, please fit the protective cover properly and place the AC charging cable in a cool and dry place where there is no direct sunlight.

■ Emergency charger

- The emergency charger that comes with the car should only be used for emergency charging.
- The car must be kept under supervision during the entire charging process
- Extension cord or adapter must not be used.
- At temperatures below zero degrees, the maximum charging speed will be limited to approx. 1kW
- In case of emergency charging in freezing temperatures, the warm-up time shown on the screen will not be accurate, as it is calculated based on charging from a home charger (Mode 3). The heating of the propulsion battery will therefore take longer than estimated before charging starts.
- Regular charging of an electric car at home should only be done using an electric car charger installed by an approved electrician

■ After vehicle collision

It is forbidden to restart or charge the vehicle.

■ It is forbidden to connect the AC charging plug and the DC charging plug at the same time, otherwise the charging may not start or may be suspended.

■ Precautions for power battery

- When the ambient temperature is too high or too low, the charging time may be prolonged. Long-term charging at too high or low temperature may affect the battery life.
- Do not use high-power DC fast charging method frequently to charge the vehicle. The high-power DC fast charging can affect the service life of the power battery. It is recommended to give priority to AC charging when conditions are available and time permits.
- To ensure the maximum driving range and the safety of the vehicle when the battery is nearly fully charged, the system will reduce the charging speed. If there is no need for long-distance driving, it is not recommended to charge in this section (set the charging limit to 90%) to reduce charging time. If you need to charge in this section, it is recommended to turn off the A/C system.
- When the battery temperature is too low, the vehicle will start the battery heating first after connecting with the charging plug, thus the charging start time will be delayed. When charging and heating, the instrument will prompt the information in power battery heating.

1-2. Charging/discharging

Display and settings of charging/discharging

Display of charging/discharging

■ Charging display on instrument cluster

During the charging process, the multi-function display of the instrument cluster will show the remaining charging time, the power and other related parameters.



■ Charging display on multimedia display

During the charging process, the charging setting interface of the multimedia display will show the remaining charging time, the power and other related parameters, and at the same time the charging limit, timing charging and other functions can be set on the interface.



Charging limit settings

The default custom charging limit in the vehicle is 100%.



- Move the slider on the charging setting interface of the multimedia system to set the charging limit. The setting range is 50%-100%, and the setting interval is 5%.
- When the charging capacity is greater than or equal to the charging limit set by the user, the vehicle will stop charging and prompt "Charging completed".
- When the vehicle displays "Charging completed", if the user sets the charging limit > current power again at this time, the charging gun shall be reconnected before starting charging again.

Discharge limit settings

The default custom discharge limit in the vehicle is 20%.



- Move the slider on the charging setting interface of the multimedia system to set the discharge limit. The setting range is 5%-40%, and the setting interval is 5%.
- After the vehicle starts to discharge, the multimedia system will calculate the remaining discharge time and prompt "AC discharging" simultaneously.
- When the remaining power reaches the discharge limit set by the user, the vehicle will stop discharging, and the instrument cluster display will prompt "SOC value < set value, discharging cannot be activated".

Timed charging

■ Timed charging settings

The timing charging function is achieved with the AC charging device of Hongqi brand.

STEP 1 Turn the power (ignition) switch to ON.

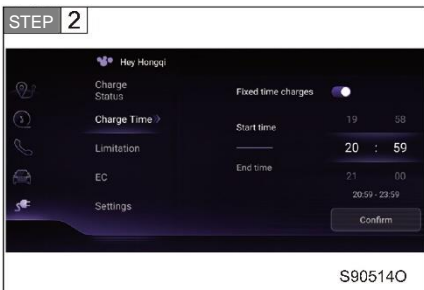

Enable the timed charging and set the time in the charging settings of the multimedia system.

The timed charging switch is OFF by default. There will be an interval of at least 10 minutes between the start time and end time.

STEP 3 Park the vehicle in an AC chargeable area, switch the gear to P, apply the EPB, connect the AC charging device, and set the charging pile to start charging. After doing all these, if there is no system fault in the vehicle and the charging equipment, the vehicle will begin to do AC charging at the appointed time set by the user.

■ Timed charging display

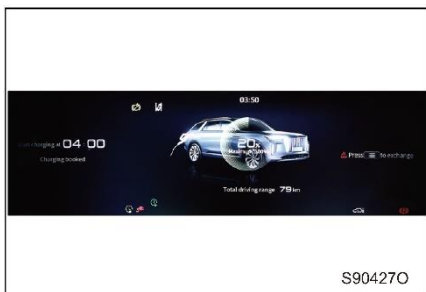

When the time for timed charging is not reached, the instrument will display the scheduled charging information, and the scheduled charging indicator ⌚ will be illuminated.



When the time for timed charging is reached, the instrument will display "Start charging - AC charging" in turn.

1-2. Charging/discharging

■ Start of timed charging in advance



When the vehicle is in the timed charging waiting state, by touching the multimedia system charging interface [Start], the AC charging can be started immediately without turning off the timed charging switch.



If the AC charging is started in advance, the information displayed on the instrument will change from "Charging reserved" to "Starting charging - AC charging".

Low battery reminder

The default custom low battery notification of the vehicle is 20%.

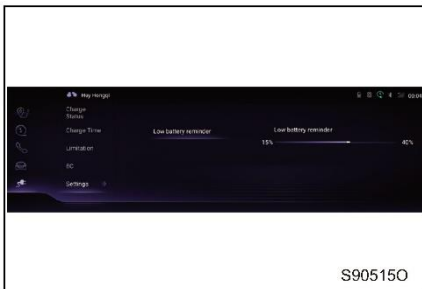

Move the slider on the charging setting interface of the multimedia system to set the low battery notification.

The setting range is 15%-40%, and the setting interval is 5%.

When the power is lower than the low battery warning value set by the user, the low-charge state warning lamp  on the instrument will be illuminated and the instrument will display "The power battery is low, please enable the "ECO" mode and charge it in a timely manner!".

1-2. Charging/discharging

Troubleshooting in charging/discharging

Symptom	Possible causes	Solution
Unable to start charging	The battery temperature is too high or too low, or the temperature difference is too large.	Determine whether the battery temperature is too high or too low, or whether the temperature difference is too large through the prompt text on the instrument cluster. If the corresponding prompt text appears on the instrument cluster, do not start charging. The charging can be started after the battery temperature becomes normal.
	The power battery is sufficiently charged or the current battery level is higher than the charge limit.	The charging cannot be started when the power battery is fully charged. The charging cannot be started when the current battery level is higher than the charge limit.
	The 12 V battery is at low level.	When the 12 V battery level is low, the vehicle control system cannot be started. In this case, please contact the authorized FAW Hongqi dealer.
	Vehicle fault	When the vehicle fails, the charging cannot be activated. In this case, check whether the MIL on the instrument cluster is illuminated. If illuminated, please stop charging immediately and contact the authorized FAW Hongqi dealer.
Unable to start AC charging	The vehicle plug is not connected reliably.	Ensure that the charging plug is reliably connected to the vehicle socket. Ensure that the charging connection indicator on the instrument cluster is illuminated.
	The AC charging device is not powered	Ensure the AC charging device is powered. Make sure to start charging in accordance with the instructions of the AC charging device. (Refer to the instructions of AC charging equipment)
	The power socket is not powered	Ensure that the power socket is powered. Confirm the power supply indicator status of the control box.
	The charging plug is not reliably connected to the power socket.	Make sure that the charging plug is reliably connected to the power socket. (Use household or industrial electrical socket (230V) for charging)
	The charging mode is timed charging mode.	Make sure that the charging mode is immediate charging mode.
Unable to start DC charging	The vehicle plug is not connected reliably.	Ensure that the charging plug is reliably connected to the vehicle socket. Ensure that the charging connection indicator on the instrument cluster is illuminated.
	The charging parameters of the DC charging equipment does not match those of the vehicle.	If the instrument cluster prompts that the DC charging device does not match the vehicle, please replace the DC charging device with other DC charging pile for charging.
	The DC charging device is not powered	Confirm the DC charging equipment is powered. Make sure to start charging according to the instructions of the DC charging equipment. (Refer to the instructions of DC charging equipment)

1-2. Charging/discharging

Symptom	Possible causes	Solution
Charging stops during AC charging	The AC power supply equipment stops power output.	If the power supply of the power supply device is interrupted, the charging will stop. When the power supply equipment restores power, the charging must be restarted.
	The power socket stops power output	If the power supply of the power socket is interrupted, the charging will stop. When the power socket is re-powered, the vehicle can automatically resume AC charging.
	The charging cable is disconnected	Make sure that the charging cable is reliably connected.
	At the end of charging time	In timed charging mode, if the charging end time is reached, the charging will stop.
	Vehicle fault	When the vehicle fails, the charging will be interrupted. Check whether the MIL on the instrument cluster is illuminated. If illuminated, please stop charging immediately and contact the authorized FAW Hongqi dealer.
Charging stops during DC charging	Communication fault between DC charging equipment and vehicle	If the instrument cluster prompts that there is a communication fault between the DC charging device and the vehicle, please reconnect the charging plug and start charging again. If the communication fault occurs repeatedly, please replace the DC charging device with other charging pile for charging.
	The AC charging connection device and the DC charging connection device are connected simultaneously	When the AC charging connection device and the DC charging connection device are connected simultaneously, the charging may stop.
	Vehicle fault	When the vehicle fails, the charging will be interrupted. Check whether the MIL on the instrument cluster is illuminated. If illuminated, please stop charging immediately and contact the authorized FAW Hongqi dealer.

1-3. Immobilizer system

Shutdown system

To prevent the vehicle from being stolen, this vehicle is equipped with a smart key. The smart key has a built-in password chip. If the key is not pre-registered in the anti-theft system, then the key will not start the power system. Different vehicles have different information registered in the key.

Do not leave the key in the vehicle when you leave it.

This system helps to prevent vehicle theft, but it cannot prevent all thefts and cannot guarantee the absolute security of the vehicle.

Carry the registered key, press the power (ignition) switch or depress the brake pedal to release the anti-theft system.

■ Conditions that may cause system failure

- The key is strongly impacted
- Water enters the key
- The key is placed in a place (e.g., instrument panel exposed to the sun) with high temperature
- The key is with a magnetic key chain
- Cleaning the key with an ultrasonic cleaner
- The key is approaching or in contact with other vehicles' keys (with built-in transponder chips)

■ If the vehicle cannot be started correctly, it may indicate that the shutdown system is faulty. In this case, please contact the authorized FAW Hongqi dealer to inspect the vehicle.



Notice

■ To ensure the system is working properly

Do not modify or remove the shutdown system. If the system is modified or disassembled without permission, the system will not be guaranteed to work properly.

1-3. Immobilizer system

Body immobilizer system

The body immobilizer system monitors the status of the four doors, the hatch and the trunk lid, and when the system detects forced entry, it sounds an alarm and causes the turn signal lamps to flash continuously.

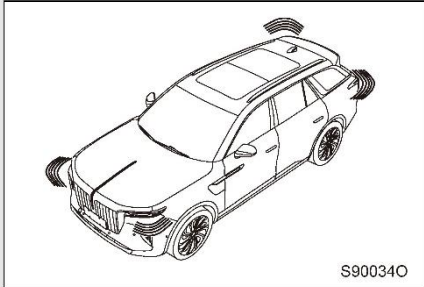

The body immobilizer system works.

After all occupants get out of the car, close the doors, trunk lid and hatch and lock all doors.

To deactivate or stop the alarm

Perform any of the following actions:

- Unlock the doors or trunk lid remotely through Smart Unlock, Remote Unlock or Hongqi Zhilian APP.
- Start the power system.

■ Items to be checked before locking the vehicle

To prevent accidental triggering of the alarm, make sure that the vehicle is unoccupied, free of any valuables and other personal items, and that all windows and sunroofs are closed before locking the vehicle.

■ When the 12 V battery is disconnected

Be sure to deactivate the alarm system.

If the battery is disconnected before deactivating the alarm, the alarm may be triggered after it is reconnected.



Notice

■ To ensure the system is working properly

Do not modify or remove the anti-theft system. If the system is modified or disassembled without permission, the system will not be guaranteed to work properly.

2. Instrument cluster

Instrument cluster	66
Alarm lamp	68
Indicator	70
Instrument cluster multi-function display information	72

2. Instrument cluster

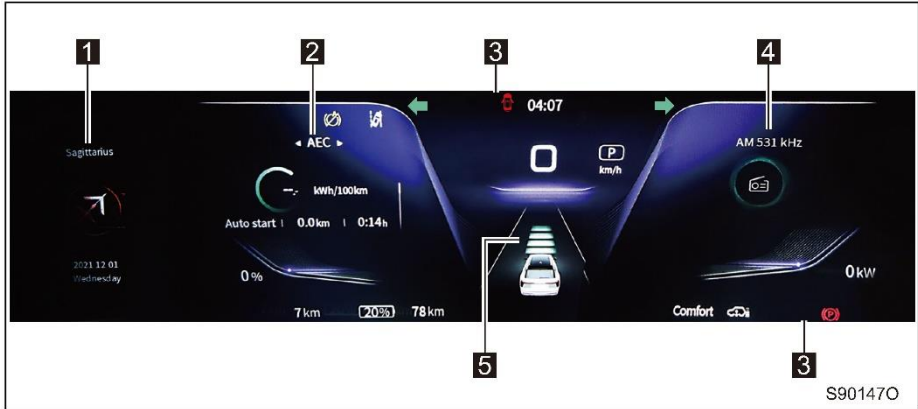

The exact display will vary depending on the model configuration.

- 1** Instrument extension area
12 constellation information or the Hongqi logo is displayed.
- 2** Driving information display area
This area displays the average energy consumption, tire pressure monitoring, acceleration information, fault query, driving mode, backlight brightness and exterior rearview mirror settings, etc.
- 3** Alert/alarm icon display zone
Displays information such as vehicle indicator and alarm lamp.
- 4** Media information display area
This area displays the music, radio, telephone etc. in the multimedia system.
- 5** Comprehensive information display area
This area displays the gear, vehicle speed, driving assistance information, date, and various alarm/reminder information, etc.

Interior backlight brightness adjustment

The interior backlight brightness can be adjusted in the driving information display area of the instrument cluster. (Refer to P.76)



WARNING

■ When adjusting brightness

For the sake of the safety, adjust the brightness of the backlight when the vehicle is parked. Distracted driving shall not occur, or the driving safety shall not be affected because of the use of this function. Ignoring road and traffic conditions can lead to accidents.

1-3. Immobilizer system

Alarm lamp

Alarm lamps indicate the current status or the current possible malfunction of the vehicle systems. (Refer to P.347)



Low charge state warning lamp



Power battery system MIL



12 V battery charging MIL



Bulb MIL



SRS fault alarm lamp



Unbuckled seat belt alarm lamp



Electronic shift system MIL



Electronic parking (Epark) lock warning lamp



PEPS MIL



Immobilizer system MIL



Low key battery warning lamp



Power system MIL



Electronic wiper system MIL



Low washer fluid level warning lamp



Brake fluid level too low/system MIL



Brake degradation warning lamp



EPS fault alarm lamp



EPS MIL



ABS alarm lamp



Brake lining excessive wear warning lamp



EPB alarm lamp



AUTO HOLD system MIL



HDC fault alarm lamp



Wireless charging fault alarm lamp



APA fault alarm lamp



Tire pressure abnormality/system fault alarm lamp



Automatic running lamp/automatic wiper MIL



Driving mode selection system fault alarm lamp



Air suspension (AirS) system MIL



SOS MIL



Coolant level too low warning lamp



Motor system MIL



Water heater PTC MIL



Power battery thermal runaway signal missing warning lamp



Headlamp leveling system MIL



Driving assistance system (DAS) MIL



AirS system MIL



Vehicle overload warning lamp



High coolant temperature alarm lamp



Thermal management system MIL



High-voltage system MIL

Notice:

If any of the lamps do not come on or go off, the corresponding system may have a fault. Please contact the authorized FAW Hongqi dealer to carefully check the vehicle.

1-3. Immobilizer system

Indicators indicate the current operating status of the vehicle systems.



Left turn indicator



Right turn indicator



High beam ON indicator



Position lamp ON indicator



“READY” indicator



Rear fog lamp ON indicator



ESC working indicator



ESC OFF indicator



AirS height indicator



AirS lift mode indicator



Service indicator



Door opening indicator



ADB working indicator



ADB system ON indicator



Intelligent speed limit indicator



APA working indicator



EPB working indicator



AUTO HOLD working indicator



FCW system OFF indicator



AEB OFF indicator



LDW/LKA system ON indicator



LDW/LKA system working indicator



ACC system ON indicator



ACC working indicator



SACC system steering assist ON indicator



SACC system steering assist working indicator



HDC working indicator



Unrecognized key indicator



Extreme mode indicator



All-terrain mode indicator



Sport mode indicator



Comfort mode indicator



Off-road mode indicator



Custom mode indicator



Long battery life (LBL) mode indicator



Charging connection indicator



Scheduled charging indicator



Unable to switch driving mode indicator

Instrument cluster multi-function display information

The driver can view various driving-related information, the multimedia navigation information, etc. through the driving information display area, media information display area, and comprehensive information display area on the instrument cluster.

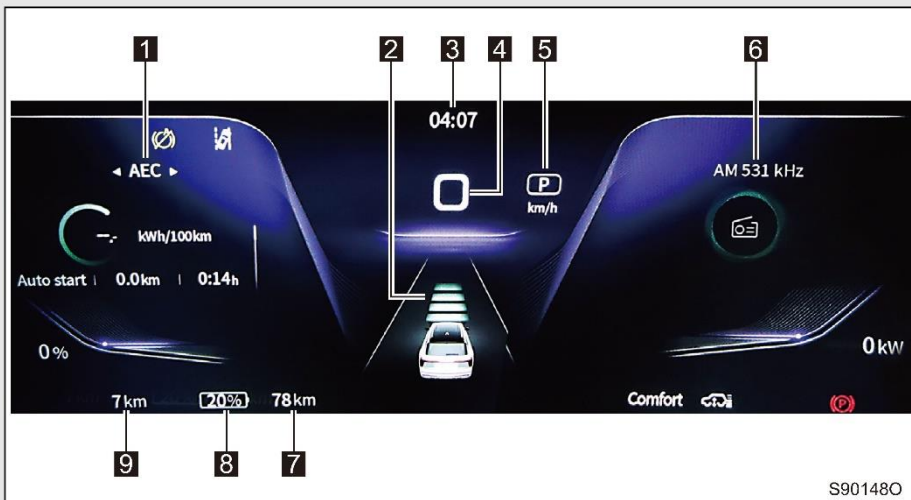

S901480

- 1** Driving information display area
- 2** Comprehensive information display area
- 3** Time display area
Displays the clock information
- 4** Speed display area
It indicates the current vehicle speed.
- 5** Gear display zone
Displays the current gear position of the vehicle.
- 6** Media information display area
- 7** Driving range display area
It displays the range the vehicle can drive with the current capacity of the battery.
- 8** Charging information display area
It displays the current battery capacity or the charging information.
- 9** Total mileage display zone
Displays the total mileage information.

Steering wheel buttons

■ Button on the left side of the steering wheel

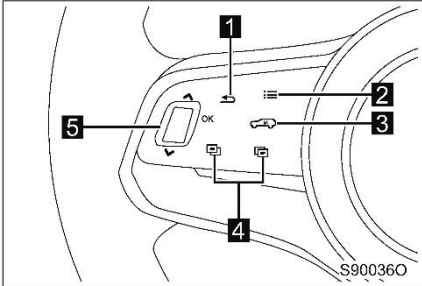

- 1** Back button
- 2** Menu button
- 3** Driving mode selection button
- 4** Left/right buttons
- 5** Scroll wheel

S/N	Function
1	Press and release: Return to the previous interface.
2	Press and release: Enter/exit the setting interface of backlight brightness and exterior rearview mirror. Press and hold: Restart the multimedia system.
3	Press and release: Enter the driving mode selection interface.
4	Press and release: Switch among average energy consumption, tire pressure monitoring, acceleration information, and fault query.
5	Scroll: Switch selection items. Press and release: Confirm the selection.

■ Button on the right side of the steering wheel

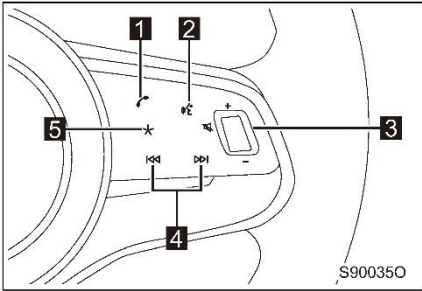

- 1** Phone button
- 2** Voice recognition button
- 3** Scroll wheel
- 4** Track/station switching button
- 5** Not in use

S/N	Function
1	Press and release: When there is an incoming call: Answer the current call. When you are answering the call/calling: Hang up the current call. When there is no incoming call: Display the last call information, and then press to dial out. Press and hold: When there is an incoming call: Hang up the current call. In case of no incoming call: the last call number will be dialed out automatically.
2	Press and release: Trigger/exit the voice recognition function.
3	Scroll: Increase/decrease the volume; if in muted state, unmute. Press and release: Mute/unmute.
4	Press and release: Previous track (station)/next track (station).
5	Not in use

WARNING

■ **During driving**

Be extremely careful when operating the steering wheel buttons to prevent accidents.

Driving information display area

The setting functions of average energy consumption, tire pressure monitoring, acceleration information, fault query, driving mode switching, backlight brightness and exterior rearview mirrors can be operated through the buttons on the left side of the steering wheel.



Press and release the left/right selection buttons to switch between average energy consumption, tire pressure monitoring, acceleration information, and fault query; press and release the driving mode selection button to enter the driving mode selection interface; press and release the menu button to enter the settings interface of backlight brightness and exterior rearview mirrors.

■ Average energy consumption

The self-starting, self-charging, and self-resetting can be switched through the scroll wheel on the steering wheel.

● Self-starting



It displays the average energy consumption/mileage/running time of the vehicle after start.

● Self-charging



It displays the average energy consumption/mileage/running time of the vehicle after self-charging.

1-3. Immobilizer system

● Self-resetting



It displays the average energy consumption/mileage/running time of the vehicle after resetting.

Press and hold the scroll wheel on the steering wheel to reset the average energy consumption/mileage/running time.

■ Tire pressure monitoring



When the tire pressure is abnormal, the abnormal tire pressure will be displayed in yellow; other normal tire pressures will be displayed in green.

When the tire pressure sensor fails, the corresponding tire pressure will be displayed as "----", and other tire pressures will be displayed normally.

■ Acceleration information

The 0-100 km/h acceleration information and the acceleration direction information can be switched through the scroll wheel on the steering wheel.

● 0-100 km/h acceleration information



It displays the current 0-100 km/h acceleration information of the vehicle.

- Acceleration direction information



It displays the acceleration information of the vehicle in all directions.

- Fault query

If any alarm information occurs in the vehicle, it will appear in the form of a popup window. In addition, all current alarm information can also be viewed in the fault query interface.



The current alarm information can be switched up and down through the scroll wheel on the steering wheel.

- Driving mode



Press and release the driving mode selection button on the steering wheel to enter the driving mode selection interface.

Select the corresponding driving mode through the scroll wheel on the steering wheel; press and release the scroll wheel to confirm the selection.

Press and hold the scroll wheels on the left and right sides of the steering wheel to quickly enter the extreme driving mode.

■ Settings of backlight brightness and exterior rearview mirrors



Press and release the menu button on the steering wheel to enter the setting interface for backlight brightness and exterior rearview mirrors.

You can set the backlight brightness and exterior rearview mirrors (folding/unfolding, and angle) through the scroll wheel on the steering wheel and the left/right selection buttons.

Media information display area

The radio, music and other multimedia information as well as the telephone can be operated through the buttons on the right side of the steering wheel.

■ Multimedia information



Press and release the multi-function button to switch among radio, music, etc.; press and release the track/station switching button to switch tracks/stations.

■ Phone

After the phone is connected to Bluetooth, the call information can be displayed in the media information display area.

● Make a call



Press and release the phone button on the steering wheel to display the last number called; press and release this button again to dial the number; press and hold the phone button on the steering wheel to directly dial the last number called.

● Answer



When there is an incoming call, press and release the phone button on the steering wheel to answer the phone.

● Hang up the phone



When there is an incoming call, press and hold the phone button on the steering wheel to hang up; during a call, press and release the phone button on the steering wheel to hang up.

Comprehensive information display

In the comprehensive information display area, the driving assistance information and alarm/prompt information can be overlapped and displayed.

■ Alarm/prompt message

If any alarm/prompt information occurs in the vehicle, it will appear in the form of a popup window. In addition, all current alarm information can also be viewed in the fault query interface.

■ Driving assistance information

When the driving assistance system is activated, the driving assistance information will be displayed in the multi-function display area. In this interface, the status and alarm of the driving assistance system can be inquired.

3

3-1. Key information	
Key	80
3-2. Opening, closing and locking the doors and trunk lid	
Door	83
Trunk lid	87
Passive entry and passive start (PEPS) system.....	91
3-3. Adjusting the seat	
Front seat	96
Rear seat.....	99
Headrest.....	102
Seat memory	104
3-4. Adjusting the steering wheel and rearview mirrors	
Steering wheel	106
Anti-glare rearview mirror	108
Exterior rearview mirror.....	109
3-5. Opening and closing windows	
Power window	112
Panoramic sunroof	114

3-1. Key information

Key

Key

The vehicle is attached with the following keys.

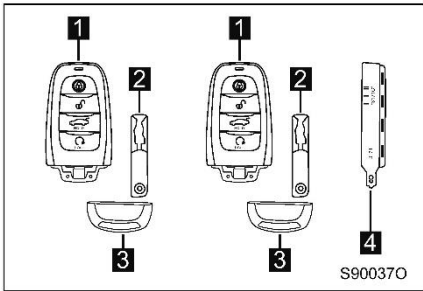

1 Smart key

- Operating the PEPS system (See P.91)
- Operating the wireless remote-control function

2 Mechanical key

3 Key end cap

4 Key number tag

Wireless remote control

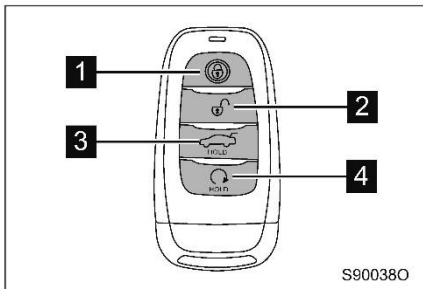

- 1 Press and release this button to lock the door; press and hold this button to close all windows and the sunroof *1
When the complete vehicle is locked, press this button twice in succession, then the vehicle search function will be triggered, the turn signal lamp will flash 3 times and the horn will buzz 3 times.
- 2 Press and release this button to unlock the door; press and hold this button to open all windows and the sunroof *1
- 3 Press and hold to unlock and open the trunk lid.
- 4 Press and release for the car to signal with horn and lights

*1: Press and hold to trigger automatic window rising/lowering.

Using a mechanical key

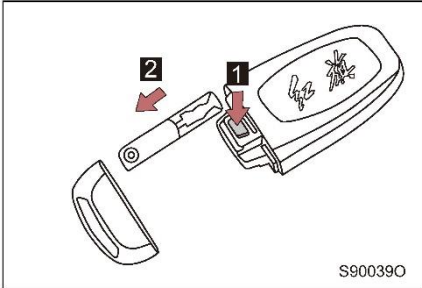

1 Press the unlock button to release the key end cap

2 Take out the mechanical key.

After using the mechanical key, store it in the smart key. Carry the mechanical key and the smart key together. If the battery of the smart key runs out and does not work properly, you need to use the mechanical key. (Refer to P.356)

■ When you need parking service

Always keep the mechanical key with you, and only give the smart key to the parking attendant.

■ When traveling by air

When carrying your smart key on an airplane, make sure you do not press any buttons on the smart key while in the cabin. If you put the key in the bag, make sure you do not accidentally press any button on the key, otherwise the key will emit radio waves, which may interfere with the flight of the aircraft.

■ Key battery power

- The standard battery life is 1 to 2 years.
- Even if the key is left idle, the battery power will be depleted. The following symptoms indicate that the key battery is low or may be depleted. If necessary, replace the battery. (Refer to P.329)
 - PEPS system or wireless remote-control function does not work.
 - The detection area becomes smaller.
 - The instrument cluster displays the message that the key battery power is low.
- To avoid serious degradation of the key performance, do not place it within 1 m of the following electrical equipment that can generate magnetic fields:
 - TV sets
 - Personal computers (PC)
 - Cell phones, cordless phones, and battery chargers
 - A mobile or cordless phone being charged
 - Table lamps
 - Induction cookers

■ Replacing the battery

(Refer to P.329)



Notice

■ To prevent key damage

- Do not subject the key to violent impact or to high temperatures (e.g. direct sunlight) and humidity.
- Do not wet the keys or clean them in an ultrasonic cleaner, etc.
- Do not immerse the key in water.
- Do not attach metal or magnetic substances to the key or place the key near such substances.
- Do not disassemble the smart key.
- Do not attach labels or other objects to the key surface.
- Do not place the key near objects that can generate magnetic fields, such as TVs, multimedia systems, induction cookers or electronic medical devices (e.g. low-frequency medical devices).

■ Carrying your smart key with you

Carry your key 10cm or more away from open electrical devices. Radio waves emitted from electrical equipment within 10cm from your key may interfere with the key and cause it not to work properly.

■ In the event of a malfunction in the PEPS system or other key-related malfunction

Please take the vehicle to an authorized FAW Hongqi dealer and bring all the keys that come with the vehicle.

■ When the key is lost

If the keys are lost, the risk of vehicle theft increases significantly. Immediately bring all other keys that come with the vehicle to an authorized FAW Hongqi dealer to be re-matched.

3-2. Opening, closing and locking the doors and trunk lid

Door

Unlocking and locking the doors from outside the vehicle

■ Passive entry

As long as you carry the smart key, you can unlock/lock the door through the passive entry function.

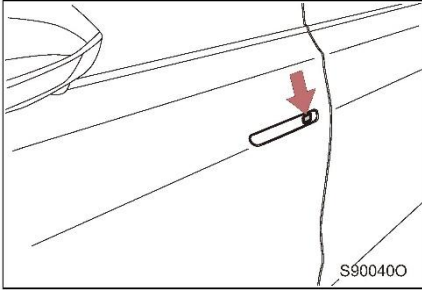

Turn off the power (ignition) switch and all doors and touch the door handle sensor switch to lock the doors.

If any door is not closed, only by touching the door handle sensor switch, the door will not be locked.

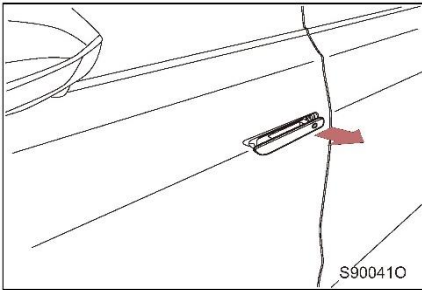

When the vehicle is locked, touch the door handle sensor switch to unlock the door and the door handle will pop out.

■ Wireless remote control

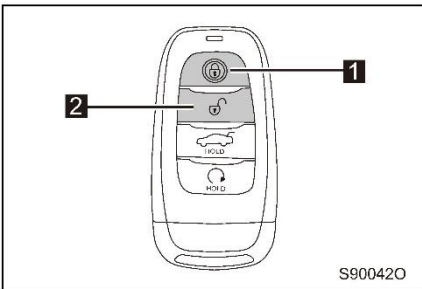

1 Lock all doors

2 Unlock the driver side door/all doors, and the unlock mode can be set. (Refer to P.223)

3-2. Opening, closing and locking the doors and trunk lid

■ Mechanical key

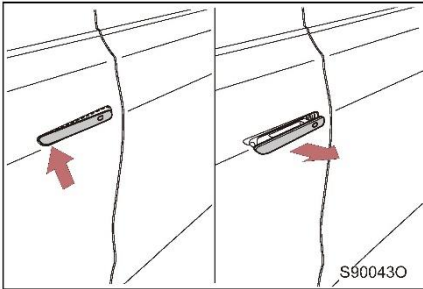

Press the front part of the driver side door handle to tilt it, then pull the middle part and pull it out vertically.

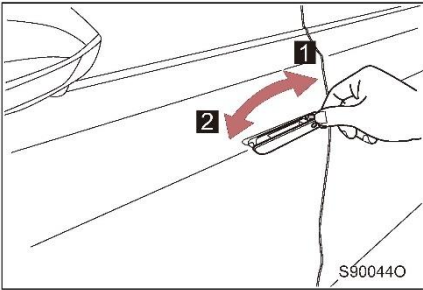

Hold the door handle, and lock and unlock the door with a mechanical key.

- 1** Unlocking the door
- 2** Locking the door

■ Operation signal

If all turn signal lamps flash, it indicates that the door is locked/unlocked. (Locked: flashes once; Unlocked: flashes twice)

■ The key battery runs out of power

If the key battery runs out of power, replace the battery with a new one. (Refer to P.329)

Unlocking and locking the doors from inside the vehicle

The door can be unlocked and locked by the central door lock switch on the driver side door.

■ Central control door lock switch

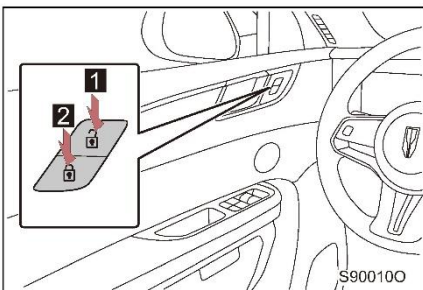

- 1** Unlocking all doors
- 2** Lock all doors

Note: When there is a door not closed, the central control door lock switch can only be used for unlocking, not for closing.

■ Interior door release handle

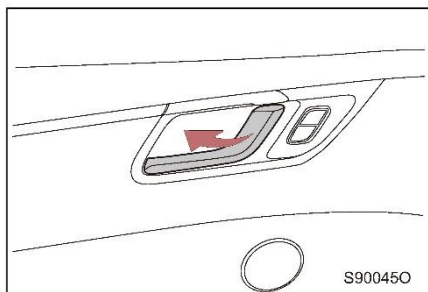

The door can be opened by pulling the interior door release handle.

After the door is locked, pull the interior door release handle once to unlock the door and pull it again to open the door.

Rear door child safety lock

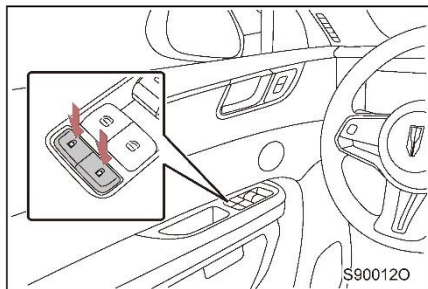

When the safety lock is set by pressing this switch, the rear door and window on the corresponding side cannot be operated from inside the vehicle.

The safety lock is used to prevent children from opening the rear door and operating the window from inside the vehicle.

■ Speed-dependent locking function

- When all doors are closed but not fully locked, the vehicle is running and the vehicle speed exceeds approximately 15km/h, the speed-dependent locking function is activated, and the doors are locked.

■ Hidden door handle

- When the vehicle is unlocked through the passive entry function or the central door lock switch, all door handles will eject.
- When the vehicle is unlocked by the remote key, the driver side door handle/all door handles will eject according to the set safety unlocking mode.
- When the vehicle is running at a speed approximately higher than 15 km/h, all door handles will retract.
- When the vehicle is locked through the passive entry function, remote key or central door lock switch, all door handles will retract.

■ Conditions affecting PEPS system or wireless remote-control operation

(Refer to P.93)



WARNING

■ To prevent accidents

The following precautions should be observed while driving.

Otherwise, the occupants in the vehicle may be thrown out of the vehicle due to the accidental opening of the door, which may result in serious injury or even death.

- Be sure to fasten your seat belt.
 - Make sure all doors are properly closed.
 - Be sure to lock all doors.
 - Do not pull the interior door release handle while driving.
Otherwise, it may cause the door to open and throw the occupants out of the vehicle, which may lead to serious injury or even death.
 - If there are children in the rear seats, be sure to set the rear door child safety locks.
 - When you leave your vehicle and no one is in it, keep your keys with you, close all windows and sunroofs and lock all doors to prevent entry or theft of your vehicle.
 - Do not leave children alone in the vehicle.
 - Do not allow children to carry or use the key. Children may start the vehicle or operate the shift lever, which may cause safety hazards.
 - Do not allow children to play with the windows or other equipment in the vehicle, as this may injure them.
 - Make sure that the temperature in the car is appropriate. If the temperature is too high or too low, it will cause fatal injury to children.
 - Always make sure the area around the vehicle is clear before opening the door.
Opening the door suddenly is very dangerous and may cause an accident by hitting a passing vehicle or pedestrian.
 - After closing the door, always make sure it is closed tightly.
It is dangerous to leave the door open. If you drive the vehicle with the door open, the door may open accidentally and cause an accident.
- #### ■ When using hidden door handle
- Be careful not to get caught by the door handle or damage the door handle.
 - When the door handle ejects, make sure that there is no foreign matter around it to prevent damage.
 - When driving in winter, remove the ice or snow from the door handle, and then unlock or lock the door, otherwise the door handle may not work properly.

3-2. Opening, closing and locking the doors and trunk lid

Trunk lid

The trunk lid can be opened by using the trunk lid opening button, passive entry function or wireless remote control.

Opening the trunk lid

- Opening the trunk lid from inside the car



When the vehicle is stationary and the trunk lid is closed, press the internal opening button of the trunk lid to unlock and open the trunk lid.

- Open the trunk lid from outside the vehicle

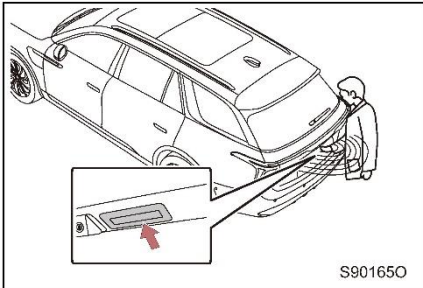

When the vehicle is locked, if you carry the smart key, you can press the external opening button of the trunk lid to unlock and open the trunk lid; when the vehicle is unlocked, press the external opening button of the trunk lid to unlock and open the trunk lid.

- Wireless remote control

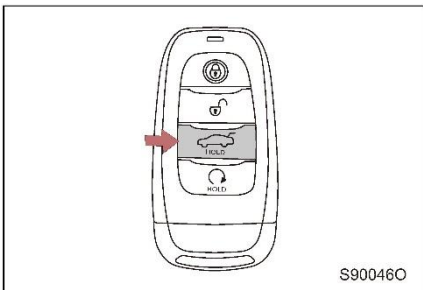

When the trunk lid is closed, press, and hold this button to unlock and open the trunk lid.

Closing the trunk lid

■ Trunk lid switch*

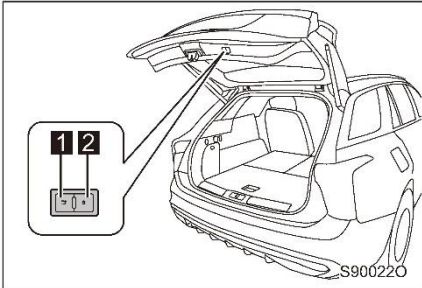

1 Trunk lid closing button

Press the trunk lid closing button, then the trunk lid will automatically close.

2 One-key lock button

When the power (ignition) switch is turned to OFF, all the doors will be closed; carry the smart key and ensure that no other recognizable smart key is in the vehicle, press the one-click lock button, the trunk lid will automatically close, and the vehicle will lock after a few seconds.

■ Trunk lid inside open button



When the vehicle is stationary and the trunk lid is open, press and hold the internal opening button of the trunk lid until the trunk lid is closed.

■ Wireless remote control

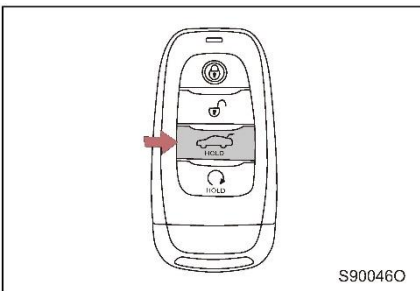

When the trunk lid is open, press and hold the button until the trunk lid is closed.

■ Trunk lamp

The trunk light illuminates when the trunk lid is opened.

■ When the trunk lid is opening, press and release the internal opening button of the trunk lid to briefly stop the opening, and press and release the button again to continue opening the trunk lid.

■ Trunk lid position memory

Open the trunk lid, adjust the trunk lid to an appropriate angle (which shall be more than half of the maximum opening angle), press and hold the trunk lid closing button for more than 3 s, then all turn signal lamps will flash once, and the current position memory is the trunk opening position.

■ Key missing reminder

When the power (ignition) switch is turned to OFF and the vehicle is locked, if you want to open and close the trunk lid separately outside the vehicle, but the smart key is left in the vehicle at this time, the key missing reminder will be triggered (the trunk lid automatically opens).



WARNING

■ When opening and closing the trunk lid, operate carefully to avoid being caught by the trunk lid.

■ Before driving

- Make sure the trunk lid is completely closed. If the trunk lid is not fully closed, it may open accidentally and hit nearby objects during driving, or the luggage inside the trunk may be thrown out accidentally, thus causing an accident.
- Do not allow children to play in the trunk. Accidentally locking a child in a trunk may result in heat stroke, suffocation, or other injury.
- Do not allow children to open or close the trunk lid. Failure to do so may cause the trunk lid to open accidentally or cause the trunk lid being closed to catch the child's hand, head, or neck.

■ Precautions during driving

Be sure to keep the trunk lid closed to prevent items in the trunk from being thrown out.

■ When children are in or around the car

Do not allow children to play in and around unsupervised vehicles, especially when the trunk lid is open and children may enter and become trapped in the trunk, which could result in serious injury or death if the temperature inside the vehicle is too high or too low.

■ Points to remember when driving

Do not allow anyone to sit in the trunk. Otherwise, it is easy to cause serious injury or even death in case of emergency braking or collision.

■ Anti-pinch function *

Do not try to activate the anti-pinch function by intentionally jamming any part of your body.



WARNING

■ Using the trunk

Please observe the following precautions, otherwise it may pinch a part of the body and cause serious injury.

- Before opening the trunk lid, you should remove the heavy load on the trunk lid, such as snow and ice accumulation. Otherwise, the trunk lid may suddenly close again after opening.
- When opening or closing the trunk lid, check thoroughly to ensure that the surrounding area is clear.
- If there are people nearby, ensure their safety and inform them that the trunk lid is about to be opened or closed.
- Care should be taken when opening or closing the trunk lid in windy weather, as the trunk lid may move suddenly in strong winds.
- Do not install any accessories on the trunk lid. Otherwise, the extra weight on the trunk lid may cause the trunk lid to suddenly close again after opening.



- It is much more difficult to open or close the trunk lid on a ramp than on a level road, so be careful that the trunk lid may accidentally close during opening or open during closing. Before using the trunk, make sure the trunk lid is fully opened and secured.



- When closing the trunk lid, special care should be taken to avoid pinching fingers and other parts.

3-2. Opening, closing and locking the doors and trunk lid Passive entry and passive start (PEPS) system

Simply carry your smart key with you, for example in your coat pocket, to perform the following operations. (The driver must always carry the key)

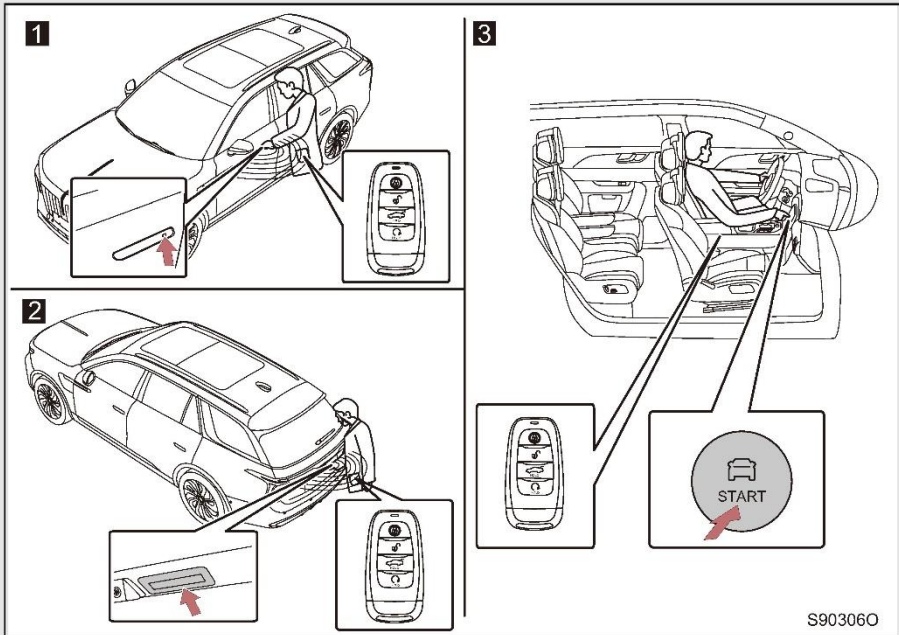

S903060

- 1** Locking and unlocking the doors. (Refer to P.83)
- 2** Lock and unlock the trunk lid. (Refer to P.87)
- 3** Start the vehicle. (Refer to P.125)

3-2. Opening, closing and locking the doors and trunk lid

■ Effective range (area where the key can be detected)

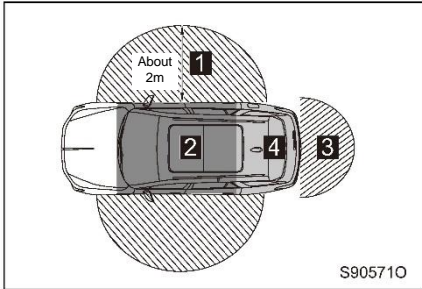

Effective range of the key sensing antenna: hemispherical area centered on the sensing antenna.

- 1** When locking or unlocking the doors
The key can lock or unlock the doors when it is in the sensing area outside the car.
- 2** When starting the power system or switching the power (ignition) switch mode
If the key is in the interior sensing area of the vehicle, you can start the power system or switch the power (ignition) switch mode.
- 3** When unlocking the trunk
If the key is in the external sensing area of the trunk, when relevant conditions are met, the trunk can be unlocked.
- 4** When the key is left in the trunk
If the trunk lid is closed when the key is in the internal sensing area of the trunk, when relevant conditions are met, the key missing reminder function will be activated. (Refer to P.89)

■ Alarm and prompt function

The system alarm and prompt functions can be realized through the instrument cluster, alarm speaker, hazard warning lamp, power (ignition) switch status indicator.

- When any of the alarm lamps are on
Take the appropriate action according to the lit alarm lamp. (Refer to P.347)
- When alarm messages are displayed
Take corresponding measures according to the alarm information displayed on the instrument cluster.

■ Circumstances affecting operation

The Passive Entry & Passive Start (PEPS) system uses weak radio waves. In the following cases, the communication between the key and the vehicle may be affected, so that the PEPS system and the wireless remote-control function do not work properly.

- When the key battery power is insufficient.
- When the key battery power is run out.
- When close to TV towers, power plants, gas stations, radio stations, large displays, airports, or other facilities that generate strong radio waves or electrical noise interference.
- When carrying portable radios, cell phones, cordless phones, or other wireless communication devices.
- When the key comes into contact with or is covered by a metal object.
- When multiple smart keys are in the vicinity of the vehicle at the same time.
- When carrying or using the key with the following devices that emit radio waves.
 - Smart keys for other vehicles
 - Wireless remote keys that emit radio waves
 - Personal computers (PC)
 - Mobile phone
- When the rear windshield has metallic composition sunscreen film or metallic substances adhered to it.
- When the following metal objects touch or cover the key.
 - Cards with aluminum foil
 - Cigarette cases with aluminum foil on the inside
 - Metal wallets or bags
 - Coins
 - Metal hand warmers
 - Media such as CDs and DVDs
- When the key is near a battery charger or an electronic device.

3-2. Opening, closing and locking the doors and trunk lid

■ Operating the system correctly

- Remember to carry the key with you when operating the system. Never bring the key too close to the vehicle when operating the system outside the vehicle.
- Depending on the specific location and grip method of the key, the key signal may not be detected, resulting in abnormal operation of the system.

■ Security features

- During remote unlocking or smart unlocking, if the door or the trunk lid is not opened, the vehicle will be automatically locked after a period.

■ When parking for a long time

- To prevent vehicle theft, do not place the key too close to the vehicle.
- When the vehicle is parked for a long time, the vehicle must be locked. Otherwise, the battery power may be depleted.

■ If the PEPS system does not work properly

- Locking and unlocking the doors: use the mechanical key. (Refer to P.356)
- Start the power system. (Refer to P.357)

■ Notes on PEPS

- In the following cases, the system may not work properly even if the key is within the effective range of action (sensing area).
 - When locking or unlocking the door, the key is too close to the window or the outer handle of the door, too close to or too high from the ground.
- If the smart key is within the effective range, anyone can lock or unlock the car door, please keep the key properly.
- If there is a lot of water splashed on the door handle (such as when washing the car or in heavy rain), the smart entry may fail.
- It may not be possible to lock the doors in the following cases.
 - When the smart key is still in the vehicle, the door can be locked via the smart locking function.
 - When any of the doors are not fully closed.



ADVARSEL

- In the following cases, the PEPS system is disabled:
 - During and after charging the propulsion battery
 - During and after preheating the passenger compartment
 - When ECO driving mode is activated
 - If you first open and close the tailgate
 - When the car is in "sleep mode" for more than 7 days



WARNING

- **Precautions related to electronic equipment interference**

Persons using implantable pacemakers, cardiac resynchronization therapy pacemakers or implantable cardioverter-defibrillators should keep an appropriate distance from the antenna of the PEPS system.

 - Radio waves may affect the normal operation of such equipment. For more information about radio wave frequency and radio wave transmission time, please consult an authorized FAW Hongqi dealer. Then, check with your doctor to see if it works properly.
 - For those not using an implantable pacemaker, cardiac resynchronization therapy pacemaker or implantable cardioverter-defibrillator, but using other electronic medical devices, the device manufacturer should be consulted about the effect of radio waves on the operation of the device.
 - Radio waves may have unpredictable effects on the use of such medical devices.
 - For details of the PEPS function, please consult an authorized FAW Hongqi dealer.

Auto lock

You can deactivate or activate the Automatic Locking function in the car's main menu under: Vehicle -> Comfort -> Automatic Locking.

■ How to use Auto lock function:

- Activate Auto locking in the car's main menu.
- Keep the key in your pocket.
- Ensure all doors, tailgate, hood and charging port are properly closed.
- The distance from the car must be more than 3 meters.
- When the doors lock, the exterior lights will blink once.



WARNING

- It is ultimately your responsibility to ensure that the car is always locked, even when **Auto lock** is activated.
- **If you leave the car while it is running with the key in your pocket, the car will shut off and the doors will lock. Make sure no children or pets are in the car when you leave with the key in your pocket.**



WARNING

- Automatic locking is deactivated in the following cases:
 - When ECO driving mode is activated.
 - During and after charging the propulsion battery.
 - During and after preheating the cabin.
 - When the car has been in sleep mode for more than 7 days.

3-3. Adjusting the seat

Front seat

Adjustment steps

► Driver seat

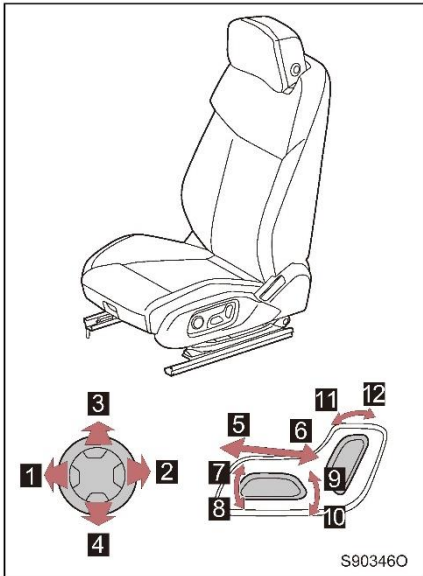

- 1** Lumbar support projection
- 2** Lumbar support concave
- 3** Lumbar support moves upward
- 4** Lumbar support moves downward
- 5** Seat forward
- 6** Seat backward
- 7** Seat front rise
- 8** Seat front drop
- 9** Seat rise
- 10** Seat drop
- 11** Seat backrest tilts forward
- 12** Backrest tilted

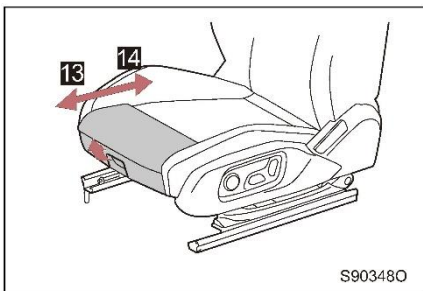

- 13** Increase seat cushion depth
- 14** Decrease seat cushion depth

After pulling the adjustment handle, you can manually adjust the depth of the seat cushion.

► Front passenger seat

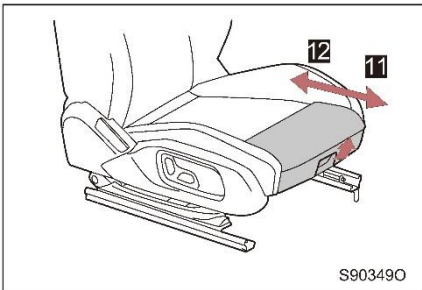
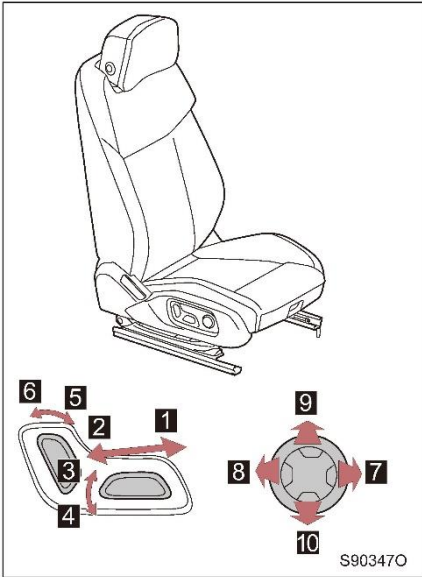

- 1** Seat forward
- 2** Seat backward
- 3** Seat rise
- 4** Seat drop
- 5** Seat backrest tilts forward
- 6** Backrest tilted
- 7** Lumbar support projection
- 8** Lumbar support concave
- 9** Lumbar support moves upward
- 10** Lumbar support moves downward

- 11** Increase seat cushion depth
- 12** Decrease seat cushion depth

After pulling the adjustment handle, you can manually adjust the depth of the seat cushion.



WARNING

■ **Seat adjustment**

- Do not over-tilt the seat while the vehicle is in motion to avoid the body slipping out of the waist belt. If the seat is overly tilted, the waist belt may slide over the hip and directly strangle the abdomen or make the shoulder belt touch the neck, which will increase the possibility of serious injury or even death in case of accident.
- Do not put your hands under the seat or near moving parts, otherwise the seat mechanism may pinch your hands.
- Care should be taken when adjusting the seat position to ensure that other occupants are not injured when the seat is moved.
- Do not allow children to adjust the seat. It is very dangerous to allow children to adjust their seats. If a child's hand or foot is caught, serious injury may result.
- Always Park the vehicle first and then adjust the driver seat. It is very dangerous to adjust the driver seat while the vehicle is in motion. The driver may lose control of the vehicle and thus cause an accident.

■ **Seat modification**

- Modifying or replacing the front seats may damage the airbag components in the seats, and the airbags will not deploy properly in the event of a collision.
- If you need to remove or replace the seats, please contact an authorized FAW Hongqi dealer.

■ **When the seat is damaged**

- If the seat has been damaged, it is very dangerous to drive the vehicle at this time.
- After a collision, the seat may be damaged even if the seat airbag does not deploy. Therefore, after a collision, please contact an authorized FAW Hongqi dealer to check the seats, seat belt pretensioners and airbags.

3-3. Adjusting the seat Rear seat

Second-row seat adjustment

► Second-row seat adjustment (Type 1)

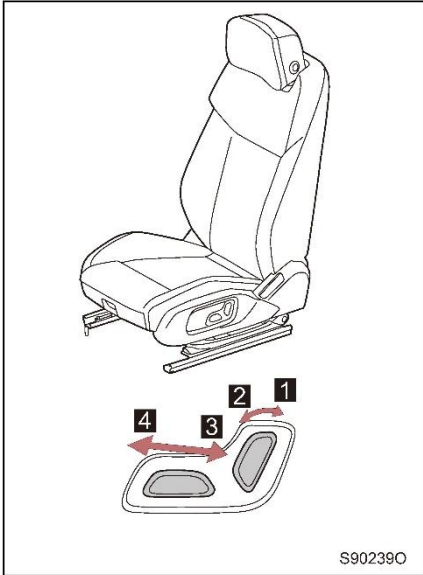

- 1 Backrest tilted
- 2 Seat backrest tilts forward
- 3 Move seat backward
- 4 Move seat forward

3-3. Adjusting the seat

► Second-row seat adjustment (Type II)

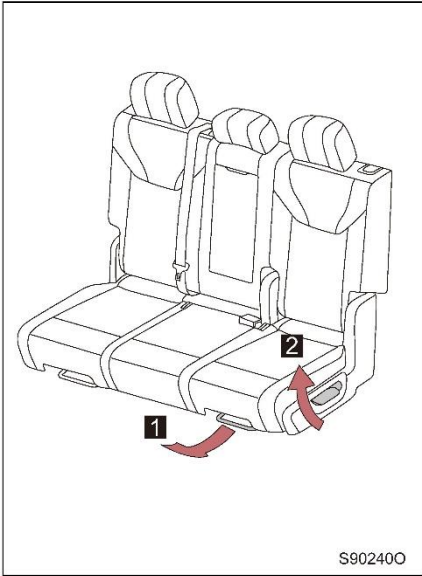

- 1 Seat front and rear position adjustment
- 2 Seat backrest inclination adjustment

S902400

Third-row seat adjustment

The third-row seat adjustment switch is located on the left trim plate of the trunk.

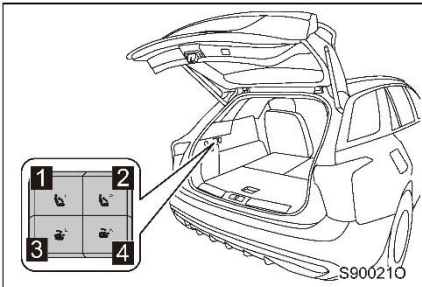

- 1 Left seat backrest unfolds
- 2 Right seat backrest unfolds
- 3 Left seat backrest folds
- 4 Right seat backrest folds

S900210

■ **Move the second-row seats away to access the third-row seats***

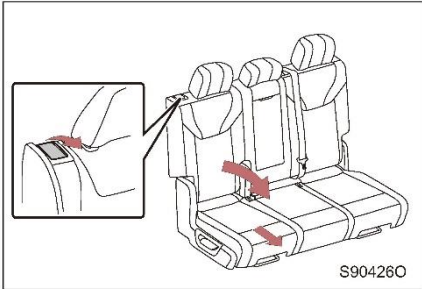

For seven-seat models, if you want to access the third-row seat, you need to pull the shoulder adjustment handle of the second-row right seat, fold the backrest to the 45° position and move the right seat forward.

WARNING

■ **Seat adjustment**

- Do not put your hands under the seat or near moving parts, otherwise the seat mechanism may pinch your hands.
- Care should be taken when adjusting the seat position to ensure that other occupants are not injured when the seat is moved.
- Do not allow children to adjust the seat. It is very dangerous to allow children to adjust their seats. If a child's hand or foot is caught, serious injury may result.

■ **Seat modification**

- Modifying or replacing the second-row seats may damage the airbag components in the seats, and the airbags will not deploy properly in the event of a collision.
- If you need to remove or replace the seats, please contact an authorized FAW Hongqi dealer.

■ **When the seat is damaged**

- If the seat has been damaged, it is very dangerous to drive the vehicle at this time.
- After a collision, the seat may be damaged even if the seat airbag does not deploy. Therefore, after a collision, please contact the authorized FAW Hongqi dealer to check the seats and airbags.

3-3. Adjusting the seat Headrest

► Manual adjustment (first-row seat headrest/second-row seat headrest)

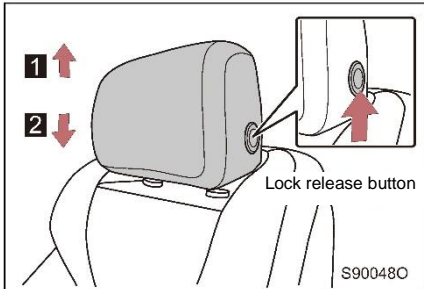

1 Up

2 Down

Push down the headrest while holding the lock release button

■ Adjusting the headrest height

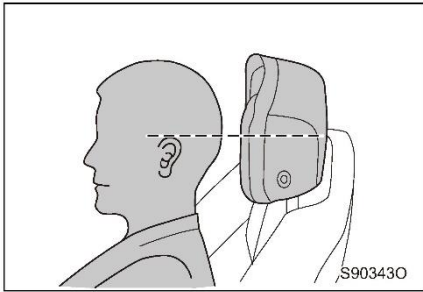

When adjusting the headrest, ensure that its center is flush with the upper part of the ears.

■ Sleeping headrest*

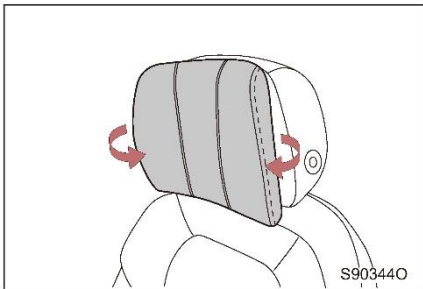

You can unfold the two wings of the headrest inward to a comfortable position.

**WARNING****■ Precautions for headrest**

Please observe the following precautions regarding headrests, otherwise it may lead to serious injury or even death.

- Please use the headrest specially designed for each seat.
- Be sure to adjust the headrest to a suitable position for use.
- Do not drive the vehicle with the headrest removed. Whenever you drive the vehicle, you should install the headrest and adjust it to the right position. Driving with the headrest positioned too low or not installed is very dangerous. In the event of a collision, the lack of head support may cause serious injury to the neck.

- **Headrests can reduce the whiplash effect and mitigate the neck injury of the occupants in case of rear impact.**

3-3. Adjusting the seat Seat memory

The position of the seat, steering wheel and exterior rearview mirror can be memorized at the same time.

Seat memory setting



Operate the A/C control panel and touch the seat setting button.



Set memory content: After adjusting the position of the seat, steering wheel, and exterior rearview mirrors, press and hold any memory button, then the button will be highlighted and ✓ will be displayed, which indicates that the position information has been recorded in the button.

Call out the memory content: press and release the memory button, the position of seat, steering wheel and exterior rearview mirror automatically adjusts to the memory position set by the button.

Courtesy function

The courtesy function includes two functions: automatic retreat and automatic return.

Automatic back: After you turn off the power (ignition) switch and open the left front door, the seat and the steering wheel will automatically move backward for the convenience of the driver getting out of the vehicle.

Automatic return: After you turn on the power (ignition) switch, the seat and the steering wheel will automatically return to the position before leaving the vehicle.

■ Courtesy function switch

The courtesy function can be turned on and off in the vehicle settings of the multimedia system. (Refer to P.223)

■ When automatically retreating

During the automatic retreat process, if the driver operates the steering wheel adjustment switch, the seat adjustment switch or the seat memory button, the steering wheel and/or seat retreat operations will stop.

■ When automatically returning

During the automatic return process, if the driver operates the steering wheel adjustment switch, the seat adjustment switch, or the seat memory button, the steering wheel and/or seat return operations will stop.

3-4. Adjusting the steering wheel and rearview mirrors

Steering wheel

Steering wheel adjustment

The steering wheel can be adjusted to a comfortable position.

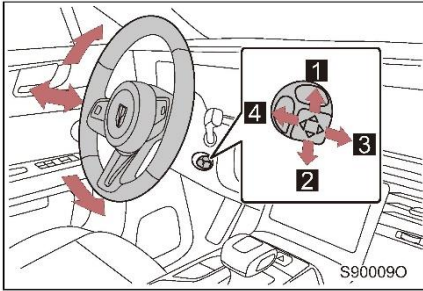

- 1 Move up
- 2 Move down
- 3 Move forward
- 4 Move backward

Steering wheel heating



Touch the steering wheel heating button on the A/C operation panel, the indicator will be illuminated, and the steering wheel heating function will be activated; touch the button again, the steering wheel heating function will be deactivated.

The steering wheel heating function will be deactivated in ECO driving mode

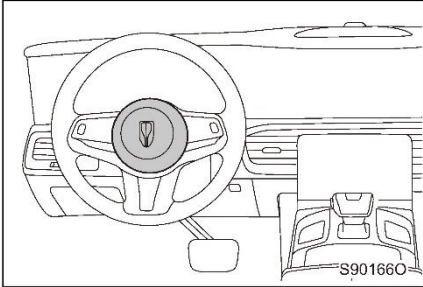
Horn

Press the horn symbol or the surrounding area to sound the horn.

WARNING
■ Precautions during driving

- Do not adjust the steering wheel during the driving process, otherwise it may lead to driver error and cause accidents, resulting in serious injuries or even death.
- When driving, the driver's hands should be held at the 3 o'clock and 9 o'clock positions on the outside of the steering wheel rim. Do not hold your hands at the 12 o'clock position of the steering wheel or in any other position to grasp the steering wheel; otherwise, the driver's airbag may cause injury to the driver's arms or head when it deploys.

■ When adjusting the steering wheel

The distance between the driver's chest and the steering wheel should be at least 300mm; do not set the steering wheel to the driver's face, otherwise, the driver's airbag will not provide effective protection in the event of an accident.

3-4. Adjusting the steering wheel and rearview mirrors

Anti-glare rearview mirror

Adjusting the interior rearview mirror

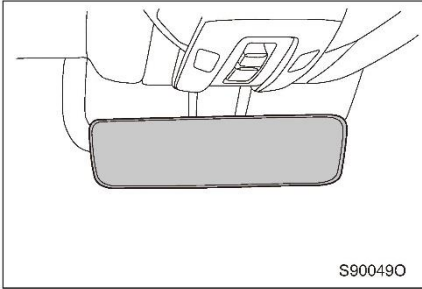

The interior rearview mirror can be adjusted up, down, left and right depending on the driving position.

The driver must adjust the interior rearview mirror to the right position to see the condition behind the car through the rear windshield.

WARNING

■ **During driving**

- Do not adjust the position of the rearview mirror during driving, otherwise it may cause an accident due to mishandling, which may lead to serious injuries or even death.
- Stacking items in the rear seat beyond the backrest will obstruct your view in the rearview mirror, resulting in a traffic accident. Therefore, do not stack items higher than the height of the backrest.

3-4. Adjusting the steering wheel and rearview mirrors

Exterior rearview mirror

Adjusting the exterior rearview mirror

When the power (ignition) switch is set to ON, the angle of the exterior rearview mirror can be adjusted.

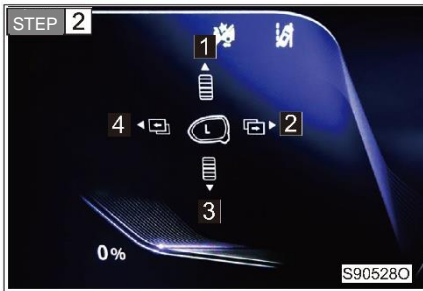
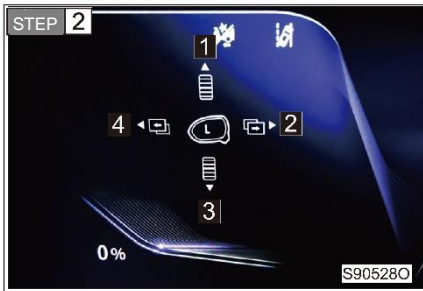
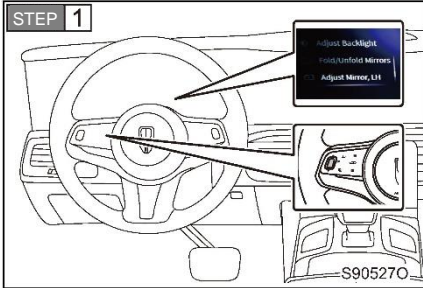

Operate the menu button on the left side of the steering wheel to enter the setting interface of backlight brightness and exterior rearview mirrors.

Operate the scroll wheel on the left side of the steering wheel to select the exterior rearview mirror at the corresponding side.

Operate the scroll wheel on the left side of the steering wheel and the left/right selection buttons to adjust the exterior rearview mirror at the corresponding side.

- 1 Move up
- 2 Move right
- 3 Move down
- 4 Move left

3-4. Adjusting the steering wheel and rearview mirrors

Folding the exterior rearview mirror

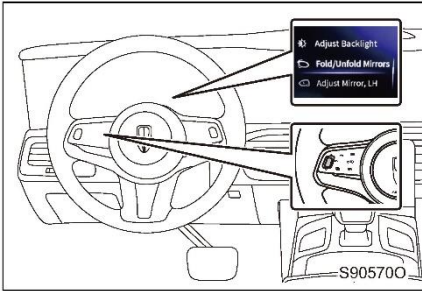

Operate the menu button on the left side of the steering wheel to enter the setting interface of backlight brightness and exterior rearview mirror and select the exterior rearview mirror to fold through the scroll wheel on the left side of the steering wheel.

When the doors are locked, the exterior rearview mirrors will automatically fold down; and when the doors are unlocked, the exterior rearview mirrors will automatically unfold.

The auto-folding of the exterior rearview mirror can be turned on/off in the vehicle settings of the multimedia system. (Refer to P.224)

Exterior rearview mirror heating



When the rearview mirror is fogging, touch the rear windshield heating button on the A/C operation panel to heat the exterior rearview mirror and the rear window at the same time; press the button again to release the heating.

If it is not manually turned off, the heater will automatically turn off after running for a period.

■ Apply electric mode in cold weather

In cold weather, the exterior rearview mirrors will freeze. If the electric mode is applied at this time, the exterior rearview mirror may fail to fold and unfold automatically. In this case, remove the snow and ice from the exterior rearview mirrors first, and then operate the mirrors manually.

■ Exterior rearview mirror memory

The exterior rearview mirror has a memory function and can be linked with the memory of the seat and the steering wheel. (Refer to P.104)

■ Right rearview mirror automatic adjustment function

When the shift lever is turned to R, this function will be activated, and the right rearview mirror will automatically flip downward to provide the driver with a reverse vision. 10 s after the shift lever disengages from R gear or when the vehicle speed exceeds 15 km/h, the rearview mirror will automatically return to the previous position.

The driver can adjust the right rearview mirror to an appropriate angle when the gear is shifted to R and memorize the target position for turning down.

The automatic adjustment function of the right rearview mirror can be turned on/off in the vehicle settings of the multimedia system. (Refer to P.224)



WARNING

■ When driving

Please observe the following precautions while driving. Failure to do so may result in loss of control of the vehicle and cause an accident, which may result in serious injury or even death.

- Always look around before changing lanes.

It is dangerous to change lanes without considering the actual distance of the vehicle in the exterior rearview mirror. Since the actual distance of the object is closer than what you see in the exterior rearview mirror, it can lead to a serious accident.

- Do not drive the vehicle with the exterior rearview mirrors folded. Before driving the vehicle, ensure that the exterior rearview mirrors are restored to the open position.

■ When adjusting the exterior mirror

To avoid personal injury and mirror malfunction, be careful not to let the moving mirrors pinch your hands.

■ When operating the exterior rearview mirror heater

- Do not touch the mirror surface of the exterior rearview mirror as it will become hot and may cause burns.
- If heating is not required, turn off the heating function of the exterior mirrors.

■ Precautions when driving

The following precautions should be observed when driving:

- Never adjust the rearview mirror during driving.
- The rearview mirrors on both sides must be unfolded and adjusted appropriately before driving.

Opening and closing power windows

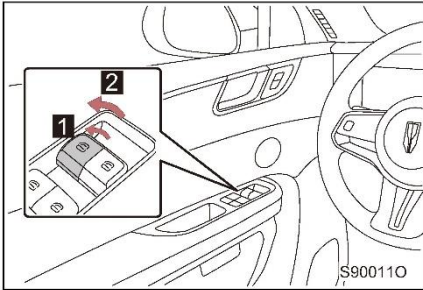

- 1 Manual rising-lowering**
Pull up/press down the corresponding window up/down switch at gear 1 (keep pulling up/down), and the window glass will rise/lower manually.
- 2 Automatic rising-lowering**
Pull up/press down the corresponding window up/down switch at gear 2 (pull up/press down and release), and the window glass will rise/lower automatically.

The driver side power window switch can control other windows up and down.

The second-row occupant side power window switch can control the rear windows up and down on both sides

■ Working conditions of power windows:

The power (ignition) switch is switched to ON.

■ Operate the power window after turning off the power (ignition) switch

Even after the power (ignition) switch has been turned off for a period, the power window can still be operated.

■ Lock the rear power windows

The rear door child safety lock is used to lock the rear power windows and the doors to prevent children from opening the rear doors and operating the windows in the vehicle. (Refer to P.85)

■ Initialization operation

After the automatic window rising-lowering function is disabled, the windows need to be initialized and set up, and the initialization method is as follows:

- When the window glass is at any position of the effective anti-pinch area (more than 4 mm from the top of the window frame), pull the switch of the window to be initialized up continuously to make the window close completely, and keep this action for about more than 2 s, then fully open and close the power window once. The initialization operation is completed.

If necessary, please contact an authorized FAW Hongqi dealer.

■ Anti-pinch function

If the power window encounters an obstacle during the automatic closing process, the power window can automatically return to a safe position.

■ Window automatic closing*

When the power (ignition) switch is switched to OFF and the window is not closed, you can determine the amount of rain through the light and rain sensor to automatically close the window.

The window automatic closing function can be turned on and off in the vehicle settings of the multimedia system. (Refer to P.223)

■ Remote window rising

When all doors, hatch and trunk lid are closed and the power (ignition) switch is in "OFF" mode, press and hold the lock button on the smart key to close all windows in the effective zone.

■ Smart window rising

When all doors, the hood and the trunk lid are closed, the power (ignition) switch is switched to OFF, and you carry the smart key, touch and hold the door handle sensor switch, then all windows will be closed.

■ Window rising by mechanical key

When all doors, the hood and the trunk lid are closed and the power (ignition) switch is switched to OFF, lock the door with a mechanical key and hold the action, then all windows will be closed.



WARNING

- **To avoid causing serious injury or even death, please observe the following precautions when closing the windows:**
 - The windows should be carefully checked when operating to ensure that they do not pinch any part of the occupants' body.
 - Do not allow children to operate the power windows.
- **Anti-pinch function**
 - Do not try to activate the anti-pinch function by intentionally jamming any part of your body.
 - If an object is caught when the window is about to close completely (4 mm), the anti-pinch function may not work.
 - If the automatic window rising-lowering function or anti-pinch function is disabled, initialization is required.

3-5. Opening and closing windows

Panoramic sunroof

The sunroof switch can be used to open and close the sunroof.

Opening and closing the sunroof

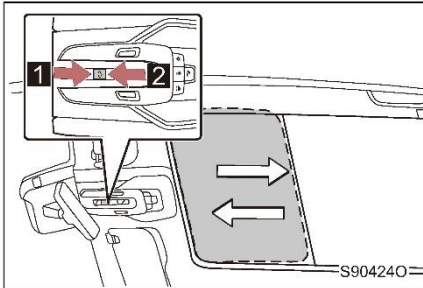

1 ON

When the sunroof is closed, press, and release the switch backwards once, the rear of the sunroof tilts up and the sunshade partially opens. When the sunroof is in the upward tilting position, press and release the switch backwards once, the sunroof and sunshade open simultaneously.

2 OFF

When the sunroof is open, press and release the switch forward once to close the sunroof.

Note: When the sunroof opens or closes automatically, press the sunroof switch again to stop the sunroof.

Press and hold the sunroof switch to manually open and close the sunroof; when you release the switch, the operations will stop immediately.

Opening and closing the sunshade

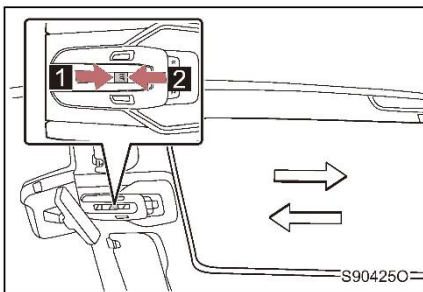

1 ON

Press and release the sunshade switch backwards once to fully open the sunshade.

2 OFF

Press and release the sunshade switch forward once to close the sunshade completely.

Note: When the sunshade is automatically opened or closed, if you press the sunshade switch again, the operations will stop.

Press and hold the sunshade switch to manually open and close the sunshade; when you release the switch, the operations will stop immediately.

If the sunroof is not closed, the sunshade cannot be closed completely.

■ Sunroof working conditions

The power (ignition) switch is switched to ON.

■ Operate the sunroof after turning off the power (ignition) switch

After the power (ignition) switch has been turned off for a period, if the driver side door is not opened, the sunroof can still be operated.

■ Initialization operation

● Sunroof initialization operation

Initialization is required when the sunroof position is incorrect, the automatic sunroof function fails, or the linkage function of the sunroof and the sunshade fails. The initialization steps are as follows: Turn the power (ignition) switch to "ON"; let the sunroof move to the fully closed position; press and hold the sunroof switch forward; release the switch when the sunroof hits the stopping point of the mechanism; press and hold the switch forward again; the sunroof performs a series of actions including tilting up to open, sliding to open and sliding to close and then stops; release the switch. The initialization operation is completed.

● Sunshade initialization operation

Initialization is required when the sunshade position is incorrect, or the automatic sunshade function fails. The initialization steps are as follows: Turn the power (ignition) switch to "ON"; let the sunshade move to the fully closed position; press and hold the sunshade switch forward; release the switch when the sunshade hits the stopping point of the mechanism; press and hold the switch forward again; the sunshade performs a series of actions including opening backward and closing forward and then stops; release the button. The initialization operation is completed.

■ Anti-pinch function

If the sunroof/sunshade encounters an obstacle during the automatic closing process, the sunroof/sunshade can automatically return to a safe position.

■ Sunroof automatic closing function*

When the power (ignition) switch is switched to OFF and the sunroof is not closed, you can determine the magnitude of rain through the light and rain sensor to automatically close the sunroof.

The window automatic closing function can be turned on and off in the vehicle settings of the multimedia system. (Refer to P.223)

■ Remote sunroof closing

When all doors, hatch and trunk lid are closed and the power (ignition) switch is in "OFF" mode, press and hold the lock button on the smart key to close the sunroof in the effective zone.

■ Smart sunroof closing

When all doors, the hood and the trunk lid are closed, the power (ignition) switch is switched to OFF, and you carry the smart key, touch and hold the door handle sensor switch, then the sunroof will be closed.

■ Sunroof closing by mechanical key

When all doors, the hood and the trunk lid are closed and the power (ignition) switch is switched to OFF, lock the door with a mechanical key and hold the action, then the sunroof will be closed.



WARNING

■ Precautions when opening the sunroof

To avoid causing serious injury, please observe the following precautions when opening the sunroof:

- When the vehicle is moving, it is prohibited for the occupants to put their hands or heads out of the vehicle.
- Do not sit on the sunroof.

■ Precautions when closing the sunroof

To avoid causing serious injury, please observe the following precautions when closing the sunroof:

- The sunroof should be carefully checked when closing to ensure that it does not trap any part of the occupant's body.
- Do not allow children to operate the sunroof.

■ During the initialization operation

- If the switch is released during the initialization process, this initialization operation fails and the initialization operation needs to be performed again.
- After the initialization operation, all functions of the sunroof need to be confirmed.
- If you are unable to complete the initialization, please contact an authorized FAW Hongqi dealer.

■ Anti-pinch function

- Do not try to activate the anti-pinch function by intentionally jamming the sunroof with any part of your body.
- If an object is caught when the sunroof / sunshade is about to close completely, the anti-pinch function may not work.

4-1 Before driving	
Driving the vehicle	118
Cargo and luggage	124
4-2 Driving rules	
Power (ignition) switch	125
Shift control	127
Driving mode	131
Air suspension *	135
Turn signal lamp control handle	139
Electric Parking Brake (EPB)	140
AUTO HOLD	142
4-3 Operating lights and wipers	
Headlamp ON/OFF	143
LED Matrix (ADB) *	145
Fog lamp switch	147
Front windshield wiper and washer	148
Rear windshield wiper and washer	151
4-4. Charging port cover	
Open charging port cover	152
4-5 Operating other driving systems	
Adaptive Cruise Control (ACC) *	154
Super adaptive cruise control (SACC) *	161
Front and Rear Parking Sensor (PSS) *	168
AVM system	173
Tire Pressure Management System (TPMS)	178
LDW/LKA	180
Front collision warning (FCW) system	183
Autonomous Emergency Braking (AEB)	186
Blind spot detection (BSD) system	189
TSR system*	194
Auto parking assist (APA)	196
Driver Assist System (DAS)	203
4-6 Driving information	
Driving essentials in winter	206
Refer to the Annex for trailer traction	
	390

The following driving rules must be observed to ensure safe driving.

■ Start the power system (refer to P.125)

■ Driving

STEP 1 Depress the brake pedal and shift the gearshift lever to D. The Electronic Parking Brake (EPB) is automatically released.

STEP 2 Gradually release the brake pedal and gently depress the accelerator pedal to accelerate the vehicle.

■ Parking

STEP 1 With the gear in D, depress the brake pedal.

STEP 2 If necessary, apply the EPB.
When parking for an extended period of time, be sure to shift to P or N.

■ Parking

STEP 1 With the gear in D, depress the brake pedal.

STEP 2 Press the P button to put the gear in P. The EPB is applied automatically.

STEP 3 Turn off the power supply of the vehicle, lock the vehicle, and make sure you carry the key at all times.

Starting on a steep slope

- STEP 1** The driver fastens the seat belt, closes the door, firmly presses the brake pedal and shifts the gearshift lever to D.
Make sure the gear indicator shows D.
- STEP 2** Apply the EPB manually.
- STEP 3** Release the brake pedal and gently depress the accelerator pedal.

■ When starting uphill

Hill Hold Control (HHC) system will be activated automatically to prevent the vehicle from skidding. (Refer to P.203)

■ Emergency Stop Signal (ESS)

When a certain speed is reached, if the emergency brake is applied, the brake light flashes rapidly to alert the vehicle behind until the brake pedal is released.

■ Driving in rain

- When it is raining, please drive carefully because visibility is reduced, windows tend to fog up and roads are slippery.
- Do not drive at high speed when it is raining because a film of water will form between the tires and the road, which will prevent the steering and braking from working properly.

■ Running in new car

To prolong the life of your vehicle, it is recommended that you observe the following precautions:

- Within the first 1,000 km:
 - Do not brake sharply.
 - Do not drive at very high speed.
 - Do not accelerate suddenly.
 - Do not continue to drive at a low speed.
 - Do not drive at constant speed for long periods of time.

■ Driving abroad

Please abide by the laws and regulations of your country or region.



WARNING

■ When starting the vehicle

When the vehicle is in "READY" state and is stopped, always depress the brake pedal. This will prevent the vehicle from moving unexpectedly.

■ Precautions when driving

- If you are not familiar with the brake pedal and accelerator pedal positions, do not drive to avoid pressing the wrong pedal.
 - If the accelerator pedal is accidentally depressed when the brake pedal should be depressed, it will cause sudden acceleration, which may result in a serious accident.
 - Although the vehicle is equipped with a rear-view camera (RVC) system and a parking distance control (PDC), you still must drive with caution when reversing.
 - When reversing, it may not be easy to operate the pedals because of twisting your body. Make sure to operate the pedal correctly.
 - Maintain the correct driving position even when moving the vehicle slightly so that the brake pedal and accelerator pedal can be depressed accurately.
 - Use your right foot to press the brake pedal. In an emergency, if the brake pedal is pressed with the left foot, the response may be delayed, which could lead to an accident.
- Do not drive over or park near flammable materials. If there is any flammable material nearby, it may cause a fire.
- Do not move the vehicle backward when the gear is in D or P, or forward when the gear is in R or P. This may cause an accident or damage the vehicle.
- Do not touch the power (ignition) switch during driving.

If the power (ignition) switch is accidentally turned off, the brake booster, etc. will fail to work properly.
- When going down a steep slope, you must slow down.

Note that continuous use of the brakes may cause them to overheat and fail.
- When the vehicle is parked on an inclined road, please make sure the slope is suitable for the EPB function, otherwise, please depress the brake pedal and apply the EPB to prevent the vehicle from moving forward or backward and causing an accident.
- Do not adjust the position of the steering wheel, seat, interior, or exterior rearview mirrors while driving. Failure to do so may result in an accident.
- Always check and make sure that all occupants' arms, heads, or other body parts are not poking out of the vehicle, otherwise serious injury may result.

**WARNING**

■ **When driving on slippery roads**

- Emergency braking, acceleration and steering may cause wheel slippage, reducing the vehicle's controllability and thus causing an accident.
- After the vehicle passes through a puddle, please gently press the brake pedal to confirm that the brake function is normal. Wet brake linings do not brake properly. Even if only one side of the brake lining becomes wet, it can affect vehicle handling.

■ **When operating the shift lever**

Be careful not to shift gears while the accelerator pedal is depressed.

Otherwise, the vehicle may accelerate suddenly and unexpectedly, which may cause an accident.

■ **When the vehicle stops**

- Do not leave the vehicle in "READY" state.
If the vehicle is in a gear other than P or N, the vehicle may suddenly and unexpectedly accelerate, which may cause an accident.
- When the vehicle is in "READY" state, always depress the brake pedal and apply the parking brake when necessary to prevent accidents caused by the movement of the vehicle.
- If the vehicle is parked on a slope, to prevent an accident caused by the vehicle's movement forward or backward, be sure to depress the brake pedal and apply the parking brake firmly when necessary.

■ **After the vehicle is parked**

- Do not leave glasses, lighters, aerosols, or soft drink cans in the vehicle while in a hot location as this may result in the following accidents:
 - Gas leaks from the lighter or aerosol dispenser and starts a fire.
 - The temperature inside the vehicle may deform or break the lenses and other plastic parts of eyeglasses.
 - Soft drink cans may rupture, causing beverages to spill onto the vehicle interiors, and may also cause short circuits in the vehicle's electrical components.
- Be sure to apply the EPB, shift the gear to P, turn off the power (ignition) switch and lock the vehicle.
- Do not leave the vehicle when it is in "READY" state.
- When the power (ignition) switch is turned on or immediately after the power (ignition) switch is turned off, do not touch the high-voltage parts in the engine compartment, otherwise it may cause electric shock or burns.



WARNING

■ **While napping in the car**

Be sure to turn off the power (ignition) switch. Otherwise, you may accidentally move the shift lever or depress the accelerator pedal, causing an accident.

■ **When applying the brake**

- Be more careful when driving with wet brakes.

When the brake is wet, the braking distance will increase, the braking effect on both sides of the vehicle may be different, and the vehicle may not be secured firmly by applying the parking brake.

- If the brake assist function is abnormal, do not follow other vehicles in proximity and avoid long hills or sharp turns.

In this case, you need to use more force than usual when depressing the brake pedal, and the braking distance may also increase.



Notice

■ During driving

Do not use the accelerator pedal or depress the accelerator pedal and brake pedal at the same time to stop on a ramp.

■ When parking

When parking for long periods of time, be sure to apply the EPB and place the gear in P. Failure to do so may cause the vehicle to move or accelerate suddenly when the accelerator pedal is accidentally depressed.

■ Driving performance

- When the ambient temperature is too high or too low, the vehicle can start normally, but the performance of the vehicle may be weakened.
- For new vehicles with the power battery in normal status, the driving range may fluctuate because of the driving habits (e.g., frequent acceleration and deceleration), road conditions (e.g., going up a long slope), air temperature (e.g., low temperature) and the turning on/off the electrical equipment (e.g., A/C).

■ Avoid damage to vehicle parts

- Do not turn the steering wheel full in either direction or hold it for a long time, as this may damage the power steering system.
- When driving on bumpy roads, you should drive as low as possible to avoid damaging the wheels, the bottom of the vehicle, etc.

■ If a tire leaks when driving

Leaky or damaged tires may cause the following to occur. Please hold the steering wheel firmly and slowly depress the brake pedal to reduce the speed of the vehicle:

- It may be difficult to control the vehicle.
- The vehicle will make abnormal sounds.
- The vehicle will drive abnormally. Replace the leaking tire with a new one.

■ When encountering waterlogged roads

Do not drive on roads with deep water, as this may result in serious damage to the vehicle as described below. | Electrical parts short circuit.

- The power system is damaged after soaking in water. After driving on a waterlogged road and the vehicle is in water, please contact an authorized FAW Hongqi dealer to check the following items as soon as possible.
- Whether the brake function is normal.
- Whether the level and the quality of the reducer oil have changed.
- The lubrication condition at the connections (possible parts) between the bearing and the suspension, and whether the functions of all connections, bearings, etc. are normal.

4-1. Before driving

Cargo and luggage

When storing cargo and luggage, please note the following matters.

- Store cargo and luggage in the trunk whenever possible.
- Make sure all items are securely fastened.
- Take care to keep the vehicle level. Place heavy objects as far forward as possible to keep the vehicle balanced.
- To extend the driving range, do not carry heavy objects that are unnecessary.



WARNING

■ Items prohibited to be stored in the trunk

The following items in the trunk may cause a fire.

- Containers containing gasoline.
- Aerosol cans.
- Other flammable and explosive materials.

■ Storage precautions

To avoid serious injury or even death, please observe the following precautions.

- Do not place cargo or luggage in the following positions, otherwise the items may not work properly due to jamming the brake pedal or accelerator pedal and may block the driver's view or touch the driver or occupants, which may cause an accident.

- Driver's feet
- Front passenger seat or rear seat (when stacking items)
- Instrument panel

- Store all items in the compartment, otherwise they can move and cause personal injury in an accident or during emergency braking.
- Do not store poorly sealed liquid containers in the trunk.

■ Load and distribution

- Do not overload the vehicle.
- Be sure to place the goods evenly.

Improper placement may result in poor steering or braking control performance, resulting in serious personal injury or even death.

- Do not place heavy objects in the trunk for a long time.

Leaving heavy objects in the trunk for a long time may affect the performance of the suspension system.

- Installing accessories on the roof will increase the wind resistance, and the accessories shall be removed if not in use.
- The maximum load carrying weight of the luggage rack on the roof shall be not more than 75kg.

Power (ignition) switch

If you carry the smart key, you can switch the power (ignition) switch mode or start the power system.

■ Switch the power (ignition) switch mode

By touching the power (ignition) switch [START] or depressing the brake pedal, the power mode can be switched from OFF to ON; by touching the power (ignition) switch [OFF] again or the remote-control lock button, the power mode can be switched from ON to OFF.

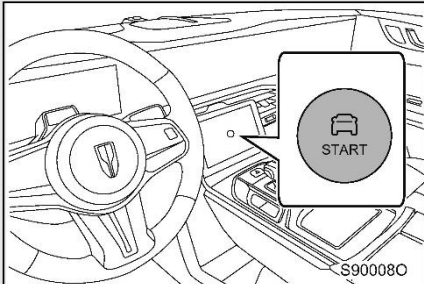

OFF mode *1

The position lamp and the hazard warning lamp can be used.

ON mode

All electrical components can be used.

*1: Before turning off the power (ignition) switch, switch the gear to P.

■ Start the power system

STEP 1 Sit in the driver seat and depress the brake pedal firmly.

STEP 2 Switch the shift lever to D/R.

The "READY" indicator on the instrument cluster will be illuminated.

■ Stop power system

STEP 1 Completely stop the vehicle.

STEP 2 Switch the gear to P and confirm that the parking brake has been applied.

STEP 3 Press the power (ignition) switch or remote-control lock button to power off the vehicle.

■ If the vehicle cannot be started

The vehicle anti-theft system may not be released yet. (Refer to P.61)



WARNING

■ Precautions during driving

Do not touch the power (ignition) switch during driving to prevent the accidental closing of the power system from causing accidents.



Notice

■ Preventing low battery power

- When the driver leaves the vehicle, he/she should lock the vehicle and carry the key with him/her. Do not leave the key in the cabin to prevent the Passive Entry & Passive Start (PEPS) from continuously working, which may result in a low battery charge.

■ When the "READY" indicator is off

- If the "READY" indicator is still not illuminated after the correct start procedures of vehicle are performed, please contact the authorized FAW Hongqi dealer immediately.

Choose a gear that suits the driving conditions.

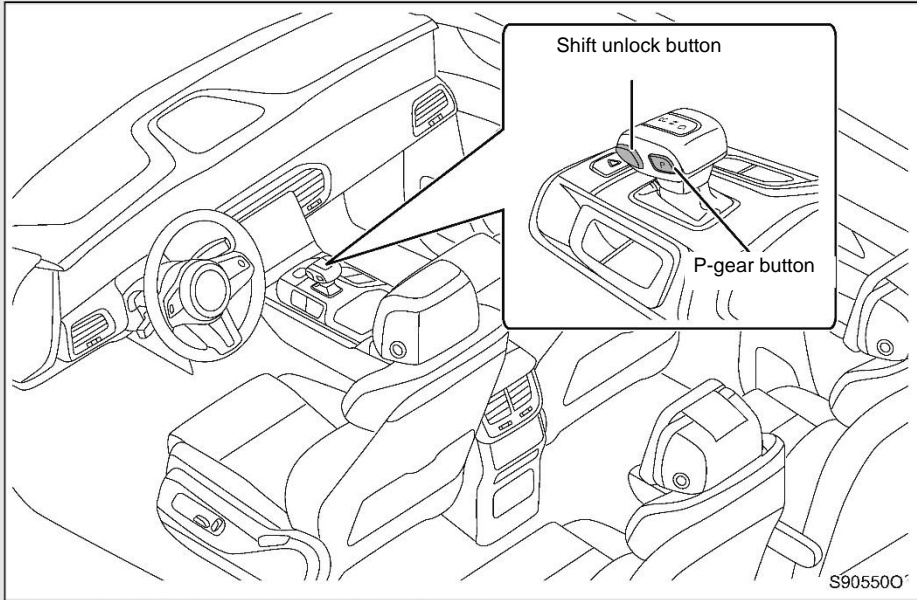

Gently operate the shift lever and make sure the shift is operating correctly.
Release the shift lever to reset it after each shift operation.

■ Gear shift

When the power (ignition) switch is switched to ON, you can perform shift operations as follows.

- P to D: Depress the brake pedal, press the unlock button and operate the shift lever downwards to the first or second stroke.
- P to N: Depress the brake pedal, press the unlock button and operate the shift lever upwards to the first stroke.
- P to R: Depress the brake pedal, press the unlock button and operate the shift lever upwards to the second stroke.
- N to D: When the vehicle is stationary, operate the shift lever downwards to the first or second stroke*.
- N to R: When the vehicle is stationary, press the unlock button and operate the shift lever upwards to the first or second stroke*.

*: If the stay time in N gear is more than 1 second, it is necessary to press the brake pedal to shift. If the stay time in N gear is less than 1 second, it is not necessary to press the brake pedal to shift.

4-2. Driving rules

- D to N: Operate the shift lever up to the first stroke.
It is impossible to switch when the vehicle speed is greater than 50 km/h.
- D to R: Depress the brake pedal until the vehicle comes to a standstill, press the unlock button, and operate the shift lever upwards to the second stroke.
- R to N: Operate the shift lever downwards to the first stroke.
- R to D: Depress the brake pedal until the vehicle comes to a standstill and operate the shift lever downwards to the second stroke.
- N/D/R to P: Depress the brake pedal until the vehicle comes to a standstill and press the P gear button.

When selecting a gear, make sure the gear display on the instrument cluster is the desired gear.

■ Gear function

Gear	Function
P	Parking (vehicle E-PARK locks)
R	Reversing
N	Neutral (the vehicle has no power output, and E-PARK is unlocked)
D	Driving

E-PARK: The control unit drives the actuator motor to mechanically lock the intermediate shaft of the reducer to park the vehicle at P gear.

Gear description

► P (Park)

The P gear can lock the reducer and prevent the wheels from turning.



WARNING

■ First operation of shift lever

The car adopts electronic gearshift mechanism, which needs to be operated according to the gear information on the instrument cluster information display and the above gear operation instructions and should not be operated by sense consciousness to avoid danger.

■ Be sure to shift to P and apply the parking brake

It is very dangerous to shift to P without applying the parking brake. If the P-gear does not fully immobilize the vehicle, it may move and cause an accident.

▶ R (Reverse)

When in R, the vehicle can only move backward. The vehicle must come to a complete stop before shifting to or out of R gear.

▶ N (Neutral)

When in N gear, the motor drive system will be in servo state, and the wheels and transmission system are not locked. When parking on a gentle slope, press the brake pedal or apply the parking brake, otherwise the vehicle will slide freely.

▶ D (Drive)

D is the gear normally used when driving to control the vehicle forward.

P-gear button

■ When shifting to P

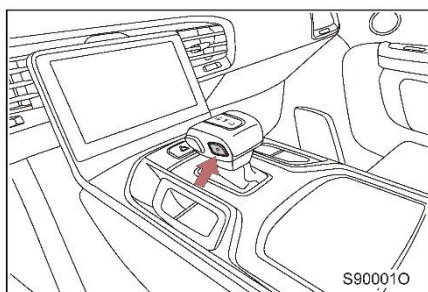

The gear can be shifted to P by using the P gear button.

When the vehicle is stationary, press the P button.

When shifting to P, the instrument cluster gear information is displayed as P.

If the speed of the vehicle is more than 3 km/h, it will not be possible to shift into P gear.

■ When switching from P to other gears

- Press the unlock button while depressing the brake pedal firmly to operate the shift lever. If the shift lever is operated without depressing the brake pedal, the shift operation is disabled.
- When shifting a gear, make sure the gear display information on the instrument cluster is the desired gear.

■ The vehicle will switch to P gear automatically under the following conditions

- When the power (ignition) switch is switched to OFF.
- When the vehicle speed is lower than 2 km/h, if the driver unfastens the seat belt, releases the brake pedal and opens the door.
- When the vehicle is charging, it automatically switches to P gear, but there is not any response to the shift operations of the driver.

■ Pedestrian warning system

When the driver switched the gear to D or R, and the vehicle speed is 0-30 km/h, the pedestrian warning system will emit a warning sound. When in D gear, the sound level changes with the vehicle speed; when in R gear, the warning sound will not change.

The pedestrian warning sound can be turned on and off in the vehicle settings of the multimedia system. (Refer to P.219)



WARNING

■ **When driving on smooth roads**

Be careful when accelerating and decelerating suddenly, as this may cause the vehicle to skid sideways or idle at the wheels.

4-2. Driving rules

Driving mode

The vehicle is equipped with a driving mode switching system, which can provide seven different driving modes: ECO, Comfort, Sport, All-terrain, Off-road, Custom, and Extreme. The vehicle has unique driving performance in different modes to satisfy the driving needs of the driver.

■ Driving mode selection

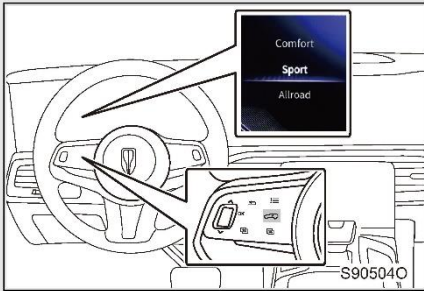

Method 1: Driving mode selection button

Press and release the driving mode selection button on the steering wheel to enter the driving mode selection interface; select the corresponding driving mode using the scroll wheel on the steering wheel.

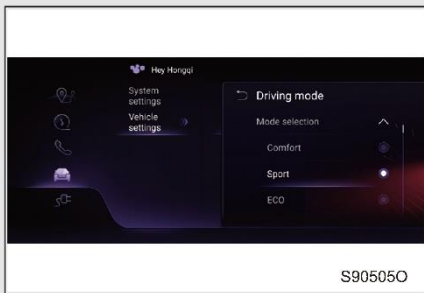

Method 2: Multimedia display

Select the corresponding driving mode in the vehicle settings of the multimedia system.

ECO mode

In the LBL mode, the vehicle has good endurance and is suitable to run on common pavements in urban areas.

■ Driving characteristics in LBL mode

- The power output is stable and gentle.
- On Exclusive and Exclusive+ with air suspension system and CDC dampers, the car's height will automatically be adjusted to dynamic level, the height of the suspension is adjusted according to speed, the suspension is moderate and the road feel is relatively balanced (P.135)

NB! Features that are disabled when ECO mode is activated:

1. The Keyless system (automatic unlocking)
2. Steering wheel heating
3. 3. screen
4. Ambient lightning
5. Massage (applies to Exclusive)
6. Fragrance (applies to Exclusive+)

Comfort mode

In comfort mode, the vehicle has good comfort and is suitable to run on common pavements in urban areas.

- Driving characteristics in comfort mode
 - The power output is balanced.
 - The steering feels light.
 - On Exclusive and Exclusive+ with air suspension system and CDC dampers, the height of the car will automatically be adjusted to the normal level, and the height of the suspension is adjusted according to the speed. (See p.135.) The suspension is relatively soft, and there is a high level of comfort.

Sport mode

In sport mode, the vehicle has good dynamics and is suitable to run on highways or common pavements in urban areas.

- Driving characteristics in sport mode
 - The power output is strong.
 - The steering movement is progressive.
 - On Exclusive and Exclusive+ with air suspension system, the car's height will automatically be adjusted to Sport level, and the height of the wheel suspension is adjusted according to speed. (See p. 135.) The suspension becomes relatively hard, and the road feel is strong.

Allroad mode

The Allroad mode is applicable to low-adhesion roads, slippery grass, and gravel roads after snow.

- Driving characteristics in all-terrain mode
 - The power output is stable and gentle, reducing vehicle skidding.
 - On Exclusive and Exclusive+ with air suspension system and CDC dampers, the car's height will automatically be adjusted to Allroad mode. The suspension is moderate, and the road feel is relatively balanced.

Offroad mode

The Offroad mode is applicable to urban road shoulders and light off-road pavements.

Do not switch to the off-road mode unless the vehicle is running at a relatively low speed. When the vehicle is running in off-road mode at a high speed, the driving mode will be automatically switched to Allroad mode.

■ Driving characteristics in off-road mode

- The power output is stable and gentle, reducing vehicle skidding.
- On Exclusive and Exclusive+ with air suspension system and CDC dampers, the car's height will automatically be adjusted to Offroad mode. The suspension is moderate, and the road feel is relatively balanced.
- Note: You can only switch to Offroad mode when the car's speed is relatively low. If the car's speed is relatively high after using Offroad mode, the driving mode automatically switches to All-terrain mode

Extreme mode* (BOOST)

The extreme mode provides users with the extreme driving experience. In extreme mode, the vehicle has strong power characteristics and is suitable to run on well-paved roads.

In sport mode, if the power battery temperature is not more than 35°C and the power battery electricity is equal to or more than 70%, the driving mode can be activated through the multimedia display or by pressing the scroll wheels on both sides of the steering wheel simultaneously for 3 s.

In extreme mode, the user needs to actively switch the driving mode to the sport mode to exit the extreme mode; In addition, the extreme mode shall be switched to the sport mode in any of the following situations for the sake of range and vehicle safety and stability:

- When the power battery temperature is more than 50°C.
- When the power battery is less than 30%.
- When the extreme mode is activated for more than 10min.
- Turn the power (ignition) switch to OFF.

■ Driving characteristics in extreme mode

- The power is quite strong.
- The movement of the steering system is strong.
- On Exclusive and Exclusive+ with air suspension system CDC dampers, the height of the car is automatically adjusted to Extreme mode, and the height of the suspension is adjusted according to the speed. (See p. 135.) The suspension is relatively hard, and the road feel is strong.

Custom mode

To satisfy the driving needs of individuals, the driver can also select the custom mode in addition to the above-mentioned driving modes.

In custom mode, the user can set the acceleration mode, coasting energy recovery level, steering characteristics, and suspension comfort.

The driving characteristics in custom mode can be set in the vehicle settings of the multimedia system. (Refer to P.225)

■ Setting conditions for switching driving mode

- The power (ignition) switch is switched to ON.

■ Working conditions of driving mode system

- When selecting the driving mode, the driver may know the current working conditions of the driving mode system through the information displayed in the instrument cluster.



Notice

■ **Do not enter special driving modes (such as Off-road and All-terrain) on common urban pavement or highways, which are only designed for special road conditions. Long-term use on the above roads may damage the driveline system.**

■ Precautions for switching the driving modes

- To ensure driving safety, please switch the driving mode when the vehicle is parked or driving at a low speed on a good road.
- The driving mode switching system has a self-protection function. Activating the driving mode may damage the vehicle and affect driving safety if the working conditions for corresponding driving mode are not met. Failure to switch to the target mode may be caused by the self-protection of the system, which is normal.
- When the working conditions are met but the driving mode system still does not work normally, please contact the authorized FAW Hongqi dealer to check the vehicle.
- The driving mode system cannot replace the driver's judgment on the driving environment, so the driver must maintain control of the vehicle at all times and has full responsibility for the vehicle.

The vehicle can be maintained at different height levels by adjusting the driving mode, thus making different ground clearances to achieve the better trafficability.

Adjustment of AirS

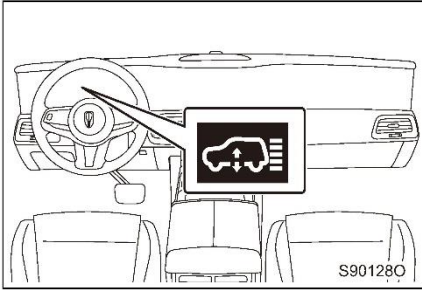

The vehicle height can be adjusted in the process of selecting a driving mod, and it will also be automatically adjusted according to the driving mode and speed during driving.

During the adjustment, the AirS indicator on the instrument cluster flashes and prompts the vehicle in rising/lowering state. After the adjustment is completed, the indicator stops flashing and displays the current height level.

Adjustment of AirS system

The AirS has different height levels and damping characteristics, which depend on the selected driving mode. The vehicle height can be automatically adjusted with the vehicle speed and can be adjusted to all height levels below the corresponding height of the current driving mode.

■ AirS characteristics in Offroad mode

- In this mode, the damper is automatically set to a balanced damping characteristic, and the vehicle height is automatically set to [off-road height 2] (+60 mm).
- This mode can be activated when the vehicle speed is less than 20 km/h. When the vehicle speed is more than 40 km/h, the driving mode is automatically adjusted from the off-road mode to the all-terrain mode, and the vehicle height is decreased to [off-road height 1] accordingly.

■ AirS characteristics in Allroad mode

- In this mode, the damper is automatically set to the damping characteristic adapting to slippery roads, and the vehicle height is automatically set to [off-road height 1] (+25 mm).
- When the vehicle speed is more than 80 km/h, the vehicle height will automatically decrease to the [normal level]; when the vehicle speed is less than 40 km/h, the vehicle height will automatically return to the [off-road height 1].

■ AirS characteristics in Comfort mode

- In this mode, the damper is automatically set to comfortable damping characteristic, and the vehicle height is automatically set to [normal level] (+0 mm).
- When the vehicle speed is more than 100 km/h for 30 s, the vehicle height will automatically decrease to the [dynamic level]; when the vehicle speed is less than 70 km/h for 120 s, the vehicle height will automatically return to the [normal level]. When the vehicle speed is less than 35 km/h, the vehicle height will immediately return to the [normal level].

4-2. Driving rules

■ AirS characteristics in ECO mode

- In this mode, the damper is automatically set to the balanced damping characteristic, and the vehicle height is automatically set to [dynamic level] (-15 mm).
- When the vehicle speed is more than 140 km/h for 20 s, the vehicle height will automatically decrease to the [highway level] (-30 mm); when the vehicle speed is less than 110 km/h for 20 s, the vehicle height will automatically return to the [dynamic level]; when the vehicle speed is less than 35 km/h, the vehicle height will immediately return to the [dynamic level].

■ AirS characteristics in sport and Extreme modes

- In the two modes, the damper is automatically set to rigid damping characteristic, and the vehicle height is automatically set to [dynamic level] (-15 mm).
- When the vehicle speed is more than 140 km/h for 20 s, the vehicle height will automatically decrease to the [highway level] (-30 mm); when the vehicle speed is less than 110 km/h for 20 s, the vehicle height will automatically return to the [dynamic level]; when the vehicle speed is less than 35 km/h, the vehicle height will immediately return to the [dynamic level].

■ Adjusting the suspension

- If the power (ignition) switch is set to OFF during the adjustment of suspension, the adjustment will be interrupted immediately until the power (ignition) switch is reset to ON, where the suspension will be automatically adjusted to the height corresponding to the current driving mode.
- If the current vehicle speed is not suitable for vehicle height adjustment, the vehicle height shall not be adjusted. Once the desired speed is reached, the vehicle will be automatically adjusted to the height corresponding to the driving mode.
- If any door is opened during the adjustment of suspension, the adjustment will be interrupted immediately, and the suspension will be automatically adjusted to the height corresponding to the current driving mode after all doors are closed.

■ Automatic adjustment with engine shutdown

After the automatic adjustment with engine shutdown is activated, if the vehicle is in Offroad or Allroad mode before the power off, the vehicle height will automatically decrease to the [normal level] immediately after power off, to facilitate getting on/off. If the vehicle is in other driving modes before powering off, the vehicle height will automatically decrease to the [highway level] after power off, to facilitate getting on/off.

You can set the on and off automatic adjustment with engine shutdown in the vehicle settings of the multimedia system. (Refer to P.223)

Note: After turning on this function, please pay attention to the parking environment for the vehicle before power off every time, so as not to damage the chassis due to the lowering of the vehicle height.

■ Easy access

Via the easy access, the AirS can be manually adjusted to [highway level], to facilitate getting on and off the vehicle. You can set the on and off easy access in the vehicle settings of the multimedia system. (Refer to P.223)



WARNING



Notice

■ Suspension height level failed to be adjusted normally

When a certain driving mode is selected, in order to ensure the safety of occupants, the AirS system will determine whether to respond to the request according to the current driving conditions. When the system determines that the current working conditions are not suitable for adjustment, the suspension will not be adjusted, which is normal.

Lifting mode

You must turn on the lifting mode before you use a jack or lifter to rise the vehicle.

After the lifting mode is entered, all AirS adjustment functions will be disabled. When the maintenance is completed, you must exit the lifting mode.

■ Entering the lifting mode

With the power (ignition) switch placed in the ON mode, press and hold the [lifting mode] button on the suspension adjustment interface of the multimedia system, and the instrument cluster will display the prompt message "Air suspension system in lifting mode", which indicates that the lifting mode is entered.

■ Exiting the lifting mode

With the power (ignition) switch placed in the ON mode, and the vehicle in the lifting mode, touch the [Exit] button on the suspension adjustment interface of the multimedia system to exit the lifting mode, and the prompt message "Air suspension system in lifting mode" will disappear; when the vehicle speed is more than 5 km/h, the vehicle will automatically exit the lifting mode.

Loading mode

The vehicle has a loading mode, in which the height of rear suspension can be lowered to (-45 mm) to facilitate loading and unloading of goods.

■ Entering the loading mode

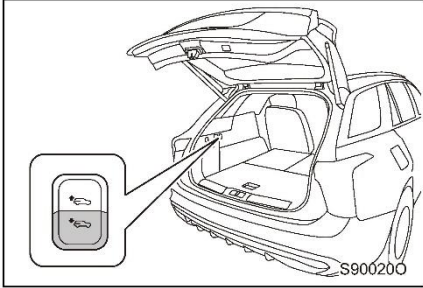

Close all doors, apply EPB, open the trunk lid and press the AirS lowering button to enter the loading mode.

■ Exiting the loading mode

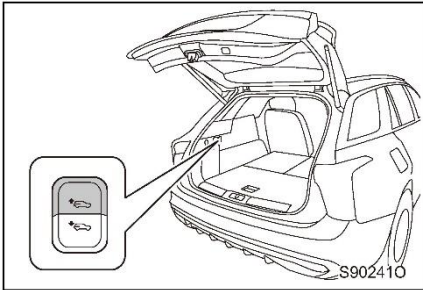

Press the AirS rising button in the trunk or close the trunk lid to exit the loading mode. When the vehicle speed is more than 5 km/h, the vehicle will automatically exit the loading mode.

*The car must be on to perform the raising function

Notice

■ Precautions for using the loading mode.

- When using the loading mode, leave enough space under the vehicle.
- When exiting the loading mode, leave enough space above the vehicle and the opened trunk lid.

Turn signal lamp control handle

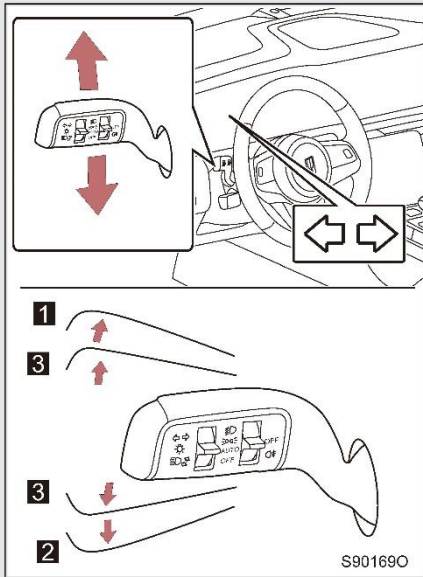

- 1 Turn right
- 2 Turn left
- 3 Comfort flash

When the control handle is moved to the non-self-locking position once, the left/right turn signal lamp flashes 3 times; when the control handle is continuously held to the non-self-locking position, the left/right turn signal lamp flashes continuously until the control handle is released.

■ Turn signal lamp working conditions

The power (ignition) switch is switched to ON.

■ Steering lamp and hazard warning lamp control

When the turn signal lamp is on, press the hazard warning lamp switch, the left and right turn signal lamps flash at the same time; and press the hazard warning lamp switch again to return to the working state of turn signal lamp.

When the power (ignition) switch is in "ON" mode, turn on the turn signal when the hazard warning lamp is on, the turn signal lamp will work, and the hazard warning lamp will stop working; turn off the turn signal lamp and return to the hazard warning lamp working state.

Electric Parking Brake (EPB)

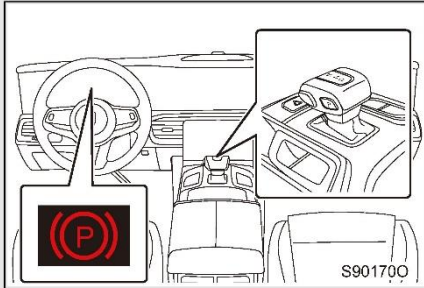

Automatic application/release of the EPB

The EPB is automatically applied when the brake pedal is depressed, and the gear is shifted to P. The EPB is automatically released when the gear is shifted to D/R.

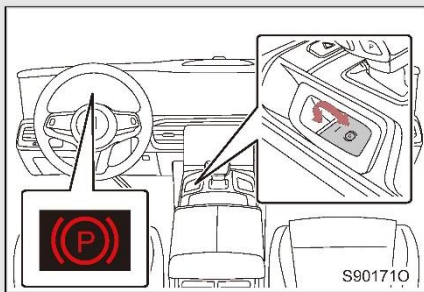

Manual application/release of the EPB

After depressing the brake pedal to make sure the vehicle is at a standstill, lift the EPB switch upward to apply the EPB; with the power (ignition) switch in "ON" mode, depress the brake pedal and press the EPB switch to release the EPB.

■ Other EPB functions

- Hill Hold Control (HHC) function: the driver fastens the seat belt, closes the door, and applies the EPB before the vehicle starts, the system will automatically release the EPB according to the torque balance principle, so that the vehicle will not skid and start smoothly.
- Electronic deceleration control function: When the vehicle is running, keep lifting the EPB switch upward, and the vehicle will brake until it stops.

■ AUTO HOLD after power-off

- When the driver stops the vehicle and turns off the power(ignition) switch, the EPB will be applied automatically.



Notice

■ Precautions before driving

- In the event of a malfunction (e.g. electrical failure), the EPB locked rear brake disc can only be unlocked by mechanical means, and you are advised to contact an authorized FAW Hongqi dealer to do so.
- Driving the vehicle when the EPB is not released and the red indicator is illuminated will cause the brake components to overheat, thus affecting brake performance and increasing brake wear.
- If the road condition is not suitable for parking, the instrument cluster multi-function display will prompt "Too steep to park".

4-2. Driving rules

AUTO HOLD

In the AUTO HOLD ready state, depress the brake pedal deeply again after the vehicle is stopped or directly depress the brake pedal deeply until the vehicle stops so as to activate AUTO HOLD. At this time, the vehicle will hold the brake when the brake pedal is released. When the brake pedal or accelerator pedal is depressed with the gear in D/R, the system will release AUTO HOLD.

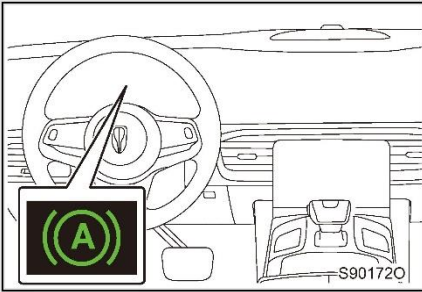

When the AUTO HOLD is activated, the AUTO HOLD indicator lights up on the instrument cluster.

■ AUTO HOLD on/off

You can set the on and off of AUTO HOLD function in the vehicle settings of the multimedia system. (Refer to P.225)

■ AUTO HOLD function

- AUTO HOLD can also serve as a Hill Hold Control (HHC) function. The Auto Hold function may not hold the vehicle when it is on a steep slope. In this case, it is necessary to apply the brakes artificially.
- After the AUTO HOLD is activated for a period, the EPB will take over the AUTO HOLD function.

■ Working conditions of AUTO HOLD

- The driver side door is closed.
- The driver fastens his seat belt.
- The AUTO HOLD function in the multimedia system is set to on.
- Depress the brake pedal deeply again after the vehicle is stopped; or directly depress the brake pedal deeply until the vehicle stops and then release the brake pedal.

4-3. Operating lights and wipers Headlamp ON/OFF

ON The headlamps (low beams) and all the following lamps are illuminated.

AUTO The headlamp (low beam), position lamp, license plate lamp and instrument panel backlight are illuminated.

OFF Turn off.

S90173O

Turn on the high beams

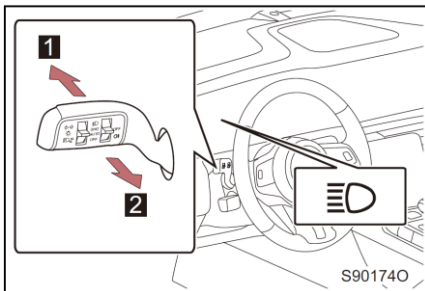

- 1 When the headlamps (low beams) is on, push the light control handle forward to turn on the high beams; pull the handle back to the original position to turn off the high beams.
- 2 Pull the light control handle backward to turn on the high beams; release the light control handle to turn off the high beams.

■ Daytime driving lamp system

To make your vehicle more visible to other drivers during daytime driving, the daytime driving lamp will automatically turn on whenever the power (ignition) switch is set to ON mode and the position lamps are off.

4-3. Operating lights and wipers

■ Light and rain sensor

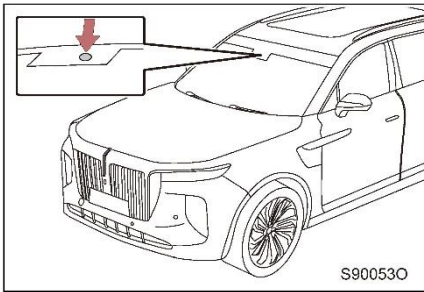

If an object is placed on the sensor or if there is an attachment on the windshield that obscures the sensor, the sensor may not be working properly.

The above conditions can affect the sensor's detection of ambient light intensity, which may cause the automatic headlamps and automatic wipers not to operate properly.

■ Headlamp leveling system

The headlamp leveling system can automatically adjust the headlamp beam height according to the number of occupants, the load of the vehicle and the road environment to ensure that the headlamps will not interfere with other road users.

Follow me home*

With the power(ignition) switch placed in the ON mode and the low beam illuminated, the lamp continues to illuminate for a period after the power(ignition) switch is switched to OFF mode and then automatically goes off. You can set the on and off follow me home function and illuminating time in the vehicle settings of the multimedia system. (Refer to P.226)

Illuminated entry system *

With the power(ignition) switch placed in the ON mode, the lamp switch set in the auto position and the low beam illuminated, lock the doors after switching to OFF mode, and the lights will illuminate for a period and then automatically goes off when unlocking the doors again. You can set the on and off illuminated entry function and illuminating time in the vehicle settings of the multimedia system. (Refer to P.226)

Corner lamp



When the vehicle is running at low speed with the headlamps illuminated, the driver operates the turn signal switch or operates the steering wheel to turn, the corresponding side corner lamp will illuminate automatically to assist the driver in driving. When shifting to the R gear, the driver operates the turn signal switch or operates the steering wheel to turn, the corner lamps on both sides of the vehicle will illuminate at the same time to improve the lighting effect of the surrounding area when reversing.

4-3. Operating lights and wipers

Adaptive driving beam (ADB) *

The LED MATRIX can automatically control the corresponding LED particles in the high beam to turn on or off according to the surrounding road conditions when the vehicle speed is greater than 40 km/h, thus providing the best view and ensuring the driving safety.

Intelligent high beam control (IHC) indicator

- When the LED MATRIX system working indicator  (white) on the instrument cluster multi-function display lights up, it indicates that the IHC is on but not met in working conditions and is standby.
- When the LED MATRIX system working indicator  (blue) on the multi-function display of the instrument cluster lights up, it indicates that the IHC is on and working.

IHC ON / OFF

You can set the on and off IHC in the vehicle settings of the multimedia system. (Refer to P.226)

■ IHC working preconditions:

When all the following conditions are met, the IHC system can work normally.

- The intelligent high beam is set to ON in the multimedia system.
- The power (ignition) switch is switched to ON.
- The headlamp switch is placed at AUTO.
- The high beam handle is in the "high beam off" position.
- The rain & light sensor
- The ADB system.

■ IHC standby conditions:

When any of the following conditions is met, the system enters the standby state, and the high beam is completely turned off.

- The speed of the vehicle is less than 20 km/h.
- There are too many obstacles ahead, and LED MATRIX has failed to adjust adaptively.
- The low beam is turned off (automatically turns off at AUTO, not manually turned off).
- The system recognizes that the environment is foggy.
- The area in front of the vehicle is not dark.

■ IHC working conditions:

When all the following conditions are met, the system enters the working state, the high beam is turned on, and the lighting area is automatically adjusted.

- The speed of the vehicle is more than 40km/h.
- The low beam is turned on (automatically turns on at AUTO, not manually turned on);
- The system recognizes that the environment is foggy.

4-3. Operating lights and wipers

- The area in front of the vehicle is dark.
- There is no vehicle ahead with tail lamps on.
- There is no oncoming vehicle with headlamps on.
- There is no traffic sign on the road ahead.
- **The system may not be able to accurately detect the surrounding brightness level under the following conditions, which may result in the IHC system not working properly. In this case, please switch the high beam and low beam manually.**
 - The rain & light sensor or advanced driver assistance system camera is faulty.
 - The front windshield becomes blurred from moisture, ice, dirt, etc.
 - The front windshield is broken or damaged.
 - The front view is not clear due to fog, heavy rain, snow, etc.
 - The camera is deformed or dirty.
 - Camera temperature is extremely high.
 - Ambient brightness is equivalent to the brightness of the headlights, taillights, or fog lights.
 - The headlights or taillights of the vehicle in front are off, dirty, changing color, not properly aligned, or lit singly.
 - Driving through areas of intermittent changes in light and darkness.
 - Driving frequently or repeatedly on uphill and downhill roads, bumpy roads, or uneven surfaces (e.g., stone paved roads, gravel roads, etc.).
 - Turning or driving frequently or repeatedly on winding roads.
 - There are highly reflective objects in front of the vehicle, such as signs or mirrors.
 - There is high reflectivity on the back of the vehicle in front, such as a container on a truck.
 - When reflections exist on roads such as wet roads, snow, or icy roads.
 - The headlights of the vehicle are damaged, dirty, or not properly aligned.
 - The vehicle opposite turns off its headlights and turns on its fog lights.
 - The vehicle leans due to deflated tires, tractor trailers, etc.
 - High beam and low beam switch repeatedly in an abnormal manner.
 - There is a light in front of the vehicle that is similar to a headlight or taillight.



WARNING

- **Do not rely too much on automatic high beam. Always drive safely, be aware of your surroundings and, if necessary, turn your high beams on or off manually.**
- **Clean the camera's field of view regularly**

4-3. Operating lights and wipers

Fog lamp switch

Fog lamps improve visibility in adverse driving conditions, such as rain or fogging.

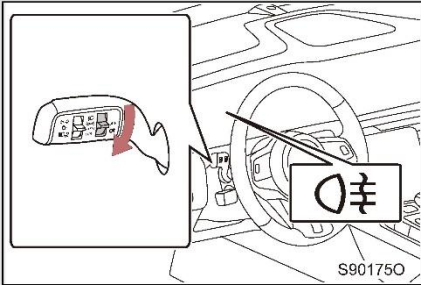

Toggle the fog lamp switch down to turn on the rear fog lamp, toggle the switch again to turn off the rear fog lamp

■ Working conditions of fog lamps

The power(ignition) switch is in the ON mode, and the headlamps are turned on.

4-3. Operating lights and wipers Front windshield wiper and washer

When the wiper control handle is in the **AUTO** position, the wiper will automatically wipe water if the light and rain sensor detects rain. The system automatically adjusts the wiper speed according to the amount of rain and vehicle speed.

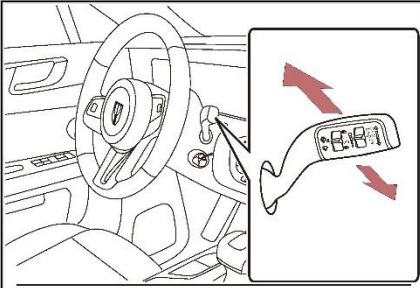

- 1** Wiper AUTO - automatically adjusts the wiper speed according to the amount of rain.
- 2** LO — Wipe at low speed.
- 3** HI — Wipe at high speed.
- 4** Wiper MIST - 1 cycle of low-speed wiper.

When the hood is open, the wiper will not work even if the control handle is pulled.

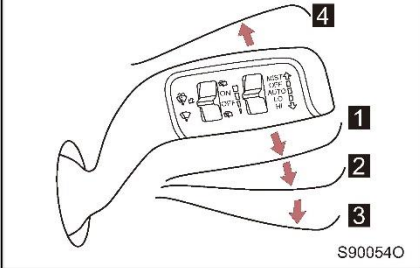

S90054O

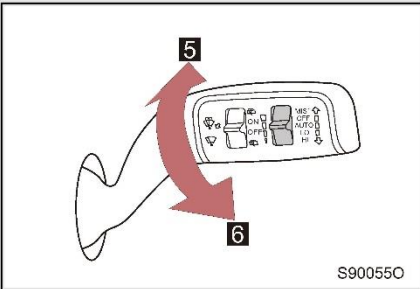

- 5** Rain sensing sensitivity is increased.
- 6** Rain sensing sensitivity is reduced.

S90055O

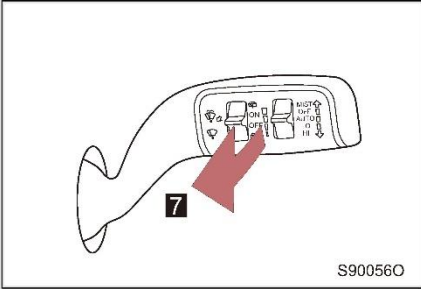

- 7** Washing/wiping operation
Pull back the wiper control handle to wash the front windshield.

■ **Front windshield wiper and washer working conditions**

The power(ignition) switch is in ON mode and the engine hood is closed.

■ **Light and rain sensor**

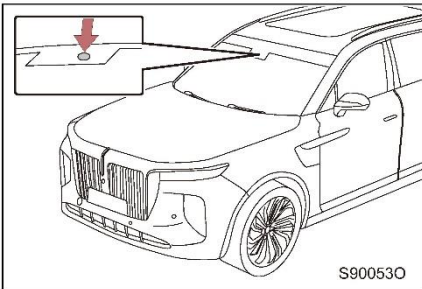

The light and rain sensor determines the amount of rain.

■ **If the windshield washer fluid cannot be sprayed**

Check whether there is washer fluid in the windshield washer fluid tank.

Check and make sure the washer nozzle is not blocked.

■ **If the front windshield wiper blade needs to be replaced**

- Set the wiper to the maintenance position in the vehicle settings of the multimedia system. (Refer to P.222)
- Turn off the power(ignition) switch and switch the wiper control handle to MIST position within 10s to set the wiper to the maintenance position.
- When the wiper is at the maintenance position, set the power (ignition) switch to ON mode, operate the wiper control handle to a position other than MIST or turn off the wiper maintenance position in the vehicle settings of the multimedia system to exit the maintenance position.



WARNING

■ **Warning for using the front windshield wiper in AUTO mode**

In AUTO mode, the front windshield wiper may work unexpectedly if the sensor is touched, the interior rearview mirror is forced to move, or the front windshield is subjected to strong vibrations (for example, the windshield is forced to knock). Be careful that your fingers or anything else does not get caught in the front windshield wiper.

■ **Precautions for using the washer fluid**

In cold weather, do not use washer fluid until the front windshield is warmed up. The washer fluid may freeze on the front windshield, resulting in the reduced visibility. This may cause an accident, which can lead to serious injury or even death.

■ **Only windshield washer fluid filled in the washer fluid reservoir**

It is very dangerous to use the engine coolant as washer fluid. If you spray it on the windshield, it will stain the windshield, obstruct your sight and may cause an accident.

■ **Use the windshield washer fluid mixed with antifreeze protective agent in freezing weather**

It is very dangerous to use windshield washer fluid that does not contain antifreeze protective agent in freezing weather. Because it may freeze on the windshield, obstruct your sight and cause an accident. In addition, make sure to operate the defroster to fully heat the windshield before spraying the washer fluid.

■ **Replace the wiper blade in time**

The use of worn or dirty wiper blades will greatly reduce the clarity of the front view and affect the driving safety. Therefore, wiper blades that are damaged or worn and failed to operate normally must be replaced in time.



Notice

■ **When the front windshield is dry**

Do not use the wiper, otherwise the wiper blade may be damaged.

■ **When the nozzle does not emit washer fluid**

If the wiper control handle is pulled back and held for a long time, the washer fluid pump may be damaged.

■ **When the nozzle is clogged**

Do not use a needle or other object to remove foreign objects by yourself, as this will damage the nozzle.

4-3. Operating lights and wipers

Rear windshield wiper and washer

The wiper and washer can be operated by rolling the rear windshield wiper control handle to different positions.

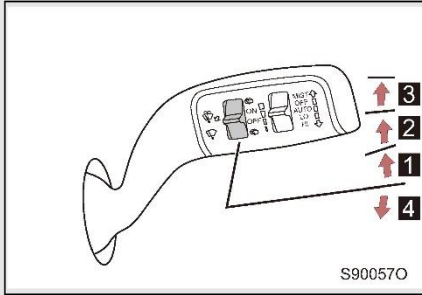

- 1** Turn off.
- 2** Turn on the rear wiper.
- 3** Washing operation.
After releasing the control handle, the wiper position is automatically reset.
- 4** Washing/wiping operation
After releasing the control handle, the off position is automatically reset.

■ Rear windshield wiper and washer working conditions

The power(ignition) switch is placed in the ON mode and the trunk lid is in the closed state.

■ Automatic wiping in R gear

When the front windshield wiper is working, the rear windshield wiper is automatically turned on after the R gear is shifted.

■ If the windshield washer fluid cannot be sprayed

Check whether there is washer fluid in the windshield washer fluid tank. Check and make sure the washer nozzle is not blocked.

WARNING

- **It is forbidden to use windshield washer fluid with ethanol content exceeding 10%**

In a high temperature environment, the windshield washer fluid with ethanol content exceeding 10% will corrode the tail lamps and cause cracks.

Notice

■ When the rear windshield is dry

Do not use the wiper, otherwise the wiper blade may be damaged.

■ When the nozzle does not emit washer fluid

If the wiper control handle is rolled to washing position and held for a long time, the washer fluid pump may be damaged.

■ When the nozzle is clogged

Do not use a needle or other object to remove foreign objects by yourself, as this will damage the nozzle.

4-4. Charging port cover

Open charging port cover

Perform the following steps to open or close the charging port cover.

■ Open charging port cover

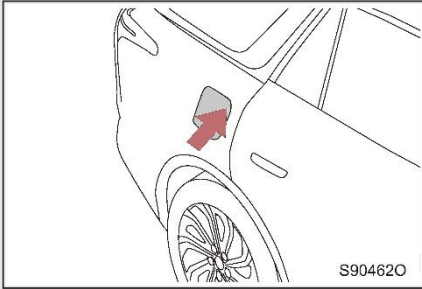

Method 2: When the vehicle is locked and the power (ignition) switch is set to OFF mode, carry your smart key with you, press the front end of the charging port cover, and it will open automatically; when the vehicle is unlocked, press the front end of the charging port cover, and it will open automatically.



Method 1: Touch the charging port cover switch in the charging settings of the multimedia system, and the charging port cover will open automatically.

■ Release the charging gun and close the charging port cover

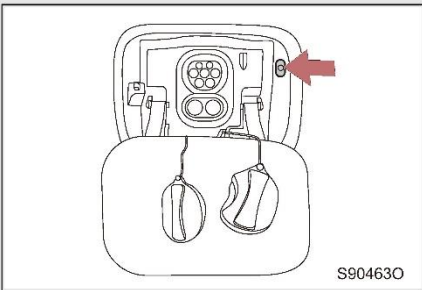

Method 1:

Step 1:

Press the open/close button to finish charging/discharging

Step 2:

Press the open/close button again to unlock the charging lock.

Step 3:

Press again to close the charging port



Method 2: When the charging port cover is opened, touch the charging port cover switch in the charging settings of the multimedia system, and the charging port cover will automatically close.

Notice

■ Precautions for opening/closing the charging port cover

- Do not push or pull forcefully during the opening and closing of the charging port cover, so as not to damage the charging port cover.
- When the charging port cover fails to reach the desired position, works reversely or does not act during the opening/closing, you can press and hold the open/close button for 3 s to initialize. If the problem still cannot be solved after initialization, please contact the authorized FAW Hongqi dealer.
- When the charging port cover cannot be opened due to icing around the cover caused by freezing rain, melting snow, or car washing, it is recommended to move the vehicle to a warm environment to defrost and turn it on. If you cannot solve the problem, please contact the authorized FAW Hongqi dealer.

4-5. Operating other driving systems Adaptive Cruise Control (ACC) *

Adaptive Cruise Control (ACC) can control the speed of the vehicle and the distance from the target vehicle in a range of 0-140 km/h in an integrated manner, thus reducing the driver's burden and increasing driving comfort. In addition, the system can automatically switch between Cruise Control System (CCS) and Following Cruise Control (FCC) depending on whether there is a moving vehicle ahead. Due to the complexity of the actual driving environment, in some cases, the driver can also intervene in the vehicle at any time as needed to actively manipulate the distance between the vehicle and the target vehicle, and ACC will prompt the driver with an audible and visual alarm if necessary.

- If ACC detects that the distance between vehicles is less than the set following distance, the vehicle will automatically slow down; if the vehicle ahead accelerates, or moves out of the lane, the vehicle can accelerate to the set cruising speed. When the vehicle is in dense fog, rain, snow and other weather conditions, or there are frost and dirty marks in the camera window area of the advanced DAS, or when the vehicle is driving towards the sun (or strong light source) and the SACC/ACC cannot work at this time.

Adaptive cruise control (ACC) settings



Turn on the cruise function and set it to adaptive cruise in the settings of the multimedia system.

The cruise mode can only be set when the system is inactivated.

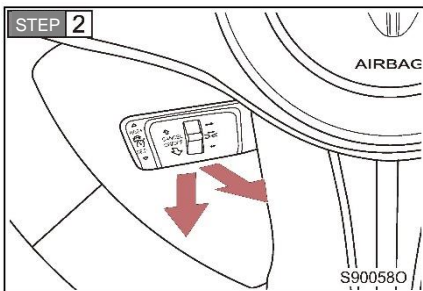

When the ACC indicator on the instrument cluster lights up in white, accelerate or decelerate to the required speed, and move the cruise control handle down to the "SET-" position or pull the cruise control handle toward you to the "ON/OFF" position and release the handle, the ACC indicator lights up in green, and the current vehicle speed is set as the cruise speed.

■ Adjusting the speed

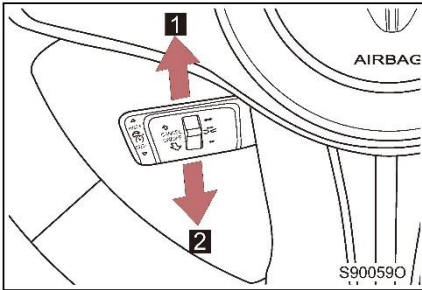

1 Increase the speed
Toggle and Release: toggle once to increase speed by 5 km/h.

Toggle and Hold: After the system confirms the validity of Toggle and Hold, it will increase by 1 km/h continuously.

2 Decrease the speed

Toggle and release: toggle once to decrease speed by 5 km/h.

Toggle and Hold: After the system confirms the validity of Toggle and Hold, it will decrease by 1 km/h continuously.

Note: When toggling and releasing, if the current set speed does not meet the multiplier of 5, the adjustment will first automatically change to a multiplier of 5.

■ Setting the following distance

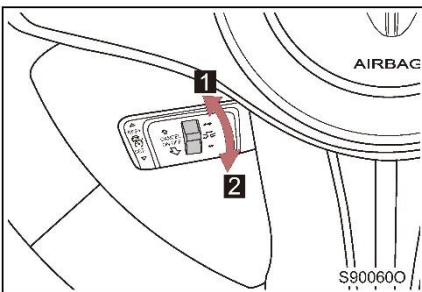

1 Increase the following distance

2 Decrease the following distance

The system provides 4 distance modes, and each toggle of the control handle enables 1 mode to be switched.



1 Set cruise speed

2 ACC indicator

White: The system is turned on, the setting conditions are met, and the cruise setting can be performed.

Green: The system is working and enters the cruise state.

3 Set following distance

The default following distance is "Spacing 4".

Canceling and restoring ACC

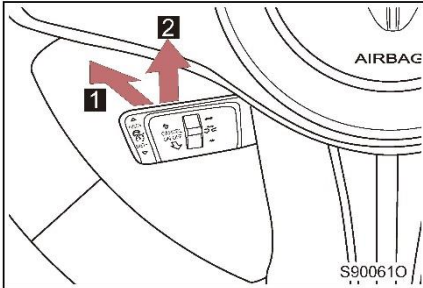

- 1** Cancel
Depress the brake pedal or push the cruise control handle to the "CANCEL" position and release it to cancel cruise control.
- 2** Restore
To restore cruise control and return to set speed, toggle the control handle up to the "RES+" position and release it to restore cruise control.

■ Noise during ACC auto deceleration

It is normal that noise may be generated when ACC is performing automatic deceleration.

■ Following distance

The default following distance is "Spacing 4".

■ Cruise control setting conditions

- ESC function is on.
- All doors and engine hood are closed.
- The driver fastens his seat belt.
- The gear is in D.
- The driver does not depress the brake pedal.
- The advanced driver assistance system camera is not covered
- ACC/ESC/AEB/TCS/ABS/HCU
- AEB/APA is not activated.

■ Conditions for cancellation of cruise

- The cruise control handle is set to the "CANCEL".
- Depress the brake pedal or apply the electronic parking brake.
- Any door or engine hood is opened.
- The driver unbuckles the seat belt.
- The accelerator pedal is depressed for more than 1 min.
- When the gear is shifted to a gear other than D.
- ESC is turned off.
- ABS/TCS/ESC is activated.
- AEB/APA is activated.
- System related functions are faulty.

■ ACC system failure

In case of ACC system failure alarm, please contact the authorized FAW Hongqi dealer to check the vehicle.

■ After turning off the power(ignition) switch

When the power(ignition) switch is turned off, the set cruise speed or following distance is deleted.

■ Adjusting or calibrating the ACC system

Please adjust or calibrate the ACC system in the following cases, otherwise the ACC system may not work properly.

- The front windshield is damaged or replaced.
- The advanced DAS camera unit or forward millimeter wave radar positioning bracket is removed or installed.
- The vehicle is adjusted after four wheel alignment.
- The front bumper is hit or deformed. Please contact an authorized FAW Hongqi dealer.



WARNING

- **For the purpose of driving safety, it is recommended not to set the cruise speed at a value more than 140 km/h, as this is very dangerous. The driver should drive the vehicle actively.**
- **Prevent accidental activation of ACC**
The ACC system should be deactivated if not used.
- **Circumstances in which it is not appropriate to use ACC**
To avoid loss of vehicle control and serious injury or death, do not use ACC in any of the following cases:
 - When there is traffic congestion.
 - When road conditions are complicated.
 - When making sharp turns.
 - On winding roads.
 - On slippery road surfaces (such as rain or snow).
 - On steep hillsides.
 - When there is a stationary obstacle in front of the vehicle.
 - When snow, rain, ice, fog and other weather.
 - At night when the lighting on the road is insufficient.
- **The driver is the primary controller of the vehicle and his or her control of the vehicle takes precedence over the ACC system. That is, when the vehicle is in adaptive cruise control, when the driver depresses the accelerator pedal and brake pedal, the control of the vehicle will be given to the driver, who must maintain control of the vehicle at all times and has full responsibility for the vehicle.**
- **ACC is only a driving assistance system, and the driver should disengage the ACC function immediately if necessary and drive on his or her own. When using ACC, please must comply with the relevant local regulations and adapt to the prevailing traffic, road and weather conditions.**



WARNING

- The front windshield must not be modified or covered by any auxiliary equipment, otherwise ACC may not work properly.
- When leaving the driver's seat for a long time, make sure to turn off ACC to avoid accident caused by misoperation.
- When this vehicle is following the target vehicle, ACC mainly controls the following distance, and the actual speed of this vehicle may be lower than the set cruising speed.
- During ACC, when the vehicle is too close to the vehicle in front (for example, due to the sudden emergency braking of the vehicle in front), the system will send an audible and visual alarm alert to the driver through the instrument cluster, and then the driver should pay attention to the distance and take over the vehicle control.
- When the driver presses the accelerator pedal to actively accelerate, the cruise speed icon displayed on the instrument cluster multi-function display will flash, which is a normal phenomenon. Meanwhile, when the driver releases the accelerator pedal and then immediately toggles the cruise handle "SET-", the current speed can be set as the targeted cruise speed.
- ACC may lose the target vehicle or misidentify the target vehicle when the vehicle enters or exits a curve, changes lanes, or when the vehicle ahead is stationary.
- ACC can not detect other sides except the rear of the vehicle, children, pedestrians, animals or other objects and apply braking, so it is necessary to drive carefully.
- ACC has limited braking ability and when a vehicle ahead suddenly slows, stops or enters your lane, there may not be time to reduce your speed to avoid a collision with the vehicle ahead. In the event of a perceived danger, please depress the brake pedal actively.
- Driving always requires full attention and you should always be prepared to take action and apply the brakes.
- The driver needs to adjust the following distance and set the ACC system according to the traffic flow ahead and the current weather conditions (e.g. rain and snow). The driver needs to ensure that the vehicle can be slowed to a stop within his or her field of vision at all times.
- ACC can only recognize motor vehicles (such as cars, trucks, etc.) with legal license plates installed and able to drive on the road. If the vehicle in front is irregular in shape, refitted, sprayed and covered, the recognition effect cannot be guaranteed, and the recognition of pedestrians and narrow vehicles (such as bicycles, motorcycles, etc.) cannot be guaranteed. At this time, the driver should take over the vehicle at any time according to the actual situation.
- The ACC system may fail to recognize large trailers accurately, and the driver should control the vehicle at any time according to the actual situation.
- The ACC system cannot accurately determine the passable width of the lane ahead, therefore, when the lane ahead of this car is too narrow and the driver feels that he cannot pass normally, he should immediately disengage the ACC system by brake intervention and control the vehicle by himself.

**WARNING**

- Do not use ACC on larger hills. ACC may not detect vehicles in the same lane, and the driver usually needs to control the acceleration and braking of the vehicle by himself/herself. If braking is applied, ACC is disengaged.
- The vehicle ahead symbol located on the instrument cluster is displayed when a vehicle traveling in the same direction in the same lane is detected. If this symbol display does not correspond to the actual situation observed by the driver, it is the driver's responsibility to take over control and drive the vehicle according to the actual situation.
- If you rest your foot on the accelerator pedal, ACC may not automatically apply the brakes, resulting in a collision with the vehicle ahead, and the driver needs to remain aware.
- The front bumper must not be painted, modified or covered by any auxiliary equipment, as this may result in reduced performance or failure of the forward millimeter wave radar sensor!
- Extreme weather such as severe snow, rain, ice, and dense fog may result in reduced performance or failure of the forward millimeter wave radar sensor. In this case, the driver should turn off the ACC system.
- If the forward millimeter wave radar sensor is displaced by a collision, the ACC may be degraded or malfunction, so the driver should calibrate the forward millimeter wave radar sensor in time.
- Do not use the forward millimeter wave radar sensor that is not properly calibrated.
- If the vehicles in the adjacent lane do not enter the monitoring area when approaching the front of the subject vehicle's direction of travel, the system may not detect these vehicles, resulting in a lag in ACC response. The driver needs to pay close attention to the movements of vehicles in adjacent lanes and should intervene proactively if necessary.
- If the vehicle in front brakes suddenly (emergency stop), ACC may not be able to react or may be too slow to react to the vehicle in front, resulting in the risk of late braking. In this case, the driver may not receive a takeover request. The driver needs to remain aware and intervene proactively if necessary.
- When the ACC follows the target vehicle to a stop, the vehicle may start suddenly because the target vehicle is blocked or pedestrians pass by. The driver needs to remain aware and intervene proactively if necessary.



Notice

- **ACC will keep the set following distance to follow the target, if the target vehicle slows down and stops, ACC will control this vehicle to slow down and stop automatically.**
- **When the target vehicle stops for less than 3s and re-starts or leaves the lane, this vehicle will automatically start under the control of ACC.**
- **When the target vehicle stops for more than 3s but not more than 10min and restarts or leaves the lane, the instrument cluster multi-function display of the vehicle will prompt the information of resuming cruise, and the driver can resume ACC function by lightly pressing the accelerator pedal or toggling the cruise control handle to "RES+" to realize automatic starting. At this time, the driver should pay attention to judge whether it is safe to start.**
- **ACC will be disengaged automatically when this vehicle is stopped for more than 10min.**
- **ACC does not keep the vehicle in the braking state for a long time. Do not leave the vehicle while ACC keeps the vehicle at a stop. Always put the vehicle in P gear before leaving the vehicle.**
- **The following should be noted when using ACC to cross curves:**
 - In corners, ACC may exit or perform speed limits.
 - On curves, ACC may react to a vehicle in another lane or may not have time to react to a vehicle in the same lane and may collide with the vehicle ahead or lose control of the vehicle, especially when driving in an on-ramp may cause the system to lose its target and thus accelerate due to excessive curves. Pay extra attention on curves and be prepared to apply the brakes if necessary, and choose the appropriate speed when driving on curves.
- **When the vehicle follows the vehicle ahead to pass the intersection with traffic lights, the driver should pay attention to the traffic light change and take the initiative to intervene in the vehicle when necessary to avoid violating traffic rules.**
- **When the vehicle is in dense fog, rain, sun, snow and other weather conditions, or there are frost and dirty marks in the camera window area of the advanced DAS, or when the vehicle is driving towards the sun (or strong light source), the camera may report "The camera of the advanced DAS is blocked, please clean the windshield" through the instrument cluster due to "limited vision", and the ACC cannot work at this time.**

4-5. Operating other driving systems Super adaptive cruise control (SACC)*

Based on the ACC, SACC can not only perform cruise and follow-up functions, but also recognize the lane line through the advanced DAS camera, and control the vehicle to drive along the center line of the lane, improving driving comfort and safety.

If SACC detects that the distance between vehicles is less than the set following distance, the vehicle will automatically slow down; if the vehicle ahead accelerates, or moves out of the lane, the vehicle can accelerate to the set cruising speed.

SACC settings



Turn on the cruise function and set it to SACC in the settings of the multimedia system.

The cruise mode can only be set when the system is inactivated.

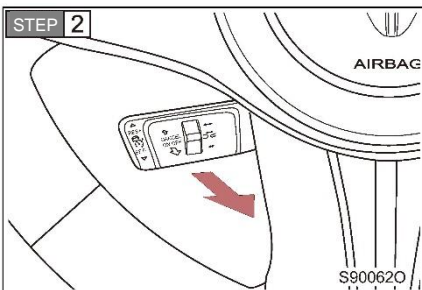

When the SACC indicator on the instrument cluster lights up in white, accelerate or decelerate to the required speed, and pull the cruise control handle backward successively for two times to the "ON/OFF" position and then release the handle, the SACC indicator will light up in green, and the current vehicle speed can be set as the cruise speed.

4-5. Operating other driving systems

■ Adjusting the speed

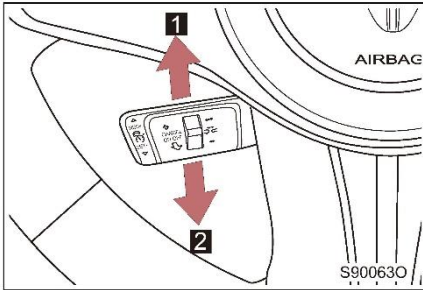

1 Increase the speed
Toggle and Release: toggle once to increase speed by 5 km/h.

Toggle and Hold: After the system confirms the validity of Toggle and Hold, it will increase by 1 km/h continuously.

2 Decrease the speed

Toggle and release: toggle once to decrease speed by 5 km/h.

Toggle and Hold: After the system confirms the validity of Toggle and Hold, it will decrease by 1 km/h continuously.

Note: When toggling and releasing, if the current set speed does not meet the multiplier of 5, the adjustment will first automatically change to a multiplier of 5.

■ Setting the following distance

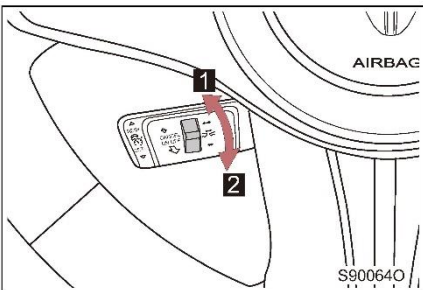

1 Increase the following distance

2 Decrease the following distance

The system provides 4 distance modes, and each toggle of the control handle enables 1 mode to be switched.

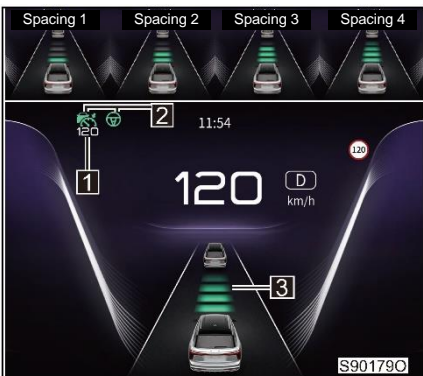

1 Set cruise speed

2 SACC indicator

(Off) (off): The system is in standby and does not meet the setting conditions.

(Off) (white): The system is activated and the ACC setting can be performed.

(White) (white): The system is activated and the SACC setting can be performed.

(Off) (green): The system is working and enters the ACC mode.

(Green) (green): The system is working and enters the SACC mode.

3 Set following distance

The default following distance is "Spacing 4".

Canceling SACC

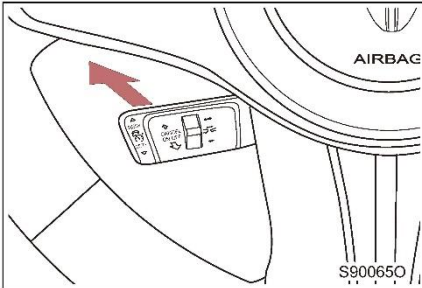

Depress the brake pedal or push the cruise control handle to the "CANCEL" position and release it to cancel cruise control.

■ Switching between SACC and ACC

When ACC is working and the conditions for setting SACC are met, pull the cruise control handle backward successively for two times to the "ON/OFF" position to switch to SACC mode.

When SACC is working, if the driver operates the steering wheel or turn signal lamp switch, it will automatically switch to ACC mode.

When SACC is working, if the camera failed to recognize the lane line ahead, it will automatically switch to ACC mode.

When SACC is working, if a sharp curve suddenly appears, it will automatically switch to ACC mode.

When SACC is working, if the camera detects that the lane line is too wide or too narrow, it will automatically switch to ACC mode.

■ Noise during SACC auto deceleration

It is normal that noise may be generated when SACC is performing automatic deceleration.

■ Following distance

The default following distance is "Spacing 4".

■ Conditions for setting SACC

- ESC function is on.
- The cruise mode is set to SACC in the multimedia system.
- All doors and engine hood are closed.
- The driver fastens his seat belt.
- The gear is in D.
- The brake pedal is not depressed.
- The advanced driver assistance system camera is not covered
- The lane lines are clear and meet the requirements of national standards.
- SACC/ESC/AEB/TCS/ABS/EPS/HCU
- AEB/APA is not activated.

4-5. Operating other driving systems

■ Conditions for suspending SACC

- If the vehicle needs to overtake, depress the accelerator pedal deeply for no more than 1 min and resume SACC after releasing the accelerator pedal.

■ Conditions for canceling SACC

- Operate the cruise control handle to the "CANCEL" position.
- Depress the brake pedal or apply the electronic parking brake.
- Any door or engine hood is opened.
- The driver unbuckles the seat belt.
- The system judges that both hands are off the steering wheel for a certain period of time.
- The accelerator pedal is depressed for more than 1 min.
- When the gear is shifted to a gear other than D.
- ESC is turned off.
- ABS/TCS/ESC is activated.
- AEB/APA is activated.
- System related functions are faulty.

■ SACC system failure

In case of SACC system failure alarm, please contact the authorized Hongqi dealer to check the vehicle.

■ After turning off the power(ignition) switch

When the power(ignition) switch is turned off, the set cruise speed or following distance is deleted.

■ Adjusting or calibrating the SACC system

Please adjust or calibrate the SACC system in the following cases, otherwise the SACC system may not work properly.

- The front windshield is damaged or replaced.
- The advanced DAS camera unit or forward millimeter wave radar positioning bracket is removed or installed.
- The vehicle is adjusted after four wheel alignment.
- The front bumper is hit or deformed.

Please contact an authorized Hongqi dealer.

**WARNING****■ Prevent accidental activation of SACC**

The SACC system should be deactivated if not used.

■ Situations in which the use of SACC is inappropriate

To avoid loss of vehicle control and serious injury or death, do not use SACC in any of the following cases:

- When there is traffic congestion.
- When road conditions are complicated.
- When making sharp turns.
- On winding roads.
- On slippery road surfaces (such as rain or snow).
- On steep hillsides.
- When there is a stationary obstacle in front of the vehicle.
- When snow, rain, ice, fog and other weather.
- At night when the lighting on the road is insufficient.
- The lane lines are not clear.
- **The driver is the primary controller of the vehicle, who is superior to the SACC system. That is, when the vehicle is in super adaptive cruise control, when the driver depresses the accelerator pedal and brake pedal or operates the steering wheel, the control of the vehicle will be given to the driver, who must always maintain control of the vehicle and has full responsibility for the vehicle.**
- **When driving on a repaired asphalt road or a road with strong light reflection, the vehicle may deviate from the driving lane. Exercise extreme caution and control your vehicle actively if necessary.**
- **When SACC is working, the driver should hold the steering wheel firmly with both hands to ensure driving safety.**
- **SACC is only a driving assistance system, and the driver should disengage the SACC function immediately if necessary and drive on his or her own. When using SACC, please must comply with the relevant local regulations and adapt to the prevailing traffic, road and weather conditions.**
- **The front windshield must not be modified or covered by any auxiliary equipment, otherwise SACC may not work properly.**
- **When leaving the driver's seat for a long time, make sure to turn off SACC to avoid accident caused by misoperation.**
- **When this vehicle is following the target vehicle, SACC mainly controls the following distance, and the actual speed of this vehicle may be lower than the set cruising speed.**
- **During SACC, when the vehicle is too close to the vehicle in front (for example, due to the sudden emergency braking of the vehicle in front), the system will send an audible and visual alarm alert to the driver through the instrument cluster, and then the driver should pay attention to the distance and take over the vehicle control.**
- **When the driver controls the steering wheel for a short time or the lane line disappears for a short time, the steering assist indicator on the instrument cluster multi-function display will flash, which is normal.**
- **Do not use the forward millimeter wave radar sensor that is not properly calibrated.**



WARNING

- When the driver presses the accelerator pedal to actively accelerate, the cruise speed icon displayed on the instrument cluster multi-function display will flash, which is a normal phenomenon. Meanwhile, when the driver releases the accelerator pedal and then immediately toggles the cruise handle “SET-”, the current speed can be set as the targeted cruise speed.
- SACC may lose the target vehicle or misidentify the target vehicle when the vehicle enters or exits a curve, changes lanes, or when the vehicle ahead is stationary.
- SACC cannot detect other sides except the rear of the vehicle, children, pedestrians, animals or other objects and apply braking, so it is necessary to drive carefully.
- SACC has limited braking ability and when a vehicle ahead suddenly slows, stops, or enters your lane, there may not be time to reduce your speed to avoid a collision with the vehicle ahead. In the event of a perceived danger, please depress the brake pedal actively.
- Driving always requires full attention and you should always be prepared to act and apply the brakes.
- The driver needs to adjust the following distance and set the SACC system according to the traffic flow ahead and the current weather conditions (e.g., rain and snow). The driver needs to ensure that the vehicle can be always slowed to a stop within his or her field of vision.
- SACC can only recognize motor vehicles (such as cars, trucks, etc.) with legal license plates installed and able to drive on the road. If the vehicle in front is irregular in shape, refitted, sprayed, and covered, the recognition effect cannot be guaranteed, and the recognition of pedestrians and narrow vehicles (such as bicycles, motorcycles, etc.) cannot be guaranteed. At this time, the driver should take over the vehicle at any time according to the actual situation.
- The SACC system may fail to recognize large trailers accurately, and the driver should control the vehicle at any time according to the actual situation.
- The SACC system cannot accurately determine the passable width of the lane ahead, therefore, when the lane ahead of this car is too narrow and the driver feels that he cannot pass normally, he should immediately disengage the SACC system by brake intervention and control the vehicle by himself.
- Do not use SACC on steep slopes. SACC may not detect vehicles in the same lane, and the driver usually needs to control the acceleration and braking of the vehicle by himself/herself. If braking is applied, the SACC will be deactivated.
- The vehicle ahead symbol located on the instrument cluster is displayed when a vehicle traveling in the same direction in the same lane is detected. If this symbol display does not correspond to the actual situation observed by the driver, it is the driver's responsibility to take over control and drive the vehicle according to the actual situation.
- If you rest your foot on the accelerator pedal, SACC may not automatically apply the brakes, resulting in a collision with the vehicle ahead, and the driver needs to remain aware.
- The front bumper must not be painted, modified or covered by any auxiliary equipment, as this may result in reduced performance or failure of the forward millimeter wave radar sensor!
- Extreme weather such as severe snow, rain, sun, ice, and dense fog may result in reduced performance or failure of the forward millimeter wave radar sensor. In this case, the driver should turn off the SACC system.
- If the forward millimeter wave radar sensor is displaced by a collision, the SACC may be degraded or malfunction, so the driver should calibrate the forward millimeter wave radar sensor in time.

**WARNING**

- If the vehicles in the adjacent lane do not enter the monitoring area when approaching the front of the vehicle's direction of travel, the system may not detect these vehicles, resulting in a lag in SACC response. The driver needs to pay close attention to the movements of vehicles in adjacent lanes and should intervene proactively if necessary.
- If the vehicle in front brakes suddenly (emergency stop), SACC may not be able to react or may be too slow to react to the vehicle in front, resulting in the risk of late braking. In this case, the driver may not receive a takeover request. The driver needs to remain aware and intervene proactively if necessary.
- When the SACC follows the target vehicle to a stop, the vehicle may start suddenly because the target vehicle is blocked, or pedestrians pass by. The driver needs to remain aware and intervene proactively if necessary.

**Notice**

- SACC will keep the set following distance to follow the target, if the target vehicle slows down and stops, SACC will control this vehicle to slow down and stop automatically.
- When the target vehicle stops for less than 3 s and re-starts or leaves the lane, this vehicle will automatically start under the control of SACC.
- When the target vehicle stops for more than 3s but not more than 10min and restarts or leaves the lane, the instrument cluster multi-function display of the vehicle will prompt the information of resuming cruise, and the driver can resume SACC function by lightly pressing the accelerator pedal or toggling the cruise control handle to "RES+" to realize automatic starting. At this time, the driver should pay attention to judge whether it is safe to start.
- SACC will be disengaged automatically when this vehicle is stopped for more than 10min.
- SACC does not keep the vehicle in the braking state for a long time. Do not leave the vehicle while SACC keeps the vehicle at a stop. Always put the vehicle in P gear before leaving the vehicle.
- The following should be noted when using SACC to cross curves:
 - In corners, SACC may exit or perform speed limits.
 - On curves, SACC may react to a vehicle in another lane or may not have time to react to a vehicle in the same lane and may collide with the vehicle ahead or lose control of the vehicle, especially when driving in an on-ramp may cause the system to lose its target and thus accelerate due to excessive curves. Pay extra attention on curves and be prepared to apply the brakes if necessary and choose the appropriate speed when driving on curves.
 - In a curve, too small road radius may affect the judgment of SACC on the lane lines. Drive with caution on curves.
- When the vehicle follows the vehicle ahead to pass the intersection with traffic lights, the driver should pay attention to the traffic light change and take the initiative to intervene in the vehicle when necessary to avoid violating traffic rules.
- When the vehicle is in dense fog, rain, snow and other weather conditions, or there are frost and dirty marks in the camera window area of the advanced driver assistance system, or when the vehicle is driving towards the sun (or strong light source), the camera may report "The camera of the advanced driver assistance system is blocked, please clean the windshield" through the instrument cluster due to "limited vision", SACC cannot work at this time.

4-5. Operating other driving systems Front and Rear Parking Sensor (PSS) *

Front and Rear Parking Sensor System (PSS) consists of controller and ultrasonic sensor. The ultrasonic sensor can measure the distance between the vehicle and the obstacle. According to the distance change of the obstacle in the detection area, the speaker will sound with different frequencies, while the audio multimedia display will show the distance and orientation information of the obstacle. When using the system, be sure to be aware of the surrounding area.

■ Sensor type

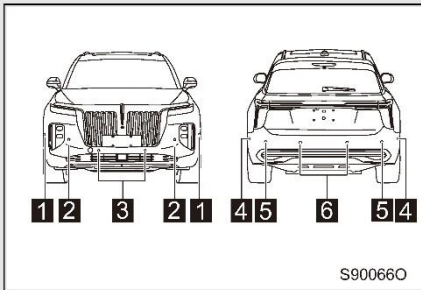

- 1 Front side radar sensor
- 2 Front corner radar sensor
- 3 Front center radar sensor
- 4 Rear side radar sensor
- 5 Rear corner radar sensor
- 6 Rear center radar sensor

■ PDC on/off



When the vehicle speed is less than 15 km/h, press the PDC/RVC ON/OFF button, and it will light up, which indicates that the PDC is turned on; press the PDC/RVC ON/OFF button again, and it will go out, which indicates that the PDC is turned off.

Radars settings

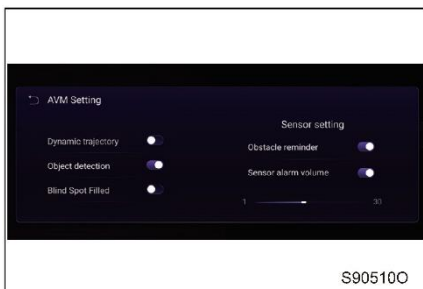

You can set the radar alarm volume and the automatic radar in the AVM interface of the multimedia system.

■ Setting the automatic radar to ON

- With the gear shifted in D/N and the vehicle speed less than 15 km/h, if there is an obstacle within 80 cm, the multimedia display will pop up a radar warning screen. Press the return button to exit the radar warning. At this time, the radar auto-on is turned off during this ignition cycle.

Note: The radar does not alarm when the gear is in N and the vehicle is stationary.

- With the gear shifted to R and the PDC ON, the PDC can be turned off by pressing the PDC/RVC ON/OFF button.
- The PDC, if turned on, will stop working when the vehicle speed is more than 15 km/h, and will resume working when the vehicle speed is less than 10 km/h.

■ Setting the automatic radar to OFF

- With the gear shifted to R and the PDC ON, the PDC can be turned off by pressing the PDC/RVC ON/OFF button.
- When the gear is in R after the system is turned on, the system will stop working when the vehicle speed is higher than 15 km/h, and when the vehicle speed is lower than 10 km/h, the PSS will work again. When the gear is in D, the system will stop working when the vehicle speed is higher than 15 km/h and will not resume automatically.

Display

- When an obstacle is detected

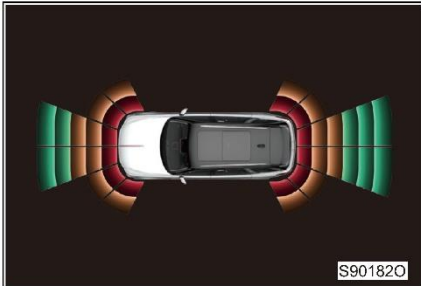

When the radar sensor detects an obstacle, the image will be displayed on the multimedia display according to the position of the obstacle and the distance from the obstacle.

The slow zone, warning zone and danger zone are displayed in green, yellow and red respectively.

Obstacle distance detection

When an obstacle is detected, the color block corresponding to the sensor will light up continuously.

- Information displayed in parking slowdown area of center radar sensor

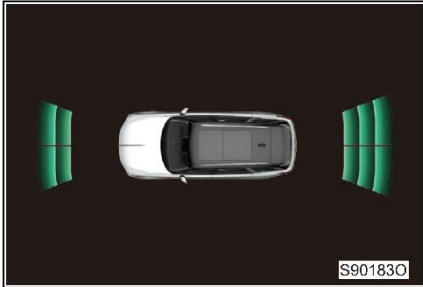

Front center radar sensor
Distance from obstacle 80 - 120cm

Rear center radar sensor
Distance from obstacle 80 - 150cm

If an obstacle is detected within this range, the green block is displayed on the multimedia display and the speaker beeps to warn the driver.

- Information displayed in parking warning area of side/corner radar sensor



Corner radar sensor
Distance from obstacle: 40 - 60cm

Side radar sensor
Distance from obstacle: 30 - 60cm

If an obstacle is detected within this range, the yellow bar will be displayed on the multimedia display and the speaker will buzzer to warn the driver.

- Center radar sensor parking warning zone information display



Center radar sensor
Distance from obstacle: 40 - 80cm

If an obstacle is detected within this range, the yellow bar will be displayed on the multimedia display and the speaker will buzzer to warn the driver.

■ Radar sensor parking danger zone information display



Center/corner radar sensor

Distance from obstacle: 1 - 40cm

Side radar sensor

Distance from obstacle: 1 - 30cm

If an obstacle is detected within this range, the red block on the multimedia display lights up and the speaker beeps to warn the driver.

Farthest distance detected by sensor

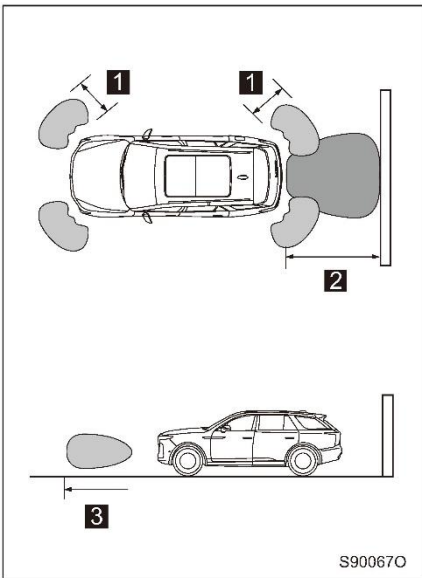

1 Approx. 60cm

2 Approx. 150cm

3 Approx. 120cm

The figure shows the farthest distance detected by the radar sensor. (Note that radar sensor does not detect obstacles extremely close to the vehicle.) Depending on the shape of the obstacle, the detection range of the radar sensor may vary.

■ Sensor detection information

- Certain vehicle conditions and surroundings may affect the sensor's ability to correctly detect obstacles. For example:
 - Dirt, snow or ice on the sensor.
 - The sensor is covered.
 - The vehicle is significantly tilted sideways.
 - On particularly bumpy roads, slopes, gravel surfaces or grass.
 - The vicinity of the vehicle is very noisy due to the sound of vehicle horns, motorcycle engines, air brakes of large vehicles or other strong noises that produce ultrasonic waves.

4-5. Operating other driving systems

- There is another vehicle equipped with parking assist sensors nearby and the sensors in that vehicle are working.
- The vehicle is equipped with a wing antenna mast or wireless antenna.
- The vehicle is fitted with a traction ring.
- The bumper or sensor has been subjected to a strong impact.
- The vehicle is approaching a high or curvy curb.
- In hot sun or severe cold weather.

In addition to the above, traffic signs and other objects may sometimes be judged by sensors to be closer than they actually are due to their shape.

- The shape of the obstacle may prevent the sensor from detecting it. Pay particular attention to the following obstacles.
 - Electric wires, fences, ropes, etc.
 - Cotton, snow and other materials that absorb radio waves.
 - Objects with sharp edges.
 - Low obstacles.
 - High obstacles with the upper part reaching outward in the direction of your vehicle.



WARNING

■ Warning for using front and rear PDC

To avoid an accident, please observe the following precautions:

- Do not attach any objects within the working range of the sensor.
- PSS is only a driver assistance system, so do not over-rely on it and the driver must drive carefully. If necessary, actively intervene in the vehicle to avoid danger.
- The driver is the primary controller of the vehicle and must maintain control of the vehicle at all times and has full responsibility for the vehicle.
- When the vehicle speed is too fast, the system will quit working, and the driver should drive carefully.



Notice

■ Precautions when washing your car

Do not rinse with water or steam against the sensor area. Otherwise, it may cause the sensor to malfunction.

4-5. Operating other driving systems AVM system

The Around View Monitor (AVM) system is displayed through the multimedia system display, which makes it easy for the driver to clearly view and understand the surrounding conditions of the vehicle, as well as make judgments about the relative orientation and distance of obstacles to achieve safe and easy parking.

The screen images used in this section are for example only and may differ from the images actually displayed on the vehicle.

Activating and deactivating the AVM system

■ Activating

There are two ways to access the AVM system.

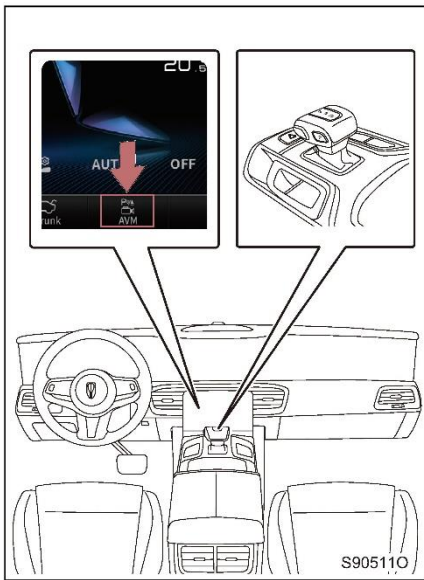

Method 1: When the gear position is in R, the AVM system is activated.

Method 2: When the vehicle speed is less than 15km/h, press the PDC/RVC ON/OFF button to activate the AVM system.

■ Deactivating

When the vehicle speed is more than 15 km/h, press the PDC/RVC ON/OFF button, touch **X** button on the display or shift the gear to D, and the AVM system will be deactivated.

AVM system screen mode

The AVM system has a variety of screen modes, and the driver can select the appropriate mode according to his/her needs.

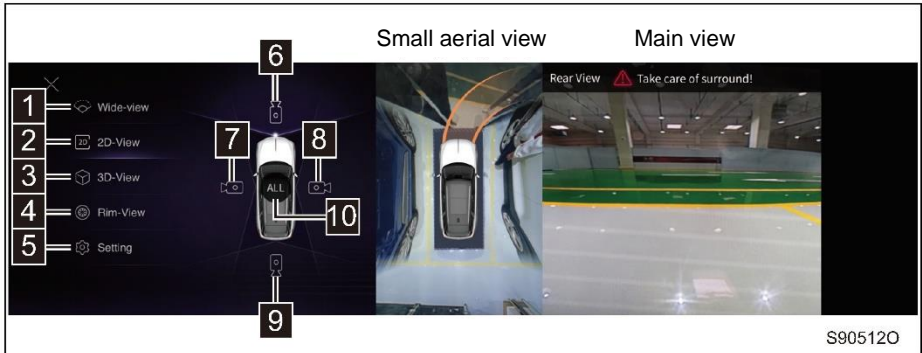

1 Wide-angle view

It is optional in the front and rear-view modes and after selecting, switch the main view and small aerial view to wide-angle view, in which you can see a nearly 180° picture.

2 2D view

Display plane images, and you can view front view, rear view, left view, right view, and big aerial view in 2D mode.

3 3D view

Display the 360-degree stereo image around the vehicle and drag to display.

4 Tire view

It is optional in front and rear-view modes and after selecting, the left view, right view and small aerial view can be displayed.

5 Setting

The alarm sound on/off, dynamic track route, object detection, underbody blind spot assist, automatic radar and radar alarm volume can be set.

- Alarm sound on/off: You can turn on or off the radar alarm sound during reversing.
- Dynamic track route: After selecting, the parking assist lines will be displayed.
- Object detection: After turning on, it can detect the dynamic objects within 3m in the front and rear of the vehicle and 5m to the left and right.
- Blind spot assist: After turning on, as the vehicle moves, the blind spot at the underside of the vehicle is filled with visual images to achieve the effect of visual underside.
- Automatic radar: You can decide whether to turn on the alarm automatically while driving.
- Radar alarm volume: You can drag to adjust the volume of the radar alarm sound
- Activate the 360° camera using the turn signal lever at speeds below 15km/h

- 6** Front view
Show the front view and small aerial view;
- 7** Left view
Show the left view and small aerial view;
- 8** Right view
Show the right view and small aerial view;
- 9** Rear view
Show the rear view and small aerial view;
- 10** Big aerial view
Switch the main view and small aerial view to big aerial view.

When the turn signal lamp is turned on, the picture mode is automatically converted to the corresponding left and right view and the small aerial view. When the turn signal lamp is turned off, the previously selected picture mode will be resumed.

Parking assist lines

The screen display assists the driver to complete parking and dynamically adjust the parking guideline according to the different angles of the vehicle.

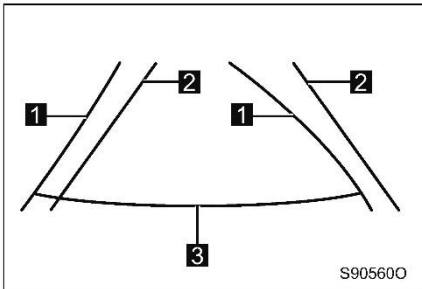

- 1** Dynamic track route (orange)
Indicates the expected driving trajectory line that follows the steering wheel rotation.
- 2** Static track route (white)
Indicates the 300cm distance from the width guideline to the rear edge of bumper.
- 3** Distance guideline (red)
Indicates the distance line 50cm from the rear edge of the bumper.

Around view camera

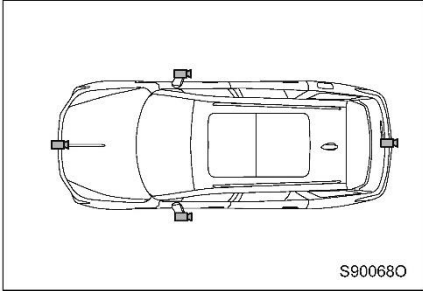

Around view cameras are mounted on the front grille, trunk lid, and left and right exterior mirrors.

When the images cannot be spliced normally due to door opening, the corresponding area is grayed out for prompting. When the camera cannot transmit images normally, the corresponding area is blacked out with a prompt message.

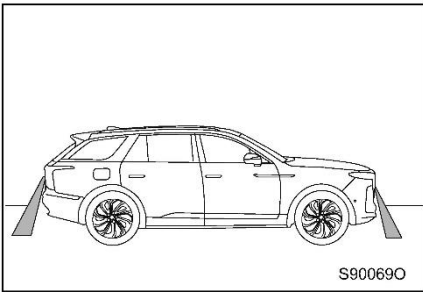

The camera has a limited area to monitor. Objects near the corner of the bumper or under the bumper are not displayed on the screen.

The area displayed on the screen may change depending on the direction of the vehicle or road conditions.

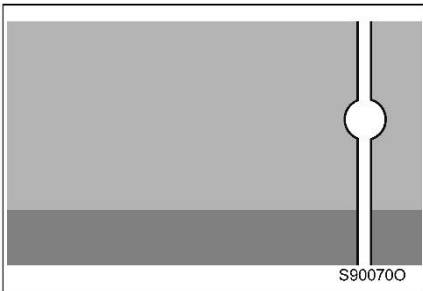

If the camera receives strong light (e.g., sunlight reflected by the body), a trailing effect specific to the camera may occur *¹.

*¹: When the image is transmitted with the camera, the light source appears to have a vertical streak extending up and down.

**WARNING**

- **AVM is only a driver assistance system, so do not over-rely on it.**

- The driver is the primary controller of the vehicle and must maintain control of the vehicle at all times and has full responsibility for the vehicle.
- Be sure to drive carefully and visually confirm the situation around the vehicle. It is very dangerous to reverse only by observing the display screen, which may lead to accidents or collision with objects. AVM is only a visual assistant system. The image on the display may differ from the actual situation.

- **When using the AVM system**

Please observe the following precautions to avoid causing serious injury or even death.

- Do not rely solely on the AVM system when reversing.
- Always check visually and through the rearview mirror to confirm that the selected path is clear.
- The displayed distance between an object and a plane is different from the actual distance.
- The aerial view of AVM system only shows objects that are close by, and the cameras do not show objects that are outside the field of view.
- The object detector only detects low-speed moving objects. There is a possibility of missed detection. Please stay alert during driving.
- Do not use this system when the cameras do not work properly.

- **Conditions affecting the AVM system**

- The camera position and mounting angle may change if the vehicle is involved in a collision. Please contact the authorized FAW Hongqi dealer to check the vehicle.
- This system may not work properly if there is a drastic change in temperature, for example, if hot water is poured on the vehicle in cold weather.
- If the camera becomes dirty, it will not transmit a clear image. Rinse it with water and wipe with a soft cloth. If the camera is very dirty, clean it with a neutral cleaner and wipe it off.
- When the system temperature is low, the displayed image may be darkened and the moving image may be slightly distorted.
- The camera image may not be clear in rain, snow, fog and low visibility.
- Situations in which the use of AVM system is inappropriate
 - On icy, slick or snowy roads.
 - When using tire chains or emergency spare tires.
 - On rough or uneven roads, such as at corners or on slopes.
- If the tires are replaced, the guide line shown on the display may be deviated. For more information about changing tires, please contact the authorized FAW Hongqi dealer.
- Depending on the vehicle (number of occupants, amount of luggage, etc.), the position of the guide line displayed on the display may change. Be sure to visually check the back of the vehicle and the surrounding area before operating.

4-5. Operating other driving systems Tire Pressure Management System (TPMS)

Tire Pressure Management System (TPMS) can monitor and view the tire pressure, and automatically alarm when the pressure is below the limit.

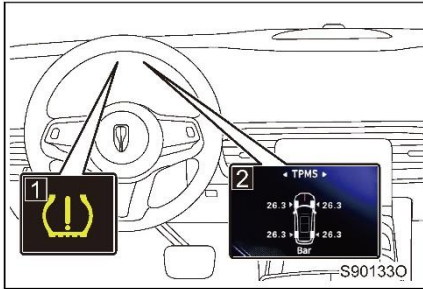

- 1** Tire pressure abnormality/system fault alarm lamp
- 2** Tire pressure information

System operation

Vehicle status	Call the police
The tire pressure is abnormal	System MIL makes an alarm
The TPMS is not working	The system MIL lights up with a message to prompt that the tire pressure monitoring is failed.

■ Matching of tire pressure sensor

The TPMS needs to be configured after changing wheels or performing the tire rotation. Please contact the authorized FAW Hongqi dealer if necessary.

**WARNING****■ Precautions for TPMS**

- The system does not prevent tire leaks and blowouts; its main function is to give an alarm when the tire pressure value is monitored below a certain set point.
- In winter, tire pressure should be adjusted in time. Because the temperature drops in winter, the tire pressure value may decrease or drop below the alarm value. When the tire pressure value drops below the alarm value, it will cause the alarm.

■ Cases in which the TPMS does not work properly

The system can make judgments based on subtle changes in the tires, and sometimes it does not work normally under the following conditions.

- When four tires are not the same size, the same manufacturer, the same brand and the same tread pattern, or when tires with significantly different levels of wear are installed (the same for winter tires).
- When using emergency tires, snow tires and when installing tire chains.
- When installing tires with air pressure significantly higher than the specified air pressure, or when the air pressure drops rapidly due to a flat tire (rupture).

4-5. Operating other driving systems LDW/LKA

The LKA system can detect the status of the driver and the driving condition of the vehicle when the vehicle speed is more than 60 km/h, and it will give an alarm or an alarm plus a correction prompt to prevent danger and violations if it judged that the vehicle departed the lane due to non-subjective intentions of the driver (such as chatting, being distracted, or operating the multimedia system).

■ Lane departure warning (LDW)

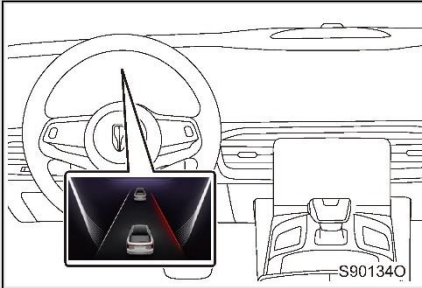

When the system determines that the vehicle has deviated from the lane, the corresponding sideline turns red, and flashes and a warning is issued.

■ Lane keeping assist (LKA)

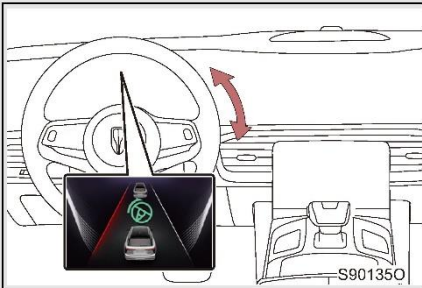

When the system determines that the vehicle has deviated from the lane, the corresponding sideline turns red and flashes and a warning is issued, then the steering wheel corrects it automatically.

■ LDW / LKA system settings

You can set the on and off of the LKA system in the vehicle settings of the multimedia system. After the system is turned on, the alarm mode can be selected as alarm only or alarm+correction, and the LDW sensitivity can be set. (Refer to P.224)

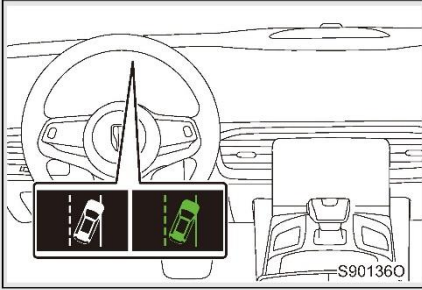

When the system is turned on, the LKA indicator (white) on the instrument cluster lights up. When the system is off, the indicator goes out.

When the system is turned on, the vehicle speed is more than 60 km/h, and the system recognizes a valid lane line, the LKA indicator (green) on the instrument cluster will be illuminated.

■ Working conditions for LDW/LKA system:

- The speed of the vehicle is more than 60 km/h.
- The lane lines are clear and meet the requirements of national standards.
- The system cameras are not obscured.

■ Under the following conditions, the system will suppress the alarm even if the vehicle deviates from the lane:

- The driver operates the steering wheel to turn.
- This car has been driving against the lane line.
- Within 3 s after the previous warning.
- Within 3 s after turning on the turn signal lamp switch or the turn signal lamp switch is returned.

■ Under the following conditions, the system will not make corrections automatically even if the vehicle deviates from the lane:

- The driver operates the turn signal lamp and steering wheel.
- The lane lines on one or both sides of the road disappear.

■ Under the following conditions, the LDW system may not function properly:

- The snow, ice or dust attached on the front windshield blocks the camera.
- Weather with low visibility such as fog, heavy rain or snow.
- The road is covered by vehicles or other obstructions.
- The road is too narrow or the curvature of the curve is too large.
- When the view of the system camera is blocked.
- When driving towards strong light.

4-5. Operating other driving systems

- The lane line conditions are complex such as lane line diverging, intersections or construction areas.
 - False recognition may be caused when the roadway is shaded by bridge ties or trees.
 - The light is low or the lane line is blurred at night.
 - The speed of the vehicle is less than 60km/h.
 - The lane lines do not meet the requirements of national standards.
 - Sudden changes in the brightness of the vehicle's external ambient light, such as entering a tunnel.
- **When the advanced DAS camera unit or the front windshield is replaced or after the four-wheel alignment, the system needs to be re-calibrated, otherwise it will not work properly. Please contact an authorized FAW Hongqi dealer.**



WARNING

- **LDW/LKA is only a DAS, so the driver must not over-rely on it and shall drive carefully.**
- **The driver is the primary controller of the vehicle, who is superior to the LDW/LKA system and must maintain control of the vehicle at all times and has full responsibility for the vehicle.**
- **Stop using the system when road and environmental factors may cause the system to not work properly.**
- **To avoid disturbing the driver, the system will not alert when the LDW/LKA activation conditions are not met.**
- **LDW systems that are not properly calibrated can misidentify other lanes and even cause accidents.**
- **The LDW /LKA system can recognize road lines and curbs with certain contrast, but it may not recognize or be unable to recognize the blurred and defaced road lines, and it may misrecognize some car marks, water marks or shadows on the road with large color contrast.**
- **When consecutive corrections are triggered within 180s by the LKA, the driver will be inspected for hand away from the steering wheel. Long time hand away from the steering wheel will trigger the alarm prompt sound and the sound will be gradually increased.**

The system automatically judges the collision risk level based on the relative distance, relative speed, and relative acceleration between the vehicle and the target vehicle, and will sound an alarm if the conditions are met.

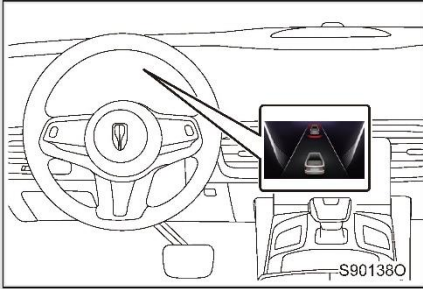

When the system determines that a collision may occur, the alarm information will appear on the instrument cluster and an alarm sound will be issued.

For vehicle targets, when the risk of collision escalates, the system will issue a braking warning alert similar to the effect of a spot brake.

■ FCW on/off

You can set the on and off of FCW system in the vehicle settings of the multimedia system and it is turned on by default. (Refer to P.225)

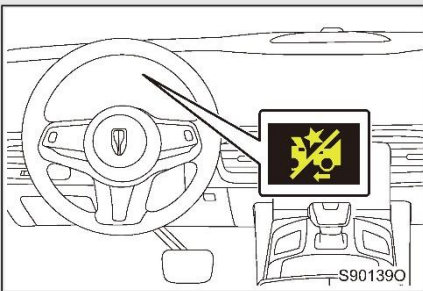

When the system is turned off, the instrument cluster will show FCW OFF indicator.

■ Adjusting or calibrating the FCW system

Please adjust or calibrate the FCW system in the following cases, otherwise the FCW system may not work properly.

- The front windshield is damaged or replaced.
- The advanced DAS camera unit or forward millimeter wave radar positioning bracket is removed or installed.
- The vehicle is adjusted after four wheel alignment.
- The front bumper is hit or deformed.

Please contact an authorized FAW Hongqi dealer.



WARNING

- To ensure driving safety, the occupants in the car must fasten their seat belts!
- FCW is only a driver assistance system, so do not over-rely on it and the driver must drive carefully.
- FCW only gives a warning of the danger of a collision, and the driver must operate the brake pedal or steering wheel himself to prevent a collision.
- FCW may not recognize modified or decorated vehicles with special appearance.
- The FCW system obtains vehicle information by identifying the rear of the vehicle, so the system does not alert to oncoming traffic in the opposite direction or to vehicles crossing laterally in front of it.
- In complex traffic conditions, FCW may not recognize vehicles in time, resulting in the delay of alarm.
- On curved roads, hilly roads or unusually bumpy roads, the system may not be able to detect vehicles ahead and drivers must drive with caution.
- The FCW system is an alarm system, but cannot detect the vehicle in all situations. For example, vehicles with heavily obscured rear ends, vehicles with strange shapes (e.g. overloaded vehicles transporting trees), vehicles with heavily damaged rear ends, etc.
- FCW may not be able to recognize narrow objects such as pedestrians or bicycles.
- When rain, snow, ice, fog or dust block the sensors, the performance of the system may be reduced or fail and the driver must drive with caution.
- The front windshield must not be modified or covered by any auxiliary equipment, as this may result in reduced performance or failure of FCW.
- If the camera is displaced by a collision, the FCW function may be degraded or malfunction, so the driver should calibrate the FCW system in time.
- Do not use an uncalibrated FCW system.
- For scenarios such as strong backlight, road reflection, and insufficient ambient lighting, the FCW system may not work properly, so drivers should drive with caution.
- If the chassis of the car in front is very high, or the goods protrude from the back of the car, please pay attention to the possible dangerous situation.
- FCW may not be able to identify targets such as cyclists.
- The front bumper must not be painted, modified or covered by any auxiliary equipment, as this may result in reduced performance or failure of the forward millimeter wave radar sensor!
- Extreme weather such as severe snow, rain, ice, and dense fog may result in reduced performance or failure of the forward millimeter wave radar sensor. In this case, the driver should use the FCW system with caution.
- If the forward millimeter wave radar sensor is displaced by a collision, the FCW may be degraded or malfunction, so the driver should calibrate the forward millimeter wave radar sensor in time.
- Do not use the forward millimeter wave radar sensor that is not properly calibrated.

**Notice**

- **To avoid disturbing the driver with false alarms from the system, the following conditions will not be alarmed.**
- The front windshield is damaged or replaced.
 - The speed of the vehicle is less than 8km/h.
 - Within 3s after the previous warning.
 - The driver operates the steering wheel too fast or turns the corner too much.
 - The driver slams on the accelerator pedal, resulting in a large pedal position.

Autonomous Emergency Braking (AEB)

The working range of autonomous emergency braking (AEB) is 8km/h - 80km/h. When the vehicle encounters an emergency and may collide with the vehicle ahead, if the driver does not apply emergency braking or steering in time, the system will assist the driver to apply braking force to the vehicle to avoid or reduce the injury of collision.

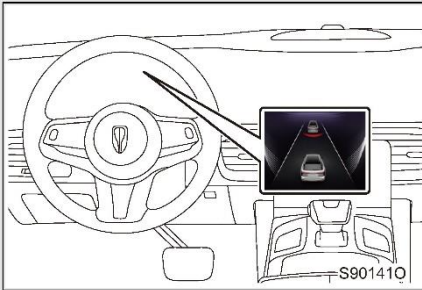

If the AEB is activated, the alarm information will appear on the instrument cluster and an alarm sound will be issued.

■ AEB on/off

You can set the on and off of AEB system in the vehicle settings of the multimedia system. (Refer to P.225)

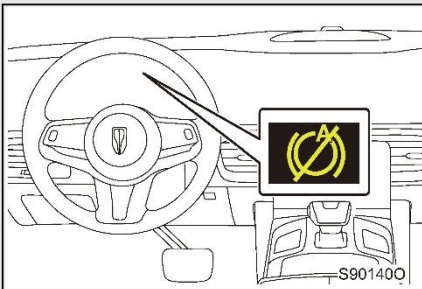

If the system is turned off, the instrument cluster will show the AEB OFF indicator.

■ Adjusting or calibrating the AEB system

Please adjust or calibrate the AEB system in the following cases, otherwise the AEB system may not work properly.

- The front windshield is damaged or replaced.
- The advanced DAS camera unit or forward millimeter wave radar positioning bracket is removed or installed.
- The vehicle is adjusted after four-wheel alignment.
- The front bumper is hit or deformed.

Please contact an authorized FAW Hongqi dealer.

**WARNING**

- To ensure driving safety, the occupants in the car must fasten their seat belts.
- AEB is only a driver assistance system, so do not over-rely on it and the driver must drive carefully.
- AEB may not recognize modified or decorated vehicles with special appearance.
- On curved roads, hilly roads or unusually bumpy roads, the system may not be able to detect vehicles ahead and drivers must drive with caution.
- AEB may not be able to identify targets such as cyclists.
- The braking function of the AEB system will not be activated when the electronic stability control (ESC) system is off or malfunctioning.
- If it snows or rains heavily, the system may not work properly.
- For scenarios such as strong backlight, road reflection, and insufficient ambient lighting, the AEB system may not work properly, so drivers should drive with caution.
- If towing another vehicle or trailer, turn off the AEB system. The safety of the vehicle deteriorates when the brakes are controlled under traction conditions.
- If the chassis of the car in front is very high, or the goods protrude from the back of the car, please pay attention to the possible dangerous situation.
- The front windshield must not be modified or covered by any auxiliary equipment, as this may result in reduced performance or failure of AEB!
- If the camera is displaced by a collision, the AEB function may be degraded or malfunction, so the driver should calibrate the AEB system in time.
- Do not use an uncalibrated AEB system.
- The AEB system obtains vehicle information by identifying the rear of the vehicle, so the system does not alert to oncoming traffic in the opposite direction or to vehicles crossing laterally in front of it.
- The AEB system is a secondary system but cannot detect the vehicle in all situations. For example, vehicles with heavily obscured rear ends, vehicles with strange shapes (e.g., overloaded vehicles transporting trees), vehicles with heavily damaged rear ends, etc.
- When the vehicle is driving in a curve, AEB may not be able to accurately determine the status of stationary objects in the direction of travel of the vehicle, so the system may not perform active emergency braking assistance.
- The AEB system does not help the driver in all situations, so the driver must not completely rely on the system and must concentrate on road conditions to ensure safe driving.
- The AEB system is an active DAS, but it cannot fully prevent collision with vehicles ahead in all situations. The driver needs to be responsible for how he or she drives and how he or she avoids dangerous situations. In the event of an emergency, the driver should apply the brakes as promptly as possible.
- If the AEB system is activated, when the vehicle is stopped, the driver must control the vehicle in time to prevent the vehicle from starting again and causing the vehicle to roll backwards.



WARNING

- **The front bumper must not be painted, modified, or covered by any auxiliary equipment, as this may result in reduced performance or failure of the forward millimeter wave radar sensor!**
- **Extreme weather such as severe snow, rain, ice, and dense fog may result in reduced performance or failure of the forward millimeter wave radar sensor. In this case, the driver should turn off the AEB system.**
- **If the forward millimeter wave radar sensor is displaced by a collision, the AEB may be degraded or malfunction, so the driver should calibrate the forward millimeter wave radar sensor in time.**
- **Do not use the forward millimeter wave radar sensor that is not properly calibrated.**



Notice

- **To avoid disturbing the driver with false alarms from the system, the following conditions will not be alarmed.**
 - The speed of the vehicle is less than 8km/h.
 - Within 20s after the previous warning.
- **When the AEB system is activated, if one of the following conditions occurs, the AEB will be deactivated:**
 - The driver operates the steering wheel too fast or turns the corner too much.
 - The driver slams on the accelerator pedal, resulting in a large pedal position.
 - The vehicle speed falls below the threshold of 45 km/h.
- **The AEB system will not be triggered when any of the following conditions are met, which is intended to allow the driver to control the vehicle himself without disturbing the driver.**
 - ESC/TCS/ABS function is activated.
 - The gear is in R.
 - Any door is not closed.
 - The hood is not closed.
 - The driver unbuckles the seat belt.
 - Automatic parking function is on.
 - Within 20s after the previous warning.
 - The speed of the vehicle is less than about 8km/h.
 - The driver operates the steering wheel too fast or turns the corner too much.
 - The driver slams on the accelerator pedal, resulting in a large pedal position.

4-5. Operating other driving systems

Blind spot detection (BSD) system

The system has the functions of blind spot detection (BSD), lane change assist, rear cross traffic alert (RCTA), door opening warning, and rear collision warning (RCW), which provide assistance to the driver when driving.

BSD and lane change assist

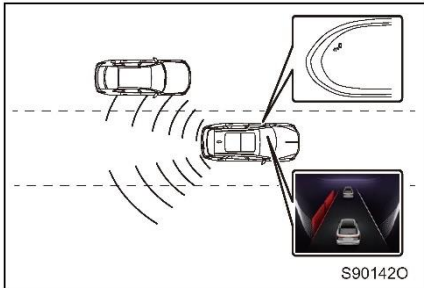

When the shift lever is moved to any position other than R and the vehicle speed is more than 15 km/h, the warning indicator in the corresponding side exterior rearview mirror will be illuminated and an alarm message will be displayed on the instrument cluster once the lateral vehicle behind is within the 3 m blind zone or 3-70 m away from the subject vehicle and the collision conditions are met. If the corresponding side turn signal lamp switch is turned on at this time, the warning indicator will flash, and a warning tone will give to remind the driver that a lane change is dangerous at this time. When the vehicle speed is less than 13 km/h, the function will be turned off.

Rear crossing traffic alert (RCTA)

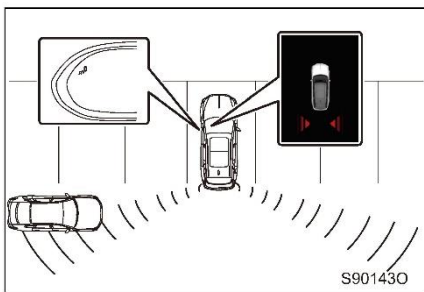

When the shift lever is in the R and the vehicle speed is 0-15 km/h, if there are crossing vehicles, electromobiles, bicycles and other targets in the lateral direction behind the vehicle, the system will judge whether there is a collision risk and the collision risk level of the relevant target. If any, the indicator in the corresponding side rearview mirror lights up, and the multimedia system display shows an alarm message to avoid the collision.

Door opening warning

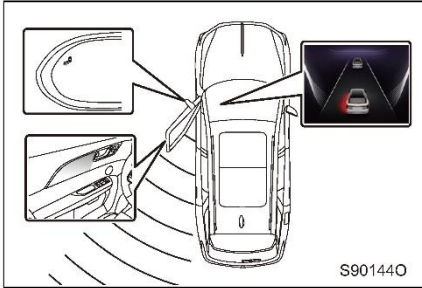

When the shift lever is moved to any position other than R and the vehicle speed is 0-3.6 km/h, if there is a vehicle approaching within 2.5 m in the lateral direction, 50 m in the longitudinal direction behind the subject vehicle and a door is unlocked, the warning indicator in the corresponding side rearview mirror and the corresponding side door ambient lamp will be illuminated in red, and an alarm message will be displayed on the instrument cluster. At this time, if you open any door, the above-mentioned indicator and ambient lamp will be flashing, and the system will issue warning tone to remind the driver that it is dangerous to open the door. When the vehicle speed is more than 5 km/h, the function will be turned off.

Rear-end collision warning

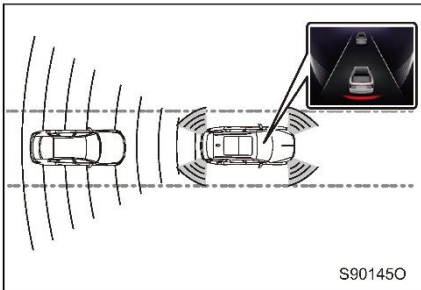

When the shift lever is moved to a gear other than R and the vehicle speed is more than 0 km/h, if the following vehicle is within 31 m of the subject vehicle, the system will monitor the driving status of the following vehicle behind the subject vehicle to determine the risk level of rear collision. If there is a danger, the instrument will display an alarm message, and meanwhile trigger the hazard warning lamp to flash, reminding the driver and the following vehicle that there is a risk of collision.

BSD system ON/OFF

You can set the on and off of BSD system in the vehicle settings of the multimedia system. (Refer to P.225)

- **Under the following conditions, the BSD and lane change assist may not alarm or delay the alarm:**
 - The vehicle is driving on a steep slope.
 - The vehicle is driving through a mountain top or mountain road.
 - There is a height difference between the driving lane and the adjacent lane.
 - The turning radius is small.
 - The vehicle is driving on snow-covered roads for a long period of time.
 - A large amount of snow or ice are gathered near the radar sensor.
- **Under the following conditions, the BSD and lane change assist may advance or expand the alarm:**
 - If the two lanes are too narrow, an alarm will occur in the other lane.
 - The vehicle is driving on roads with fixed obstacles (such as tunnel walls, viaduct concrete barriers, metal billboards, etc.) near the side of the body for a long period of time.
- **Under the following conditions, RCTA may fail to make alarm or expand the alarm range:**
 - The vehicle is parking at an angle.
 - The reversing speed of the vehicle is more than 15km/h.
 - A large amount of snow or ice are gathered near the radar sensor.
 - The target vehicle speed and yaw angle keep changing in the detection area.
 - A vehicle is approaching the vehicle directly from behind.
- **Under the following conditions, door opening warning may fail to make alarm or expand the alarm range:**
 - A large amount of snow or ice are gathered near the radar sensor.
 - The vehicle is driving on roads with fixed obstacles (such as tunnel walls, viaduct concrete barriers, metal billboards, etc.) near the side of the body.
- **Under the following conditions, RCW may fail to make alarm or expand the alarm range:**
 - A large amount of snow or ice are gathered near the radar sensor.
 - The target vehicle speed and yaw angle keep changing in the detection area.



Notice

- **Be careful not to bump the bumper when parking, as this may displace or damage the sensors in the bumper and the system will shut down automatically or the system function will be affected.**
- **To ensure that the system works properly, the sensors in the bumper must be kept clean and must not be covered by other objects.**
- **Only paint approved by our company is allowed to be applied to the bumper. Spraying other types of paint may result in limited function or system failure of the BSD system.**
- **If the BSD does not work properly, shut down the system immediately and contact the authorized FAW Hongqi dealer for maintenance.**
- **After the BSD system is repaired, it needs to be calibrated. For more information, please contact the authorized FAW Hongqi dealer.**
- **BSD only serves as an auxiliary alert and cannot completely prevent collisions with vehicles in the blind spot. Before changing lanes, be sure to check your mirrors, scan backwards and turn on the turn signal lamp.**
- **The BSD system may cause false alarms or missed alarms under special working conditions, such as cloudy and wet weather, high speed, which is normal.**
- **When the rear BSD radar of the vehicle is blocked, it will cause the system to be inoperative and needs to be cleared in time.**
- **The BSD system is limited by physical laws and system conditions and may not correctly identify traffic conditions under certain driving conditions. Such as the following situations.**
 - During a sharp turn lane.
 - When in travel lanes of different widths.
 - When on undulating roads in mountainous areas.
 - During adverse weather conditions.
 - At certain special structures on the roadside, such as higher or staggered highway guardrails.

**WARNING**

- **BSD is only a DAS, so the driver must not over-rely on it and shall drive carefully.**
- **The driver is the primary controller of the vehicle, and the BSD system only serves as an aid to alert the driver, so the driver must always maintain control of the vehicle and has full responsibility for the vehicle.**
- **When a vehicle is towed or there are accessories (such as bicycle brackets) installed at the rear, turn off the radar detection system. Otherwise, the radio waves emitted by the radar will be blocked and the system will not work properly.**
- **BSD system can detect targets such as automobiles, electric bicycles, bicycles, etc. If the target vehicle is featured with irregular shape, or is modified or covered by painting, the recognition effect cannot be guaranteed, and the recognition of pedestrians, animals or other objects also cannot be guaranteed. Drive with caution currently.**
- **The intelligent technology used in the BSD system cannot violate the laws of physics and has its own certain limitations, so the BSD can only work within its limit range. Therefore, the driver must still concentrate on observing the road and traffic conditions to prevent accidents.**
 - Be sure to adjust the speed and the safe distance from the vehicle ahead according to the visibility, weather conditions, road, and traffic conditions at that time.
 - Be sure to always keep both hands on the steering wheel while driving and be ready to implement steering.
 - Be sure to pay attention to the information displayed on the exterior rearview mirror indicator and the instrument cluster multi-function display and follow the instructions to operate correctly.
 - The BSD system may react to specific roadside structures (such as taller or offset guardrails) and generate false alarms as a result.
 - Always pay attention to the road conditions and surrounding conditions.
 - Do not use the BSD system when the sensor is dirty or damaged, in which case the system function may be affected.
 - In direct sunlight, the field of vision of the exterior rearview mirror may be limited.
 - When driving, be sure to strictly follow the instructions of the alarm lamp/indicator and related text messages, otherwise, it is likely to cause accidents and serious personal injuries.

4-5. Operating other driving systems TSR system*

Traffic sign recognition (TSR) system can accurately recognize the speed limit sign and speed limit release sign ahead during the driving.

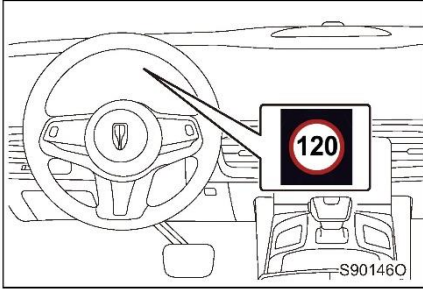

When the system recognizes the speed limit sign, if the vehicle speed is less than the speed limit value, the instrument cluster will only display the current speed limit requirement through the indicator; and if the vehicle speed is more than the speed limit value, the instrument cluster will remind the driver by sound/icon/text message, etc.

When the system recognizes that the TSR is canceled, the indicator on the instrument cluster will go out and the TSR will be canceled.

TSR system on/off

You can set the on and off TSR system in the vehicle settings of the multimedia system. (Refer to P.225)

■ Under the following conditions, the system will cancel the speed limit alarm:

- The vehicle has passed the speed limit sign for a certain distance.
- The turn signal lamp is turned on and a turn is made.
- A U-turn is made at low speed.

■ Adjusting or calibrating the TSR system

Please adjust or calibrate the TSR system in the following cases, otherwise the TSR system may not work properly.

- The front windshield is damaged or replaced.
- The four-wheel alignment has performed.
- The advanced driver assistance system camera unit is replaced.

For calibration, please contact the authorized FAW Hongqi dealer.

**WARNING**

- **TSR is only a driver assistance system, so do not over-rely on it and the driver must drive carefully.**
- **The driver is the primary controller of the vehicle and must always maintain control of the vehicle and has full responsibility for the vehicle.**
- **If it snows or rains heavily, the system may not work properly.**
- **For scenarios such as strong backlight, road reflection, and insufficient ambient lighting, the TSR may not work properly, so drivers should drive with caution.**
- **The front windshield must not be modified or covered by any auxiliary equipment, as this may result in reduced performance or failure of TSR.**
- **If the camera is displaced by a collision, the TSR function may be degraded or malfunction, so the driver should calibrate the TSR system in time.**
- **When the sign is not in a style or placed at a position that conforms to regulations, the system will fail to recognize it normally.**

4-5. Operating other driving systems Auto parking assist (APA)

APA measures the length of the parking spaces on both sides of the road through ultrasonic waves and cameras. If the appropriate parking space is selected, the system will automatically control the vehicle to perform auto parking in the selected parking space. APA includes auto parking-in and auto parking-out. They can be selected through the multimedia display.

Before using the APA, be sure to check the automatic parking steps, precautions and warnings described in this section to prevent accidents.

Activating APA



Press the APA button to enter the automatic parking selection interface.



You may select the parking mode of parking-in or parking-out in the parking selection interface.

Auto parking-in

- Selecting the parking space type



You can search parking spaces in automatic mode and manual mode. And in each mode, there are three types of parking spaces available: vertical parking, inclined parking, and horizontal parking.

When the vehicle speed is not zero, the system defaults to automatic mode. Only when the vehicle speed is zero, the manual mode can be selected.

- Selecting the parking space



Method 1: Automatic mode selection

When the automatic mode is selected, it defaults to full parking space, and all parking space types can be searched. If the user has selected a type, the search success rate of single parking space type can be improved. The system will recognize the parking spaces of the same type as that selected by the user on both sides of the driving direction while driving. The system defaults to the preferred parking space as the target parking space; and you can also touch other optional parking spaces on the display as the target parking space.

Red: unavailable parking spaces

Yellow: available parking spaces

Green: preferred parking space

Method 2: Manual mode selection

After selecting the manual mode and the parking space type, the corresponding target parking space frame will appear on the display, which can be dragged and rotated. When the vehicle in the parking space frame is shown in red, it means that the vehicle cannot be parked in the area, the position and posture of the target parking space frame on the display needs to be adjusted.



4-5. Operating other driving systems

■ Parking control

Method 1: With the target parking space selected, depress the brake pedal, touch the "Start Parking-in" button, and release the brake pedal to start parking.

Method 2: With the target parking space selected, shift the gear to P, apply the EPB and touch the "Start Parking-in" button to start parking.

The parking process can be controlled through the display during the parking.

Auto parking-out

■ Selecting the parking-out type



Four types of parking-out can be selected: vertical backwards, vertical forward, parallel leftwards, and parallel rightwards through the multimedia system display.

■ Parking-out control

Method 1: With the parking-out type selected, depress the brake pedal, touch the "Start Parking-out" button, and release the brake pedal to start parking out.

Method 2: With the parking-out type selected, shift the gear to P, apply the EPB and touch the "Start Parking-out" button to start parking out.

The parking process can be controlled through the display during the parking out.

■ Parking working conditions:

- In the process of searching a parking space, the vehicle speed should be less than 20 km/h; otherwise, slowdown will be prompted.
- No one is operating the steering wheel during parking.
- ESC OFF switch is not activated.
- ESC/ABS/TCS function is not working.
- APA/ESC/ABS/TCS/EPS.

■ Parking exit conditions:

- The vehicle speed is more than 30 km/h during the process of searching a parking space.
- The driver steers the wheel.
- Any door is opened.
- The parking canceling button is pressed.
- Parking is not completed beyond the maximum number of movements after the automatic parking is activated.
- The SACC function is activated
- ESC OFF switch is activated.
- ESC/ABS/TCS functional intervention.
- APA/ESC/ABS/TCS/EPS function failure.

- **During the automatic parking process, it is necessary to observe the surrounding conditions of the vehicle throughout the entire process. When an emergency occurs and braking is required, the driver needs to touch the parking canceling button or depress the brake pedal or pull the EPB switch to stop the vehicle.**



Notice

- **The driver is the primary controller of the vehicle, and the APA is only a DAS. Though the system can help the driver, it should not replace the driver to park the vehicle and the driver must be responsible for the parking. In the process of parking, the driver should pay attention to the surrounding environment of the vehicle and control the vehicle if necessary to avoid danger.**
- **To ensure the success rate and safety, the system needs to be used in the following environmental conditions:**
 - The road surface is flat, the obstacle is less than 5cm high, and the slope does not exceed 4 degrees.
 - The parking space lines are clear, and the parking space is large enough.
 - The weather is good, and the driver can see the environment near the parking space clearly and unobstructed.
 - The driving road is dry and non-slip.
- **In the process of automatically searching for parking spaces, the following situations should be paid attention to:**
 - The vehicle needs to move close to the parking space. Failure to do so may cause the parking space not to be recognized.
 - The steering angle of the vehicle should not be excessive, otherwise it may cause failure of the parking space recognition.
 - The vehicle speed should not be more than 20 km/h, otherwise the parking space recognition failure will occur.
 - Rain, snow, fog, or dark light may reduce the recognition rate of parking spaces.
 - When the parking space is too small, the parking space lines are not clear, or the parking space is irregular, it may cause failure to search a parking space.
 - In the process of searching a parking space, the image can only assist the driver, and the driver needs to pay attention to the surrounding environment in real time.
- **In the process of automatically parking, the following situations should be paid attention to:**
 - The distance prompting function may have blind spots, and the driver needs to pay attention to the surrounding environment in real time.
 - Insufficient parking space may cause failure of parking.
 - Steep slope may cause failure of parking.
 - Slippery roads may cause failure of parking.
 - Uneven road surface, steps or low obstacles may cause failure of parking.
 - In the process of parking, the driver should not operate the pedals, shift lever and steering wheel, otherwise the parking will be terminated.
- **If the tire needs to be replaced, please make sure that the size of the replaced tire is exactly the same as that of the original tire and check the four-wheel alignment parameters.**

**WARNING**

- Due to the blind zone of the sensor, pay attention to low and small obstacles, and the corners and sides of the vehicle during parking.
- For specific limitations of the sensor, please refer to the relevant description of the parking sensor.
- Pay attention to whether there is enough space when parking.
- There is a delay in the parking brake, so the driver should make a judgment in advance and stop the vehicle if the danger is found.
- Please pay special attention to people, animals, and various obstacles around the vehicle, where the sensor has a blind spot that cannot be detected.
- When searching for a parking space or during parking, please be aware that there are no obstacles in the parking space, such as rocks, thin poles, or tow bars, as the system may not detect such obstacles.
- The system may not recognize the surface or structure of certain objects (e.g., wire fences, fluffy snow, angular pillar, etc.). Therefore, please re-check that there is enough space in the parking space and surroundings before parking the vehicle.
- If the Park Distance Control (PDC) detects an obstacle, the obstacle may disappear from the sensor detection range after the car approaches (this is highly likely to happen when detecting obstacles that are too high and too low), thus not detecting these items. Do not ignore the warning from the radar warning system, otherwise the vehicle may be at risk of collision.
- Due to the influence from various external sound and electromagnetic fields (e.g. other vehicles using ultrasonic ranging, air pressure, engine noise, electric gears, induction loops, etc.), the system cannot achieve absolute immunity to interference.
- The immunity to interference and detection performance of ultrasonic ranging systems may be reduced by environmental conditions and obstacle reflection properties, which are determined by the physical properties of ultrasonic propagation.
- The installation position of the sensor has an important impact on the system performance, which is reflected in the reflection from the vehicle bumper surface itself, ground echo reflection and detection range.
- Avoid cleaning the sensor with a pressure washer or steam cleaner to prevent damaging the sensor. When cleaning the vehicle, you should use a smaller water flow to rinse the sensor surface for a short time and keep at least 10 cm away.
- The propagation of sound waves in air is based on the physical properties of refraction and diffraction phenomena. Temperature differences in the air are one of the most important factors in generating a non-uniform propagation medium, which in turn leads to acoustic diffraction.
- The detection performance of ultrasonic detection equipment can be affected by the following factors.
 - Hot vehicle exhaust.
 - High temperature tarmac.
 - Summer breeze.
 - Temperature stratification.



WARNING

- **When there is a difference between the bumper temperature and the ambient air temperature (which usually occurs in winter), there is temperature stratification, which leads to acoustic wave diffraction, and in certain bumper structures there is a risk of false alarms due to reflected echoes.**
- **Some important factors that can lead to reduced or undetectable detection range.**
 - Snow or sludge adhering to the bumper surface.
 - Plaster or ice adhering to the sensor surface.
 - High acoustic attenuation (e.g., in dry, hot environments).
 - Heavy rain or in foam.
 - Obstacles with wave-absorbing materials.
- **Flat type obstacles with angles facing the sensor and reflected echoes occur only in a specific angular range.**

The functions associated with the electronic stability control (ESC) system vary slightly depending on the model. To improve the driving safety and performance of the vehicle, each of the following functions will work automatically according to various driving conditions. However, it is important to remember that these functions are only auxiliary and should not be relied upon when driving the vehicle.

■ **Anti-lock Braking System (ABS)**

When driving on slippery roads or during emergency braking, it prevents the wheels from locking and producing sideslip or runaway.

■ **Electronic Brakeforce Distribution (EBD)**

According to the changes of vehicle load, road condition and braking force, the dynamic proportional distribution of front and rear wheel braking force is implemented to improve vehicle braking stability and controllability.

■ **Traction Control System (TCS)**

It prevents the drive wheels from slipping when the vehicle starts or accelerates on a smooth road, ensuring vehicle acceleration performance.

■ **Hydraulic Brake Assist (HBA)**

Braking force compensation is performed when the brake pedal is depressed quickly, which can effectively increase the braking force.

■ **Hydraulic Brake Boost (HBB)**

Braking force compensation is required when the assistance provided by EPS is insufficient, which can effectively increase the braking force.

■ **Hill descent control (HDC)**

When the vehicle is running downhill at a speed of 8-35 km/h, apply the proper braking force to the wheels to keep the vehicle at a stable speed. You can set the on/off of HDC-by-HDC button.

■ **Hill Hold Control (HHC)**

This function properly maintains the braking pressure applied by the driver to prevent the vehicle from skidding during the period when the driver moves his foot from the brake pedal to the accelerator pedal when the vehicle is starting on a hill.

■ **Electronic Stability Control (ESC)**

It helps the driver control sideslip and ensure correct vehicle trajectory when steering suddenly or steering on slippery roads.

■ **Controlled Deceleration for ACC-Stop & Go (CDD-S) ***

It assists adaptive cruise control (ACC) to achieve adaptive cruise deceleration control of the vehicle.

■ **Controlled Deceleration for Parking Brake (CDP)**

Pull up and hold the EPB switch, and the vehicle actively enters the deceleration state.

■ **AUTO HOLD**

A function to hold the stationary vehicle via the parking brake applied by the hydraulic system for a short period of time, after which the parking is taken over by the electronic parking system.

■ **Automatic Brake Prefill (ABP)**

ESC system actively pre-charges the brake system according to the request from the relevant controller to improve the response speed of the brake.

4-5. Operating other driving systems

Electric Power Steering (EPS)

It uses an electric motor to reduce the force required to turn the steering wheel.

When TCS/ESC works

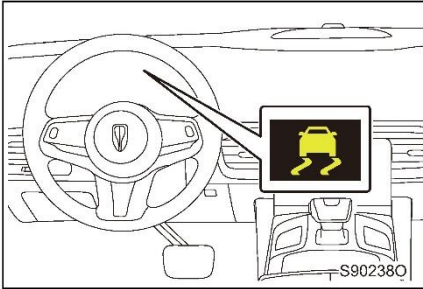

If the vehicle skids or the drive wheels are idling, the indicator flashes, indicating that TCS/ESC is operating.

Disable ESC

ESC may reduce the power output of power system to the wheels if the vehicle is stuck in snow or slush. Turning off the system helps the vehicle move back and forth out of the trap.

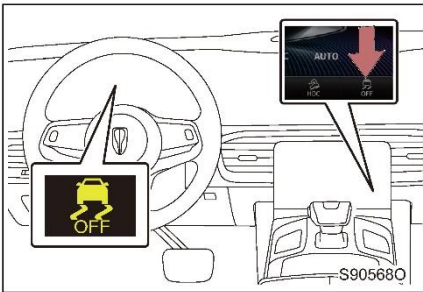

You can set the on/off of ESC function in the A/C control panel and when the function is turned off, the ESC OFF indicator on instrument cluster lights up.

■ ESC Auto Response

When the vehicle is restarted after the ESC/TCS is turned off or when the vehicle speed is greater than 70 km/h, the system will be automatically reactivated.

■ Sound and vibration generated by ABS/HBA/TCS/ESC/CDP/CDD-S/HBB and AUTO HOLD

- A sound may be heard from the engine compartment when the engine is started or just after the vehicle begins to move. The sound does not mean that the system has fault.
- Some of the following normal conditions may occur when the above systems are operating, and these conditions do not indicate that a malfunction has occurred.

- Vibrations may be felt through the body and steering wheel.
- A motor sound may be heard when the vehicle is stopped.



WARNING

■ Handling of wheels and suspension

Using any faulty wheels or modifying the suspension will have an impact on the driver assist system (DAS) and may cause the system to malfunction.

■ ABS do not work effectively in the following cases

- The limit of the tire grip is exceeded.
- The vehicle skids when driving at high speed on wet roads.

■ Braking distance for ABS operation on special road surfaces

ABS is not designed to shorten the braking distance of a vehicle and it is important to maintain a safe distance from the vehicle moving ahead in the following cases.

- When driving on muddy, gravel or snowy roads.
- When driving with tire chains.
- When driving on bumpy roads.
- When driving on pothole-ridden or uneven roads.

■ TCS may not work effectively in the following cases

When driving on slippery roads, even if the TCS is working properly, you may not be able to control the direction and achieve power requirements, so do not drive the vehicle in conditions where stability and power may be lost.

■ When ESC is activated

If the indicator flashes, be sure to drive carefully, otherwise it may easily lead to an accident.

■ When ESC is closed

Special care should be taken and drive at a speed appropriate to the road conditions. ESC ensures vehicle stability and drivability and should not be turned off if not necessary.

■ Replacing the wheels

Ensure that all wheels have the same specification, brand, tread pattern and load capacity. Also, make sure the tire pressure meets the requirements of the tire pressure label. If the vehicle has a mix of different wheels, the ABS and EPS will not work properly. For more information about changing tires or wheels, please contact the authorized FAW Hongqi dealer.

Before driving in winter, please make the necessary preparations and checks. Be sure to drive in a manner appropriate to the prevailing winter weather conditions.

■ Preparations for driving in winter

- Use fluids suitable for outdoor temperatures.
 - Coolant
 - Cleaning fluid
- Ensure good battery performance.
- If necessary, install four snow tires on the vehicle or purchase a set of tire chains for the drive wheel.

Make sure all tires are the same model and brand and that the chains match the tire size.

■ Before driving

The following measures are taken according to driving conditions.

- Do not force open the frozen window or move the frozen wiper, apply warm water to the frozen part to melt the ice, and wipe the water off immediately to prevent icing.
- To ensure proper fan operation, remove snow from the air intake grille.
- Remove ice that has accumulated on the vehicle chassis.
- Periodically inspect and remove any snow or ice that may have accumulated on the wheel covers or brakes.
- Remove snow or mud from the soles of your shoes before you get on the car.

■ During

driving

Accelerate slowly and slow down your driving speed according to the road conditions.

Selection of tire chain

Use the correct size of tire chains when installing snow chains.

The size of the chain should be adjusted according to the size of each tire.

Regulations regarding the use of snow chains

Depending on the location and type of road, the regulations for using tire chains may vary. Be sure to check local regulations before installing the chains.

Install the chains on the drive tires.

Retighten the chains after 0.5 - 1.0 km of driving.

■ Tire chain

Observe the following precautions when installing and removing the chains.

- Install and remove tire chains in a safe location.
- Install the chains on the drive tires.
- Install the tire chains according to the instructions provided in the manual that came with them.



WARNING

■ **Driving a vehicle with snow tires**

To avoid the possibility of losing control of the vehicle and causing serious injury or even death, and to reduce the risk of accidents, the following precautions should be observed.

- Use the specified type of tires.
- Maintain the recommended air pressure values.
- Do not drive more than the road speed limit or the posted speed limit of the snow tires used.
- All wheels should be fitted with snow tires.

■ **Driving a vehicle with tire chains**

To avoid the possibility of rendering the vehicle unsafe to drive and causing serious injury or even death, and to reduce the risk of accidents, the following precautions should be observed.

- Do not drive faster than the posted speed limit for the tire chains used.
- Avoid driving on uneven or pothole-ridden roads.
- Avoid sharp turns or emergency braking.
- Slow down sufficiently before entering a curve to ensure that you can control the vehicle.

5-1. Basic operation

Multimedia display	209
USB data interface	214

5-2. Operating the multimedia system

Vehicle.....	216
Travel.....	228
Entertainment	242

5-3. Operating the on-board Bluetooth phone

Hands-free system	245
Bluetooth® phone.....	248

5-4. Operating the voice recognition

Voice recognition	252
-------------------------	-----

5-5. Operating Mobile APP

Hongqi Zhilian APP	254
--------------------------	-----

5-1. Basic operation

Multimedia display

Users can operate the functions such as navigation, telephone, radio, music, vehicle settings through the multimedia display.

Front entertainment display

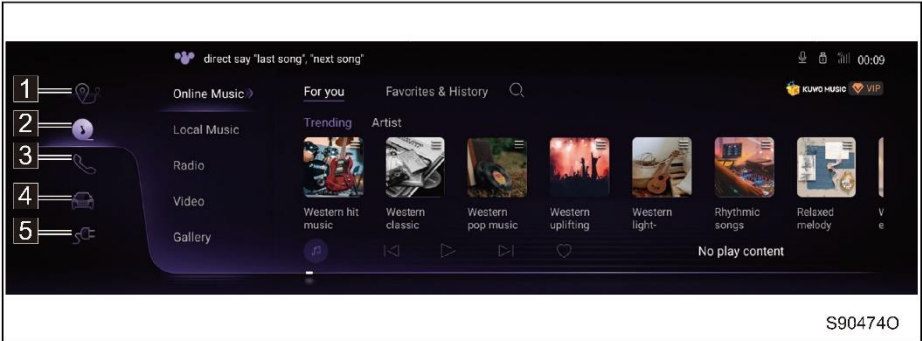

S904740

S/N	Name	Function
1	Travel	Enter [Travel] interface The on-board navigation system can be used.
2	Entertainment	Enter [Entertainment] interface You can use the Entertainment functions such as music, radio, and video.
3	Bluetooth phone	Enter the [Bluetooth Phone] interface When a Bluetooth phone is connected, the Bluetooth phone function can be used.
4	Vehicle	Enter [Vehicle] interface The system can be set, and the vehicle settings can be viewed and operated.
5	Charge	Enter the [Charge] interface The charging settings can be viewed and operated.

Front passenger display*

The user can view and operate Online Music, Local Music, Video and Setting through the front passenger entertainment display screen.

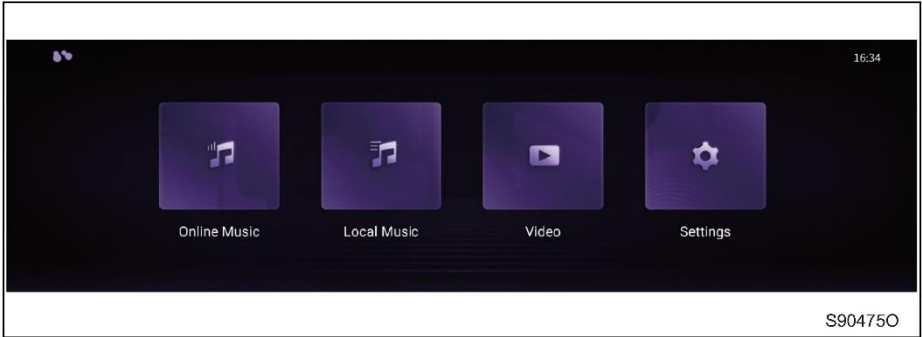

Shortcut menu on entertainment display

When the multimedia system is on, swipe down on the screen to pull out the shortcut menu, you can perform shortcut operations to view some functions.



■ To avoid damaging the multimedia display

- Touch the multimedia display lightly with fingers for operation. If the content showed on the multimedia display cannot be called out, it means that the content may not be called currently. Do not press the screen buttons excessively to avoid damage to the device.
- Do not use sharp or angular hard objects to touch the multimedia display, otherwise it may be damaged.
- Do not spray liquid directly on the multimedia display. If liquid leaks into the equipment, the electronic components may be damaged.
- When cleaning the surface of the multimedia display, please set the power(ignition) switch to OFF mode and wipe it with a soft dry cloth. Do not use rough rags, chemical rags, or organic reagents (alcohol, benzene, disinfectant, etc.), as they may damage or deteriorate the panel.

■ When using the multimedia display

- If the multimedia display is cold, the display may be dark, or the system may seem to be operating slightly slower than normal.
- The display might be dark or hard to watch clearly when you wear a pair of sunglasses, please change the angle of watching the multimedia display or take off your sunglasses.
- Do not expose the multimedia display under the blazing sun for quite a long time.
- Do not expose the multimedia screen under moisture, dusts, fumes or other pollution.



WARNING

■ Using the multimedia system

- Please do not operate this system as much as possible during driving.
- The volume should be adjusted properly so that the situation outside the vehicle can be heard during driving. If the volume is adjusted too high to observe the situation outside the vehicle, an accident may occur.
- Do not use it in a faulty state where no screen is displayed, or no sound is produced. This may cause an accident, fire, electric shock, or fatal injury.
- Do not operate the system in a no-parking area, as this may cause a traffic accident.
- For safety, please do not distract or hinder safe driving because of using this function. Ignoring road and traffic conditions can lead to an accident.

■ Do not disassemble or modify this product without permission, as this behavior may cause traffic accidents, fire, electric shock, etc.

■ If any abnormality occurs with the system due to intrusion of the foreign matter or water, please stop using immediately and contact the authorized FAW Hongqi dealer. It may lead to malfunctions if you continue using.



Notice

■ Noise from multimedia system

- The system is highly sensitive, so there might be noises when it is near television towers, broadcasting stations, power plants or other places transmitting strong radio wave or electrical noise interference.
- Interfering noises may be produced if a mobile phone is used inside or close to the vehicle while the multimedia system is operating.

■ Preventing damage to the multimedia system

Take care not to spill drinks or other liquids over the multimedia system. If fluid or other items enters this system, cut off the power immediately and contact the authorized FAW Hongqi dealer.

■ Compatibility

Some equipment may not be used normally due to their own compatibility issues.

■ In case of failure

If any troubleshooting fails, please contact the authorized FAW Hongqi dealer.

5-1. Basic operation

USB data interface

A USB device may be operated via the multimedia system after connecting it to the USB data interface.

Use of USB data interface

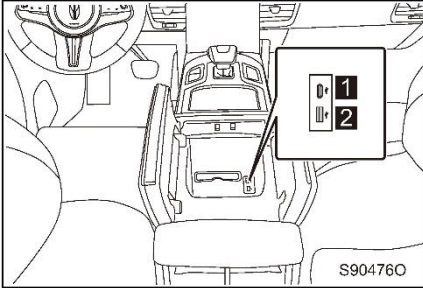

Open the front central glove box cover to connect the external multimedia source.

- 1 type-c
- 2 USB

■ USB memory

Connect the USB memory.

If the USB memory is not started, turn on its power supply.

WARNING

■ During driving

Do not connect the equipment or operate its control buttons to prevent accidents.



Notice

■ Prevent damage to the USB device or its terminals

- Do keep the interface clean. If foreign object or liquid enters the interface, it may cause multimedia system failure.
- Do not plug high-current USB devices other than U disk and mobile phone, such as mobile hard disks and portable powers.
- Do not leave any USB devices in the vehicle, as the temperature inside the vehicle may rise, causing damage to the USB devices.
- Do not press or impose unnecessary pressure on a USB device while it is connected.
- Do not insert foreign object into the interface.

■ Compatibility

Some equipment may not be used normally due to their own compatibility issues.

■ Ensure the normal identification of the system

USB devices with poor quality may not be identified by the system, so it is recommended to use high-quality USB devices.

■ When getting off the vehicle

Do not leave items such as mobile phones in the vehicle. The temperature inside the vehicle may rise, causing damage to mobile phones.

■ Mobile phone data cable

It is recommended to use the USB data cable supplied with the mobile phone to ensure stable connection.

5-2. Operating the multimedia system

Vehicle

Touch the [Vehicle] button on the screen in the main menu interface to access the vehicle function interface.

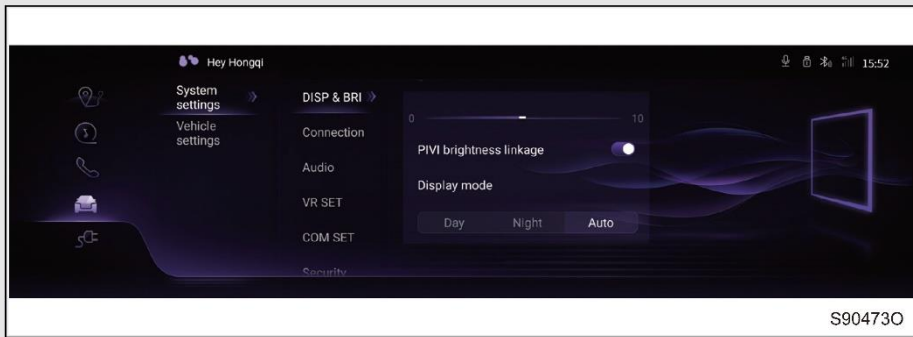

System settings

In the system settings, the display and brightness, network and connection, sound setting, voice setting, and general setting can be set.

■ Display and brightness

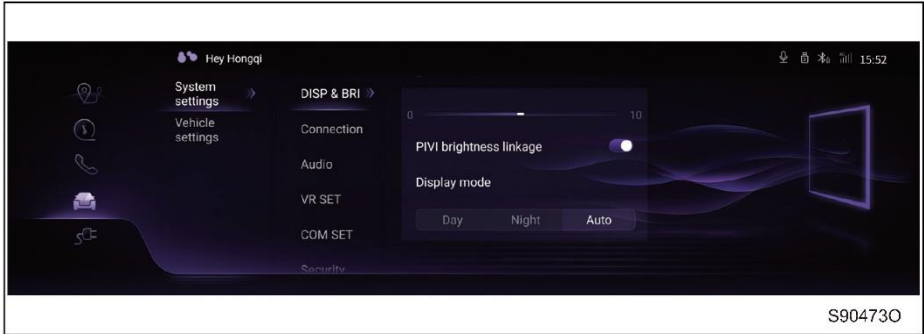

1 Brightness

- Brightness adjustment: the screen brightness can be adjusted.
- Front passenger screen brightness linkage: the brightness of the front passenger screen can be set to vary with the central control screen.
- Display mode: Three display modes can be set: day, night and auto.

2 Wallpaper

- You can set the wallpaper as a mechanical clock or digital clock.

3 Font size

- Language: The system can be set to Chinese, Norway, and English.
- Font size: You can set the font size as standard or large.
- Synchronization of font size on each screen: You can set whether to synchronize the adjusted font size of each display screen.

4 Theme setting

- Three theme modes can be set: technology, minimalism, and sports.

5 Screen on/off

- It can be set to turn ON/ OFF the central control entertainment display (front row entertainment display) and front passenger entertainment display.

6 Personalized instrument display

- You can set the contents on the expansion area of instrument as 12 constellations or Hongqi logo.

7 Eye protection mode

- The eye protection mode of the central entertainment screen can be turned on or off.

■ Network and connection

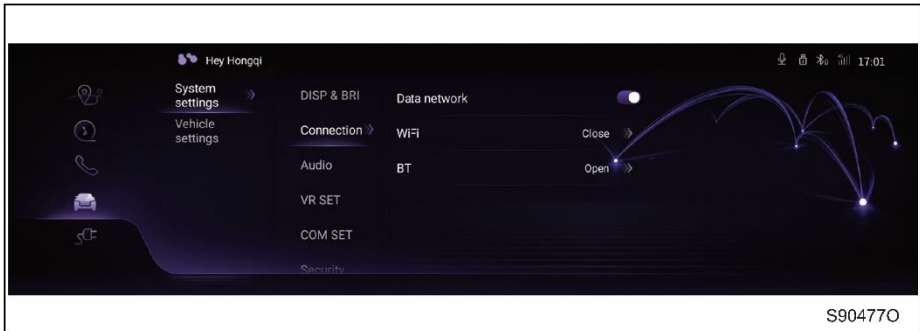

1 Data network

- The mobile data network can be turned on or off.

2 WiFi

- WiFi can be turned on or off. When WiFi is turned on, my devices and available devices can be viewed, connected, and deleted.

3 Bluetooth

- Bluetooth can be turned on or off. When Bluetooth is turned on, the saved devices and available devices can be viewed, connected, and deleted, and the Bluetooth name can be set.

■ Sound Setting

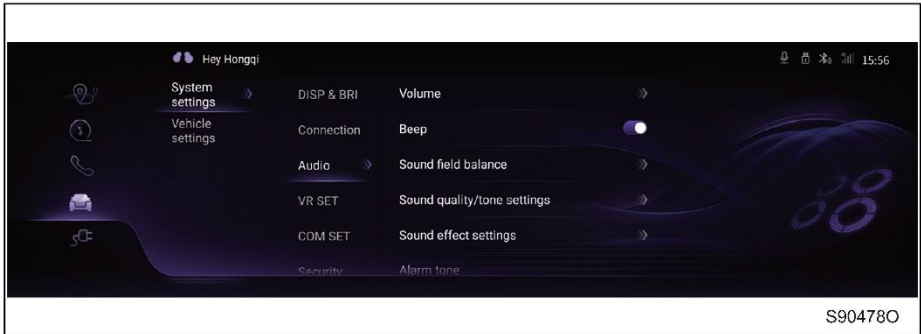

1 Volume

- The volume of multimedia, SOS, Bluetooth phone, audio broadcast, radar and other functions can be adjusted.

2 Key tone

- You can set the on/off the key tone on the screen.

3 Sound field balance

- By dragging the circular cursor, you can select the best sound field position, and reset the sound field.

4 Timbre setting

- You can adjust the tone values of bass, mediant and treble.

5 Sound effect setting

- You can set three modes: normal balance, driver seat priority and virtual surround sound.

6 Alarm tone

- You can set the alarm tone to high, medium, and low.

7 Pedestrian warning sound

- The pedestrian warning sound can be turned on or off.

■ Voice setting

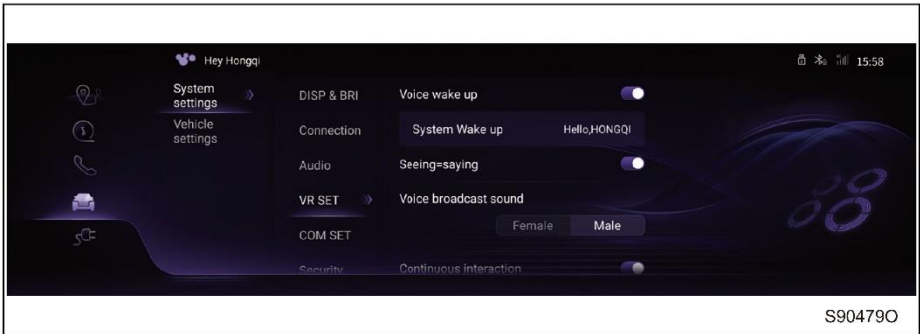

- 1** Voice Wake-up
 - The ON/OFF Voice Recognition can be set.
- 2** Audiovisual
 - You can set the on/off the audiovisual and speak out any special command for voice control in any interface after it is turned on.
- 3** Audio broadcast voice
 - It can be set as female voice and male voice.
- 4** Continuous interaction
 - You can set the on/off the continuous interaction. When the continuous interaction via voice recognition is turned on, the voice recognition can be used without wake-up words, and the interaction duration can be set to 10 s, 30 s and 60 s.

5-2. Operating the multimedia system

■ General setting

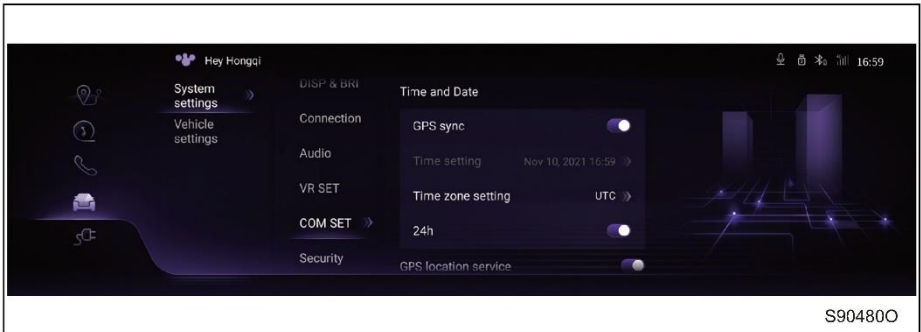

1 Time and date

- Time zone setting: Select the current time zone according to the country or region.
- 24h: 24h system is applied at power-on; 12h system is applied at power-off.

2 GPS

- You can set the on/off the GPS.

3 USB upgrade

- The multimedia system can be upgraded through the USB data packet. Please contact the authorized FAW Hongqi dealer for specific operation.

4 About the system

- You can view the system information.

5 Restoring system settings

- You can restore the system to factory settings.

■ Data Security

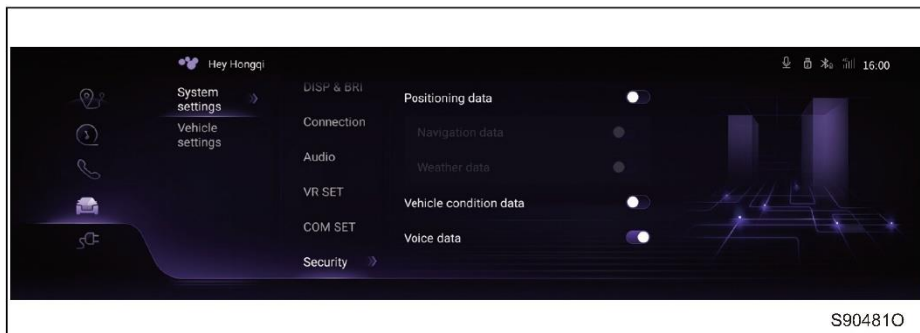

1 Positioning data

- It can be turned ON and OFF.
- Navigation data: It can be turned ON and OFF.
In case of OFF, the use of this function is limited.
- Weather data: It can be turned ON and OFF.
In case of OFF, the use of this function is limited.

2 Vehicle data

- It can be turned ON and OFF.
In case of OFF, the use of this function is limited.

3 Voice data

- It can be turned ON and OFF.
In case of OFF, the use of this function is limited.

Vehicle settings

In the Vehicle Setting, the functions such as Comfort Setting, Driving and Safety, Lighting Setting and Charging Setting can be performed.

■ Comfort setting

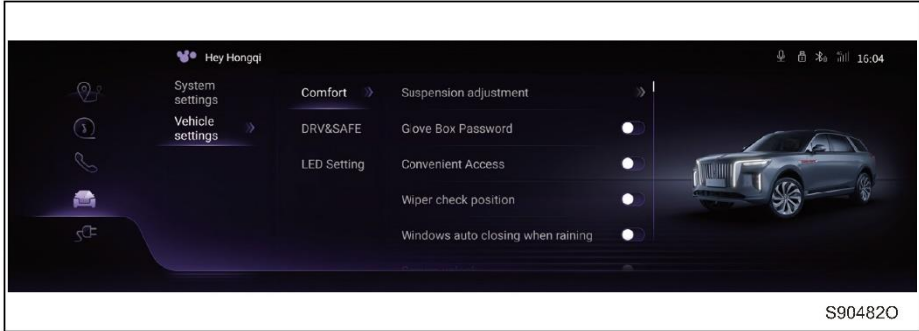

1 Suspension adjustment

- Auto adjustment at flameout: When the power (ignition) switch is turned off, please lower the vehicle suspension.
- Easy access: Adjust the vehicle suspension to the lowest position to facilitate occupants to get off.
- Lifting mode: Enter/exit the lifting mode.

2 Glove box password

Set a password to open the glove box if necessary.

3 Easy access

You can set the on/off the courtesy function.

4 Wiper access position

When the wiper access position function is turned on, the wiper shall be set to the access position when conditions permit.

5 Window auto closing in rainy days

You can set the on/off the windows and sunroof auto closing in rainy days.

6 Secure unlocking

You can set the on/off the secure unlocking.

On: press the unlocking button on the smart key once to unlock the driver side door; press the unlocking button on the smart key twice in succession to unlock all doors.

Off: press the unlocking button on the smart key once to unlock all doors.

- 7** Lock the auto-folding of exterior rearview mirror
Set the locking exterior mirror auto-folding function ON/OFF.
- 8** Turning of rearview mirror at reversing
The right rear rearview mirror can be set to turn down when reversing.
- 9** Auto proximity unlocking
You can set the on/off the auto proximity unlocking.
When the function is turned on, the vehicle will automatically unlock once the driver with the smart key is approaching.
- 10** Auto lock
You can turn auto-lock on or off.
When the function is switched on, the car will automatically be locked when the driver has the key and is longer than 3 meters away from the car
- 11** Vehicle mobilization reminder
You can set the on/off the vehicle mobilization reminder.
When the function is turned on, if the vehicle is moved in locked status, the owner will be notified through the Hongqi APP.
- 12** The trailer ON/OFF is set in Trailer Mode.
In case of ON, the blind spot detection, automatic emergency braking, lane departure correction and cruise mode are closed and cannot be set, the driving mode is locked to comfort mode, and the suspension height is maintained at normal level and cannot be set.
In case of OFF, the blind spot detection, automatic emergency braking, lane departure correction and cruise mode are closed and cannot be set, and the suspension adjustment and driving mode return to settable status.
- 12** Ceremonial sense
The ambient lamp can be turned on/off when the vehicle is unlocked or locked.

■ Driving and Safety

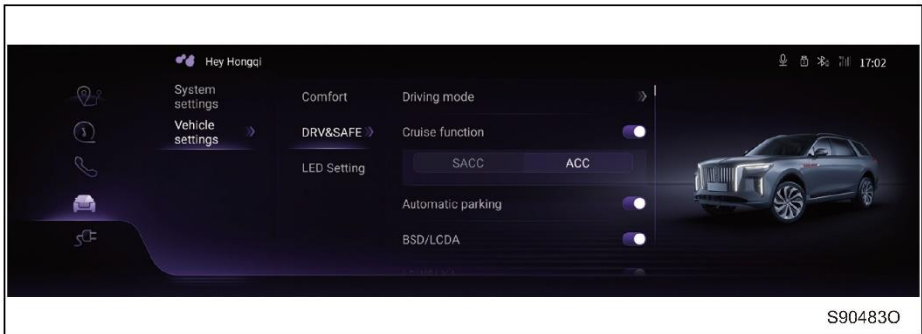

1 Driving mode

You can set seven driving modes: Comfort, Sport, LBL, All-terrain, Off-road, Custom and Extreme; and you can also set the driving characteristics of custom mode.

2 Cruise function

You can set the on/off of the cruise function. After the function is turned on, you can set the cruise mode as SACC or ACC.

3 AUTO HOLD

You can set the on/off of the AUTO HOLD.

4 BSD/lane change assist

You can set the on/off of the BSD/lane change assist.

5 LDW and assist

Set the ON/OFF of lane departure. After the function is turned on, the alarm mode can be set as alarm (LDW) and alarm + departure correction (LKA); At the same time, the alarm trigger sensitivity can be set. You can set the LDW sensitivity when the SACC is turned off.

6 RCTA

You can set the on/off of RCTA. After the function is turned on, the alarm mode can be set as FCW or FAW + AEB.

7 FCW and assist

You can set the on/off of FCW. After the function is turned on, the alarm mode can be set as FCW or FAW + AEB; and the FCW sensitivity can also be set.

8 Rear-end collision warning

You can set the on/off of RCW.

9 Traffic sign recognition (TSR)

You can set the on/off of TSR. After the function is turned on, the reminder mode can be set as intelligent TSR or manual TSR.

10 Driver fatigue alarm setting

You can set the on/off of the driver condition monitoring system.

11 Door opening warning

You can set the on/off of the door opening warning function.

■ Lighting setting

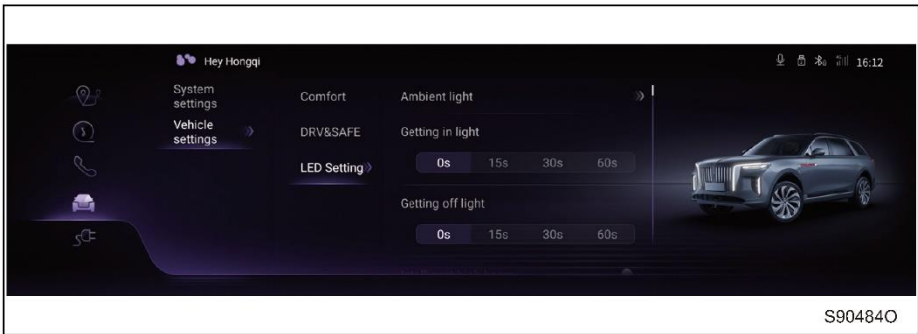
**1** Ambient lamp

You can set the on/off the ambient lamp.

The brightness and color can be adjusted, and the color of ambient lamp can be set to vary with the driving mode either.

2 Boarding lighting

You can set the on/off the boarding lighting and the lighting duration.

3 Getting-off lighting

You can set the on/off the getting-off lighting and the lighting duration.

4 IHC

You can set the on/off the IHC.

Charging setting

Users can know the current charging information of the vehicle through the charging setting interface.



- 1** State of Charge
 - The charging port cover can be opened/closed.
- 2** Charging time
 - You can turn on/off the scheduled charging and set the start and stop time of the scheduled charging.
- 3** Limit value
 - You can set the charge/discharge limit.
- 4** Energy consumption
 - The energy consumption value is displayed in a curve.
- 5** Setting
 - Low battery reminder: The range of low battery reminder can be set according to the demand.

5-2. Operating the multimedia system Travel

Touch and press the [Travel] button on the screen in the main menu interface to access the navigation interface.



Browsing the map

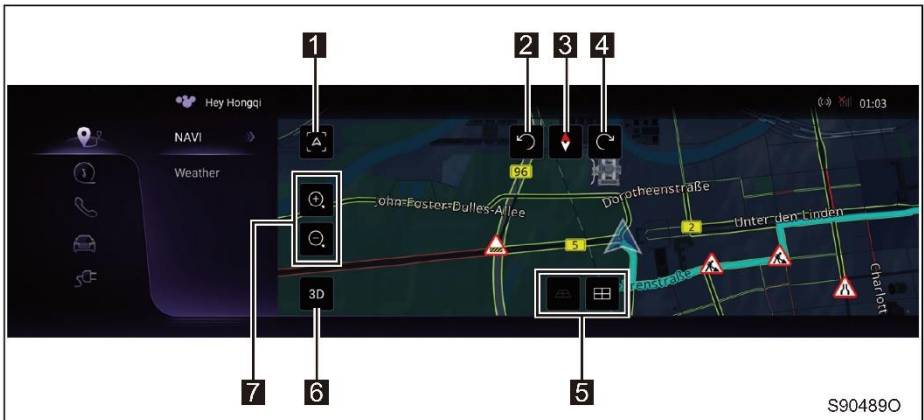

- 1** This icon appears after you move the map manually. It moves the map back to follow the current GPS position. Automatic map rotation is also re-enabled. The map manipulation buttons disappear, and the navigation continues.
- 2** **4** Changes the horizontal view angle of the map.
Tap once to modify the view in a large step or tap and hold the button to modify it continuously and smoothly.
- 3** Compass. The direction indicated in red shows North.

5-2. Operating the multimedia system

- 5** Change the vertical view angle of the map in 3D mode.

Tap once to modify the view in a large step or tap and hold the button to modify it continuously and smoothly.

- 6** Switch between the 3D perspective, 2D Heading up, and 2D North up map view modes. In Heading up mode the map is rotated so its top always points in the current driving direction. This is the default orientation in 3D map view mode. In North up mode, the map faces North.

- 7** Change how much of the map is displayed on the screen.

Navigation uses maps that let you examine the locations at various zoom levels, always with optimized content. It always displays street names and other text with the same font size, never upside-down, and you only see the streets and objects that you need.

Map scaling has a limit in 3D map view mode. If you zoom out further, the map switches to 2D view mode.

Tap once to modify the view in a large step or tap and hold the button to modify it continuously and smoothly.

Setting a destination

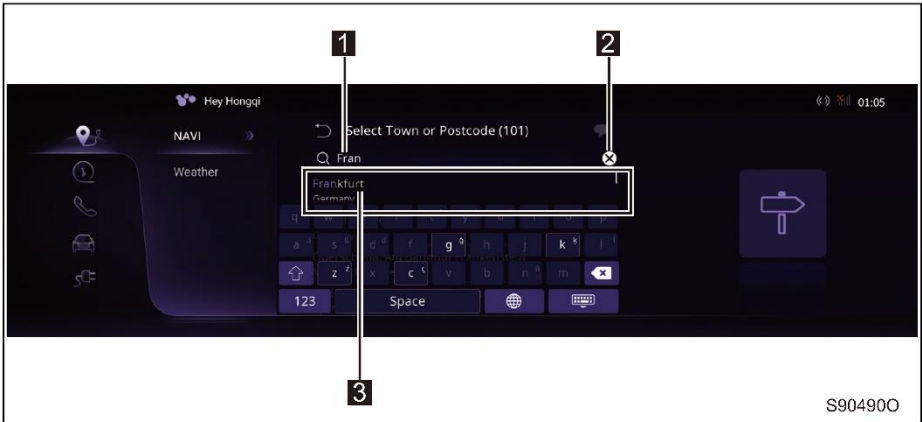

- 1** Input field showing the text that you type. You only need to enter a few letters to get a result. The most likely result appears below the input field as you enter new letters.
- 2** Delete the contents of the input field.
- 3** Search results. Tap your intended destination to continue.



The route is calculated, and the map appears showing the entire route, where you can check route information **1** and alternative routes **2**. Tap **4** to modify the route parameters.

- 3** Route information, including distance, time of arrival and traffic delay.
- 5** Change the zoom level on the displayed map or reset the default zoom level with the middle button.

5-2. Operating the multimedia system

- 6** A map displaying the entire route.



- 1** You can select from the following route planning method types:

Button	Description
Fast	Gives a quick route if you can travel near the speed limit on all roads. Usually, the best selection for fast and normal cars.
Easy	Results in a route with fewer turns and no difficult maneuvers. With this option, you can take, for example, the motorway instead of a series of smaller roads or streets.
Short	Gives a short route to minimize the travel distance. Usually optimal for pedestrians, cyclists or slow vehicles. Searching for a short route regardless of the speed, this route type is rarely optimal for normal vehicles.
Green	Gives a quick but fuel-efficient route based on the fuel consumption data. Travel cost and CO2 emission calculations are estimations only. They cannot take elevations, curves and traffic conditions into consideration.
Economical	For vehicle types where green routing is not available, this method combines the benefits of Fast and Short. It is like the Fast route, but it takes other roads as well to save fuel.

Navigation view

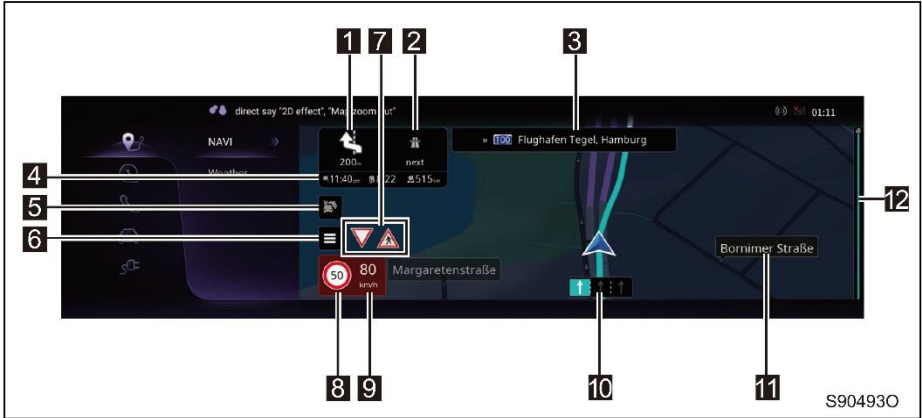

- 1** The field in the top left corner displays the next maneuver. Both the type of the maneuver (turn, roundabout, exiting motorway, and so on) and its distance from the current position are displayed.
- 2** A smaller icon shows the type of the second next maneuver if it is near the first one. Otherwise, only the next maneuver is displayed. Tap the icon of the actual maneuver to open the Itinerary screen.
- 3** Displays the name of the next street. If you have not selected a route destination, you can see nearby house numbers (where available).
- 4** Three data fields show the following information:
 - A. The estimated time of the arrival at the destination.
 - B. The remaining time of the trip.
 - C. The remaining distance to the destination.
- 5** Traffic information. By tapping it, you can check traffic details.
- 6** Navigation menu. By tapping it, you can reach other functions in Navigation.
- 7** Traffic signs. They show warnings for the current road (for example, dangers, sharp curves).
- 8** Shows the speed limit when speeding.
- 9** Shows the current speed.

5-2. Operating the multimedia system

- 10 Lane guidance. On multi-lane roads, it shows the lanes ahead and their directions. The highlighted arrows represent the lanes and direction you need to take.
- 11 Street or road name.
- 12 Route progress bar. It shows a visual representation of the portion of the route already covered.

Motorway services

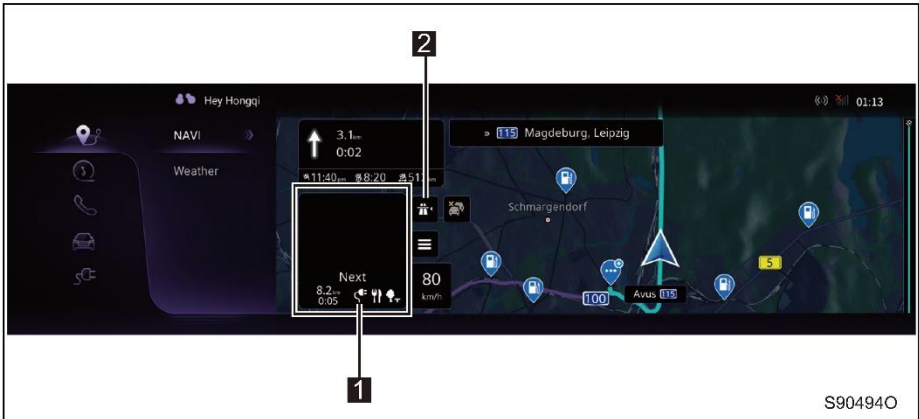

- 1 When you are driving on a motorway, the button appears on the Navigation view. Tap it to open a panel with the details of the next few service stations (petrol stations, restaurants). Tap any of them to display the exit area on the map. You can now easily add this service station as a waypoint to your route if necessary.
- 2 Motorways services. By tapping it, you can check the details of the next few service stations (petrol stations, restaurants) when travelling on a motorway.

Junction view

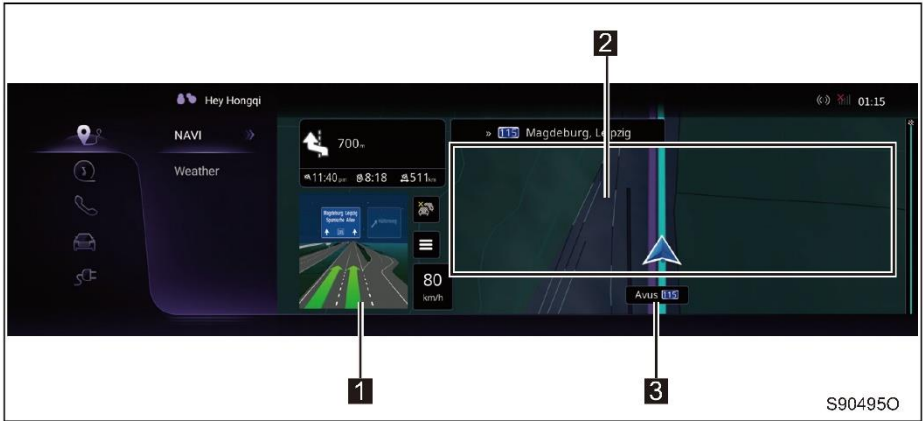

- 1** If you are approaching a motorway exit or a complex intersection, a 3D view of the junction is also shown (if the needed information exists in map data). The lanes you need to take are displayed with arrows. At the top of the screen, road signs show you additional information.
- 2** The default map view is shown next to the junction view.
- 3** Shows the current street name. By tapping it, you can open the Where Am I screen.

Signposts

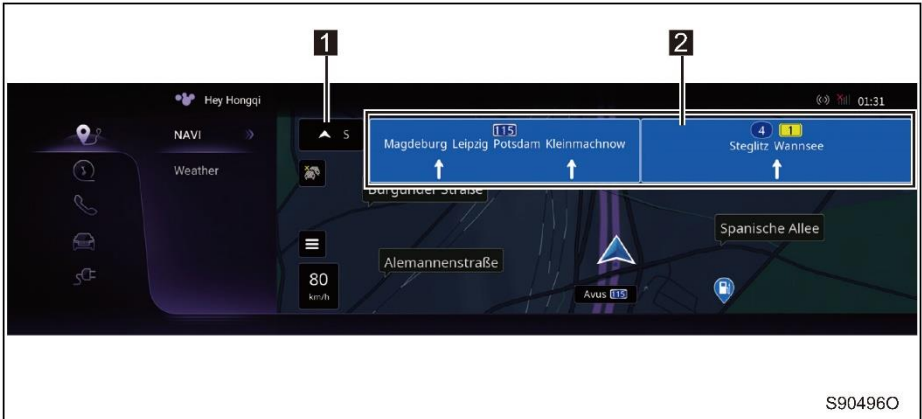

- 1** Shows the direction of your heading.
- 2** During navigation, signposts are displayed at the top of the map (if necessary, information is available in map data). The color and style of the signposts are like the real ones you can see above roads or by roadsides. They show the available destinations and the road numbers. All signposts look similar when cruising (when there is no planned route). During navigation, only the signpost that points to the lane(s) to be taken is highlighted; all the others are darker. If you want to hide the currently displayed signposts, tap any of them, and the normal Navigation view returns until new signpost information is received.

Itinerary

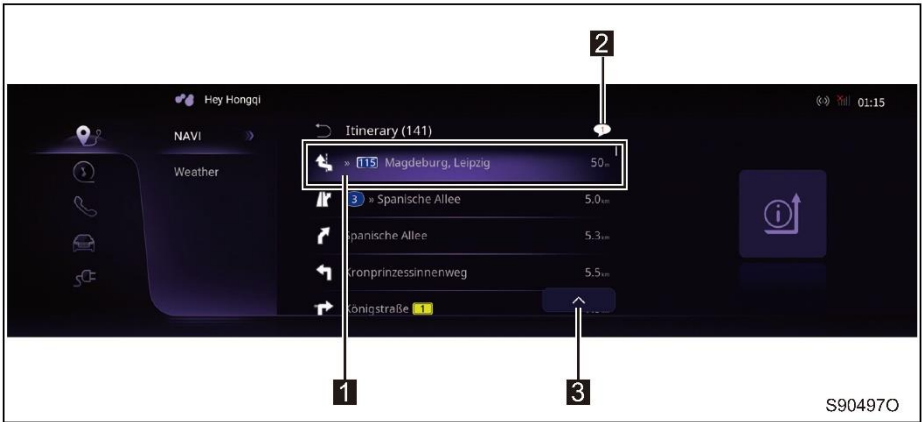

- 1** The next road to take, with an indication of the maneuver, road name and distance.
- 2** Check those notifications that contain important information but do not require immediate action from you. If there are no notifications, this icon is not displayed.
- 3** Access additional settings.

Combined search (selecting a destination with the Search in All function)

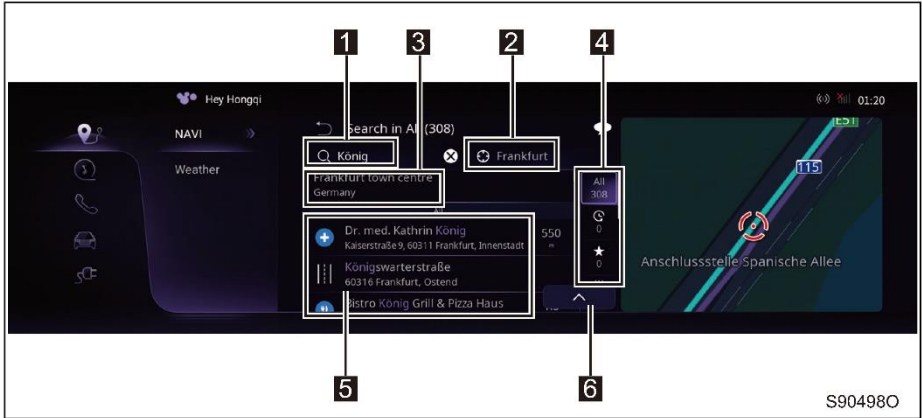

- 1** Text input field. Tap it to start entering the name of your destination.
- 2** Search area. It is the town around which the search is carried out. The default search area is the area where you are located. Tap to modify it, or for a local search, keep the default location. With the proper search area displayed, start entering the name, address, or category of the destination you are looking for using the text input field.
- 3** Quick access to the current city center.
- 4** You can use these buttons to filter the search results by type, such as previous destinations, POI, address or other types available.
- 5** A list of most likely search results. Icons indicate the type or category of the location. The name, address and distance of each search result is also shown. Tap the item you want to select as your destination.
- 6** Access additional settings.

Search by coordinates

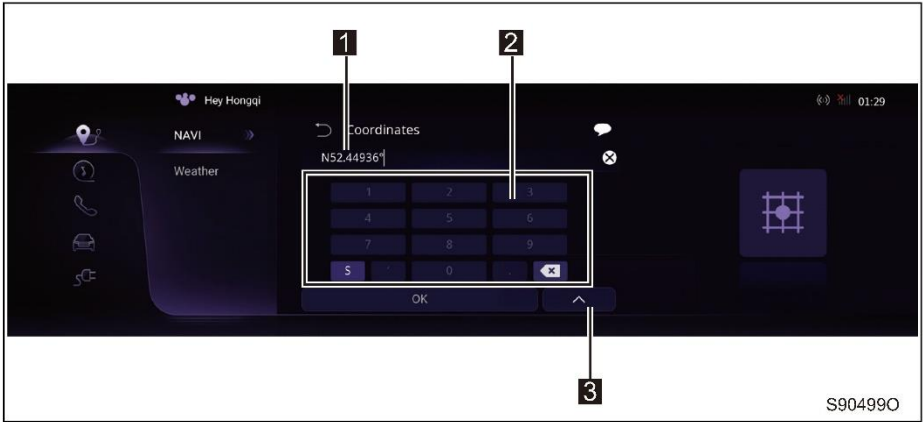

- 1** Coordinate input field. Displays the coordinates you enter using the keyboard.
- 2** Keyboard. You can enter the latitude and longitude values in any of the following formats: decimal degrees, degrees and decimal minutes, or degrees, minutes and decimal seconds.
- 3** Access additional settings.

Electric vehicle charging stations

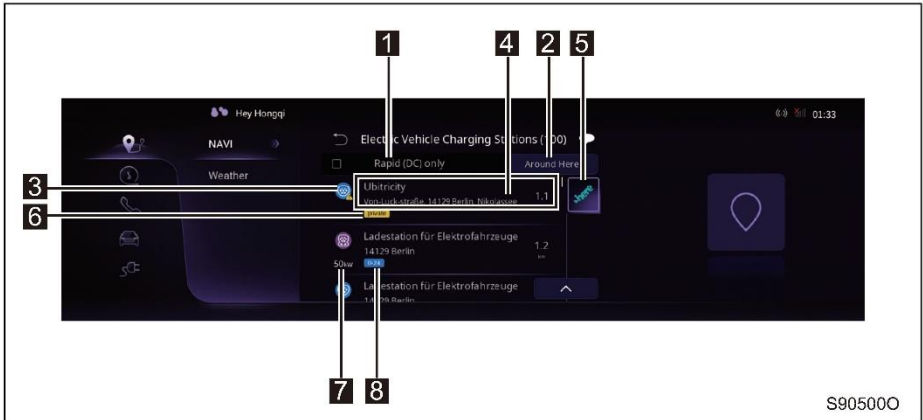

- 1** Select the charger type
- 2** Select the search area
- 3** Icon representing the charger type and its port according to the available charging cable
- 4** The name and distance of the charging station
- 5** Icon representing the charging station data provider
- 6** Indication whether the charging station is available for the general public or restricted for private use (e.g., customers only)
- 7** The charging capacity
- 8** Opening time

Parking near the destination

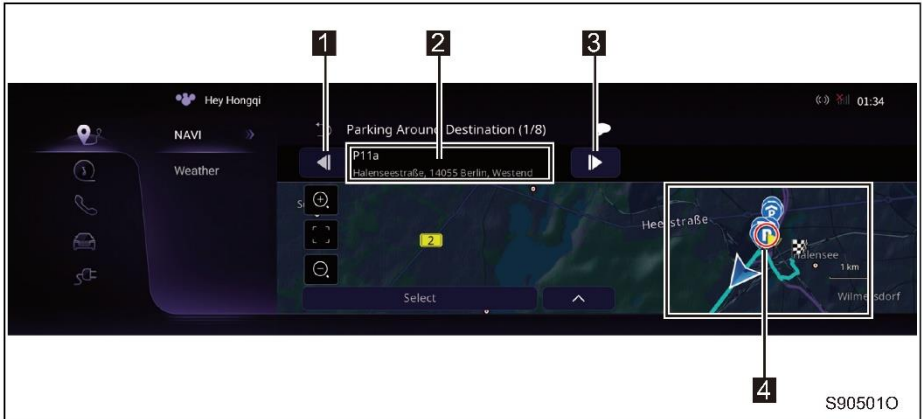

When approaching the destination, you can use the P icon to display a list of nearby parking locations.

- 1** **3** Use these buttons to navigate between parking locations.
- 2** Displays the name and address of the parking location.
- 4** Map displaying the parking location.

Settings



The following controls are available in Settings:

- 1** Tap to access additional options.
- 2** Toggle the switch to turn the selected setting on or off.



WARNING

■ During driving

- When navigating the path through the navigation system, please drive according to the actual traffic rules. If you only follow the path of the navigation system, you may sometimes violate traffic rules and cause traffic accidents.
- During driving, the driver should not carry out address search and other operations, and these operations can be only done after stopping the vehicle. Failure to observe the situation ahead may lead to traffic accidents.



Notice

- **At present, all on-board navigation systems have certain limitations. Satellite condition, road structure, vehicle condition and other factors may affect the accuracy of vehicle positioning, which will affect the normal function of the system. If you have any questions, please contact the authorized FAW Hongqi dealer.**
- **Network connection quality**
Network connection quality will vary due to the constant change of antenna position, the difference of signal strength and the influence of nearby objects (such as trains and transmitting stations), which make it difficult to maintain perfect receiving quality.
- **As the navigation version is constantly updated, the actual operation interface may be different from the schematic diagram. Please refer to the latest version.**

5-2. Operating the multimedia system Entertainment

Touch the [Entertainment] button on the screen in the main menu interface to access the entertainment interface.

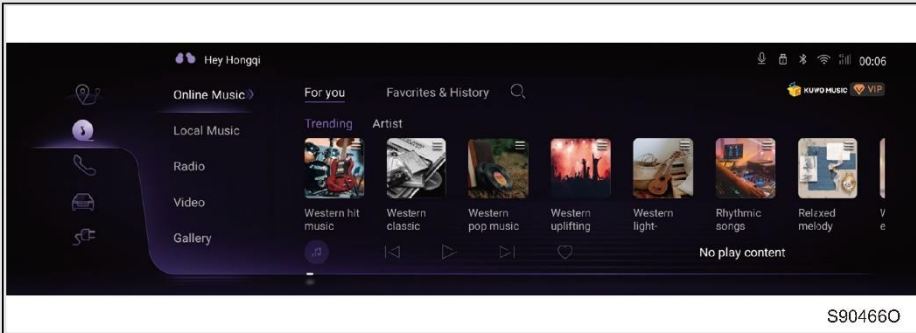

Online Music

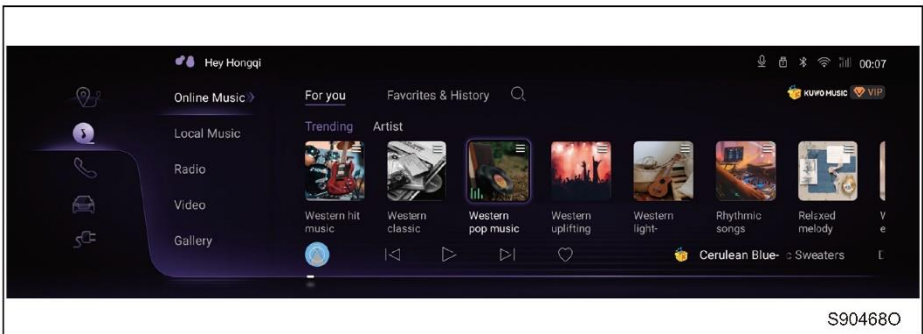

- You can view and play in the Recommendations and Collection History interface.
- You can manually search for music to play.
- Touch the Play icon below to enter the Play interface, where you can view the song list, collect music, select sound source quality, switch play mode, adjust sound effect settings, etc.

Local Music



- You can view and play in the Bluetooth, USB1, USB2 and Preset interfaces.
- Touch the Play icon below to enter the Play interface, where you can view the song list, switch play mode, adjust sound effect settings, etc.

Radio station



- You can view and play in the FM/AM/DAB/Collection interfaces.
- You can manually search the radio.
- In the Play interface, you can view the radio list, collect, search for radios, adjust sound effect settings, etc.

Video

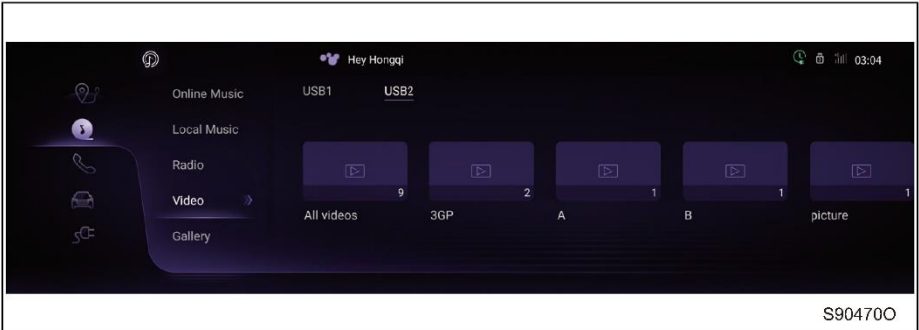

- You can view and play in the USB1 and USB2 interfaces.

Picture

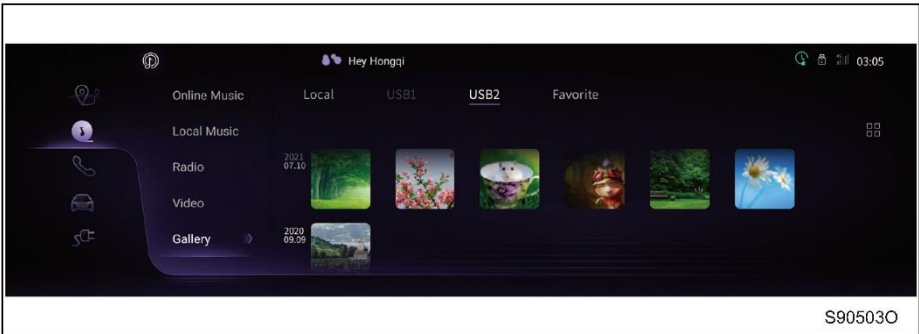

- You can view and play in the Local, USB1, USB2 and Favorites interfaces.
- Touch the picture to access the play interface, where you can play the picture slide.

Antenna

The radio antenna is built into the shark fin antenna.

5-3. Operating the on-board Bluetooth phone Hands-free system

The hands-free system has the function of using the phone without touching the mobile phone.

The system supports Bluetooth® phone. Bluetooth® is a wireless data system that enables a mobile phone to connect to a hands-free system wirelessly.

■ Phone button

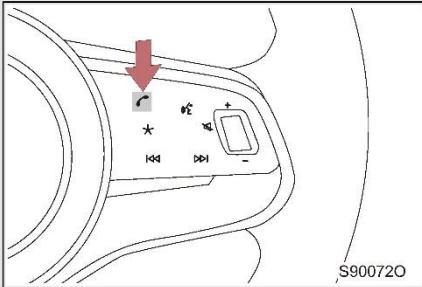

The phone button is located in the position shown in the figure.

See the following table for specific functions:

Information description	Function
Press and release	In case of an incoming call: answer the current incoming call Call/dial-out state: hang up the current call; In case of no incoming call: display the last call information and pressing again will dial out.
Press and hold	In case of an incoming call: hang up the current call; In case of no incoming call: automatically dial out the last call number.

Before using the hands-free system, you must bind a Bluetooth phone.

■ Bluetooth microphone

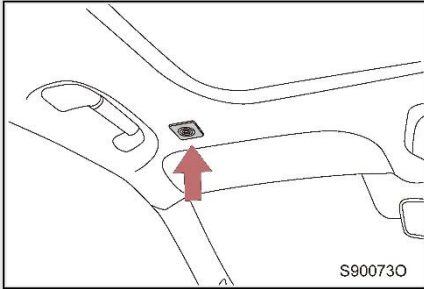

Located near each handle of the vehicle ceiling.

- If the volume of reception is too high, you may hear an echo.
- Try to face the microphone when talking.
- Under the following circumstances, it may be difficult for the other party to hear the sound:
 - Phone signal is poor.
 - Drive on an unpaved road.
 - Drive at high speed.
 - Window is open.
 - The A/C outlet is facing the microphone.
 - The air volume of A/C blower is too high.

■ The system will be inoperative under the following conditions:

- The used phone does not support Bluetooth®.
- The mobile phone is turned off or in-flight mode.
- The current location is outside the service area.
- The mobile phone is not connected.
- The battery power of the mobile phone is low.

■ Bluetooth® antenna

If the mobile phone is placed in the glove box or is in contact with or covered by metal materials, the connection signal may deteriorate.

■ Battery level/signal status

This display may not be exactly consistent with mobile phones.

5-3. Operating the on-board Bluetooth phone

■ About Bluetooth®

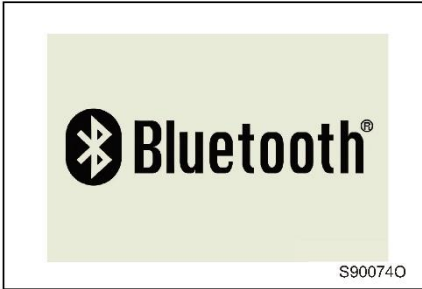

Bluetooth® is the trademark of Bluetooth SIG, Inc.

■ Compatible type

The Bluetooth hands-free system is only compatible with Bluetooth certified (SIG) phones sold through regular channels and of mainstream brands.



Notice

■ When getting off the vehicle

Do not leave items such as mobile phones in the vehicle. The temperature inside the vehicle may rise, causing damage to mobile phones.

5-3. Operating the on-board Bluetooth phone Bluetooth® phone

The system supports the functions of dialing, answering incoming calls, hanging up calls, viewing contacts, viewing call history and so on.

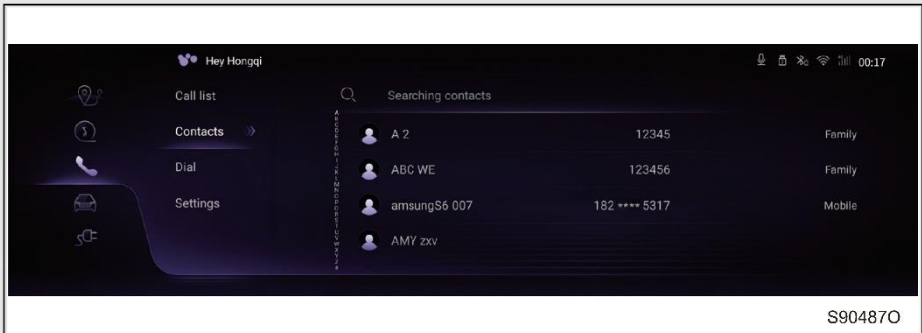

Method of entering Bluetooth phone interface: connect Bluetooth, touch the [Bluetooth Phone] in main menu to access the Bluetooth phone interface.

Note: If the Bluetooth is not connected, touch the setting button to connect the Bluetooth.

Contact

■ Contact saving

After the Bluetooth of the mobile phone is bound successful, the system will automatically download the contact information from the bound phone.

■ Contact view

The contact entry on the mobile phone can be viewed by touching and pressing the [Contact] button on the screen of the main interface in the phone.

■ Contact deletion

The system supports manually deleting a matching phone and synchronously deleting the contact of the phone in the system; You can also manually delete stored contacts.



Notice

- **Contacts will only appear on the screen if the phone supports contact download.**

Call history

■ Call history view

You can view the received, missed, or dialed calls on the mobile phone by pressing the [Call History] button on the screen of Bluetooth phone interface.



Notice

- **The call history is displayed on the screen only if the phone supports the call history download and allows manual download.**

Make a call

Dialing method:



- 1: Dialing through contact or call history.
- 2: Enter the number through the dialing keyboard to dial.

Answer/hang up the phone

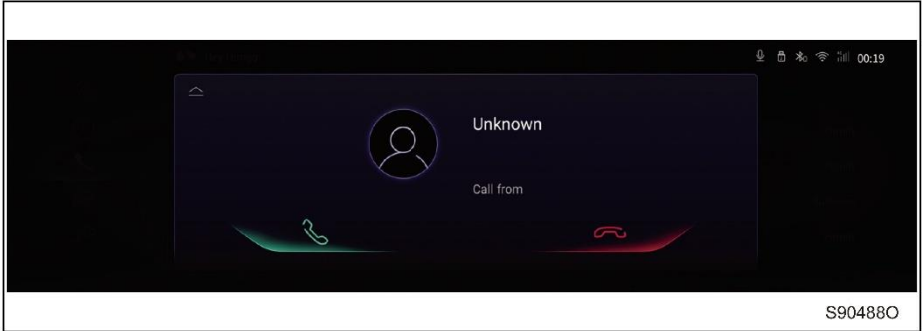
When the phone calls in, a call reminder pops up.



How to answer/hang up the phone:

Method 1: touch the  /  button on the screen to answer/hang up the phone.

Method 2: press the  button on the steering wheel to answer (press and release)/hang up (press and hold) the phone.

Handsfree mode switching

Touch the  button on the screen during the call, and then you can switch between private/hands-free.

Because some mobile phones do not support private/hands-free switching, the Bluetooth connection may be disconnected during private/hands-free switching.

Microphone mute

Touch the  button on the screen during the call, and then you can switch between mute and non-mute microphone. When the microphone is muted, the caller will not hear your sound.

Call waiting

Touch the  button on the screen during the call, and then you can hang up the phone temporarily, or resume the call through touching again.

■ Auto connection of Bluetooth

When the Bluetooth is turned on, the connected Bluetooth device will be automatically connected.

■ Privacy protection

Contacts and call history of each mobile phone can only be displayed after the mobile phone is successfully connected. You cannot view the contacts and call history of any mobile phone when the phone is not connected in place.



WARNING

■ **During driving**

Do not use a mobile phone or connect to a Bluetooth® system.



Notice

■ **When getting off the vehicle**

Do not leave items such as mobile phones in the vehicle. The temperature inside the vehicle may rise, causing damage to mobile phones.

5-4. Operating the voice recognition

Voice recognition

Users can realize the voice control of the system through the voice recognition. The control functions mainly include Bluetooth phone, A/C control, etc.

This vehicle supports four sound source localization, that is, the voice recognition system can be used in the first row and the second row. When the voice recognition system is triggered in one position, the voice function cannot be used unless the voice recognition system is triggered again in other positions.

Voice recognition trigger

Method 1: press the button on the steering wheel to trigger the voice recognition system.

Method 2: speak out the wake-up password to trigger the voice recognition system.

Method 3: speak out the voice command directly to trigger the voice recognition system and execute the voice command.

You can set the on/off of the audiovisual in the system settings of the multimedia system. (Refer to P.220)

Voice recognition help

After triggering the voice recognition, speak out "View Help" to open the voice help interface, where you can know the commonly used voice commands.

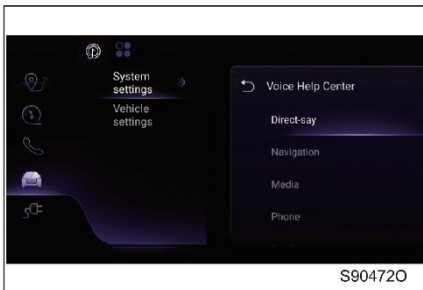

Look at the prompts in the voice interface to learn about common voice commands.

Voice recognition exit

Method 1: After triggering the voice recognition system, if there is no recognition commands, the system will automatically exit the voice recognition.

Method 2: The system will exit the voice recognition after the normal execution of voice commands.

Method 3: The system will exit the voice recognition after you touch the  button on the steering wheel.

Method 4: You can speak out the exit command to exit the voice recognition.



Notice

- **The voice recognition results are for reference only.**
- **Please use standard and clear Mandarin, and do not activate the voice recognition when the environment is noisy, to avoid incorrect recognition results.**
- **Try to avoid using the voice recognition while driving. If voice recognition is used in such case, please pay attention to the road conditions to prevent danger.**

5-5. Operating Mobile APP Hongqi Zhilian APP

The vehicle can be remotely controlled and operated through the mobile APP.

- Open the logged-in Hongqi APP to access the APP home.

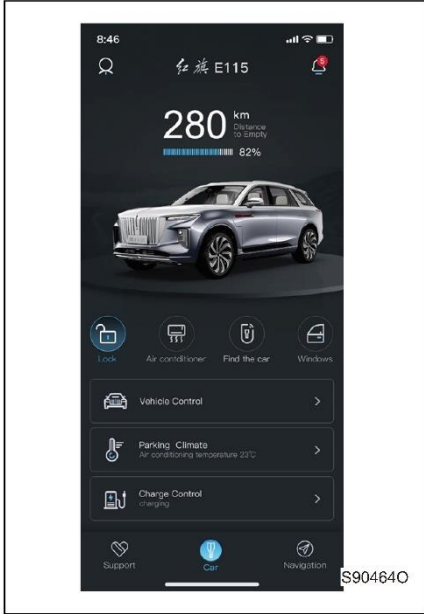

1 Service

Operations such as network inquiries can be performed.

2 My car

Information view: You can view the endurance range and remaining power. Remote control: In the main interface, you can quickly operate the car lock, A/C, car search and window. Enter the vehicle foundation control interface through [Vehicle Control] in the main interface to view the total mileage, tire pressure, doors, lights, bonnet, and trunk, and operate the vehicle locks, windows and skylight. Enter the vehicle environment control interface through [Parking Climate] in the main interface to operate A/C, seat heating, steering wheel heating and other functions.

Enter the vehicle charging control interface through [Charge Control] in the main interface to view the vehicle charging related status and operate the remote charging.

3 Message Center

Messages can be viewed.

4 Personal center

In this interface, you can set and view user information, vehicle information, privacy rights, account and PIN management, common problems and other functions.

Login

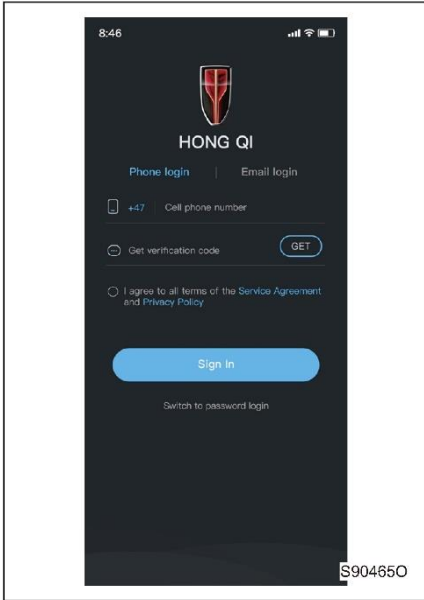

Mobile Number Login

Enter the area code and mobile phone number to obtain the verification code. After entering the verification code, touch the mobile phone screen key [Login] to log in to the system.

Mailbox Login

After the first login, you can choose to bind your mailbox, and then you can use your mailbox as the login credentials.

■ APP download

Apple Store or Google Play.

■ Software version

As the software version is constantly updated, the actual operation interface may be different from the schematic diagram. Please refer to the latest version.



WARNING

■ Mobile phone lost

If your mobile phone is lost, it will increase the risk of vehicle theft. Please keep it properly and contact the authorized FAW Hongqi dealer where necessary.

■ Network connection quality

Network connection quality will vary due to the constant change of antenna position, the difference of signal strength and the influence of nearby objects (such as trains and transmitting stations), which make it difficult to maintain perfect receiving quality.



Notice

■ Use permission

When using APP, some functions need to be given corresponding permissions, and you should ensure that the third-party tools do not prohibit the network permissions of APP, otherwise the system may not work properly.

■ In case of failure

If any troubleshooting fails, please contact the authorized FAW Hongqi dealer.

■ Preheating the compartment

Be careful not to leave the car keys in the car before you start preheating the passenger compartment. Before preheating starts, all doors will be locked.

6-1. Operating the air-conditioning (A/C) system

Fully automatic A/C system	258
Fully automatic A/C system — front control system	259
Fully automatic A/C system — second-row control system	267
Third-row A/C control system	273
Heat rear windshield.....	277

6-2. Operating the interior lights

List of interior lights	278
-------------------------------	-----

6-3. Operating storage box

List of storage boxes	281
Trunk device	287

6-4. Other in-car equipment

On-board wireless charging system...	288
Sun visor	289
File folder	290
Make-up mirror	291
Power socket	292
220V power outlet.....	294
Seat temperature controller *	296
Seat massage function*	298
Rear center armrest *	299
Ceiling handle	300
Coat hook.....	301

6-1. Operating the air-conditioning (A/C) system Fully automatic A/C system

The vehicle is equipped with a fully automatic A/C system with multi-temperature-zone, which can automatically realize cooling and heating according to the temperature set by users, and you can also manually set the air outlet mode and air volume of each seating position.

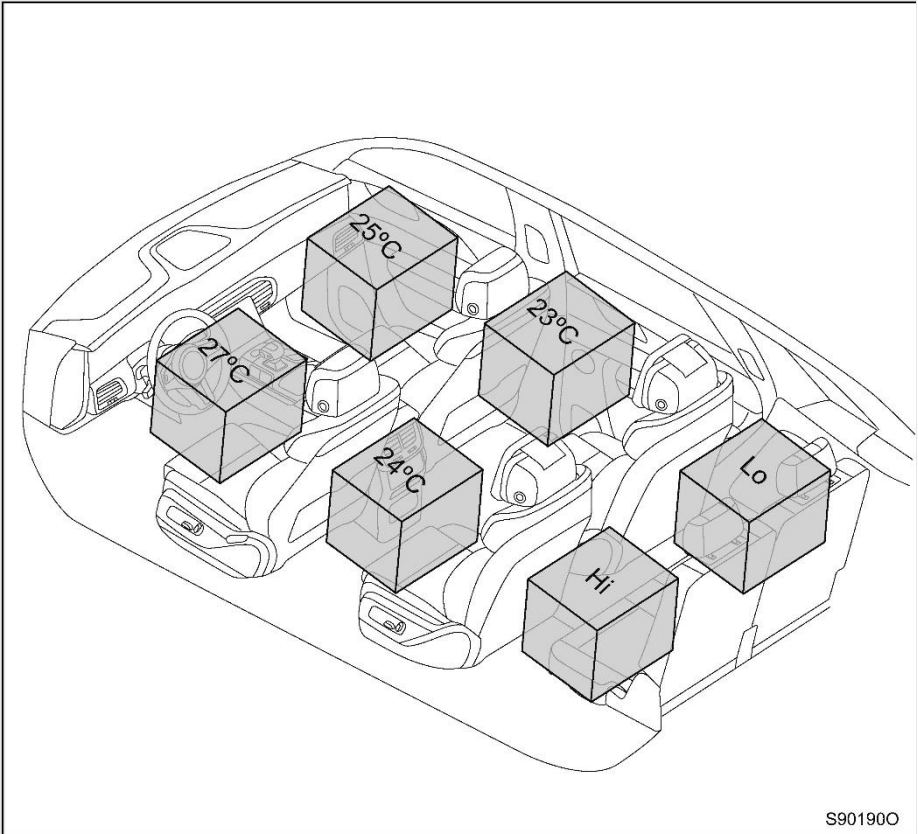

S901900

Note: This figure only takes six-seat model as an example.

6-1. Operating the air-conditioning (A/C) system

Fully automatic A/C system — front control system

Select the air outlet according to the temperature setting, and adjust the air volume automatically.

► Operation display of front A/C

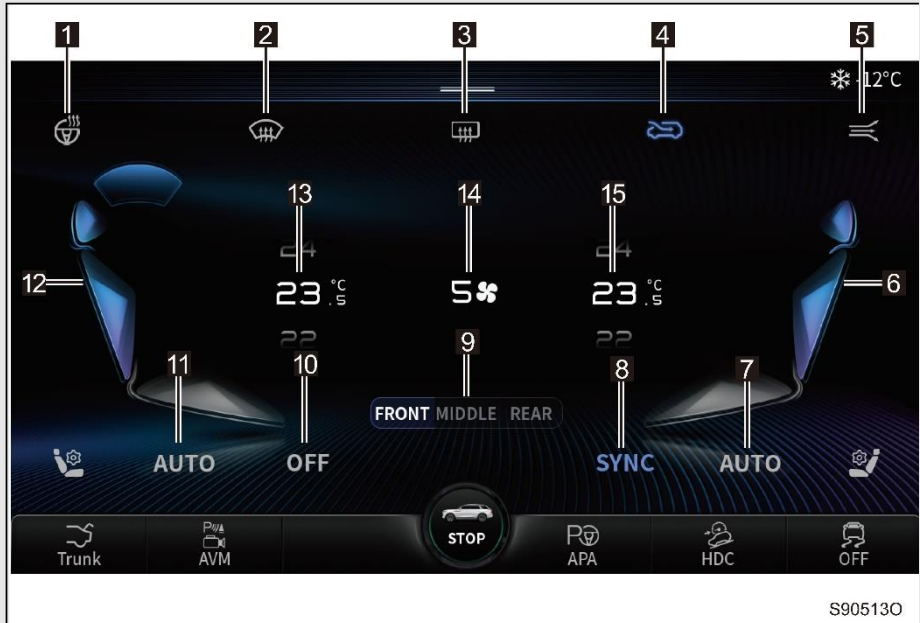

S905130

- | | |
|---|--|
| 1 Heating button on steering wheel | 2 Forced defrosting/defogging button of windshield |
| 3 Rear windshield heating button | 4 Internal/double flow/external circulation buttons |
| 5 Natural ventilation button | 6 Air outlet mode button at front passenger side |
| 7 AUTO button at front passenger side | 8 SYNC button |
| 9 Front/middle/rear switching buttons | 10 OFF button |
| 11 AUTO button at driver side | 12 Air outlet mode button at driver side |
| 13 Driver side temperature setting button | 14 Air volume setting button |
| 15 Front passenger side temperature setting button | |

Operating the automatic A/C system



Touch the [AUTO] button, the working indicator lights up and enters the automatic air conditioning mode.

In the auto A/C mode, you can set the temperature by touching the temperature setting button according to your personal needs, and the temperature display will show the set temperature simultaneously.

■ Operating AUTO mode

The air volume is automatically adjusted according to the temperature setting and environmental conditions. As a result, the following scenarios may occur.

- In summer, when the low temperature setting is selected, the system will automatically switch to the internal circulation mode.
- When the switch is pressed, the blower may not run immediately until the warm or cool air is ready for normal air delivery.

Manual setting

- Adjusting the air volume



Slide up/down the air volume setting value to adjust the air volume of the A/C system among level 1-7.

- Adjusting the temperature

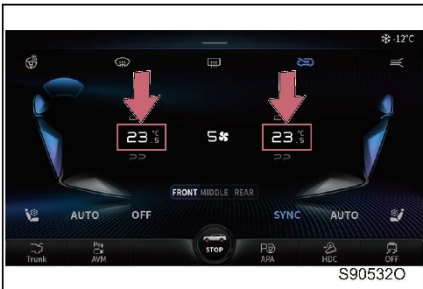

Slide up/down the temperature setting value to set the temperature.

The temperature on the driver side and front passenger side can be adjusted separately.

- Turn off the A/C

Touch the [OFF] button to turn off the air conditioner.

- Switch temperature zone control mode









Touch the [SYNC] button, the indicator will light up, and the single-temperature-zone control mode will be activated. The temperature and air outlet mode set at the driver side will be synchronized to the front passenger side and the second row.

Touch the [SYNC] button again, the indicator will go out, and the multi-temperature-zone control mode will be activated. At this time, the temperature and air outlet mode at the driver side, front passenger side and the second row can be independently controlled. In the single-temperature-zone control mode, you can directly activate the multi-temperature-zone control mode by directly operating the temperature or air outlet setting button at the front passenger side or the second row.



■ Switching the air outlet mode



Touch the air outlet mode button to select the corresponding air outlet mode, and touch the button again to cancel the air outlet mode. The air outlet mode can be selected in combination.

-  : Airflow blows to the face.
-  : Airflow blows to the feet.
-  : Air flow blows to the front windshield.
-  : Airflow blows to the face and feet.
-  : Air flow blows to the face and front windshield.
-  : Airflow blows to the feet and front windshield.
-  : Air flow blows to the face, feet, and front windshield.

■ Internal/double flow/external circulation mode switching

Touch the internal/double flow/external circulation button to switch the circulation mode. If the  button lights up, the internal circulation mode will be activated; If the  button lights up, the double flow circulation mode will be activated; If the  button lights up, the external circulation mode will be activated.

When switching to automatic air conditioning mode, the A/C system automatically switches the circulation modes.

WARNING

- **Do not use inner circulation mode in cold or rainy weather**
Using the inner circulation mode in cold or rainy weather can cause the windows to fog up and your vision can be obstructed, which could lead to a serious accident.
- **When using the inner circulation mode**
If the inner circulation mode is used for a long time, the windows may tend to fog up.
- **When cleaning the window, the system will automatically switch to the internal circulation mode to prevent the smell of washer fluid from entering the car, and if the air outlet mode is the forced defrosting/defogging of front windshield, the double flow circulation mode will be activated.**

Other functions

- Forced defrosting/defogging of front windshield

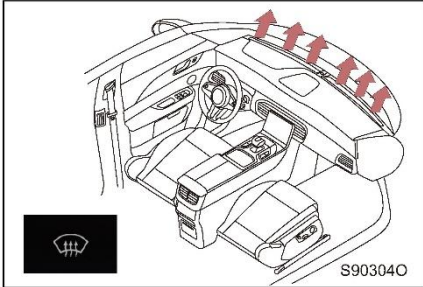

Touch the  button, the indicator will light up, and the forced defrosting/defogging of the front windshield will be activated.

If it is currently in internal circulation mode, the system will automatically switch to external circulation mode, and it cannot be manually switched to the internal circulation mode.

Increase the air volume to defrost/defog the front/side windshield as soon as possible.

Notice

- **The window may be foggy under the following conditions, please pay attention to driving safety**
 - When the humidity inside the car is high, the windows tend to fog up.
 - In rainy weather, the windows may fog up.
 - If the inner circulation mode is used for a long time, the windows may fog up.

WARNING

- **Prevent windshield fogging.**
 - Do not use the front windshield forced defrosting/defogging mode during cooling operation when the weather is extremely humid. The temperature difference between the air outside the car and the windshield may fog up the outer surface of the windshield, thus obstructing your vision.
 - Do not place any objects that may cover the air outlets on the instrument panel as they may block the airflow and thus prevent the front windshield from defogging.
- Natural ventilation

Touch the  button to activate the natural ventilation mode, the air inlet mode is switched to external circulation, and the air outlet mode is switched to face + foot blowing. Currently, the compressor stops operating, thus saving energy.

■ Auto defogging system (ADS) *

When the current windshield is fogged and tends to affect driving safety, the A/C system will activate the ADS, and the air volume will be appropriately increased and blown to the front windshield. When the tendency is released, the A/C system will automatically switch back to the operating state before defogging. When the auto defogging mode is activated, you can operate the auto A/C ON button or the air outlet mode adjustment button to stop the auto defogging, and the A/C system will not repeatedly start this mode for a period.

Prompt: When the ADS is activated, the air output of the A/C system will be large.

■ Deicing

When the complete vehicle is charging, check whether there is icing through deicing detection cycle. If there is icing, the deicing mode will be automatically entered, and after the deicing, the deicing mode will be automatically exited. During the deicing, it is temporarily impossible to heat the cab.

■ Battery cooling/heating

If the battery needs to be cooled/heated, the vehicle will automatically cool/heat the battery. After the cooling/heating function is turned on, the A/C effect in the vehicle may be poor.

Fragrance (Exclusive+)

Swipe down the front A/C display screen to pull out the setting menu to set the fragrance system, environmental mode, key tone and screen brightness.

■ Fragrance system*



After the appropriate fragrance mode is selected, the system will cooperate with the A/C to improve the interior environment of the car for enhanced comfort of the driver and passengers.

* The switch for "Fragrance" is not available for the European version of the HONGQI E-HS9

The system will be deactivated in ECO driving mode

Adjusting the air outlet flow, opening and closing the air outlet

► Front center air outlet

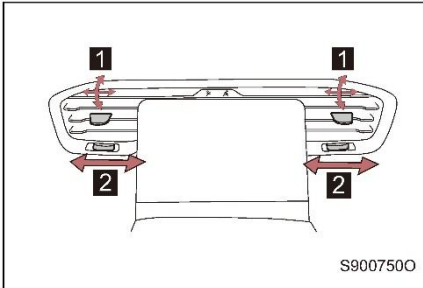

- 1** Directs airflow to the left or right, upper or lower side.
- 2** Toggle to open or close the air outlet.

► Front side air outlet

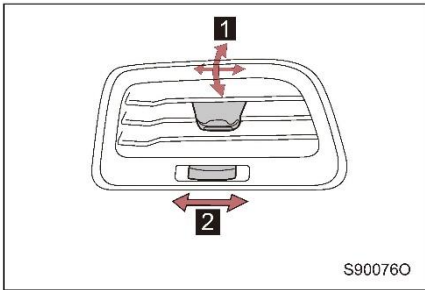

- 1** Directs airflow to the left or right, upper or lower side.
- 2** Toggle to open or close the air outlet.

■ Remote operation of the A/C system

- You can turn on and off the fully automatic A/C, set the A/C temperature and running time, and turn on/off the windshield defrosting function via the mobile APP. (Refer to P.254)

■ Circulation mode

- Switch to inner circulation mode when driving on dusty roads (e.g., tunnels) or on roads with traffic congestion. This effectively prevents outside air from entering the vehicle. When cooling, the set temperature can be achieved faster in internal circulation mode.
- If the inner circulation mode is used for a long time, the windows may fog up.

■ Windshield defroster

- When the defrosting/defogging function is activated, the air volume may be increased, and increasing the air volume can defrost/defog the front windshield as soon as possible.

■ Air conditioning odor

- During use, various odors from inside and outside the vehicle may enter and accumulate in the A/C system. This may cause odors to emanate from the air outlets.

**Notice****■ A/C energy saving mode**

- When the vehicle is in the LBL mode or the battery power is less than 10%, the A/C system will enter the energy saving mode. In this case, the cooling effect and heating effect will decrease, and some functions will be prohibited.
- When remote control of the air conditioning from the Hongqi APP is activated, you must manually switch on the air conditioning the next time you get back into the car.

6-1. Operating the air-conditioning (A/C) system

The second-row A/C control system can synchronously or independently adjust the temperature and air outlet mode in the second-row according to the needs of occupants, so as to improve the ride comfort.

► Operation display of front A/C



- | | |
|---|--|
| 1 Button to set the air outlet mode for the second-row occupants | 2 Button to set temperature for left rear occupants |
| 3 Air volume setting button | 4 Button to set temperature for rear occupants |
| 5 AUTO button | 6 Front/middle/rear switching buttons |
| 7 OFF button | |

► Operation panel of the second-row A/C

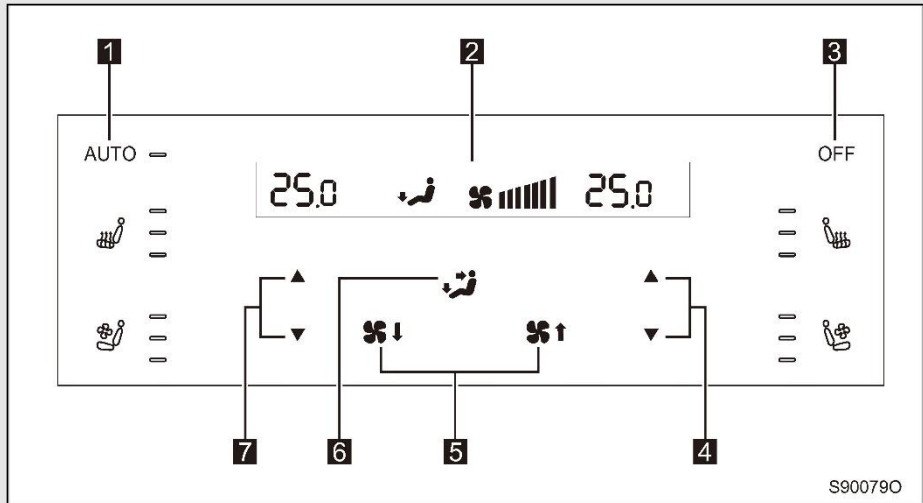

- 1** AUTO button
- 2** Display
- 3** OFF button
- 4** Button to set temperature for right rear occupants
- 5** Air volume setting button
- 6** Button to set the air outlet mode for the second-row occupants
- 7** Button to set temperature for left rear occupants

Operating the automatic A/C system



Method 1: touch the [AUTO] button on the A/C control display, and the indicator will light up to activate the auto A/C mode.

6-1. Operating the air-conditioning (A/C) system

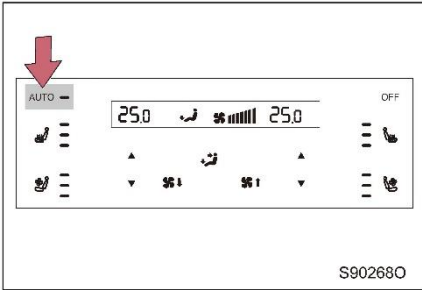

Method 2: touch the [AUTO] button on the operation panel, and the indicator will light up to activate the auto A/C mode.

In the auto A/C mode, you can set the temperature by touching the temperature setting button according to your personal needs, and the temperature display will show the set temperature simultaneously.

■ Operating AUTO mode

The air volume is automatically adjusted according to the temperature setting and environmental conditions. As a result, the following scenarios may occur.

- In summer, when the low temperature setting is selected, the system will automatically switch to the internal circulation mode.
- When the switch is pressed, the blower may not run immediately until the warm or cool air is ready for normal air delivery.

Manual setting

■ Adjusting the air volume





Method 1: slide up/down the air volume setting value in the operation display of A/C to adjust the air volume of the A/C system among level 1-7.

Method 2: operate the  air volume setting button on the operation panel to adjust the air volume of A/C system among level 1-7.

■ Adjusting the temperature



Method 1: slide up/down the temperature setting value in the operation display of A/C system to set the temperature.

Method 2: operate the  /  temperature setting button on the operation panel to set the temperature.

It's feasible to separately adjust the temperature in the areas for the left rear occupants and right rear occupants.

■ Turn off the A/C

Touch the [OFF] button on the display or the [OFF] button on the operation panel to turn off the A/C system.

6-1. Operating the air-conditioning (A/C) system



■ Switching the air outlet mode



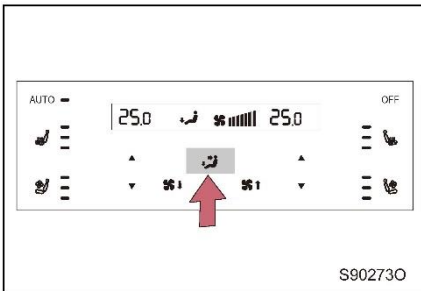

Method 1: touch the air direction arrow to select the corresponding air outlet mode, and then press and touch again to cancel the air outlet mode. The air outlet mode can be selected in combination.



Method 2: touch the air outlet mode setting button to switch the air outlet mode.

 /  : Airflow blows to the face.

 /  : Airflow blows to the feet.

 /  : Airflow blows to the face and feet.

Adjusting the air outlet flow, opening and closing the air outlet

► Second-row central air outlet

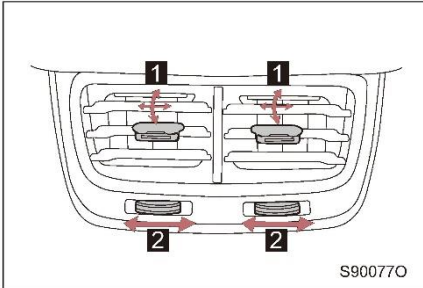

- 1** Directs airflow to the left or right, upper or lower side.
- 2** Rotate the knob to open or close the air outlet.

► Second-row side air outlet

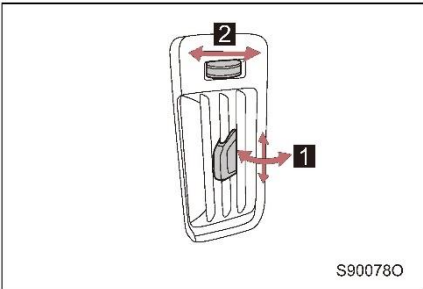

- 1** Directs airflow to the left or right, upper or lower side.
- 2** Rotate the knob to open or close the air outlet.

6-1. Operating the air-conditioning (A/C) system

Third-row A/C control system

The third-row A/C system has heating function other than cooling function. When the front A/C system starts heating, the third-row A/C setting button can be operated to independently heat the third-row area; when the front A/C system starts cooling, you can operate the third-row A/C setting button to circulate the air in the third-row area.

► Operation display of front A/C



- | | | | |
|----------|---|----------|---|
| 1 | Button to set the air outlet mode for the third-row occupants | 2 | Button to set the temperature for third row left occupants |
| 3 | Air volume setting button | 4 | Button to set the temperature for third-row right occupants |
| 5 | Front/middle/rear switching buttons | 6 | OFF button |
| 7 | AUTO button | | |

► Operation panel of the third-row A/C

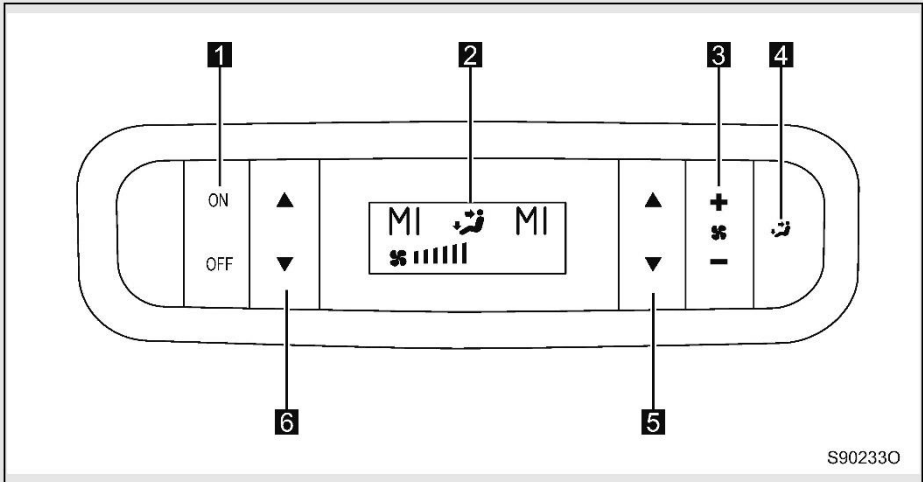

- | | |
|---|--|
| <p>1 ON/OFF button</p> <p>3 Air volume setting button</p> <p>5 Button to set the temperature for third-row right occupants</p> | <p>2 Display</p> <p>4 Button to set the air outlet mode for the third-row occupants</p> <p>6 Button to set the temperature for third row left occupants</p> |
|---|--|

Manual setting

■ Adjusting the air volume



Method 1: slide up/down the air volume setting value in the operation display of front A/C to adjust the air volume of the third-row A/C among level1-5.

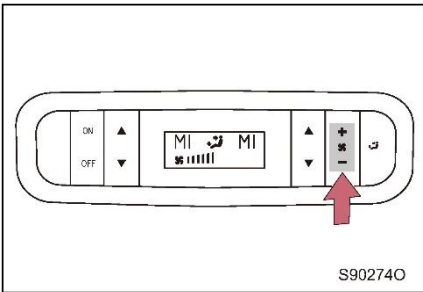

Method 2: operate the air volume setting button on the operation panel to adjust the air volume of third-row A/C among level 1-5.

■ Adjusting the temperature

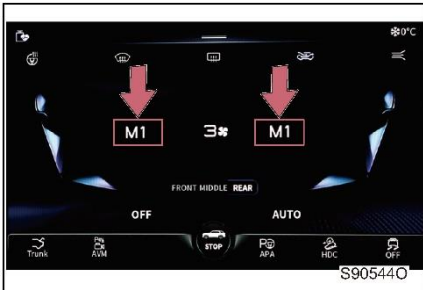

Method 1: slide up/down the temperature setting value in the operation display of front A/C to set the temperature.

Method 2: operate the ▲ / ▼ temperature setting button on the operation panel to set the temperature.

■ Turn off the A/C

Touch the [OFF] button on the display or the [OFF] button on the operation panel to turn off the A/C system.



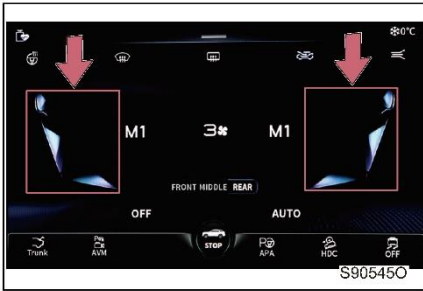

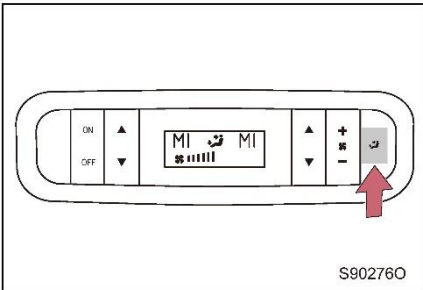

■ Switching the air outlet mode



Method 1: touch the air direction arrow to select the corresponding air outlet mode, and then press and touch again to cancel the air outlet mode. The air outlet mode can be selected in combination.





Method 2: touch the air outlet mode setting button to switch the air outlet mode.

-  /  : Airflow blows to the face.
-  /  : Airflow blows to the feet.
-  /  : Airflow blows to the face and feet.

6-1. Operating the air-conditioning (A/C) system Heat rear windshield



Touch the  button on the display, and the indicator will light up to start heating the rear windshield and exterior rearview mirror.

When the  button is touched again, the indicator goes off and the system stops working.

Note: After running for a period, the system will be automatically turned off and the indicator will go out.

WARNING

■ When the rear windshield is heated

Do not touch the heated area, as it may be hot and cause burns.

6-2. Operating the interior lights

List of interior lights

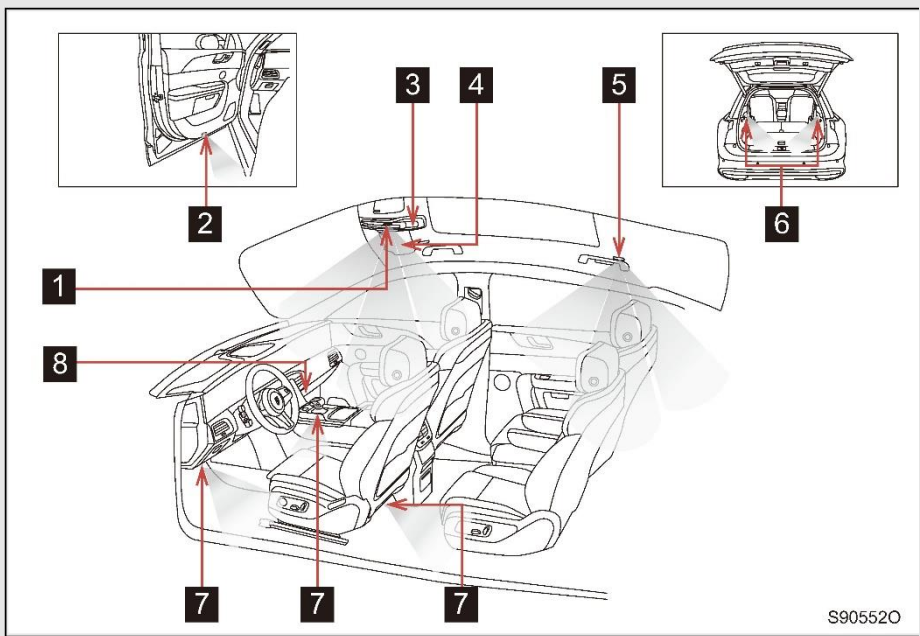



S905520

- 1** Front reading lamp
- 2** Door lamp
- 3** Front interior light
- 4** Make-up mirror lamp
- 5** Rear reading lamp
- 6** Trunk lamp
- 7** Atmosphere lamp * (See P.226)
- 8** Glove box lamp

6-2. Operating the interior lights

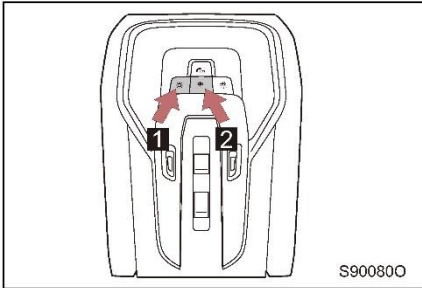
Front interior light



1 Touch the  button to turn on the front interior light, touch it again to turn off the front interior light.

2 Touch the  button, and the indicator will light up to deactivate the door linkage function; touch the button again, and the indicator will go out to activate door linkage function.

Front reading lamp

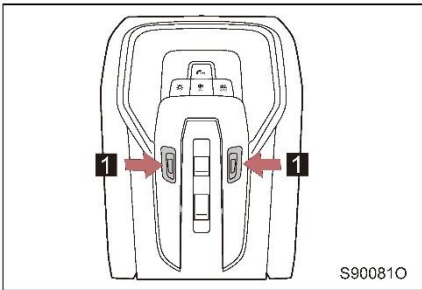

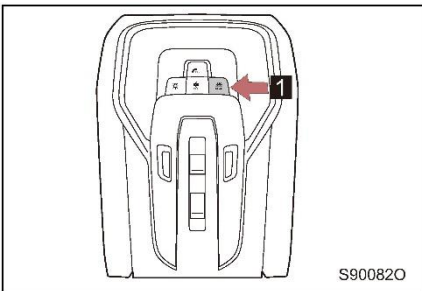

1 Touch the front reading lamp button to turn on the lamp and touch the button again to turn off the lamp.

Rear reading lamp

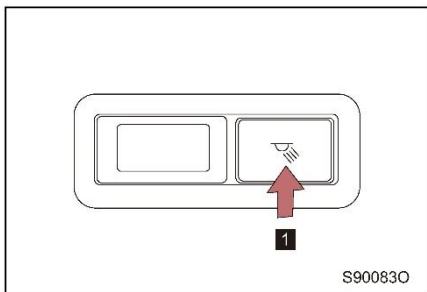

1 Touch the button  to turn on the rear reading lamp, touch it again to turn off the rear reading lamp.



- 1 Touch the  button to turn on the rear reading lamp at corresponding side and touch the button again to turn off the rear reading lamp.

Make-up mirror lamp

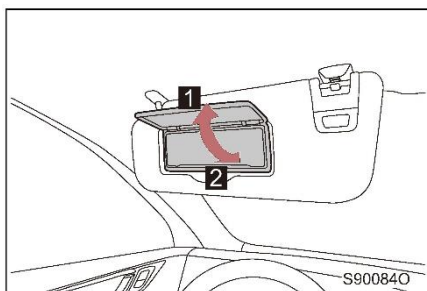

- 1 Open the sun visor, open the make-up mirror cover, and the make-up mirror lamp lights up.
- 2 Close the make-up mirror cover and the make-up mirror lamp goes out.

Energy-saving control

The front interior light switch is placed in the door linkage position. If the door is opened, the interior light will light for a period and then go out; if the power (ignition) switch and each door is closed, the interior light and atmosphere lamp will go out on a delayed basis.

Notice

■ Preventing battery depletion

Turn off the interior lights if they are not needed.

Do not open the make-up mirror cover or the door for a long time. This is because when it is turned on, the corresponding interior lights will light up, which may drain the battery.

6-3. Operating storage box List of storage boxes

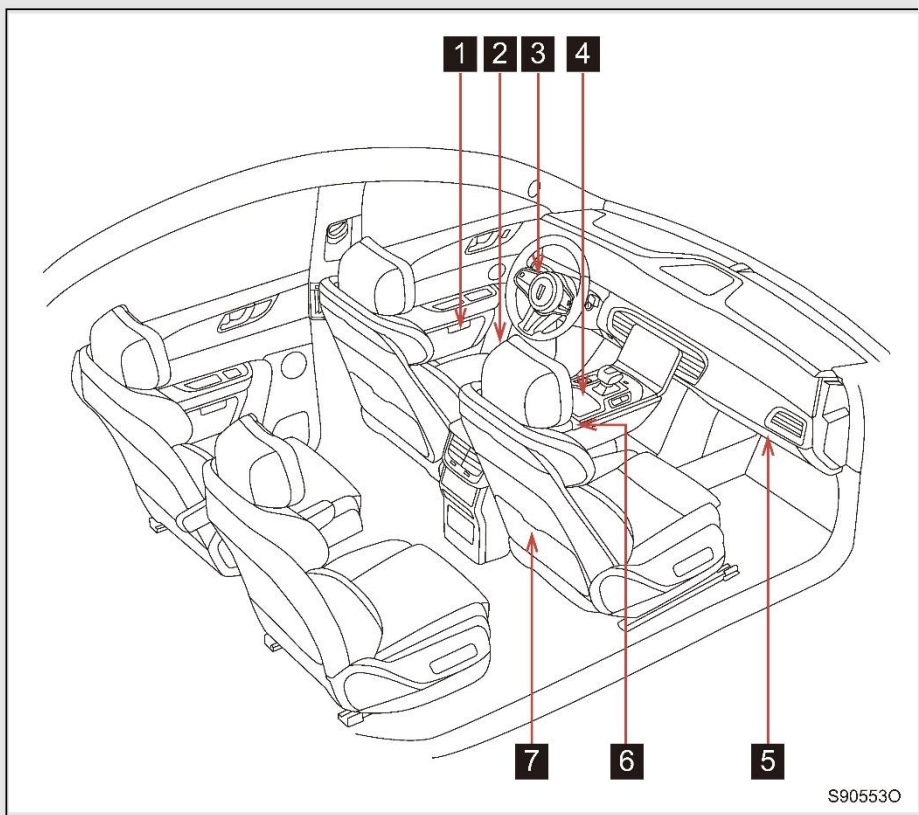

- 1** Door storage box
- 2** Storage box
- 3** Glove box on left lower guard
- 4** Cup holder (front/rear)
- 5** Glove box
- 6** Front central storage box
- 7** File pocket

Glove box

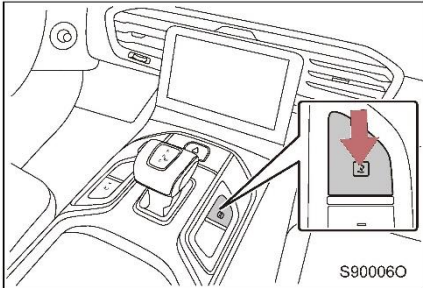

Press the glove box switch to open it.

When closing the glove box cover, a "click" sound indicates that it is firmly locked.

You can set the password for the glove box in the vehicle settings of the multimedia system. (Refer to P.223)

■ Emergency opening of glove box

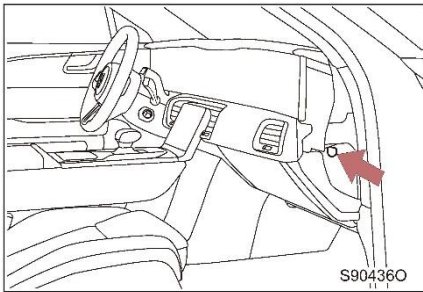

When the glove box cannot be opened normally through the glove box switch, emergency opening is available through the glove box cable.

Detach the right cover of the instrument panel to pull the glove box cable.

WARNING

■ Warning during driving

Keep the glove box closed.

Failure to do so may result in injury in the event of an accident or emergency braking.

Front central storage box

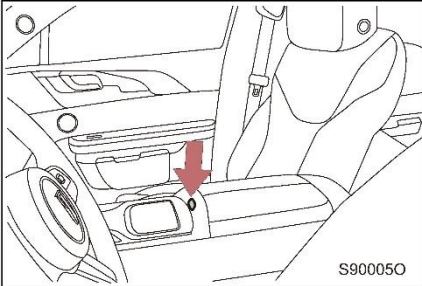

Press the storage box switch to pop up the front central storage box.

WARNING

■ **Warning during driving**

Keep the storage box closed.

Failure to do so may result in injury in the event of an accident or emergency braking.

Glove box on left lower guard

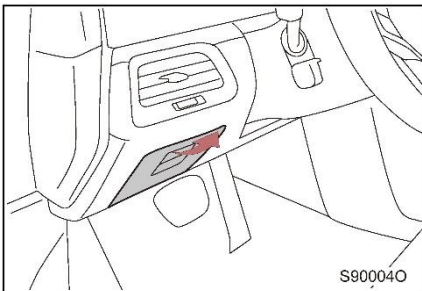

Pull the opening handle to open the glove box.

When closing the glove box cover, a "click" sound indicates that it is firmly locked.

WARNING

■ **Warning during driving**

Keep the storage box closed.

Otherwise, it may affect normal driving of the driver, and result in injury in the event of an accident or emergency braking.

Cup holder

▶ Front

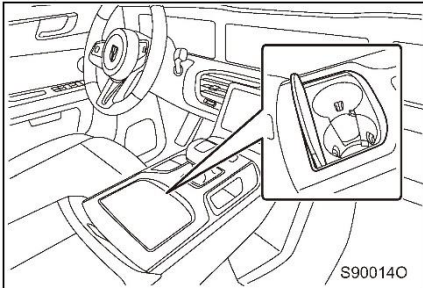

Press down on the cup holder cover and the cover flips open automatically.

▶ Rear *

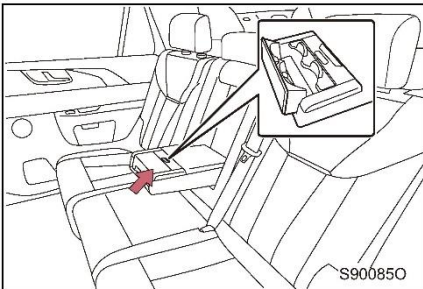

Lower the rear center armrest, press the cup holder cover opening button, and the cup holder will pop out automatically.

■ When using the cup holder to store a cup

- Please tighten the cup cover.
- Cups may not be stored due to their size or shape.



WARNING

■ When using the cup holder

- Do not place any items other than cups or aluminum cans in the cup holder, as such items may be thrown out of the cup holder and cause injury in the event of an accident or emergency braking.
- Do not use the cup holder to accommodate the cup with hot liquid, etc. If the liquid inside the cup is spilled, it may cause burns.
- Do not make foreign matters such as liquid come into contact with the electrical components around and under the cup holder, otherwise it may cause short circuit or electric shock.

■ When not in use

Keep the cup holder closed. Failure to do so may result in injury in the event of an accident or emergency braking.

Storage box

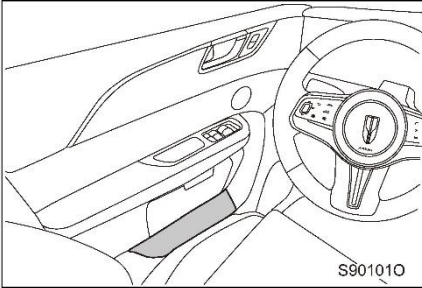

The storage box is located on each door and can be used to accommodate bottles or miscellaneous items such as rags.

When storing the bottle, tighten the cap.

Bottles may not be stored due to their size or shape.

Door storage box

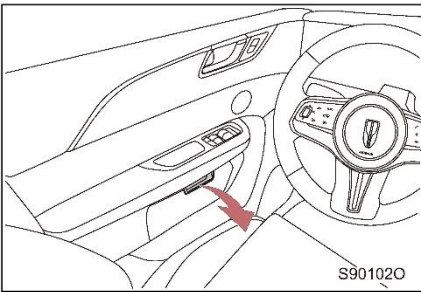

Storage boxes are located on each door. Pull the storage box cover to open the storage box.

File pocket

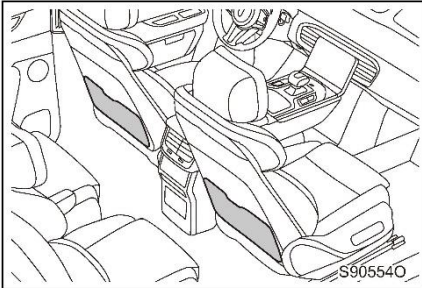

The file pockets are located at the back of the driver and front passenger backrests.

They are used to store newspapers, magazines and other items.

Rear central storage box *

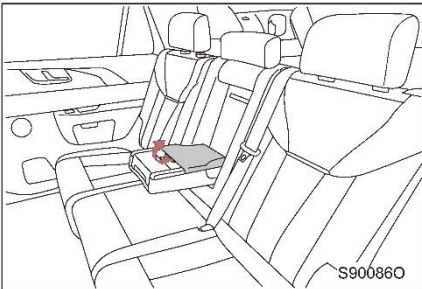

Lift up the storage box cover to open the storage box.

WARNING

■ Warning during driving

Keep the storage box closed.

Failure to do so may result in injury in the event of an accident or emergency braking.

6-3. Operating storage box Trunk device

Trunk hook

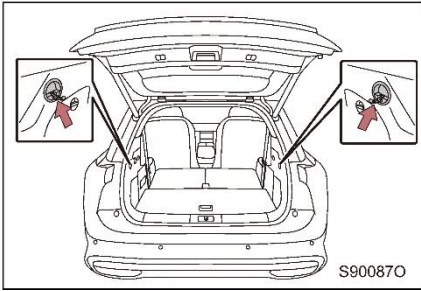

Trunk hooks are provided on the left and right sides of the trunk.

WARNING

- When not using the trunk hook, be sure to return it to the stowed position.
- Do not hang any items weighing more than 2kg on the trunk hooks.

6-4. Other in-car equipment

On-board wireless charging system

The central storage box is equipped with a wireless charging system.

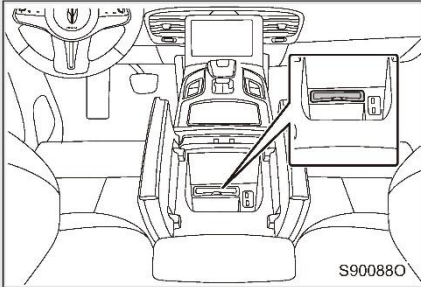

The back of cell phones that support Qi standard wireless charging can be placed directly in the wireless charging area for charging.

Cell phones do not support Qi standard wireless charging need to be charged with a receiver.

■ Conditions for use of on-board wireless charging system

The power (ignition) switch is switched to ON.

- Depending on the length, width and thickness of the mobile phone



WARNING

■ Before charging, remove all metal objects from the charging board

If a metal object (such as a coin, key, ring or clip) is found in the wireless charging area while the phone is charging wirelessly, do not remove the foreign object by hand immediately to avoid burning your fingers. But remove the phone first and wait for the metal object to cool down before removing it.



Notice

■ When charging

- Remove all items from the wireless charging area. If there are foreign objects, the system may not charge properly.
- The phone should be placed in the middle of the charging area as much as possible.

■ Do not place magnetic cards such as highway toll cards in the wireless charging area, as this may cause demagnetization.

■ Wireless charging disabled

During wireless charging, if you start the vehicle or leave the vehicle with a key, the wireless charging will be interrupted for a short time, which is a normal phenomenon.

6-4. Other in-car equipment

Sun visor

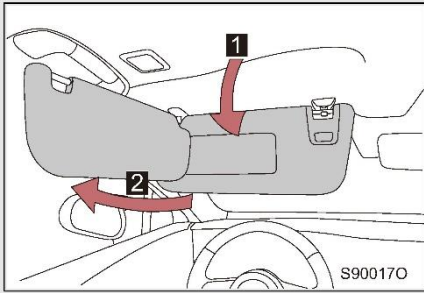

- 1** Forward position
Flip down the sun visor.
- 2** Side position
Flip down the visor, disengage the hooks, and pull to the side.

6-4. Other in-car equipment

File folder

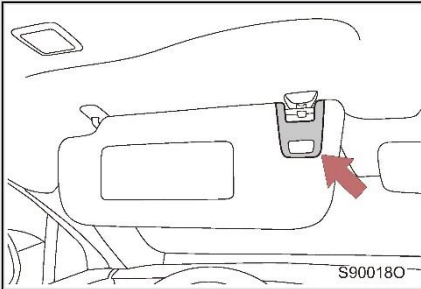

The file folder is located on the sun visor at the driver and front passenger sides.

It is used to store bills, business cards and other objects.



Notice

■ **Preventing folder damage**

Do not put too many objects on the folder.

6-4. Other in-car equipment

Make-up mirror

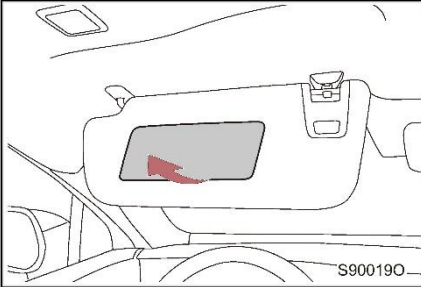

Turn down the sun visor and turn up the make-up mirror cover to open the mirror.

Notice

■ **When not in use**

Keep the make-up mirror closed.

■ **Preventing low battery power**

Do not turn on the make-up mirror lamp for a long time when the vehicle is not started.

6-4. Other in-car equipment

Power socket

■ 12V power supply

The power socket is available for 12 V accessories with an operating current of less than 10 A.

► Front

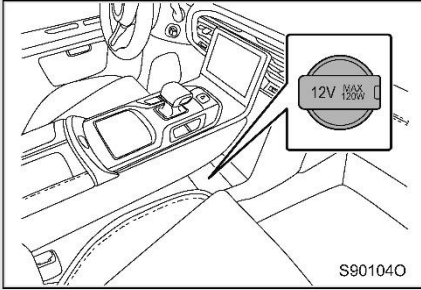

Located under the console.

► Rear

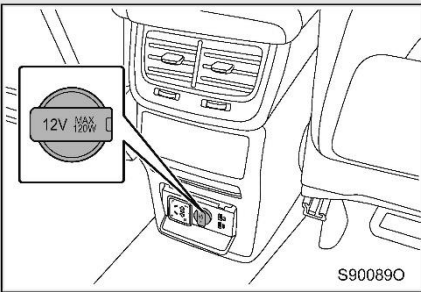

At the lower end of the rear center air outlet.

6-4. Other in-car equipment

■ 5 V USB power supply

The power socket is available for 5V accessories with an operating current of less than 2A.

► Rear

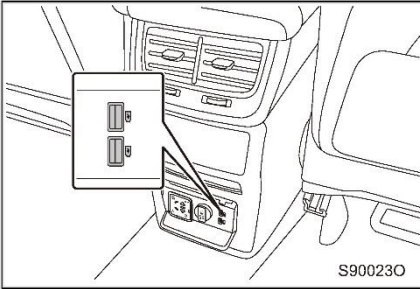

At the lower end of the rear center air outlet.

► Third row

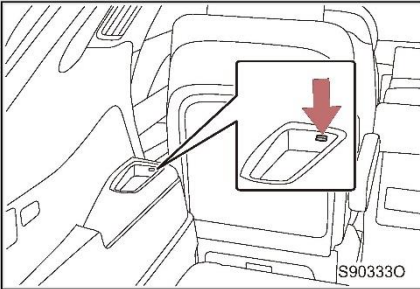

Located on the trunk trim panels on both sides of the third-row seats.

■ Conditions for use of power socket

The power (ignition) switch is switched to ON.

⚠ Notice

■ Preventing damage to power socket

When the power socket is not in use, the power socket cover should be closed, otherwise foreign objects or liquids will enter the power socket and cause a short circuit.

■ Preventing fuse blowing

Do not use accessories that exceed the rated voltage/current.

6-4. Other in-car equipment

220V power outlet

The vehicle is equipped with a 220 V power socket.

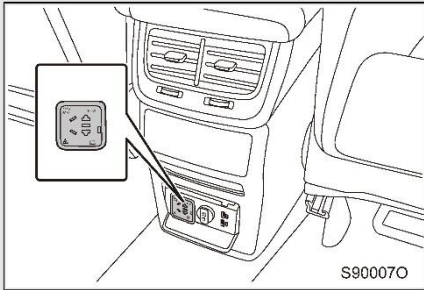

At the lower end of the rear center air outlet.

■ Conditions for use of 220 V power socket

The power (ignition) switch is switched to ON.

■ Indicator

Under normal operation, the indicator (green) will remain on; if a fault exists, such as input voltage overvoltage, 220 V output overload, short circuit, electric leakage, over-temperature protection, the indicator (red) will flash.

WARNING

- **When the 220 V power socket operates, it is in a high voltage state.**
 - Never spill liquid on the power socket.
 - Do not connect the adapter or additional wires to the 220 V power socket, otherwise the built-in child electric shock protection will fail and the socket will remain electrified.
 - Do not insert any conductive items, such as knitting needles, into the contacts in the 220 V power socket by mistake.



Notice

- **Connecting the electrical device:** insert the plug into the limit position to unlock the built-in child electric shock protection. Power shall only be supplied to the socket after the child electric shock protection has been unlocked.
- **Do strictly abide by the instructions provided by the manufacturer of electrical appliances for operation!**
- **The power consumption of electrical appliances shall not be greater than the maximum rated output power 150 W of the socket, otherwise, the electrical system of the complete vehicle may be damaged.**
- **Do not plug heavy electrical devices such as power adapters or plugs directly into the socket.**
- **Only electrical devices whose voltage matches the socket voltage can be connected to the socket.**
- **If the temperature exceeds a specified value, the output of the 220 V power socket will be automatically powered off. When the power consumption or the ambient temperature is too high, the overheat protection function will be activated to turn off the 220 V output. When the temperature drops to the specified value, the 220 V power socket will automatically restore the 220 V output and the power supply to the electrical appliances. When the inverter is powered off due to overheating, it will also cut off the current supply of the electrical appliances.**

6-4. Other in-car equipment

Seat temperature controller *

The temperature of each seat can be adjusted separately.

■ Front seat temperature adjustment



Touch the seat setting button on the front A/C operation panel to access the seat setting interface, and touch the seat heating and ventilation buttons to select the appropriate heating and ventilation gears.

■ Rear seat temperature adjustment

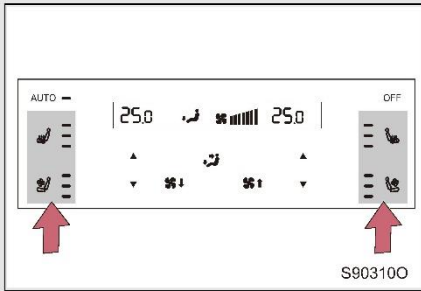

Touch the seat heating and ventilation buttons on the rear A/C operation panel to select the appropriate heating and ventilation gears.

■ Working conditions

The power (ignition) switch is switched to ON.



WARNING

- **When using the seat heating and ventilation function, be sure to observe the following precautions**
- Special care is needed to avoid burns when seating in heated seats for the following persons:
 - Infants, children, elderly, sick and disabled
 - People with sensitive skin
 - Very fatigued people
 - Drowsiness due to alcohol or medication (sleeping pills, cold medication, etc.)
- Do not cover the seat with any object (e.g. blanket, seat cushion) when using seat heating or ventilation function. Otherwise, the seat temperature will rise or fall, which can lead to over-heating or over-cooling.
- Do not turn on the seat heating or ventilation function if not necessary. Otherwise, it may make occupants feel too cool, too hot or cause local burns.



Notice

- **Preventing damage to seat heating or ventilation systems**

Do not place heavy objects with uneven surfaces on the seat or stick sharp objects (pins, nails, etc.) in the seat.
- **When cleaning the seats**

When cleaning the seats, do not use organic substances such as benzene and gasoline. It is easy to damage the heater and the seat skin.

6-4. Other in-car equipment

Seat temperature controller *

Seat massage function is available through the A/C operation interface.



Touch the seat setting button on the front A/C operation panel to access the seat setting interface, where you can select seat massage mode and gear.

■ Working conditions

The power (ignition) switch is switched to ON.

■ Operating duration

The system will automatically shut down after about 15 minutes of operation.

WARNING

■ Use of seat massage function

- Pregnant women, puerpera or sick people (heart disease, etc.) who need rest should consult a doctor before use.
- Children are forbidden to use massage function.
- The massage function should not be used immediately after meals or used for a long time.
- If you feel uncomfortable when using massage function, you should stop it immediately.
- The massage function is deactivated in ECO driving mode

6-4. Other in-car equipment Rear center armrest *



Pull down the armrest to use.



Notice

- **Preventing damage to armrest**
Do not forcefully press the armrest.

6-4. Other in-car equipment

Ceiling handle

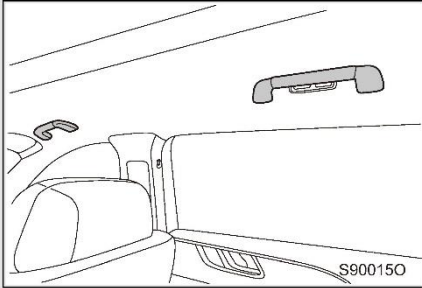

The ceiling handle is located at the roof side member of each door.

When sitting on the seat, the body can be supported by the ceiling handle mounted on the roof lining.



WARNING

■ Ceiling handle

Do not use the ceiling handle when getting in or out of the vehicle or getting up from the seat.



Notice

■ Preventing damage to ceiling handle

Do not hang any heavy objects or apply heavy loads on the ceiling handle to prevent damage to the ceiling handle.

6-4. Other in-car equipment

Coat hook

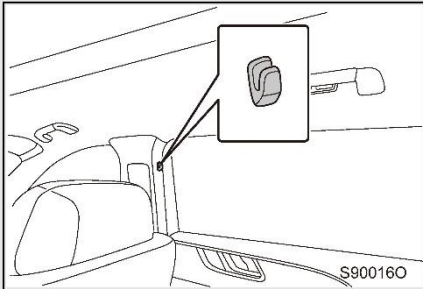

Just hang your clothes on the coat hook when you need it.

WARNING

■ **Items that should not be hung on the coat hook**

Do not hang hangers or other hard or sharp objects on coat hooks. If the curtain airbag deploys, these objects could be ejected and result in serious injury or death.

7-1. Service and maintenance

Cleaning and protecting vehicle
exteriors..... 304

Cleaning and protecting vehicle
interiors..... 306

7-2. Maintenance

Maintenance instructions 308

7-3. Self-maintenance

Precautions for self-maintenance..... 310

Hood..... 312

Engine compartment 313

Tire 321

Tire pressure..... 324

Wheel 326

A/C filter..... 327

Replacing the key battery 329

Checking and replacing the fuse 331

Power battery..... 335

Cleaning and protecting vehicle exteriors

Compliance with the following operations will help protect the vehicle exteriors and keep it in optimum condition.

- Rinse the body, wheel covers and underside of the vehicle from top to bottom with plenty of water to remove dirt and dust.
- Use a sponge or soft cloth (such as a chamois cloth) to wipe the body.
- For hard-to-remove marks, wash with automobile detergent and rinse thoroughly with water.
- Wipe the water away.
- After the waterproof coating has deteriorated, the vehicle should be waxed.

Please wait until the surface of the vehicle is clean and free of water droplets and the body is cool before waxing the body.

■ Automatic car wash

- The exterior rearview mirrors should be folded and the doors should be locked (the handles must be in locked position) before washing the car. Start washing from the front of the vehicle. Make sure the exterior rearview mirrors are unfolded before driving.
- The brush used to wash the car in automatic washing station may scratch the surface of the vehicle and damage the paint.

■ High-pressure car wash

- Do not allow the nozzles used for washing your car to get too close to the windows.
- Before washing the vehicle, check that the filler cap is properly closed on the vehicle.

■ Aluminum wheels

- The dirt on wheels should be removed immediately with neutral detergent. Do not use hard brushes or cleaners containing abrasives. Do not use highly corrosive or aggressive chemical cleaners.
- Do not use detergent to clean the wheels when they are hot (e.g., after driving long distances in hot weather).
- After cleaning the wheels with detergent, rinse them off immediately.

■ Bumper

Do not wipe with abrasive cleaner.



WARNING

■ When washing the vehicle

Do not rinse the inside of the engine compartment with water. Failure to do so may cause a short circuit in the electrical components, which may result in a fire.

**Notice****■ Preventing body aging and body paint deterioration, body and components (aluminum wheels, etc.) corrosion**

- The vehicle should be washed immediately after the occurrence of the following cases:
 - After driving on the beach.
 - After driving on salty roads.
 - If the paint is attached with coal tar or resin.
 - If dead insects, insect droppings or bird droppings fall on the paint surface.
 - After the vehicle is driven in an area contaminated by soot, oil smoke, mineral dust, iron dust or chemical substances.
 - When the vehicle is heavily dusted or mud-bound.
 - When liquids such as benzene and gasoline are spilled on the paint surface.
- If the paint is peeling or scratched, have it repaired immediately.
- To prevent wheel corrosion, store the wheels with the dirt removed and in a low humidity place.

■ When cleaning the flag marker

Please use water or neutral cleaning agent to wipe the flag mark on the hatch cover. It is forbidden to use alcohol or organic solvents such as alcohol-containing liquid, phenol, anisole, etc. for cleaning, otherwise it is easy to produce cracks.

■ When cleaning the lights

- Care should be taken when cleaning. Do not use organic cleaners or hard brushes for cleaning, as this may damage the surface of the lights.
- Do not wax the surface of the lights, as the wax may damage the light cover.

Cleaning and protecting vehicle interiors

Compliance with the following operations will help protect the vehicle interiors and keep it in optimum condition:

■ **Protecting vehicle interiors**

Remove dirt and dust with a vacuum cleaner. Wet a cloth with warm water to wipe the soiled surface.

■ **Cleaning the leather area**

- Remove dirt and dust with a vacuum cleaner.
- Wet a soft cloth with diluted detergent to wipe away any remaining dirt and dust. Use an aqueous solution of neutral wool detergent with a dilution concentration of approximately 5%.
- Wring out the damp cloth to wipe off any residual detergent thoroughly.
- Wipe off any residual water on the surface with a dry, soft cloth and allow the leather to dry in a cool, ventilated place.

■ **Cleaning the artificial leather area**

- Remove floating dust with a vacuum cleaner.
- Apply the neutral soap solution to the artificial leather.
- Allow the soap to soak in for a few minutes, then wipe off the dirt and soap with a clean, damp cloth.

■ **Cleaning the woody area**

- Dust accumulation on the surface of wood finishes can be gently cleaned and wiped with cotton gauze.
- If the surface of wood finishes is stained with dirt, it can be gently wiped with cotton cloth dipped in a little neutral soap.

■ **Maintenance of leather area**

It is recommended that you clean the interior of your vehicle at least twice a year to maintain the quality of the interiors.

■ **Maintenance of woody area**

It is recommended that you always maintain the wood finish surface according to the condition of the wood finish surface.

■ **Carpet cleaning**

Use a suitable commercially available foam cleaner to clean the carpet. Apply foam with sponge or brush, wipe in overlapping circles, do not add water, and keep carpet dry as much as possible for best results.

■ **Seat belt**

Clean with a cloth or sponge moistened with neutral detergent and slightly warm water. And check the seat belt regularly for excessive wear, abrasion or scratches.

**WARNING**

- **Waterproofing inside the car**

- Do not spill liquid inside the vehicle, as this may cause electrical components, etc. to malfunction or catch fire.
- Do not expose the airbag components or wires in the vehicle to moisture. Electrical failure may cause the airbag to deploy unexpectedly or malfunction, resulting in serious injury or even death.

- **Cleaning the interior (especially the instrument panel)**

Do not use polishing waxes or polishing cleaners. The instrument panel may reflect onto the windshield, obstructing the driver's view and causing an accident that could result in serious injury or even death.

**Notice**

- **Cleaner**

- Do not use the following types of cleaners as they may discolor the interiors of the vehicle or cause staining or damage to the paintwork: Organic substances such as benzene or gasoline, alkaline or acidic solutions, stains and bleaches.
- Do not use polishing waxes or polishing cleaners as they may damage the finish of the instrument panel or other interior parts of the vehicle.

- **Preventing damage to the leather surface**

To prevent damage and deterioration of the leather surface, please observe the following precautions:

- Wipe off the dust and dirt from the leather surface in time.
- The vehicle should not be exposed to direct sunlight for a long time. Please park it in a cool place, especially in summer.
- Do not place polyethylene, plastic products or wax items on the leather trim, as they may stick to the leather surface when the interior temperature rises significantly.
- If there is too much moisture left on the surface of the seat, it will cause the leather to harden, shrink and deform.

- **Floor waterproofing**

Do not wash the vehicle floor with water.

If the electrical components under the vehicle floor come into contact with water, it may cause damage to the electrical system, and even cause rust to the body.

- **Cleaning the inside of the rear windshield**

- Do not use glass cleaner to clean the rear windshield as this may cause damage to the rear windshield defroster electric heater wire. Moisten a cloth with warm water and wipe gently in a direction parallel to the electric heater wire.
- Be careful not to scratch or damage the electric heater wire.

Maintenance instructions

To ensure safe and economical driving, routine maintenance and regular servicing are very important. FAW recommends that you take the following maintenance measures:

■ Regular maintenance

- Please follow the maintenance schedule and perform regular maintenance on your vehicle.

The maintenance interval may be based on the mileage or time in the schedule, whichever is reached first. For maintenance items that have exceeded the last interval, it is also recommended that you have them serviced at the same interval.

- Where do I go for maintenance?

It is ideal to go to the authorized FAW Hongqi dealer for maintenance.

The authorized FAW Hongqi dealers have the advanced repair tools, equipment and genuine spare parts required to provide repair and service to your vehicle, and all after-sales service personnel have received professional management and technical training to ensure fast and efficient completion of vehicle maintenance and repair work, ensuring that your vehicle always has good technical performance.

The authorized FAW Hongqi dealers have invested a lot of money in special tools and maintenance equipment. This helps to provide you with better service.

The authorized FAW Hongqi dealers abide by the concept of efficient, reasonable and value-added service, and perform all maintenance items of the vehicle with all their might.

Rubber hoses (for cooling and heating systems and brake systems) should be inspected by professionals in strict accordance with the maintenance schedule. Rubber hoses deteriorate over time, resulting in swelling, wear and tear, or rupture. Therefore, if the hose shows any signs of deterioration or damage, please make sure you contact an authorized FAW Hongqi dealer for replacement immediately.

■ Self-maintenance instructions

Is it possible to maintain the vehicle by myself?

If you have basic knowledge of vehicle construction and inspection and maintenance and have some basic tools, you can perform daily inspection and maintenance by yourself. Simple instructions on how to do your own maintenance are described in this section.

It is important to note that certain maintenance tasks require specialized maintenance equipment and expertise, and are therefore best performed by a qualified technician. Even if you are an experienced professional technician, we still recommend that you visit an authorized FAW Hongqi dealer for standardized repairs and maintenance, as they will keep a record of your car's maintenance information and help you claim warranty service.

■ Does your vehicle need to be repaired?

Be alert to changes in vehicle performance and sound, and other visual warnings that indicate the vehicle needs service. The following are some important signs:

- Power is significantly reduced.
- Abnormal noise in motor.
- Fluid leaks from the bottom of the vehicle. (Water dripping after A/C operating is a normal phenomenon)
- Tires become flat, excessive tire noise when turning, and uneven tire wear.
- The vehicle runs off to one side when driving in a straight line on a flat road.
- Rattles related to suspension components.
- Brake failure; loose feeling when the brake pedal is stepped on; pedal almost touches the floor; vehicle runs off when braking.
- Persistently high coolant temperature.

If you notice any of the above signs, please contact an authorized FAW Hongqi dealer as soon as possible as the vehicle may require adjustment or repair.



WARNING

■ **If the vehicle is not properly maintained**

May cause serious damage to the vehicle and lead to serious injury or even death.

■ **Precautions when handling batteries**

Battery posts, terminals and related accessories contain lead and lead compounds, which can cause brain damage. Be sure to wash your hands after handling.

Precautions for self-maintenance

If you are going to perform the maintenance yourself, be sure to follow the proper steps as described below.

Item	Parts and tools
Battery condition (See P.317)	<ul style="list-style-type: none"> • Warm water • Baking soda • Grease • Conventional wrench (For terminal bolts)
Coolant level (refer to P.314)	<ul style="list-style-type: none"> • Automotive long-life coolant • Funnel (for adding coolant only)
Brake fluid level (refer to P.316)	<ul style="list-style-type: none"> • Genuine brake fluid from FAW • Rag or paper towel, funnel (For adding brake fluid only)
Fuse (See P.331)	<ul style="list-style-type: none"> • Fuses with the same amperage rating as original parts
Radiator and condenser (refer to P.315)	—
Tire pressure (See P.324)	<ul style="list-style-type: none"> • Tire pressure gauge • Compressed air source
Cleaning fluid (See P.320)	<ul style="list-style-type: none"> • Washer fluid containing antifreeze (For winter use) • Funnel

**WARNING**

A large number of mechanical devices in the engine compartment may suddenly turn, become hot, or begin to energize. To avoid serious injury, please observe the following precautions.

■ **When handling engine compartment components**

- Be careful not to touch the motor, radiator, exhaust manifold, etc. immediately after driving, as they may be very hot.
- Do turn off the power (ignition) switch before opening the engine hood, apply the electronic parking brake, keep the key handy and leave the engine to cool.
- Keep hands, clothing and tools away from the rotating fan.
- Do not leave any items in the engine compartment. Do not leave items such as tools or cloths in the engine compartment after completing an inspection or maintenance in the engine compartment, otherwise it may result in fire, thus leading to an accident.
- Do not smoke, cause sparks or expose open fire near the engine compartment cable or battery.
- Be very careful when handling batteries. The battery contains sulfuric acid, which is toxic and corrosive.
- Be careful when handling brake fluid, as it can harm your hands or eyes and damage the paintwork. If brake fluid is splashed on your hands or in your eyes, immediately flush the splashed area with plenty of water. If you still feel unwell, seek immediate medical attention.

■ **When in the vicinity of electric fans or radiator grilles**

Ensure that the power (ignition) switch is turned off.

When the power (ignition) switch is turned to ON, the electric cooling fan may run automatically if the A/C is turned on or the coolant temperature is high.

■ **Safety goggles**

Wear safety goggles to prevent objects from flying in or liquids from splashing into your eyes.

**Notice**

■ **If the brake fluid level is too low or too high**

It is normal for the brake fluid level to drop slightly when the brake linings are worn or the level in the brake fluid tank is high. If the brake fluid tank needs to be filled frequently with brake fluid, it means there may be a serious fault, please contact authorized FAW Hongqi dealer to check the vehicle.

7-3. Self-maintenance

Hood

Unlocking from inside the vehicle to open the hood.

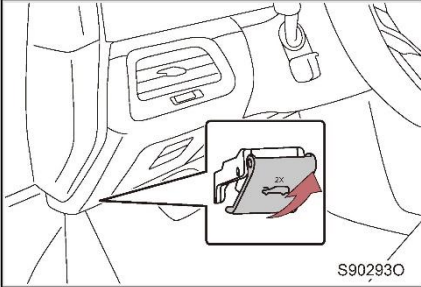

Pull the engine hood release handle in the vehicle twice to open the engine hood.



WARNING

■ Pre-driving inspection

Check and make sure the hood is fully closed and locked.

If the hood is not properly locked, it could open while the vehicle is in motion and cause an accident, which could result in serious injury.



Notice

■ When closing the hood

- Do not apply excessive force, as this may cause damage to the hood.
- Before closing the hood, make sure that no tools, objects, etc. are left in the engine compartment.

7-3. Self-maintenance Engine compartment

Due to different vehicle configurations, the picture is only for reference.

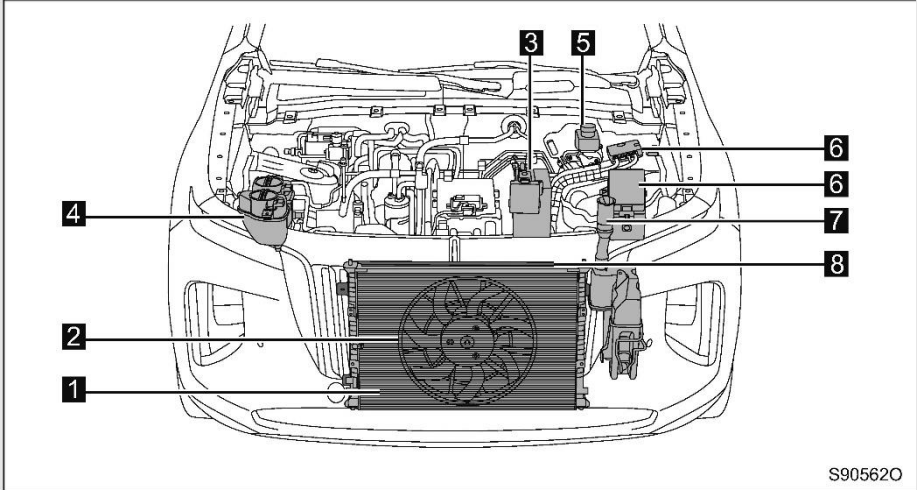

S905620

- | | | | |
|----------|------------------------|----------|-------------------|
| 1 | Condenser | 2 | Cooling fan |
| 3 | 12 V battery | 4 | Coolant reservoir |
| 5 | Brake fluid tank | 6 | Fuse box |
| 7 | Washer fluid reservoir | 8 | Radiator |

Coolant

If the coolant level in the coolant reservoir is between the "MAX" (high) and "MIN" (low) mark lines, the level is normal.

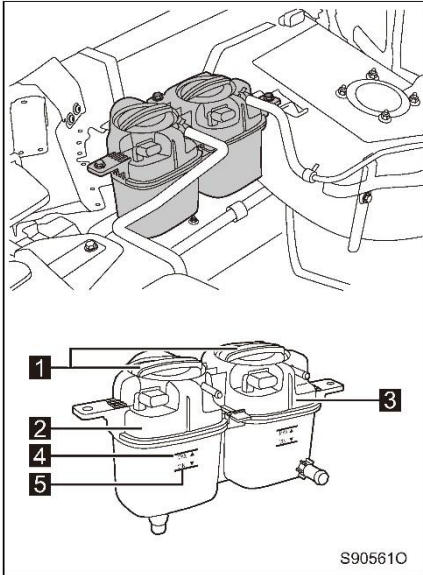

- 1 Reservoir cover
- 2 Motor coolant reservoir
- 3 Battery coolant reservoir
- 4 "MAX" (high)
- 5 "MIN" (low)

If the level is below the "MIN" mark line, add coolant to the normal level.

■ If the coolant level drops shortly after the coolant is replenished

Must visually inspect the radiator, reservoir, cooling lines and other components.

If no leakage is found, please contact the authorized FAW Hongqi dealer to check the system.

■ Coolant selection

Use automotive long-life coolant throughout the year.

For more details about the coolant, please contact an authorized FAW Hongqi dealer.



WARNING

■ When the coolant temperature is high

- Do not remove the coolant reservoir cover.

Pressure may exist inside the cooling system, and hot coolant may spray out when the coolant reservoir cover is removed, resulting in burns or other injuries.

**Notice****■ When adding coolant**

FAW specified type of coolant must be added to ensure proper lubrication, anti-corrosion and cooling performance. Please read the label instructions of the coolant.

■ If the coolant is accidentally spilled

Be sure to clean with water to prevent damage to parts or the paint.

Radiator and condenser

Check the radiator as well as condenser, and remove all foreign objects.

If the radiator or condenser is particularly dirty or abnormal, please contact the authorized FAW Hongqi dealer to check the vehicle.

**WARNING****■ When the radiator and condenser are very hot**

Do not touch the radiator or condenser, as this may result in burns.

Brake fluid

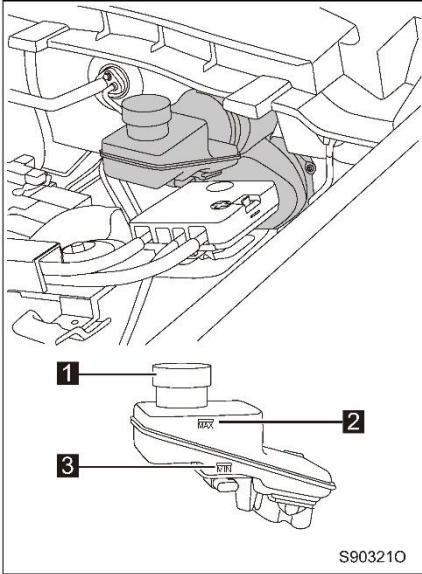

1 Brake fluid cap

2 "MAX" (high)

3 "MIN" (low)

If the level is below the "MIN" mark line, add brake fluid to the normal level.

WARNING

■ **Precautions for adding coolant**

- The sprayed brake fluid is very dangerous. If the brake fluid gets into your eyes, please rinse with plenty of water immediately and seek medical advice as soon as possible.
- Do not spray brake fluid on your body or on the electrical components of the engine compartment, otherwise it may cause personal injury or fire.

■ **Too low brake fluid level**

- Too low brake fluid level is very dangerous. Low level indicates wear of brake lining or leakage of the brake system. The brake may fail, resulting in serious accidents. If the level is found to be too low, please check the brake.
- If the level is too low, add brake fluid until the level rises to "MAX". Before adding brake fluid, please thoroughly clean the area around the reservoir cover.

Notice

- Brake fluid will damage the paint surface. If it spills on the paint surface, please wipe it clean immediately.
- Using non-specified brake fluid can damage the system. Mixed use of different brake fluids will also cause damage to the system.
- If you need to add or renew brake fluid, please contact the authorized FAW Hongqi dealer.
- Do not drip brake fluid on the inverter, otherwise it may cause failure of the inverter.

12 V battery

■ LV power management system

- When the battery/power battery is insufficient or the vehicle is in LBL mode, to ensure the driving range of the vehicle, the system will restrict or turn off some comfort functions, such as A/C, seat ventilation/heating/massage, headlamp delay, which may not operate according to the operating statuses set by users. When the vehicle switches to other driving modes and the power is in a safe range, the limited comfort functions will resume response.

The LV power management system can adjust the DC/DC output voltage in real time, and obtain battery status information to control the best charging voltage, to ensure the normal operation of the LV power network on the vehicle.

- When the power (ignition) switch is in OFF mode, the vehicle will automatically control the high voltage output to recharge the battery if the system detects a battery loss.

■ Check the battery appearance

Make sure that the battery terminals are not corroded, the connection parts are not loose, the exterior is not cracked and the fixing clips are not loose.

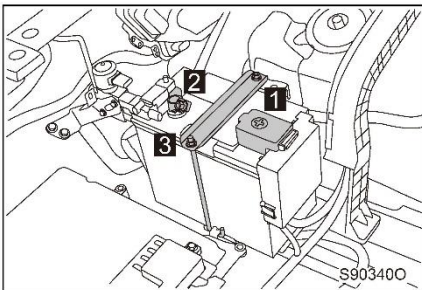

- 1** Positive terminal
- 2** Negative terminal
- 3** Retaining clip

■ When installing

- When wiring the battery, prevent the terminal cable from being connected backwards, otherwise it may damage the electrical equipment in the car.
- The battery should be prevented from contacting the positive and negative terminals during storage, handling and installation. For example, the wiring metal wrench may easily touch the positive and negative terminals at the same time, which may lead to direct failure due to short circuit of the battery in this case.
- As the battery has small exhaust holes, so the battery should not be placed sideways or upside down during storage, handling and installation to prevent leakage.
- When replacing the battery, replace it with the same type of battery as the original car.
- When replacing the battery, if the wiring clips are oxidized or dirty, you must remove the oxidized layer or dirt with sandpaper, etc., and then apply petroleum jelly to the wiring clips and battery terminals before wiring.
- The positive terminal should be connected before the negative terminal when installing, and the negative terminal should be dismantled before the positive terminal when dismantling to avoid the danger of short circuit.

■ Before charging

The following precautions should be noted before charging:

- If charging a battery installed in a vehicle, be sure to turn off the power (ignition) switch and disconnect the ground cable.
- When connecting and disconnecting the charger cable to the battery, make sure the power switch on the charger is off.

■ When using

- Prevent the battery exhaust port from being blocked, and pay attention to cleaning the exhaust port.
- The battery needs to be recharged when the following conditions are encountered:
 - The vehicle is not used for a long time.
 - The lights are not turned off after parking.
 - The vehicle door is not closed tightly when parking.
- If the vehicle is stored for more than 30 days, in order to maintain the normal state of charge technology of the battery, the following measures should be taken:
 - Disconnect the negative battery hitch wire to prevent the battery from discharging due to additional current drain.
 - Charge the battery every 20-45 days.



WARNING

■ Chemicals in the battery

The battery contains toxic and corrosive sulfuric acid and may produce flammable and explosive hydrogen gas. To reduce the likelihood of serious injury, observe the following precautions when handling batteries or working in their vicinity:

- Do not make tools touch the battery terminals to avoid sparking.
- Do not smoke or have open flames near the battery.
- Avoid splashing electrolyte on eyes, skin or clothes.
- Do not inhale or swallow the electrolyte.
- Wear safety goggles when working near the battery.
- Keep children away from the battery.

■ Safe place for battery charging

Charging should be done in an open place. Do not charge the battery in a poorly ventilated garage or a closed room.

■ Emergency measures for handling electrolyte

- If the electrolyte is accidentally splashed in the eye
Flush your eyes with water for at least 15 min and seek immediate medical attention. If possible, continue to wash your eyes with an absorbent sponge or cloth while en route to medical attention.
- If the electrolyte is spilled on the skin,
clean the area thoroughly. If there is a burning pain, seek medical attention immediately.
- If the electrolyte is spilled on clothes,
it may penetrate the clothes and get on the skin. Take off your clothes immediately and take the above measures if necessary.
- If you accidentally swallow electrolytes
Drink a lot of water or milk, then take magnesium oxide lotion, churned raw eggs or vegetable oil, and seek immediate medical attention.

■ Do not disconnect the negative (-) terminal on the body side

- A disconnected negative (-) terminal may come in contact with the positive (+) terminal, causing a short circuit and leading to serious injury or even death.

■ The system will automatically recharge the battery when the vehicle is parked for a long period of time, but the battery may not be automatically recharged in the following cases:

- Battery sensor auto-tuning is not completed.
- The static current of the system is abnormal.
- The hood is not closed.
- The battery is aging.

 **Notice**

■ **Precautions when charging the battery**

Do not charge the battery when the vehicle is started. Be sure to turn off all accessories.

Cleaning fluid

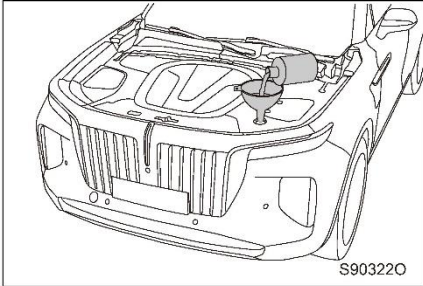

If any cleaner does not work or an alarm message appears on the instrument cluster multi-function display, the cleaning fluid reservoir may be empty, please add cleaning fluid in time.

 **WARNING**

■ **When adding cleaning fluid**

Do not add washer fluid when the power system is hot or operating. Otherwise, if the cleaning fluid is spilled on the motor, it will possibly cause a fire due to the alcohol in the cleaning fluid.

 **Notice**

■ **Do not use fluids other than cleaning fluid**

Do not use soapy water or coolant instead of cleaning fluid, as this may cause the vehicle paint to run.

■ **Diluting the cleaning fluid**

If necessary, dilute the cleaning fluid with water.

Please refer to the freezing temperature indicated on the label of the cleaning fluid reservoir bottle.

Replace the tires or perform a tire rotation depending on the wear condition of the tire tread.

■ Tire check

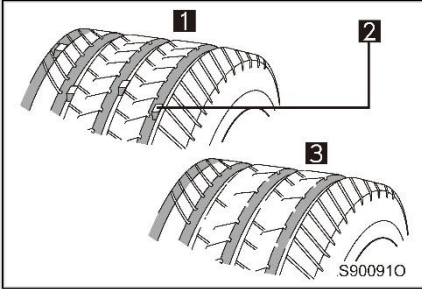

- 1 New tread
- 2 Tread wear marks
- 3 Worn tread

When worn to the tire wear mark, the tire needs to be replaced (picture is only a schematic).

■ Tire rotation

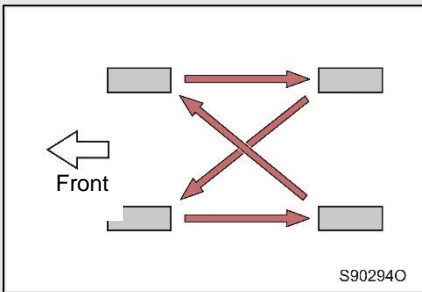

Perform the tire rotation in the order shown in the diagram.

For even wear and longer service life, it is recommended that you perform a tire rotation after every 8,000-10,000 km of driving.

Prompt:

The TPMS needs to be configured after the wheel change, please contact an authorized FAW Hongqi dealer if necessary.

■ Wheel failure prevention measures

- The car should drive as slowly as possible along the vertical direction of the obstacle when driving over a curb or similar obstacle.
- Do not let the tires come into contact with grease and fuel.
- Regularly check the condition of tire damage (e.g., damage such as cuts, cracks or bulges) and remove debris embedded in the tire tread.

■ Tire storage instructions

- Before dismantling the tires, you should mark on the tires to indicate the direction of rotation, and reset the tires according to the mark when installing them, so that the direction of rotation and dynamic balance of the wheels remain unchanged.
- Removed wheels and tires should be stored in a cool, dry place, preferably in a dark place with no sunlight.

■ Concealed damage

- Tire and rim damage is often not easy to find, if you find the vehicle abnormal vibration or runaway during driving, it indicates a wheel failure, in this case, you should go to FAW authorized Hongqi dealer to check the wheels as soon as possible.

■ When to change the tires

Tires should be replaced in the following cases:

- When the tire has something such as a cut, a break, a deeper crack that exposes the cord ply, or a bulge.
- When the tire has frequent air leaks or is beyond repair due to other damage.

■ Tire life

Avoid using older tires that are more than six years old if possible, and if you have to, drive with extreme caution and at low speeds.

■ Notes on driving in snow

If snow tire tread wear reaches 4mm or more, the snow tire anti-skid performance will be significantly reduced.

**WARNING****■ Precautions when checking or replacing tires**

To prevent damages to transmission components from affecting the maneuverability of the vehicle, please observe the precautions below:

- Do not mix tires of different makes, models, tread patterns or tread wear.
- Do not use tires that are not recommended by FAW.
- Do not mix tires with different structures such as radial, belt bundle twill or twill cord ply.
- Do not mix summer, all-season and winter tires.
- Do not use tires that have been used on other vehicles.

**Notice****■ Driving on uneven roads**

Extra care should be taken when driving on loose surfaces or roads with potholes.

Such road surfaces can lead to bulging tires due to impact and eventually cause tire damage.

■ If the tire pressure becomes low while driving

Do not continue driving as this may cause complete damage to the tires and/or wheels.

7-3. Self-maintenance

Tire pressure

Be sure to maintain proper tire pressure. Check tire pressure at least once a month.

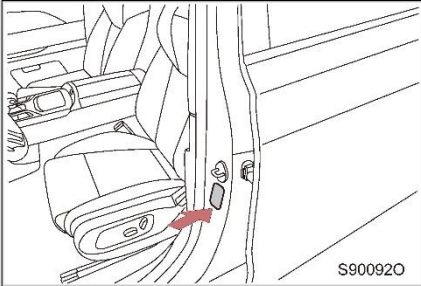

A tire pressure label is attached under the driver's side B-pillar locking pin.

■ Consequences of incorrect tire pressure

Low tire pressure:

- Rolling resistance becomes greater and power consumption increases.
- This leads to reduced overall vehicle controllability and stability.
- It may cause damage and high temperature, leading to a blowout, and when the tire pressure is seriously insufficient, it may cause the tire to detach from the rim and reduce safety.
- Causes bias wear on both sides of the tire.

High tire pressure:

- This leads to a reduction in the overall comfort of the vehicle.
- Causes excessive wear in the middle part of the tire.
- Excessive tire pressure can easily produce internal cracking and blowout when the tire is impacted.

■ Tire pressure check guide

Even if your vehicle is equipped with a TPMS, which can remind you of the tire pressure condition in time, please check the tire pressure at the right time.

When checking the tire pressure, please observe the following precautions:

- Do not check until the tires have cooled down.
If the vehicle has been parked for at least 3 hours or has not been driven more than 1.5km, check at this time to get an accurate tire pressure reading.
- Be sure to use a tire pressure gauge.
Tire appearance can sometimes be misleading. In addition, even a slightly lower tire pressure may reduce smoothness and controllability.
- Do not deflate or depressurize the tires after driving. It is normal for the tire pressure to increase after driving.
- Do not overload your vehicle.
The weight of the occupants and luggage should be evenly distributed to bring the vehicle into balance.

**WARNING****■ Proper inflation is the key to protecting your tires**

Be sure to maintain proper tire pressure, otherwise the following may occur.

- Excessive wear and tear
- Uneven wear and tear
- Poor maneuverability
- Tire blowout after overheating
- Weakened tire edge sealing
- Wheel deformation or tire detachment from the wheel
- Tires are more likely to be damaged due to poor road conditions

■ Do not drive in the case of improper tire pressure

It is dangerous to drive a vehicle with improper tire pressure. Improper tire pressure may affect handling performance and lead to an accident.

**Notice****■ Precautions when checking and adjusting tire pressure**

Be sure to reinstall the tire valve cover.

If there is no valve cover, dirt or moisture may enter the valve and cause an air leak, which could lead to an accident.

If the valve cover is missing, install a new one as soon as possible.

If the rim is bent, cracked or severely corroded, it should be replaced.

Otherwise, the tire may separate from the rim or cause the vehicle to lose control.

■ **Wheel selection**

When replacing the wheels, care must be taken to ensure that the replacement wheels have the same load capacity, diameter, rim width and offset distance as the original wheels.

Replacement wheels are available from FAW authorized Hongqi dealers.

FAW recommends against the use of the following wheels:

- Different size or type of wheels.
- Old wheels.
- Bent wheels that have been straightened.

■ **Precautions on aluminum wheels**

- Always use the wheel bolts and wrenches for this aluminum wheel.
- Check and confirm the wheel bolts tightness when changing, repairing or replacing the wheel.
- When using tire chains, be careful not to damage the aluminum rim.
- When balancing the wheels, only use the balancing blocks specified by FAW or equivalent products.



WARNING

■ **When replacing the wheels**

Do not use wheels that are different from the model of this vehicle, as this may cause the vehicle to lose control.

■ **When installing the wheel bolts**

- Tighten wheel bolts until the cone contacts the wheel bolt seat of the rim.
- Do not apply oil or grease to the wheel bolts.

Oil and grease may overtighten the wheel bolt and cause damage to the bolt or spoke plate type wheel. In addition, oil or grease can cause wheel bolts to loosen and dislodge the wheel, which can cause an accident and lead to serious injury or even death. Remove all oil or grease on the wheel bolts.

■ **Do not use defective wheels**

Do not use cracked or deformed wheels.

Otherwise, it may lead to air leakage from the tire while driving, which may cause an accident.

7-3. Self-maintenance A/C filter

The A/C filter must be replaced regularly to maintain air conditioning efficiency.

■ Replacing the A/C filter

STEP 1 Turn off the power (ignition) switch.

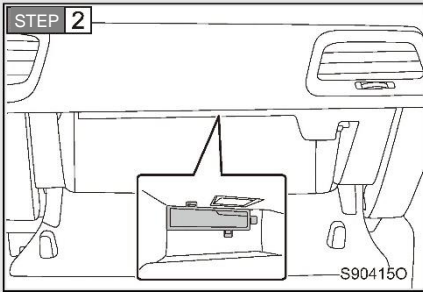

Open the glove box.
Detach the A/C filter cover plate.

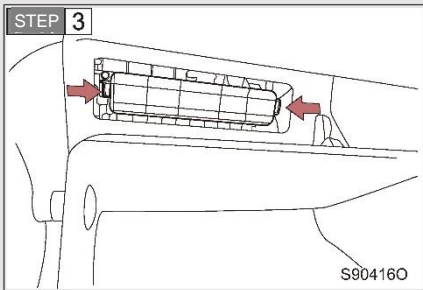

Detach the A/C filter.

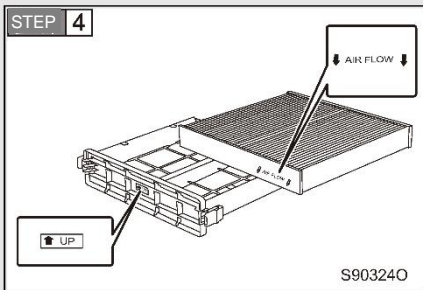

Detach the filter from the filter housing and replace it with a new one.

Pay attention to the installation direction arrow on the filter and filter housing during installation.

■ Replace the fragrance box*

STEP 1 Turn off the power (ignition) switch.

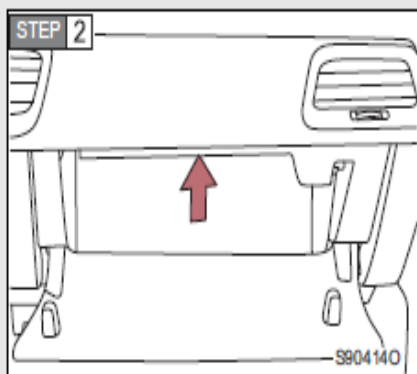

Open the glove box. The fragrance box is located at the top of the glove box.

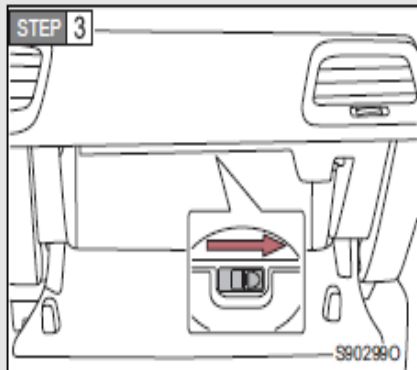

Turn the switch to the right to open the cover plate of the fragrance box.

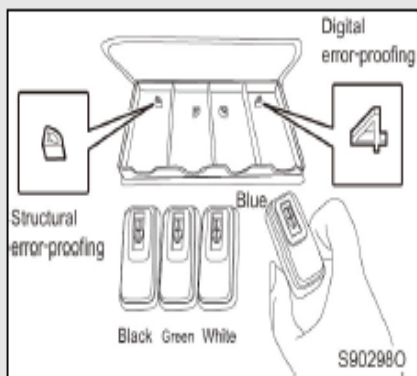

Remove the fragrance from the fragrance box and replace it with new fragrance.

From left to right, it is number 1, 2, 3 and 4. The black, white, green and blue fragrances are placed in sequence

- **A/C filter replacement interval**

In dusty or heavy traffic areas, the replacement interval may need to be shortened.

- **If the airflow at the air outlets is significantly weakened**

The filter may be clogged. Check the filter and replace it if necessary.

- **A/C filter**

If you need to clean or replace the filter, please contact an authorized FAW Hongqi dealer.



Notice

- **When operating the automatic A/C system**

Make sure the filter is installed.

Using an A/C system without a filter may cause damage to that system.

- **When removing the filter cover**

It is forbidden to replace the A/C filter while the blower is in operation, otherwise it may cause injury.

7-3. Self-maintenance

Replacing the key battery

If the smart key battery is low, replace it with a new one.

- The following items are required:
 - Lithium battery
- Replace the smart key battery

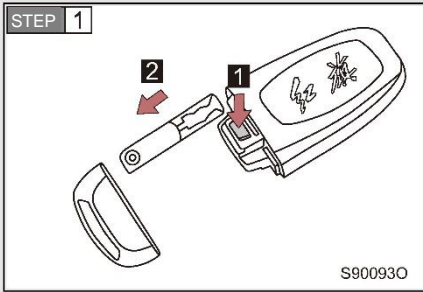

- 1 Press the unlock button to release the key end cap.
- 2 Take out the mechanical key.

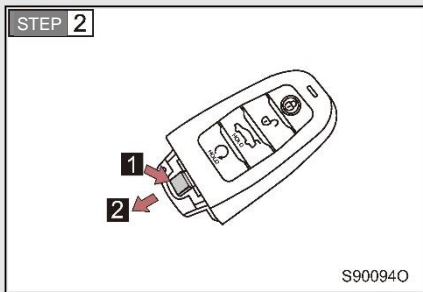

- 1 Hold down the button.
- 2 Pull out the battery compartment.

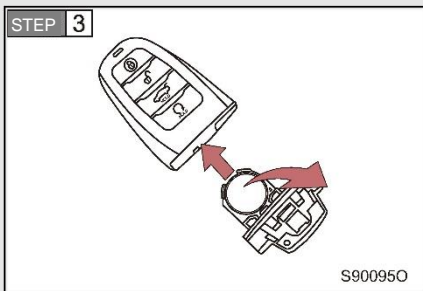

- 1 Remove the used battery.
Insert the new battery with the + pole facing down.
- 2 Put the battery compartment back into the smart key.

■ **If the smart key battery is low, the following conditions will occur**

- The wireless remote control function will be out of order.
- The effective range becomes smaller. The passive entry function is out of order. The passive start function is out of order.

■ **Using CR2032 lithium battery**

- It is recommended to replace it with the same or equivalent product recommended by an authorized FAW Hongqi dealer.
- Used batteries must be disposed of according to local regulations.



WARNING

■ **Replaced batteries and other parts**

Keep out of the reach of children.

These parts are small and can cause choking if accidentally swallowed by a child.



Notice

■ **To ensure that the remote key works properly after battery replacement, please observe the precautions below**

- Dry your hands when operating, otherwise it may cause the battery to rust.
- Do not touch or move any other parts inside the remote control key.
- Do not bend the battery terminals.

7-3. Self-maintenance

Checking and replacing the fuse

If any electrical component is not working, a fuse may have blown. In this case, check and, if necessary, replace the fuse.

STEP 1 Turn off the power (ignition) switch.

STEP 2 The fuse is located in the following position. Follow the instructions below to check the fuse.

■ Engine compartment (type A)

Press the retaining clip to open the cover.

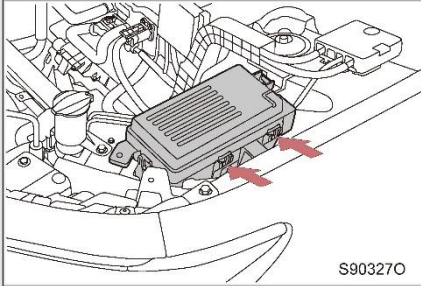

■ Engine compartment (type B)

Press the retaining clip to open the cover.

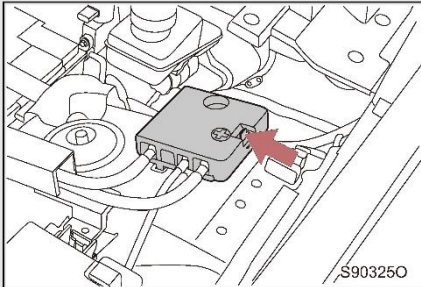

■ Engine compartment (type C)

Press the retaining clip to open the cover.

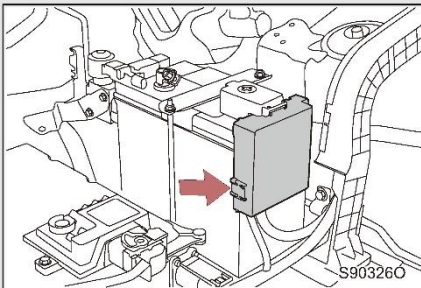

■ Driver side instrument panel

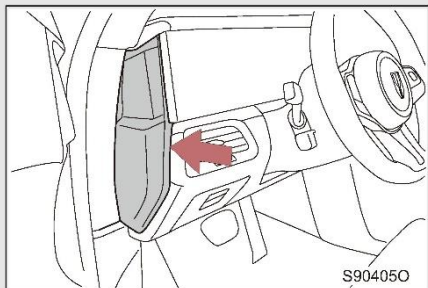

Detach the left cover plate from the instrument panel.

■ Right front door sill trim plate

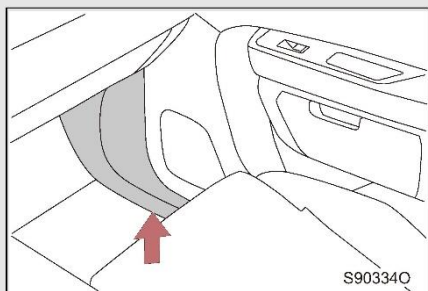

Detach the right front door sill trim plate. When replacing the fuse here, it is recommended to contact the authorized FAW Hongqi dealer for replacement.

■ Trunk

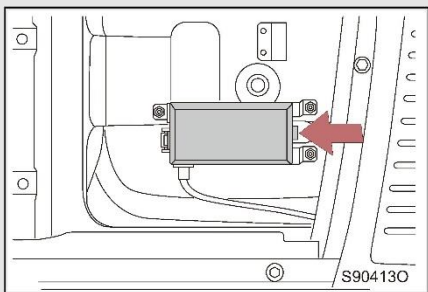

Take out the tool box to open the box cover.

7-3. Self-maintenance

STEP 3

After a system failure occurs, contact an authorized FAW Hongqi dealer to find out exactly which fuses to check.

STEP 4

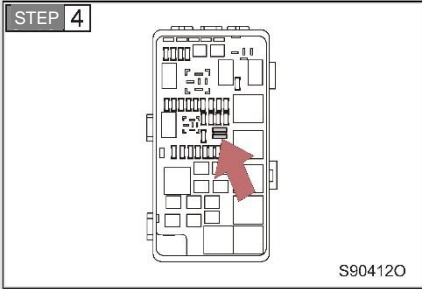

Remove the fuse with the remover.

STEP 5

Check if the fuse is blown.

► Type A

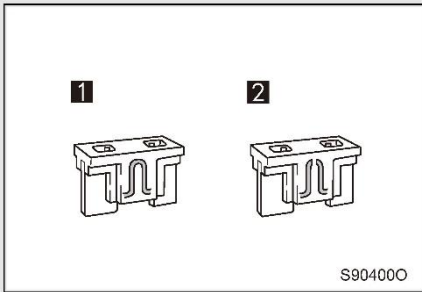

1 Normal fuse

2 Blown fuse

► Type B

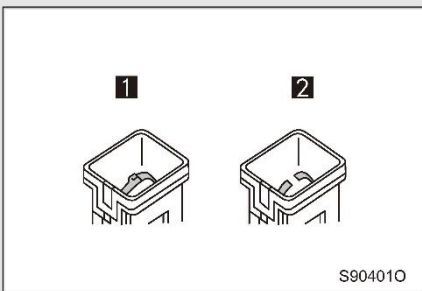

1 Normal fuse

2 Blown fuse

Replace the fuse with a fuse of the rated amperage allowed by FAW.

■ Fuse distribution and amperage rating

Please contact an authorized FAW Hongqi dealer for confirmation of fuse distribution and amperage rating.

■ After fuse replacement

- If the electrical function still does not work properly after replacing the fuse, further inspection may be required. Please contact an authorized FAW Hongqi dealer.
- If the replaced fuse blows again, please contact the authorized FAW Hongqi dealer to check the vehicle.

■ If a circuit is overloaded

The fuse will blow and may damage the entire wiring harness.



WARNING

■ Preventing system failure and vehicle fire

Please observe the following precautions as failure to do so may result in damage to the vehicle, fire or injury to persons.

- Never use a fuse that is higher or lower than the rated amperage.
- Be sure to use the same or equivalent products recommended by an authorized FAW Hongqi dealer.

Never use wire instead of fuse, even temporary replacement is not allowed, otherwise it may lead to serious damage to the vehicle or even fire.

- Do not modify the fuse or fuse box.



Notice

■ Before replacing a fuse

Please contact an authorized FAW Hongqi dealer to determine the cause of excessive electrical load and have it repaired.

7-3. Self-maintenance

Power battery

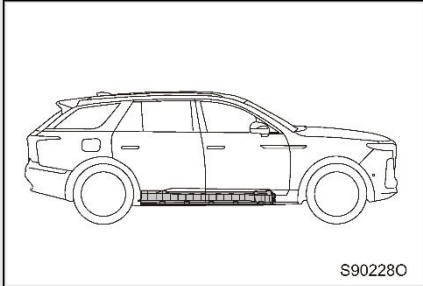

The power battery is arranged under the vehicle floor.

- **Do not park the vehicle near high temperature heat sources or fire sources to avoid fire.**
- **Do not park the vehicle in a wet and ponding place, and avoid the battery pack from soaking in water for a long time to prevent fire.**
- **Park the vehicle in a dry, cool and ventilated position as far as possible, and avoid long-term exposure to the sun as far as possible.**
- **When the battery is not in use, it will also discharge slowly, which will lead to a decrease in battery power (average 1%/week). If the power drops to 0%, it will cause damage to the battery. Therefore, if the vehicle is left unused for a long time, please evaluate the parking power consumption according to the estimated storage time. Even if parking will not cause the power dropping to 0%, it is still not recommended to park the vehicle for a long time. Standing for a long time will lead to a decrease in driving range. If necessary, please perform maintenance monthly following the method below:**
 - Discharge the vehicle in an appropriate way (driving vehicle or power consuming by high-voltage devices) until the instrument prompts: "Power battery is low, please charge".
 - Charge the power battery to full via household or AC charging piles.

■ **Power battery recycling**

Power batteries are industrial dangerous goods, and their irregular disposal will cause serious pollution to the environment. According to the requirements of relevant national policies on power battery recycling, the power batteries shall be recovered by the qualified recycling service outlets. For information of recycling service outlets, please consult the authorized FAW Hongqi dealer.

Do not sell, transfer or remove, disassemble or modify power batteries without permission. When the power battery can no longer be used or need to be recycled, the vehicle should be sent to the designated service outlet, and the power battery should be detached from the vehicle in accordance with the specified procedure for avoidance of safety accidents. According to relevant laws and regulations, if a user does not dispose of waste power batteries in a standardized way, which causes safety accidents or environmental pollution, the liability arising therefrom shall be born by the user.

**WARNING**

- **If the power battery is not properly recovered, the following situations may occur, causing certain personal injury:**
 - Illegal scrapping or disposal of power batteries will cause harm to the environment, or people may be subjected to electric shock due to touching high-voltage parts.
 - Power batteries are specially used for electric vehicles. If the power battery is used outside the vehicle or modified in any way, electric shock, heating, smoke, explosion, electrolyte leakage and other accidents may occur.
 - When a vehicle is not sold or transferred with the help of the authorized FAW Hongqi dealer, the possibility of safety accidents is high since the purchasers do not know these dangers.
- **When the battery leaks in the case of a vehicle collision, or there is pungent aromatic smell in the vehicle or obvious liquid flows out of the vehicle, or smoke comes out of the battery pack:**
 - Turn the power (ignition) switch to OFF and disconnect the 12 V battery when conditions permit.
 - Immediately call the service hotline of the authorized FAW Hongqi dealer to request rescue, and do not perform other operations on the vehicle.
- **The high voltage of the power battery is very dangerous. It is strictly prohibited for non-professionals to remove or repair the power battery.**
- **If the power battery is not removed when the vehicle is scrapped, there may be a risk of severe electric shock when touching high-voltage parts, cables and their connectors. If the vehicle must be scrapped, the power battery must be disposed by the authorized FAW Hongqi dealer or professional institute. If the power battery is improperly handled, it may cause electric shock, resulting in serious injury or even death.**



Notice

- The power battery assembly is integrated with a thermal management system, but it is still recommended that users shall avoid aggressive driving in extreme high and low temperature environment as much as possible.
- The power battery should be stored in a dry and ventilated environment at - 40-60℃. In order to ensure the battery performance, it is not recommended to expose the complete vehicle to the environment below -30 ℃ or above 60 ℃ for more than 24 h. It is recommended to store the battery in the environment at 5-30℃ if the storage duration exceeds one week.
- Avoid exposing the power battery to hot or humid environment for a long time (such as when baking paint), and do not exceed 30 min at 70 ℃ or 20 min at 80 ℃. It is recommended to remove the power battery assembly during paint baking.
- If the vehicle is to be re-charged after more than 2 months from last charging and discharging, please charge via household or AC charging piles.
- Try to avoid driving the vehicle in water exceeding the chassis height, otherwise it may cause permanent damage to the power battery assembly. If the vehicle wades, please drive it to a dry area for parking as soon as possible.
- Do not park the vehicle in a wet and ponding place, and avoid the power battery from soaking in water for a long time to prevent fire.
- Failure to maintain the battery for more than 6 months may cause damage to the battery.
- In order to protect the battery performance, it is not advisable to discharge the power to a very low level, otherwise it may cause permanent damage to the battery performance.
- When the power battery capacity is obviously attenuated (the driving range of the vehicle obviously reduce) or the power battery has serious failure (the vehicle cannot drive normally, and the instrument prompts "power system failed"), please contact the authorized FAW Hongqi dealer to test and maintain the power battery and to replace the power battery assembly where necessary.

8-1. Important information

Hazard warning lamp	340
SOS alarm.....	341

8-2. Measures to be taken in case of emergency

If the vehicle needs to be towed	342
If the vehicle is found to be abnormal	346
If the alarm lamp lights up or the alarm speaker sounds	347
If a tire leaks.....	352
In case of power system failure to starter	354
If the key is lost	355
In case of key failure to work normally	356
If the door can not be locked properly	358
In case of low 12 V battery	360
If the vehicle is overheated	363
In case of an electrical fire	365
If a trap occurs	366
If driving on waterlogged roads	367
In the event of a flat tire.....	368
In the event of an accident.....	369
Emergency opening of trunk lid.....	370

8-1. Important information

Hazard warning lamp

When the vehicle breaks down, please stop by the side of the road while using the hazard warning lamps; when the vehicle cannot be moved due to the breakdown, please place a warning triangle behind the vehicle while turning on the hazard warning lamps. If necessary, please put on a reflective undershirt.

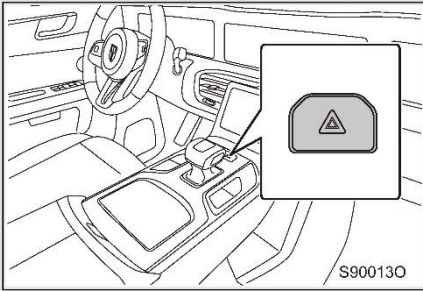

Press the hazard warning lamp switch, all turn signal lamps will flash; Press again to turn off the hazard warning lamp.

Notice

■ **Prevent 12 V battery from being insufficient**

When the power (ignition) switch is not turned on, turn off the hazard warning indicator if not required.

8-1. Important information SOS alarm

If you need help in case of emergency, press and hold the SOS alarm switch for 3 s and then release it. The E-call starts dialing, and the SOS indicator changes from normally on to flashing. After receiving your call for help, the background will arrange proper rescue service for you.

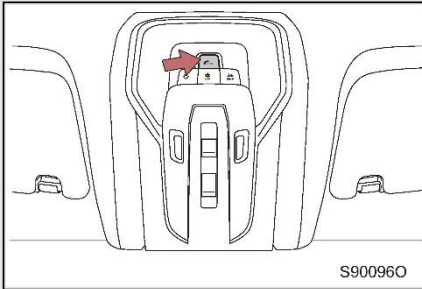

The SOS alarm switch is located behind the front interior lamp.



Notice

- Please use the SOS alarm switch when necessary.

8-2. Measures to be taken in case of emergency If the vehicle needs to be towed

If the vehicle needs to be towed, FAW recommends using a platform truck and having the vehicle towed by the authorized FAW Hongqi dealer or professional rescue company, and it is strictly prohibited to tow the vehicle in P gear.

All towing is done with safety chain devices and in compliance with all regulations of the country or region where it is done.

Before towing

If any of the following conditions occur, the transmission system may be faulty. Please contact an authorized FAW Hongqi dealer before towing your vehicle.

- The power system operates normally, but the vehicle cannot be moved.
- There is abnormal noise or vibration in the vehicle.

The use of a lifting load trailer for towing is strictly prohibited



Do not tow with a lifting load trailer to prevent damage to the body.

Towing from the front with a wheel lift cargo trailer

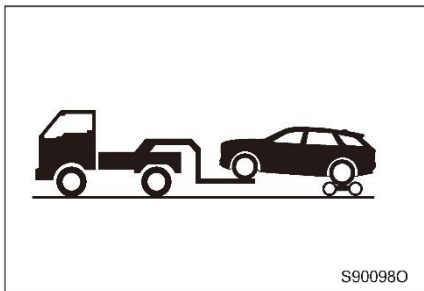

Place the towing trolley under the rear wheels and put the vehicle into lift mode.

Towing from the rear with a wheel lift cargo trailer

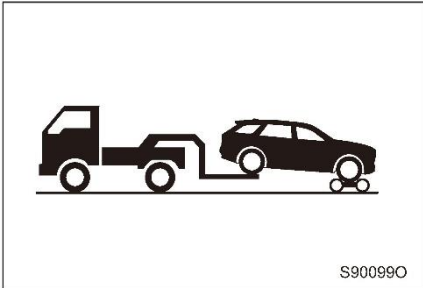

Place the towing trolley under the front wheels and put the vehicle into lift mode.

Use of platform cargo trailer

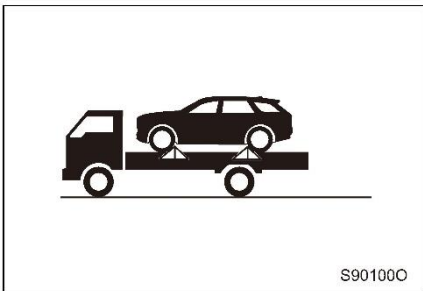

Apply the electronic parking brake, put the vehicle into lifting mode, and turn off the power (ignition) switch.

Place blocks under all 4 wheels to prevent vehicle movement.

Secure the vehicle by tying the tires to the floor of the trailer as shown in the diagram.

Emergency towing

If a cargo trailer cannot be found in an emergency, the vehicle can be temporarily towed by fastening the tow cable or trailer chain in the traction ring and shifting into N gear. This method can only be used for short distance towing at low speed on hard paved roads.

The driver must sit inside the vehicle to control the steering wheel and brake pedal. The wheels, driveline, steering wheel and brakes must be in good condition.

Emergency towing steps

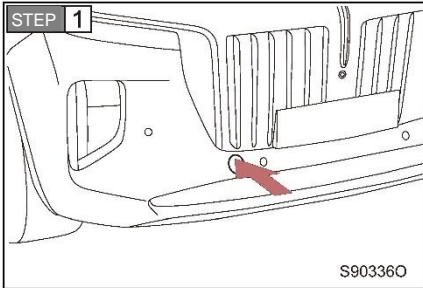

Press the upper part of the tow ring cover to disengage the tow ring cover.

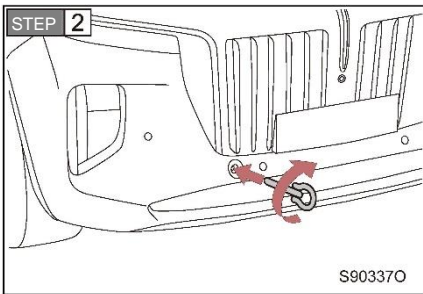

Insert the traction ring into the hole and tighten it slightly by hand.

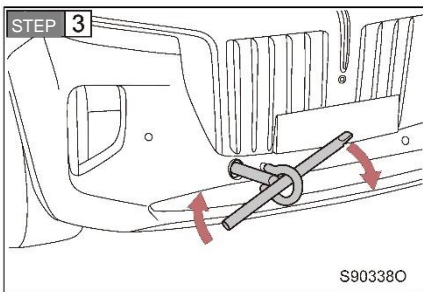

Secure the tow ring with an aid tool.

STEP 4 Securely fasten the tow cable or tow chain to the traction ring.
Be careful not to damage the body.

STEP 5 Enter the vehicle being towed and start it.
If the vehicle cannot start, turn the power (ignition) switch to ON.

STEP 6 Release the electronic parking brake (EPB) and engage into N gear.

■ Traction ring

The tow ring is stored in the driver's tool box. (Refer to P.352)



WARNING

Please observe the following precautions, otherwise it may lead to serious injury or even death.

■ When towing the vehicle

Always transport the vehicle with all four wheels off the ground.

If the vehicle is towed with the drive wheels touching the ground, the drive train and related parts may be damaged.

■ When towing

- When using the rope towing, avoid sudden start, etc., otherwise there will be too much tension on the traction ring and rope.

The traction ring or rope may be damaged and broken pieces may hit people and cause serious injury.

■ Attaching the traction ring to the vehicle

Make sure the traction ring is securely installed.

Otherwise, the traction ring may come loose during towing. This may lead to an accident.



Notice

■ Prevent damage to the vehicle when towing with a wheel lift cargo trailer

When lifting the vehicle, make sure there is enough ground clearance at the landing end of the vehicle for towing. Otherwise, the vehicle may be damaged during towing.

■ Prevent damage to the vehicle when towing with a lifting load trailer

Whether towing from the front or rear of the vehicle, a lifting load trailer shall not be used.

■ Prevent damage to the vehicle when using a platform cargo trailer

- Do not drive over the blocks, as this may damage the tires.
- Do not tie the vehicle to parts other than the tires (e.g., suspension).

8-2. Measures to be taken in case of emergency If the vehicle is found to be abnormal







If any of the following symptoms are found, the vehicle may need to be adjusted or repaired. Please contact an authorized FAW Hongqi dealer as soon as possible.

- Visible symptoms
 - Fluid leaks under the vehicle. (It is normal for the air conditioner to drip after use)
 - Flat or uneven tire wear.
 - Persistently high coolant temperature.
- Audible symptoms
 - Excessive tire noise during cornering.
 - Abnormal noise related to the suspension system.
 - Noise related to the power system.
- Operational symptoms
 - Power is significantly reduced.
 - Vehicle runs badly when braking.
 - The vehicle runs badly when driving on a flat road.
 - Brake failure, soft brake pedal or pedal almost touching the floor.











If the alarm lamp lights up or the alarm speaker sounds











If an alarm lamp lights up or flashes, remain calm and perform the following actions. If the alarm lamp lights up or flashes but then goes off, it does not necessarily indicate a system malfunction. However, if it continues to occur, please contact an authorized FAW Hongqi dealer to have the vehicle checked.

List of alarm lamps

Alarm lamp	Alarm lamps/Details/Measures
	<p>Low charge state warning lamp</p> <ul style="list-style-type: none"> It indicates that the battery power is low. <p>→ Please charge or contact an authorized FAW Hongqi dealer.</p>
	<p>Power battery system MIL</p> <ul style="list-style-type: none"> It indicates that the power battery system is faulty. <p>→ Immediately park the vehicle in a safe place and contact an authorized FAW Hongqi dealer.</p>
	<p>12 V battery charging MIL</p> <ul style="list-style-type: none"> If the alarm lamp is on continuously, it means that the 12 V battery charging system is faulty. <p>→ Immediately park the vehicle in a safe place and contact an authorized FAW Hongqi dealer.</p>
	<p>Bulb MIL</p> <ul style="list-style-type: none"> Indicates a malfunction in the vehicle's exterior lamps. <p>→ Check the exterior lamps and wiring harness connectors for faults or immediately contact an authorized FAW Hongqi dealer.</p>
	<p>SRS fault alarm lamp</p> <ul style="list-style-type: none"> Indicates a malfunction in the airbag system. <p>→ Please contact an authorized FAW Hongqi dealer immediately.</p>
	<p>Unbuckled seat belt alarm lamp</p> <ul style="list-style-type: none"> It indicates that the driver or occupant seat belt is not fastened. <p>→ Fasten the driver and occupant seat belts.</p>
	<p>Electronic shift system MIL</p> <ul style="list-style-type: none"> It indicates that the electronic shift system is faulty. <p>→ Immediately park the vehicle in a safe place and contact an authorized FAW Hongqi dealer.</p>



8-2. Measures to be taken in case of emergency

Alarm lamp	Alarm lamps/Details/Measures
	<p>Electronic parking (Epark) lock warning lamp</p> <ul style="list-style-type: none"> • It indicates that the Epark is faulty. <p>→Immediately park the vehicle in a safe place and contact an authorized FAW Hongqi dealer.</p>
	<p>PEPS MIL</p> <ul style="list-style-type: none"> • It indicates that the smart entry system is faulty. <p>→Please contact an authorized FAW Hongqi dealer immediately.</p>
	<p>Immobilizer system MIL</p> <ul style="list-style-type: none"> • It indicates that the immobilizer system is faulty. <p>→Please contact an authorized FAW Hongqi dealer immediately.</p>
	<p>Low key battery warning lamp</p> <ul style="list-style-type: none"> • It indicates that the key power is insufficient. <p>→Replacing the key battery.</p>
	<p>Power system MIL</p> <ul style="list-style-type: none"> • It indicates that the power system is faulty. <p>→Immediately park the vehicle in a safe place and contact an authorized FAW Hongqi dealer.</p>
	<p>Electronic wiper system MIL</p> <ul style="list-style-type: none"> • It indicates that the electronic wiper system is faulty. <p>→Please contact an authorized FAW Hongqi dealer immediately.</p>
	<p>Low washer fluid level warning lamp</p> <ul style="list-style-type: none"> • It indicates that the washer fluid level is too low. <p>→ Add washer fluid or contact the authorized FAW Hongqi dealer immediately.</p>
	<p>Brake fluid level too low/system MIL</p> <ul style="list-style-type: none"> • It indicates a brake system malfunction. <p>→Immediately park the vehicle in a safe place and contact an authorized FAW Hongqi dealer. It may be dangerous to continue driving the vehicle.</p>
	<p>Brake degradation warning lamp</p> <ul style="list-style-type: none"> • It indicates a brake system malfunction. <p>→Immediately park the vehicle in a safe place and contact an authorized FAW Hongqi dealer. It may be dangerous to continue driving the vehicle.</p>
	<p>EPS fault alarm lamp</p> <ul style="list-style-type: none"> • It indicates that the EPS is faulty. <p>→Please drive carefully and contact an authorized FAW Hongqi dealer.</p>

Alarm lamp	Alarm lamps/Details/Measures
	<p>EPS MIL</p> <ul style="list-style-type: none"> • It indicates that the EPS is seriously faulty. <p>→ Immediately park the vehicle in a safe place and contact an authorized FAW Hongqi dealer.</p>
	<p>ABS alarm lamp</p> <ul style="list-style-type: none"> • It indicates an ABS malfunction. <p>→ Please contact an authorized FAW Hongqi dealer immediately.</p>
	<p>Brake lining excessive wear warning lamp</p> <ul style="list-style-type: none"> • It indicates that the brake lining is of excessive wear. <p>→ Please contact an authorized FAW Hongqi dealer immediately to check and replace the brake lining.</p>
	<p>EPB alarm lamp</p> <ul style="list-style-type: none"> • It indicates an EPB malfunction. <p>→ Immediately park the vehicle in a safe place and contact an authorized FAW Hongqi dealer.</p>
	<p>AUTO HOLD system MIL</p> <ul style="list-style-type: none"> • It indicates that the AUOT HOLD system is faulty. <p>→ Please contact an authorized FAW Hongqi dealer immediately.</p>
	<p>HDC fault alarm lamp</p> <ul style="list-style-type: none"> • Indicates an HDC malfunction <p>→ Please contact an authorized FAW Hongqi dealer immediately.</p>
	<p>APA fault alarm lamp</p> <ul style="list-style-type: none"> • Indicates an APA malfunction <p>→ Please contact an authorized FAW Hongqi dealer immediately.</p>
	<p>Tire pressure abnormality/system fault alarm lamp</p> <ul style="list-style-type: none"> • It indicates a TPMS malfunction or abnormal tire pressure. <p>→ Immediately park the vehicle in a safe place and contact an authorized FAW Hongqi dealer.</p>
	<p>Automatic running lamp/automatic wiper MIL</p> <ul style="list-style-type: none"> • It indicates that the automatic driving lamp/automatic wiping is faulty. <p>→ Please contact an authorized FAW Hongqi dealer immediately.</p>
	<p>Headlamp leveling system MIL</p> <ul style="list-style-type: none"> • It indicates that the headlamp leveling system is faulty. <p>→ Please contact an authorized FAW Hongqi dealer immediately.</p>

8-2. Measures to be taken in case of emergency

Alarm lamp	Alarm lamps/Details/Measures
	<p>Driving mode selection system fault alarm lamp</p> <ul style="list-style-type: none"> Indicates a malfunction in the drive mode selection system. <p>→ Please contact an authorized FAW Hongqi dealer immediately.</p>
	<p>Driving assistance system (DAS) MIL</p> <ul style="list-style-type: none"> It indicates that the DAS is faulty. <p>→ Please contact an authorized FAW Hongqi dealer immediately.</p>
	<p>Air suspension (AirS) system MIL</p> <ul style="list-style-type: none"> It indicates that the AirS system is faulty. <p>→ Please contact an authorized FAW Hongqi dealer immediately.</p>
	<p>AirS system MIL</p> <ul style="list-style-type: none"> It indicates that the AirS system is seriously faulty. <p>→ Please contact an authorized FAW Hongqi dealer immediately.</p>
	<p>SOS MIL</p> <ul style="list-style-type: none"> It indicates that the SOS phone is faulty. <p>→ Please contact an authorized FAW Hongqi dealer immediately.</p>
	<p>Coolant level too low warning lamp</p> <ul style="list-style-type: none"> It indicates that the coolant level is too low. <p>→ Please contact an authorized FAW Hongqi dealer immediately.</p>
	<p>High coolant temperature alarm lamp</p> <ul style="list-style-type: none"> It indicates that the coolant temperature is too high. <p>→ Immediately park the vehicle in a safe place and contact an authorized FAW Hongqi dealer.</p>
	<p>Motor system MIL</p> <ul style="list-style-type: none"> It indicates that the motor system is faulty. <p>→ Immediately park the vehicle in a safe place and contact an authorized FAW Hongqi dealer.</p>
	<p>Thermal management system MIL</p> <ul style="list-style-type: none"> It indicates that the thermal management system is faulty. <p>→ Please contact an authorized FAW Hongqi dealer immediately.</p>
	<p>Water heater PTC MIL</p> <ul style="list-style-type: none"> It indicates that the PTC water heater is faulty. <p>→ Please contact an authorized FAW Hongqi dealer immediately.</p>

Alarm lamp	Alarm lamps/Details/Measures
	<p>Wireless charging fault alarm lamp</p> <ul style="list-style-type: none"> • It indicates that the wireless charging is faulty. <p>→ Please contact an authorized FAW Hongqi dealer immediately.</p>
	<p>Power battery thermal runaway signal missing warning lamp</p> <ul style="list-style-type: none"> • It indicates that the systems relating the power battery is faulty. <p>→ Please contact an authorized FAW Hongqi dealer immediately.</p>
	<p>High-voltage system MIL</p> <ul style="list-style-type: none"> • It indicates that the high voltage system of the vehicle is faulty. <p>→ Immediately park the vehicle in a safe place and contact an authorized FAW Hongqi dealer.</p>

Note: When the indicators such as coolant high temperature alarm light up, the alarm speaker sounds.

8-2. Measures to be taken in case of emergency If a tire leaks

Please use the tire repair kit included with the vehicle tools for repair.
For details, please refer to the instructions in the tire repair kit.

■ Accompanying tools

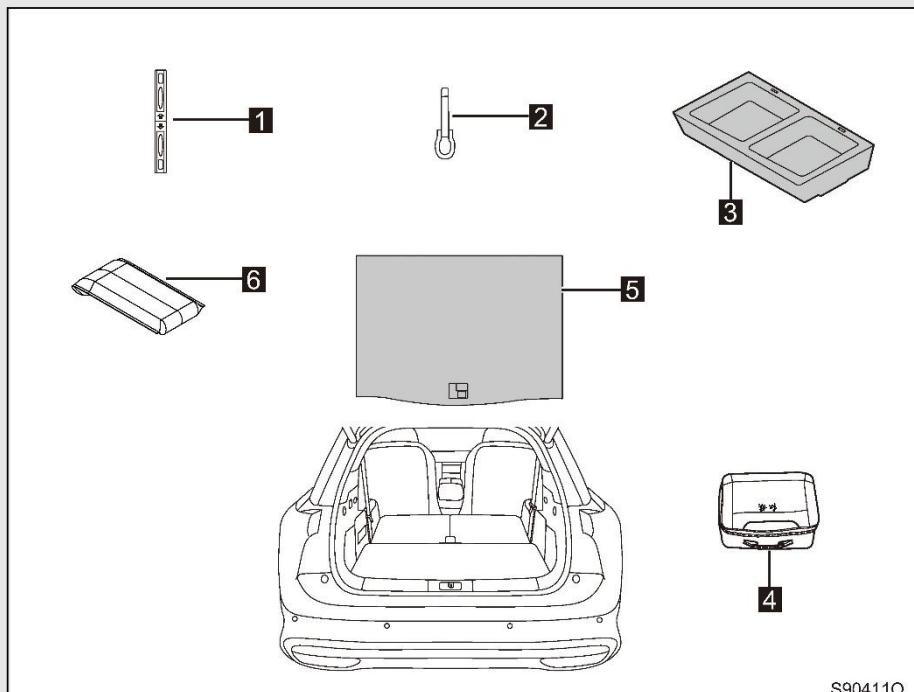

S904110

1 Triangle warning sign

2 Traction ring

3 Tool box

4 Tire repair kit

5 Trunk carpet

6 Reflective undershirt assembly

**WARNING****■ Do not drive a vehicle with leaking tires**

- Do not continue to drive a vehicle with a leaking tire.
- If you continue to drive, the tire and vehicle may be damaged even if you drive a short distance, making it impossible to repair or even causing a traffic accident.

■ Before repairing tires

- Park the vehicle on a hard, flat surface.
- Apply the EPB.
- Shift the gear to P.
- Turn the power (ignition) switch to OFF.
- Turn on the hazard warning lamps and place triangular warning signs.

**Notice**

- **Pay attention to the surrounding environment when repairing tires to avoid accidents.**

8-2. Measures to be taken in case of emergency In case of power system failure to starter

If the power system still fails to start even after correct start steps (refer to P.125), please consider the causes below.

- If the power system still fails to start even after correct start steps.

The cause of the malfunction may be one of the following:

- The electric charge of the vehicle power battery is insufficient.
- The key cannot operate normally.
- The gear control system may be faulty.
- Electrical faults (like key battery depletion or a blown fuse) can cause power system fault. However, you can take emergency as per the fault type to start the power system.
- The shutdown system may be faulty. (Refer to P.60)

- If the interior lamps and headlamps are dim or the horn cannot sound or the sound volume is too low

The cause of the malfunction may be one of the following:

- The 12 V battery power is insufficient or has been depleted. (Refer to P.360)
- The terminal connector of the 12 V battery may be loose or corroded.

- If the interior lamps or headlamp cannot light up or the horn cannot sound

The cause of the malfunction may be one of the following:

- The 12 V battery terminal has been disconnected.
- The 12 battery power has been depleted.

If you cannot troubleshoot or are not sure of the repair procedure, please contact an authorized FAW Hongqi dealer.

8-2. Measures to be taken in case of emergency If the key is lost

If a smart key is lost or stolen, then please provide the remaining keys to an authorized FAW Hongqi dealer as soon as possible. The lost or stolen key will be invalid after the key is re-matched. Unauthorized and illegal modifications, or the use of non-standard spare parts may cause the system to fail in operation.

8-2. Measures to be taken in case of emergency In case of key failure to work normally

If the communication between the key and the vehicle is interrupted (See P.91) or if the key cannot be used due to a low battery, the PEPS system and the wireless remote control functions will not be available. In this case, the following steps can be used to open the door or start the power system.

Locking and unlocking the doors

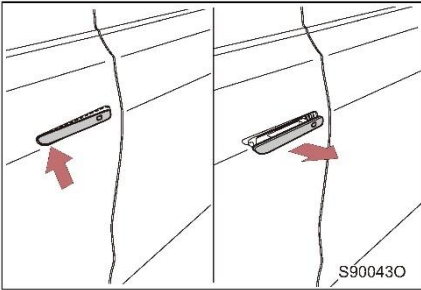

Press the front part of the driver side door handle to tilt it, then pull the middle part and pull it out vertically.

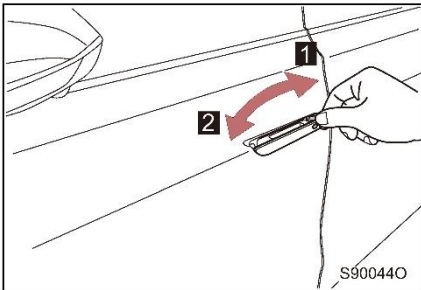

Hold the door handle, and lock and unlock the vehicle with a mechanical key.

- 1 Unlocking the door
- 2 Locking the door

Backup start mode

When the key is low on power, the backup start mode is required.

STEP 1 Press the power (ignition) switch or depress the brake pedal.

In this case, the instrument cluster multi-function display will prompt "Unable to recognize the key".

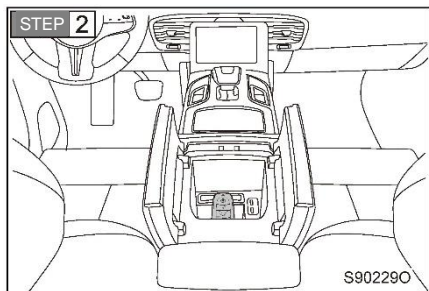

Open the front central storage box, then place the smart key in the storage box.

STEP 3 Press the power (ignition) switch or depress the brake pedal to start the power system.

If the power system still cannot be started, please contact an authorized FAW Hongqi dealer.

■ Replacing the key battery

If the power of the smart key is insufficient, replace its battery in time. (Refer to P.329)

8-2. Measures to be taken in case of emergency If the door can not be locked properly

If the doors cannot be locked by the passive entry function or wireless remote control function due to low battery power. In this case, the following steps can be used to lock each door.

Locking the driver side door

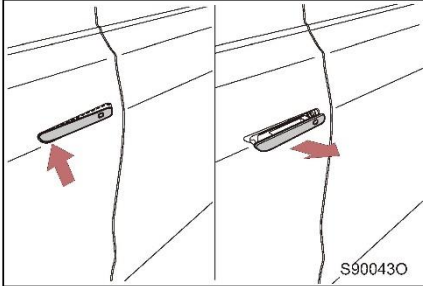

Press the front part of the driver side door handle to tilt it, then pull the middle part and pull it out vertically.

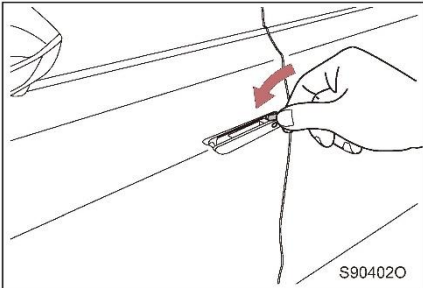

Hold the door handle, and lock the vehicle with a mechanical key.

Locking the front passenger side and rear occupant side doors

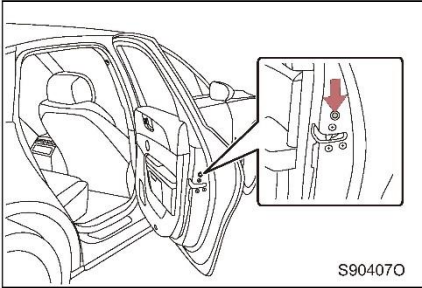

Disengage the mechanical locking switch guard of the corresponding side door.

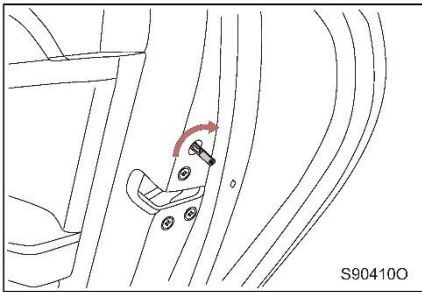

Use the mechanical key to close the doors after locking.

Doors at the front passenger side and the right rear side: turn the doors clockwise; left rear door: turn the switch counterclockwise.

8-2. Measures to be taken in case of emergency In case of low 12 V battery

If the battery power is low, you can take the following measures to start the power system.

You can contact an authorized FAW Hongqi dealer or a professional repair store.

If you have a set of jumper cables (or auxiliary cables) and another vehicle with a 12V battery, you can jumper start your vehicle by following these steps:

STEP 1 Detach the positive cover of the 12V battery.

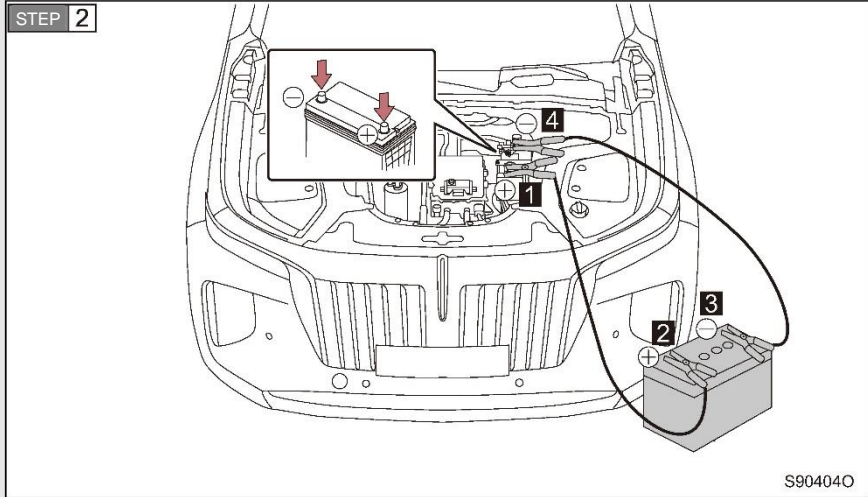

Connect the jumper cables.

- 1** Connect the positive (+) terminal of the 12V battery on your vehicle.
- 2** Connect the positive (+) terminal of the 12V battery on another vehicle.
- 3** Connect the negative (-) terminal of the 12V battery on another vehicle.
- 4** Connect the negative (-) terminal of the 12V battery on your vehicle.

STEP 3 Start the engine of the other vehicle. Increase the engine speed slightly and keep it for about 5 min to recharge the 12V battery of your vehicle.

STEP 4 Keep the engine of the other vehicle running, and then turn the power (ignition) switch of your vehicle to ON.

STEP 5 Once the vehicle has been successfully started, remove the jumper cables in the exact reverse order of when they were connected.

Once the vehicle is started, please drive the vehicle to an authorized FAW Hongqi dealer for inspection as soon as possible.

■ Charging the 12V battery

Due to natural discharge and the depletion effect of certain electrical equipment, the power stored in the 12 V battery is gradually depleted even when the vehicle is not in use. If the vehicle is left idle for an extended period of time, the 12V battery power may be depleted and the vehicle may fail to start. (Automatically charge the 12V battery after starting the vehicle)

■ When replacing the 12V battery

Use 12V batteries that meet original factory standards.



Notice

■ When operating jumper cables

- Only one 12V auxiliary battery can be used.
- When connecting or disconnecting a jumper cable, be careful not to entangle the cable with the cooling fan.



WARNING

■ When removing the 12V battery terminals

- Be sure to remove the negative (-) terminal first. If any metal in the surrounding area is touched while removing the positive (+) terminal, a spark may be generated which could cause a fire, and an electric shock could be caused, resulting in serious injury or even death.

■ Avoid 12V battery fire or explosion

The 12V battery may emit flammable gases. To avoid accidental ignition of flammable gases, be sure to observe the following precautions:

- Make sure that each jumper cable is connected to the correct terminal and does not accidentally contact terminals other than the correct terminal.
- Do not allow the other end of the jumper cable connected to the "+" terminal to come in contact with any other parts or metal surfaces in this area, such as brackets or unpainted metal.
- Do not allow the "+" clip and "-" clip of the jumper cable to come into contact with each other.
- Do not light any open flame, smoke or use matches or lighters near the 12V battery.
- Be careful when connecting the negative cable to the vehicle. Sparks may be generated when connecting the second jumper cable. Sparks may explode the gas near the battery and cause personal injury.



WARNING

- **After the charging, once the vehicle is started, please drive the vehicle to an authorized FAW Hongqi dealer for inspection as soon as possible.**

- **Precautions on the 12V battery**

The 12 V battery contains a toxic and corrosive acidic electrolyte. Therefore, please be sure to observe the following precautions when handling 12V batteries:

- When handling the 12V battery, do wear safety goggles and do not make the 12 V battery electrolyte come into contact with skin, clothing or vehicle body.
- Do not bend over the 12V battery.
- If 12V battery electrolyte comes in contact with skin or eyes, wash with water immediately and seek medical attention. A wet sponge or cloth should be used to cover the contact area prior to the medical attention.
- Do wash your hands after handling 12V battery holders, terminals and other 12V battery-related parts.
- Do not allow children near the 12V battery.
- Lay out jumper cables away from moving parts.

It is dangerous to connect jumper cables to or around moving parts (e.g. cooling fans). When the vehicle starts, the cable may get stuck, which can lead to serious injury.

- If the battery is aging, it may emit malodorous gas if it is used continuously, which may endanger the health of occupants. Please contact an authorized FAW Hongqi dealer to check the battery as soon as possible.

8-2. Measures to be taken in case of emergency If the vehicle is overheated

The following conditions may indicate that the vehicle is overheating.

- Alarm of high coolant temperature or feeling power decrease.
- Steam is coming out from under the hood.

■ Solutions:

STEP 1 Park the vehicle in a safe place and turn off the A/C system.

STEP 2 Check for steam coming from under the hood.

If steam is coming out:

Turn off the power (ignition) switch. Carefully lift the engine hood after the steam has dissipated, then restart power (ignition) switch.

If steam is not coming out:

Keep the power system running and carefully lift the engine hood.

STEP 3 Check that the cooling fan is running.

If the fan is running:

Wait until the coolant temperature begins to drop (coolant temperature is displayed on the instrument cluster), then stop the power (ignition) switch.

If the fan is not running:

Turn of the power (ignition) switch, and then please contact an authorized FAW Hongqi dealer.

STEP 4 After the system has cooled sufficiently, check the coolant level, and then check the cooling system for leakage.

STEP 5 Add coolant when necessary. (Refer to P.314)

In case of emergency, if there is no coolant, contact an authorized FAW Hongqi dealer.



WARNING

■ Precautions during inspection

When opening the vehicle hood for inspection, be sure to observe the following precautions to avoid accidents or injuries to persons.

- If you see steam coming out from under the hood, do not open the hood until the steam dissipates. The vehicle may be very hot, which would lead to serious injuries such as burns.
- Keep away from the fan when the vehicle is powered on.
- Do not loosen the coolant cap when the power system and radiator are hot. Otherwise, the hot coolant and steam may be released under pressure, which could lead to serious burns and other accidents.



Notice

■ When adding coolant

Add coolant slowly after the power system has cooled sufficiently. Adding cold coolant too quickly will damage the power system when the system is very hot.

■ Avoiding damage to the cooling system

Please observe the following precautions:

- Avoid mixing foreign objects (such as sand or dust) in the coolant.
- Do not use any coolant additives.

8-2. Measures to be taken in case of emergency In case of an electrical fire

In case of an electrical fire, please observe the following operation steps and contact an authorized FAW Hongqi dealer as soon as possible.

- Protect yourself and do not breathe fumes.
- Call 110
- When extinguishing fires on electrical equipment, use CO2 fire extinguishers or foam fire extinguishers.
- Do not use CO2 fire extinguishers to extinguish fires on persons. Because there is a danger of suffocation.

8-2. Measures to be taken in case of emergency If a trap occurs

If the wheels are idling or the vehicle is stuck in sludge or snow, do the following.

- STEP 1** Apply the EPB and shift the gear to P. Turn off the power (ignition) switch.
- STEP 2** Remove mud, snow or sand from around the trapped tire.
- STEP 3** Place blocks of wood, rocks or other materials under each tire to increase the grip of the tire.
- STEP 4** Turn the power (ignition) switch to ON.
- STEP 5** Shift the gear to D or R and carefully step on the accelerator pedal to get the vehicle out of the trap.

■ Emergency towing

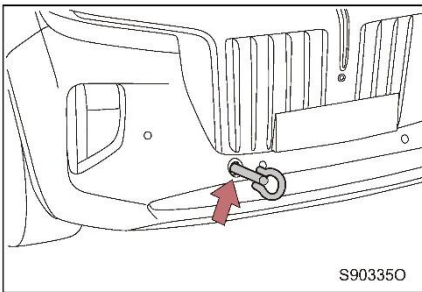

- When the vehicle is trapped or cannot be moved, the towing cable or trailer chain can be tied to another vehicle to tow the vehicle in case of emergency using the traction ring.
- For more information on towing, please refer to "If the vehicle needs to be towed" in this chapter. (Refer to P.342)
- It is not recommended that you tow other vehicles with this vehicle.

WARNING

■ **When trying to get out of a stuck vehicle situation**

If you move your vehicle back and forth to get out of a trap, make sure the surrounding area is clear to avoid hitting other vehicles, objects or people. When the vehicle is about to drive out of the trap, it may suddenly rush forward or backward, so extra care should be taken.

■ **When operating the shift lever**

Do not step on the accelerator pedal by mistake when shifting gears, as this may cause the vehicle to accelerate suddenly, which could lead to a serious accident.

Notice

■ **Avoiding damage to components**

- If you are unable to get out of a stuck vehicle after trying these methods, you will need towing assistance.

8-2. Measures to be taken in case of emergency If driving on waterlogged roads

In case you accidentally drive on a waterlogged road and get water, please contact an authorized FAW Hongqi dealer to have the following items checked:

- Check the braking efficiency of the brakes.
- Check the oil quantity and quality in the reducer (when the lubricant is white and cloudy, it means that it is mixed with water and should be replaced).
- Lubrication of the drive shaft, each bearing, each joint and other parts.



If driving on waterlogged roads, it is easy to cause the power system fault, short circuit in and water ingress into electrical elements. Please do not try to start the power (ignition) switch after the power system is shut down, otherwise it may cause serious damage to the power system.

8-2. Measures to be taken in case of emergency In the event of a flat tire

In case of a flat tire or tire rupture while driving, please respond calmly.

Hold the steering wheel firmly and slowly step on the brake pedal to slow down the vehicle. Emergency braking or sharp turning the steering wheel is easy to make the vehicle out of control. In case of any of follows, please judge whether it is caused by tire blowout or rupture:

- the steering wheel is shaking.
- the vehicle vibrates abnormally.
- the vehicle is tilted abnormally.

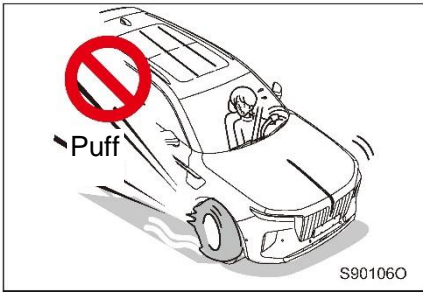

Do not drive with a flat tire.

Continuing to drive with a flat tire will be very dangerous and could easily lead to an accident. In addition, it will bring damage to the tire, rim, suspension and body, so please change the tire immediately or contact an authorized FAW Hongqi dealer.

8-2. Measures to be taken in case of emergency In the event of an accident

Do not panic, please follow the following methods:

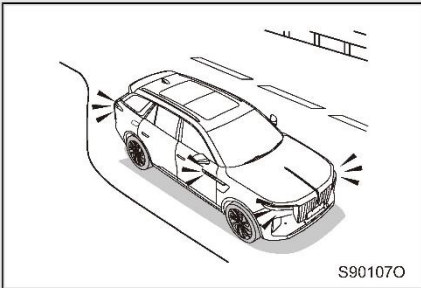

- 1** Prevent continuous accidents from occurring.

Move the vehicle to a safe area so as not to interfere with traffic, and then turn off the power (ignition) switch.

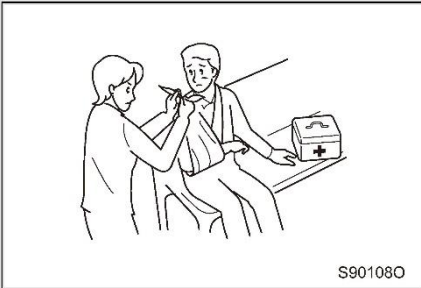

- 2** If there are people injured, take emergency measures to save their lives.

Try to take emergency measures until doctors and emergency vehicles arrive. If the head injury is serious, try to stay in the same position and not move, or move to safety if you are concerned about a continuing accident.



- 3** Call the police.

- 4** Identify the at-fault party and make notes (name, address, phone number, etc.).

- 5** Contact an authorized FAW Hongqi dealer and the insurance company.

8-2. Measures to be taken in case of emergency

Emergency opening of trunk lid

The following steps can be used as an emergency measure to ensure that the trunk lid can be opened.

STEP 1 Enter the trunk by folding the second and third row seat backrests.

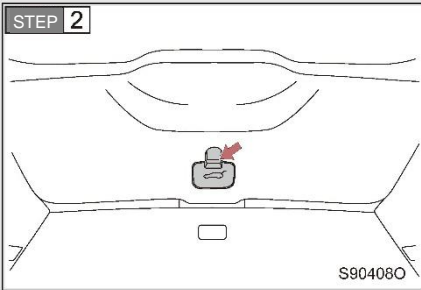

Open the emergency lock cover on the trunk lid.

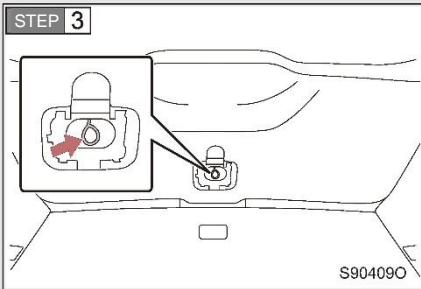

Pull the unlocking cable on trunk lid to open the trunk lid.



WARNING

- **Be careful when opening or closing the trunk lid manually in case of emergency to prevent injury.**
 - Never leave children or persons in need of assistance to operate the vehicle alone. In the event of an emergency, children and persons in need of assistance may be trapped in the vehicle and unable to safely evacuate or rescue themselves.
 - With seasonal changes, the temperature inside a locked vehicle can be very high or very low, making the occupants extremely vulnerable to injury and illness, and even death, especially for young children.
 - Always use caution when opening or closing the trunk lid and make sure no one is between the trunk lid and the bodywork.



Notice

■ Preventing vehicle damage

When opening or closing the trunk lid in an emergency, it is important to remove and install the parts carefully to avoid damaging the vehicle.

Vehicle specifications

9

9-1. Specification

Service data 372

9-1. Specification

Service data

Size

■ Model No.: E-HS9E01, E-HS9E02, E-HS9E03, E-HS9E04

Total length	5,209 mm	
Total width	2,010 mm	
Total height	1,731 mm (E-HS9E01, E-HS9E02) 1,713 mm (E-HS9E03, E-HS9E04)	
Front suspension	916 mm	
Rear suspension	1,183 mm	
Wheelbase	3,110 mm	
Tread	Front	1,708 mm
	Rear	1,709 mm
Approach angle	22.5° (E-HS9E01、E-HS9E02)	
	21.3° (E-HS9E03)	
Departure angle	22.4° (E-HS9E01、E-HS9E02)	
	21.4° (E-HS9E03)	

Number of passengers

■ Model No.: E-HS9E01, E-HS9E02

Number of passengers	7
----------------------	---

■ Model No.: E-HS9E03, E-HS9E04

Number of passengers	6
----------------------	---

Drive mode

- Model No.: E-HS9E01, E-HS9E02, E-HS9E03, E-HS904

Drive mode	Four-wheel drive
------------	------------------

Vehicle mass

- Model No.: E-HS9E01

Curb weight		2,505 kg
Maximum allowable total mass		3,130 kg
Full-load axle load	Front	1,271 kg
	Rear	1,859 kg

- Model No.: E-HS9E02

Curb weight		2,660 kg
Maximum allowable total mass		3,205 kg
Full-load axle load	Front	1,350 kg
	Rear	1,855 kg

- Model No.: E-HS9E03

Curb weight		2,630 kg
Maximum allowable total mass		3,180 kg
Full-load axle load	Front	1,288 kg
	Rear	1,892 kg

- Model No.: E-HS9E04

Curb weight		2,702 kg
Maximum allowable total mass		3,232 kg
Full-load axle load	Front	1,348 kg
	Rear	1,884 kg

Vehicle power performance

■ Model No.: E-HS9E01, E-HS9E02, E-HS9E03, E-HS9E04

Maximum gradient	45%
Maximum speed	200 km/h

Vehicle power performance

Model	CAM220PT2
Motor type	AC permanent magnet synchronous motor
Peak power	160 kW
Rated power	75 kW
Peak speed	15,000 rpm
Rated speed	5,093 rpm
Peak torque	300 N.m
Rated torque	120 N.m

Model	CAM250PT1
Motor type	AC permanent magnet synchronous motor
Peak power	245 kW
Rated power	80 kW
Peak speed	14,500 rpm
Rated speed	5,200 rpm
Peak torque	450 N.m
Rated torque	150 N.m

Power battery

■ Model No.: E-HS9E01

Model	CAB232EL3
Battery type	Ternary lithium ion battery
Nominal voltage	350 V
Net total energy	81.7 kWh
Weight	471 Kg
Cooling method	Liquid cooling
Operating temperature	-30°C~55°C

■ Model No.: E-HS9E02, E-HS9E03

Model	CAB232EL1
Battery type	Ternary lithium ion battery
Nominal voltage	410 V
Net total energy	95.3 kWh
Weight	553 Kg
Cooling method	Liquid cooling
Operating temperature	-30°C~55°C

■ Model No.: E-HS9E04

Model	CAB232EL1
Battery type	Ternary lithium ion battery
Nominal voltage	410 V
Net total energy	111,5 kWh
Weight	595 Kg
Cooling method	Liquid cooling
Operating temperature	-30°C~55°C

9-1. Specification

Front wheel alignment (no load)

- Model No.: E-HS9E01, E-HS9E02

Front wheel camber	$-6' \pm 25'$
Kingpin caster angle	$5^{\circ} 43' \pm 45'$
Kingpin inclination	$5^{\circ} 13' \pm 45'$
Front wheel toe-in	$\beta = 13' \pm 5'$

- Model No.: E-HS9E03, E-HS9E04

Front wheel camber	$-20' \pm 25'$
Kingpin caster angle	$6^{\circ} 6' \pm 45'$
Kingpin inclination	$5^{\circ} 22' \pm 45'$
Front wheel toe-in	$\beta = 7.5' \pm 5'$

Rear wheel alignment (no load)

- Model No.: E-HS9E01, E-HS9E02

Rear wheel camber	$-1^{\circ} 3' \pm 30'$ (within $\pm 30'$ difference between left and right wheels)
Rear wheel toe-in	$\beta = 8' \pm 5'$ $2\beta = 16' \pm 10'$

- Model No.: E-HS9E03

Rear wheel camber	$-1^{\circ} 3' \pm 30'$ (within $\pm 30'$ difference between left and right wheels)
Rear wheel toe-in	$\beta = 10' \pm 5'$ $2\beta = 20' \pm 10'$

Suspension

- Model No.: E-HS9E01, E-HS9E02

Front suspension	Type		Double wishbone independent suspension
	Spring type		Coil spring
	Damper type		Dual-cylinder hydraulic inflatable damper
	Stabilizer bar	Type	Hollow stabilizer bar
		Diameter	φ34×5.8mm
Rear suspension	Type		Trapezoid independent suspension
	Spring type		Coil spring
	Damper type		Dual-cylinder hydraulic inflatable damper
	Stabilizer bar	Type	Hollow stabilizer bar
		Diameter	φ28.5×5.2mm

- Model No.: E-HS9E03, E-HS9E04

Front suspension	Type		Double wishbone independent suspension
	Spring type		Air spring
	Damper type		Continuous damping control vibration damper
	Stabilizer bar	Type	Hollow stabilizer bar
		Diameter	φ34×5.8mm
Rear suspension	Type		Trapezoid independent suspension
	Spring type		Air spring
	Damper type		Continuous damping control vibration damper
	Stabilizer bar	Type	Hollow stabilizer bar
		Diameter	φ28.5×5.2mm

Vehicle identification

■ Manufacturer's nameplate

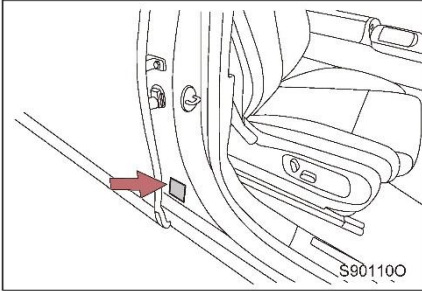

The manufacturer's nameplate is located on the right side B-pillar as shown in the figure.

The manufacturer's nameplate includes the following items: company name, WVTA number, VIN, fully loaded mass, combined mass (body with trailer), allowable axle load on the front axle, and allowable axle load on the rear axle.

■ Vehicle identification number

The Vehicle Identification Number (VIN) is the legal identification of a vehicle. It is the primary identification number of the vehicle and is used for owner registration.

▶ Top left of the instrument panel

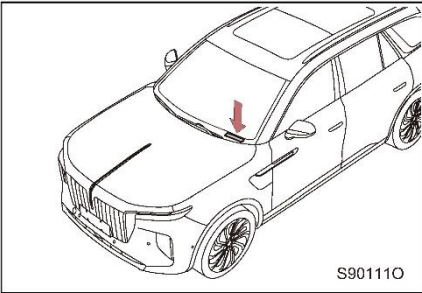

Paste under the front windshield at the top left of the instrument panel.

▶ Underneath the front passenger seat

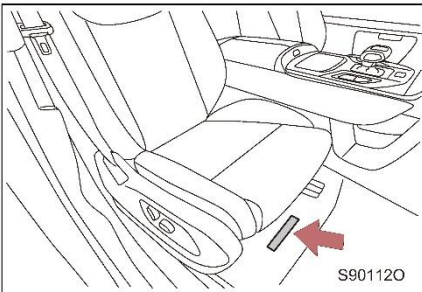

Embossed under the front passenger seat.

■ Motor No. (CAM220PT2)

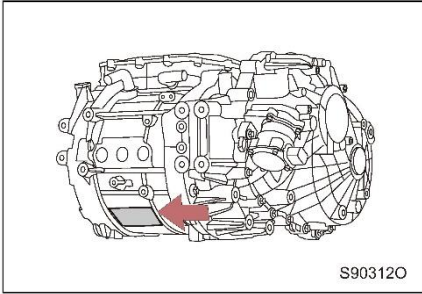

As shown in the figure, the motor No. and motor nameplate are located on the motor body.

■ Motor No. (CAM250PT1)

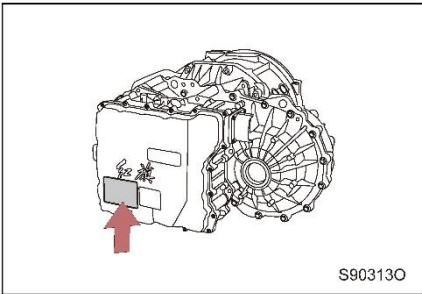

As shown in the figure, the motor No. and motor nameplate are located on the motor body.

■ Power battery No.

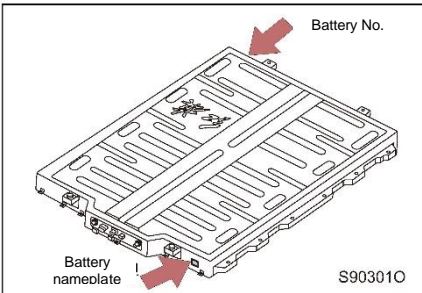

As shown in the figure, the battery No. and battery nameplate are located on the battery case body.

9-1. Specification

Microwave window

- Model No.: E-HS9E01, E-HS9E02, E-HS9E03

Recommended microwave window location
(The picture shows the view from inside the cab)

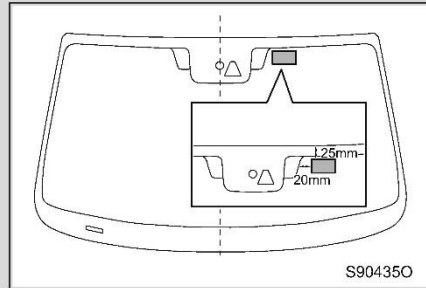

Cooling system

- Model No.: E-HS9E01

Coolant capacity of motor system	8 L
Coolant capacity of battery cooling system	10.5 L
Cooling liquid type	Automotive long-life coolant throughout the year (G30-91)

- Model No.: E-HS9E02, E-HS9E03

Coolant capacity of motor system	8 L
Coolant capacity of battery cooling system	12.5 L
Cooling liquid type	Automotive long-life coolant throughout the year (G30-91)

- Model No.: E-HS9E04

Coolant capacity of motor system	8 L
Coolant capacity of battery cooling system	14 L
Cooling liquid type	Automotive long-life coolant throughout the year (G30-91)

Reducer (front/rear)

- Model No.: E-HS9E01

Reducer oil capacity	0.64 ± 0.02 L (front/rear)
Reducer oil type	CASTROL BOT350 M3

- Model No.: E-HS9E02, E-HS9E03

Reducer oil capacity	0.64 ± 0.02 L (front) 1.4 ± 0.05 L (rear)
Reducer oil type	CASTROL BOT350 M3

Electrical system

- Model No.: E-HS9E01, E-HS9E02, E-HS9E03, E-HS9E04

12 V battery	45 Ah maintenance-free battery
--------------	--------------------------------

A/C refrigerant

A/C refrigerant capacity	1120±25 g
A/C refrigerant specification	R-1234yf

Brake

Free travel of brake pedal	≤ 10mm
Brake pedal travel	115mm
Brake fluid capacity	0.83 ± 0.01 L
Brake fluid type	DOT4

9-1. Specification

Reasonable application range of brake friction pair

► Front

Pad thickness	Standard thickness	Total thickness 17.8mm	Friction material thickness 12mm
	Minimum thickness	Total thickness 7.8mm	Friction material thickness 2mm
Brake disc thickness	Standard thickness	32mm	
	Minimum thickness	30mm	

► Rear

Pad thickness	Standard thickness	Total thickness 17.58mm	Friction material thickness 11mm
	Minimum thickness	Total thickness 8.2mm	Friction material thickness 2mm
Brake disc thickness	Standard thickness	24mm	
	Minimum thickness	22mm	



Notice

When the brake pad is worn to the minimum thickness, there will be an audible alarm to indicate that the brake pad needs to be replaced as soon as possible.

Tire and wheel

Tire specification	265/45 R21 108W XL 275/40 R22 107W XL			
Wheel size	21×9J 22×9.5J			
Tire pressure kPa (bar)		3 persons	ECO	Fully loaded
	Front	240(2.4)	280(2.8)	240(2.4)
	Rear	270(2.7)	280(2.8)	270(2.7)
Wheel bolt torque	(160±10)N.m			
Wheel balancing requirements	Residual unbalance: ≤ 8g			

Seat (when cushion is deep)

Front seat	Front-to-back position (forward from the limit position at the rear end of the slide)	253mm
	Backrest angle	25°
Second-row seat	Front-to-back position	150mm
	Backrest angle	25°
Third-row seat	Front-to-back position	Not adjustable
	Backrest angle	20°

Normal use state of the backrest: any position within the adjustable travel of the backrest design is the normal use state.

9-1. Specification

	Comfort	Premium	Exclusive	Exclusive+
Lengde (mm)	5209	5209	5209	5209
Bredde (mm)	2010	2010	2010	2010
Høyde (mm)	1731	1731	1713	1713
Egenvekt med fører (kg)	2580	2735	2705	2777
Maks total vekt kg	3130	3205	3180	3232
Bagasjevolum: 7/6 seter (mm)	580 x 1050 x 720	580 x 1050 x 720	580 x 1050 x 720	580 x 1050 x 720
Bagasjevolum: 5/4 seter (mm)	1240 x 1050 x 800	1240 x 1050 x 800	1240 x 1050 x 800	1240 x 1050 x 800
Bagasjevolum: 2 seter (mm)	2160 x 1050 x 800	2160 x 1050 x 800	-	-
Akselavstand (mm)	3110	3110	3110	3110
Luftdrag-koeffisient	0,345	0,345	0,345	0,345
Aksellerasjonstid 0-100 km/t (sek)	≤6.5	≤4,9	≤4,9	≤4,9
Batteripakken kWh (netto)	84 (81.7)	99 (95.3)	99 (95.3)	120 (111.5)
Motorkraft (kW)	160kW +160kW	160kW + 245kW	160kW + 245kW	160kW + 245kW
Motorkraft (hk)	435	551	551	551
Elektrisk rekkevidde opptil (WLTP)	396 km	465 km	465 km	515 km
Hurtiglading DC CCS2 opptil	140kW	140kW	140kW	130kW
Ombordlader	11kW	11kW	11kW	11kW
Innebygd diagnostikk OBD	•	•	•	•
Strømuttak via ladepistol	•	•	•	•
Oppv. av batteripakke	•	•	•	•
Takstativ (taklast kg)	75 kg	75 kg	75 kg	75 kg
Hengerfeste (tilhengervekt kg)	1500 kg	1500 kg	1500 kg	1500 kg

Other information



List of abbreviations 386

List of abbreviations
List of abbreviation

Abbreviations	Meaning
ABP	Automatic Brake Prefill
ABS	Antilock Brake System
ACC	Adaptive Cruise Control
ADB	Adaptive Driving Beam
ADS	Auto Defrost System
AEB	Autonomous Emergency Braking
APA	Auto Parking Assist
BSD	Blind Spot Detection
CDC	Continuous Damping Control
CDD-S	Controlled Deceleration for ACC-Stop & Go (ACC)
CDP	Controlled Deceleration for Parking Brake
EBD	Electronic Brakeforce Distribution
EDR	Event Data Recorder
ELR	Emergency Locking Retractor
EPB	Electrical Parking Brake
EPS	Electric Power Steering
ESC	Electronic Stability Control
ESS	Emergency Stop Signal
FCW	Forward Collision Warning
GPS	Global Positioning System

HBA	Hydraulic Brake Assist
HBB	Hydraulic Brake Boost
HCU	Hybrid Control Unit
HDC	Hill Descent Control
HHC	Hill Hold Control
LDW	Lane Departure Warning
LED	Light Emitting Diode
LKA	Lane Keeping Assist
MAX	Maximum
MIN	Minimize
OBD	On-Board Diagnostic
POI	Point Of Interest
PTC	Positive Temperature Coefficient
SACC	Super Adaptive Cruise Control
SOC	State Of Charge
TCS	Traction Control System
TPMS	Tire Pressure Manegment System
TSR	Traffic Sign Recognition
USB	Universal Serial Bus
VIN	Vehicle Identification Number

Charging station references

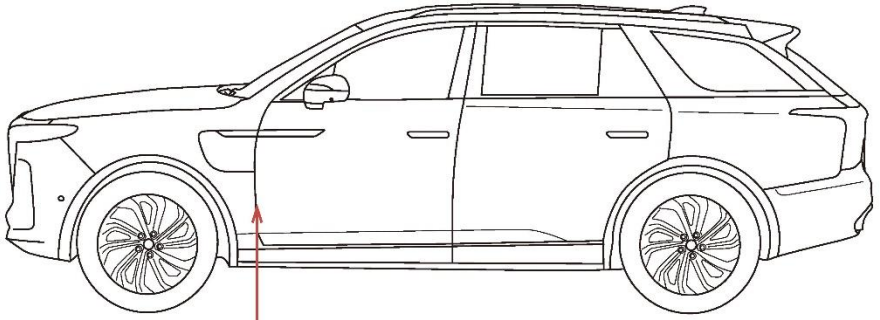

Hood opening handle

P.312

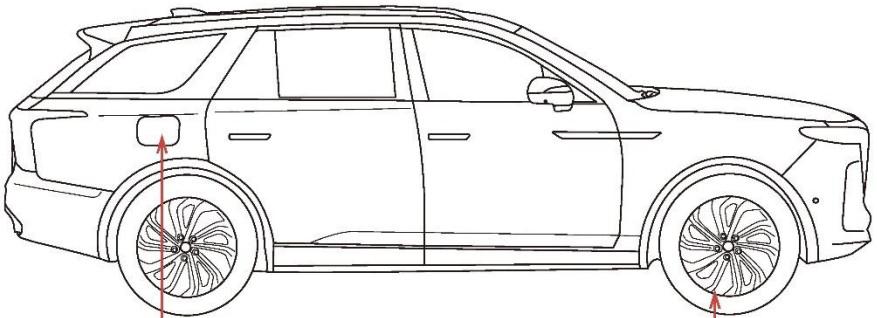



Charging port cover

P.152

Tire pressure

P.382

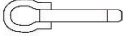
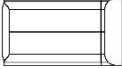
List of accompanying tools

Illustration	Name	Qty.
	Triangle warning sign	1
	Traction ring	1
	Reflective undershirt assembly	1
	Tire repair kit	1

Technical prerequisites

Trailer tractor must conform to relevant regulations.

Although your vehicle is mainly used to carry people and luggage, it can also be used to tow a trailer when equipped with relevant technical devices.

If your vehicle is equipped with a trailer tractor at delivery, all technical and legal requirements for driving with a trailer have been taken into account.

The vehicle has a connector for the electrical connection between the tractor and the trailer. Retrofitting a trailer tractor must be carried out in accordance with the manufacturer's instructions.

The maximum trailer weight is 1,500 kg.

If the loading weight exceeds 750 kg, the trailer shall be equipped with an independent braking system. The brake must be suitable for the trailer weight. Please follow the instructions provided by the trailer brake manufacturer to ensure the correct installation, commissioning and maintenance of the trailer brake.

The maximum vertical load is 60 kg.

The vertical load is the downward force exerted by the trailer weight on the ball head of the trailer tractor, which shall not be less than 4% of the trailer load. When the tractor is loaded with a certain weight of equipment, personnel or goods, the vertical load will be reduced, thereby weakening the maximum traction force.

When calculating the maximum traction force, it is assumed that the rated weight of the vehicle is not exceeded.



WARNING

Always ask professional enterprises to install the trailer tractor.

- **If there is no suitable cooling system, do not drive uphill for a long time, especially when the ambient temperature is high. Otherwise, the cooling system will overheat.**
- **Incorrect retrofitting may cause accidents!**

Operation guide

When driving with a trailer, you must pay attention to several matters.

■ Traction load

- In any case, it is not allowed to exceed the allowable traction load.
- The support load data on the trailer tractor nameplate is only the test value of the tractor. The actual value of each vehicle is often lower than the test value. For details, please contact the authorized FAW Hongqi dealer.

■ Leveling system *

The following applies to vehicles equipped with air suspension:

- Before the connection with trailer and the adjustment of support load of the trailer, the trailer mode must be set so that the vehicle is at normal height.

■ Load distribution

- After the trailer is connected, the load ratio of front axle shall not be less than 20% of the full load.
- Please try to put heavy objects near the axle when distributing the load on the trailer. Fix the object properly to prevent it from sliding. Improper loading may affect the driving pattern.
- The allowable vertical support load applied by the draw bar onto the ball head of the trailer tractor shall be utilized as far as possible, but it shall not be exceeded.

■ Tire pressure

Select the tire inflation pressure under "full load". See the tire pressure label for details. If necessary, correct the tire inflation pressure of the trailer according to the manufacturer's recommendations (when the trailer is fully loaded, the rear tire pressure needs to be increased to 290 kpa).

■ Exterior rearview mirror

If the standard rearview mirror is not sufficient to see the road conditions behind the trailer, an additional exterior rearview mirror must be installed. The two additional exterior rearview mirrors shall be fixed to the folding bracket. Please adjust these two mirrors so that you can see enough rear view.

■ Headlamp

- Please check the headlamp setting before driving with a trailer.
- If an automatic headlamp beam leveling system is installed, the light distance will be automatically adjusted according to the load condition of the vehicle.

-
- **For vehicles equipped with air suspension system, the mode of driving with trailer must be switched on before towing.**
 - **If you often drive with a trailer, we recommend that you shall carry out additional maintenance between the scheduled maintenances.**
 - **In the case of towing, the overload mass of the leading vehicle shall not exceed 100 kg, the vehicle speed shall not exceed 100 km/h, and the tire pressure on rear axle shall be 0.2 bar higher than the original.**

Driving guide

Take special care when driving with a trailer.

■ Weight distribution

Towing a loaded trailer with an unloaded vehicle is extremely detrimental to load distribution. However, if you have to drive in this combination, please drive with particularly low speed.

■ Vehicle speed

- The speed used to drive with a trailer must not exceed 80 km/h. If the leading and following vehicles meet specific technical prerequisites for towing, you can drive a maximum speed of 100 km/h. Please note the special provisions imposed by each country.
- The driving stability of the two vehicles decreases with the increase of vehicle speed. Therefore, when the road conditions, weather and wind speed are adverse, you should not drive at the maximum speed permitted by law, especially in downhill sections.
- If the trailer swings from side to side, even if it is small, you must reduce the speed immediately. Do not attempt to "straighten" the tractor and trailer by accelerating.
- Please brake in time! For trailers with inertia brakes, brake gently first, and then step down quickly and evenly. Thus, the braking impact caused by the locking of trailer wheels can be avoided. Before driving downhill, energy recovery can be used to exert the effect of brakes.
- Body sway can be reduced by additional stability assist device. When the traction load is large, it is recommended to install this kind of stability assist device. Such device can be purchased from and installed by professional enterprises.

■ Overheating

Please pay attention to the coolant temperature when the outside temperature is high. If a high coolant temperature alarm is found or a decrease in power is felt, please reduce the speed immediately.



HONGQI



hongqi.no