



FP045 | RELIC | TOKEN

DIRECT

TABLE OF
CONTENTS

DIRECT

COVER PAGE

SKU/Pattern/Color

DISPLAYS

FloorEver™ PetPlus	5
Phenix Microban® Lowboy	9
Coupon Policy	12

CARPET

New Product Introductions	13
2025 Carpet Product Guide	14
Fiber Descriptions	17

FLOOREVER™ PETPLUS

FloorEver™ PetPlus	18
SureSoftSDN™ Cationic Nylon	19
FloorEver™ PetPlus Nylon Introductions	20

MICROBAN®

Microban® Brand	22
Microban® Polyester Introductions	23

NO DYE LOT

No Dye Lot Information	24
------------------------------	----

MARKETING

Virtual Decorator	25
Social Media	26
Mannington Connect	27
Phenix Rewards	29

2025 NATIONAL ACCOUNTS / BUYING GROUPS

Overview	30
One Phenix Program Benefits	32
One Phenix Program Sign Up	37
Abbey Carpets & Floors To Go Displays	44
CarpetsPlus Displays	50
FCA Displays	60
Floors and More Display	62
NFA Display	63
Carpet One Room by Room	64
Flooring America	83

PHENIX

TABLE OF
CONTENTS

2025 NATIONAL ACCOUNTS / BUYING GROUPS CONT.

Buying Group Crossover Lists101
2023/2024 Drops110
Sample Order Info.....111
Order and Delivery Guidelines116

CONTACT INFO

Contacts118

FORMS

Custom Sample Order Form121

DISPLAYS

2025



FloorEver™PetPlus



Phenix Microban® Polyester Lowboy

PHENIX

FLOOREVER™
PETPLUS

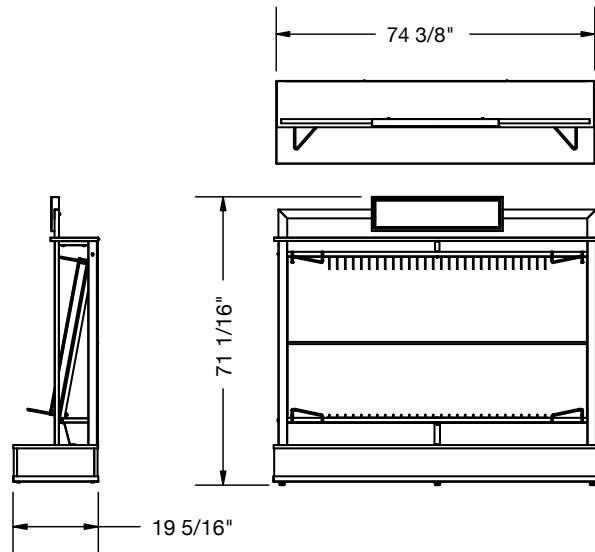

DIMENSIONS
DEPTH 19 5/16"
WIDTH 74 3/8"
HEIGHT 71 1/16"

Option 1 **\$799** includes display with 16 \$50 coupons

SAP: 532288

Option 2 **\$499** includes wing cards only, no display graphics, with 10 \$50 coupons

SAP: 531351

Update Kit **\$199** FEPP includes 5 wing cards with 3 \$50 coupons

FP038 Grande Vista

FP039 Karma Gold/FP040 Karma Silver

FP041 Signature Platinum/FP042 Signature Gold/FP043 Signature Silver

FP044 Seaside

FP045 Relic

SAP: 569226

PHENIX

FLOOREVER™

PETPLUS



	PIN	STYLE NAME	
L E F T	1	FP007/FP008	Balboa/Lido
	2	FP039/FP040	Karma Gold/Karma Silver
	3	FP009/FP010	Portofino/Sorrento
	4	FP011/FP012	Luna/Milo
	5	FP015/FP016	Crystal Cove/Seaview
	6	FP017	Paxton
	7	FP001/FP002	Hydra/Rhodes
	8	FP021/FP022	Bougie/Luxe
	9	FP018/FP019/FP020	Bari/Catania/Palermo
	10	FP035/FP036	Vista Gold/Vista Silver
	11	FP038	Grande Vista
	12	FP041/FP042/FP043	Signature Platinum/Signature Gold/Signature Silver
13	CENTER GRAPHIC		
14			
15			
16			
R I G H T	17	FP045	Relic
	18	FP044	Seaside
	19	FP028	Aviara
	20	FP026	Del Mar
	21	FP027	Big Sur
	22	FP024	Mykonos
	23	FP037	Madras
	24	FP029	Verona
	25	FP033	Impression
	26	FP030	All Inclusive
	27	FP031	In The Details
	28	FP034	Cardigan

PHENIX

ADDITIONAL SAMPLE ORDER INFO

FLOOREVER™ PETPLUS	SELLING NUMBER	STYLE	WING CARD	DECK BOARD	HANDLE CARD	27X18	13X18	KITS	6X6	12X12
	FP001/FP002	Hydra/Rhodes	X	X		X			X	
	FP003/FP004	Crete/Sparta	X	X		X			X	
	FP005/FP006	Emerson/Mateo	X	X		X			X	
	FP007/FP008	Balboa/Lido	X	X		X			X	
	FP009/FP010	Portofino/Sorrento	X	X		X			X	
	FP011/FP012	Luna/Milo	X	X		X			X	
	FP013/FP014	Capri/Naples	X	X		X			X	
	FP015/FP016	Crystal Cove/Seaview	X	X		X			X	
	FP017	Paxton	X	X		X			X	
	FP018/FP019/FP020	Bari/Catania/Palermo	X	X		X			X	
	FP021/FP022	Bougie/Luxe	X	X		X			X	
	FP024	Mykonos	X	X		X			X	
	FP025	Maxwell	X	X		X			X	
	FP026	Del Mar	X	X		X			X	
	FP027	Big Sur	X	X		X			X	
	FP028	Aviara	X	X		X			X	
	FP029	Verona	X	X		X			X	
	FP030	All Inclusive	X	X		X			X	
	FP031	In The Details	X	X		X			X	
	FP032	Debut	X	X		X			X	
	FP033	Impression	X	X		X			X	
	FP034	Cardigan	X	X		X			X	
	FP035/FP036	Vista Gold/Silver	X	X		X			X	
FP037	Madras	X	X		X			X		
FP038	Grande Vista	X	X		X			X		
FP039/FP040	Karma Gold/Karma Silver	X	X		X			X		
FP041/FP042/FP043	Signature Platinum/Gold/Silver	X	X		X			X		
FP044	Seaside	X	X		X				X	
FP045	Relic	X	X		X				X	

Wing Cards 24x36
 Deck Boards 17x32
 Handle Cards 17x27

NYLON CROSSOVER LIST

PHENIX

FLOOREVER PET PLUS	FLOOREVER	FLOORSURE
FPO01 HYDRA	N/A	NS131 APHRODITE
FPO02 RHODES	FE103 ACCOLADES	NS130 VENUS
FPO03 CRETE	FE104 TRIBUTE	NS129 MYSTICAL
FPO04 SPARTA	N/A	NS128 WONDERLAND
FPO05 EMERSON	N/A	NS120 EDEN
FPO06 MATEO	N/A	NS119 ELYSIAN
FPO07 BALBOA	FE101 BRAVO	NS140 MINERVA
FPO08 LIDO	FE102 OVATION	NS139 MUSE
FPO09 PORTOFINO	N/A	NS118 ATHENA II
FPO10 SORRENTO	N/A	NS117 ZEUS II
FPO11 LUNA	FE111 SUCCEED	NS138 DREAM WORLD
FPO12 MILO	FE112 SURPASS	NS137 UTOPIA
FPO13 CAPRI	FE113 ACHIEVE	NS136 AVALON
FPO14 NAPLES	FE114 ATTAIN	NS135 SHANGRI-LA
FPO15 CRYSTAL COVE	FE109 INTELLECT	NS142 ATLANTIS
FPO16 SEAVIEW	FE105 INSIGHT	NS141 POSEIDEN
FPO17 PAXTON	FE106 EPIPHANY	NS143 DELPHI
FPO18 BARI	N/A	NS127 BALLAD
FPO19 CATANIA	N/A	NS126 FABLE
FPO20 PALERMO	N/A	NS125 SAGA
FPO21 BOUGIE	N/A	NS134 CAPRICORN
FPO22 LUXE	N/A	NS133 COSMIC
FPO24 MYKONOS	N/A	NS124 ODYSSEY
FPO25 MAXWELL	N/A	NS123 DYNASTY
FPO26 DEL MAR	FE110 YEARN	NS145 XANADU
FPO27 BIG SUR	FE116 ASPIRE	NS146 OLYMPUS
FPO28 AVIARA	FE115 CONJURE	NS144 VALHALLA
FPO29 VERONA	N/A	NS121 ARCADIA
FPO30 ALL INCLUSIVE	FE108 DESIRE	NS147 FOLKLORE
FPO31 IN THE DETAILS	FE107 CRAVE	NS148 LEGENDARY
FPO32 DEBUT	N/A	NS122 UNIVERSE
FPO35 VISTA GOLD	N/A	NS152 PANORAMA II
FPO36 VISTA SILVER	N/A	NS151 PANORAMA I
FPO37 MADRAS	N/A	NS153 VALENCIA
FPO38 GRANDE VISTA	N/A	
FPO39 KARMA GOLD	N/A	
FPO40 KARMA SILVER	N/A	
FPO41 SIGNATURE PLATINUM	N/A	
FPO42 SIGNATURE GOLD	N/A	
FPO43 SIGNATURE SILVER	N/A	
FPO44 SEASIDE	N/A	
FPO45 RELIC	N/A	

MICROBAN®
LOWBOY

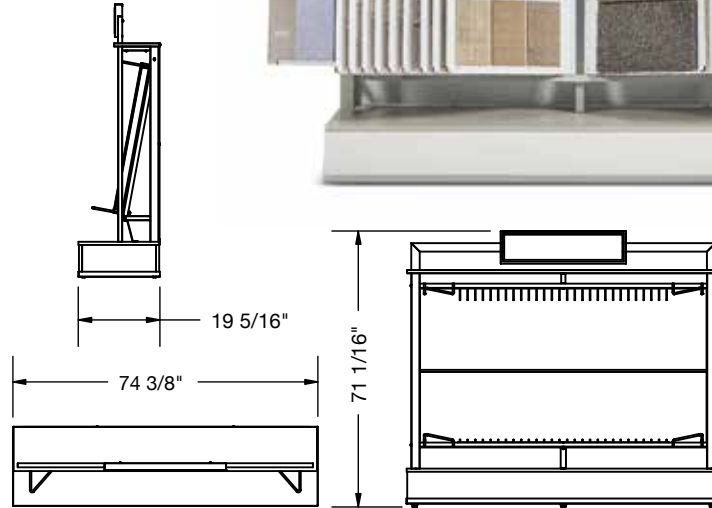

DIMENSIONS
DEPTH 19 5/16"
WIDTH 74 3/8"
HEIGHT 71 1/16"

Option 1 **\$799** includes display with 16 \$50 coupons
SAP: 531364

Option 2 **\$499** includes wing cards only, no display graphics, with 10 \$50 coupons
SAP: 531363

Update Kit **\$99** includes 2 wing cards with 2 \$50 coupon
MB155 Current Platinum/MB156 Current Gold/MB157 Current Silver
MB158 Escape Gold/MB159 Escape Silver
SAP: 569222

PHENIX

MICROBAN[®] LOWBOY



PHENIX Microban[®] Lowboy

	PIN	STYLE NAME	
L E F T	1	N175/N176	Aurora/Solstice
	2	MB134/MB135	Foundation I/Foundation II
	3	MB139	Dolce
	4	N233/N234	First Light/Day Break
	5	MB111/MB112	Tempt/Entice
	6	MB145/MB146	Radiant Gold/Radiant Silver
	7	MB132/MB133	Canvas I/Canvas II
	8	MB130	Tweed
	9	MB147/MB148/MB149	Oasis Platinum/Oasis Gold/Oasis Silver
	10	MB153/MB154	Illusion Gold/Illusion Silver
	11	MB158/MB159	Escape Gold/Escape Silver
	12	MB155/MB156/MB157	Current Platinum/Current Gold/Current Silver
	13	MB124/MB125/MB126	Heavenly/Ethereal/Magical
	14	MB136/MB137/MB138	Mirage I/Mirage II/Mirage III
	15	MB127/MB128	Cashmere/Merino
R I G H T	16	MB152	Cabana
	17	MB143/MB144	Colonnade/Courtyard
	18	MB142	Boucle
	19	MB129	Glam
	20	N243	Etched
	21	MB140	Allure
	22	MB118	Memento
	23	MB121	Medley
	24	MB141	Reflection
	25	MB150/MB151	Mesh/Aura
	26	MB122/ MB123	Amarillo/El Dorado
	27	MB100	Bodega Bay
	28	MB119/MB120	Top Notch/Five Star

PHENIX

ADDITIONAL SAMPLE ORDER INFO

	Selling Number	Style	Wing Card	Deck Board	Handle Card	27x18	13x18	Kits	6x6	
	MICROBAN® LOWBOY	MB100	Bodega Bay	X	X					X
N175/N176		Aurora/Solstice	X		X				X	
MB127/MB128		Cashmere/Merino	X	X		X		X	X	
MB115/MB116/MB117		Ryman/Tabernacle/Lincoln Hall	X	X				X	X	
MB121		Medley	X	X		X			X	
N243		Etched	X	X		X			X	
N233/N234		First Light/Day Break	X		X				X	
MB119/MB120		Five Star/Top Notch	X	X					X	
MB118		Memento	X	X		X			X	
MB122/MB123		Amarillo/El Dorado	X		X				X	
MB111/MB112		Tempt/Entice	X		X	X		X	X	
N259/N260/N261		Front Runner/Medal Winner/Grand Champion	X	X					X	X
MB124/MB125/MB126		Heavenly/Ethereal/Magical	X	X		X		X	X	
MB129		Glam	X	X		X			X	
MB130		Tweed	X	X		X	X		X	
MB132/MB133		Canvas I/Canvas II	X	X		X			X	
MB134/MB135		Foundation I/Foundation II	X	X		X			X	
MB142		Boucle	X	X		X			X	
MB140		Allure	X	X		X			X	
MB141		Reflection	X	X		X			X	
MB136/MB137/MB138		Mirage I/Mirage II/Mirage III	X	X		X			X	
MB139		Dolce	X	X		X			X	
MB143/MB144		Colonnade/Courtyard	X	X		X			X	
MB145/MB146		Radiant Gold/Radiant Silver	X	X		X			X	
MB147/MB148/MB149		Oasis Platinum/Oasis Gold/Oasis Silver	X	X		X			X	
MB150/MB151		Mesh/Aura	X	X		X			X	
MB152		Cabana	X	X		X			X	
MB153/MB154		Illusion Gold/Illusion Silver	X	X		X			X	
MB155/MB156/MB157		Current Platinum/Gold/Silver	X	X		X			X	
MB158/MB159		Escape Gold/Escape Silver	X	X		X			X	

Wing Cards 24x36

Deck Boards 17x32

Handle Cards 17x27

COUPON POLICY

Coupons are available for select sample displays and packages if purchased at the full price on the order form.* These coupons are valued at \$50 each and are activated when the sample invoice for which the selected display/sample package has been paid. Once the coupons are activated, they are available to use at your discretion.

Please note that coupons expire 12 months from the date of invoice (not when the invoice is paid).*



























Coupons can be applied by referencing the coupon number on a payment remittance or within email correspondence with the Credit department.

If you are unsure of the coupons available, please email Calhoun.credit@mannington.com and a Credit Analyst will send a listing.

*Coupons are issued only if the amount paid is the full amount of the display and/or package. No coupons are issued/activated on discounted displays/packages.

To submit a credit application, please go to <https://manningtoncommercial.force.com/AccountManagement/s/>

2025 INTRODUCTIONS

Selling Style #	Style	Oz	Fiber	Display	Antimicrobial Treatment
FP038	Grande Vista	63	SureSoftSDN™	FloorEver PetPlus 	MICROBAN® 
FP039	Karma Gold	58	SureSoftSDN™	FloorEver PetPlus 	MICROBAN® 
FP040	Karma Silver	46	SureSoftSDN™	FloorEver PetPlus 	MICROBAN® 
FP041	Signature Platinum	73	SureSoftSDN™	FloorEver PetPlus 	MICROBAN® 
FP042	Signature Gold	62	SureSoftSDN™	FloorEver PetPlus 	MICROBAN® 
FP043	Signature Silver	50	SureSoftSDN™	FloorEver PetPlus 	MICROBAN® 
FP044	Seaside	47	SureSoftSDN™	FloorEver PetPlus 	MICROBAN® 
FP045	Relic	47	SureSoftSDN™	FloorEver PetPlus 	MICROBAN® 
MB155	Current Platinum	64	SureSoftSD™	MICROBAN®  LOWBOY	MICROBAN® 
MB156	Current Gold	54	SureSoftSD™	MICROBAN®  LOWBOY	MICROBAN® 
MB157	Current Silver	44	SureSoftSD™	MICROBAN®  LOWBOY	MICROBAN® 
MB158	Escape Gold	65	SureSoftSD™	MICROBAN®  LOWBOY	MICROBAN® 
MB159	Escape Silver	50	SureSoftSD™	MICROBAN®  LOWBOY	MICROBAN® 

2025 CARPET PRODUCT GUIDE

STYLE	Oz	COLLECTION
FE101 Bravo	48	FloorEver™ PetPlus
FE102 Ovation	35	FloorEver™ PetPlus
FE103 Accolades	49	FloorEver™ PetPlus
FE104 Tribute	39	FloorEver™ PetPlus
FE105 Insight	40	FloorEver™ PetPlus
FE106 Epiphany	60	FloorEver™ PetPlus
FE107 Crave	34	FloorEver™ PetPlus
FE108 Desire	34	FloorEver™ PetPlus
FE109 Intellect	55	FloorEver™ PetPlus
FE110 Yearn	48	FloorEver™ PetPlus
FE111 Succeed	54	FloorEver™ PetPlus
FE112 Surpass	42	FloorEver™ PetPlus
FE113 Achieve	54	FloorEver™ PetPlus
FE114 Attain	42	FloorEver™ PetPlus
FE115 Conjure	45	FloorEver™ PetPlus
FE116 Aspire	45	FloorEver™ PetPlus
FP001 Hydra	64	FloorEver™ PetPlus
FP002 Rhodes	49	FloorEver™ PetPlus
FP003 Crete	39	FloorEver™ PetPlus
FP004 Sparta	29	FloorEver™ PetPlus
FP005 Emerson	75	FloorEver™ PetPlus
FP006 Mateo	60	FloorEver™ PetPlus
FP007 Balboa	48	FloorEver™ PetPlus
FP008 Lido	35	FloorEver™ PetPlus
FP009 Portofino	50	FloorEver™ PetPlus
FP010 Sorrento	42	FloorEver™ PetPlus
FP011 Luna	54	FloorEver™ PetPlus
FP012 Milo	42	FloorEver™ PetPlus
FP013 Capri	54	FloorEver™ PetPlus
FP014 Naples	42	FloorEver™ PetPlus
FP015 Crystal Cove	55	FloorEver™ PetPlus
FP016 Seaview	40	FloorEver™ PetPlus
FP017 Paxton	60	FloorEver™ PetPlus
FP018 Bari	66	FloorEver™ PetPlus
FP019 Catania	55	FloorEver™ PetPlus
FP020 Palermo	44	FloorEver™ PetPlus
FP021 Bougie	70	FloorEver™ PetPlus
FP022 Luxe	50	FloorEver™ PetPlus
FP024 Mykonos	53	FloorEver™ PetPlus
FP025 Maxwell	45	FloorEver™ PetPlus
FP026 Del Mar	48	FloorEver™ PetPlus
FP027 Big Sur	45	FloorEver™ PetPlus
FP028 Aviara	45	FloorEver™ PetPlus
FP029 Verona	50	FloorEver™ PetPlus
FP030 All Inclusive	34	FloorEver™ PetPlus
FP031 In The Details	34	FloorEver™ PetPlus

PHENIX

2025 CARPET PRODUCT GUIDE CONT.

STYLE	Oz	COLLECTION
FP032 Debut	30	FloorEver™ PetPlus
FP033 Impression	36	FloorEver™ PetPlus
FP034 Cardigan	34	FloorEver™ PetPlus
FP035 Vista Gold	51	FloorEver™ PetPlus
FP036 Vista Silver	41	FloorEver™ PetPlus
FP037 Madras	45	FloorEver™ PetPlus
FP038 Grande Vista	63	FloorEver™ PetPlus
FP039 Karma Gold	58	FloorEver™ PetPlus
FP040 Karma Silver	46	FloorEver™ PetPlus
FP041 Signature Platinum	73	FloorEver™ PetPlus
FP042 Signature Gold	62	FloorEver™ PetPlus
FP043 Signature Silver	50	FloorEver™ PetPlus
FP044 Seaside	47	FloorEver™ PetPlus
FP045 Relic	47	FloorEver™ PetPlus
FE502 Idyllic	59	Microban® Polyester
FE503 Ebullient	43	Microban® Polyester
FE505 Whimsical	64	Microban® Polyester
FE506 Eccentric	54	Microban® Polyester
FE507 Visionary	44	Microban® Polyester
MB100 Bodega Bay	34	Microban® Polyester
MB110 Divine	38	Microban® Polyester
MB111 Tempt	42	Microban® Polyester
MB112 Entice	30	Microban® Polyester
MB115 Ryman	70	Microban® Polyester
MB116 Tabernacle	55	Microban® Polyester
MB117 Lincoln Hall	42	Microban® Polyester
MB118 Memento	25	Microban® Polyester
MB119 Five Star	65	Microban® Polyester
MB120 Top Notch	50	Microban® Polyester
MB121 Medley	25	Microban® Polyester
MB122 Amarillo	38	Microban® Polyester
MB123 El Dorado	28	Microban® Polyester
MB124 Heavenly	68	Microban® Polyester
MB125 Ethereal	53	Microban® Polyester
MB126 Magical	38	Microban® Polyester
MB127 Cashmere	75	Microban® Polyester
MB128 Merino	60	Microban® Polyester
MB129 Glam	36	Microban® Polyester
MB130 Tweed	50	Microban® Polyester
MB132 Canvas I	58	Microban® Polyester
MB133 Canvas II	45	Microban® Polyester
MB134 Foundation I	39	Microban® Polyester
MB135 Foundation II	29	Microban® Polyester
MB136 Mirage I	77	Microban® Polyester
MB137 Mirage II	60	Microban® Polyester

2025 CARPET PRODUCT GUIDE CONT.

STYLE	Oz	COLLECTION
MB138 Mirage III	45	Microban® Polyester
MB139 Dolce	38	Microban® Polyester
MB140 Allure	39	Microban® Polyester
MB141 Reflection	25	Microban® Polyester
MB142 Bouclé	36	Microban® Polyester
MB143 Colonnade	46	Microban® Polyester
MB144 Courtyard	40	Microban® Polyester
MB145 Radiant Gold	50	Microban® Polyester
MB146 Radiant Silver	35	Microban® Polyester
MB147 Oasis Platinum	60	Microban® Polyester
MB148 Oasis Gold	50	Microban® Polyester
MB149 Oasis Silver	40	Microban® Polyester
MB150 Mesh	25	Microban® Polyester
MB151 Aura	35	Microban® Polyester
MB152 Cabana	50	Microban® Polyester
MB153 Illusion Gold	55	Microban® Polyester
MB154 Illusion Silver	40	Microban® Polyester
MB155 Current Platinum	64	Microban® Polyester
MB156 Current Gold	54	Microban® Polyester
MB157 Current Silver	44	Microban® Polyester
MB158 Escape Gold	65	Microban® Polyester
MB159 Escape Silver	50	Microban® Polyester
N175 Aurora	29	Microban® Polyester
N176 Solstice	39	Microban® Polyester
N219 Paradox	77	Microban® Polyester
N230 Paragon	45	Microban® Polyester
N231 Paradigm	60	Microban® Polyester
N233 First Light	32	Microban® Polyester
N234 Day Break	42	Microban® Polyester
N243 Etched	35	Microban® Polyester
N259 Front Runner	35	Microban® Polyester
N260 Medal Winner	43	Microban® Polyester
N261 Grand Champion	59	Microban® Polyester
N271 Refined	25	Microban® Polyester
N273 Appealing	25	Microban® Polyester
N278 Polaris	25	Microban® Polyester
PH007	68	100% SureSoftSD™ Solution Dyed Polyester with Microban®
PH016	50	100% SureSoftSD™ Solution Dyed Polyester with Microban®
PH018	78	100% SureSoftSD™ Solution Dyed Polyester with Microban®
PH025	60	100% SureSoftSD™ Solution Dyed Polyester with Microban®
PH026	49	100% SureSoftSD™ Solution Dyed Polyester with Microban®
PH027	58	100% SureSoftSD™ Solution Dyed Polyester with Microban®
PH028	20	100% SureSoftSD™ Solution Dyed Polyester
PH029	35	100% SureSoftSD™ Solution Dyed Polyester with Microban®
PH030	48	100% SureSoftSD™ Solution Dyed Polyester with Microban®
PH031	35	100% SureSoftSD™ Solution Dyed Polyester with Microban®

New products highlighted yellow.

SureSoftSDN™

SOLUTION DYED NYLON

Commercial grade stain protection in a residential carpet. Our SureSoftSDN™ cationic nylon fibers repel acid-based stains. No worries about spills like wine, spaghetti sauce or pet stains.

Color through the entire fiber, not just on the surface. Our SureSoftSDN™ fibers are Solution Dyed, meaning they have the dye all the way through the fiber, like a carrot. Which means no fading and after years of wear from cleaning and wear & tear, the color of the carpet will still shine through.

Warranted for Stairs – How many carpets can you name that are warranted for stairs? We stand by our durability and performance of our SureSoftSDN™ fibers so much, this carpet is warranted for the stairs.

SureSoftSD™

SOLUTION DYED POLYESTER

Get lost in the feeling of SureSoftSD™ carpet fibers. Excellent stain and soil resistance make it easy to clean and maintain, so relax and enjoy the comfort of your carpet without worries about spills or pet messes. Fade resistance ensures this carpet won't fade in the sun. Rest assured your new carpet will meet all your household needs.

Phenix SureSoft™ Solution Dyed Fibers

The color is all the way through the fiber, like a carrot.



The color of non solution dyed fibers is only on the surface like a radish, making the carpet dull over time due to wear.











The benefit of having the color all the way through the fiber is the color of the carpet lasts longer. It resists stains, fading, and wear and tear. Surface dyed fibers become dull over time because the color is worn away.

Built to withstand the “uh-ohs” that come with furry family members, 24/7, with enhanced pet performance and exceptional warranties for stain and spill protection, as well as product durability.



Microban® Surface Protection

							
Enhanced Pet Protection	Stain + Spill Protection	Durability Guaranteed	Kid Friendly	100 Day Satisfaction	Warranted for Stairs		Helping to Keep Your Floors Cleaner
							24/7 SURFACE PROTECTION 99% CLEANER

MICROBAN®

Your Phenix carpet helps protect 24/7 against the growth of bacteria, mold and mildew, and remain 99% cleaner than untreated surfaces. Learn more at Floors.com/Microban

SureSoftSDN™ Solution Dyed Nylon

Commercial-grade stain performance in a residential carpet. Livable luxury is the best way to describe SureSoftSDN™ carpet fibers. This state of the art fiber provides inherent stain, soil, and fade resistance while maintaining superior protection for your home. Bring on the kids and pets, this durable nylon fiber will bounce back time and time again to ensure your carpet looks newer longer.



Asthma & Allergy Friendly*

Phenix Flooring carpets help you breathe easier by reducing airborne allergens.

* See the Carpet and Rug Institute's "Asthma and Allergy" fact sheet at carpet-rug.org

WARRANTIES

- Lifetime Limited Stain Resistance (Includes Resistance to pet urine, vomit and feces stains)
- Lifetime Limited Soil Resistance
- Lifetime Limited Anti-Static
- Lifetime Limited Fade Resistance
- Lifetime Limited Manufacturing Defects
- 25 Year Limited Texture Retention
- 25 Year Limited Abrasive Wear
- 100 Days Customer Satisfaction

**Regular professional cleaning required to keep warranty valid. For more information visit PhenixFlooring.com/FEPPwarranty.





| Our Difference is in the Details



1 Commercial-grade stain protection in a residential carpet OurSuresoftSDN™ cationic nylon fibers repel acid-based stains. No worries about spills like wine, spaghetti sauce or pet stains.



2 Colorthrough the entire fiber, not just on the surface. Our SureSoftSDN™ fibers are Solution Dyed, meaning they have the dye all the way through the fiber, like a carrot. Which means no fading and after years of wear from cleaning and wear and tear, the color of the carpet will still shine through.



3 Microban® Surface Protection Helping to protect 24/7 against the growth of bacteria, mold and mildew, and remain 99% cleaner than untreated surfaces.



4 Warranted for Stairs How many carpets can you name that are warranted for stairs? We stand by our durability and performance of our SureSoftSDN™ fibers so much, this carpet is warranted for the stairs.

SureSoftSDN™
Cationic Solution Dyed Nylon

NEW 2025 INTRODUCTIONS

FloorEver™ PetPlus

with
SureSoftSDN™ **MICROBAN**
Antimicrobial Technology

GRANDE VISTA

Discover the beauty of the world's most captivating landscapes with Grande Vista. This updated version of the beloved Vista style boasts a broader color palette and a more substantial texture. From the warm, sunlit sands of tropical shores to the earthy tones of mountain ranges, and the serene greens of lakes and fields, Grande Vista offers a rich array of hues that effortlessly enhance both contemporary and classic interiors. Its upgraded construction provides a plush, comfortable feel underfoot, making it a perfect choice for any space.



GRANDE VISTA



SEASIDE

SEASIDE

Inspired by the tranquil allure of the coast, Seaside brings the essence of the beach into your home. It beautifully captures the texture of sandy shores, the rhythm of crashing waves, and the rugged charm of coastal cliffs. Its undulating loop pattern, intricately carved into a plush cut pile, creates a dynamic visual texture, while the subtle color palette ensures a sophisticated and usable style. For a truly refined coastal look, pair Seaside with Grande Vista to achieve a harmonious and layered aesthetic that elevates any interior with coastal elegance.



KARMA

KARMA

Create a sanctuary of equilibrium and tranquility with Karma. This dense, all-cut carpet, with its relaxed, cozy texture, is destined to compliment any interior. Available in 20 neutral colorways with multi-tonal yarns, Karma provides a grounded foundation that helps you send out good vibes that come back around, enriching your space with a harmonious and restorative ambiance.

NEW 2025 INTRODUCTIONS

FloorEver™ PetPlus

SureSoftSDN™ with **MICROBAN** Antimicrobial Technology



SIGNATURE

SIGNATURE

Make a bold statement with Signature, where classic elegance merges with modern design. This refined cut-pile carpet is meticulously crafted to transform your space into a serene haven, blending sophistication with modern flair. The Signature collection showcases subtle tonal variations in each colorway, providing a polished and versatile base for any interior. Whether you're designing a tranquil living room, a stylish office, or a cozy bedroom, Signature's luxurious texture and understated charm create a fresh and inviting atmosphere. Elevate your home with the perfect balance of comfort and style—choose Signature for a look that is both distinguished and welcoming.

RELIC

Transform your space with the timeless sophistication of Relic. Crafted to add warmth and a touch of lived-in charm, Relic effortlessly turns any room into a cozy sanctuary. Its unique medallion motif, enhanced with patinaed texturing, creates captivating visual interest, while the nine soft, classic color options ensure seamless coordination with any decor. Relic pairs beautifully with Signature collection, merging classic appeal with modern comfort for a refined aesthetic.

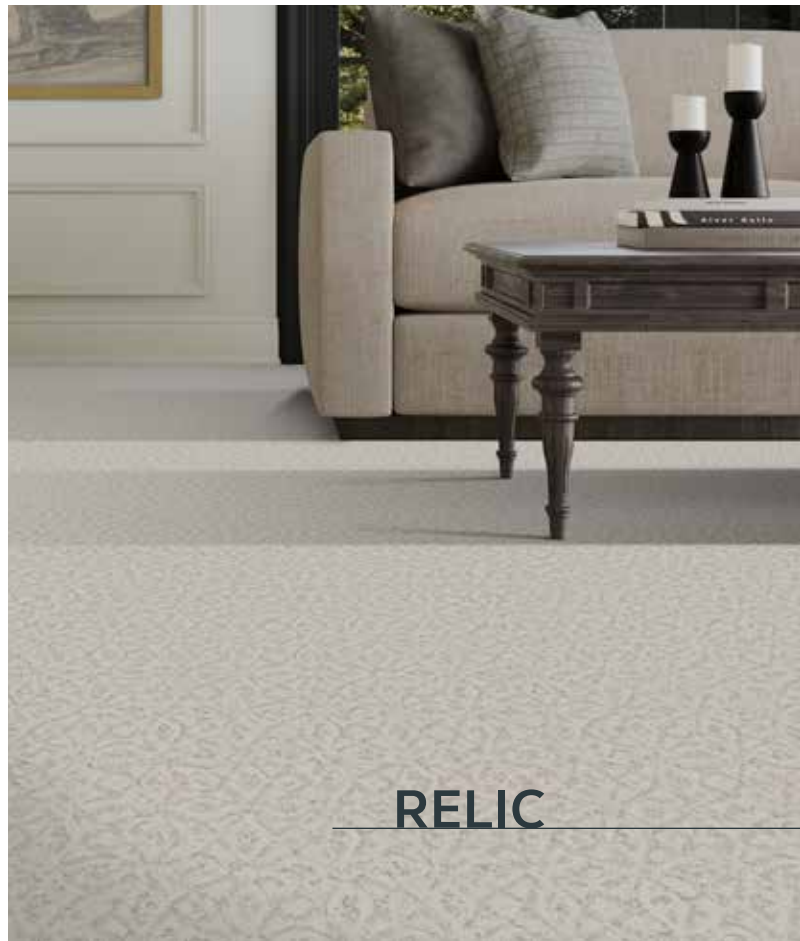

RELIC



THE ONLY RESIDENTIAL CARPET WITH MICROBAN® PROTECTION

Phenix Flooring is proud to be the exclusive provider of polyester and nylon carpet products with built-in Microban® antimicrobial product protection.

ADDED MICROBAN PROTECTION MEANS YOU CAN WORRY LESS AND LIVE MORE.



Surfaces treated with Microban technology remain 99% cleaner from the growth of bacteria and odors than untreated surfaces.



Microban technology protects 24/7 against the growth of bacteria, mold and mildew that can cause stains, odors and product deterioration.

PHENIXFLOORING.COM



©2020 All Rights Reserved. Microban is a registered trademark of Microban Products Company.



ESCAPE

ESCAPE

Transform your space into a serene retreat with Escape. This refined cut-pile carpet features a contemporary flair, effortlessly blending elegance with modern design. The subtle tonal variations in each colorway provide a sophisticated and polished foundation, ideal for crafting a fresh and inviting interior. Whether you're designing a tranquil living room, a stylish office, or a cozy bedroom, the Escape carpet's luxurious texture and understated charm offer a versatile backdrop that enhances any setting.

CURRENT

Discover the serene elegance of Current. Inspired by the gentle flow of water, Current introduces a calming and refreshing ambiance to your space, echoing the tranquility of a serene rippling stream. With 20 nature-inspired, multi-tonal colorways, each shade captures the subtle shimmer and depth of water's surface. These hues create a rich, dynamic foundation that effortlessly enhances any decor style. Transform your home with Current, where every step embodies the tranquil beauty of nature's gentle currents.

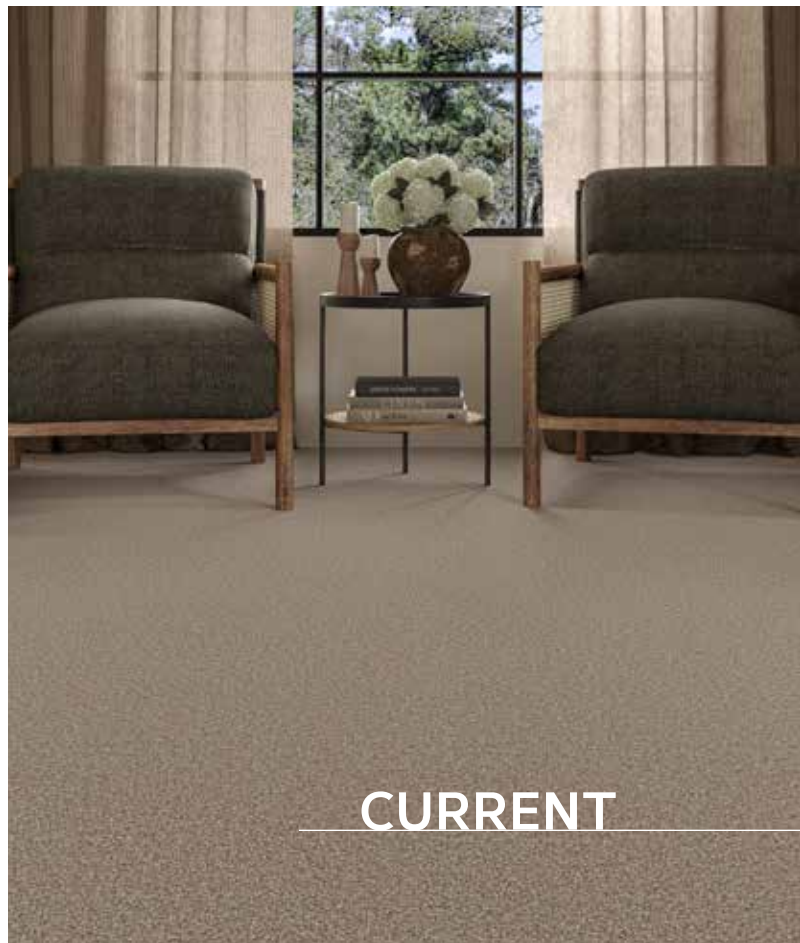

CURRENT

NO DYE LOTS

ANNOUNCING NO DYE LOTS ON SURESOFT™SD SOFT SURFACE FLOORS

This includes all Microban® Polyester and PH styles that are manufactured after September 1, 2023.

Our manufacturing and product development teams have worked for well over a year so we can confidently offer No Dye Lots on our Polyester soft surface floors. We are working to offer the same benefit for Nylon in the future.

What is No Dye Lot?

No Dye Lot means that the color of the carpet will be the same from roll to roll, regardless of when it was manufactured.

Why Does This Matter?

There are a number of benefits for our retailers and for us:

1. Retailers no longer have to deal with the issue of short rolls when working on a job that requires more carpet than what they have on hand. They can use their short rolls along with a new roll or cut order to complete a job, without having to worry about if the carpet will match.
2. If they have a short roll on hand, they don't have to sell it at a discount. They can use it to start another job, leading to less waste for the retailer and higher profitability by not having to sell off short rolls.
3. Allows retailers to potentially get their carpet order from us faster. They will be given the option to buy shorter rolls verses waiting until the next time the carpet will be manufactured for a longer roll.
4. Having flexible options for retailers helps us to earn trust in our brand and floors and makes us easier to work with. For us, this helps us to better manage our own inventory and have less waste.

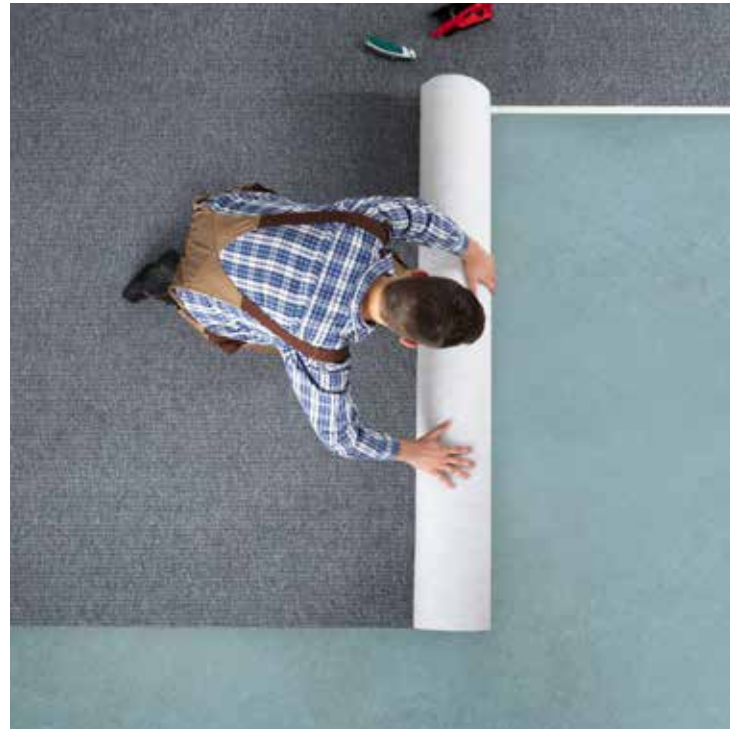

Have Confidence, Guaranteed

You can have confidence in our No Dye Lot benefit because we have the tightest tolerances than any other residential carpet manufacturer.

Our floors are guaranteed to match on any SureSoft™SD solution dyed polyester floor that is manufactured after September 1, 2023.

VIRTUAL DECORATOR

Floors.com/TryOn | The More They Can See It, The More You Can Sell It

Consumers have a hard time visualizing what their new floor will look like. Use our free tools on a tablet, smart phone or computer—no apps or downloads:

Compare

Try on our floors in any room—your or ours. Use the slider tool to view two floors side-by-side.



Save

Find something you love? You can save the image online, export it as a new file or print it out.

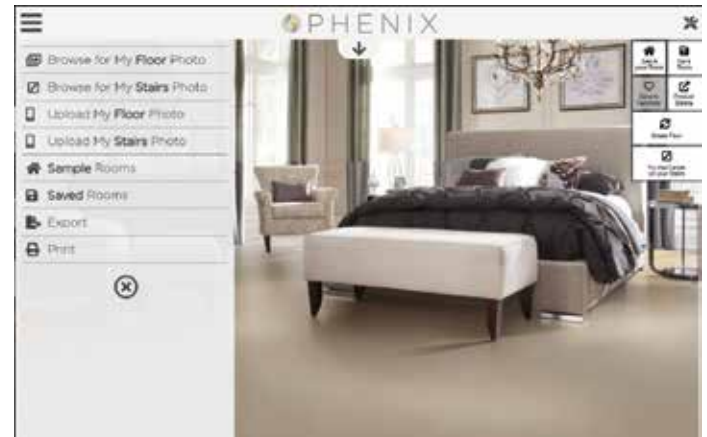

Rotate

Put a “spin” on a look you like and see how the floor will look in a different direction.



Stairs

Try on our floors on your stairs in a few clicks.



SOCIAL MEDIA

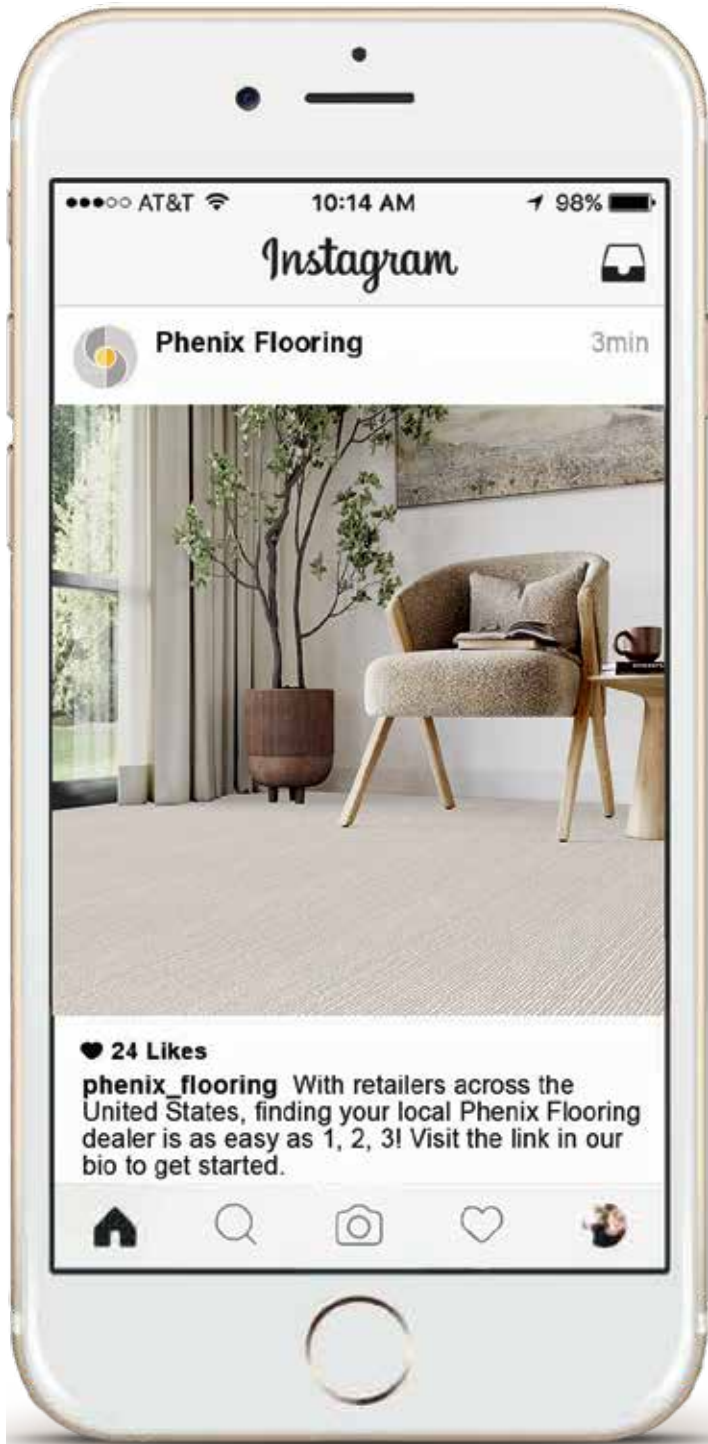

SOCIAL MEDIA

 **INSTAGRAM**
 @phenix_flooring
 #PhenixFlooring
 #TISE2025

 **FACEBOOK**
 @PhenixFlooring
 #TISE2025

 **PINTEREST**
 PhenixFlooring

 **LINKEDIN**
 Phenix-Flooring

MANNINGTON CONNECT

Register on [Connect.Mannington.com](https://connect.mannington.com)

To Register, go to [CONNECT.MANNINGTON.COM](https://connect.mannington.com), and click on 'Register Today!'

If you experience an issue during registration to the portal, our team will automatically be notified and provide further assistance with registration.

If additional assistance is needed, you can contact technical support by clicking the 'Contact Us' link on the **bottom of the login page**.

The image displays two screenshots of the Mannington Connect website interface.

The left screenshot shows the login page. At the top, the Mannington logo is displayed. Below it, the URL [WWW.MANNINGTONCONNECT.COM](https://www.manningtonconnect.com) is shown, along with a note that it is now [CONNECT.MANNINGTON.COM](https://connect.mannington.com). A message asks users to update their bookmarks. Below this, there are two bullet points: one for 'Mannington Commercial Only?' and another for 'New to our site?'. The login form includes a 'Username' field, a 'Password' field, and a 'Log in' button. At the bottom, there are links for 'Forgot your password?', 'Register Today!', and a 'Contact Us' link which is highlighted with a red box.

The right screenshot shows the 'CONTACT CUSTOMER SUPPORT' form. The title is 'CONTACT CUSTOMER SUPPORT' with the subtitle 'TELL US HOW WE CAN HELP'. The form contains several input fields: '*CONTACT FIRST NAME', '*CONTACT LAST NAME', '*WEB EMAIL', '*COMPANY NAME', '*MANNINGTON ACCOUNT NUMBER', '*COMPANY ADDRESS', '*COMPANY CITY', '*COMPANY STATE' (a dropdown menu with 'Select an Option'), and '*DESCRIPTION'. A 'SUBMIT' button is located at the bottom of the form.

If you experience issues with accessing the site directly and are unable to contact us from the login screen, please click Contact US and fill out the following form, and we will assist you as soon as possible.

MANNINGTON CONNECT

Welcome to Mannington Connect!

Mannington Connect is a powerful online portal and resource for managing your Mannington account!

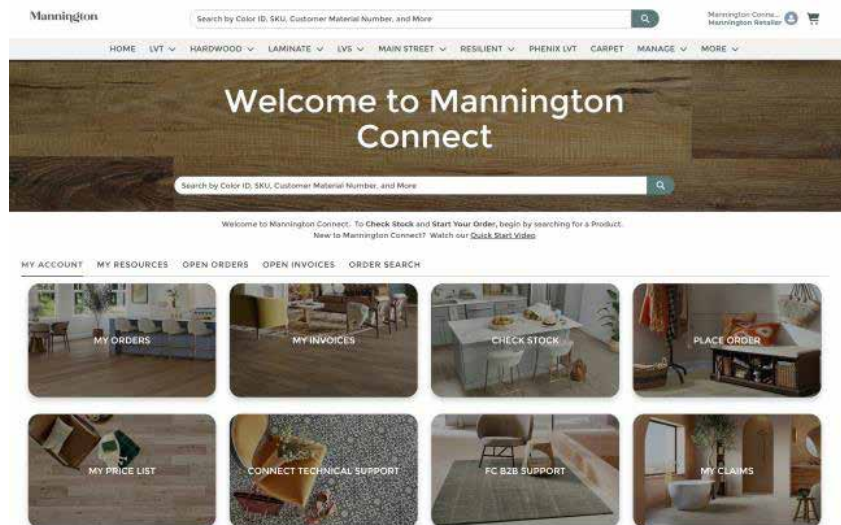

Check Stock and Place Orders Online

Check Mannington and Phenix Stock at Mannington Warehouses with just a couple clicks. Place orders with an easy step by step process.

Review Order Status and Track Shipping

Stay on top of open and previous orders with Mannington. Review by overall order statuses, and stay up to date with individual line status of orders with easy to see shipment dates. For lines that have shipped, easily track shipments online. Download critical order documentation, such as Order Confirmations and Bills of Lading for each order.

Access and Download Price Sheets

Request both Hard Surface and Soft Surface Price Lists directly from our portal, and emailed directly to your inbox in seconds!

Manage and Access Invoices

See a list of previous and open invoices for your account. Easily search for invoices by Order, PO, and more. See invoice details, and download invoices directly to your computer.

PHENIX REWARDS

WELCOME TO

PHENIX
Rewards

- MasterCard® PrePaid: choose a one time physical card or opt for a digital card
- Simplified process to “Claim Your Sales”
- Points will be issued immediately after you claim your sale
- Sales can be claimed as far back as 90 days from the date of the sale

Points are assigned by price range
not style

CARPET PRODUCTS PRICE AND POINT VALUE RANGE

- Products \$20 and above = 30 points per Sq Yd
- Products \$12-\$19.99 = 18 points per Sq Yd
- Products \$7-\$11.99 = 12 points per Sq Yd
- Products \$6-\$6.99 = 6 points per Sq Yd

HARD SURFACE PRODUCTS PRICE AND POINT VALUE RANGE:

- All Hard Surface Products = 2 points per Sq Ft

Visit
FlooringRewards.com
to **Get Started Today!**

STEP 1 SIGN UP

Visit
FlooringRewards.com
to register and receive 1,000 bonus
points just for signing up!

STEP 2 EARN POINTS

Earn points each time you submit your
sales information for eligible Phenix
carpet and hard surface products.

STEP 3 REDEEM

Redeem your rewards points for **Cash,
Merchandise, and Travel!**

For questions regarding registration, please contact
hello@FlooringRewards.com. or call 877-467-0388



National Accounts/Buying Groups

ONE MANNINGTON

ONE PHENIX



One Phoenix

PROGRAM & BENEFITS

ONE PHENIX

2025 RETAILER BENEFITS

We consider our **One Phenix** retailers to be valued partners, and we are now offering more **One Phenix** benefits than ever before!

▪ YEARLY REBATE

Earn a yearly rebate based upon your eligible sales. The more Mannington you sell, the more you earn!

▪ FREE VISUALIZATION TOOLS

Our digital tools allow you to offer your customers a new level of service by helping them to visualize a Mannington floor in their home.
Floors.com/TryOn—Try on our floors in any room.

▪ PREFERRED LISTING ON MANNINGTON.COM'S STORE LOCATOR

▪ EXCLUSIVE ONE MANNINGTON WEBSITE & MARKETING TOOLS

Access to Mannington.com/PK—all of Mannington's marketing content in one place!

▪ PHENIX MERCHANDISING PROGRAM (PMP)

Receive automatic sample updates at least once a year at an exclusive discount.

▪ DIRECT COMMUNICATIONS

Get updates, news and product information. Go to Mannington.com/signup.

▪ SELF-INSPECT CLAIMS

▪ EDUCATIONAL & TRAINING OPPORTUNITIES

▪ DISPLAY FLOOR DISCOUNTS

▪ EXCLUSIVE PROMOTIONAL OPPORTUNITIES

▪ ACCESS TO BROADLUME

Details to come in the near future

2025 ONE PHENIX REBATE PROGRAM OVERVIEW: REBATE LEVELS

You can earn a yearly rebate on your qualifying Phenix Carpet Sales. Just like on Hard Surface, you now have a chance to partner with us on Carpet to grow your business and **earn up to a 4% rebate!**

LEVEL	SILVER	GOLD	PLATINUM
Sales Level Needed for Rebate	\$12,000+	\$24,000+	\$48,000+
Rebate	2%	3%	4%

PROGRAM REQUIREMENTS

- Sales volume (as indicated in the chart above)
 - Must have a Phenix Lowboy display
 - This rebate is separate from Hard Surface
- Note: Must be signed up in Salesforce as a One Phenix Retailer

2025 ONE PHENIX REBATE PROGRAM

Both Rebate and Volume product sales will count towards your overall sales volume. However, you will only receive your rebate based on products that are eligible for a rebate.

	REBATE OR VOLUME		REBATE OR VOLUME		REBATE OR VOLUME
FE101 Bravo	Rebate	FP031 In The Details	Rebate	MB147 Oasis Platinum	Rebate
FE102 Ovation	Rebate	FP032 Debut	Rebate	MB148 Oasis Gold	Rebate
FE103 Accolades	Rebate	FP033 Impression	Rebate	MB149 Oasis Silver	Rebate
FE104 Tribute	Rebate	FP034 Cardigan	Rebate	MB150 Mesh	Rebate
FE105 Insight	Rebate	FP035 Vista Gold	Rebate	MB151 Aura	Rebate
FE106 Epiphany	Rebate	FP036 Vista Silver	Rebate	MB152 Cabana	Rebate
FE107 Crave	Rebate	FP037 Madras	Rebate	MB153 Illusion Gold	Rebate
FE108 Desire	Rebate	FP038 Grande Vista	Rebate	MB154 Illusion Silver	Rebate
FE109 Intellect	Rebate	FP039 Karma Gold	Rebate	MB155 Current Platinum	Rebate
FE110 Yearn	Rebate	FP040 Karma Silver	Rebate	MB156 Current Gold	Rebate
FE111 Succeed	Rebate	FP041 Signature Platinum	Rebate	MB157 Current Silver	Rebate
FE112 Surpass	Rebate	FP042 Signature Gold	Rebate	MB158 Escape Gold	Rebate
FE113 Achieve	Rebate	FP043 Signature Silver	Rebate	MB159 Escape Silver	Rebate
FE114 Attain	Rebate	FP044 Seaside	Rebate		
FE115 Conjure	Rebate	FP045 Relic	Rebate	N175 Aurora	Volume
FE116 Aspire	Rebate			N176 Solstice	Volume
		MB100 Bodega Bay	Rebate	N219 Paradox	Rebate
FE502 Idyllic	Rebate	MB110 Divine	Volume	N230 Paragon	Rebate
FE503 Ebullient	Rebate	MB111 Tempt	Volume	N231 Paradigm	Rebate
FE505 Whimsical	Rebate	MB112 Entice	Volume	N233 First Light	Volume
FE506 Eccentric	Rebate	MB115 Ryman	Rebate	N234 Day Break	Volume
FE507 Visionary	Rebate	MB116 Tabernacle	Rebate	N243 Etched	Rebate
		MB117 Lincoln Hall	Rebate	N259 Front Runner	Rebate
FP001 Hydra	Rebate	MB118 Memento	Rebate	N260 Medal Winner	Rebate
FP002 Rhodes	Rebate	MB119 Five Star	Rebate	N261 Grand Champion	Rebate
FP003 Crete	Rebate	MB120 Top Notch	Rebate	N271 Refined	Volume
FP004 Sparta	Rebate	MB121 Medley	Rebate	N272 Essential	Volume
FP005 Emerson	Rebate	MB122 Amarillo	Volume	N273 Appealing	Volume
FP006 Mateo	Rebate	MB123 El Dorado	Volume	N278 Polaris	Volume
FP007 Balboa	Rebate	MB124 Heavenly	Rebate		
FP008 Lido	Rebate	MB125 Ethereal	Rebate	PH007 PH007	Volume
FP009 Portofino	Rebate	MB126 Magical	Rebate	PH016 PH016	Volume
FP010 Sorrento	Rebate	MB127 Cashmere	Rebate	PH018 PH018	Volume
FP011 Luna	Rebate	MB128 Merino	Rebate	PH025 PH025	Volume
FP012 Milo	Rebate	MB129 Glam	Rebate	PH026 PH026	Volume
FP013 Capri	Rebate	MB130 Tweed	Rebate	PH027 PH027	Volume
FP014 Naples	Rebate	MB132 Canvas I	Rebate	PH028 PH028	Volume
FP015 Crystal Cove	Volume	MB133 Canvas II	Rebate	PH029 PH029	Volume
FP016 Seaview	Volume	MB134 Foundation I	Volume	PH030 PH030	Volume
FP017 Paxton	Rebate	MB135 Foundation II	Volume	PH031 PH031	Volume
FP018 Bari	Rebate	MB136 Mirage I	Rebate	PH032 PH032	Volume
FP019 Catania	Rebate	MB137 Mirage II	Rebate	PH033 PH033	Volume
FP020 Palermo	Rebate	MB138 Mirage III	Rebate	PH034 PH034	Volume
FP021 Bougie	Rebate	MB139 Dolce	Rebate		
FP022 Luxe	Rebate	MB140 Allure	Rebate		
FP024 Mykonos	Rebate	MB141 Reflection	Rebate		
FP025 Maxwell	Rebate	MB142 Boucle	Rebate		
FP026 Del Mar	Rebate	MB143 Colonnade	Rebate		
FP027 Big Sur	Rebate	MB144 Courtyard	Rebate		
FP028 Aviara	Rebate	MB145 Radiant Gold	Rebate		
FP029 Verona	Rebate	MB146 Radiant Silver	Rebate		
FP030 All Inclusive	Rebate				

Enjoy the Benefits of Preferred Status

As a **One Phenix** dealer, your business information and Preferred status are displayed prominently on PhenixFlooring.com's Store Locator. An important tool that consumers use when they are doing their research, the Phenix Store Locator makes it easy for local customers to find you! Being included as a Preferred Phenix dealer represents your strong Phenix product knowledge and commitment to providing a superior customer experience.

One Phoenix

PROGRAM SIGN-UP

ONE PHENIX PROGRAM SIGN-UP

I have reviewed the **One Phenix** Program and believe that it will be valuable to my business now and in the coming years. It is my desire to sign on as a partner through the **One Phenix** Program, and work with Phenix to grow my business. In support of my commitment, I feel I can grow Phenix sales by _____ in the next 12 months.

Follow-up Meeting Date

Account Number

Account Name

Account Address

City

State

Zip

Main Contact Number

Main Contact Email

Retailer Contact Signature

Date

Mannington TM Signature

Date

PROGRAM NEXT STEPS

Here are the next steps to ensure success of your Retailer in the **One Phenix** Program.

1. Make sure that the retailer understands the **One Phenix** Program and has signed their commitment.
2. Ask your retailer to schedule any Product Knowledge sessions to get their Retail Sales Associate educated on Phenix Flooring products.
3. Schedule a follow-up meeting with the retailer to ensure things progress smoothly with implementing **One Phenix**.
4. Schedule a 6 month review with the retailer to understand progress towards their **One Phenix** commitment.

Additional Items to Complete—

ONE PHENIX & KEY ACCOUNTS DISPLAY PROMOTION



FLOOREVER™ PETPLUS DISPLAY

\$799 Fully Loaded
=(16) \$50.00 Coupons

SAP Number 532288

Wing Card Set—No Display Graphics

\$499
=(10) \$50.00 Coupons

SAP Number 531351



MICROBAN® LOW BOY DISPLAY

\$799 Fully Loaded
=(16) \$50.00 Coupons

SAP Number 531364

Wing Card Set—No Display Graphics

\$499
=(10) \$50.00 Coupons

SAP Number 531363

Please connect with your RSD to set your targets and goals for this display placement promotion. To place your Display order, contact your local Mannington Sales Representative.

PHENIX



FloorEver™ PetPlus

OUR DIFFERENCE IS IN THE DETAILS



1. Commercial-grade stain protection in a residential carpet. Our SureSoftSDN™ cationic nylon fibers repel acid-based stains. No worries about spills like wine, spaghetti sauce or pet stains.



2. Color through the entire fiber, not just on the surface. Our SureSoftSDN™ fibers are Solution Dyed, meaning they have the dye all the way through the fiber, like a carrot. Which means no fading and after years of wear from cleaning and wear and tear, the color of the carpet will still shine through.



3. Microban® Surface Protection Helping to protect 24/7 against the growth of bacteria, mold and mildew, and remain 99% cleaner than untreated surfaces.



4. Warranted for Stairs How many carpets can you name that are warranted for stairs? We stand by our durability and performance of our SureSoftSDN™ fibers so much, this carpet is warranted for the stairs.

PRODUCT BENEFITS

MICROBAN®
24/7 SURFACE PROTECTION | **99%** CLEANER



ENHANCED PET PROTECTION



STAIN + SPILL PROTECTION



DURABILITY GUARANTEED



KID FRIENDLY



100 DAY SATISFACTION



WARRANTED FOR STAIRS



ASTHMA + ALLERGY FRIENDLY



SureSoftSDN™
 Solution Dyed Cationic Nylon

PHENIX

FloorEver™ PetPlus

- FloorEver™ PetPlus Display
- 74.375" x 19.3125" x 71.0625" Footprint





MICROBAN®

If your customer's biggest concern is value, take them to the Microban® low boy display. All of the styles in this display feature our SureSoftSD™ polyester fibers, but also have built-in Microban® antimicrobial protection, all at a wallet-friendly price point. Microban® protects 24/7 against the growth of bacteria, mold, and mildew that can cause stains, odors, and product deterioration. On an unprotected surface, bacteria can double every 20 minutes.

Surfaces with built-in Microban® technology remain 99% cleaner from the growth of bacteria and odors than untreated surfaces. Microban® technology does not wash or wear off and is a permanent part of the carpet.

STYLE AND DESIGN LEADERSHIP

- Made of SureSoftSD™ Solution Dyed Polyester, meaning they have the dye all the way through the fiber
- Phenix carpets with Microban® help protect 24/7 against the growth of bacteria, mold and mildew, and remain 99% cleaner than untreated surfaces
- Built-in protection that lasts for the life of the carpet cleaner, with no additional cost or effort

PRODUCT BENEFITS

MICROBAN®
24/7 SURFACE PROTECTION | **99%** CLEANER



KID & PET FRIENDLY



EASY TO CLEAN & MAINTAIN



FADE & STAIN RESISTANT



ASTHMA + ALLERGY FRIENDLY



GREEN LABEL PLUS



SureSoftSD™
Solution Dyed Polyester

PHENIX

MICROBAN®

- Microban® LowBoy Display
- 74.375" x 19.3125" x 71.0625" Footprint



LIFETIME PLUS

ABBEE CARPET
FLOORS TO GO

MICROBAN



Surfaces treated with Microban technology remain 99% cleaner from the growth of bacteria and odors than untreated surfaces.



Microban technology protects 24/7 against the growth of bacteria, mold and mildew that can cause stains, odors and product deterioration.

 **Abbey Carpet & Floor**



Floors To Go.



DIMENSIONS

DEPTH 34 1/16"

WIDTH 65 1/8"

HEIGHT 65 3/16"

PROGRAM NUMBER: Abbey - ABB1534 | FTG - FTG1534

Wing Cards 24x36

Option 1

Cards Only includes 19 wing cards

SAP: ABBEY 531341

SAP: FTG 531358

Option 2

Display + Cards includes display graphics and 19 wing cards

SAP: ABBEY 531344

SAP: FTG 531357

Update Kit

Contact Tonya Gaddis

Tonya.Gaddis@Phenixflooring.com

AB228/FG228 Forward Dash

AB229/FG229 Fresh Mix

AB230/FG230 Friendly Match

PHENIX

LIFETIME PLUS

ABBEY CARPET
FLOORS TO GO

MICROBAN



Surfaces treated with Microban technology remain 99% cleaner from the growth of bacteria and odors than untreated surfaces.



Microban technology protects 24/7 against the growth of bacteria, mold and mildew that can cause stains, odors and product deterioration.

Abbey Carpet & Floor



Floors To Go

PHENIX			Abbey - ABB1534		LIFETIME PLUS	
BOARD	STYLE #	STYLE NAME	STYLE #	STYLE NAME	STYLE #	STYLE NAME
1	FE502	Idyllic	AB192	Long Preserve	FG192	Everlasting Song
	FE503	Ebullient	AB193	Luxury Island	FG193	Exciting Visit
2	FE101	Bravo	AB602	Missing You	FG602	Ideal Age
	FE102	Ovation	AB603	Peaceful Spring	FG603	Legend Moon
3	MB155	Current Platinum	AB228	Forward Dash	FG228	Forward Dash
	MB156	Current Gold	AB229	Fresh Mix	FG229	Fresh Mix
	MB157	Current Silver	AB230	Friendly Match	FG230	Friendly Match
4	FE105	Insight	AB606	Quail Creek	FG606	Logan Drive
	FE109	Intellect	AB607	Ranch Trail	FG607	Magic Circle
5	FE106	Epiphany	AB608	Regal Dynasty	FG608	Magical Land
6	FE107	Crave	AB609	Rest On	FG609	Major Decision
7	FE108	Desire	AB601	Sawyer City	FG601	Sawyer Heights
8	FE110	Yearn	AB610	Sailing Along	FG610	Modern Day
9	FE111	Succeed	AB611	Sandpiper Isle	FG611	Monday Lane
	FE112	Surpass	AB612	Tackle Road	FG612	Never Fear
10	FE115	Conjure	AB615	Wagon Trail	FG615	Renewed Style
11	FE116	Aspire	AB616	Ribbon Award	FG616	Splendid Song
12	FP033	Impression	AB635	Amazing Feeling	FG635	Adoring Delight
13	FP034	Cardigan	AB636	Get Creative	FG636	Get Ready
14	MB143	Colonnade	AB225	Pioneer Island	FG225	Pioneer Island
	MB144	Courtyard	AB224	Pioneer City	FG224	Pioneer City
15	MB145	Radiant Gold	AB214	Give Your Heart	FG214	Give Your Heart
	MB146	Radiant Silver	AB215	Graceful Dance	FG215	Graceful Dance
16	MB147	Oasis Platinum	AB216	Star Moment	FG216	Star Moment
	MB148	Oasis Gold	AB217	Stardust Lane	FG217	Stardust Lane
	MB149	Oasis Silver	AB218	Stargazer Way	FG218	Stargazer Way
17	MB150	Mesh	AB219	Panther Run	FG219	Panther Run
	MB151	Aura	AB220	Panther Trail	FG220	Panther Trail
18	MB152	Cabana	AB221	State of Grace	FG221	State of Grace
19	MB153	Illusion Gold	AB222	Everlasting Shine	FG222	Everlasting Shine
	MB154	Illusion Silver	AB223	Evening Light	FG223	Evening Light

PHENIX

EVERY DAY LIVING CARPET

ABBEY CARPET
FLOORS TO GO

MICROBAN



Surfaces treated with Microban technology remain 99% cleaner from the growth of bacteria and odors than untreated surfaces.



Microban technology protects 24/7 against the growth of bacteria, mold and mildew that can cause stains, odors and product deterioration.

 **Abbey Carpet & Floor**



Floors To Go.



DIMENSIONS

DEPTH 34 1/16"

WIDTH 65 1/8"

HEIGHT 65 3/16"

PROGRAM NUMBER: Abbey - ABB1531 | FTG - FTG1531

Wing Cards 24x36

Option 1

Cards Only includes 21 wing cards

SAP: ABBEY 531340

SAP: FTG 531355

Option 2

Display + Cards includes display graphics and 21 wing cards

SAP: ABBEY 531343

SAP: FTG 531356

Update Kit

Contact Tonya Gaddis

Tonya.Gaddis@phenixflooring.com

PHENIX

EVERY DAY LIVING CARPET

ABBEY CARPET
FLOORS TO GO

MICROBAN



Surfaces treated with Microban technology remain 99% cleaner from the growth of bacteria and odors than untreated surfaces.



Microban technology protects 24/7 against the growth of bacteria, mold and mildew that can cause stains, odors and product deterioration.

PHENIX

Abbey Carpet & Floor

Floors To Go.

PHENIX

Abbey - ABB1531

EVERYDAY LIVING

PIN	STYLE #	STYLE NAME	STYLE #	STYLE NAME	STYLE #	STYLE NAME
1	N175	Aurora	AB101	Campus Hall	FG101	Capiello
	N176	Solstice	AB102	Cherry Creek	FG102	Conley
2	MB115	Ryman	AB179	Wall Street	FG179	Walden Square
	MB116	Tabernacle	AB167	Fenwick	FG167	Festive
	MB117	Lincoln Hall	AB168	Kelly Lane	FG168	Kelly Ridge
3	MB132	Canvas I	AB202	Simple Grace I	FG202	So Confident I
	MB133	Canvas II	AB203	Simple Grace II	FG203	So Confident II
4	N219	Paradox	AB114	Javelin	FG114	Jewelberry
	N230	Paragon	AB115	Kalista	FG115	Kodiac
	N231	Paradigm	AB116	La Habra	FG116	Largo
5	MB119	Five Star	AB169	Kelly Station	FG169	Kellyville
	MB120	Top Notch	AB170	Kempsey	FG170	Kempsey Mill
6	N233	First Light	AB118	Albion	FG118	Aberdeen
	N234	Day Break	AB119	Astrid	FG119	Adagio
7	MB134	Foundation I	AB204	Simple Touch I	FG204	So Expressive I
	MB135	Foundation II	AB205	Simple Touch II	FG205	So Expressive II
8	N243	Etched	AB121	Ballina	FG121	Bavaria
9	Microban Info Card					
10	MB136	Mirage I	AB206	Simple Elegance I	FG206	So Inspiring I
	MB137	Mirage II	AB207	Simple Elegance II	FG207	So Inspiring II
	MB138	Mirage III	AB208	Simple Elegance III	FG208	So Inspiring III
11	N259	Front Runner	AB133	Neverending	FG133	New Moon
	N260	Medal Winner	AB134	Neverland	FG134	New Oasis
	N261	Grand Champion	AB135	Old World	FG135	Once Upon A Time
12	MB122	Amarillo	AB181	Endless Acres	FG181	Alabama Moon
	MB123	El Dorado	AB182	Endless Waves	FG182	Alton Lane
13	MB118	Memento	AB178	Wakefield Estate	FG178	Wakefield Lake
14	MB121	Medley	AB180	Club Mason	FG180	World Champ
15	MB111	Tempt	AB173	Key Adventure	FG173	My Design
	MB112	Entice	AB174	My Dreams	FG174	My Leader
16	MB140	Allure	AB210	Embrace Love	FG210	Endless Fun
17	MB141	Reflection	AB211	Embrace Today	FG211	Endless Night
18	MB142	Boucle	AB212	Embrace Tradition	FG212	Endless Peace
19	PH028	PH028	AB213	Embrace Wonder	FG213	Endless Charm
20	MB124	Heavenly	AB183	Epic Adventure	FG183	Band Together
	MB125	Ethereal	AB184	Ever Improving	FG184	Beautiful Treasure
	MB126	Magical	AB185	Fable Circle	FG185	Beloved Feeling
21	MB127	Cashmere	AB186	Falling Star	FG186	Capri Circle
	MB128	Merino	AB187	Grant Estate	FG187	Charity Island

LIFETIME PLUS
PET DEFENSE



 **Abbey Carpet & Floor**

 **Floors To Go.**



DIMENSIONS

DEPTH 34 1/16"

WIDTH 65 1/8"

HEIGHT 65 3/16"

PROGRAM NUMBER: Abbey - ABB1535 | FTG - FTG1535

Wing Cards 24x36

Option 1

Cards Only includes 18 wing cards

SAP: ABBEY 531342

SAP: FTG 531359

Option 2

Display + Cards includes display graphics and 18 wing cards

SAP: ABBEY 531345

SAP: FTG 531360

Update Kit

Contact Tonya Gaddis

Tonya.Gaddis@Phenixflooring.com

AB640/FG640 Paradise Bay

AB641/FG641 Paradise Found

AB642/FG642 Point Harbor

AB643/FG643 Tavern Beach

AB644/FG644 Brighton Shore

AB646/FG646 Grand Award

AB647/FG647 Great Adventure

AB648/FG648 Great Society

PHENIX

LIFETIME PLUS
PET DEFENSE

 **Abbey Carpet & Floor**

 **Floors To Go.**



PHENIX

ABBEY - ABB1531

FLOORS TO GO

BOARD	STYLE #	STYLE NAME	STYLE #	STYLE NAME	STYLE #	STYLE NAME
1	FP009	Portofino	AB617	Amazing Moment	FG617	Amazing Moment
2	FP010	Sorrento	AB618	Beautiful Dreamer	FG618	Beautiful Dreamer
3	FP044	Seaside	AB643	Tavern Beach	FG643	Tavern Beach
4	FP045	Relic	AB644	Brighton Shore	FG644	Brighton Shore
5	FP029	Verona	AB621	English Manor	FG621	English Manor
6	FP038	Grande Vista	AB642	Point Harbor	FG642	Point Harbor
7	FP039	Karma Gold	AB640	Paradise Bay	FG640	Paradise Bay
	FP040	Karma Silver	AB641	Paradise Found	FG641	Paradise Found
8	FP024	Mykonos	AB624	Mystical Island	FG624	Mystical Island
9	FP018	Bari	AB625	Natural Feeling	FG625	Natural Feeling
10	FP019	Catania	AB626	Night Star	FG626	Night Star
11	FP020	Palermo	AB627	Noble Dream	FG627	Noble Dream
12	FP041	Signature Platinum	AB646	Grand Award	FG646	Grand Award
	FP042	Signature Gold	AB647	Great Adventure	FG647	Great Adventure
	FP043	Signature Silver	AB648	Great Society	FG648	Great Society
13	FP001	Hydra	AB630	Sunrise Retreat	FG630	Sunrise Retreat
14	FP002	Rhodes	AB631	Sweet Adventure	FG631	Sweet Adventure
15	FP021	Bougie	AB633	West Hill	FG633	West Hill
16	FP022	Luxe	AB634	Weston Bay	FG634	Weston Bay
17	FP035	Vista Gold	AB637	Cheerful Breeze	FG637	Cheerful Breeze
	FP036	Vista Silver	AB638	Cheerful Charm	FG638	Cheerful Charm
18	FP037	Madras	AB639	Broad Method	FG639	Broad Method

PHENIX

PICK A PACK

CARPETS PLUS

MICROBAN



Surfaces treated with Microban technology remain 99% cleaner from the growth of bacteria and odors than untreated surfaces.



Microban technology protects 24/7 against the growth of bacteria, mold and mildew that can cause stains, odors and product deterioration.



Wing Cards 21x32

Option 1

ComfortSoftSD PET Cards Only

8 wing card solution dyes PET with Microban®

SAP: 531349

POLYESTER

CARD #	STYLE NAME	MILL STYLE NAME
1	Hubble's Law	Front Runner
	Kuiper Belt	Medal Winner
	Tidal Force	Grand Champion
3	Orbit	Ryman
	Winter Moon	Tabernacle
	Starship	Lincoln Hall
5	Astrid	Paragon
	Cassiopeia	Paradigm
	Ophelia	Paradox
7	Zodiac	Daybreak
	Capricornus	First Light

PHENIX

CLEAN HOME DESTINATION

CARPETS PLUS

MICROBAN



Surfaces treated with Microban technology remain 99% cleaner from the growth of bacteria and odors than untreated surfaces.



Microban technology protects 24/7 against the growth of bacteria, mold and mildew that can cause stains, odors and product deterioration.

CarpetsPlus
COLORTILE
AMERICA'S FLOOR STORE



DIMENSIONS

DEPTH 18 3/16"
WIDTH 67 5/16"
HEIGHT 60 3/8"

Wing Cards 21x32

Option 1 **Cards Only** includes 12 wing cards
SAP: 531348

Option 2 **Display + Cards** includes display graphics and 12 wing cards
SAP: 531347

Update Kit **Cards Only**
Contact Tonya Gaddis
Tonya.Gaddis@phenixflooring.com

PHENIX

CLEAN HOME DESTINATION

CARPETS PLUS



Surfaces treated with Microban technology remain 99% cleaner from the growth of bacteria and odors than untreated surfaces.



Microban technology protects 24/7 against the growth of bacteria, mold and mildew that can cause stains, odors and product deterioration.



POLYESTER

PIN	STYLE #	MILL STYLE NAME	CARPETS PLUS STYLE #	CARPETS PLUS STYLE NAME
1	MB124	Heavenly	CP167	Distressed
	MB125	Ethereal	CP168	Limited Edition
	MB126	Magical	CP169	Pantone
2	MB129	Glam	CP166	Bellow
3	FE505	Whimsical	CP174	Blind Side
4	MB127	Cashmere	CP170	Breakaway
	MB128	Merino	CP171	Let it Be
	MB122	Amarillo	CP178	Melodious
5	MB123	El Dorado	CP179	Composite
6	FE506	Eccentric	CP175	Amore
	FE507	Visionary	CP176	Aria
7	MB121	Medley	CP177	Retrograde
8	FE502	Idyllic	CP172	Monochrome
	FE503	Ebullient	CP173	Now or Never
9	MB110	Divine	CP149	Invigorating
10	MB118	Memento	CP163	Penchant
11	MB111	Tempt	CP165	Bayside
	MB112	Entice	CP164	Manifest
12	MB142	Bouclé	CP181	Delighted

PHENIX

HAPPY PETS DESTINATION

CARPETS PLUS

MICROBAN



Surfaces treated with Microban technology remain 99% cleaner from the growth of bacteria and odors than untreated surfaces.



Microban technology protects 24/7 against the growth of bacteria, mold and mildew that can cause stains, odors and product deterioration.

Your Destination for **happy**  **pets**.
CARPET



DIMENSIONS

DEPTH 18 3/16"

WIDTH 67 5/16"

HEIGHT 60 3/8"

Wing Cards 21x32

Option 1 **Cards Only** includes 21 wing cards
SAP: 532294

Option 2 **Display + Cards** includes display graphics
and 21 wing cards
SAP: 532292

Update Kit **Cards Only**
Contact Tonya Gaddis
Tonya.Gaddis@phenixflooring.com

PHENIX

HAPPY PETS DESTINATION

CARPETS PLUS



Surfaces treated with Microban technology remain 99% cleaner from the growth of bacteria and odors than untreated surfaces.



Microban technology protects 24/7 against the growth of bacteria, mold and mildew that can cause stains, odors and product deterioration.

PHENIX

Your Destination for **happy** **pets.**
CARPET

MILL

CARPETS PLUS

CARD#	STYLE # & NAME	STYLE #	STYLE NAME
1	FE101 Bravo	CP600	Gatsby
	FE102 Ovation	CP601	Macbeth
2	FE105 Insight	CP604	Oliver Twist
	FE109 Intellect	CP605	Othello
3	FE106 Epiphany	CP606	Secret Garden
4	FE107 Crave	CP607	Humphrey
5	FE108 Desire	CP608	Burton
6	FE110 Yearn	CP609	Dickens
7	FE111 Succeed	CP610	Faulkner
	FE112 Surpass	CP611	Hayes
8	FE113 Achieve	CP612	Hemingway
	FE114 Attain	CP613	Twain
9	FE115 Conjure	CP614	Wilder
10	FE116 ASPIRE	CP615	Wolf
11	Story Board		
12	FP009 Portofino	CP637	Star Casting
	FP010 Sorrento	CP638	Off Broadway
13	FP005 Emerson	CP618	Quiet Sanctuary
	FP006 Mateo	CP619	Ralph
14	FP012 Verona	CP620	Round Up
	FP014 Debut	CP621	Staccato
15	FP025 Maxwell	CP622	Sylvester
16	FP024 Mykonos	CP623	Tom Sawyer
17	FP018 Bari	CP624	Bruckner
	FP019 Catania	CP625	Vanity Fair
	FP020 Palermo	CP626	Clarion
18	FP003 Crete	CP627	Almond Blossoms
	FP004 Sparta	CP628	Atelier
19	FP001 Hydra	CP629	Beethoven
	FP002 Rhodes	CP630	Berlioz
20	FP021 Bougie	CP632	Brahms
	FP022 Luxe	CP633	Brown Sugar
21	FP034 Cardigan	CP634	Sinclair

PERFECT HOME
LVT TOWER

ALLIANCE
FLOORING INC.
CARPETS PLUS



Surfaces treated with Microban technology remain 99% cleaner from the growth of bacteria and odors than untreated surfaces.



Microban technology protects 24/7 against the growth of bacteria, mold and mildew that can cause stains, odors and product deterioration.



PERFECT HOME STYLE NAME	PERFECT HOME STYLE #	PERFECT HOME COLOR NAME	PERFECT HOME COLOR #	MILL STYLE NAME
Toscana Flex	FPH491	Cocoon	FPH491	ADURA®Flex Fresco
Toscana Flex	FPH490	High Tea	FPH490	ADURA®Flex Fresco
Toscana Pro	PPH491	Cocoon	PPH491	ADURA®Flex Fresco
Toscana Pro	PPH490	High Tea	PPH490	ADURA®Flex Fresco
Toscana Max	MPH491	Cocoon	MPH491	ADURA®Flex Fresco
Toscana Max	MPH490	High Tea	MPH490	ADURA®Flex Fresco

PHENIX

PERFECT HOME
PEAK
PERFORMERS

ALLIANCE
FLOORING INC.
CARPETS PLUS

MICROBAN



Surfaces treated with Microban technology remain 99% cleaner from the growth of bacteria and odors than untreated surfaces.



Microban technology protects 24/7 against the growth of bacteria, mold and mildew that can cause stains, odors and product deterioration.

Perfect HOME[®]
FLOORING

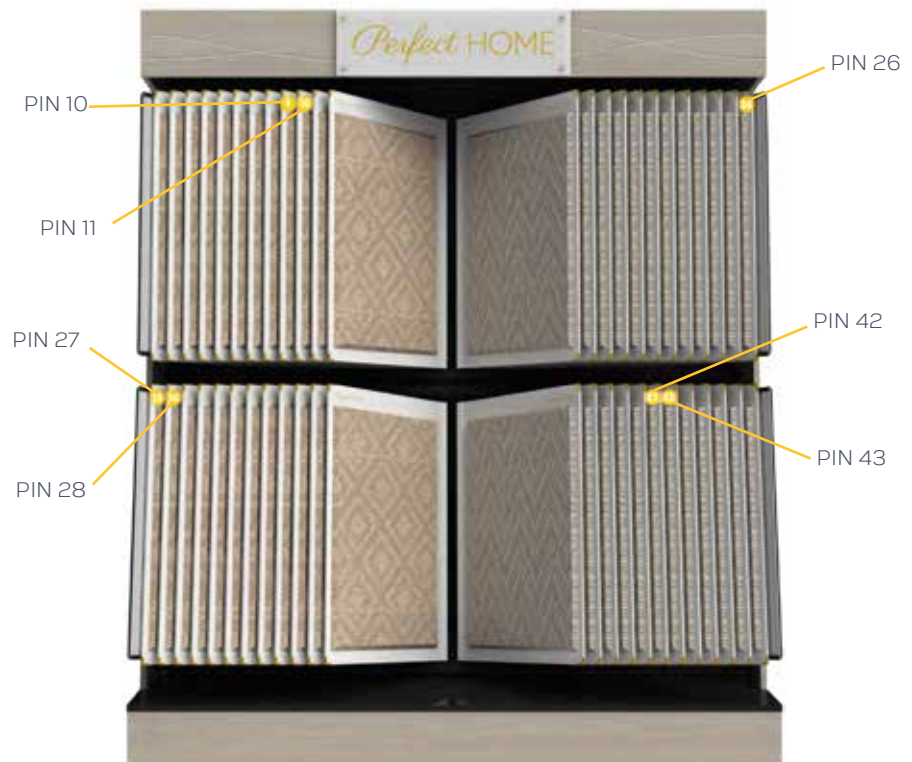

Wing Cards 21x32

POLYESTER

PIN	STYLE #	MILL STYLE NAME	CARPETS PLUS STYLE #	CARPETS PLUS STYLE NAME
10	FP021	Bougie	CP639	Brilliant Addition
	FP022	Luxe	CP640	World Premier
11	FP0171	Paxton	CP606	Secret Garden
26	FP011	Luna	CP610	Faulkner
	FP012	Milo	CP611	Hayes
27	FP009	Portofino	CP637	Star Casting
	FP010	Sorrento	CP638	Off Broadway
28	FP018	Bari	CP635	Flynn Creek
	FP019	Catania	CP636	Overture
42	FP032	Debut	CP641	High Flyers
43	FP033	Impression	CP645	Bright Stars

PHENIX

PERFECT HOME
PEAK
PERFORMERS

ALLIANCE
FLOORING INC.
CARPETS PLUS

MICROBAN



Surfaces treated with Microban technology remain 99% cleaner from the growth of bacteria and odors than untreated surfaces.



Microban technology protects 24/7 against the growth of bacteria, mold and mildew that can cause stains, odors and product deterioration.

Perfect HOME
FLOORING

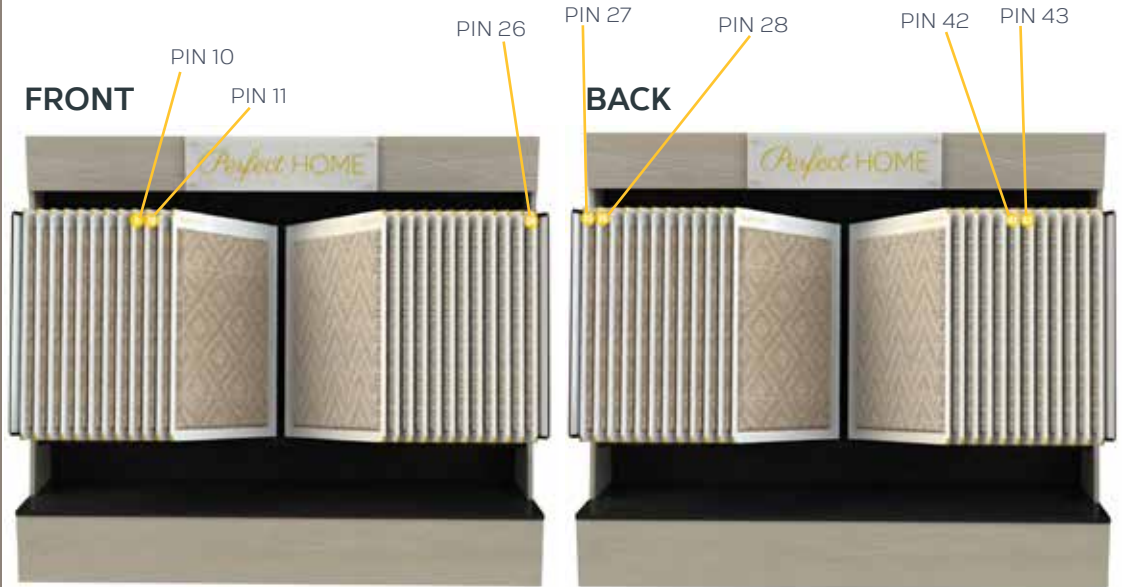

Wing Cards 21x32

POLYESTER - FRONT

PIN	STYLE #	MILL STYLE NAME	CARPETS PLUS STYLE #	CARPETS PLUS STYLE NAME
10	FP021	Bougie	CP639	Brilliant Addition
	FP022	Luxe	CP640	World Premier
11	FP0171	Paxton	CP606	Secret Garden
26	FP011	Luna	CP610	Faulkner
	FP012	Milo	CP611	Hayes

POLYESTER - BACK

PIN	STYLE #	MILL STYLE NAME	CARPETS PLUS STYLE #	CARPETS PLUS STYLE NAME
27	FP009	Portofino	CP637	Star Casting
	FP010	Sorrento	CP638	Off Broadway
28	FP018	Bari	CP635	Flynn Creek
	FP019	Catania	CP636	Overture
42	FP032	Debut	CP641	High Flyers
43	FP033	Impression	CP645	Bright Stars

PHENIX

PERFECT HOME
CASUAL
COMFORTS

ALLIANCE
FLOORING INC.
CARPETS PLUS

MICROBAN



Surfaces treated with Microban technology remain 99% cleaner from the growth of bacteria and odors than untreated surfaces.



Microban technology protects 24/7 against the growth of bacteria, mold and mildew that can cause stains, odors and product deterioration.

Perfect HOME[®]
FLOORING

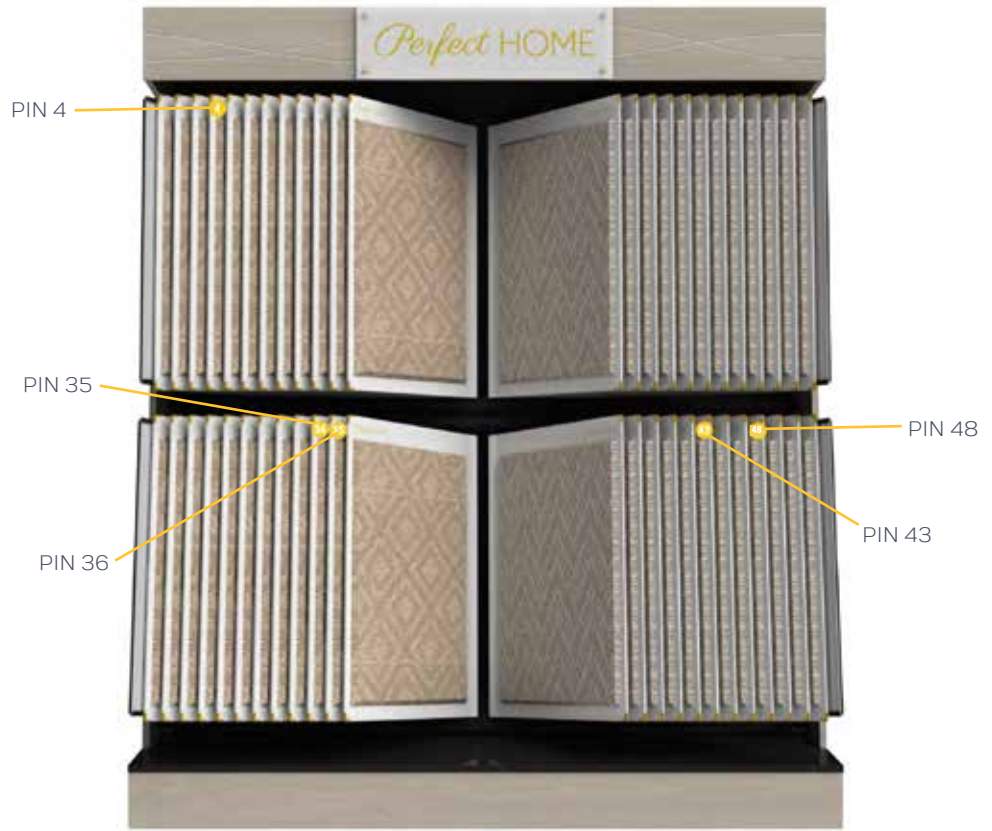

Wing Cards 21x32

POLYESTER

PIN	STYLE #	MILL STYLE NAME	CARPETS PLUS STYLE #	CARPETS PLUS STYLE NAME
4	MB132	Canvas I	CP188	Grandiose I
	MB133	Canvas II	CP189	Grandiose II
35	MB136	Mirage I	CP183	Comfort Zone I
	MB137	Mirage II	CP184	Comfort Zone II
36	MB138	Mirage III	CP185	Comfort Zone III
43	MB141	Reflection	CP186	Stillness Within
48	MB140	Allure	CP187	Open Fields

PHENIX

PERFECT HOME
CASUAL
COMFORTS

ALLIANCE
FLOORING INC.
CARPETS PLUS

MICROBAN



Surfaces treated with Microban technology remain 99% cleaner from the growth of bacteria and odors than untreated surfaces.



Microban technology protects 24/7 against the growth of bacteria, mold and mildew that can cause stains, odors and product deterioration.

Perfect HOME
FLOORING

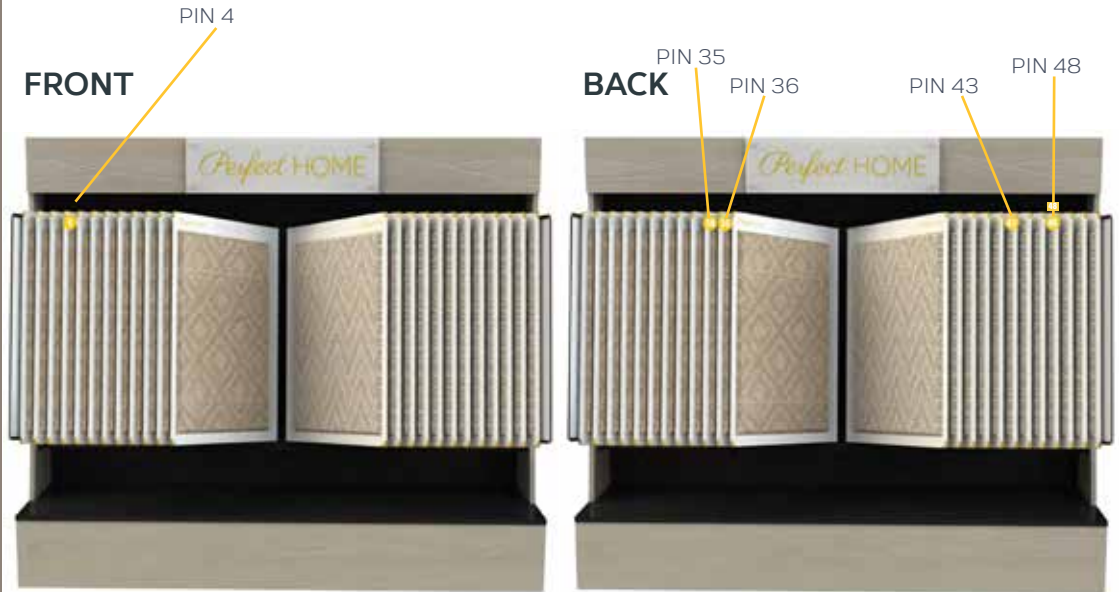

Wing Cards 21x32

POLYESTER - BACK

PIN	STYLE #	MILL STYLE NAME	CARPETS PLUS STYLE #	CARPETS PLUS STYLE NAME
35	MB137	Mirage II	CP184	Comfort Zone II
	MB136	Mirage I	CP183	Comfort Zone I
36	MB138	Mirage III	CP185	Comfort Zone III
43	MB141	Reflection	CP186	Stillness Within
48	MB140	Allure	CP187	Open Fields

PHENIX

SIGNATURE HOME
WITH MICROBAN

FCA NETWORK



Surfaces treated with Microban technology remain 99% cleaner from the growth of bacteria and odors than untreated surfaces.



Microban technology protects 24/7 against the growth of bacteria, mold and mildew that can cause stains, odors and product deterioration.



Wing Cards 24x36

Option 1 **Cards Only** includes 23 wing cards
Send any order to **Tonya Gaddis**

Option 2 **Display + Cards** includes display graphics
and 23 wing cards
Send any order to **Tonya Gaddis**

Update Kit **Cards Only**
Contact **Tonya Gaddis**
Tonya.Gaddis@phenixflooring.com

PHENIX

SIGNATURE
HOME
WITH MICROBAN

FCA NETWORK



Surfaces treated with Microban technology remain 99% cleaner from the growth of bacteria and odors than untreated surfaces.



Microban technology protects 24/7 against the growth of bacteria, mold and mildew that can cause stains, odors and product deterioration.



PIN	FCA STYLE NAME	MILL STYLE NAME
L1	Walking on Air	Memento
L2	Smitten Kitten/Puppy Love	Mesh/Aura
L3	Music City/Nashville	First Light/Daybreak
L6	Paths of Jupiter/ Over the Moon	Tabernacle/ Lincoln Hall
L8	Soul Man/Iron Sky	Idyllic/Eubllient
L9	Summer Solstice	Ryman
L10	Halley's Comet	Elegance
L11	Twice as Nice/Gateway	Amarillo/El Dorado
L12	Misty Blue/Superstition	Cashmere/Merino
R1	Fine & Dandy/Bluegrass	Accolades/Tribute
R2	Magnolias/Nightscape	Insight/Intellect
R3	West End	Epiphany
R4	Winter's Tale	Desire
R5	Eternal City	Yearn
R6	Second to None/Warm Welcome	Succeed/Surpass
R7	Always in Season/Claim to Fame	Achieve/Attain
R8	American Beauty	Conjure
R9	Pot of Gold	Aspire
R10	Risk Taker I/Risk Taker II	Mateo/Emerson
R11	Free Yourself I/Free Yourself II	Luxe/Bougie

PHENIX

UNIVERSAL DISPLAY

FLOORS & MORE

MICROBAN



Surfaces treated with Microban technology remain 99% cleaner from the growth of bacteria and odors than untreated surfaces.



Microban technology protects 24/7 against the growth of bacteria, mold and mildew that can cause stains, odors and product deterioration.



Lifescape Designs



Landmark Collection



Eternally

PHENIX STYLE # & NAME	F&M STYLE #	F&M STYLE NAME	FIXTURE
MB122 Amarillo	FM108	Dealers Choice	Lifescape Designs
MB123 El Dorado	FM107	Competitive Advantage	Lifescape Designs
MB127 Cashmere	FM100	Top Pick	Lifescape Designs
MB128 Merino	FM101	Top Choice	Lifescape Designs
N175 Aurora	FM102	Enviably Choice	Lifescape Designs
N176 Solstice	FM103	Enviably Selection	Lifescape Designs
N243 Etched	FM109	Noteworthy	Lifescape Designs
FP010 Sorrento	FM600	Glamorous I	Landmark Collection
FP009 Portofino	FM601	Glamorous II	Landmark Collection
FE114 Attain	FM602	Limitless	Eternally
FE113 Achieve	FM603	Prime	Eternally
FP025 Maxwell	FM604	Enduring	Eternally
FP024 Mykonos	FM605	Evermore	Eternally
FP022 Luxe	FM606	Proven	Eternally
FP021 Bougie	FM607	Approval	Eternally
FP020 Palermo	FM608	Lifelong	Eternally
FP019 Catania	FM609	Lifetime	Eternally
FP018 Bari	FM610	Livelihood	Eternally

Fixtures and cards are managed by Floors & More Corp.
Please have dealer contact their corporate office for more info.

PHENIX



PHENIX FloorSure™ PetPlus

Phenix Flooring + NFA Warranty

Built to withstand the “uh-ohs” that come with furry family members, 24/7, with enhanced pet performance and exceptional warranties for stain and spill protection, as well as product durability.



24/7
SURFACE
PROTECTION

99%
CLEANER



Lifetime* Limited Warranty Coverage

- Lifetime Limited Stain Resistance (Includes Resistance to pet urine, vomit, and feces stains)
- Lifetime Limited Soil Resistance
- Lifetime Limited Anti-Static
- Lifetime Limited Fade Resistance
- Lifetime Limited Manufacturing Defects
- 25 Year Limited Texture Retention
- 25 Year Limited Abrasive Wear
- 120 Days Customer Satisfaction

**Regular professional cleaning required to keep warranty valid.*



DIMENSIONS:

Depth 19 5/16" | Width 74 3/8" | Height 71 1/16"



Enhanced Pet Protection



Stain + Spill Protection



Durability Guaranteed



Kid Friendly



120 Day Satisfaction



Warranted for Stairs



Asthma & Allergy Friendly*



SureSoftSDN™
Cationic Solution Dyed Nylon

Fixtures & Card \$499

SAP #: 532290

5 Card Update (2025)

SAP #:



CARPET ONE



ROOM BY ROOM



Mannington.

PHENIX

Microban® Polyester Solution Dyed Carpet

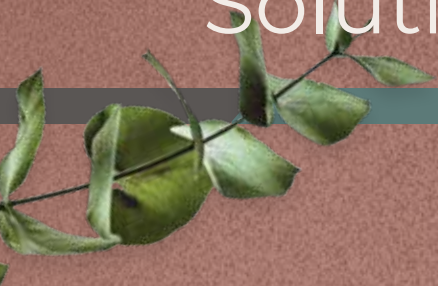

Microban® Polyester Solution Dyed Carpet

The carpets in the Microban® Polyester collection feature Microban® Surface Protection, helping to protect 24/7 against the growth of bacteria, mold, and mildew, and remain 99% cleaner than untreated surfaces. They also feature SureSoftSD™ solution-dyed polyester fibers, which are exceptionally soft, stain and soil resistant, making it easy to clean and maintain, and they're fade resistant, ensuring the carpet won't fade in the sun.

FARM TOP CELLAR I



Farm Top Cellar I
Vault
CO10001727
Pin No. 01727



Farm Top Cellar I
Chardonnay
CO10001718
Pin No. 01718



Farm Top Cellar I
Sweetrose
CO10001868
Pin No. 01868



Farm Top Cellar I
Savory
CO10001869
Pin No. 01869



Farm Top Cellar I
Merlot
CO10001937
Pin No. 01937



Farm Top Cellar I
Vintage
CO10001719
Pin No. 01719

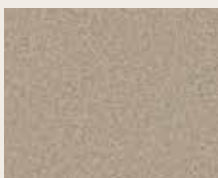

Farm Top Cellar I
Tulip
CO10001728
Pin No. 01728



Farm Top Cellar I
Bordeau
CO10001989
Pin No. 01989

PRODUCT BENEFITS

MICROBAN®

24/7
SURFACE
PROTECTION

99%
CLEANER



KID & PET FRIENDLY



EASY TO CLEAN & MAINTAIN



FADE & STAIN RESISTANT



MADE IN THE USA



ASTHMA + ALLERGY FRIENDLY



GREEN LABEL PLUS

	MICROBAN® POLYESTER	SHAW	MOHAWK	STAINMASTER	ENGINEERED FLOORS
MICROBAN® SURFACE PROTECTION	✓	✗	✗	✗	✗
DESIGNED BY MANNINGTON'S AWARD-WINNING STYLE TEAM	✓	✗	✗	✗	✗
ALL SOLUTION DYED FIBERS	✓	✗	✗	✗	✓
ALL BLEACH RESISTANT	✓	✗	✗	✗	✓
NO DYE LOTS	✓	✗	✗	✗	✓

PROUDLY MADE IN
USA

SureSoftSD™

Microban® Polyester Solution Dyed Carpet

The carpets in the Microban® Polyester collection feature Microban® Surface Protection, helping to protect 24/7 against the growth of bacteria, mold, and mildew, and remain 99% cleaner than untreated surfaces. They also feature SureSoftSD™ solution-dyed polyester fibers, which are exceptionally soft, stain and soil resistant, making it easy to clean and maintain, and they're fade resistant, ensuring the carpet won't fade in the sun.

FARM TOP CELLAR I



Farm Top Cellar I
French
CO10001929
Pin No. 01929



Farm Top Cellar I
Beaujolais
CO10001979
Pin No. 01979



Farm Top Cellar I
Chablis
CO10001738
Pin No. 01738



Farm Top Cellar I
Sherry
CO10001859
Pin No. 01859



Farm Top Cellar I
Cabernet
CO10001969
Pin No. 01969



Farm Top Cellar I
Zinfandel
CO10001919
Pin No. 01919



Farm Top Cellar I
Flute
CO10001948
Pin No. 01948

PRODUCT BENEFITS

MICROBAN®

24/7
SURFACE
PROTECTION

99%
CLEANER



KID & PET FRIENDLY



EASY TO CLEAN & MAINTAIN



FADE & STAIN RESISTANT



MADE IN THE USA



ASTHMA + ALLERGY FRIENDLY



GREEN LABEL PLUS

	MICROBAN® POLYESTER	SHAW	MOHAWK	STAINMASTER	ENGINEERED FLOORS
MICROBAN® SURFACE PROTECTION	✓	✗	✗	✗	✗
DESIGNED BY MANNINGTON'S AWARD-WINNING STYLE TEAM	✓	✗	✗	✗	✗
ALL SOLUTION DYED FIBERS	✓	✗	✗	✗	✓
ALL BLEACH RESISTANT	✓	✗	✗	✗	✓
NO DYE LOTS	✓	✗	✗	✗	✓



SureSoftSD™

Microban® Polyester Solution Dyed Carpet

The carpets in the Microban® Polyester collection feature Microban® Surface Protection, helping to protect 24/7 against the growth of bacteria, mold, and mildew, and remain 99% cleaner than untreated surfaces. They also feature SureSoftSD™ solution-dyed polyester fibers, which are exceptionally soft, stain and soil resistant, making it easy to clean and maintain, and they're fade resistant, ensuring the carpet won't fade in the sun.

FARM TOP CELLAR II



Farm Top Cellar II
Vault
CO10101727
Pin No. 01727



Farm Top Cellar II
Chardonnay
CO10101718
Pin No. 01718



Farm Top Cellar II
Sweetrose
CO10101868
Pin No. 01868



Farm Top Cellar II
Savory
CO10101869
Pin No. 01869



Farm Top Cellar II
Merlot
CO10101937
Pin No. 01937



Farm Top Cellar II
Vintage
CO10101719
Pin No. 01719

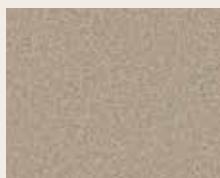

Farm Top Cellar II
Tulip
CO10101728
Pin No. 01728



Farm Top Cellar II
Bordeau
CO10101989
Pin No. 01989

PRODUCT BENEFITS

MICROBAN®

24/7
SURFACE
PROTECTION

99%
CLEANER



KID & PET FRIENDLY



EASY TO CLEAN & MAINTAIN



FADE & STAIN RESISTANT



MADE IN THE USA



ASTHMA + ALLERGY FRIENDLY



GREEN LABEL PLUS

	MICROBAN® POLYESTER	SHAW	MOHAWK	STAINMASTER	ENGINEERED FLOORS
MICROBAN® SURFACE PROTECTION	✓	✗	✗	✗	✗
DESIGNED BY MANNINGTON'S AWARD-WINNING STYLE TEAM	✓	✗	✗	✗	✗
ALL SOLUTION DYED FIBERS	✓	✗	✗	✗	✓
ALL BLEACH RESISTANT	✓	✗	✗	✗	✓
NO DYE LOTS	✓	✗	✗	✗	✓



SureSoftSD™

Microban® Polyester Solution Dyed Carpet

The carpets in the Microban® Polyester collection feature Microban® Surface Protection, helping to protect 24/7 against the growth of bacteria, mold, and mildew, and remain 99% cleaner than untreated surfaces. They also feature SureSoftSD™ solution-dyed polyester fibers, which are exceptionally soft, stain and soil resistant, making it easy to clean and maintain, and they're fade resistant, ensuring the carpet won't fade in the sun.

FARM TOP CELLAR II



Farm Top Cellar II
French
CO10101929
Pin No. 01929



Farm Top Cellar II
Beaujolais
CO10101979
Pin No. 01979



Farm Top Cellar II
Chablis
CO10101738
Pin No. 01738



Farm Top Cellar II
Sherry
CO10101859
Pin No. 01859



Farm Top Cellar II
Cabernet
CO10101969
Pin No. 01969



Farm Top Cellar II
Zinfandel
CO10101919
Pin No. 01919



Farm Top Cellar II
Flute
CO10101948
Pin No. 01948

PRODUCT BENEFITS

MICROBAN®

24/7
SURFACE
PROTECTION

99%
CLEANER



KID & PET FRIENDLY



EASY TO CLEAN & MAINTAIN



FADE & STAIN RESISTANT



MADE IN THE USA



ASTHMA + ALLERGY FRIENDLY



GREEN LABEL PLUS

	MICROBAN® POLYESTER	SHAW	MOHAWK	STAINMASTER	ENGINEERED FLOORS
MICROBAN® SURFACE PROTECTION	✓	✗	✗	✗	✗
DESIGNED BY MANNINGTON'S AWARD-WINNING STYLE TEAM	✓	✗	✗	✗	✗
ALL SOLUTION DYED FIBERS	✓	✗	✗	✗	✓
ALL BLEACH RESISTANT	✓	✗	✗	✗	✓
NO DYE LOTS	✓	✗	✗	✗	✓



SureSoftSD™

Microban® Polyester Solution Dyed Carpet

The carpets in the Microban® Polyester collection feature Microban® Surface Protection, helping to protect 24/7 against the growth of bacteria, mold, and mildew, and remain 99% cleaner than untreated surfaces. They also feature SureSoftSD™ solution-dyed polyester fibers, which are exceptionally soft, stain and soil resistant, making it easy to clean and maintain, and they're fade resistant, ensuring the carpet won't fade in the sun.

FERRIS FARMS



Ferris Farms
Range
CO10201923
Pin No. 01923



Ferris Farms
Vineyard
CO10201968
Pin No. 01968



Ferris Farms
Village
CO10201739
Pin No. 01739



Ferris Farms
Prairie
CO10201744
Pin No. 01744



Ferris Farms
Town
CO10201852
Pin No. 01852



Ferris Farms
Plantation
CO10201711
Pin No. 01711



Ferris Farms
Estate
CO10201945
Pin No. 01945



Ferris Farms
Harvest
CO10201724
Pin No. 01724

PRODUCT BENEFITS

MICROBAN®

24/7
SURFACE
PROTECTION

99%
CLEANER



KID & PET FRIENDLY



EASY TO CLEAN & MAINTAIN



FADE & STAIN RESISTANT



MADE IN THE USA



ASTHMA + ALLERGY FRIENDLY



GREEN LABEL PLUS

	MICROBAN® POLYESTER	SHAW	MOHAWK	STAINMASTER	ENGINEERED FLOORS
MICROBAN® SURFACE PROTECTION	✓	✗	✗	✗	✗
DESIGNED BY MANNINGTON'S AWARD-WINNING STYLE TEAM	✓	✗	✗	✗	✗
ALL SOLUTION DYED FIBERS	✓	✗	✗	✗	✓
ALL BLEACH RESISTANT	✓	✗	✗	✗	✓
NO DYE LOTS	✓	✗	✗	✗	✓

PROUDLY MADE IN
USA

SureSoftSD™

Microban® Polyester Solution Dyed Carpet

The carpets in the Microban® Polyester collection feature Microban® Surface Protection, helping to protect 24/7 against the growth of bacteria, mold, and mildew, and remain 99% cleaner than untreated surfaces. They also feature SureSoftSD™ solution-dyed polyester fibers, which are exceptionally soft, stain and soil resistant, making it easy to clean and maintain, and they're fade resistant, ensuring the carpet won't fade in the sun.

PRIMA DONNA DANDY



Prima Donna Dandy
First
CO5010101
Pin No. 0101



Prima Donna Dandy
Leading
CO5010102
Pin No. 0102

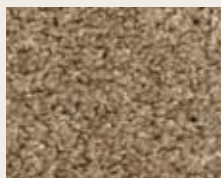

Prima Donna Dandy
Star
CO5010103
Pin No. 0103

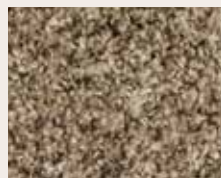

Prima Donna Dandy
Impression
CO5010104
Pin No. 0104



Prima Donna Dandy
Scene
CO5010105
Pin No. 0105

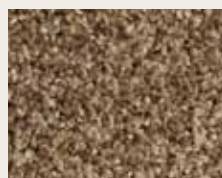

Prima Donna Dandy
Mask
CO5010106
Pin No. 0106



Prima Donna Dandy
Diva
CO5010107
Pin No. 0107



Prima Donna Dandy
Mimic
CO5010108
Pin No. 0108



Prima Donna Dandy
Drama
CO5010109
Pin No. 0109

PRODUCT BENEFITS

MICROBAN®

24/7
SURFACE
PROTECTION

99%
CLEANER



KID & PET FRIENDLY



EASY TO CLEAN & MAINTAIN



FADE & STAIN RESISTANT



MADE IN THE USA



ASTHMA + ALLERGY FRIENDLY



GREEN LABEL PLUS

	MICROBAN® POLYESTER	SHAW	MOHAWK	STAINMASTER	ENGINEERED FLOORS
MICROBAN® SURFACE PROTECTION	✓	✗	✗	✗	✗
DESIGNED BY MANNINGTON'S AWARD-WINNING STYLE TEAM	✓	✗	✗	✗	✗
ALL SOLUTION DYED FIBERS	✓	✗	✗	✗	✓
ALL BLEACH RESISTANT	✓	✗	✗	✗	✓
NO DYE LOTS	✓	✗	✗	✗	✓

PROUDLY MADE IN
USA

SureSoftSD™

Microban® Polyester Solution Dyed Carpet

The carpets in the Microban® Polyester collection feature Microban® Surface Protection, helping to protect 24/7 against the growth of bacteria, mold, and mildew, and remain 99% cleaner than untreated surfaces. They also feature SureSoftSD™ solution-dyed polyester fibers, which are exceptionally soft, stain and soil resistant, making it easy to clean and maintain, and they're fade resistant, ensuring the carpet won't fade in the sun.

PRIMA DONNA PREMIER



Prima Donna Premier
First
CO5020101
Pin No. 0101



Prima Donna Premier
Leading
CO5020102
Pin No. 0102



Prima Donna Premier
Star
CO5020103
Pin No. 0103

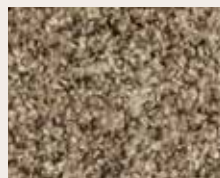

Prima Donna Premier
Impression
CO5020104
Pin No. 0104



Prima Donna Premier
Scene
CO5020105
Pin No. 0105



Prima Donna Premier
Mask
CO5020106
Pin No. 0106



Prima Donna Premier
Diva
CO5020107
Pin No. 0107



Prima Donna Premier
Mimic
CO5020108
Pin No. 0108



Prima Donna Premier
Drama
CO5020109
Pin No. 0109

PRODUCT BENEFITS

MICROBAN®

24/7
SURFACE
PROTECTION

99%
CLEANER



KID & PET FRIENDLY



EASY TO CLEAN & MAINTAIN



FADE & STAIN RESISTANT



MADE IN THE USA



ASTHMA + ALLERGY FRIENDLY



GREEN LABEL PLUS

	MICROBAN® POLYESTER	SHAW	MOHAWK	STAINMASTER	ENGINEERED FLOORS
MICROBAN® SURFACE PROTECTION	✓	✗	✗	✗	✗
DESIGNED BY MANNINGTON'S AWARD-WINNING STYLE TEAM	✓	✗	✗	✗	✗
ALL SOLUTION DYED FIBERS	✓	✗	✗	✗	✓
ALL BLEACH RESISTANT	✓	✗	✗	✗	✓
NO DYE LOTS	✓	✗	✗	✗	✓



SureSoftSD™

Microban® Polyester Solution Dyed Carpet

The carpets in the Microban® Polyester collection feature Microban® Surface Protection, helping to protect 24/7 against the growth of bacteria, mold, and mildew, and remain 99% cleaner than untreated surfaces. They also feature SureSoftSD™ solution-dyed polyester fibers, which are exceptionally soft, stain and soil resistant, making it easy to clean and maintain, and they're fade resistant, ensuring the carpet won't fade in the sun.

PRIMA DONNA



Prima Donna
First
CO5000101
Pin No. 0101



Prima Donna
Leading
CO5000102
Pin No. 0102

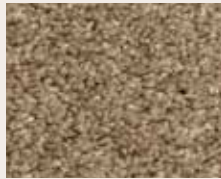

Prima Donna
Star
CO5000103
Pin No. 0103



Prima Donna
Impression
CO5000104
Pin No. 0104



Prima Donna
Scene
CO5000105
Pin No. 0105



Prima Donna
Mask
CO5000106
Pin No. 0106



Prima Donna
Diva
CO5000107
Pin No. 0107



Prima Donna
Mimic
CO5000108
Pin No. 0108



Prima Donna
Drama
CO5000109
Pin No. 0109

PRODUCT BENEFITS

MICROBAN®



24/7
SURFACE
PROTECTION

99%
CLEANER



KID & PET FRIENDLY



EASY TO CLEAN & MAINTAIN



FADE & STAIN RESISTANT



MADE IN THE USA



ASTHMA + ALLERGY FRIENDLY



GREEN LABEL PLUS

	MICROBAN® POLYESTER	SHAW	MOHAWK	STAINMASTER	ENGINEERED FLOORS
MICROBAN® SURFACE PROTECTION	✓	✗	✗	✗	✗
DESIGNED BY MANNINGTON'S AWARD-WINNING STYLE TEAM	✓	✗	✗	✗	✗
ALL SOLUTION DYED FIBERS	✓	✗	✗	✗	✓
ALL BLEACH RESISTANT	✓	✗	✗	✗	✓
NO DYE LOTS	✓	✗	✗	✗	✓

PROUDLY MADE IN
USA

SureSoftSD™



Nylon Solution Dyed Carpet



PHENIX Nylon Solution Dyed Carpet

Our nylon solution dyed carpets are built to withstand the “uh-ohs” that come with furry family members, 24/7, with enhanced pet performance and exceptional warranties for stain and spill protection, as well as product durability. This carpet is warranted for stairs and features Microban® Surface Protection, helping to protect 24/7 against the growth of bacteria, mold and mildew, and remain 99% cleaner than untreated surfaces.

STRIKER BLAZE I



Stricker Blaze I
Brilliant
CO60201957
Pin No. 01957



Stricker Blaze I
Force
CO60201913
Pin No. 01913

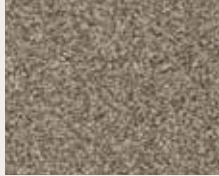

Stricker Blaze I
Aim
CO60201912
Pin No. 01912



Stricker Blaze I
Illuminance
CO60201934
Pin No. 01934



Stricker Blaze I
Afterglow
CO60201911
Pin No. 01911



Stricker Blaze I
Flash
CO60201922
Pin No. 01922



Stricker Blaze I
Luster
CO60201721
Pin No. 01721



Stricker Blaze I
Splendor
CO60201712
Pin No. 01712



Stricker Blaze I
Taper
CO60201865
Pin No. 01865

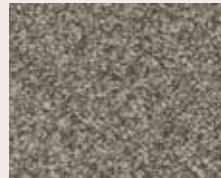

Stricker Blaze I
Zap
CO60201965
Pin No. 01965



Stricker Blaze I
Dawn
CO60201856
Pin No. 01856



Stricker Blaze I
Glee
CO60201985
Pin No. 01985

PRODUCT BENEFITS



ENHANCED PET PROTECTION



STAIN + SPILL PROTECTION



DURABILITY GUARANTEED



KID FRIENDLY



100 DAY SATISFACTION



WARRANTED FOR STAIRS



ASTHMA + ALLERGY FRIENDLY



SureSoftSDN™
Solution Dyed Cationic Nylon

P H E N I X Nylon Solution Dyed Carpet

Our nylon solution dyed carpets are built to withstand the “uh-ohs” that come with furry family members, 24/7, with enhanced pet performance and exceptional warranties for stain and spill protection, as well as product durability. This carpet is warranted for stairs and features Microban® Surface Protection, helping to protect 24/7 against the growth of bacteria, mold and mildew, and remain 99% cleaner than untreated surfaces.

STRIKER BLAZE II

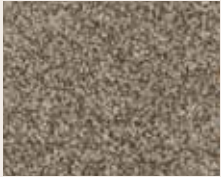

Stricker Blaze II
Brilliant
CO60301957
Pin No. 01957

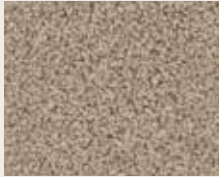

Stricker Blaze II
Force
CO60301913
Pin No. 01913

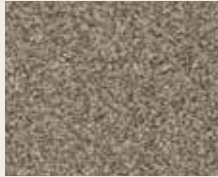

Stricker Blaze II
Aim
CO60301912
Pin No. 01912

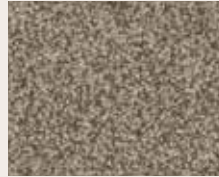

Stricker Blaze II
Illuminance
CO60301934
Pin No. 01934



Stricker Blaze II
Afterglow
CO60301911
Pin No. 01911



Stricker Blaze II
Flash
CO60301922
Pin No. 01922



Stricker Blaze II
Luster
CO60301721
Pin No. 01721



Stricker Blaze II
Splendor
CO60301712
Pin No. 01712



Stricker Blaze II
Taper
CO60301865
Pin No. 01865



Stricker Blaze II
Zap
CO60301965
Pin No. 01965



Stricker Blaze II
Dawn
CO60301856
Pin No. 01856



Stricker Blaze II
Glee
CO60301985
Pin No. 01985

PRODUCT BENEFITS



ENHANCED PET PROTECTION



STAIN + SPILL PROTECTION



DURABILITY GUARANTEED



KID FRIENDLY



100 DAY SATISFACTION



WARRANTED FOR STAIRS



ASTHMA + ALLERGY FRIENDLY



SureSoftSDN™
Solution Dyed Cationic Nylon

PHENIX Nylon Solution Dyed Carpet

Our nylon solution dyed carpets are built to withstand the “uh-ohs” that come with furry family members, 24/7, with enhanced pet performance and exceptional warranties for stain and spill protection, as well as product durability. This carpet is warranted for stairs and features Microban® Surface Protection, helping to protect 24/7 against the growth of bacteria, mold and mildew, and remain 99% cleaner than untreated surfaces.

ROSSON GULLEY



Rosson Gully
Boulder
CO60601931
Pin No. 01931



Rosson Gully
Chestnut
CO60601859
Pin No. 01859



Rosson Gully
Dove
CO60601999
Pin No. 01999



Rosson Gully
Haze
CO60601959
Pin No. 01959



Rosson Gully
Pebble
CO60601909
Pin No. 01909



Rosson Gully
Metal
CO60601978
Pin No. 01978



Rosson Gully
Sandbag
CO60601837
Pin No. 01837



Rosson Gully
Masonry
CO60601727
Pin No. 01727



Rosson Gully
Brook
CO60601561
Pin No. 01561

PRODUCT BENEFITS



ENHANCED PET PROTECTION



STAIN + SPILL PROTECTION



DURABILITY GUARANTEED



KID FRIENDLY



100 DAY SATISFACTION



WARRANTED FOR STAIRS



ASTHMA + ALLERGY FRIENDLY



SureSoftSDN™
Solution Dyed Cationic Nylon

PHENIX Nylon Solution Dyed Carpet

Our nylon solution dyed carpets are built to withstand the “uh-ohs” that come with furry family members, 24/7, with enhanced pet performance and exceptional warranties for stain and spill protection, as well as product durability. This carpet is warranted for stairs and features Microban® Surface Protection, helping to protect 24/7 against the growth of bacteria, mold and mildew, and remain 99% cleaner than untreated surfaces.

WOODBURN GLOW

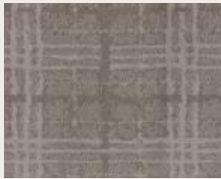

Woodburn Glow
Ember
CO60501859
Pin No. 01859



Woodburn Glow
Clouds
CO60501959
Pin No. 01959



Woodburn Glow
Glistening
CO60501837
Pin No. 01837

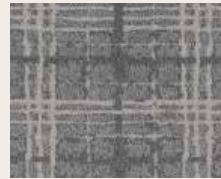

Woodburn Glow
Shipper
CO60501561
Pin No. 01561



Woodburn Glow
Spark
CO60501727
Pin No. 01727



Woodburn Glow
Sparkle
CO60501978
Pin No. 01978



Woodburn Glow
Gleam
CO60501909
Pin No. 01909



Woodburn Glow
Radiate
CO60501931
Pin No. 01931



Woodburn Glow
Basking
CO60501999
Pin No. 01999

PRODUCT BENEFITS



 ENHANCED PET PROTECTION

 STAIN + SPILL PROTECTION

 DURABILITY GUARANTEED

 KID FRIENDLY

 100 DAY SATISFACTION

 WARRANTED FOR STAIRS

 ASTHMA + ALLERGY FRIENDLY



SureSoftSDN™
Solution Dyed Cationic Nylon

PHENIX Nylon Solution Dyed Carpet

Our nylon solution dyed carpets are built to withstand the “uh-ohs” that come with furry family members, 24/7, with enhanced pet performance and exceptional warranties for stain and spill protection, as well as product durability. This carpet is warranted for stairs and features Microban® Surface Protection, helping to protect 24/7 against the growth of bacteria, mold and mildew, and remain 99% cleaner than untreated surfaces.

HENDERSON URBAN I



Henderson Urban I
Ocean View
CO60001133
Pin No. 01133



Henderson Urban I
Sand Castle
CO60001966
Pin No. 01966



Henderson Urban I
Sunbeam
CO60001122
Pin No. 01122



Henderson Urban I
Wave
CO60001987
Pin No. 01987

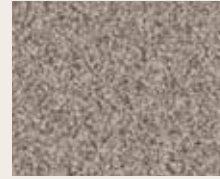

Henderson Urban I
Pier
CO60001731
Pin No. 01731



Henderson Urban I
Island
CO60001936
Pin No. 01936



Henderson Urban I
Beach
CO60001924
Pin No. 01924



Henderson Urban I
Seashell
CO60001748
Pin No. 01748



Henderson Urban I
Tropical
CO60001854
Pin No. 01854



Henderson Urban I
Breeze
CO60001742
Pin No. 01742



Henderson Urban I
Palm Tree
CO60001813
Pin No. 01813



Henderson Urban I
Star Fish
CO60001825
Pin No. 01825

PRODUCT BENEFITS



ENHANCED PET PROTECTION



STAIN + SPILL PROTECTION



DURABILITY GUARANTEED



KID FRIENDLY



100 DAY SATISFACTION



WARRANTED FOR STAIRS



ASTHMA + ALLERGY FRIENDLY



SureSoftSDN™
Solution Dyed Cationic Nylon

PHENIX Nylon Solution Dyed Carpet

Our nylon solution dyed carpets are built to withstand the “uh-ohs” that come with furry family members, 24/7, with enhanced pet performance and exceptional warranties for stain and spill protection, as well as product durability. This carpet is warranted for stairs and features Microban® Surface Protection, helping to protect 24/7 against the growth of bacteria, mold and mildew, and remain 99% cleaner than untreated surfaces.

HENDERSON URBAN II



Henderson Urban II
Ocean View
CO60101133
Pin No. 01133



Henderson Urban II
Sand Castle
CO60101966
Pin No. 01966



Henderson Urban II
Sunbeam
CO60101122
Pin No. 01122



Henderson Urban II
Wave
CO60101987
Pin No. 01987

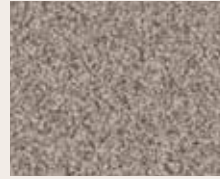

Henderson Urban II
Pier
CO60101731
Pin No. 01731



Henderson Urban II
Island
CO60101936
Pin No. 01936



Henderson Urban II
Beach
CO60001924
Pin No. 01924

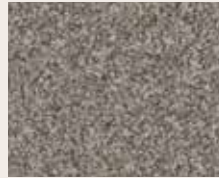

Henderson Urban II
Seashell
CO60101748
Pin No. 01748



Henderson Urban II
Tropical
CO60101854
Pin No. 01854



Henderson Urban II
Breeze
CO60101742
Pin No. 01742



Henderson Urban II
Palm Tree
CO60101813
Pin No. 01813



Henderson Urban II
Star Fish
CO60101825
Pin No. 01825

PRODUCT BENEFITS



ENHANCED PET PROTECTION



STAIN + SPILL PROTECTION



DURABILITY GUARANTEED



KID FRIENDLY



100 DAY SATISFACTION



WARRANTED FOR STAIRS



ASTHMA + ALLERGY FRIENDLY



SureSoftSDN™
Solution Dyed Cationic Nylon

PHENIX Nylon Solution Dyed Carpet

Our nylon solution dyed carpets are built to withstand the “uh-ohs” that come with furry family members, 24/7, with enhanced pet performance and exceptional warranties for stain and spill protection, as well as product durability. This carpet is warranted for stairs and features Microban® Surface Protection, helping to protect 24/7 against the growth of bacteria, mold and mildew, and remain 99% cleaner than untreated surfaces.

STANLEY PARK



Stanley Park
Play Ground
CO60401748
Pin No. 01748

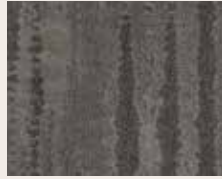

Stanley Park
Plaza
CO60401889
Pin No. 01889



Stanley Park
Slide
CO60401733
Pin No. 01733



Stanley Park
Amusement
CO60401959
Pin No. 01959



Stanley Park
Skyward
CO60401999
Pin No. 01999



Stanley Park
Recreation
CO60401719
Pin No. 01719



Stanley Park
Monument
CO60401859
Pin No. 01859



Stanley Park
Country
CO60401165
Pin No. 01165



Stanley Park
Pavilion
CO60401727
Pin No. 01727



Stanley Park
Riverside
CO60401919
Pin No. 01919

PRODUCT BENEFITS



ENHANCED PET PROTECTION



STAIN + SPILL PROTECTION



DURABILITY GUARANTEED



KID FRIENDLY



100 DAY SATISFACTION



WARRANTED FOR STAIRS



ASTHMA + ALLERGY FRIENDLY



SureSoftSDN™
Solution Dyed Cationic Nylon

SureSoftSD™

SureSoftSDN™

Solution Dyed Cationic Nylon

All Phenix Carpets Feature Solution Dyed Fibers

The difference is our Solution Dyed Fibers. Carpets made with solution dyed fibers look newer, longer. A solution dyed fiber's color is all the way through the fiber, like a carrot. Surface dyed fibers only have the color on the outside of the fiber, like a radish.

The benefit of having the color all the way through the fiber is the color of the carpet lasts longer. It resists stains, fading, and wear and tear. Surface dyed fibers become dull over time because the color is worn away.

We create two types of solution dyed fibers:

- **SureSoftSDN™** – A special solution dyed cationic nylon fiber
- **SureSoftSD™** – A solution dyed polyester fiber

SureSoftSDN™ — Solution Dyed Cationic Nylon

Livable luxury is the best way to describe SureSoftSDN™ carpet fibers. This state of the art fiber provides inherent stain, soil, and fade resistance while maintaining superior protection for your home. Bring on the kids and pets, this durable nylon fiber will bounce back time and time again to ensure your carpet looks newer longer.

SureSoftSD™ — Solution Dyed Polyester

Get lost in the feeling of SureSoftSD™ carpet fibers. Excellent stain and soil resistance make it easy to clean and maintain, so relax and enjoy the comfort of your carpet without worries about spills or pet messes. Fade resistance ensures this carpet won't fade in the sun. Rest assured your new carpet will meet all your household needs.

The color is all the way through the fiber, like a carrot.



The color of non solution dyed fibers is only on the surface, like a radish, making the carpet dull over time due to wear.





FLOORING AMERICA

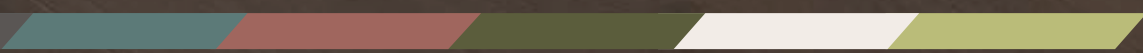

Room to Explore



Mannington | PHENIX

Microban® Polyester Solution Dyed Carpet



Microban® Polyester Solution Dyed Carpet

The carpets in the Microban® Polyester collection feature Microban® Surface Protection, helping to protect 24/7 against the growth of bacteria, mold, and mildew, and remain 99% cleaner than untreated surfaces. They also feature SureSoftSD™ solution-dyed polyester fibers, which are exceptionally soft, stain and soil resistant, making it easy to clean and maintain, and they're fade resistant, ensuring the carpet won't fade in the sun.

BECKETT LOFTY I



Beckett Lofty I
Exalted
FA10072701
Color No. 72701



Beckett Lofty I
Impressive
FA10071801
Color No. 71801



Beckett Lofty I
Grandiose
FA10086801
Color No. 86801



Beckett Lofty I
Stature
FA10086901
Color No. 86901



Beckett Lofty I
Supreme
FA10093701
Color No. 93701



Beckett Lofty I
Distinguished
FA10071901
Color No. 71901



Beckett Lofty I
Cherished
FA10072801
Color No. 72801



Beckett Lofty I
Achieving
FA10098901
Color No. 98901

PRODUCT BENEFITS

MICROBAN®

24/7
SURFACE
PROTECTION

99%
CLEANER



KID & PET FRIENDLY



EASY TO CLEAN & MAINTAIN



FADE & STAIN RESISTANT



MADE IN THE USA



ASTHMA + ALLERGY FRIENDLY



GREEN LABEL PLUS

	MICROBAN® POLYESTER	SHAW	MOHAWK	STAINMASTER	ENGINEERED FLOORS
MICROBAN® SURFACE PROTECTION	✓	✗	✗	✗	✗
DESIGNED BY MANNINGTON'S AWARD-WINNING STYLE TEAM	✓	✗	✗	✗	✗
ALL SOLUTION DYED FIBERS	✓	✗	✗	✗	✓
ALL BLEACH RESISTANT	✓	✗	✗	✗	✓
NO DYE LOTS	✓	✗	✗	✗	✓



SureSoftSD™

Microban® Polyester Solution Dyed Carpet

The carpets in the Microban® Polyester collection feature Microban® Surface Protection, helping to protect 24/7 against the growth of bacteria, mold, and mildew, and remain 99% cleaner than untreated surfaces. They also feature SureSoftSD™ solution-dyed polyester fibers, which are exceptionally soft, stain and soil resistant, making it easy to clean and maintain, and they're fade resistant, ensuring the carpet won't fade in the sun.

BECKETT LOFTY I



Beckett Lofty I
Noble
FA10092901
Color No. 92901



Beckett Lofty I
Ambitious
FA10097901
Color No. 97901



Beckett Lofty I
Idealistic
FA10073801
Color No. 73801



Beckett Lofty I
Admirable
FA10085901
Color No. 85901



Beckett Lofty I
Esteem
FA10096901
Color No. 96901

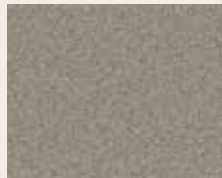

Beckett Lofty I
Majestic
FA10091901
Color No. 91901



Beckett Lofty I
Wisdom
FA10094801
Color No. 94801

PRODUCT BENEFITS

MICROBAN®

24/7
SURFACE
PROTECTION

99%
CLEANER



KID & PET FRIENDLY



EASY TO CLEAN & MAINTAIN



FADE & STAIN RESISTANT



MADE IN THE USA



ASTHMA + ALLERGY FRIENDLY



GREEN LABEL PLUS

	MICROBAN® POLYESTER	SHAW	MOHAWK	STAINMASTER	ENGINEERED FLOORS
MICROBAN® SURFACE PROTECTION	✓	✗	✗	✗	✗
DESIGNED BY MANNINGTON'S AWARD-WINNING STYLE TEAM	✓	✗	✗	✗	✗
ALL SOLUTION DYED FIBERS	✓	✗	✗	✗	✓
ALL BLEACH RESISTANT	✓	✗	✗	✗	✓
NO DYE LOTS	✓	✗	✗	✗	✓



SureSoftSD™

Microban® Polyester Solution Dyed Carpet

The carpets in the Microban® Polyester collection feature Microban® Surface Protection, helping to protect 24/7 against the growth of bacteria, mold, and mildew, and remain 99% cleaner than untreated surfaces. They also feature SureSoftSD™ solution-dyed polyester fibers, which are exceptionally soft, stain and soil resistant, making it easy to clean and maintain, and they're fade resistant, ensuring the carpet won't fade in the sun.

BECKETT LOFTY II



Beckett Lofty II
Exalted
FA10172701
Color No. 72701



Beckett Lofty II
Impressive
FA10171801
Color No. 71801



Beckett Lofty II
Grandiose
FA10186801
Color No. 86801



Beckett Lofty II
Stature
FA10186901
Color No. 86901



Beckett Lofty II
Supreme
FA10193701
Color No. 93701



Beckett Lofty II
Distinguished
FA10171901
Color No. 71901



Beckett Lofty II
Cherished
FA10172801
Color No. 72801



Beckett Lofty II
Achieving
FA10198901
Color No. 98901

PRODUCT BENEFITS

MICROBAN®

24/7
SURFACE
PROTECTION

99%
CLEANER



KID & PET FRIENDLY



EASY TO CLEAN & MAINTAIN



FADE & STAIN RESISTANT



MADE IN THE USA



ASTHMA + ALLERGY FRIENDLY



GREEN LABEL PLUS

	MICROBAN® POLYESTER	SHAW	MOHAWK	STAINMASTER	ENGINEERED FLOORS
MICROBAN® SURFACE PROTECTION	✓	✗	✗	✗	✗
DESIGNED BY MANNINGTON'S AWARD-WINNING STYLE TEAM	✓	✗	✗	✗	✗
ALL SOLUTION DYED FIBERS	✓	✗	✗	✗	✓
ALL BLEACH RESISTANT	✓	✗	✗	✗	✓
NO DYE LOTS	✓	✗	✗	✗	✓



SureSoftSD™

Microban® Polyester Solution Dyed Carpet

The carpets in the Microban® Polyester collection feature Microban® Surface Protection, helping to protect 24/7 against the growth of bacteria, mold, and mildew, and remain 99% cleaner than untreated surfaces. They also feature SureSoftSD™ solution-dyed polyester fibers, which are exceptionally soft, stain and soil resistant, making it easy to clean and maintain, and they're fade resistant, ensuring the carpet won't fade in the sun.

BECKETT LOFTY II



Beckett Lofty II
Noble
FA10192901
Color No. 92901



Beckett Lofty II
Ambitious
FA10197901
Color No. 97901



Beckett Lofty II
Idealistic
FA10173801
Color No. 73801



Beckett Lofty II
Admirable
FA10185901
Color No. 85901



Beckett Lofty II
Esteem
FA10196901
Color No. 96901

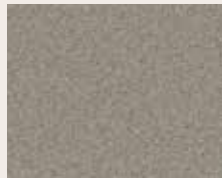

Beckett Lofty II
Majestic
FA10191901
Color No. 91901



Beckett Lofty II
Wisdom
FA10194801
Color No. 94801

PRODUCT BENEFITS

MICROBAN®

24/7
SURFACE
PROTECTION

99%
CLEANER



KID & PET FRIENDLY



EASY TO CLEAN & MAINTAIN



FADE & STAIN RESISTANT



MADE IN THE USA



ASTHMA + ALLERGY FRIENDLY



GREEN LABEL PLUS

	MICROBAN® POLYESTER	SHAW	MOHAWK	STAINMASTER	ENGINEERED FLOORS
MICROBAN® SURFACE PROTECTION	✓	✗	✗	✗	✗
DESIGNED BY MANNINGTON'S AWARD-WINNING STYLE TEAM	✓	✗	✗	✗	✗
ALL SOLUTION DYED FIBERS	✓	✗	✗	✗	✓
ALL BLEACH RESISTANT	✓	✗	✗	✗	✓
NO DYE LOTS	✓	✗	✗	✗	✓



SureSoftSD™

Microban® Polyester Solution Dyed Carpet

The carpets in the Microban® Polyester collection feature Microban® Surface Protection, helping to protect 24/7 against the growth of bacteria, mold, and mildew, and remain 99% cleaner than untreated surfaces. They also feature SureSoftSD™ solution-dyed polyester fibers, which are exceptionally soft, stain and soil resistant, making it easy to clean and maintain, and they're fade resistant, ensuring the carpet won't fade in the sun.

SALLIE FREE



Sallie Free
Complimentary
FA10292301
Color No. 92301



Sallie Free
Unlimited
FA10296801
Color No. 96801



Sallie Free
Easy
FA10273901
Color No. 73901



Sallie Free
Premium
FA10274401
Color No. 74401



Sallie Free
Independence
FA10285201
Color No. 85201



Sallie Free
Choice
FA10271101
Color No. 71101



Sallie Free
Access
FA10294501
Color No. 94501



Sallie Free
Story
FA10272401
Color No. 72401

PRODUCT BENEFITS

MICROBAN®

24/7
SURFACE
PROTECTION

99%
CLEANER



KID & PET FRIENDLY



EASY TO CLEAN & MAINTAIN



FADE & STAIN RESISTANT



MADE IN THE USA



ASTHMA + ALLERGY FRIENDLY



GREEN LABEL PLUS

	MICROBAN® POLYESTER	SHAW	MOHAWK	STAINMASTER	ENGINEERED FLOORS
MICROBAN® SURFACE PROTECTION	✓	✗	✗	✗	✗
DESIGNED BY MANNINGTON'S AWARD-WINNING STYLE TEAM	✓	✗	✗	✗	✗
ALL SOLUTION DYED FIBERS	✓	✗	✗	✗	✓
ALL BLEACH RESISTANT	✓	✗	✗	✗	✓
NO DYE LOTS	✓	✗	✗	✗	✓

PROUDLY MADE IN
USA

SureSoftSD™

Microban® Polyester Solution Dyed Carpet

The carpets in the Microban® Polyester collection feature Microban® Surface Protection, helping to protect 24/7 against the growth of bacteria, mold, and mildew, and remain 99% cleaner than untreated surfaces. They also feature SureSoftSD™ solution-dyed polyester fibers, which are exceptionally soft, stain and soil resistant, making it easy to clean and maintain, and they're fade resistant, ensuring the carpet won't fade in the sun.

TREASURE CHEST PLUS



Treasure Chest Plus Favor
FA5000101
Color No. 0101



Treasure Chest Plus Cherish
FA5000201
Color No. 0201

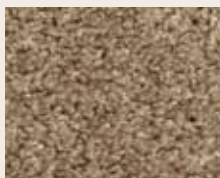

Treasure Chest Plus Adore
FA5000301
Color No. 0301

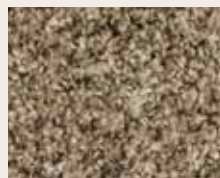

Treasure Chest Plus Prize
FA5000401
Color No. 0401



Treasure Chest Plus Precious
FA5000105
Color No. 0501

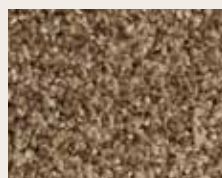

Treasure Chest Plus Esteem
FA5000601
Color No. 0601



Treasure Chest Plus Admire
FA5000701
Color No. 0701



Treasure Chest Plus Delight
FA5000801
Color No. 0801



Treasure Chest Plus Idol
FA5000901
Color No. 0901

PRODUCT BENEFITS

MICROBAN®

24/7
SURFACE
PROTECTION

99%
CLEANER



KID & PET FRIENDLY



EASY TO CLEAN & MAINTAIN



FADE & STAIN RESISTANT



MADE IN THE USA



ASTHMA + ALLERGY FRIENDLY



GREEN LABEL PLUS

	MICROBAN® POLYESTER	SHAW	MOHAWK	STAINMASTER	ENGINEERED FLOORS
MICROBAN® SURFACE PROTECTION	✓	✗	✗	✗	✗
DESIGNED BY MANNINGTON'S AWARD-WINNING STYLE TEAM	✓	✗	✗	✗	✗
ALL SOLUTION DYED FIBERS	✓	✗	✗	✗	✓
ALL BLEACH RESISTANT	✓	✗	✗	✗	✓
NO DYE LOTS	✓	✗	✗	✗	✓



SureSoftSD™

Microban® Polyester Solution Dyed Carpet

The carpets in the Microban® Polyester collection feature Microban® Surface Protection, helping to protect 24/7 against the growth of bacteria, mold, and mildew, and remain 99% cleaner than untreated surfaces. They also feature SureSoftSD™ solution-dyed polyester fibers, which are exceptionally soft, stain and soil resistant, making it easy to clean and maintain, and they're fade resistant, ensuring the carpet won't fade in the sun.

TREASURE CHEST PREMIERE



Treasure Chest Premiere Favor
FA5010101
Color No. 0101



Treasure Chest Premiere Cherish
FA5010201
Color No. 0201

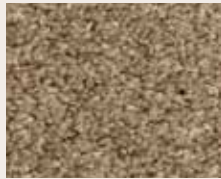

Treasure Chest Premiere Adore
FA5010301
Color No. 0301



Treasure Chest Premiere Prize
FA5010401
Color No. 0401



Treasure Chest Premiere Precious
FA5010105
Color No. 0501



Treasure Chest Premiere Esteem
FA5010601
Color No. 0601



Treasure Chest Premiere Admire
FA5010701
Color No. 0701



Treasure Chest Premiere Delight
FA5010801
Color No. 0801



Treasure Chest Premiere Idol
FA5010901
Color No. 0901

PRODUCT BENEFITS

MICROBAN®

24/7
SURFACE
PROTECTION

99%
CLEANER



KID & PET FRIENDLY



EASY TO CLEAN & MAINTAIN



FADE & STAIN RESISTANT



MADE IN THE USA



ASTHMA + ALLERGY FRIENDLY



GREEN LABEL PLUS

	MICROBAN® POLYESTER	SHAW	MOHAWK	STAINMASTER	ENGINEERED FLOORS
MICROBAN® SURFACE PROTECTION	✓	✗	✗	✗	✗
DESIGNED BY MANNINGTON'S AWARD-WINNING STYLE TEAM	✓	✗	✗	✗	✗
ALL SOLUTION DYED FIBERS	✓	✗	✗	✗	✓
ALL BLEACH RESISTANT	✓	✗	✗	✗	✓
NO DYE LOTS	✓	✗	✗	✗	✓



SureSoftSD™

Microban® Polyester Solution Dyed Carpet

The carpets in the Microban® Polyester collection feature Microban® Surface Protection, helping to protect 24/7 against the growth of bacteria, mold, and mildew, and remain 99% cleaner than untreated surfaces. They also feature SureSoftSD™ solution-dyed polyester fibers, which are exceptionally soft, stain and soil resistant, making it easy to clean and maintain, and they're fade resistant, ensuring the carpet won't fade in the sun.

TREASURE CHEST



Treasure Chest Favor
FA5020101
Color No. 0101



Treasure Chest Cherish
FA5020201
Color No. 0201

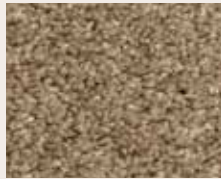

Treasure Chest Adore
FA5020301
Color No. 0301



Treasure Chest Prize
FA5020401
Color No. 0401



Treasure Chest Precious
FA5020105
Color No. 0501



Treasure Chest Esteem
FA5020601
Color No. 0601



Treasure Chest Admire
FA5020701
Color No. 0701



Treasure Chest Delight
FA5020801
Color No. 0801



Treasure Chest Idol
FA5020901
Color No. 0901

PRODUCT BENEFITS

MICROBAN®

24/7
SURFACE
PROTECTION

99%
CLEANER

-  KID & PET FRIENDLY
-  EASY TO CLEAN & MAINTAIN
-  FADE & STAIN RESISTANT
-  MADE IN THE USA
-  ASTHMA + ALLERGY FRIENDLY
-  GREEN LABEL PLUS

	MICROBAN® POLYESTER	SHAW	MOHAWK	STAINMASTER	ENGINEERED FLOORS
MICROBAN® SURFACE PROTECTION	✓	✗	✗	✗	✗
DESIGNED BY MANNINGTON'S AWARD-WINNING STYLE TEAM	✓	✗	✗	✗	✗
ALL SOLUTION DYED FIBERS	✓	✗	✗	✗	✓
ALL BLEACH RESISTANT	✓	✗	✗	✗	✓
NO DYE LOTS	✓	✗	✗	✗	✓

★ PROUDLY MADE IN
USA ★

SureSoftSD™



Nylon Solution Dyed Carpet



PHENIX Nylon Solution Dyed Carpet

Our nylon solution dyed carpets are built to withstand the “uh-ohs” that come with furry family members, 24/7, with enhanced pet performance and exceptional warranties for stain and spill protection, as well as product durability. This carpet is warranted for stairs and features Microban® Surface Protection, helping to protect 24/7 against the growth of bacteria, mold and mildew, and remain 99% cleaner than untreated surfaces.

CAPTAIN BAILY I

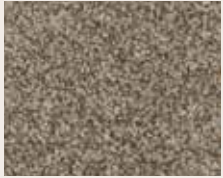

Captain Baily I
Sailing
FA60295701
Color No. 957901

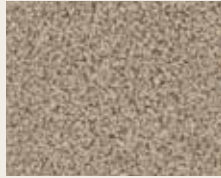

Captain Baily I
Cargo
FA60291301
Color No. 91301

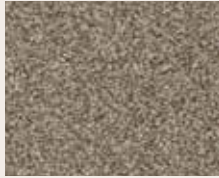

Captain Baily I
Vessel
FA60291201
Color No. 91201

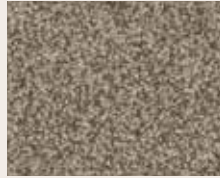

Captain Baily I
Cruiser
FA60293401
Color No. 93401

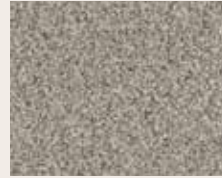

Captain Baily I
Fleet
FA60291101
Color No. 01911



Captain Baily I
Carrier
FA60292201
Color No. 92201

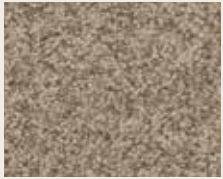

Captain Baily I
Flagship
FA60272101
Color No. 72101



Captain Baily I
Officer
FA60271201
Color No. 71201



Captain Baily I
Commander
FA60286501
Color No. 86501

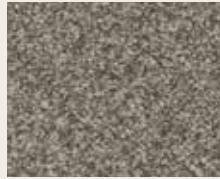

Captain Baily I
Skipper
FA60296501
Color No. 96501



Captain Baily I
Colonel
FA60285601
Color No. 85601

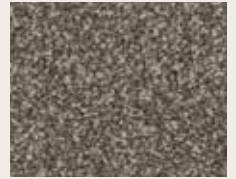

Captain Baily I
Leader
FA60298501
Color No. 98501

PRODUCT BENEFITS



ENHANCED PET PROTECTION



STAIN + SPILL PROTECTION



DURABILITY GUARANTEED



KID FRIENDLY



100 DAY SATISFACTION



WARRANTED FOR STAIRS



ASTHMA + ALLERGY FRIENDLY



SureSoftSDN™
Solution Dyed Cationic Nylon

P H E N I X Nylon Solution Dyed Carpet

Our nylon solution dyed carpets are built to withstand the “uh-ohs” that come with furry family members, 24/7, with enhanced pet performance and exceptional warranties for stain and spill protection, as well as product durability. This carpet is warranted for stairs and features Microban® Surface Protection, helping to protect 24/7 against the growth of bacteria, mold and mildew, and remain 99% cleaner than untreated surfaces.

CAPTAIN BAILY II

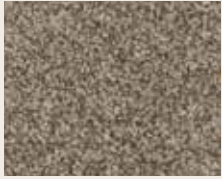

Captain Baily II
Sailing
FA60395701
Color No. 957901

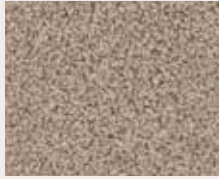

Captain Baily II
Cargo
FA60391301
Color No. 91301

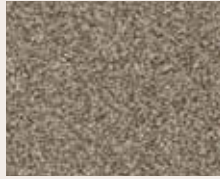

Captain Baily II
Vessel
FA60391201
Color No. 91201

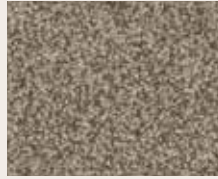

Captain Baily II
Cruiser
FA603293401
Color No. 93401

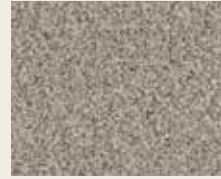

Captain Baily II
Fleet
FA60291101
Color No. 01911



Captain Baily II
Carrier
FA60392201
Color No. 92201

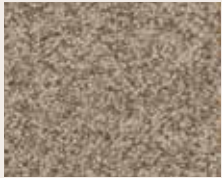

Captain Baily II
Flagship
FA60372101
Color No. 72101



Captain Baily II
Officer
FA60371201
Color No. 71201



Captain Baily II
Commander
FA60386501
Color No. 86501

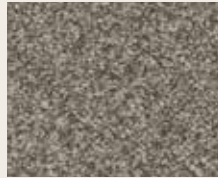

Captain Baily II
Skipper
FA60396501
Color No. 96501



Captain Baily II
Colonel
FA60385601
Color No. 85601

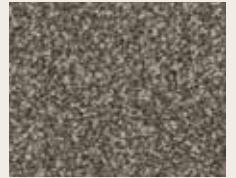

Captain Baily II
Leader
FA60398501
Color No. 98501

PRODUCT BENEFITS



ENHANCED PET PROTECTION



STAIN + SPILL PROTECTION



DURABILITY GUARANTEED



KID FRIENDLY



100 DAY SATISFACTION



WARRANTED FOR STAIRS



ASTHMA + ALLERGY FRIENDLY



SureSoftSDN™
Solution Dyed Cationic Nylon

PHENIX Nylon Solution Dyed Carpet

Our nylon solution dyed carpets are built to withstand the “uh-ohs” that come with furry family members, 24/7, with enhanced pet performance and exceptional warranties for stain and spill protection, as well as product durability. This carpet is warranted for stairs and features Microban® Surface Protection, helping to protect 24/7 against the growth of bacteria, mold and mildew, and remain 99% cleaner than untreated surfaces.

REED FLUTE



Reed Flute
Arrangement
FA60693101
Color No. 93101



Reed Flute
Blad
FA60685901
Color No. 85901



Reed Flute
Classical
FA60699901
Color No. 99901



Reed Flute
Composition
FA60695901
Color No. 95901



Reed Flute
Melody
FA60690901
Color No. 90901



Reed Flute
Harmony
FA60697801
Color No. 97801



Reed Flute
Lyric
FA60683701
Color No. 83701



Reed Flute
Concert
FA60672701
Color No. 72701



Reed Flute
Variation
FA60656101
Color No. 56101

PRODUCT BENEFITS



ENHANCED PET PROTECTION



STAIN + SPILL PROTECTION



DURABILITY GUARANTEED



KID FRIENDLY



100 DAY SATISFACTION



WARRANTED FOR STAIRS



ASTHMA + ALLERGY FRIENDLY



SureSoftSDN™
Solution Dyed Cationic Nylon

PHENIX Nylon Solution Dyed Carpet

Our nylon solution dyed carpets are built to withstand the “uh-ohs” that come with furry family members, 24/7, with enhanced pet performance and exceptional warranties for stain and spill protection, as well as product durability. This carpet is warranted for stairs and features Microban® Surface Protection, helping to protect 24/7 against the growth of bacteria, mold and mildew, and remain 99% cleaner than untreated surfaces.

HAGAR STYLISH



Hagar Stylish
Trendy
FA60585901
Color No. 85901



Hagar Stylish
Classy
FA60595901
Color No. 95901



Hagar Stylish
Snazzy
FA60583701
Color No. 83701

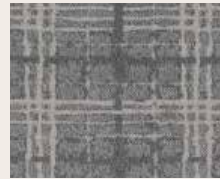

Hagar Stylish
Sleek
FA60556101
Color No. 56101



Hagar Stylish
Glamorous
FA60572701
Color No. 72701



Hagar Stylish
Luxurious
FA60597801
Color No. 97801



Hagar Stylish
Lovely
FA60590901
Color No. 90901



Hagar Stylish
Charming
FA60593101
Color No. 93101



Hagar Stylish
Exquisite
FA60599901
Color No. 99901

PRODUCT BENEFITS



 ENHANCED PET PROTECTION

 STAIN + SPILL PROTECTION

 DURABILITY GUARANTEED

 KID FRIENDLY

 100 DAY SATISFACTION

 WARRANTED FOR STAIRS

 ASTHMA + ALLERGY FRIENDLY



SureSoftSDN™
Solution Dyed Cationic Nylon

PHENIX Nylon Solution Dyed Carpet

Our nylon solution dyed carpets are built to withstand the “uh-ohs” that come with furry family members, 24/7, with enhanced pet performance and exceptional warranties for stain and spill protection, as well as product durability. This carpet is warranted for stairs and features Microban® Surface Protection, helping to protect 24/7 against the growth of bacteria, mold and mildew, and remain 99% cleaner than untreated surfaces.

MCPIKE DESERT I



McPike Desert I
Sandy
FA60013301
Color No. 13301



McPike Desert I
Vast
FA60096601
Color No. 96601



McPike Desert I
Immense
FA60012201
Color No. 12201

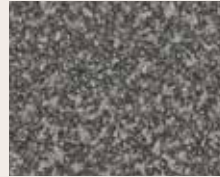

McPike Desert I
Region
FA60098701
Color No. 98701

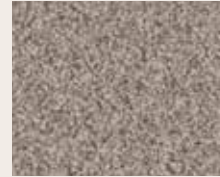

McPike Desert I
Windswept
FA60073101
Color No. 73101



McPike Desert I
Flourish
FA60093601
Color No. 93601



McPike Desert I
Dune
FA60092401
Color No. 92401



McPike Desert I
Sage
FA60074801
Color No. 74801



McPike Desert I
Arid
FA60085401
Color No. 85401



McPike Desert I
Aster
FA60074201
Color No. 74201



McPike Desert I
Blaze
FA60081301
Color No. 81301



McPike Desert I
Hopper
FA60082501
Color No. 82501

PRODUCT BENEFITS



ENHANCED PET PROTECTION



STAIN + SPILL PROTECTION



DURABILITY GUARANTEED



KID FRIENDLY



100 DAY SATISFACTION



WARRANTED FOR STAIRS



ASTHMA + ALLERGY FRIENDLY



SureSoftSDN™
Solution Dyed Cationic Nylon

PHENIX Nylon Solution Dyed Carpet

Our nylon solution dyed carpets are built to withstand the “uh-ohs” that come with furry family members, 24/7, with enhanced pet performance and exceptional warranties for stain and spill protection, as well as product durability. This carpet is warranted for stairs and features Microban® Surface Protection, helping to protect 24/7 against the growth of bacteria, mold and mildew, and remain 99% cleaner than untreated surfaces.

MCPIKE DESERT II



McPike Desert II
Sandy
FA60113301
Color No. 13301



McPike Desert II
Vast
FA60196601
Color No. 96601



McPike Desert II
Immense
FA60112201
Color No. 12201



McPike Desert II
Region
FA60198701
Color No. 98701

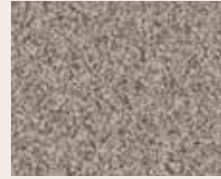

McPike Desert II
Windswept
FA60173101
Color No. 73101



McPike Desert II
Flourish
FA60193601
Color No. 93601



McPike Desert II
Dune
FA60192401
Color No. 92401

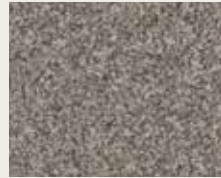

McPike Desert II
Sage
FA60174801
Color No. 74801



McPike Desert II
Arid
FA60185401
Color No. 85401



McPike Desert II
Aster
FA60174201
Color No. 74201



McPike Desert II
Blaze
FA60181301
Color No. 81301



McPike Desert II
Hopper
FA60182501
Color No. 82501

PRODUCT BENEFITS



ENHANCED PET PROTECTION



STAIN + SPILL PROTECTION



DURABILITY GUARANTEED



KID FRIENDLY



100 DAY SATISFACTION



WARRANTED FOR STAIRS



ASTHMA + ALLERGY FRIENDLY



SureSoftSDN™
Solution Dyed Cationic Nylon

PHENIX Nylon Solution Dyed Carpet

Our nylon solution dyed carpets are built to withstand the “uh-ohs” that come with furry family members, 24/7, with enhanced pet performance and exceptional warranties for stain and spill protection, as well as product durability. This carpet is warranted for stairs and features Microban® Surface Protection, helping to protect 24/7 against the growth of bacteria, mold and mildew, and remain 99% cleaner than untreated surfaces.

LALaurie NOBLE



Lalaurie Noble
Grand
FA60474801
Color No. 74801

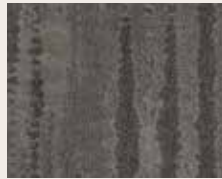

Lalaurie Noble
Worthy
FA60488901
Color No. 88901



Lalaurie Noble
Honorable
FA60473301
Color No. 73301



Lalaurie Noble
Stately
FA60495901
Color No. 95901



Lalaurie Noble
Divine
FA60499901
Color No. 99901



Lalaurie Noble
Cherish
FA60471901
Color No. 71901



Lalaurie Noble
Praise
FA60485901
Color No. 85901



Lalaurie Noble
Upstanding
FA60416501
Color No. 16501



Lalaurie Noble
Generous
FA60472701
Color No. 72701



Lalaurie Noble
Slide
FA60491901
Color No. 91901

PRODUCT BENEFITS



ENHANCED PET PROTECTION



STAIN + SPILL PROTECTION



DURABILITY GUARANTEED



KID FRIENDLY



100 DAY SATISFACTION



WARRANTED FOR STAIRS



ASTHMA + ALLERGY FRIENDLY



SureSoftSDN™
Solution Dyed Cationic Nylon

CARPET ONE



FlooringAmerica.

ProSource
WHOLESALE
Products & Pros for Home & Commercial Projects



CCA AT A GLANCE

	C1			FA		
PHENIX STYLE	STYLE NAME	PROGRAM	SAP MAT#	STYLE NAME	PROGRAM	SAP MAT#
FP018 Bari	Stricker Blaze II	Room By Room	CCA	Captain Baily II	Room To Explore	CCA
FP019 Catania	Stricker Blaze I	Room By Room	CCA	Captain Baily I	Room To Explore	CCA
FP020 Palermo	N/A			N/A		
FP027 Big Sur	Rosson Gully	Room By Room	CCA	Reed Flute	Room To Explore	CCA
FP026 Del Mar	Woodburn Glow	Room By Room	CCA	Hagar Stylish	Room To Explore	CCA
MB127 Cashmere	Farm Top Cellar II	Room By Room	CCA	Beckett Lofty II	Room To Explore	CCA
MB128 Merino	Farm Top Cellar I	Room By Room	CCA	Beckett Lofty I	Room To Explore	CCA
FP001 Hydra	Henderson Urban II	Room By Room	CCA	McPike Desert II	Room To Explore	CCA
FP002 Rhodes	Henderson Urban I	Room By Room	CCA	McPike Desert I	Room To Explore	CCA
FP024 Mykonos	Stanley Park	Room By Room	CCA	Lalaurie Noble	Room To Explore	CCA
MB143 Colonnade	Ferris Farms	Room By Room	CCA	Sallie Free	Room To Explore	CCA
N219 Paradox	Prima Donna Premier	Extreme Values	542146: Blanket 542147: Take Home DB	Treasure Chest Premier	Spotlight Value	542148: Blanket 542150: Take Home DB
N231 Paradigm	Prima Donna Dandy	Extreme Values		Treasure Chest Plus	Spotlight Value	
N230 Paragon	Prima Donna	Extreme Values		Treasure Chest	Spotlight Value	
	PROSOURCE*			FLOORTRADER		
PHENIX STYLE	STYLE NAME	PROGRAM	SAP MAT#	STYLE NAME	PROGRAM	SAP MAT#
FP018 Bari	Castlebay Premium	Dura Weave Elite WC	542705	N/A		
FP019 Catania	Castlebay Best	Dura Weave Elite WC	542706	N/A		
FP020 Palermo	Castlebay Better	Dura Weave Elite WC		N/A		
FP027 Big Sur	Timberidge	Somerset House WC	542707	N/A		
FP026 Del Mar	Brightview	Somerset House WC		N/A		
MB127 Cashmere	N/A			N/A		
MB128 Merino	N/A			N/A		
FP001 Hydra	Fairacres Best	Dura Weave Elite WC	542708	N/A		
FP002 Rhodes	Fairacres Better	Dura Weave Elite WC		N/A		
FP024 Mykonos	Philmar	Somerset House WC	542709	N/A		
MB143 Colonnade	Reiker	Somerset House WC	542710	N/A		
N219 Paradox	Ryker Premium	Harding Factory Direct WC & DB	542711	Crown Jewels Premium	Right Price Right Now	542151: Blanket
N231 Paradigm	Ryker Best	Harding Factory Direct WC & DB	542712: WC	Crown Jewels Best	Right Price Right Now	
N230 Paragon	Ryker Better	Harding Factory Direct WC & DB	542713: DB	Crown Jewels Better	Right Price Right Now	

*Initial shipment is handled by Prosource through marketing alliance, any replacements are ordered through Phenix

ABBEY CARPET
FLOORS TO GO
PRIVATE
LABEL CARPET
PROGRAMS



Surfaces treated with Microban technology remain 99% cleaner from the growth of bacteria and odors than untreated surfaces.



Microban technology protects 24/7 against the growth of bacteria, mold and mildew that can cause stains, odors and product deterioration.

PHENIX



PHENIX STYLE #	PHENIX STYLE NAME	ABBEY STYLE #	ABBEY STYLE NAME	FLOORS TO GO STYLE #	FLOORS TO GO STYLE NAME
FE101	Bravo	AB602	Missing You	FG602	Ideal Age
FE102	Ovation	AB603	Peaceful Spring	FG603	Legend Moon
FE103	Accolades	AB604	Penny Circle	FG604	Lifelong Voyage
FE104	Tribute	AB605	Perkins Drive	FG605	Live Celebration
FE105	Insight	AB606	Quail Creek	FG606	Logan Drive
FE106	Epiphany	AB608	Regal Dynasty	FG608	Magical Land
FE107	Crave	AB609	Rest On	FG609	Major Decision
FE108	Desire	AB601	Sawyer City	FG601	Sawyer Heights
FE109	Intellect	AB607	Ranch Trail	FG607	Magic Circle
FE110	Yearn	AB610	Sailing Along	FG610	Modern Day
FE111	Succeed	AB611	Sandpiper Isle	FG611	Monday Lane
FE112	Surpass	AB612	Tackle Road	FG612	Never Fear
FE113	Achieve	AB613	Take to Heart	FG613	Perfect Take
FE114	Attain	AB614	The Avenue	FG614	Quiet Star
FE115	Conjure	AB615	Wagon Trail	FG615	Renewed Style
FE116	Aspire	AB616	Ribbon Award	FG616	Splendid Song
FE502	Idyllic	AB192	Long Preserve	FG192	Everlasting Song
FE503	Ebullient	AB193	Luxury Island	FG193	Exciting Visit
FE505	Whimsical	AB195	Manor Garden	FG195	Here Forever
FE506	Eccentric	AB196	Midnight Star	FG196	Hidden Jewel
FE507	Visionary	AB197	Mighty Wonder	FG197	Hilton Way
FP001	Hydra	AB630	Sunrise Retreat	FG630	Sunrise Retreat
FP002	Rhodes	AB631	Sweet Adventure	FG631	Sweet Adventure
FP003	Crete	AB628	Summer Living	FG628	Summer Living
FP004	Sparta	AB629	Sun Valley Lane	FG629	Sun Valley Lane
FP005	Emerson	AB619	Endless Honor	FG619	Endless Honor
FP006	Mateo	AB620	Enduring Charm	FG620	Enduring Charm
FP009	Portofino	AB617	Amazing Moment	FG617	Amazing Moment
FP010	Sorrento	AB618	Beautiful Dreamer	FG618	Beautiful Dreamer
FP018	Bari	AB625	Natural Feeling	FG625	Natural Feeling
FP019	Catania	AB626	Night Star	FG626	Night Star
FP020	Palermo	AB627	Noble Dream	FG627	Noble Dream
FP021	Bougie	AB633	West Hill	FG633	West Hill
FP022	Luxe	AB634	Weston Bay	FG634	Weston Bay
FP024	Mykonos	AB624	Mystical Island	FG624	Mystical Island
FP025	Maxwell	AB623	Mystic Point	FG623	Mystic Point
FP029	Verona	AB621	English Manor	FG621	English Manor
FP032	Debut	AB622	Gentle Greeting	FG622	Gentle Greeting
FP033	Impression	AB635	Amazing Feeling	FG635	Adoring Delight
FP034	Cardigan	AB636	Get Creative	FG636	Get Ready
FP035	Vista Gold	AB637	Cheerful Breeze	FG637	Cheerful Breeze
FP036	Vista Silver	AB638	Cheerful Charm	FG638	Cheerful Charm
FP037	Madras	AB639	Broad Method	FG639	Broad Method
MB100	Bodega Bay	AB140	Delightful	FG140	Blush

ABBEY CARPET
FLOORS TO GO
PRIVATE
LABEL CARPET
PROGRAMS

MICROBAN



Surfaces treated with Microban technology remain 99% cleaner from the growth of bacteria and odors than untreated surfaces.



Microban technology protects 24/7 against the growth of bacteria, mold and mildew that can cause stains, odors and product deterioration.

Abbey Carpet & Floor

Floors To Go

PHENIX STYLE #	PHENIX STYLE NAME	ABBEY STYLE #	ABBEY STYLE NAME	FLOORS TO GO STYLE #	FLOORS TO GO STYLE NAME
MB110	Divine	AB164	Hope Valley	FG164	Hour Glass
MB111	Tempt	AB173	Key Adventure	FG173	My Design
MB112	Entice	AB174	My Dreams	FG174	My Leader
MB115	Ryman	AB179	Wall Street	FG179	Walden Square
MB116	Tabernacle	AB167	Fenwick	FG167	Festive
MB117	Lincoln Hall	AB168	Kelly Lane	FG168	Kelly Ridge
MB118	Memento	AB178	Wakefield Estate	FG178	Wakefield Lake
MB119	Five Star	AB169	Kelly Station	FG169	Kellyville
MB120	Top Notch	AB170	Kempsey	FG170	Kempsey Mill
MB121	Medley	AB180	Club Mason	FG180	World Champ
MB122	Amarillo	AB181	Endless Acres	FG181	Alabama Moon
MB123	El Dorado	AB182	Endless Waves	FG182	Alton Lane
MB124	Heavenly	AB183	Epic Adventure	FG183	Band Together
MB125	Ethereal	AB184	Ever Improving	FG184	Beautiful Treasure
MB126	Magical	AB185	Fable Circle	FG185	Beloved Feeling
MB127	Cashmere	AB186	Falling Star	FG186	Capri Circle
MB128	Merino	AB187	Grant Estate	FG187	Charity Island
MB129	Glam	AB188	Great Advance	FG188	Clear Memory
MB130	Tweed	AB198	Native Island	FG198	Native Island
MB132	Canvas I	AB202	Simple Grace I	FG202	So Confident I
MB133	Canvas II	AB203	Simple Grace II	FG203	So Confident II
MB134	Foundation I	AB204	Simple Touch I	FG204	So Expressive I
MB135	Foundation II	AB205	Simple Touch II	FG205	So Expressive II
MB136	Mirage I	AB206	Simple Elegance I	FG206	So Inspiring I
MB137	Mirage II	AB207	Simple Elegance II	FG207	So Inspiring II
MB138	Mirage III	AB208	Simple Elegance III	FG208	So Inspiring III
MB139	Dolce	AB209	Embrace Change	FG209	Endless Flair
MB140	Allure	AB210	Embrace Love	FG210	Endless Fun
MB141	Reflection	AB211	Embrace Today	FG211	Endless Night
MB142	Boucle	AB212	Embrace Tradition	FG212	Endless Peace
MB143	Colonnade	AB225	Pioneer Island	FG225	Pioneer Island
MB144	Courtyard	AB224	Pioneer City	FG224	Pioneer City
MB145	Radiant Gold	AB214	Give Your Heart	FG214	Give Your Heart
MB146	Radiant Silver	AB215	Graceful Dance	FG215	Graceful Dance
MB147	Oasis Platinum	AB216	Star Moment	FG216	Star Moment
MB148	Oasis Gold	AB217	Stardust Lane	FG217	Stardust Lane
MB149	Oasis Silver	AB218	Stargazer Way	FG218	Stargazer Way
MB150	Mesh	AB219	Panther Run	FG219	Panther Run
MB151	Aura	AB220	Panther Trail	FG220	Panther Trail
MB152	Cabana	AB221	State Of Grace	FG221	State Of Grace

PHENIX

ABBEY CARPET
FLOORS TO GO
PRIVATE
LABEL CARPET
PROGRAMS



Surfaces treated with Microban technology remain 99% cleaner from the growth of bacteria and odors than untreated surfaces.



Microban technology protects 24/7 against the growth of bacteria, mold and mildew that can cause stains, odors and product deterioration.



PHENIX STYLE #	PHENIX STYLE NAME	ABBEY STYLE #	ABBEY STYLE NAME	FLOORS TO GO STYLE #	FLOORS TO GO STYLE NAME
MB153	Illusion Gold	AB222	Everlasting Shine	FG222	Everlasting Shine
MB154	Illusion Silver	AB223	Evening Light	FG223	Evening Light
N175	Aurora	AB101	Campus Hall	FG101	Capiello
N176	Solstice	AB102	Cherry Creek	FG102	Conley
N219	Paradox	AB114	Javelin	FG114	Jewelberry
N230	Paragon	AB115	Kalista	FG115	Kodiac
N231	Paradigm	AB116	La Habra	FG116	Largo
N233	First Light	AB118	Albion	FG118	Aberdeen
N234	Day Break	AB119	Astrid	FG119	Adagio
N243	Etched	AB121	Ballina	FG121	Bavaria
N256	Creekside II	AB130	Mix And Match	FG130	Monkey Business
N257	Stoneybrook II	AB131	Monarch Supreme	FG131	Moon Cloud
N258	Riverbend II	AB132	Moray	FG132	Montego
N259	Front Runner	AB133	Neverending	FG133	New Moon
N260	Medal Winner	AB134	Neverland	FG134	New Oasis
N261	Grand Champion	AB135	Old World	FG135	Once Upon A Time
PH026	PH026	AB200	Take Pride	FG200	Take Pride
PH027	PH027	AB201	Take Spirit	FG201	Take Spirit
PH028	PH028	AB213	Embrace Wonder	FG213	Endless Charm
MB155	Current Platinum	AB228	Forward Path	FG228	Forward Path
MB156	Current Gold	AB229	Fresh Mix	FG229	Fresh Mix
MB157	Current Silver	AB230	Friendly Match	FG230	Friendly Match
FPO39	Karma Gold	AB640	Paradise Bay	FG640	Paradise Bay
FPO40	Karma Silver	AB641	Paradise Found	FG641	Paradise Found
FPO38	Grande Vista	AB642	Point Harbor	FG642	Point Harbor
FPO44	Seaside	AB643	Tavern Beach	FG643	Tavern Beach
FPO45	Relic	AB644	Brighton Shore	FG644	Brighton Shore
FPO41	Signature Platinum	AB646	Grand Award	FG646	Grand Award
FPO42	Signature Gold	AB647	Great Adventure	FG647	Great Adventure
FPO43	Signature Silver	AB648	Great Society	FG648	Great Society

PHENIX

CARPETS PLUS
 CARPETLAND
 PRIVATE
 LABEL CARPET
 PROGRAMS



Surfaces treated with Microban technology remain 99% cleaner from the growth of bacteria and odors than untreated surfaces.



Microban technology protects 24/7 against the growth of bacteria, mold and mildew that can cause stains, odors and product deterioration.

PHENIX STYLE #	PHENIX STYLE NAME	CARPETS PLUS STYLE #	CARPETS PLUS STYLE NAME	CARPETLAND STYLE #	CARPETLAND STYLE NAME
FE101	Bravo	CP600	Gatsby	CL600	Call of the Wild
FE102	Ovation	CP601	Macbeth	CL601	Dracula
FE103	Accolades	CP602	Iliad	CL602	Forte
FE104	Tribute	CP603	Monte Cristo	CL603	Gone with the Wind
FE105	Insight	CP604	Oliver Twist	CL604	Grapes of Wrath
FE106	Epiphany	CP606	Secret Garden	CL606	Huckleberry Finn
FE107	Crave	CP607	Humphrey	CL607	Kafka
FE108	Desire	CP608	Burton	CL608	Les Miserables
FE109	Intellect	CP605	Othello	CL605	Great Expectations
FE110	Yearn	CP609	Dickens		
FE111	Succeed	CP610	Faulkner	CL609	Maestro
FE112	Surpass	CP611	Hayes	CL610	Melange
FE113	Achieve	CP612	Hemingway	CL611	Moby Dick
FE114	Attain	CP613	Twain	CL612	Mockingbird
FE115	Conjure	CP614	Wilder		
FE116	Aspire	CP615	Woolf		
FE502	Idyllic	CP172	Monochrome	CL120	Ensemble
FE503	Ebullient	CP173	Now or Never	CL121	Nocturne
FE505	Whimsical	CP174	Blind Side	CL122	Carousel
FE506	Eccentric	CP175	Amore	CL123	Chromatic
FE507	Visionary	CP176	Aria	CL124	Falsetto
FP001	Hydra	CP629	Beethoven		
FP002	Rhodes	CP630	Berlioz		
FP003	Crete	CP627	Almond Blossoms		
FP004	Sparta	CP628	Atelier		
FP005	Emerson	CP618	Quiet Sanctuary		
FP006	Mateo	CP619	Ralph		
FP009	Portofino	CP637	Star Casting		
FP009	Portofino	CP616	Backdrop		
FP010	Sorrento	CP617	Outsiders		
FP010	Sorrento	CP638	Off Broadway		
FP018	Bari	CP624	Bruckner		
FP018	Bari	CP635	Flynn Creek		
FP019	Catania	CP636	Overture		
FP019	Catania	CP625	Vanity Fair		
FP020	Palermo	CP626	Clarion		
FP021	Bougie	CP639	Brilliant Addition		
FP021	Bougie	CP632	Brahms		
FP022	Luxe	CP640	World Premiere		
FP022	Luxe	CP633	Brown Sugar		
FP024	Mykonos	CP623	Tom Sawyer		
FP025	Maxwell	CP622	Sylvester		
FP029	Verona	CP620	Round Up		
FP032	Debut	CP621	Staccato		
FP032	Debut	CP641	High Flyers		
FP033	Impression	CP645	Bright Stars		
FP034	Cardigan	CP634	SINCLAIR		
MB100	Bodega Bay	CP145	Astounding	CL109	Oak Harbor

PHENIX

CARPETS PLUS
 CARPETLAND
 PRIVATE
 LABEL CARPET
 PROGRAMS



Surfaces treated with Microban technology remain 99% cleaner from the growth of bacteria and odors than untreated surfaces.



Microban technology protects 24/7 against the growth of bacteria, mold and mildew that can cause stains, odors and product deterioration.

PHENIX STYLE #	PHENIX STYLE NAME	CARPETS PLUS STYLE #	CARPETS PLUS STYLE NAME	CARPETLAND STYLE #	CARPETLAND STYLE NAME
MB103	Superb	CP146	Progressive	CL106	Milton Place
MB110	Divine	CP149	Invigorating	CL105	Memory Lane
MB111	Tempt	CP165	Bayside	CL100	Littleton
MB112	Entice	CP164	Manifest	CL101	Lockmiller
MB115	Ryman	CP153	Orbit		
MB116	Tabernacle	CP154	Winter Moon		
MB117	Lincoln Hall	CP155	Starship		
MB118	Memento	CP163	Penchant		
MB121	Medley	CP177	Retrograde		
MB122	Amarillo	CP178	Melodious	CL125	Presto
MB123	El Dorado	CP179	Composite	CL126	Cantabile
MB124	Heavenly	CP167	Distressed	CL115	Grandeur
MB125	Ethereal	CP168	Limited Edition	CL116	Beaumonde
MB126	Magical	CP169	Pantone	CL117	Andante
MB127	Cashmere	CP170	Breakaway	CL118	Bishop
MB128	Merino	CP171	Let it Be	CL119	Composition
MB129	Glam	CP166	Bellow		
MB132	Canvas I	CP189	Grandoise II		
MB133	Canvas II	CP188	Grandoise I		
MB136	Mirage I	CP183	Comfort Zone I		
MB137	Mirage II	CP184	Comfort Zone II		
MB138	Mirage III	CP185	Comfort Zone III		
MB140	Allure	CP187	Open Fields		
MB141	Reflection	CP186	Stillness Within		
MB142	Boucle	CP181	Delighted		
N219	Paradox	CP107	Ophelia		
N230	Paragon	CP105	Astrid		
N231	Paradigm	CP106	Cassiopeia		
N233	First Light	CP109	Capricornus		
N234	Daybreak	CP110	Zodiac		
N243	Etched	CP112	Starburst		
N256	Creekside II	CP118	Supernova		
N257	Stoneybrook II	CP119	Pulsar		
N258	Riverbend II	CP120	Callisto		
N259	Front Runner	CP121	Hubble's Law		
N260	Medal Winner	CP122	Kuiper Belt		
N261	Grand Champion	CP123	Tidal Force		
PH027	PH027	CP180	Classical Ballet		

PHENIX

FLOORS & MORE PRIVATE LABEL CARPET PROGRAMS



Surfaces treated with Microban technology remain 99% cleaner from the growth of bacteria and odors than untreated surfaces.



Microban technology protects 24/7 against the growth of bacteria, mold and mildew that can cause stains, odors and product deterioration.

PHENIX STYLE #	PHENIX STYLE NAME	FLOORS & MORE STYLE #	FLOORS & MORE STYLE NAME
FE113	Achieve	FM603	Prime
FE114	Attain	FM602	Limitless
FP009	Portofino	FM601	Glamorous II
FP010	Sorrento	FM600	Glamorous I
FP018	Bari	FM610	Livelihood
FP019	Catania	FM609	Lifetime
FP020	Palermo	FM608	Lifelong
FP021	Bougie	FM607	Approval
FP022	Luxe	FM606	Proven
FP024	Mykonos	FM605	Evermore
FP025	Maxwell	FM604	Enduring
MB 128	Merino	FM101	Top Choice
MB122	Amarillo	FM108	Dealers Choice
MB123	El Dorado	FM107	Competitive Advantage
MB127	Cashmere	FM100	Top Pick
N175	Aurora	FM102	Enviably Choice
N176	Solstice	FM103	Enviably Selction
N243	Etched	FM109	Noteworthy

PHENIX

FCA PRIVATE LABEL CARPET PROGRAMS



Surfaces treated with Microban technology remain 99% cleaner from the growth of bacteria and odors than untreated surfaces.



Microban technology protects 24/7 against the growth of bacteria, mold and mildew that can cause stains, odors and product deterioration.

PHENIX STYLE #	PHENIX STYLE NAME	FCA STYLE #	FCA STYLE NAME	PHENIX STYLE #	PHENIX STYLE NAME	FCA STYLE #	FCA STYLE NAME
FE101	Bravo	FC601	Jolene	FP025	Maxwell	FC618	Deco Chic
FE102	Ovation	FC602	Darlin'	FP033	Impression	FC631	Crazy Beautiful
FE103	Accolades	FC603	Fine & Dandy	MB115	Ryman	FC121	Paths of Jupiter
FE104	Tribute	FC604	Bluegrass	MB116	Tabernacle	FC120	Summer Solstice
FE105	Insight	FC605	Magnolias	MB117	Lincoln Hall	FC122	Over the Moon
FE106	Epiphany	FC607	West End	MB118	Memento	FC123	Walking on Air
FE107	Crave	FC608	City Slicker	MB122	Amarillo	FC126	Twice as Nice
FE108	Desire	FC609	Winter's Tale	MB123	El Dorado	FC127	Gateway
FE109	Intellect	FC606	Nightscape	MB127	Cashmere	FC130	Misty Blue
FE110	Yearn	FC610	Eternal City	MB128	Merino	FC131	Superstition
FE111	Succeed	FC611	Second to None	MB132	Canvas I	FC138	Shine Your Light
FE112	Surpass	FC612	Warm Welcome	MB133	Canvas II	FC137	Aspire To Inspire
FE113	Achieve	FC613	Always in Season	MB134	Foundations I	FC140	Innerpeace
FE114	Attain	FC614	Claim to Fame	MB135	Foundations II	FC139	Nirvana
FE115	Conjure	FC615	American Beauty	MB136	Mirage I	FC142	Keep It Fun
FE116	Aspire	FC616	Pot of Gold	MB137	Mirage II	FC141	Go For It
FE502	Idyllic	FC128	Soul Man	MB140	Allure	FC143	Live, Laugh, Love
FE503	Eubllient	FC129	Iron Sky	MB141	Reflection	FC144	Embrace Elegance
FP005	Emerson	FC621	Risk Taker II	MB143	Colonnade	FC147	Earl Greyhound
FP006	Mateo	FC622	Risk Taker I	MB144	Courtyard	FC148	Sherlock Bones
FP009	Portofino	FC627	Labrador-able II	MB150	Mesh	FC145	Smitten Kitten
FP010	Sorrento	FC626	Labrador-able I	MB151	Aura	FC146	Puppy Love
FP018	Bari	FC630	Noah's Bark III	N233	First Light		Music City
FP019	Cantania	FC629	Noah's Bark II	N234	Daybreak		Nashville
FP020	Palermo	FC628	Noah's Bark I	N243	Etched		Clermont
FP021	Bougie	FC624	Free Yourself II	N259	Front Runner		Sierra Lake
FP022	Luxe	FC625	Free Yourself I	N260	Medal Winner		Shelby Lake
FP024	Mykonos	FC619	Fashion Plate	N261	Grand Champion		Shadow Lake
FP038	Grande Vista	FC632	Corg-eous	N278	Polaris	FC136	Game Plan
FP039	Karma Gold	FC634	Cat-Nip I	PH016	PH016	FC134	Think Big
FP040	Karma Silver	FC633	Cat-Nip II	PH027	PH027	FC135	Big Deal
FP041	Signature Platinum	FC637	Boss Cat III				
FP042	Signature Gold	FC636	Boss Cat II				
FP043	Signature Silver	FC635	Boss Cat I				

PHENIX

NFA PRIVATE LABEL CARPET PROGRAMS



Surfaces treated with Microban technology remain 99% cleaner from the growth of bacteria and odors than untreated surfaces.



Microban technology protects 24/7 against the growth of bacteria, mold and mildew that can cause stains, odors and product deterioration.



PHENIX STYLE #	PHENIX STYLE NAME	CUSTOMER	NFA STYLE #	NFA STYLE NAME
FP010	Sorrento	NFA	NS117	Zeus II
FP009	Portofino	NFA	NS118	Athena II
FP006	Mateo	NFA	NS119	Elysian
FP005	Emerson	NFA	NS120	Eden
FP029	Verona	NFA	NS121	Arcadia
FP032	Debut	NFA	NS122	Universe
FP025	Maxwell	NFA	NS123	Dynasty
FP024	Mykonos	NFA	NS124	Odyssey
FP020	Palermo	NFA	NS125	Saga
FP019	Catania	NFA	NS126	Fable
FP018	Bari	NFA	NS127	Ballad
FP004	Sparta	NFA	NS128	Wonderland
FP003	Crete	NFA	NS129	Mystical
FP002	Rhodes	NFA	NS130	Venus
FP001	Hydra	NFA	NS131	Aphrodite
FP022	Luxe	NFA	NS133	Cosmic
FP021	Bougie	NFA	NS134	Capricorn
FP014	Naples	NFA	NS135	Shangri-La
FP013	Capri	NFA	NS136	Avalon
FP012	Milo	NFA	NS137	Utopia
FP011	Luna	NFA	NS138	Dream World
FP008	Lido	NFA	NS139	Muse
FP007	Balboa	NFA	NS140	Minerva
FP016	Seaview	NFA	NS141	Poseiden
FP015	Crystal Cove	NFA	NS142	Atlantis
FP017	Paxton	NFA	NS143	Delphi
FP028	Aviara	NFA	NS144	Valhalla
FP026	Del Mar	NFA	NS145	Xanadu
FP027	Big Sur	NFA	NS146	Olympus
FP030	All Inclusive	NFA	NS147	Folklore
FP031	In The Details	NFA	NS148	Legendary
FP033	Impression	NFA	NS150	Imprint
FP034	Cardigan	NFA	NS149	Glacier
FP035	Vista Gold	NFA	NS152	Panorama II
FP034	Vista Silver	NFA	NS151	Panorama I
FP037	Madras	NFA	NS153	Valencia

PHENIX

2023-2024 PRODUCT DROPS

STYLE	STYLE NAME	DROP DATE
N225	Panache	10/1/2024
N226	Cachet	10/1/2024
MC118	Warp	9/15/2024
MC119	Weft	9/15/2024
MB113	Blessed	5/10/2024
MB114	Goals	5/10/2024
MB131	Tonal Serenity	5/10/2024
PH003	PH003	3/31/2024
N212	Chandler Bay	3/31/2024
N242	Linea	3/31/2024
N263	Memoir	3/31/2024
N216	Touchstone	12/4/2023
N217	Capstone	12/4/2023
FE500	Cherish	12/4/2023
FE501	Decadent	12/4/2023
FE504	Sonder	12/4/2023
SN100	Thrill	8/16/2023
MC120	Pristine	7/24/2023
MC102	Tonal Harmony	7/24/2023
MC108	Frill	7/24/2023
MC110	Haven	7/24/2023
MC105	Sartorial	7/24/2023
MC109	Opulent	7/24/2023
MC115	Bespoke	7/24/2023
MC117	Elegance	7/24/2023
MC106	Lavish	7/24/2023
MC116	Fringe	7/24/2023
MC104	Chic Stria	7/24/2023

ADDITIONAL SAMPLE ORDER INFO

	STYLE NAME	WING CARD 24X36	HANDLE CARD 17X27	DECK BOARD 17X32	COMBO SETS 27X18	SPLIT SETS 13.5X18 WITH 27X18 FEELER BOTH WEIGHTS	6X6 EACH COLOR	12X12 EACH COLOR
FloorEver™ PetPlus	FP001 HYDRA/FP002 RHODES	529225	X	529831	X	X	X	X
	FP001 HYDRA	X	X	X	529397	X	YES	X
	FP002 RHODES	X	X	X	529426	X	YES	X
	FP003 CRETE/FP004 SPARTA	529226	X	529888	X	X	X	X
	FP003 CRETE	X	X	X	529571	X	YES	X
	FP004 SPARTA	X	X	X	529538	X	YES	X
	FP005 EMERSON/FP006 MATEO	529227	X	529825	X	X	X	X
	FP005 EMERSON	X	X	X	529394	X	YES	X
	FP006 MATEO	X	X	X	529412	X	YES	X
	FP007 BALBOA/FP008 LIDO	529228	X	529873	X	X	X	X
	FP007 BALBOA	X	X	X	529444	X	YES	X
	FP008 LIDO	X	X	X	530580	X	YES	X
	FP009 PORTOFINO/FP010 SORRENTO	529229	X	529858	X	X	X	X
	FP009 PORTOFINO	X	X	X	529415	X	YES	X
	FP010 SORRENTO	X	X	X	530583	X	YES	X
	FP011 LUNA/FP012 MILO	529218	X	529867	X	X	X	X
	FP011 LUNA	X	X	X	529435	X	YES	X
	FP012 MILO	X	X	X	529465	X	YES	X
	FP013 CAPRI/FP014 NAPLES	529197	X	529870	X	X	X	X
	FP013 CAPRI	X	X	X	529432	X	YES	X
	FP014 NAPLES	X	X	X	529468	X	YES	X
	FP015 CRYSTAL COVE/FP016 SEAVIEW	529198	X	529861	X	X	X	X
	FP015 CRYSTAL COVE	X	X	X	529406	X	YES	X
	FP016 SEAVIEW	X	X	X	529456	X	YES	X
	FP017 PAXTON	529199	X	530023	529429	X	YES	X
	FP018 BARI/FP019 CATANIA/FP020 PALERMO	529200	X	529837	X	X	X	X
	FP018 BARI	X	X	X	531078	X	YES	X
	FP019 CATANIA	X	X	X	529423	X	YES	X
	FP020 PALERMO	X	X	X	529504	X	YES	X
	FP021 BOUGIE/FP022 LUXE	529201	X	529840	X	X	X	X
	FP021 BOUGIE	X	X	X	529438	X	YES	X
FP022 LUXE	X	X	X	529483	X	YES	X	
FP024 MYKONOS	529202	X	529966	529420	X	YES	X	
FP025 MAXWELL	529203	X	530014	529447	X	YES	X	
FP026 DEL MAR	529204	X	530056	529705	X	YES	X	
FP027 BIG SUR	529205	X	530062	529486	X	YES	X	
FP028 AVIARA	529206	X	530008	529708	X	YES	X	
FP029 VERONA	529207	X	530047	529462	X	YES	X	
FP030 ALL INCLUSIVE	529208	X	530101	529507	X	YES	X	
FP031 IN THE DETAILS	529209	X	530032	529541	X	YES	X	

ADDITIONAL SAMPLE ORDER INFO

	STYLE NAME	WING CARD 24X36	HANDLE CARD 17X27	DECK BOARD 17X32	COMBO SETS 27X18	SPLIT SETS 13.5X18 WITH 27X18 FEELER BOTH WEIGHTS	6X6 EACH COLOR	12X12 EACH COLOR
FloorEver™ PetPlus	FP032 DEBUT	529210	X	530029	529492	X	YES	X
	FP033 IMPRESSION	541362	X	541361	541363	X	YES	X
	FP034 CARDIGAN	541359	X	541358	541360	X	YES	X
	FP035 VISTA GOLD/FP036 VISTA SILVER	557529	X	557530	X	X	X	X
	FP035 VISTA GOLD	X	X	X	X	557531	YES	X
	FP036 VISTA SILVER	X	X	X	X	X	YES	X
	FP037 MADRAS	557535	X	557536	557537	X	YES	X
	FP038 GRANDE VISTA	568681	X	568682	568683	X	YES	X
	FP039 KARMA GOLD/FP040 KARMA SILVER	568684	X	568685	568725	X	YES	X
	FP040 SIGNATURE PLATINUM/FP042 SIGNATURE GOLD/FP043 SIGNATURE SILVER	568686	X	568687	568730	X	YES	X
	FP044 SEASIDE	568688	X	568689	568690	X	X	YES
	FP045 RELIC	568692	X	568693	568694	X	X	YES

ADDITIONAL SAMPLE ORDER INFO





	STYLE NAME	WING CARD 24X36	HANDLE CARD 17X27	DECK BOARD 17X32	27X18 SETS	27X18 COMBO SETS WITH FEELER OF OTHER WEIGHTS	COMBO SETS 13.5X18	SPLIT SETS 13.5X18 WITH 27X18 FEELER OF ALL WEIGHTS	6X6 EACH COLOR
Microban® Polyester	MB100 BODEGA BAY	529211	X	530098	529712	X	X		YES
	MB111 TEMPT/MB112 ENTICE	529212	530453	X	X	X	X		X
	MB111 TEMPT	X	X	X	539664	529661	529771		YES
	MB112 ENTICE	X	X	X	X	529706	529807		YES
	MB115 RYMAN/MB116 TABERNACLE/ MB117 LINCOLN HALL	529214	X	529903	X	X	X	X	X
	MB115 RYMAN	X	X	X	X	X	X	529519	YES
	MB116 TABERNACLE	X	X	X	X	X	X	529553	YES
	MB117 LINCOLN HALL	X	X	X	X	X	X	529595	YES
	MB118 MEMENTO	529215	X	530468	530959	X	X	X	YES
	MB119 FIVE STAR/ MB120 TOP NOTCH	529216	X	529933	X	X	X	X	X
	MB119 FIVE STAR	X	X	X	X	X	X	529441	YES
	MB120 TOP NOTCH	X	X	X	X	X	X	529471	YES
	MB121 MEDLEY	529217	X	530471	529715	X	X	X	YES
	MB122 AMARILLO/ MB123 EL DORADO	529230	530517	X	X	X	X	X	X
	MB122 AMARILLO	X	X	X	530071	X	X	530041	YES
	MB123 EL DORADO	X	X	X	X	X	X	530044	YES
	MB124 HEAVENLY/ MB125 ETHEREAL/MB126 MAGICAL	529254	X	530441	X	X	X	X	X
	MB124 HEAVENLY	X	X	X	X	X	X	529894	YES
	MB125 ETHEREAL	X	X	X	X	X	X	529897	YES
	MB126 MAGICAL	X	X	X	X	X	X	529900	YES
	MB127 CASHMERE/MB128 MERINO	529255	X	530456	X	X	X	X	X
	MB127 CASHMERE	X	X	X	X	X	X	532064	YES
	MB128 MERINO	X	X	X	X	X	X	529876	YES
	MB129 GLAM	529256	X	530542	530077	X	X	X	YES
	MB130 TWEED	529257	X	530068	X	X	529589	X	YES
	MB132 CANVAS I/MB133 CANVAS II	537529	X	537528	X	X	X	X	X
	MB132 CANVAS I	X	X	X	537534	X	X	537532	YES
	MB133 CANVAS II	X	X	X	537535	X	X	537533	YES
	MB134 FOUNDATION I/ MB135 FOUNDATION II	537921	X	537920	X	X	X	X	X
	MB134 FOUNDATION I	X	X	X	537924	X	X	537922	YES
	MB135 FOUNDATION II	X	X	X	537925	X	X	537923	YES
	MB136 MIRAGE I/MB137 MIRAGE II/ MB138 MIRAGE III	537927	X	537926	X	X	X	X	X
	MB136 MIRAGE I	X	X	X	537931	X	X	537928	YES
	MB137 MIRAGE II	X	X	X	537932	X	X	537929	YES
	MB138 MIRAGE III	X	X	X	537933	X	X	537930	YES
	MB139 DOLCE	538034	X	538033	538035	X	X	X	YES
	MB140 ALLURE	538047	X	538046	538048	X	X	X	YES
	MB141 REFLECTION	538060	X	538059	538061	X	X	X	YES
	MB142 BOUCLE	529211	X	530098	529712	X	X		YES





ADDITIONAL SAMPLE ORDER INFO

	STYLE NAME	WING CARD 24X36	HANDLE CARD 17X27	DECK BOARD 17X32	27X18 SETS	27X18 COMBO SETS WITH FEELER OF OTHER WEIGHTS	COMBO SETS 13.5X18	SPLIT SETS 13.5X18 WITH 27X18 FEELER OF ALL WEIGHTS	6X6 EACH COLOR
Microban® Polyester	MB143 COLONNADE/ MB144 COURTYARD	550031	X	550030	X	X	X	X	X
	MB143 COLONNADE	X	X	X	550032	X	X	X	YES
	MB144 COURTYARD	X	X	X	550033	X	X	X	YES
	MB145 RADIANT GOLD/ MB146 RADIANT SILVER	553920	X	553921	X	X	X	X	X
	MB145 RADIANT GOLD	X	X	X	X	X	X	553922	YES
	MB146 RADIANT SILVER	X	X	X	X	X	X	X	YES
	MB147 OASIS PLATINUM/MB148 OASIS GOLD/MB149 OASIS SILVER	553924	X	553925	X	X	X	X	X
	MB147 OASIS PLATINUM	X	X	X	X	553926	X	X	YES
	MB148 OASIS GOLD	X	X	X	X	X	X	X	YES
	MB149 OASIS SILVER	X	X	X	X	X	X	X	YES
	MB150 MESH/MB151 AURA	553929	X	553930	X	X	X	X	X
	MB150 MESH	X	X	X	554310	X	X	X	YES
	MB151 AURA	X	X	X	554311	X	X	X	YES
	MB152 CABANA	557532	X	557533	557534	X	X	X	YES
	MB153 ILLUSION GOLD/ MB154 ILLUSION SILVER	557526	X	557537	X	X	X	X	X
	MB153 ILLUSION GOLD	X	X	X	X	557528	X	X	YES
	MB154 ILLUSION SILVER	X	X	X	X	X	X	X	YES
	MB155 CURRENT PLATINUM/MB156 CURRENT GOLD/MB157 CURRENT SILVER	568698	X	568700	568731	X	X	X	YES
	MB158 ESCAPE GOLD/ MB159 ESCAPE SILVER	568701	X	568702	568728	X	X	X	YES
	N175 AURORA/N176 SOLSTICE	529259	530160	X	X	X	X	X	X
	N175 AURORA	X	X	X	X	X	529619	X	YES
	N176 SOLSTICE	X	X	X	X	X	529601	X	YES
	N233 FIRST LIGHT/N234 DAY BREAK	529264	530459	X	X	X	X	X	YES
	N233 FIRST LIGHT	X	X	X	X	X	X	529685	YES
	N234 DAY BREAK	X	X	X	X	X	X	529563	YES
	N243 ETCHED	529266	X	530436	529789	X	X	X	YES
	N259 FRONT RUNNER/ N260 MEDAL WINNER/ N261 GRAND CHAMPION	529231	X	529855	X	X	X	X	X
	N259 FRONT RUNNER	X	X	X	X	529532	X	X	YES
	N260 MEDAL WINNER	X	X	X	X	529513	X	X	YES
	N261 GRAND CHAMPION	X	X	X	X	529572	X	X	YES
	N271 REFINED	X	530610	X	529566	X	529697	X	YES
	N272 ESSENTIAL	X	530616	X	529640	X	X	X	YES
	N273 APPEALING	X	530604	X	529798	X	X	X	YES
N278 POLARIS	X	530595	X	530157	X	530523	X	YES	

ADDITIONAL SAMPLE ORDER INFO

	STYLE NAME	WING CARD 24X36	HANDLE CARD 17X27	DECK BOARD 17X32	27X18 SETS	27X18 COMBO SETS WITH FEELER OF OTHER WEIGHTS	COMBO SETS 13.5X18	SPLIT SETS 13.5X18 WITH 27X18 FEELER OF ALL WEIGHTS	6X6 EACH COLOR
PH Products	PH007	X	530526	X	X	X	X	X	YES
	PH016	X	530513	X	X	X	X	X	YES
	PH018	X	530507	X	X	X	X	X	YES
	PH025	X	530592	X	X	X	X	X	YES
	PH026	X	530545	X	X	X	X	X	YES
	PH027	X	530529	X	X	X	X	X	YES
	PH028	X	530565	X	X	X	X	X	YES
	PH029	X	X	X	X	X	X	X	X
	PH030/PH031	X	553008	X	X	X	X	X	X
	PH030	X	X	X	X	X	X	X	YES
	PH031	X	X	X	X	X	X	X	YES
	PH032/PH033/PH034	X	559659	X	X	X	X	X	X
	PH035/PH036	X	580715	X	X	X	X	X	X
	PH037/PH038	X	581098	X	X	X	X	X	X

		
<p>Placing an Order, Status of Orders, & Stock Availability</p>	<p>Delivery Guidelines</p>	<p>Cancellation Policy</p>
<p>Web: ManningtonConnect.com Phone: 877-845-9884 Customer Service is available 8am-5pm EST Monday-Friday</p> <p>To place an order: Call 877-845-9884 or email ResidentialService@Mannington.com For placing an order, you'll need:</p> <ul style="list-style-type: none"> • Your Mannington Account Number • Product Code • Quantity • Ship-to Address <p>To order samples/displays: Contact your TM for sample and display orders 6"x6" carpet swatches can be ordered by calling 877-845-9884</p> <p>To order rugs: Rugs@PhenixFlooring.com</p> <p>To order promo goods: Chris.Bogue@Mannington.com</p>	<p>Soft Surface Delivery Options</p> <ul style="list-style-type: none"> • Prepaid and Add • Collect • Third Party <p>All soft surface roll goods will ship FOB from Dalton, GA.</p>	<p>Orders for cuts cannot be cancelled if the cut has been processed.</p> <p>An order is not considered cancelled until it is given a cancellation number.</p> <p>If an order has already been processed for shipment when cancellation is requested, it must be filed as a return.</p> <p>To initiate a cancellation: Call 877-845-9884 or email ResidentialService@Mannington.com</p>
		<p>Please view the Order & Delivery Guidelines for complete and detailed information.</p>
<p>Returns/Claims Policy</p>	<p>Payee & Supplier</p>	
<p>A restocking fee of up to 35% applies for any approved returns.</p> <p>All returns must be approved by Mannington and must have a Return Material Authorization (RMA) number.</p> <p>To initiate a return: Email ResidentialService@Mannington.com with your account number and order number.</p> <p>To initiate a claim: In the unlikely event you receive damaged product or an incomplete order, please reach out to the below email or call to process your claim.</p> <p>Soft Surface Claims Call 800-609-9557 Email Claims@PhenixFlooring.com</p>	<p>Please note our new payee information for payment of all Mannington & Phenix invoices.</p> <p>Payee Information Mannington Mills, Inc. File #96261 P.O. Box 96261 Chicago, IL 60693</p> <p>A fee of 2.5% is applied to all soft and hard surface orders that are paid via credit card.</p> <p>Supplier Information Mannington Mills, Inc. P.O. Box 12281 Calhoun, GA 30701</p>	

		
<p>Placing an Order, Status of Orders, & Stock Availability</p>	<p>Delivery Guidelines</p>	<p>Cancellation Policy</p>
<p>Web: ManningtonConnect.com Phone: 800-609-9557 Customer Service is available 8am-5pm EST Monday-Friday</p> <p>To place an order: Call 800-609-9557 or email Orders@PhenixFlooring.com For placing an order, you'll need:</p> <ul style="list-style-type: none"> • Your Phenix Account Number • Product Code • Quantity • Ship-to Address <p>To order samples/displays: Call 800-609-9557 or email Samples@PhenixFlooring.com</p> <p>To order customer rugs: Rugs@PhenixFlooring.com</p> <p>To order promo goods: Chris.Bogue@Mannington.com</p>	<p>Soft Surface Delivery Options</p> <p>All soft surface roll goods will ship FOB from Dalton, GA.</p> <ul style="list-style-type: none"> • In stock orders placed by 5:00 pm (ET) cut-off time are available to ship the next business day • Prepaid & Add - Phenix will ship orders at Phenix negotiated rates and add the freight to the invoice as selected • Collect - Customer may select to assign the freight cost to its own freight account 	<p>A restocking fee of up to 35% applies for any approved cancellations.</p> <p>Orders for cuts of carpet cannot be cancelled if the cut has been processed.</p> <p>To initiate a cancellation: Call 800-609-9557 or email Orders@PhenixFlooring.com</p> <p>See the Order Delivery Guidelines for more complete information.</p>
		<p>Please view the Order & Delivery Guidelines for complete and detailed information.</p>
<p>Returns/Claims Policy</p>	<p>Payee & Supplier</p>	
<p>A restocking fee of up to 35% applies for any approved returns.</p> <p>All returns must be approved by Phenix and must have a Return Material Authorization (RMA) number.</p> <p>To initiate a return: Email Claims@PhenixFlooring.com with your account number and order number.</p> <p>To initiate a claim: In the unlikely event you receive damaged product or an incomplete order, please email Claims@PhenixFlooring.com or call to process your claim.</p>	<p>Please note our new payee information for payment of all Mannington & Phenix invoices.</p> <p>Payee Information Mannington Mills, Inc. File #96261 P.O. Box 96261 Chicago, IL 60693</p> <p>Supplier Information Mannington Mills, Inc. P.O. Box 12281 Calhoun, GA 30701</p> <p>Credit Department Call 800-241-2262 or email Calhoun.Credit@Mannington.com</p>	

CONTACTS AND PROCESSES CHEAT SHEET

TOPIC	CONTACT NAME/ DEPT	PHONE NUMBER/EMAIL ADDRESS	REQUESTED INFO TO PROVIDE
General product/Processes Inquiries/Training	Ryan Garbett	ryan.garbett@mannington.com or 214-457-2127	
Account Changes/Address/Phone Questions	Sandy Tyson	Sandy.Tyson@Mannington.com or request form in SFDC	New info vs old info
Stock Check (Mannington)	Customer Service	877.845.9884 or Salesforce.com	SKU # or color code
Place an order (Mannington)	Customer Service	ResidentialService@Mannington.com OR SFDC	Account #/Product/QTY
Connect.mannington.com	Justen Macias	justen.macias@mannington.com	
Sample Orders (Mannington & Phenix)	Customer Service	DirectSamples@Mannington.com	SKU and Account number if for a dealer
Returns (Mannington)	Customer Service	ResidentialService@Mannington.com	Reason for return and original Ref #
Returns (Phenix)	Customer Service	Claims@PhenixFlooring.com	Reason for return and original Ref #
Claims (Man. Defect)	Customer Care	800.356.6787 or Mannington.com/Claims	Claim number
Off goods Pricing/Availability	Chris Bogue	Chris.Bogue@Mannington.com	Product, QTY, dealer location
Off goods Pricing/Availability	Commercial	Debbie.Mock@Mannington.com	Product, QTY, dealer location
Commercial (Mannington)	Customer Service	877.845.9884	
Freight Damage	Customer Service	ResidentialService@Mannington.com	Ref number, Pictures, details on damage
Buying Group Questions	Jay Kopelson	Jay.Kopelson@Mannington.com	
SFDC Processes	Ian Campbell	Ian.Campbell@Mannington.com	This is for "how to" sales processes etc
SFDC System Issues	SFDC	Submit a case in SFDC and it will be responded to by the interal team	Be specific in the issue you are having
Marketing/Product Info	Website	Mannington.com/PK	
Mannington & Phenix Rewards	Dawn Hyson	dawn.hyson@mannington.com	
Pricing Inquires (Phenix or Mannington)	Customer Service	Residential.Pricing@Mannington.com	
Credit (Phenix or Mannington)	Customer Service	Calhoun.Credit@Mannington.com	Invoice number
Installation Questions	Jason Hyson	Jason.Hyson@Mannington.com	
Problem orders	Customer Service	ResidentialService@Mannington.com	Ref number and specifics on issue
Follow up on a shipping claim already filed	Customer Service	Directclaims@mannington.com	Ref number and specifics on issue
New Account Set up (Mannington)	Account Support	Link in SFDC	Customers email
Denied Claim follow up	Claims Dept	Claims.Disputes@Mannington.com	Claim number, customer info
Installations / Tech services	Jason Hyson / Anthony Faulknor	Jason.Hyson@Mannington.com / anthony.faulknor@mannington.com	installations or technical questions
Reporting Request / Needs	Joseph Ponders	joseph.ponders@mannington.com	Requested information

EXPEDITOR CONTACTS (SUBJECT TO CHANGE)

DIVISION	EXPEDITOR	INTERNAL EMAIL QUEUES
Sunshine SE (D51)	Josh	sunshineexpeditor@mannington.com
Midwest (D52)	Taylor	midwestexpeditor@mannington.com
Golden Gate & Palm Desert (West) (D53)	Brittney	goldengateexpeditor@mannington.com/palmdesertexpeditor@mannington.com
Mid-Southeast (D54)	Jody	midsoutheastexpeditor@mannington.com
Lonestar (D55)	Valerie	lonestarexpeditor@mannington.com
PacNW (D56)	Brittney	pacnwexpeditor@mannington.com
Atlantic NE (D57)	Christin	atlanticne@mannington.com
Phenix Only (D65)	Crystal/Tammy	expeditor@phenixflooring.com

PHENIX

Date _____

Territory Manager _____

Bill to _____

Ship to _____

Account # _____

Account # _____

Name _____

Name _____

Address _____

Address _____

City State Zip _____

City State Zip _____

Phone _____

Phone _____

PO _____

Style #	Style Name	Color	Size	# of Rolls	Price	Cashback

Additional Comments/Instructions: _____

Signature: _____

Date: _____

Customer Service: 800.609.9557

www.phenixflooring.com

1001 Enterprise Drive, Dalton GA 30721

*All products must ship to the retailer within 6 weeks of event date to be eligible for this pricing and cashback.

Mannington. PHENIX

Complete Custom Sample Order Form

1.) Tell us about the Custom Sample Project:

Requested by: _____

Date: _____

Distributor Name: _____

Ship To: _____

via Distrib. Truck _____ or Direct _____

Shipping Contact: _____ T: _____

Sidemark: _____

Purchase Order #: _____ (can be filled in AFTER order submitted)

2.) Sign to start the process. The request must be signed and dated for the work to begin.

Requester Name

Date

3.) What product(s) does this order include?

ADURA® Hardwood Laminate Sheet Carpet Other

4.) Tell us the specifics of this order:

Number of Sets: _____ Number of SKU's per Set: _____

Sample Size: _____ Handle Cards Deckboards Other

Backing Type: MDF Board Raw (MDF)

Painted edges No backing N/A Carpet

Do you need a room scene on the backer (recommended)? Yes No

Sample label required? If yes, complete the next two lines. Yes No

Sample label type: _____ Sample label size: _____

Label placement (ex. Front bottom left): _____

Sample Corner Type: Square Rounded (additional cost)

Strap sets only - Cover needed: Yes No

Packaging for Shipping - Collate into sets Yes (packed in cartons
 No (bulk package by SKU on skids)

****Expected delivery date:** _____

Mannington. PHENIX

***Please detail SKUs required to complete sets, any special instructions along with drawing:**

Steps:

- 1.) Fill out the above form in it's entirety.
- 2.) Submit form to directsamples@mannington.com.
- 3.) Carpet - TM's submit the request to the regional and regionals send the request to samples. Once quote is received, it is sent to upper management for approval. Once approved, purchase order is sent to sample vendor.
- 4.) A quote will be submitted to you within 5 business days.
- 5.) Once the quote is approved and all questions are answered, the project will begin.

NOTE - Once a custom order is approved and production has begun, we are unable to cancel the order.

*Room scenes may not be available in every size - custom artwork & printing will incur additional costs and lead time.

NOTE: Mannington is not responsible for samples produced with non-Mannington approved sample vendors.

Upper Management approval is required for the following:

- Processing of custom samples
- Setup of private label names
- Changes to warranties

Stainmaster requires we use their approved warranty side labels.

The final proof must be approved by the customer prior to printing. Any changes after the samples have been processed will be at the customer's expense.

Please return the completed form to directsames@mannington.com

PHENIX