



# Arcos® Modular Femoral Revision System

Cone Proximal Body Surgical Technique

# Table of Contents

<b>Pre-operative Planning</b> .....	<b>2</b>
<b>Patient Positioning and Surgical Approach</b> .....	<b>2</b>
<b>Removal of a Cemented Component</b> .....	<b>3</b>
<b>Removal of a Cementless Stem</b> .....	<b>3</b>
<b>Cone Proximal Body &amp; STS™ Distal Stem Ream-Over Technique</b> .....	<b>4</b>
Preparation of the Diaphysis .....	4
Trialing the Distal Stem .....	5
Distal Stem Insertion .....	5
Preparation of the Metaphysis .....	6
Trialing the Proximal Body .....	7
Trial Reduction .....	8
Proximal Body Insertion .....	8
Inserting the Locking Screw.....	9
Final Reduction .....	9
<b>Cone Proximal Body &amp; STS Distal Stem Sterile Field Technique</b> .....	<b>10</b>
Preparation of the Diaphysis .....	10
Preparation of the Metaphysis .....	11
Trialing .....	12
Trial Reduction .....	13
Implant Assembly.....	13
Implant Insertion .....	14
Inserting the Locking Screw.....	15
Final Reduction .....	15
<b>Cone Proximal Body &amp; PPS® Distal Stem Ream-Over Technique</b> .....	<b>16</b>
Preparation of the Diaphysis .....	16
Preparation of the Metaphysis: Part One.....	16
Trialing the Distal Stem .....	17
Distal Stem Insertion .....	18
Preparation of the Metaphysis: Part Two .....	19
Trialing the Proximal Body .....	20
Trial Reduction .....	20
Proximal Body Insertion .....	21
Inserting the Locking Screw.....	22
Final Reduction .....	22
<b>Cone Proximal Body &amp; PPS Distal Stem Sterile Field Technique</b> .....	<b>23</b>
Preparation of the Diaphysis .....	23
Preparation of the Metaphysis .....	24
Trialing .....	25
Trial Reduction .....	26
Implant Assembly.....	26
Implant Insertion .....	27
Inserting the Locking Screw.....	28
Final Reduction .....	28

<b>ETO (Extended Trochanteric Osteotomy) Distal Stem Ream-Over Technique .....</b>	<b>29</b>
Femoral Osteotomy.....	29
Preparation of the Diaphysis .....	29
Distal Stem Trial.....	30
Distal Stem Insertion .....	30
Preparation of the Metaphysis .....	31
Trialing the Proximal Body .....	32
Trial Reduction .....	33
Proximal Body Insertion .....	33
Inserting the Locking Screw.....	34
Final Reduction .....	34
<b>Cone Proximal Body &amp; Interlocking Distal Stem Ream-Over Technique .....</b>	<b>35</b>
Overview.....	35
Preparation of the Diaphysis .....	35
Preparation of the Metaphysis: Part One.....	36
Trialing the Distal Stem .....	36
Distal Stem Insertion .....	37
Distal Stem Retraction .....	39
Transverse Locking Screw Preparation.....	40
Transverse Locking Screw Insertion .....	41
Preparation of the Metaphysis: Part Two .....	43
Trialing the Proximal Body .....	44
Trial Reduction .....	45
Proximal Body Insertion .....	46
Inserting the Locking Screw.....	47
Final Reduction .....	48
<b>Trochanteric Reattachment Technique .....</b>	<b>49</b>
Attaching the Trochanteric Bolt Guide .....	59
Preparing for Auxiliary Implant Attachment .....	50
Final Attachment of the Auxiliary Implant.....	52
<b>In-Femur Assembly.....</b>	<b>53</b>
Implant Assembly.....	53
Inserter Disassembly .....	56
Inserting the Locking Screw.....	57
Final Reduction .....	58
<b>Taper Compression Assembly .....</b>	<b>59</b>
Proximal Body Insertion .....	59
Inserter Removal .....	61
Inserting the Locking Screw.....	62
<b>Disengaging the Taper Junction .....</b>	<b>63</b>
Disengaging the Proximal Body from the Distal Stem Implant.....	63

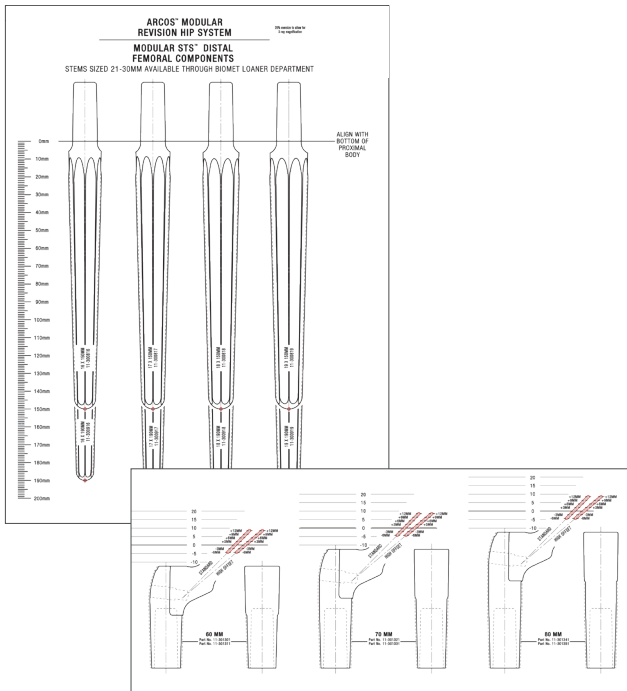

Figure 1

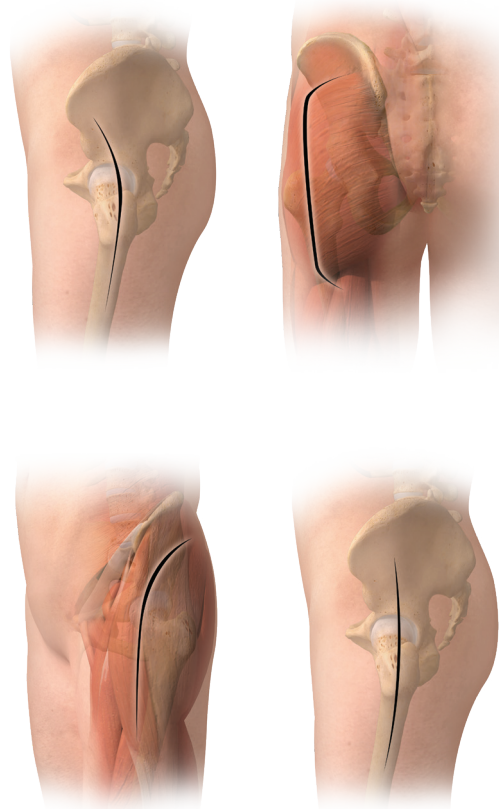

Figure 2

## Pre-operative Planning

When planning a hip revision utilizing the Arcos Modular Femoral Revision System, carefully review the indications and contraindications for use referenced within the package insert.

The Arcos System is not designed for use in a fully unsupported proximal femur. Bone stock of adequate quality must be present and appraised at the time of surgery. The use of medial and/or lateral strut grafts may be necessary to support the taper junction in cases of severe proximal deficiency.

Utilizing A/P and M/L X-rays and implant templates will assist in determining the correct implant size, offset and position for a stable reconstruction (Figure 1). Final determination frequently cannot be made until the time of surgery. However, with appropriate planning, a consistent operative plan with alternatives can be formulated.

## Patient Positioning and Surgical Approach

Patient position should be determined by the surgeon's preferred approach. The goal of the surgical approach is to establish adequate visualization of the anatomy (Figure 2).



Figure 3



Figure 4



Figure 5

## Removal of a Cemented Component

Once the stem has been removed from the cement mantle by utilizing universal extraction instruments or manufacturer specific instruments, ensure all cement is removed prior to preparation of the femur for the Arcos Femoral Components (Figure 3). This can be achieved using the Ultra-Drive<sup>®</sup> cement removal system or cement removal tools. An osteotomy of the femur may be necessary to facilitate removal of the cement.

## Removal of a Cementless Stem

Removal of a cementless stem may be difficult due to the biologic fixation that may exist between the implant and bone. When removing a proximally porous coated stem, it may be necessary to perform an osteotomy of the femur just below the level of the porous coating to assist in stem removal (Figure 4).

**Note:** An extended trochanteric osteotomy may be necessary if removing an extensively coated stem.

Sectioning the stem and utilizing trephine reamers can assist in the removal of the porous coated distal segment of a cementless stem (Figure 5).

## Cone Proximal Body & STS Distal Stem Ream-Over Technique



Figure 6

### Preparation of the Diaphysis

To prepare the femur for an STS distal stem, select the STS reamers (silver reamers for 150 mm stem length and gold reamers for 190 mm stem length). Assemble the STS reamer to the T-handle and turn the handle from torque limiting to the locked position (Figure 6).

Ream the femur in 1 mm increments by hand until the reamer advances to the 70 mm mark, referencing the tip of the greater trochanter.

- ⓘ **Note:** Reaming to the 70 mm etch mark on the STS reamer allows for a proximal height adjustment of 10 mm in either direction (e.g. 60 - 80 mm) depending on the final depth of the seated distal stem implant.
- ⓘ **Note:** The final depth of the implant may vary from the depth of the reamer. How aggressively the femur is prepared and the quality of the bone may impact the depth that the final implant will seat. If the final implant sits proud of the desired ream depth, note the difference between these and utilize the last reamer used to ream deeper into the femur. Reaming the femur by hand may help avoid any discrepancy between the reamed depth and the final depth of the implant.



Figure 7

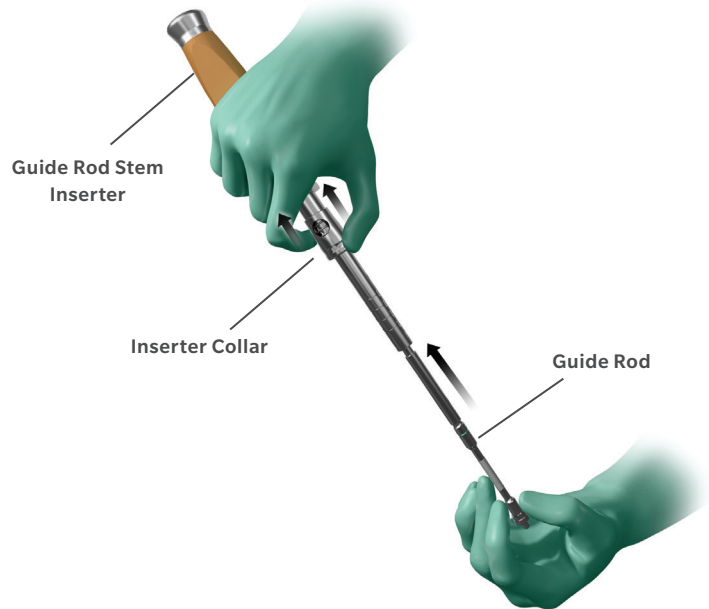

Figure 8

## Trialing the Distal Stem

When distal reaming is complete, select the stem trial that is the same diameter as the final reamer and the necessary length for stem stability. Thread the black distal stem trial inserter into the stem trial and insert the stem trial into the femur to the depth mark that matches the ream depth from the final reamer (Figure 7).

**Note:** The trial stem and reamer are the same size. Both are 1 mm smaller than the femoral implant.

## Distal Stem Insertion

Assemble the guide rod to the orange guide rod stem inserter by sliding the rod into the inserter, pulling back on the inserter collar and locking the rod into the stem inserter (Figure 8).

## Cone Proximal Body & STS Distal Stem Ream-Over Technique



Figure 9



Figure 10

### Distal Stem Insertion (cont.)

Thread the inserter assembly to the distal stem implant and seat the implant into the femur to the previously determined depth level, referencing the greater trochanter (Figure 9).

- ⓘ **Note:** If utilizing the 190 mm stem, ensure the bevel at the distal tip of the stem is oriented anteriorly.

Once the implant has been seated to the desired level, identify the depth on the inserter in reference to the greater trochanter to determine the height of the cone proximal body needed.

- ⓘ **Note:** The 50 mm, size A cone proximal body implant was not designed to accommodate a trochanteric bolt and claw. If a trochanteric bolt and claw is desired, utilize a cone proximal body implant with a 60, 70 or 80 mm vertical height.

### Preparation of the Metaphysis

To ream the proximal femur, release the inserter from the guide rod by pulling back on the collar spring to disengage the reaming guide and remove the stem inserter, leaving the guide rod attached to the distal stem (Figure 10).

- ⓘ **Note:** The guide rod must be attached to the stem to properly ream over the taper junction. The rod protects the taper junction from reamer damage and provides for accurate reaming depth.



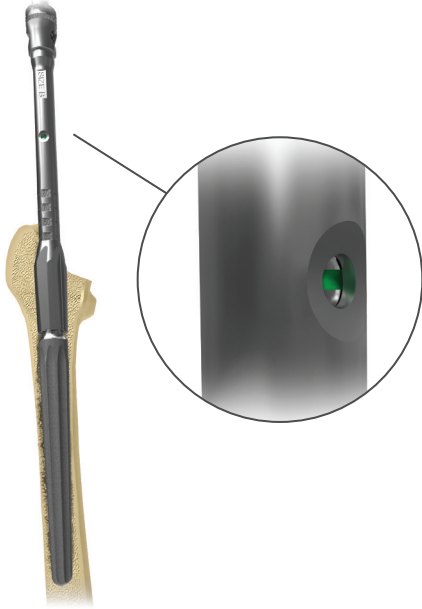

Figure 11



Figure 12



Figure 13

Ream the proximal femur over the guide rod with the proximal reamers until they no longer advance. A green line is visible through the proximal reamer window verifying that the reamer is fully seated and the proper reaming depth is obtained. Sequentially increase the size of the reamers until the desired proximal body size (A–G) is achieved (Figure 11).

Remove the guide rod from the distal stem implant with the guide rod removal tool, turning the removal tool counter-clockwise (Figure 12).

## Trialing the Proximal Body

To trial the proximal body, first ensure that the taper junction on the distal stem implant is clean and dry. Attach the cone trial that is the same height and size as the final proximal reamer and the appropriate offset. The light green trial indicates standard offset, while the purple trial represents high offset.

Assemble the 3.5 mm hex driver to the T-handle and adjust the T-handle to the torque limiting position. Tighten the cone trial to the distal stem implant until the T-handle “clicks,” setting the desired anteversion or retroversion in the proximal body (Figure 13).

ⓘ **Note:** The anti-rotation handle can be placed over the implant neck to control anteversion or retroversion.

ⓘ **Note:** In cases with good medial bone stock, impingement between the medial neck and bone may occur causing the trial to not properly seat. Using the appropriate hand tools, such as a rongeur, remove the excess bone and re-seat the trial before choosing a final implant.

## Cone Proximal Body & STS Distal Stem Ream-Over Technique

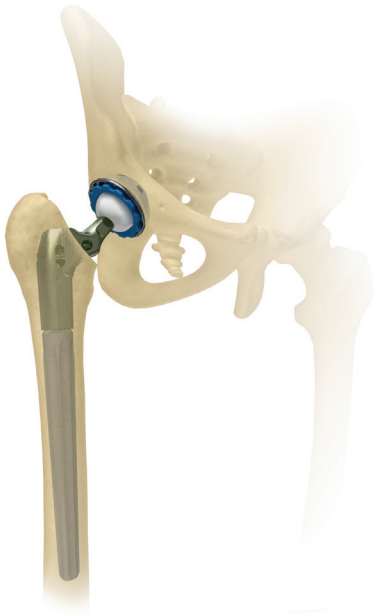

Figure 14



Figure 15

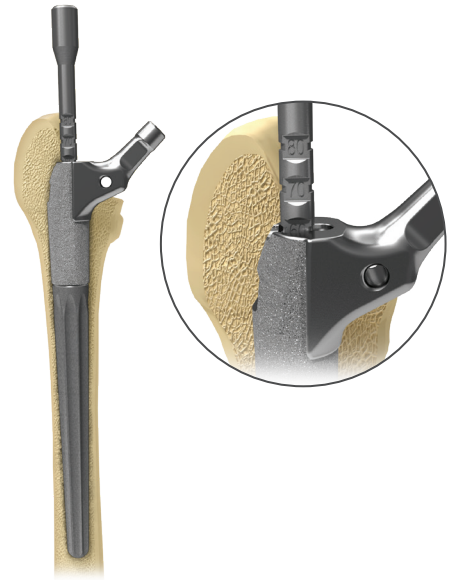

Figure 16

### Trial Reduction

Utilizing modular head trials, perform a trial reduction and determine if the selected offset, leg length and joint stability are appropriate (Figure 14). In performing the trial range of motion, ensure the absence of impingement of the neck on the rim of the acetabular component or acetabular liner. Remove the cone proximal body trial from the femur with the 3.5 mm hex driver.

### Proximal Body Insertion

**Note:** Reference the Taper Compression Assembly section of this technique (pg. 57) if an impaction assembly is not preferred.

Once the proper body height and size has been determined, thread the green proximal body inserter to the proximal body implant, ensuring the anti-rotation tabs are locked in the proper orientation.

Impact the proximal body to the taper junction on the distal stem implant with several blows of the mallet (Figure 15). The implant will be seated when there is an audible change in the pitch during impaction or the etch mark on the inserter handle is advanced to the previously determined ream depth.

**Note:** To confirm that the proximal body is fully seated onto the taper junction an optional taper engagement tool is available. Insert the taper engagement tool into the top of the proximal body. Verify that the etch mark depth (50, 60, 70 or 80) on the engagement tool aligns with the lateral shoulder of the proximal body implant chosen (Figure 16). The taper engagement tool may only be used prior to inserting the locking screw.



Figure 17

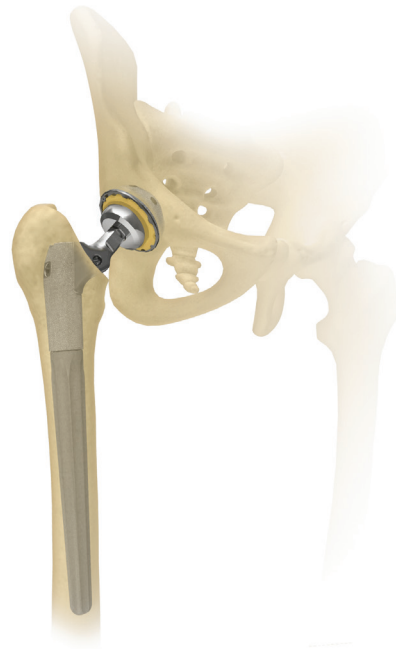

Figure 18

## Inserting the Locking Screw

To lock the distal and proximal body implants, thread the locking screw into the top of the cone proximal body using the 3.5 mm hex driver and T-handle in the torque limiting position until a “click” is felt and heard (Figure 17).

**Note:** If the screw does not thread into the distal stem the proximal body is not fully seated and the implant insertion steps must be repeated.

## Final Reduction

If desired, another trial reduction can be accomplished prior to selecting final head size and impacting the modular head onto the stem (Figure 18). Provisional heads in seven neck lengths allow an additional trial reduction using the actual implant to ensure proper leg length and stability. After fully seating the femoral component, impact the appropriate modular head onto the clean, dry taper.

## Cone Proximal Body & STS Distal Stem Sterile Field Technique



Figure 19

### Preparation of the Diaphysis

To prepare the femur for an STS distal stem, select the STS reamers (silver reamers for 150 mm stem length and gold reamers for 190 mm stem length). Assemble the STS reamer to the T-handle and turn the handle from torque limiting to the locked position (Figure 19).

Ream the femur in 1 mm increments by hand until the reamer advances to the 70 mm mark, referencing the tip of the greater trochanter.

- ⓘ **Note:** Reaming to the 70 mm etch mark on the STS reamer allows for a proximal height adjustment of 10 mm in either direction (e.g. 60–80 mm) depending on the final depth of the seated distal stem implant.
- ⓘ **Note:** The final depth of the implant may vary from the depth of the reamer in this step. How aggressively the femur is prepared and the quality of the bone may impact the depth that the final implant will seat. If the final implant sits proud of the desired ream depth, note the difference between these and utilize the last reamer used to ream deeper into the femur. Reaming the femur by hand may help avoid any discrepancy between the reamed depth and the final depth of the implant.

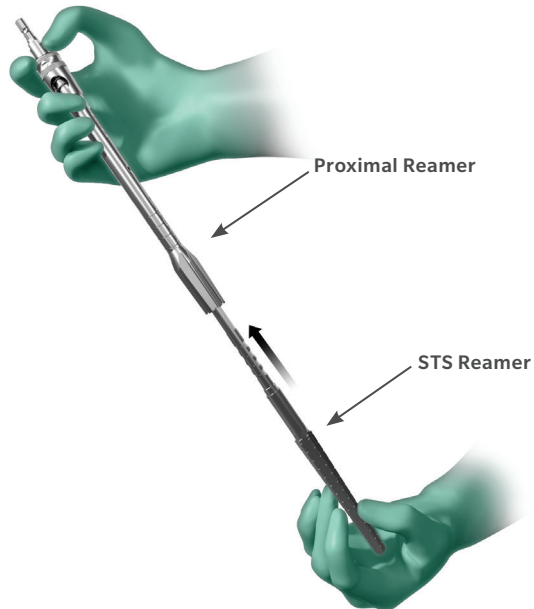

Figure 20

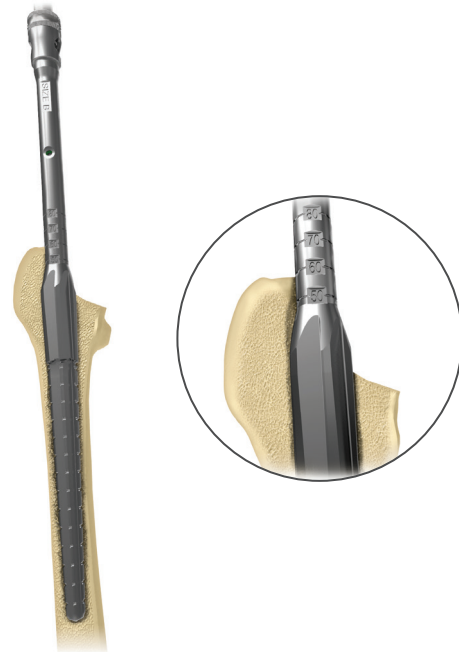

Figure 21

## Preparation of the Metaphysis

To prepare the proximal femur, assemble the final STS reamer into the proximal reamer and press down on the collar at the top of the proximal reamer to securely lock the two instruments together (Figure 20). Ream the proximal femur with the reamers, sequentially increasing the size of the proximal reamer, until the desired size (A–G) and proximal body height is achieved (Figure 21).

## Cone Proximal Body & STS Distal Stem Sterile Field Technique

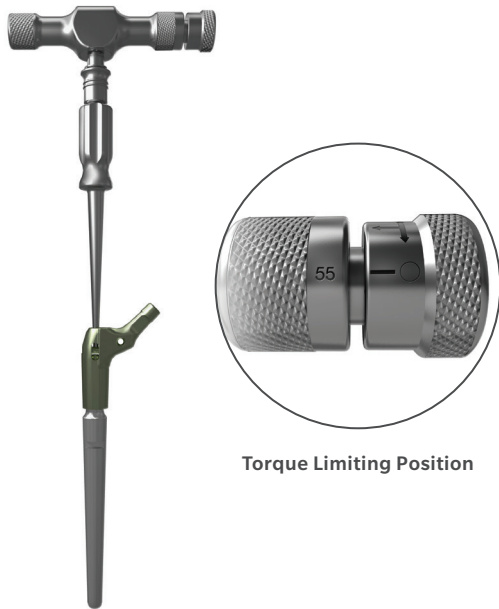

Figure 22



Figure 23

### Trialing

Select the proximal and distal stem trials that match the predetermined size, height and neck offset (standard or high). The light green trial indicates standard offset and the purple trial represents high offset. Assemble the proximal and distal stem trials together using the 3.5 mm hex driver and the T-handle in torque limiting position (Figure 22).

Thread the green proximal body inserter into the proximal body trial. Insert the trial into the femur aligning the etched depth mark on the inserter with the tip of the greater trochanter (Figure 23).

ⓘ **Note:** The anti-rotation handle can be placed over the trial neck to control anteversion or retroversion.

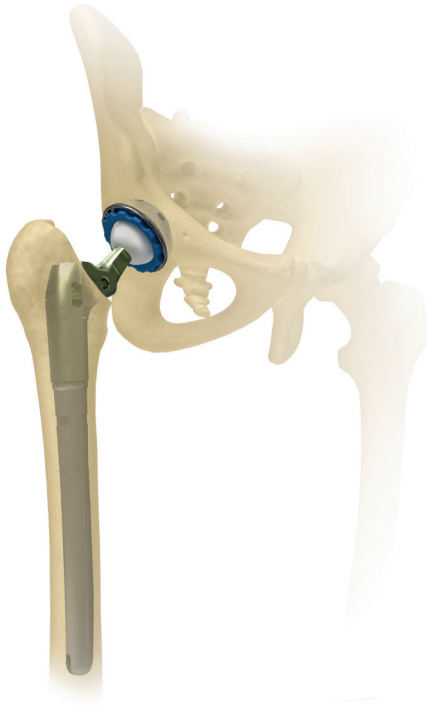

Figure 24



Figure 25

## Trial Reduction

Utilizing modular head trials, perform a trial reduction and determine if the selected offset, leg length and joint stability are appropriate (Figure 24). In performing the trial range of motion, ensure the absence of impingement of the neck on the rim of the acetabular component or acetabular liner.

Once the desired offset, leg length and joint stability has been achieved, reattach the proximal inserter to the assembled trial and remove the trial from the femur. Unthread the proximal inserter from the assembled trial.

## Implant Assembly

With the trial still assembled in the sterile field, assemble the distal stem and proximal body to match the orientation of the assembled trial (Figure 25).

## Cone Proximal Body & STS Distal Stem Sterile Field Technique



Figure 26



Figure 27

### Implant Assembly (cont.)

When the desired position of the implants has been achieved, thread the proximal body inserter to the assembled implants, ensure the anti-rotation tabs are properly locked and impact the taper junction with at least three blows of the mallet on the back table (Figure 26).

ⓘ **Note:** When using a 190 mm stem, ensure the bevel at the distal tip of the stem is anterior.

### Implant Insertion

With the proximal inserter still assembled to the implant, insert the final implant into the femur until the desired depth is achieved (Figure 27).

ⓘ **Note:** The final depth of the implant may vary from the depth of the reamer in this step. How aggressively the femur is prepared and the quality of the bone may impact the depth that the final implant will seat. If the final implant sits proud of the desired ream depth, note the difference between these and utilize the last reamer used to ream deeper into the femur. Reaming the femur by hand may help avoid any discrepancy between the reamed depth and the final depth of the implant.





Figure 28

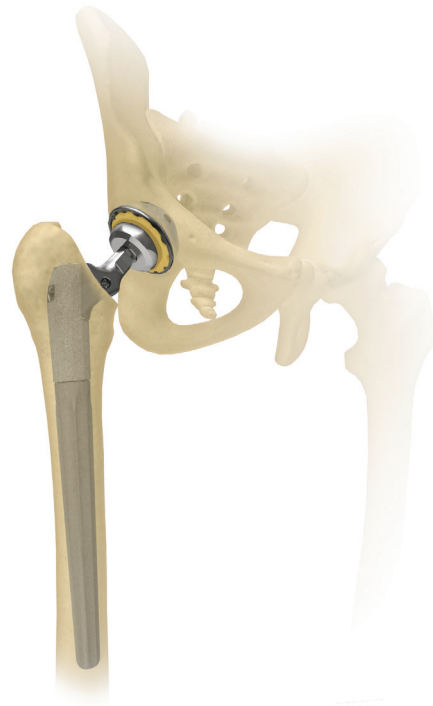

Figure 29

## Inserting the Locking Screw

To lock the distal and proximal body implants, unthread the proximal body inserter from the implant and thread the locking screw into the top of the cone proximal body using the 3.5 mm hex and T-handle in the torque limiting position until a “click” is felt and heard (Figure 28).

**Note:** The screw can be used to lock the proximal body and distal stem together before the implants are inserted into the femur. If this is done, check the security of the screw once the implant has been fully seated.

## Final Reduction

If desired, another trial reduction can be accomplished prior to selecting final head size and impacting the modular head onto the stem (Figure 29). Provisional heads in seven neck lengths allow an additional trial reduction using the actual implant to ensure proper leg length and stability. After fully seating the femoral component, impact the appropriate modular head onto the clean, dry taper.

## Cone Proximal Body & PPS Distal Stem Ream-Over Technique



Figure 30

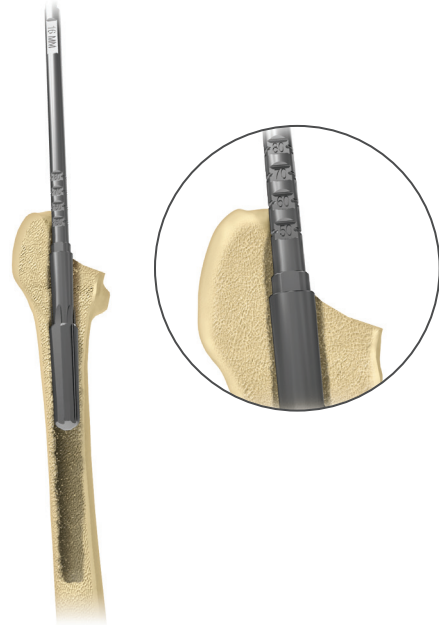

Figure 31

### Preparation of the Diaphysis

To prepare the femur for a PPS distal stem, select flexible or thin shaft reamers and sequentially ream the femur two cortical diameters or 2–3 cm below the distal defect, increasing size until cortical “chatter” is achieved (Figure 30).

- ⓘ **Note:** When utilizing flexible reamers, ream the canal in 0.5 mm increments until cortical “chatter” is achieved. The final reamer diameter should be line to line or 0.5 mm larger than the diameter of the desired implant, depending on bone quality.
- ⓘ **Note:** Reaming over a guide is recommended. The Arcos Distal Reamers that are designed to prepare the femur for a bowed distal stem are cannulated to accommodate a guide wire.

### Preparation of the Metaphysis: Part One

To prepare the femur for the flared region of the PPS distal stem, select the transition reamer that is the same size as the desired distal stem and ream to the depth of the desired proximal body height (60, 70 or 80 mm). The etch mark of the transition reamer, that corresponds to the proximal body height selected, should align with the tip of the greater trochanter (Figure 31).

- ⓘ **Note:** The 50 mm, size A cone proximal body implant was not designed to accommodate a trochanteric bolt and claw. If a trochanteric bolt and claw is desired, utilize a cone proximal body implant with a 60, 70 or 80 mm vertical height.

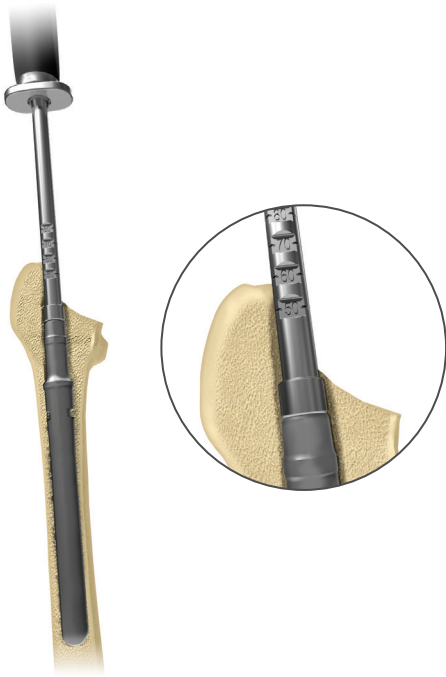

Figure 32

### Trialing the Distal Stem

When distal reaming is complete, select the stem trial that is the same diameter as the final transition reamer and the necessary length for stem stability. Thread the black distal trial stem inserter into the stem trial and insert the stem trial into the femur, matching the etched depth mark on the inserter to the depth achieved from the transition reamer (Figure 32).

- ⓘ **Note:** The stem trial will be 1.5 mm smaller than the final implant diameter as measured over the porous coating.

## Cone Proximal Body & PPS Distal Stem Ream-Over Technique

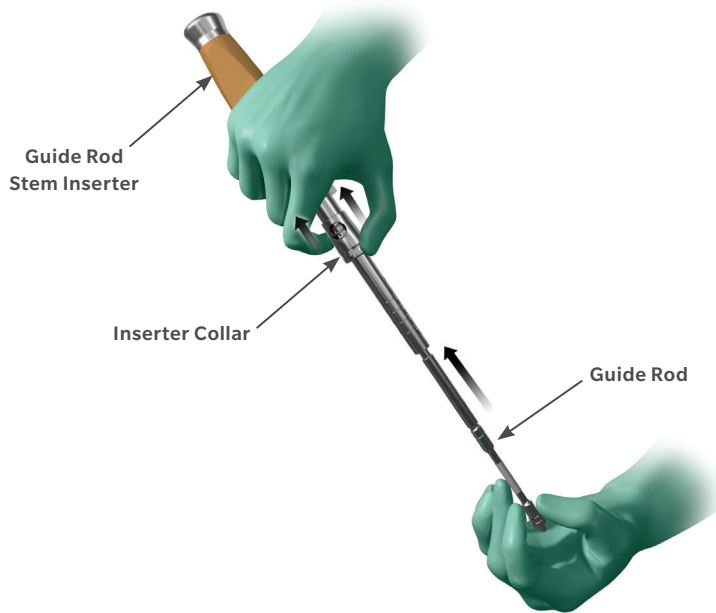

Figure 33



Figure 34

### Distal Stem Insertion

Assemble the guide rod to the orange guide rod stem inserter by sliding the rod into the inserter, pulling back on the inserter collar and locking the rod into the inserter (Figure 33). Thread this inserter assembly to the distal stem implant and seat the implant into the femur to the previously determined depth level, referencing the greater trochanter.

Once the implant has been seated to the desired level, identify the depth on the inserter in reference to the greater trochanter to determine the height of the cone proximal body needed (Figure 34).

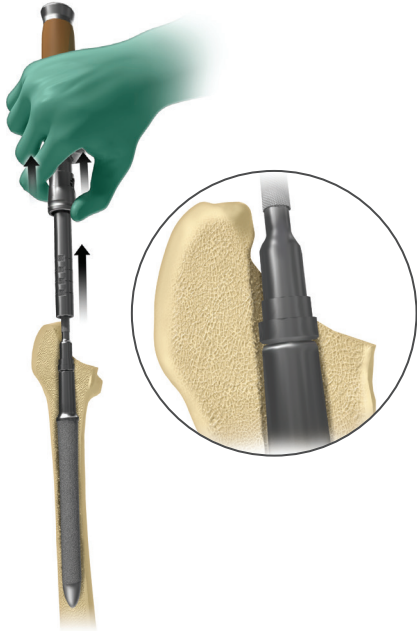

Figure 35

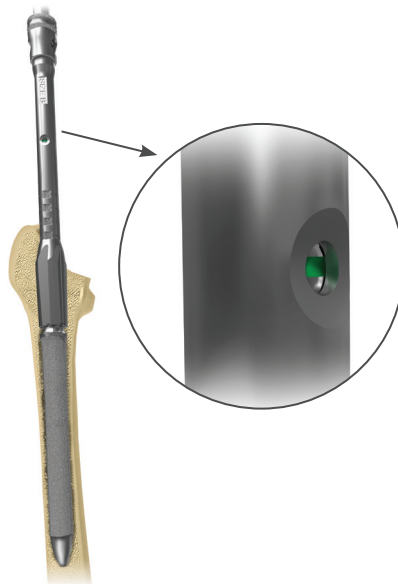

Figure 36

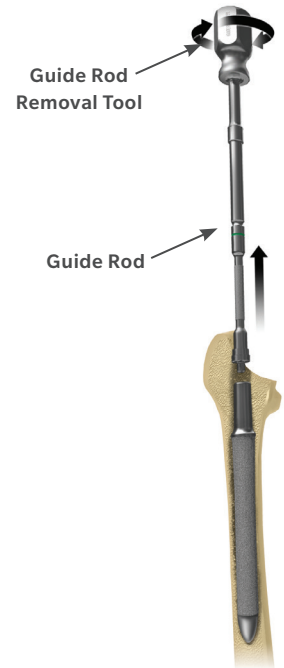

Figure 37

## Preparation of the Metaphysis: Part Two

To ream the proximal femur, release the inserter from the guide rod by pulling back on the collar spring to disengage the reaming guide and remove the stem inserter, leaving the guide rod attached to the distal stem (Figure 35).

**Note:** The guide rod must be attached to the stem to properly ream over the taper junction. The rod protects the taper junction from reamer damage and provides for accurate reaming depth.

Ream the proximal femur over the guide rod with the proximal reamers until they no longer advance. A green line is visible through the proximal reamer window verifying that the reamer is fully seated and the proper reaming depth is obtained. Sequentially increase the size of the reamers until the desired proximal body size (A–G) is achieved (Figure 36).

Remove the guide rod from the distal stem implant with the guide rod removal tool, turning the removal tool counter-clockwise (Figure 37).

## Cone Proximal Body & PPS Distal Stem Ream-Over Technique



Figure 38

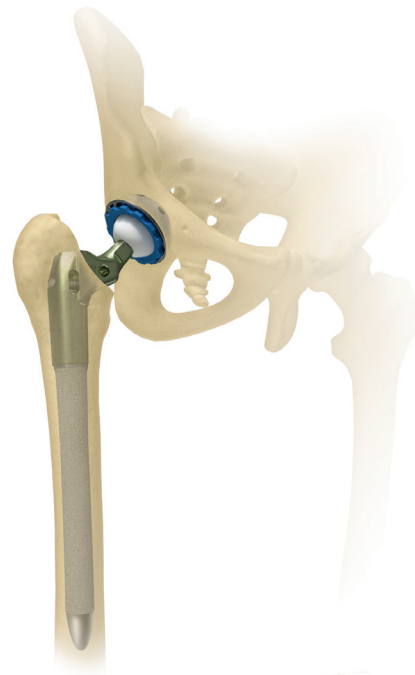

Figure 39

### Trialing the Proximal Body

To trial the proximal body, first ensure that the taper junction on the distal stem implant is clean and dry. Attach the cone trial that is the same height and size as the final proximal reamer and the appropriate offset. The light green trial indicates standard offset and the purple trial represents high offset.

Assemble the 3.5 mm hex driver to the T-handle and adjust the T-handle to the torque limiting position. Tighten the cone trial to the distal stem implant until the T-handle “clicks,” setting the desired anteversion or retroversion in the proximal body (Figure 38).

**Note:** The anti-rotation handle can be placed over the neck of the trial to control anteversion or retroversion. Once the desired version has been achieved, use electrocautery to mark the desired position under the neck on the remaining bone stock.

**Note:** In cases with good medial bone stock, impingement between the medial neck and bone may occur causing the trial to not properly seat. Using the appropriate hand tools such as a rongeur, remove the excess bone and re-seat the trial before choosing a final implant.

### Trial Reduction

Utilizing modular head trials, perform a trial reduction and determine if the selected offset, leg length and joint stability are appropriate (Figure 39). In performing the trial range of motion, ensure the absence of impingement of the neck on the rim of the acetabular component or acetabular liner. Remove the cone trial from the femur with the 3.5 mm hex driver.



Figure 40



Figure 41

## Proximal Body Insertion

ⓘ **Note:** Reference the Taper Compression Assembly section of this technique (pg. 57) if an impaction assembly is not preferred.

Once the proper body height and size has been determined, thread the green proximal body inserter to the proximal body implant, ensuring the anti-rotation tabs are locked in the proper orientation.

Impact the proximal body to the taper junction on the distal stem implant with several blows of the mallet (Figure 40). The implant will be seated when there is an audible change in the pitch during impaction or the etch mark of the inserter handle is advanced to the previously determined ream depth.

ⓘ **Note:** To confirm that the proximal body is fully seated onto the taper junction an optional taper engagement tool is available. Insert the taper engagement tool into the top of the proximal body. Verify that the etch mark depth (50, 60, 70 or 80) on the engagement tool aligns with the lateral shoulder of the proximal body implant chosen (Figure 41). The taper engagement tool may only be used prior to inserting the locking screw.

## Cone Proximal Body & PPS Distal Stem Ream-Over Technique

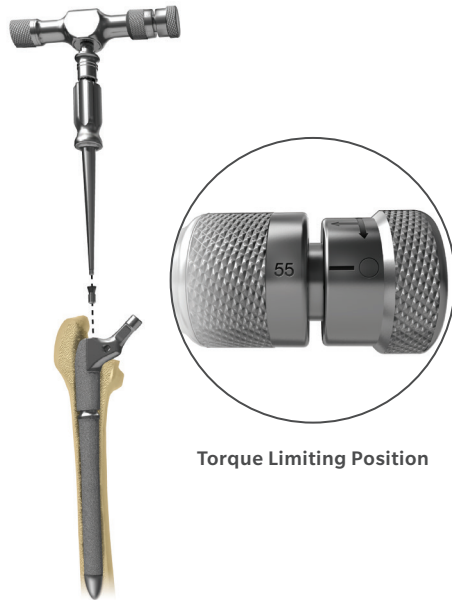

Figure 42

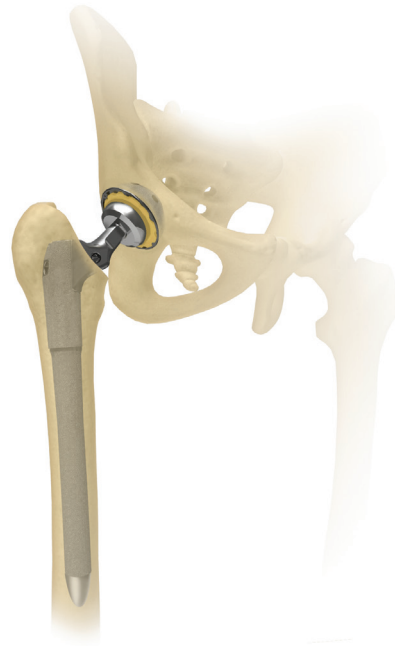

Figure 43

### Inserting the Locking Screw

To lock the distal and proximal body implants, thread the locking screw into the top of the cone proximal body using the 3.5 mm hex driver and T-handle in the torque limiting position until a “click” is felt and heard (Figure 42).

ⓘ **Note:** If the screw does not thread into the distal stem the proximal body is not fully seated and the final implant assembly steps must be repeated.

### Final Reduction

If desired, another trial reduction can be accomplished prior to selecting final head size and impacting the modular head onto the stem (Figure 43). Provisional heads in seven neck lengths allow an additional trial reduction, using the actual implant to ensure proper leg length and stability. After fully seating the femoral component, impact the appropriate modular head onto the clean, dry taper.



## Cone Proximal Body & PPS Distal Stem Sterile Field Technique



Figure 44

### Preparation of the Diaphysis

To prepare the femur for a PPS distal stem, select flexible or thin shaft reamers and sequentially ream the femur two cortical diameters or 2–3 cm below the distal defect, increasing size until cortical “chatter” is achieved (Figure 44).

ⓘ **Note:** When utilizing flexible reamers, ream the canal in 0.5 mm increments until cortical “chatter” is achieved. The final reamer diameter should be line-to-line or 0.5 mm larger than the diameter of the desired implant, depending on bone quality.

ⓘ **Note:** Reaming over a guide is recommended. The Arcos Distal Reamers that are designed to prepare the femur for a bowed distal stem are cannulated to accommodate a guide wire.

## Cone Proximal Body & PPS Distal Stem Sterile Field Technique

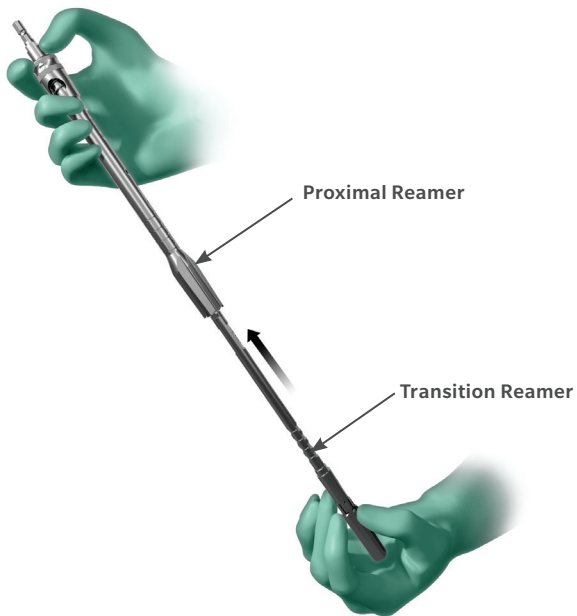

Figure 45

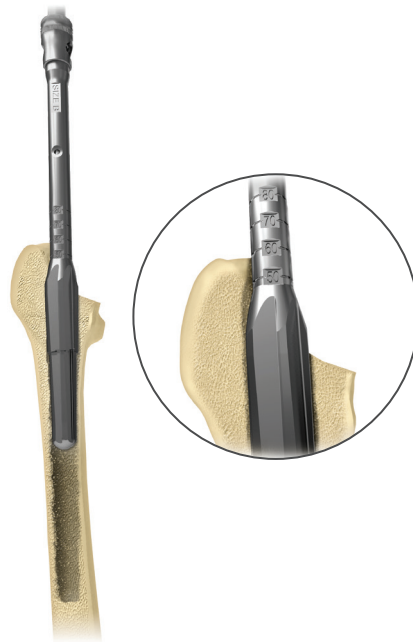

Figure 46

### Preparation of the Metaphysis

To prepare the proximal femur for the tapered region of the PPS distal stem and proximal body, assemble the transition reamer that is the same size as the desired distal stem into the proximal reamer and press down on the collar at the top of the proximal reamer to securely lock the two instruments together (Figure 45). Ream the proximal femur with the modular (transition/proximal) reamer, sequentially increasing the size of the proximal reamer, until the desired size (A–G) and proximal body height (60, 70 or 80 mm) is achieved.

The etch mark of the proximal reamer, that corresponds to the proximal body height selected, should align with the tip of the greater trochanter (Figure 46).

- ⓘ **Note:** The 50 mm, size A cone proximal body implant was not designed to accommodate a trochanteric bolt and claw. If a trochanteric bolt and claw is desired, utilize a cone proximal body implant with a 60, 70 or 80 mm vertical height.



Figure 47



Figure 48



Figure 49

## Trialing

Select the proximal and distal stem trials that match the predetermined size, height and neck offset (standard or high). The light green trial indicates standard offset and the purple trial represents high offset. Loosely assemble the proximal and distal stem trials together using the 3.5 mm hex driver (Figure 47).

ⓘ **Note:** Assemble the proximal and distal stem trials loose to allow the distal stem to find the appropriate position in the femur.

Thread the green proximal body inserter into the proximal body trial. Insert the trial into the femur aligning the etched depth mark on the inserter with the tip of the greater trochanter (Figure 48).

Once the trial has been seated to the desired level, remove the proximal inserter, adjust the anteversion or retroversion on the proximal trial and lock the proximal body into place with the 3.5 mm hex driver (Figure 49).

ⓘ **Note:** The anti-rotation handle can be placed over the neck of the trial to control anteversion or retroversion.

## Cone Proximal Body & PPS Distal Stem Sterile Field Technique

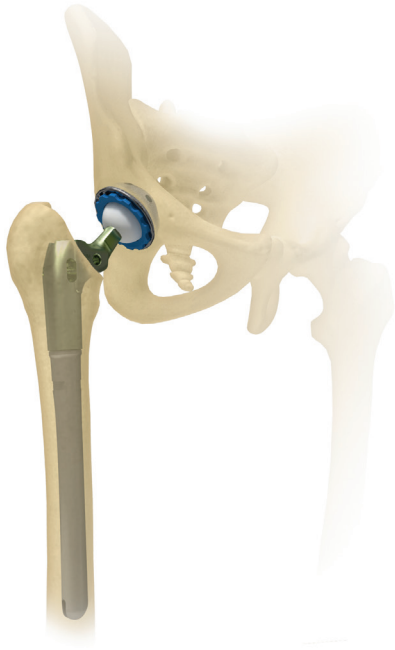

Figure 50



Figure 51

### Trial Reduction

Utilizing modular head trials, perform a trial reduction and determine if the selected offset, leg length and joint stability are appropriate (Figure 50). In performing the trial range of motion, ensure the absence of impingement of the neck on the rim of the acetabular component or acetabular liner.

Once the desired offset, leg length and joint stability have been achieved remove the modular head trial. Reattach the proximal inserter to the assembled trial and remove the trial from the femur. Unthread the proximal inserter from the assembled trial.

### Implant Assembly

With the trial still assembled in the sterile field, assemble the distal stem and proximal body implants to match the orientation of the assembled trial (Figure 51).

- Note:** If utilizing a slotted stem, a straight osteotome can be used in the slot of the trial and implant to properly orient the distal stem in relation to the proximal body.



Figure 52

### Implant Assembly (cont.)

When the desired orientation of the implants has been achieved, ensure the anti-rotation tabs are properly locked and thread the proximal body inserter to the assembled implants and impact the taper junction with at least three blows of the mallet on the back table (Figure 52).



Figure 53

### Implant Insertion

With the proximal inserter still assembled to the implant, insert the final implant into the femur until the desired depth is achieved (Figure 53).

## Cone Proximal Body & PPS Distal Stem Sterile Field Technique



Figure 54

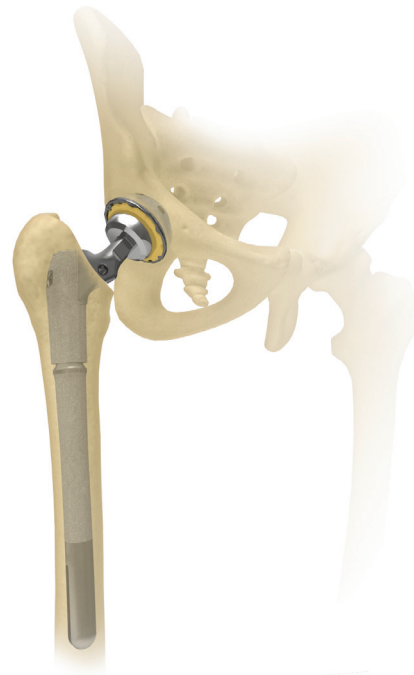

Figure 55

### Inserting the Locking Screw

To lock the distal and proximal body implants, unthread the proximal body inserter from the implant and thread the locking screw into the top of the cone proximal body using the 3.5 mm hex drive and T-handle in torque limiting position until a “click” is felt and heard (Figure 54).

**Note:** The screw can be used to lock the proximal body and distal stem together before the implants are inserted into the femur. If this is done, check the security of the screw once the implant has been fully seated.

### Final Reduction

If desired, another trial reduction can be accomplished prior to selecting final head size and impacting the modular head onto the stem (Figure 55). Provisional heads in seven neck lengths allow an additional trial reduction using the actual implant to ensure proper leg length and stability. After fully seating the femoral component, impact the appropriate modular head onto the clean, dry taper.

## ETO (Extended Trochanteric Osteotomy) Distal Stem Ream-Over Technique

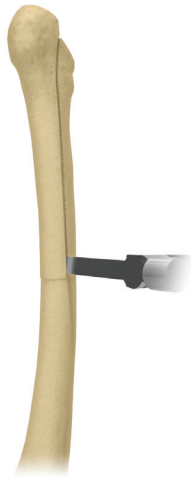

Figure 56

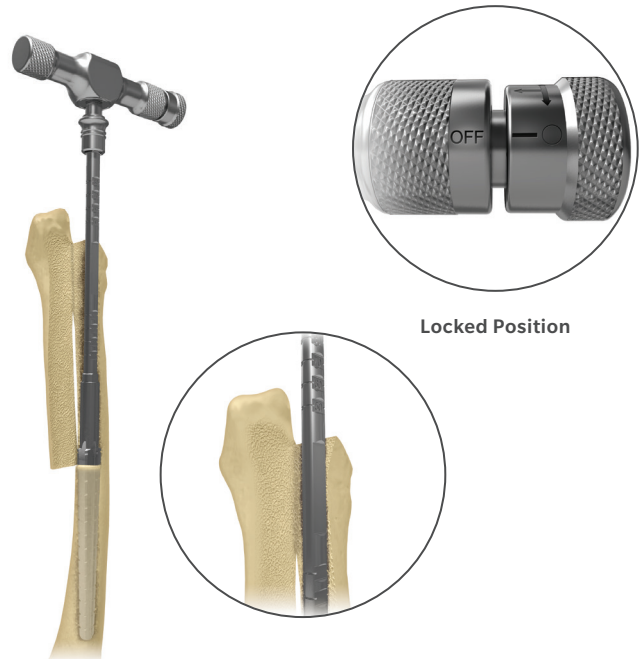

Figure 57

### Femoral Osteotomy

When utilizing the ETO distal stem the only assembly option is the ream-over technique. Due to its distinct design, this stem should only be used in cases when there is an osteotomy of the femur that allows for reaming of the most distal aspect of the femur (into and below the anatomic bow) (Figure 56).

### Preparation of the Diaphysis

To prepare the femur for the ETO distal stem, select the STS reamers (silver reamers correspond to the 150 mm/250 mm ETO STS stem lengths). Assemble the STS reamer to the T-handle and turn the handle from torque limiting to the locked position.

ⓘ **Note:** Reference the set of depth etch markings closest to the T-handle. The reamer flutes are also marked with additional depth etch marks to allow for a visual reference from the osteotomy level.

Ream the femur in 1 mm increments by hand until the reamer advances to the 70 mm mark, referencing the tip of the greater trochanter and measuring the reaming depth from the more proximal depth marks (Figure 57).

- ⓘ **Note:** Reaming to the 70 mm mark allows for a proximal height adjustment of 10 mm in either direction (e.g. 60 mm–80 mm) depending on the final seated depth of the distal stem implant.
- ⓘ **Note:** The final depth of the implant may vary from the depth of the reamer in this step. How aggressively the femur is prepared and the quality of the bone may impact the depth that the final implant will seat. If the final implant sits proud of the desired ream depth, note the difference between these and utilize the last reamer used to ream deeper into the femur. Reaming the femur by hand may help avoid any discrepancy between the reamed depth and the final depth of the implant.

## ETO (Extended Trochanteric Osteotomy) Distal Stem Ream-Over Technique

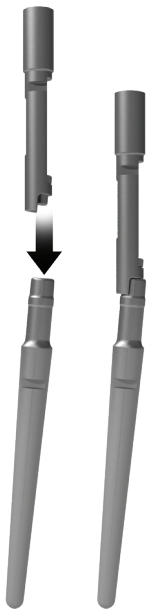

Figure 58

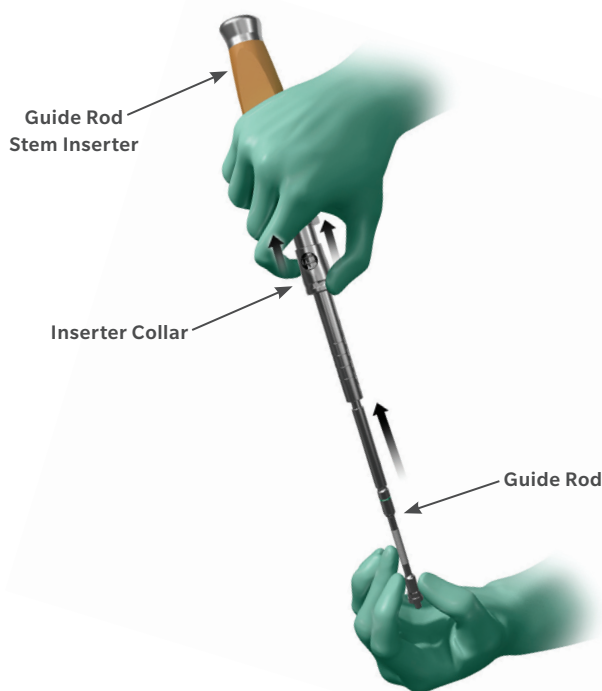

Figure 59

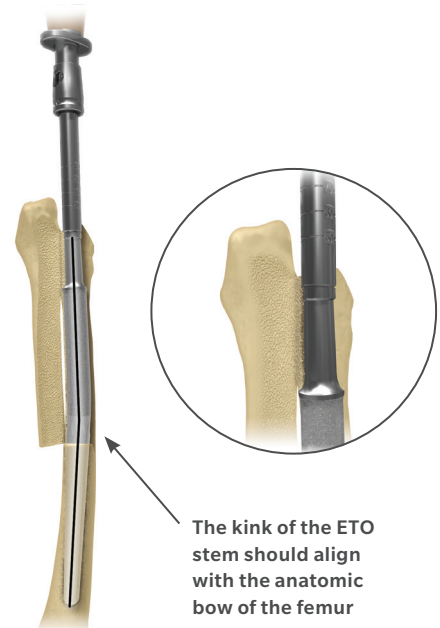

Figure 60

### Distal Stem Trial

When distal reaming is complete, assemble the Arcos ETO Trial Extension to the 150 mm length STS trial that is the same diameter of the final reamer, using the 3.5 mm hex driver. This will provide a 250 mm length trial stem. Once the extension has been added, thread the black distal stem trial inserter into the ETO trial and insert it into the femur such that the kink in the trial matches the anatomic bow of the femur and the distal stem is seated to the previously determined depth level, referencing the greater trochanter (Figure 58).

**Note:** The proximal portion of the ETO trial extension will work with all of the STS 150 mm trials and is intended to determine distal fixation.

### Distal Stem Insertion

Once the final stem size has been determined, assemble the guide rod to the orange guide rod stem inserter by sliding the rod into the inserter, pulling back on the inserter collar and locking the rod into the inserter (Figure 59).

Thread the inserter assembly to the distal stem implant and insert the implant into the femur such that the kink in the implant matches the anatomic bow of the femur and the distal stem is seated to the previously determined depth level, referencing the greater trochanter. Once the implant has been seated to the desired level, identify the depth on the inserter in reference to the greater trochanter to determine the height of the cone proximal body needed (Figure 60).

**Note:** The 50 mm, size A cone proximal body implant was not designed to accommodate a trochanteric bolt and claw. If a trochanteric bolt and claw is desired, utilize a cone proximal body implant with a 60, 70 or 80 mm vertical height.



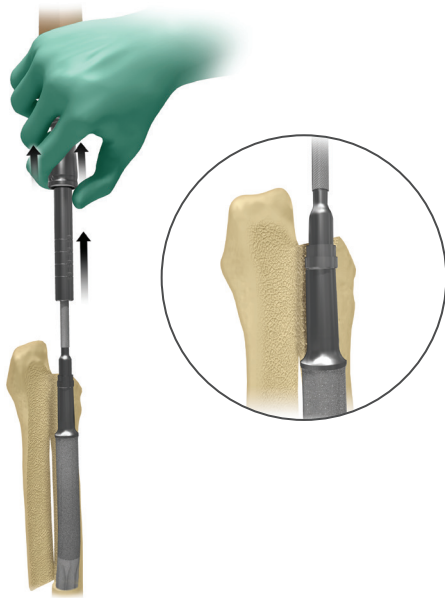

Figure 61

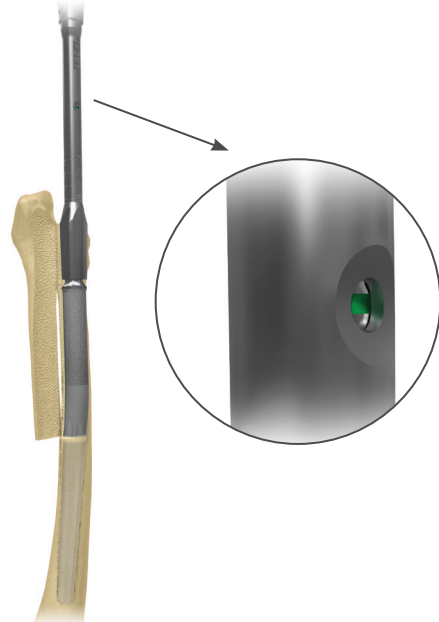

Figure 62

## Preparation of the Metaphysis

To ream the proximal femur, release the inserter from the guide rod by pulling back on the collar spring to disengage the reaming guide and remove the stem inserter, leaving the guide rod attached to the distal stem (Figure 61).

Ream the proximal femur over the guide rod with the proximal reamers until they no longer advance. A green line is visible through the proximal reamer window verifying that the reamer is fully seated and the proper reaming depth is obtained. Sequentially increase the size of the reamers until the desired proximal body size (A–G) is achieved (Figure 62).

## ETO (Extended Trochanteric Osteotomy) Distal Stem Ream-Over Technique

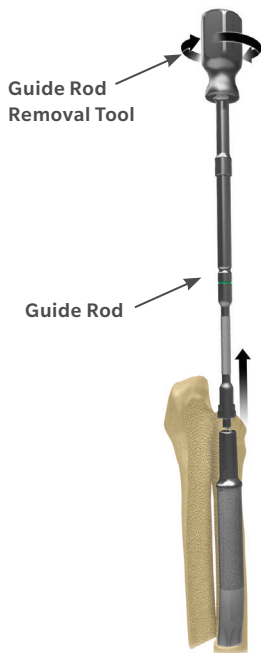

Figure 63

Remove the guide rod from the distal stem implant with the guide rod removal tool, turning the removal tool counter-clockwise (Figure 63).

### Trialing the Proximal Body

To trial the proximal body, first ensure that the taper junction on the distal stem implant is clean and dry. Attach the cone trial that is the same height and diameter as the final proximal reamer and the appropriate offset. The light green trial indicates standard offset, while the purple trial represents high offset.



Figure 64

Assemble the 3.5 mm hex driver to the T-handle and adjust the T-handle to the torque limiting position. Tighten the proximal body trial to the distal stem implant until the T-handle “clicks,” setting the desired anteversion or retroversion in the proximal body (Figure 64).

- ⓘ **Note:** The anti-rotation handle can be placed over the trial neck to control anteversion or retroversion.
- ⓘ **Note:** In cases with good medial bone stock, impingement between the medial neck and bone may occur causing the trial to not properly seat. Using the appropriate hand tools such as a rongeur, remove the excess bone and re-seat the trial before choosing a final implant.

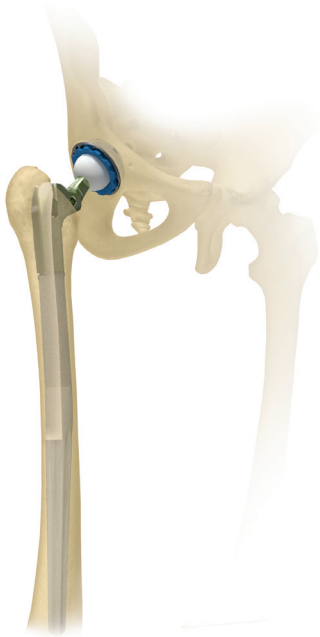

Figure 65



Figure 66

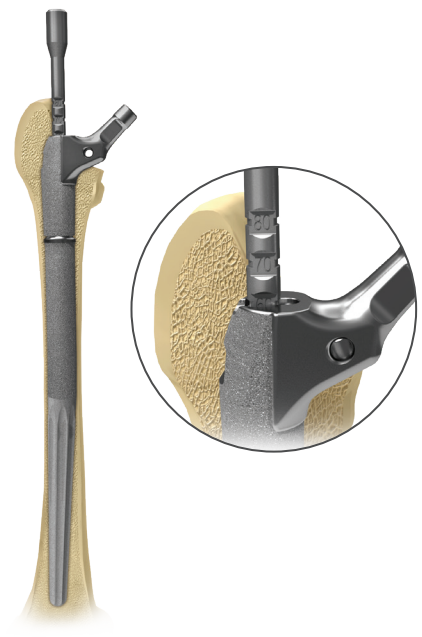

Figure 67

## Trial Reduction

Reduce the hip to ensure that proper leg length and joint stability have been achieved (Figure 65). In performing the trial range of motion, ensure the absence of impingement of the neck on the rim of the acetabular component or acetabular liner. Remove the cone proximal body trial from the femur with the 3.5 mm hex driver.

## Proximal Body Insertion

**Note:** Reference the Taper Compression Assembly Section of this technique (pg. 57) if an impaction assembly is not preferred.

Once the proper body height and size has been determined, thread the green proximal body inserter to the proximal body implant, ensuring the anti-rotation tabs are locked in the proper orientation.

Impact the proximal body to the taper junction on the distal stem implant with blows of the mallet (Figure 66). The implant will be seated when there is an audible change in the pitch during impaction or the etch mark of the inserter handle is advanced to the previously determined ream depth.

**Note:** To confirm that the proximal body is fully seated onto the taper junction an optional taper engagement tool is available. Insert the taper engagement tool into the top of the proximal body. Verify that the etch mark depth (50, 60, 70 or 80) on the engagement tool aligns with the lateral shoulder of the proximal body implant chosen (Figure 67). The taper engagement tool may only be used prior to inserting the locking screw.

## ETO (Extended Trochanteric Osteotomy) Distal Stem Ream-Over Technique

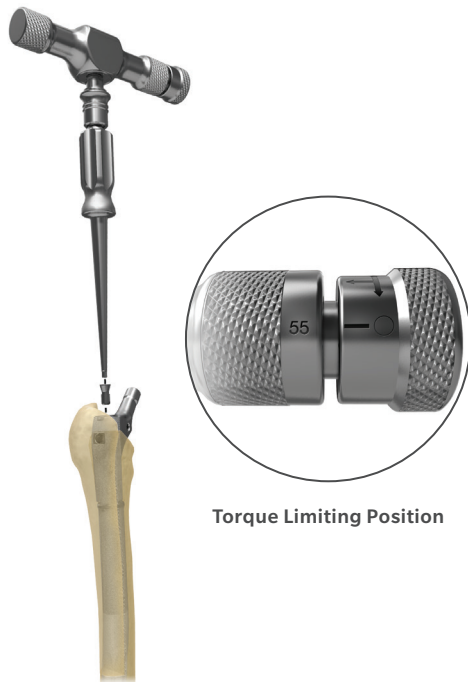

Figure 68

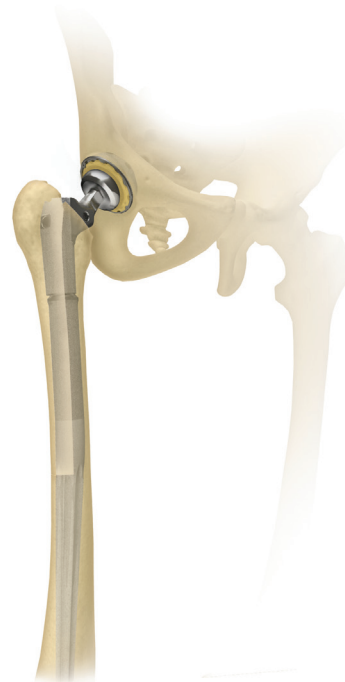

Figure 69

### Inserting the Locking Screw

To lock the distal and proximal body implants, thread the locking screw into the top of the proximal body using the 3.5 mm T-handle in the torque limiting position until a “click” is felt and heard (Figure 68).

**Note:** If the screw does not thread into the distal stem the proximal body is not fully seated and the implant insertion steps must be repeated.

### Final Reduction

If desired, another trial reduction can be accomplished prior to selecting final head size and impacting the modular head onto the stem (Figure 69). Provisional heads in seven neck lengths allow an additional trial reduction using the actual implant to ensure proper leg length and stability. After fully seating the femoral component, impact the appropriate modular head onto the clean, dry taper.

## Cone Proximal Body & Interlocking Distal Stem Ream-Over Technique



Figure 70



Figure 71

### Overview

Arcos Interlocking Distal Components have been designed to augment stem rotational stability in cases where primary fixation may be compromised due to sclerotic or deficient bone stock, or to stabilize a femoral fragment in cases of fracture when additional fixation is deemed necessary. The interlocking distal components can only be implanted using the ream-over surgical technique.

### Preparation of the Diaphysis

To prepare the femur for the interlocking distal stem, select flexible or thin shaft reamers and sequentially ream the femur two cortical diameters or 2-3 cm below the distal defect, increasing size until cortical ‘chatter’ is achieved (Figure 70). When utilizing the interlocking distal stem for cases where a fracture is evident and screw fixation is to be used, the most proximal of the distal fixation screw holes must be at least 2-3 cm below the fracture point (Figure 71).

**Note:** When utilizing flexible reamers, ream the canal in 0.5 mm increments until cortical ‘chatter’ is achieved. The final reamer diameter will depend on the length of press-fit/intact bone and the bone quality of the femur. The final reamer diameter may be .5 mm smaller than the diameter of the final implant in cases with poor bone quality and less press-fit length. Line-to-line or over-reaming may be necessary in cases with more press-fit/intact bone and better bone quality.

**Note:** Reaming over a guide is recommended. The Arcos Distal Reamers that are designed to prepare the femur for a bowed distal stem are cannulated to accommodate a guide wire.

## Cone Proximal Body & Interlocking Distal Stem Ream-Over Technique



Figure 72



Figure 73

### Preparation of the Metaphysis: Part One

To prepare the femur for the flared region of the interlocking distal stem, select the transition reamer that is the same size as the desired distal stem and ream to the depth of the desired proximal body height (60, 70 or 80 mm). The etch mark of the transition reamer, that corresponds to the proximal body height selected, should align with the tip of the greater trochanter (Figure 72).

ⓘ **Note:** The 50 mm, size A cone proximal body implant was not designed to accommodate a trochanteric bolt and claw. If a trochanteric bolt and claw is desired, utilize a cone proximal body implant with a 60, 70 or 80 mm vertical height.

### Trialing the Distal Stem

When distal reaming is complete, select the stem trial that is the same diameter as the final transition reamer and the necessary length for stem stability. Thread the distal trial stem inserter into the stem trial and insert the stem trial into the femur, matching the etched depth mark on the inserter to the depth achieved from the transition reamer (Figure 73).

ⓘ **Note:** The stem trial will be 1.5 mm smaller than the final implant diameter as measured over the porous coating.

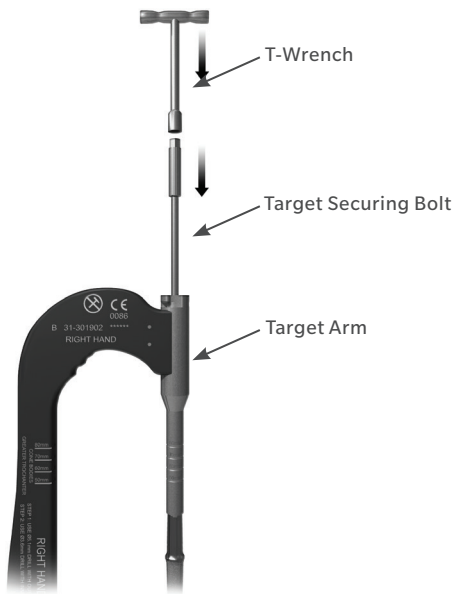

Figure 74



Figure 75



Figure 76

## Distal Stem Insertion

Interlocking distal stems should be assembled to the distal targeting device prior to insertion into the femur. It is also recommended that prior to inserting the interlocking stem into the femur a pre-alignment check is carried out. To carry out this alignment check, first assemble the targeting arm as shown (Figures 74 and 75). Once the targeting device is secure, slide a guide tube and drill into the targeting device that aligns with the most distal hole in the implant (Figure 76). If the drill aligns with the hole, then proceed to the next stage of the operation.

- Note:** The Arcos Distal Targeting Device is available in left and right versions. It is important to select the correct device prior to assembling to the interlocking distal stem.

## Cone Proximal Body & Interlocking Distal Stem Ream-Over Technique



Figure 77



Figure 78

### Distal Stem Insertion (cont.)

Insert the assembled Interlocking distal stem/distal targeting device into the femur by gently tapping the impaction handle (Figure 77). When the stem has been inserted to the correct level, as determined by the femoral reaming and trial, make note of the reference mark on the alignment device that corresponds with the tip of the greater trochanter (Figure 78).





Figure 79



Figure 80

## Distal Stem Retraction

- Note:** Should the stem need to be retracted, first twist the impaction handle until it locks onto the assembly (Figure 79). Then attach the slide hammer assembly as shown and utilize to retract the complete stem/distal targeting device assembly from the femur (Figure 80).

## Cone Proximal Body & Interlocking Distal Stem Ream-Over Technique

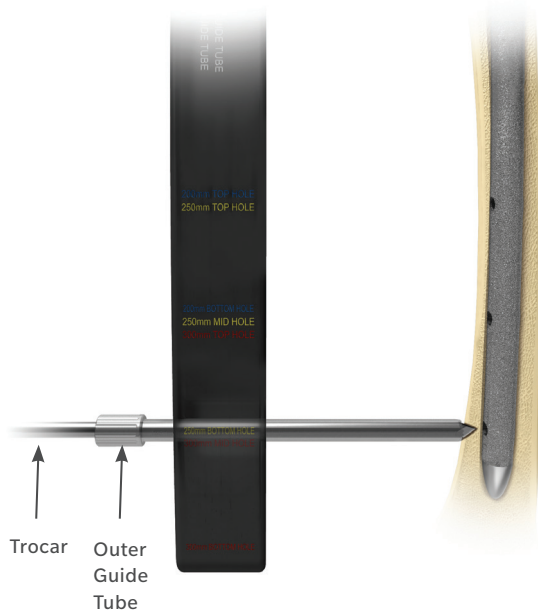

Figure 81

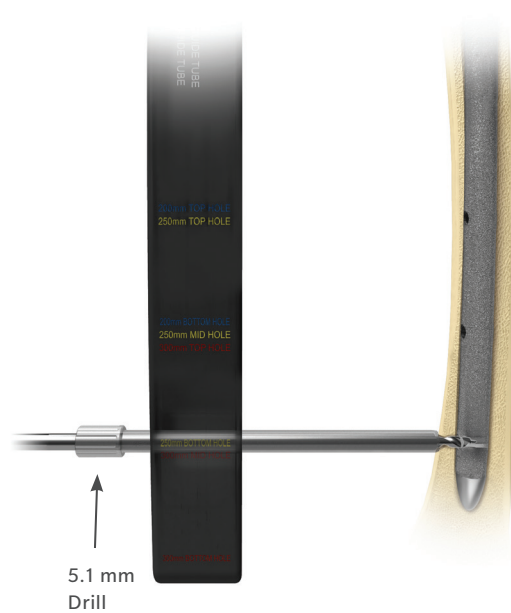

Figure 82

### Transverse Locking Screw Preparation

Once the soft tissues have been resected in the appropriate manner, insert the outer guide tube and trocar through the holes in the distal targeting device. The trocar point is used to create an 'indent' in the lateral cortex (Figure 81). The trocar is then removed from the outer guide tube and replaced with a 5.1 mm twist drill. This drill is then used to perforate the lateral cortex. This drill contains a 'built-in' stop to prevent it from advancing any further than 20 mm (Figure 82).

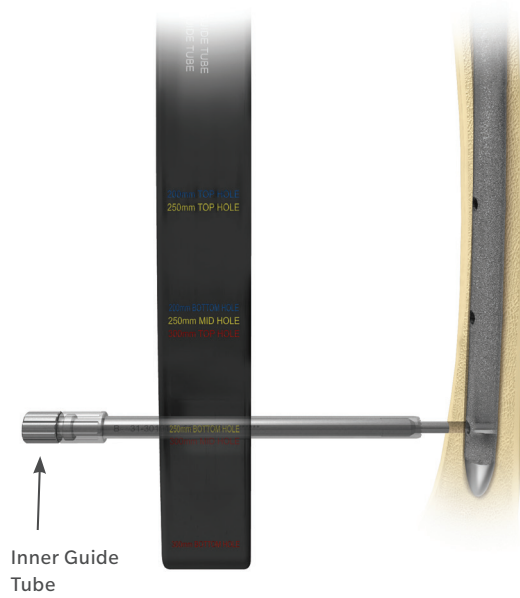

Figure 83

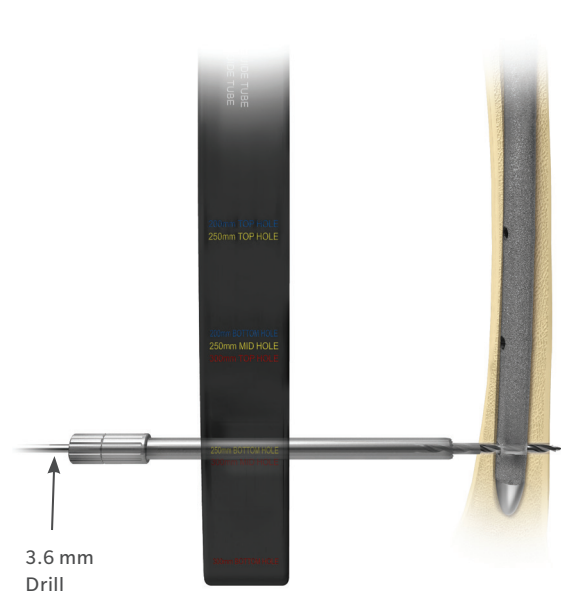

Figure 84

## Transverse Locking Screw Insertion

When drilling of the lateral cortex has been completed, insert the inner guide tube into the outer guide tube ensuring that it is fully seated against the lateral cortex (Figure 83). The 3.6 mm twist drill is then used to perforate the medial cortex (Figure 84).

## Cone Proximal Body & Interlocking Distal Stem Ream-Over Technique

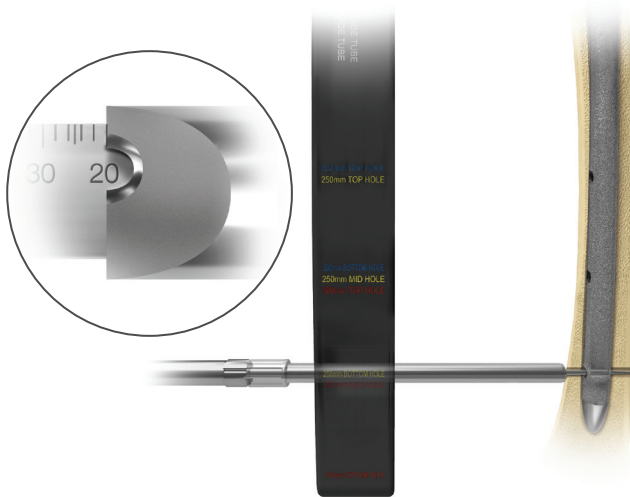

Figure 85

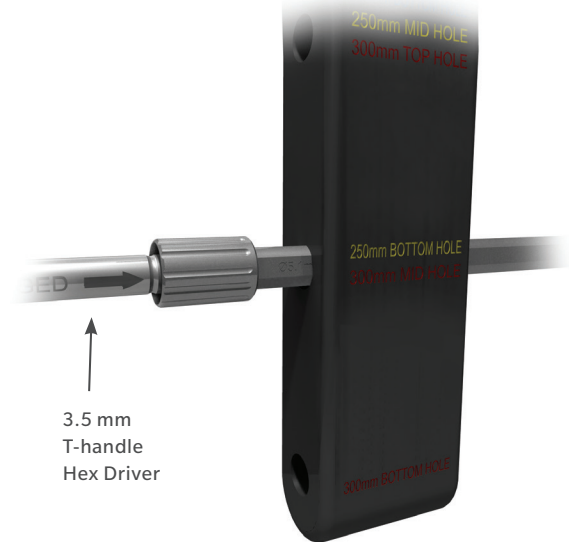

Figure 86

### Transverse Locking Screw Insertion (cont.)

Remove the inner guide tube, insert the depth gauge into the outer guide tube and advance through both cortices. Use the depth gauge to determine the correct length of interlocking stem screws needed (Figure 85). Once selected, insert the screw into the outer guide tube and utilize the 3.5 mm T-handle hex driver to tighten the screw in position. The 3.5 mm T-handle hex driver contains a marker groove that highlights when the screw is fully seated (Figure 86). Repeat this step along the stem until each drilled hole has been secured with a screw.

**Note:** It is recommended that at least two screws are used.



Figure 87



Figure 88

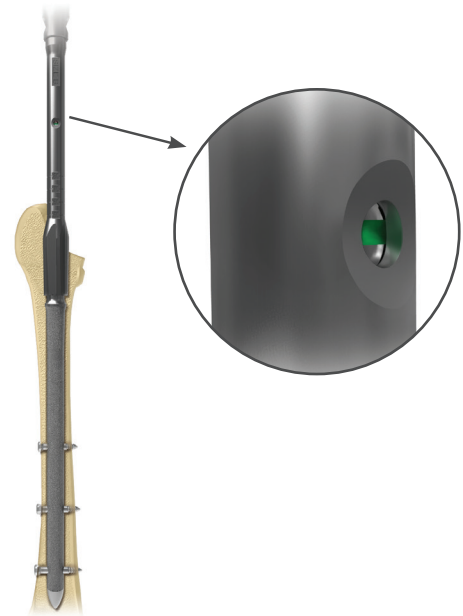

Figure 89

## Preparation of the Metaphysis: Part Two

Prior to reaming the proximal femur, first remove the distal targeting device assembly from the interlocking distal stem. Then, attach the reaming guide rod to the threaded hole in the proximal part of the distal stem (Figures 87 and 88).

**Note:** The reaming guide rod must be attached to the stem to properly ream-over the taper junction. The rod protects the taper junction from reamer damage and provides for accurate reaming depth.

Ream the proximal femur over the reaming guide rod with the proximal reamers until they no longer advance.

A green line is visible through the proximal reamer window verifying that the reamer is fully seated and the proper reaming depth is obtained. Sequentially increase the size of the reamers until the desired proximal body size (A–G) is achieved (Figure 89).

## Cone Proximal Body & Interlocking Distal Stem Ream-Over Technique

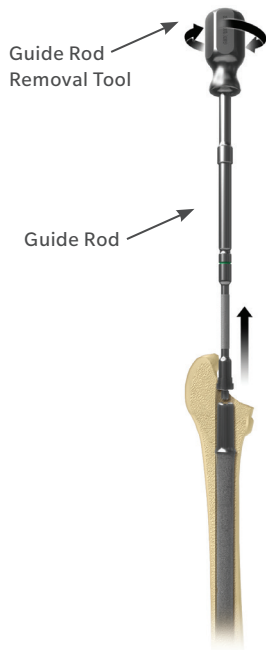

Figure 90



Figure 91

### Preparation of the Metaphysis: Part Two (cont.)

Remove the guide rod from the distal stem implant with the guide rod removal tool, turning the removal tool counter-clockwise (Figure 90).

### Trialing the Proximal Body

To trial the proximal body, first ensure that the taper junction on the distal stem implant is clean and dry. Attach the cone trial that is the same height and size as the final proximal reamer and the appropriate offset. The light green trial indicates standard offset and the purple trial represents high offset. Assemble the 3.5 mm hex driver to the T-handle and adjust the T-handle to the torque limiting position. Tighten the cone trial to the distal stem implant until the T-handle “clicks,” setting the desired anteversion or retroversion in the proximal body (Figure 91).

ⓘ **Note:** The anti-rotation handle can be placed over the neck of the trial to control anteversion or retroversion. Once the desired version has been achieved, use electrocautery to mark the desired position under the neck on the remaining bone stock.

ⓘ **Note:** In cases with good medial bone stock, impingement between the medial neck and bone may occur causing the trial to not properly seat. Using the appropriate hand tools such as a rongeur, remove the excess bone and re-seat the trial before choosing a final implant.



Figure 92

## Trial Reduction

Utilizing modular head trials, perform a trial reduction and determine if the selected offset, leg length and joint stability are appropriate (Figure 92). In performing the trial range of motion, ensure the absence of impingement of the neck on the rim of the acetabular component or acetabular liner. Remove the cone trial from the femur with the 3.5 mm hex driver.

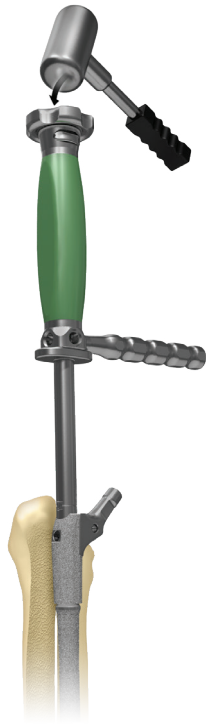

Figure 93



Figure 94

## Proximal Body Insertion

**Note:** Reference the Taper Compression Assembly Section of this technique (pg. 57) if an impaction assembly is not preferred.

Once the proper body height and size has been determined, thread the green proximal body inserter to the proximal body implant, ensuring the anti-rotation tabs are locked in the proper orientation.

Impact the proximal body to the taper junction on the distal stem implant with blows of the mallet (Figure 93). The implant will be seated when there is an audible change in the pitch during impaction or the etch mark of the inserter handle is advanced to the previously determined ream depth.

**Note:** To confirm that the proximal body is fully seated onto the taper junction an optional taper engagement tool is available. Insert the taper engagement tool into the top of the proximal body. Verify that the etch mark depth (50, 60, 70 or 80) on the engagement tool aligns with the lateral shoulder of the proximal body implant chosen (Figure 94). The taper engagement tool may only be used prior to inserting the locking screw.





Figure 95

## Inserting the Locking Screw

To lock the distal and proximal body implants, thread the locking screw into the top of the cone proximal body using the 3.5 mm hex driver and T-handle in the torque limiting position until a “click” is felt and heard (Figure 95).

ⓘ **Note:** If the screw does not thread into the distal stem the proximal body is not fully seated and the implant insertion steps must be repeated.

ⓘ **Note:** If the screw does not thread into the distal stem the proximal body is not fully seated and the implant insertion steps must be repeated.

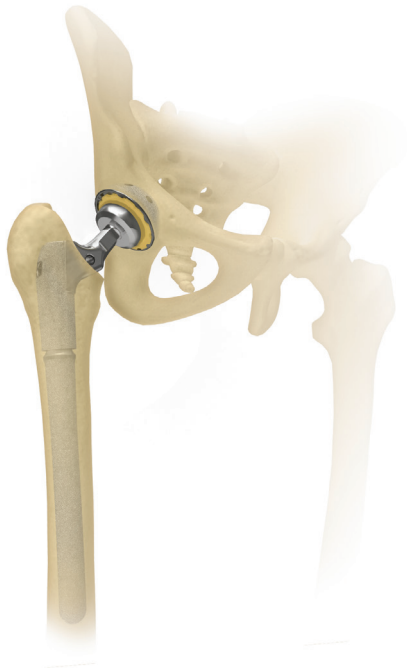

Figure 96

## Final Reduction

If desired, another trial reduction can be accomplished prior to selecting final head size and impacting the modular head onto the stem (Figure 96). Provisional heads in seven neck lengths allow an additional trial reduction using the actual implant to ensure proper leg length and stability. After fully seating the femoral component, impact the appropriate modular head onto the clean, dry taper.

## Trochanteric Reattachment Technique



Figure 97



Figure 98

### Attaching the Trochanteric Bolt Guide

Once the final implant has been reduced, the osteotomy can be repaired and stabilized by choosing one of the auxiliary options available in the Arcos System and attaching it directly to the implant.

Depending on the surgical approach and operative hip, select the appropriate trochanteric bolt guide instrument (Figure 97).

Use the 5.0 mm hex driver to thread the trochanteric bolt guide into the insertion hole on the proximal body, ensuring the anti-rotation tabs are locked to the proximal body implant. Place the trochanteric fragment between the implant and the trochanteric bolt guide (Figure 98).

If utilizing the trochanteric claw use the claw trials (large or small) to select the needed width.

⊖ **Note:** Guide may be easier to attach before hip is reduced.

⊖ **Note:** All proximal body designs accept a bolt and claw except the 50A cone and 50A calcar bodies.

## Trochanteric Reattachment Technique

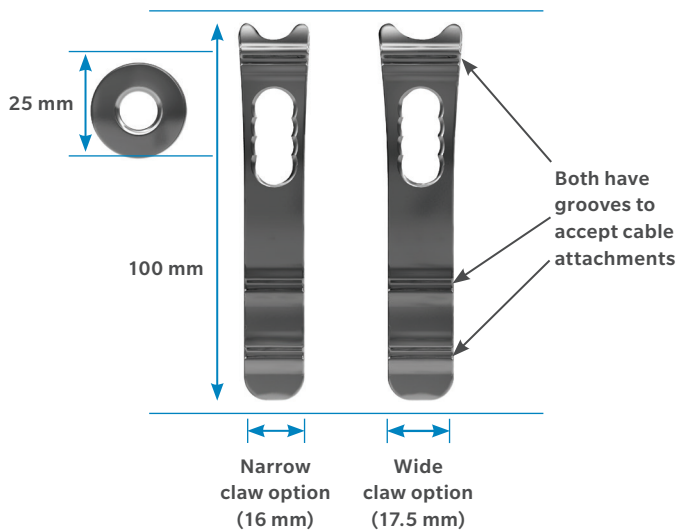

Figure 99

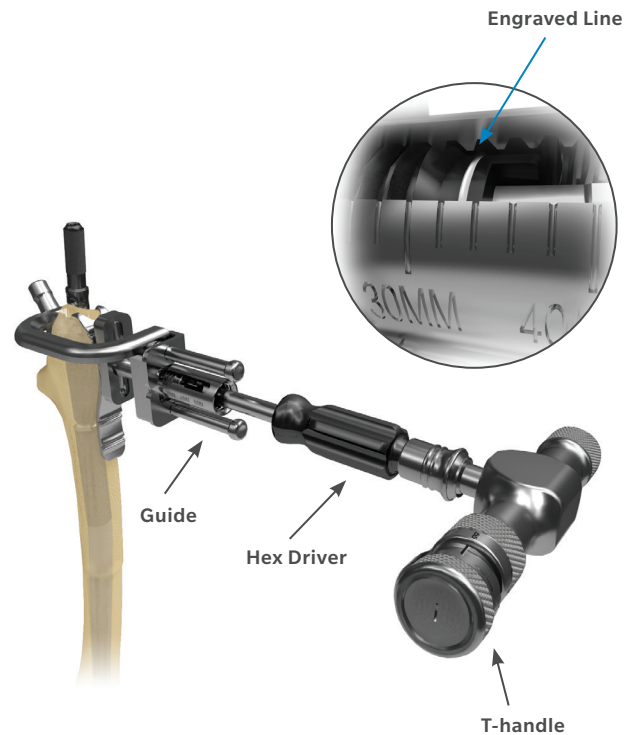

Figure 100

### Preparing for Auxiliary Implant Attachment

**Note:** Both the large and small claw are 100 mm in length, measured from top to bottom. The button is 25 mm in diameter (Figure 99).

Once the trochanteric fixation option has been determined, compress the auxiliary implant to the bone fragment by threading the plunger tightly against the auxiliary implant using the 5.0 mm hex driver and T-handle in the torque limiting position (Figure 100).

**Note:** If utilizing the claw auxiliary option, ensure that the head of the plunger is aligned with a hole in the claw to ensure that the bolt will pass through the claw into the implant.

Choose the trochanteric bolt drill bit that matches the size of the proximal body implant (Size A–G) regardless of height or body style. Select the bolt length that corresponds with the depth marks on the outside of the trochanteric bolt guide as measured according to the position of the engraved line on the plunger.

**Example:** If a size B cone body is used, select the size B trochanteric bolt drill bit. Selecting the correct size will prevent the drill from contacting the implant.

**Note:** Bolts are available in 2 mm increments.

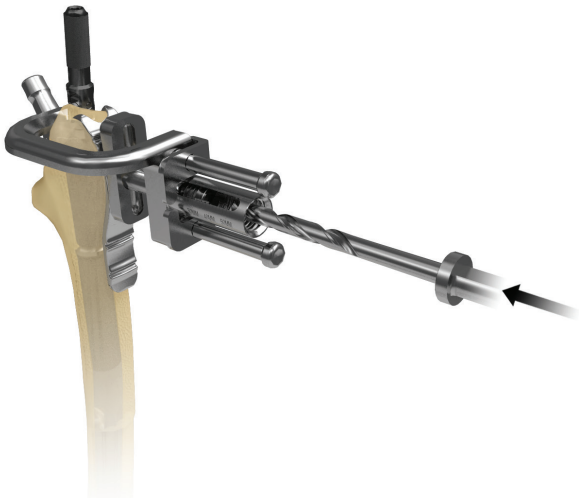

Figure 101

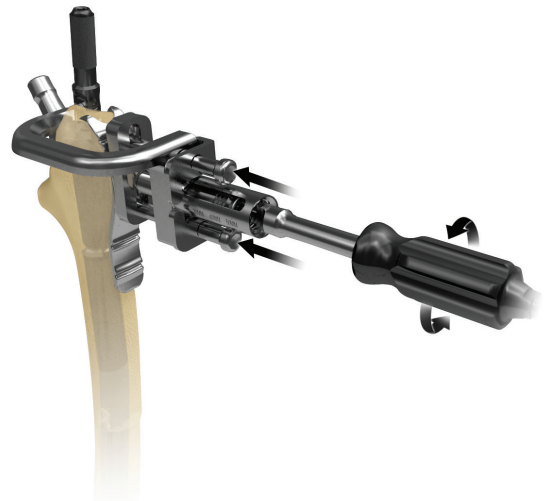

Figure 102

### Preparing for Auxiliary Implant Attachment (cont.)

Advance the appropriate size drill bit through the plunger until the built-in stop bottoms out on the cylindrical surface of the outrigger (Figure 101).

ⓘ **Note:** It is not possible to drill through the bolt hole on the claw trial, preparation must be performed with the final implant in place.

Compress the arms of the trochanteric bolt guide tightly to the auxiliary implant and remove the measurement plunger with the 5.0 mm hex driver (Figure 102). Attach the 5.0 mm hex driver to the T-handle and set to torque limiting position.

## Trochanteric Reattachment Technique

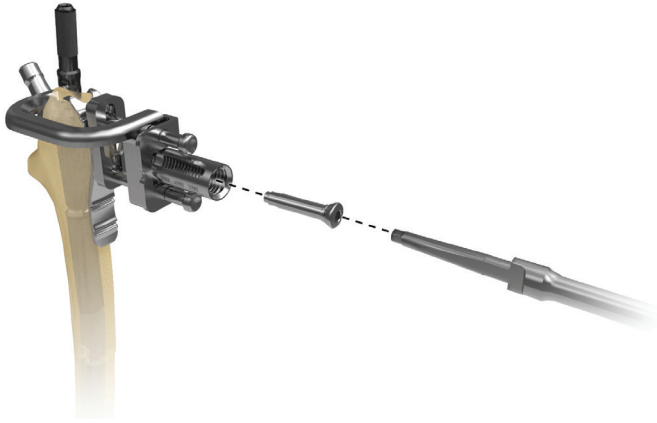

Figure 103



Figure 104

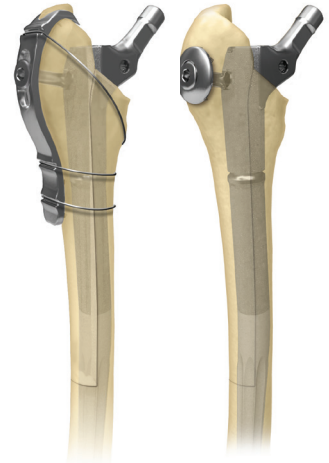

Figure 105

### Final Attachment of the Auxiliary Implant

Thread the bolt through the trochanteric bolt guide and into the proximal body until a “click” is felt and heard (Figure 103).

ⓘ **Note:** It may be necessary to give the T-handle a few small taps with the mallet to ensure the bolt drops into the hole in the proximal body.

Once the bolt is secured to the implant, unthread the trochanteric bolt guide from the proximal body using the 5.0 mm hex driver (Figure 104).

ⓘ **Note:** If utilizing the claw auxiliary option, cables may be added in the grooves of the claw for additional stability (Figure 105).

ⓘ **Note:** If the trochanteric bolt guide is difficult to remove, unthread the trochanteric bolt by  $\frac{1}{2}$  of a turn, remove the guide and retighten the bolt with the T-handle in torque limiting position.

## In-Femur Assembly

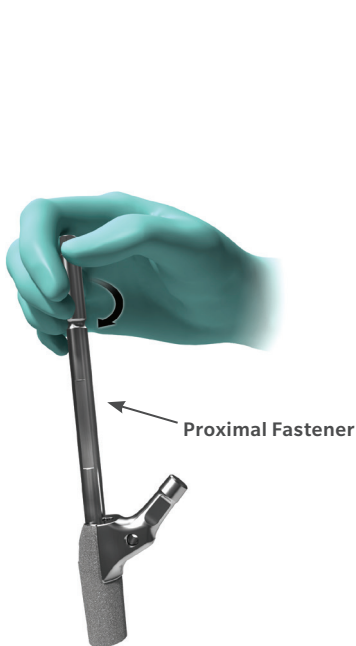

Figure 106

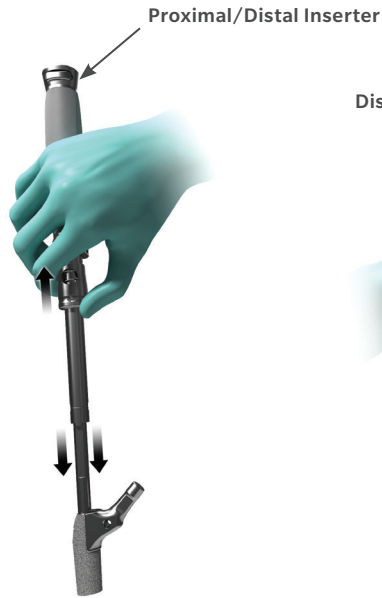

Figure 107

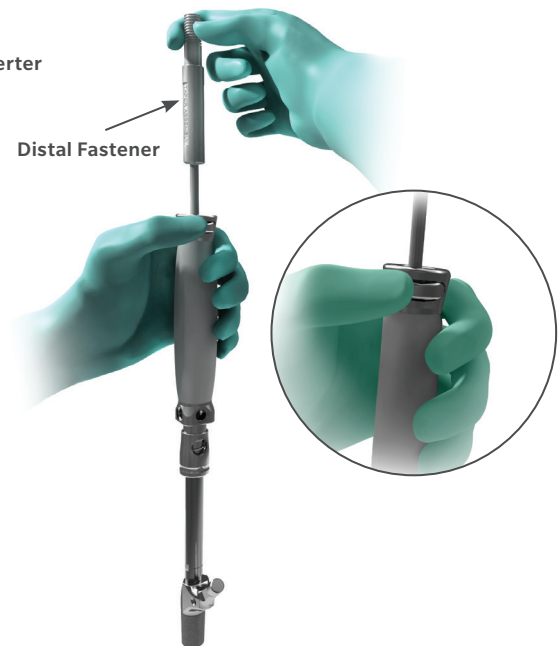

Figure 108

## Implant Assembly

The in-femur assembly tool can be utilized with any proximal body and PPS coated distal stem construct and was designed to allow for a bowed distal stem to seat in the proper anatomic orientation, independent of the proximal body implant.

Once the diaphysis and metaphysis has been prepared and trialed, the in-femur assembly tool can be utilized for the final insertion of the implant and to securely lock the taper junction.

Thread the proximal fastener into the insertion hole on the proximal body implant (Figure 106). Slide the fastener into the gray proximal/distal inserter, pulling back on the inserter collar and locking the fastener into the inserter (Figure 107). Ensure that the anti-rotation tabs are locked to the implant.

Place the distal fastener that matches the selected proximal body height into the proximal/distal inserter handle. Depress the button at the top of the proximal/distal inserter handle and insert the assembly rod into the inserter (Figure 108).

## In-Femur Assembly



Figure 109

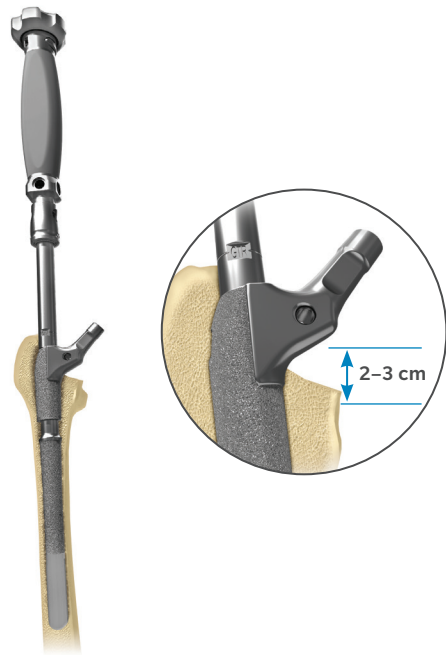

Figure 110

### Implant Assembly (cont.)

Insert the 5.0 mm hex driver to the top of the proximal/distal inserter handle, hold the taper junction apart and thread the distal fastener into the distal stem (Figure 109).

⊖ **Note:** Do not engage the taper junction when threading the distal fastener rod into the distal stem.

Attach the proximal/distal inserter handle strike plate, tightening until a “click” is felt and heard. Impact the proximal body until it is 2–3 cm proud of the desired depth (Figure 110).

⊖ **Note:** When a “click” is heard while tightening the strike plate, the proximal body and distal stem are separated and cannot be locked during insertion into the femur.



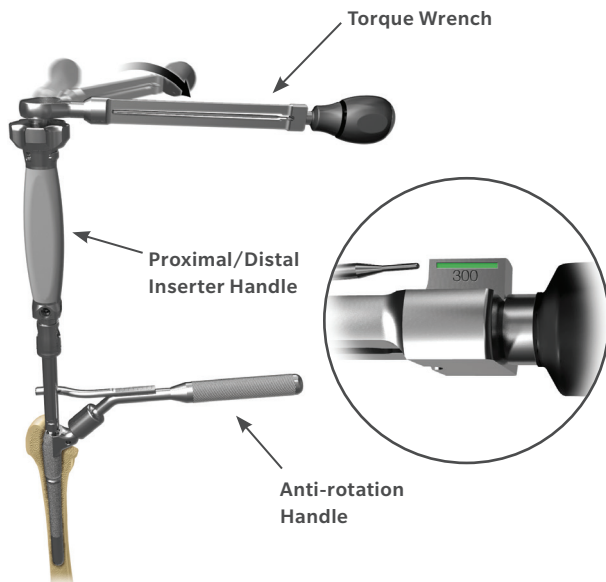

Figure 111



Figure 112

### Implant Assembly (cont.)

To fully engage the taper junction, attach the torque wrench to the end of the proximal/distal inserter handle strike plate, place the anti-rotation handle over the implant neck and tighten until 300 in-lbs is indicated on the torque wrench shaft (Figure 111).

Disassemble the torque wrench and anti-rotation handle. Impact the stem to the desired depth (Figure 112).

## In-Femur Assembly

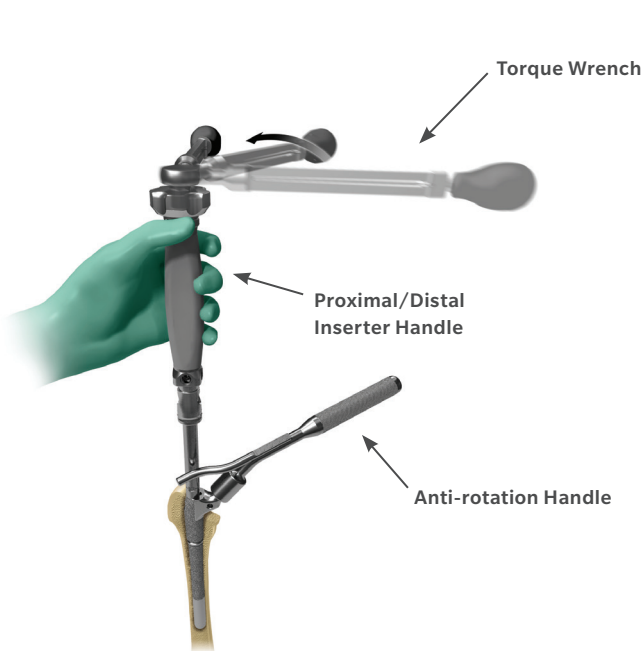

Figure 113



Figure 114

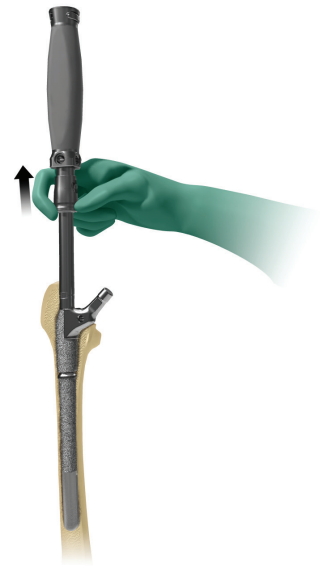

Figure 115

## Inserter Disassembly

To loosen the strike plate, use the anti-rotation handle to hold the neck of the implant. Turn the torque wrench counter-clockwise and depress the button at the top of the proximal/distal inserter handle and unthread the strike plate (Figure 113).

Unthread the distal fastener from the distal stem implant using the 5.0 mm hex. Disengage the proximal/distal inserter by pulling back on the inserter collar (Figures 114 and 115).



Figure 116

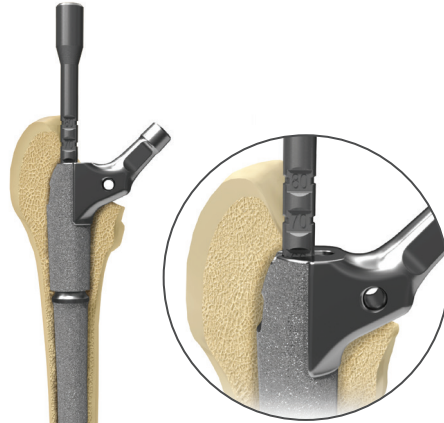

Figure 117



Torque Limiting Position

Figure 118

### Inserter Disassembly (cont.)

To remove the proximal fastener, utilize the taper assembly driver and unthread the proximal fastener from the proximal body implant (Figure 116).

ⓘ **Note:** This inserter disassembly technique will NOT disassemble the implant.

ⓘ **Note:** To confirm that the proximal body is fully seated onto the taper junction an optional taper engagement tool is available. Insert the taper engagement tool into the top of the proximal body. Verify that the etch mark depth (50, 60, 70 or 80) on the engagement tool aligns with the lateral shoulder of the proximal body implant chosen (Figure 117). The taper engagement tool may only be used prior to inserting the locking screw.

### Inserting the Locking Screw

To lock the distal and proximal body implants, thread the locking screw into the top of the proximal body using the 3.5 mm hex driver and T-handle in torque limiting position until a “click” is felt and heard (Figure 118).

ⓘ **Note:** If the screw does not thread into the distal stem the proximal body is not fully seated and the final implant assembly steps must be repeated.

## In-Femur Assembly

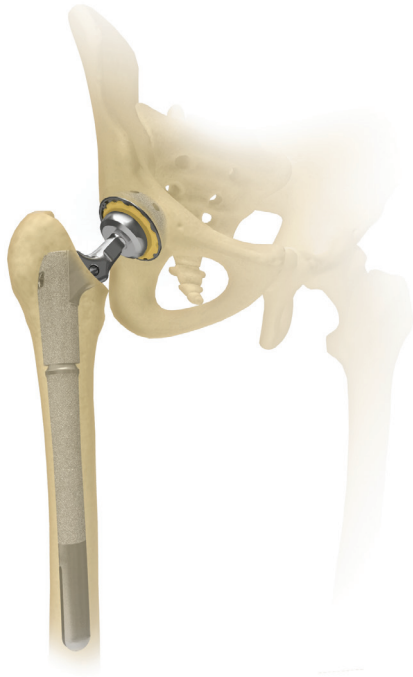

Figure 119

### Final Reduction

If desired, another trial reduction can be accomplished prior to selecting final head size and impacting the modular head onto the stem (Figure 119). Provisional heads in seven neck lengths allow an additional trial reduction using the actual implant to ensure proper leg length and stability. After fully seating the femoral component, impact the appropriate modular head onto the clean, dry taper.

## Taper Compression Assembly

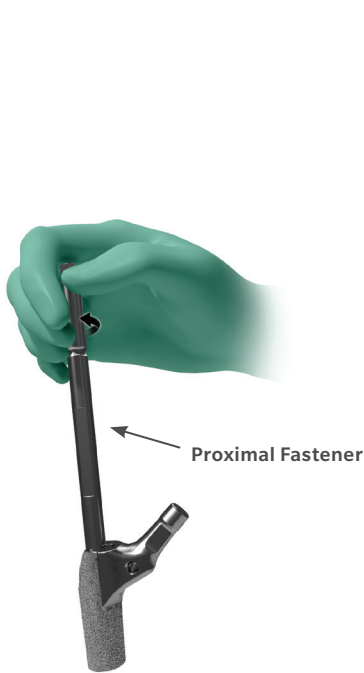

Figure 120



Figure 121

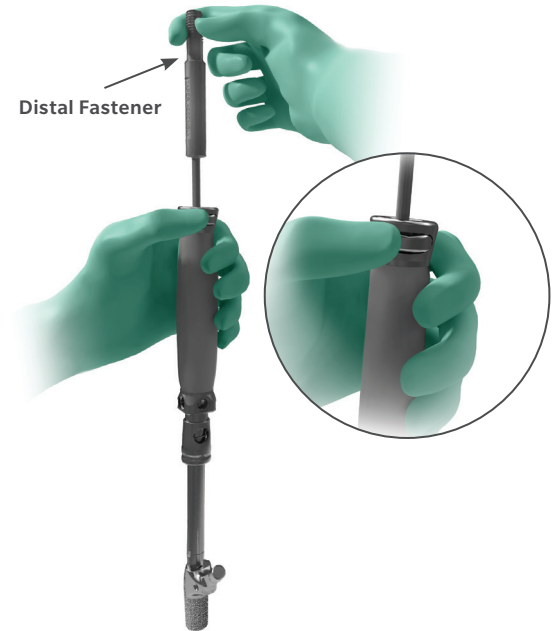

Figure 122

## Proximal Body Insertion

### Attaching the Proximal Body to the Distal Stem Implant

Once the desired offset has been chosen, ensure that the taper junction on the distal stem implant is clean and dry. Attach the proximal fastener to the cone proximal body implant by threading the proximal fastener into the insertion hole on the cone proximal body implant (Figure 120). Place the gray proximal/distal inserter handle over the proximal fastener by pulling back on the inserter collar and locking the fastener to the inserter (Figure 121). Ensure that the anti-rotation tabs are locked to the implant.

Place the distal fastener that matches the selected proximal body height into the proximal/distal inserter handle. Depress the button at the end of the proximal/distal inserter handle and insert the distal fastener into the inserter (Figure 122).

## Taper Compression Assembly



Figure 123



Figure 124

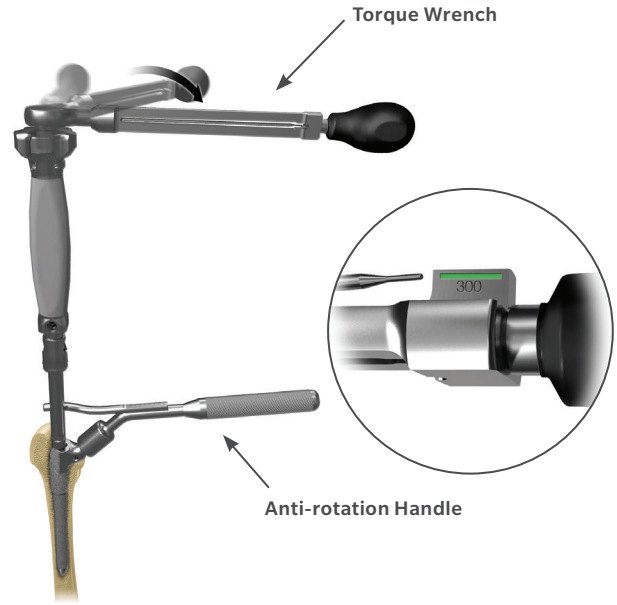

Figure 125

### Proximal Body Insertion (cont.)

Insert the 5.0 mm hex driver into the top of the proximal/distal inserter handle and tightly thread the distal fastener into the distal stem (Figure 123). Attach the proximal/distal inserter handle strike plate, tightening until a “click” is felt and heard.

Set the desired version of the cone proximal body implant by turning the strike plate clockwise until it stops (Figure 124).

To fully engage the implant taper junction, attach the torque wrench to the end of the proximal/distal inserter handle strike plate, place the anti-rotation handle to the implant neck and tighten until 300 in-lbs is indicated on the torque wrench shaft (Figure 125).

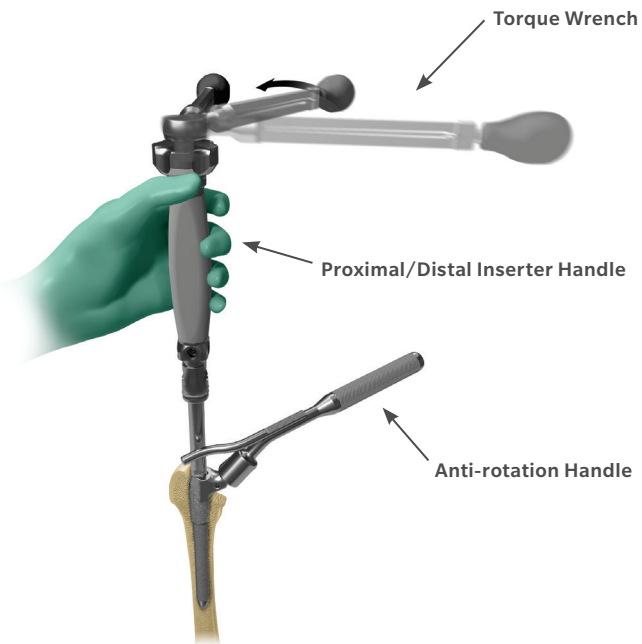

Figure 126



Figure 127

## Inserter Removal

To remove the inserter from the fully seated implant, turn the torque wrench counter-clockwise while leveraging the anti-rotation handle, depress the button at the top of the proximal/distal inserter handle and unthread the strike plate (Figure 126). Unthread the distal fastener from the distal stem implant using the 5.0 mm hex driver (Figure 127).

ⓘ **Note:** If the distal fastener is difficult to loosen with the 5.0 mm hex driver, attach the T-handle, set to the OFF position, and turn it counter-clockwise.

## Taper Compression Assembly

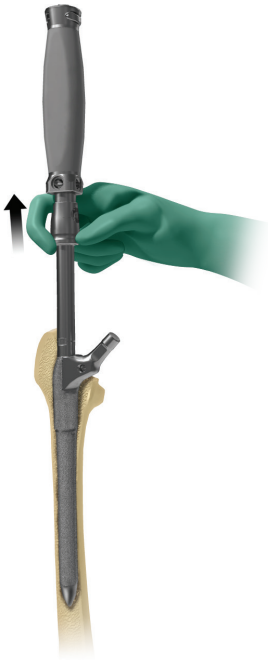

Figure 128



Figure 129

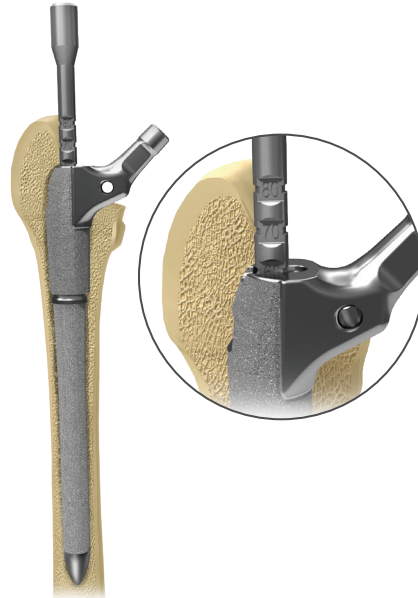

Figure 130

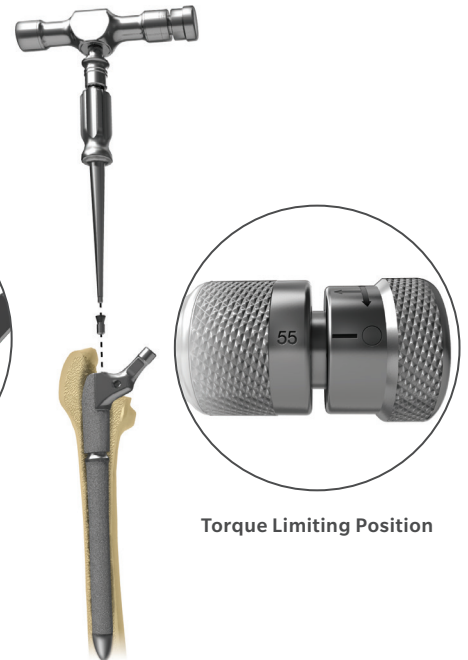

Figure 131

### Inserter Removal (cont.)

Disengage the proximal/distal inserter by pulling back on the inserter collar (Figure 128). To remove the proximal fastener, utilize the taper assembly driver and unthread the proximal fastener from the proximal body implant (Figure 129).

- ⓘ **Note:** This inserter disassembly technique will NOT disassemble the implant.
- ⓘ **Note:** To confirm that the proximal body is fully seated onto the taper junction an optional taper engagement tool is available. Insert the taper engagement tool into the top of the proximal body. Verify that the etch mark depth (50, 60, 70 or 80) on the engagement tool aligns with the lateral shoulder of the proximal body implant chosen (Figure 130). The taper engagement tool may only be used prior to inserting the locking screw.

### Inserting the Locking Screw

To lock the distal and proximal body implants, thread the locking screw into the top of the proximal body using the 3.5 mm hex driver and T-handle in torque limiting position until a “click” is felt and heard (Figure 131).

- ⓘ **Note:** If the screw does not thread into the distal stem the proximal body is not fully seated and the final implant assembly steps must be repeated.



## Disengaging the Taper Junction



Figure 132



Figure 133

### Disengaging the Proximal Body from the Distal Stem Implant

To disengage the proximal body implant from the distal stem, remove the locking screw with the 3.5 mm hex driver and thread the taper disassembly tool that matches the proximal body height to the proximal body implant (Figure 132). Attach the torque wrench to the taper disassembly tool and with the anti-rotation handle attached to the neck of the proximal body, turn the torque wrench clockwise until the proximal body disengages the distal stem (Figure 133). When resistance is felt, continue to slowly turn the torque handle and after each quarter turn of the handle, pull the underside of the taper disassembly tool until the proximal body disengages.

- Note:** When disengaging the taper junction within the femur the proximal body may feel tight within the bone although the taper junction is disengaged. This is due to the initial fixation of the PPS coating to the bone. Gently tap the underside of the taper disassembly tool with the mallet to extract the proximal body from the bone. Do NOT continue tightening the torque wrench as this may damage the implant.

Zimmer Biomet does not practice medicine. This technique was developed in conjunction with health care professionals. This document is intended for surgeons and is not intended for laypersons. Each surgeon should exercise his or her own independent judgment in the diagnosis and treatment of an individual patient, and this information does not purport to replace the comprehensive training surgeons have received. As with all surgical procedures, the technique used in each case will depend on the surgeon's medical judgment as the best treatment for each patient. Results will vary based on health, weight, activity and other variables. Not all patients are candidates for this product and/or procedure.

All content herein is protected by copyright, trademarks and other intellectual property rights, as applicable, owned by or licensed to Zimmer Biomet or its affiliates unless otherwise indicated, and must not be redistributed, duplicated or disclosed, in whole or in part, without the express written consent of Zimmer Biomet.

This material is intended for health care professionals. Distribution to any other recipient is prohibited.

**Caution:** Federal (USA) law restricts this device to sale by or on the order of a physician. Rx Only.

For indications, contraindications, warnings, precautions, potential adverse effects and patient counselling information, see the package insert or contact your local representative; visit [www.zimmerbiomet.com](http://www.zimmerbiomet.com) for additional product information.

Check for country product clearances and reference product specific instructions for use.

Not for Distribution in France.

© 2019, 2021 Zimmer Biomet

For ordering information refer to the following document :  
- 0531.X Global Ordering Information.



 **Legal Manufacturer**  
Biomet Orthopedics  
P.O. Box 587  
56 E. Bell Drive  
Warsaw, Indiana 46581-0587  
USA

**Legal Manufacturer**  
Biomet Trauma  
P.O. Box 587  
56 E. Bell Drive  
Warsaw, Indiana 46581-0587  
USA

**Legal Manufacturer**  
Biomet UK Ltd.  
Waterton Industrial Estate  
Bridgend  
CF31 3XA  
UK



CE mark on a surgical technique is not valid unless there is a CE mark on the product label.

For individual CE mark of implants and instrumentation, refer to the product label.

**Note:** For legal manufacturer of individual implants and instrumentation, please refer to the Ordering Information.