



VATS

V5 MICS





VATS / MICS INSTRUMENT TABLE OF CONTENTS

VATS MICS	2-3
PRODUCT FEATURES	2
QUALITY STATEMENT	3
VATS	4-35
CLAMPS	4-8
FORCEPS	9-16
GRASPERS	17
NEEDLE HOLDERS	18-21
KNOT TIE/PUSHERS	22
SCISSORS	23-24
RETRACTORS	25
CHEST TUBE PASSER	26
HOOKS/SUTURE PULLER	27
SCALPEL HOLDER/SUTURE PUSHER	28
EXTENDER	29
SUCTION/BRUSH	30-32
TROCAR/CANNULA	33
ACCESSORIES	34-35
MICS CORONARY	36-45
FORCEPS	36
CLIP APPLIERS	37
NEEDLE HOLDERS	38
KNOT TIE/PUSHERS	39
SCISSORS	40
CHEST TUBE PASSER	41
CLAMPS	42
ACCESSORIES	43-44
NOTES	45
MICS VALVE	46-65
CLAMPS	46
FORCEPS	47-49
CLIP APPLIERS	50
NEEDLE HOLDERS	51-53
KNOT TIE/PUSHERS	54
SCISSORS	55-56
CHEST TUBE PASSER	57
HOOKS/SUTURE PULLER/PUSHER	58
SCALPEL HOLDER/NEEDLE EXTENDER	59
SUCTION	60
BRUSH	61
CHORDAE SIZER/RONGUERS	62
ACCESSORIES	63-64
NOTES	65
EPIC VATS	66-73
CLAMPS	66
DISSECTORS	67
FORCEPS	68
SCISSORS	69
NOTES	70-73



A COMPLETE RANGE OF VATS & MICS INSTRUMENTS

Wexler has developed a complete line of instruments and products for Video Assisted Thoracoscopic Surgery (VATS) and Minimally Invasive Cardiac Surgery (MICS). Our products have been manufactured by skilled instrument craftsmen, using only the highest quality materials. Every effort is made to manufacture the finest quality surgical instruments at exacting specifications. Scan the QR code to see our full line of VATS & MICS instruments.



VATS Video Assisted Thoracoscopic Surgery

MICS Minimally Invasive Cardiac Surgery

UNIQUE DESIGNS

- **Sliding-Shaft w/Conventional Standard Handles:** Allows for full function of the instrument either through a port or a small thoracic incision.
- **Ergonomic Aluminum Squeeze Handles:** Ergonomic, light-weight design provides surgeons with a comfortable, easy-to-use handle, which allows for more concentration on the surgical technique.
- **10 Year Warranty on VATS Instruments:** Warranty covers manufacturing and material defects for 10 years.
- **1 Year Warranty on MICS Instruments:** Warranty covers manufacturing and material defects for 1 year.



Various Jaw Types



TC-Coated Jaws

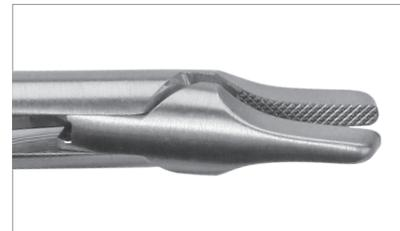

TC-Inserted Jaws

CUSTOMIZING AVAILABLE

Wexler combines your specifications, along with our experience in designing to produce the perfect instrument.



Custom Jaws

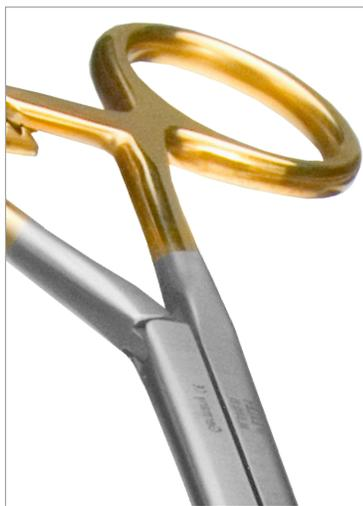

Custom Handles



Custom Tips

VATS•MICS

PRODUCTS



Wexler Surgical, Inc. is dedicated to providing innovative high quality specialty surgical instrumentation. Wexler guarantees that all of our products have been manufactured by skilled instrument craftsmen, using only quality materials. Every effort is made to manufacture the finest quality surgical instruments at exacting specifications. Wexler surgical instruments comply with the European Medical Device Directives and bare the **CE** Mark.

Ordering

Order your Wexler products by:
Online Order Entry: www.wexlersurgical.com
Email: sales@wexlersurgical.com
Atencion al cliente en Español:
salesLA@wexlersurgical.com
Fax: 713-723-6906
Phone: 713-723-6900 Toll Free: 800-414-1076
or with an authorized Wexler sales representative.

Shipping and Packaging

All of our products are thoroughly inspected and carefully packaged to prevent errors and damage while in transit. Please verify that the package is intact and unaltered, otherwise, please note it on the receiving documents and report it to Wexler's Customer Service department. All orders will be shipped FedEx Ground unless otherwise specified.

Attn: Customer Service Toll Free: 800-414-1076
11333 Chimney Rock Rd. Tel: 713-723-6900
Suite #110 Fax: 713-723-6906
Houston, TX 77035 sales@wexlersurgical.com
custservice@wexlersurgical.com

Terms

Terms of sales are net 30 days from invoice date. All merchandise is invoiced when the shipment is initially made. Wexler reserves the right to require adequate credit information and references. Wexler reserves the right to change credit terms to C.O.D. prior to shipping on credit and without prior notice to customer. Any outstanding invoice is subject to a monthly 1% interest surcharge.

Returned Merchandise

Unused merchandise may be returned for credit or exchanged within 30 days after the date of shipment. All returns must include a RMA #, available for calling, faxing or emailing Wexler's Customer Service. A 15% restocking fee will apply to merchandise returned within 30 days. No returns will be accepted after 30 days unless noted on invoice. No returns will be accepted on used, custom made, custom etched, discontinued or altered products unless noted on invoice.

Wexler's European Authorized Representative

CE Partner 4U
Attn: Theo Nusselder
Esdoornlaan 13
3951 DB, Maarn
The Netherlands



Tel: +31-6-516-536-26

Warranty

Wexler products are warranted to be free from defects in material and workmanship when used under normal condition for its intended purpose for 10 Year Warranty on VATS Instruments: Warranty covers manufacturing and material defects for 10 years. 1 Year Warranty on MICS Instruments: Warranty covers manufacturing and material defects for 1 year. Any instrument that proves to be defective during this period, Wexler will, at its sole discretion, either repair or replace the defective product at no charge. This limited warranty is null and void if a Wexler product is repaired or modified in any way by any party that is not explicitly Wexler authorized. Wexler Surgical, Inc. shall not be held responsible for consequential or indirect damage arising from the sale or use of any product.



THORACOSCOPIC DEBAKEY CLAMPS

Ring Handle | Curved Jaws



AL8210.12



AL8230.12
AL8226.12
AL8229.12
AL8229.12-A



AL8240.12



AL8250.12



CURVED 2x3
DEBAKEY JAWS

AL8250.12

CURVED 1x2
DEBAKEY JAWS

AL8240.12

Images not actual size

VATS•MICS

AL8210.12	Thoracoscopic DeBakey Clamp - 60mm Curved 1x2 DeBakey Atraumatic jaws, 5mm Shaft, w/Ratchet, (21cm Working Length), Stainless Steel, 12.25" (31cm)
AL8226.12	Thoracoscopic DeBakey Clamp - 65mm Curved Right 1x2 DeBakey Atraumatic jaws, 10mm Shaft, w/Lock, 17cm Working Length, Stainless Steel, 10.25" (26.4cm)
AL8229.12	Thoracoscopic DeBakey Clamp - 65mm Curved 1x2 DeBakey Atraumatic jaws, 10mm Shaft, w/Lock, 17cm Working Length, Stainless Steel, 10.25" (26.4cm)
AL8229.12-A	Thoracoscopic DeBakey Clamp - 65mm Curved 1x2 DeBakey Atraumatic jaws, 10mm Shaft, w/Lock, Angled Shanks, 17cm Working Length, Stainless Steel, 9.75" (24.8cm)
AL8230.12	Thoracoscopic DeBakey Clamp - 65mm Curved 1x2 DeBakey Atraumatic jaws, 10mm Shaft, w/Ratchet, (23cm Working Length), Stainless Steel, 12.75" (32cm)
AL8240.12	Thoracoscopic DeBakey Clamp - 100mm Curved 1x2 DeBakey Atraumatic jaws, 10mm Shaft, w/Ratchet, (25.5cm Working Length), Stainless Steel, 14.25" (36cm)
AL8250.12	Thoracoscopic DeBakey Clamp - 100mm Curved 2x3 DeBakey Atraumatic jaws, 10mm Shaft, w/Ratchet, (25.5cm Working Length), Stainless Steel, 14.25" (36cm)



THORACOSCOPIC DEBAKEY CLAMPS

Ring Handle | Straight / Curved Jaws

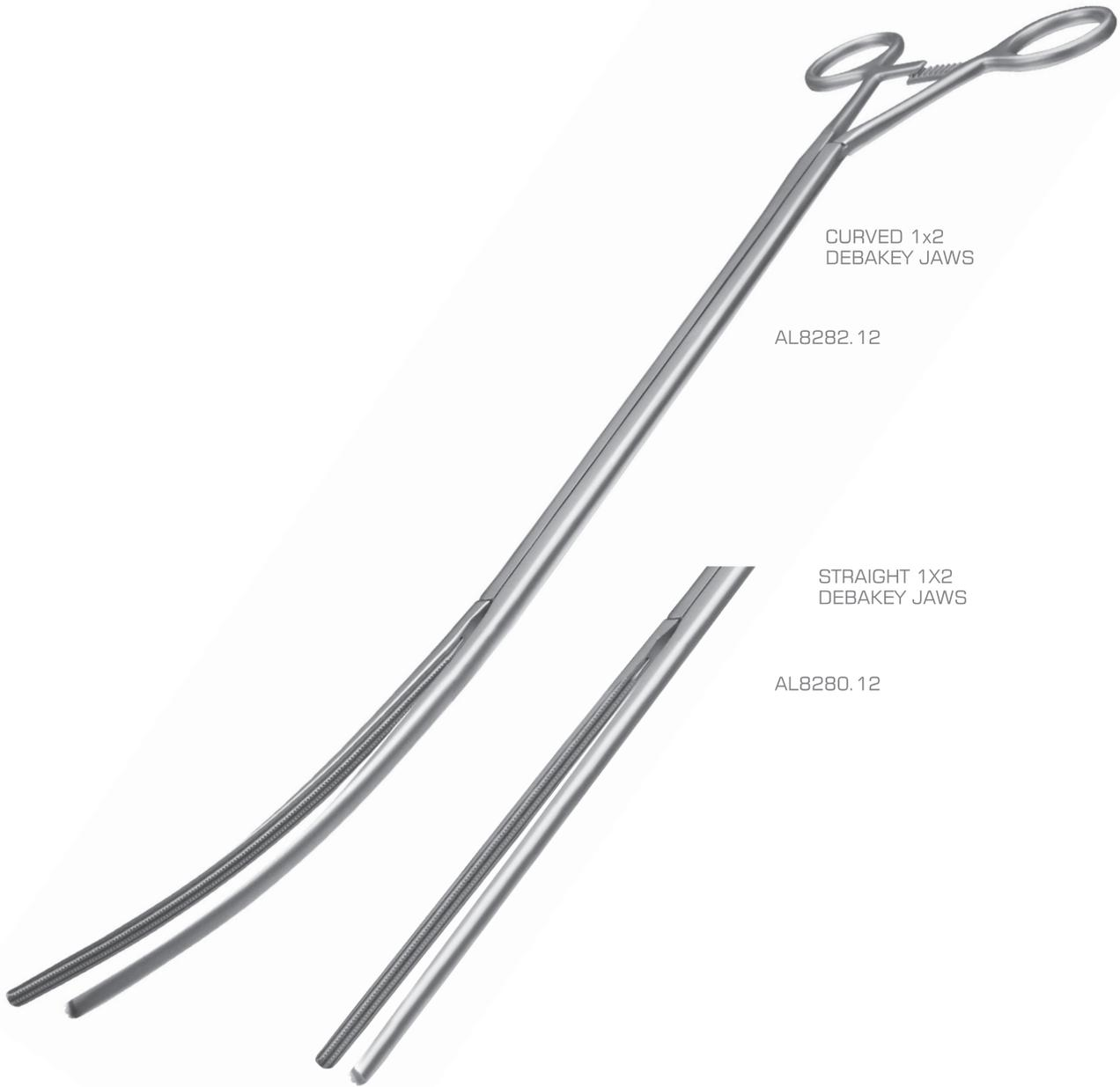

CURVED 1x2
DEBAKEY JAWS

AL8282.12

STRAIGHT 1x2
DEBAKEY JAWS

AL8280.12

Images not actual size

VATS•MICS

- AL8280.12 Thoracoscopic DeBakey Clamp - 115mm Straight 1x2 DeBakey Atraumatic Tapered jaws, 10mm Shaft, w/Ratchet, (27cm Working Length), Stainless Steel, 14.75" (37.5cm)
- AL8282.12 Thoracoscopic DeBakey Clamp - 110mm Curved 1x2 DeBakey Atraumatic Tapered jaws, 10mm Shaft, w/Ratchet, (25.5cm Working Length), Stainless Steel, 14.5" (37cm)



VATS SEMB CLAMP

Ring Handle | Fully Curved Jaws



AL8268.12

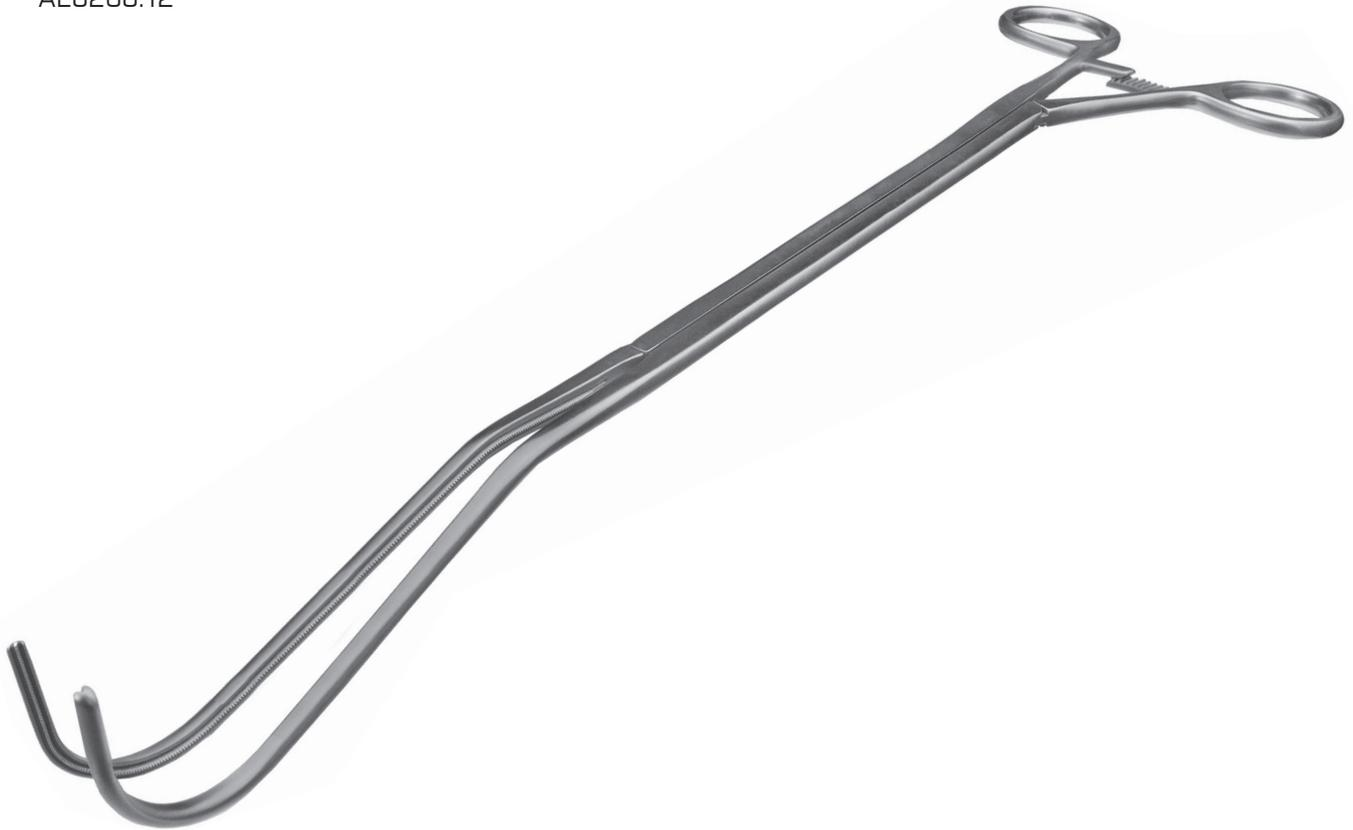

Images not actual size

VATS

AL8268.12

VATS Semb Clamp – 140mm Fully Curved 1x2 DeBakey Atraumatic jaws,
10mm Shaft, (31cm Working Length), w/Ratchet, Stainless Steel, 15.5" (39.5cm)



THORACOSCOPIC LAMBERT KAY CLAMP

Ring Handle | Fully Curved Jaws



AL8274.12



Images not actual size

VATS

AL8274.12 Thoracoscopic Lambert Kay Clamp – Curved 1x2 DeBakey Atraumatic jaws, 10mm Shaft, Angled Shanks, w/Ratchet, (21cm Working Length), Stainless Steel, 12.25" (31cm)



VATS HARKEN CLAMPS

Ring Handle | Curved / Fully Curved Jaws

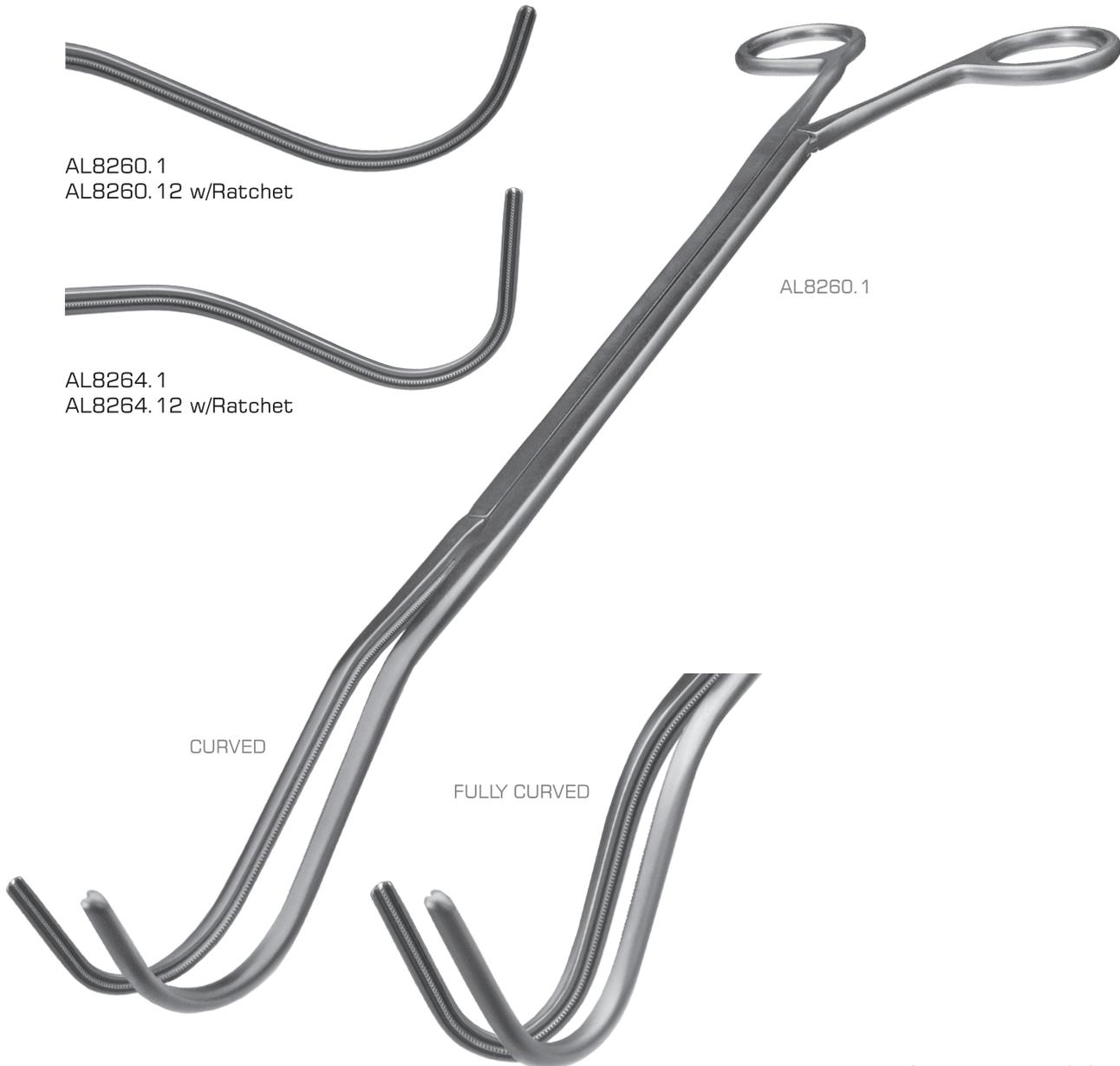

Images not actual size

VATS

- AL8259.1 VATS Harken #1 Clamp - 95mm Curved 1x2 DeBakey Atraumatic jaws, 10mm Shaft, 8" (20cm Working Length), Stainless Steel, 12" (30cm)
- AL8260.1 VATS Harken #1 Clamp - 95mm Curved 1x2 DeBakey Atraumatic jaws, 10mm Shaft, (25cm Working Length), Stainless Steel, 14" (35.5cm)
- AL8260.12 VATS Harken #1 Clamp - 95mm Curved 1x2 DeBakey Atraumatic jaws, 10mm Shaft, (25cm Working Length), w/Ratchet, Stainless Steel, 14" (35.5cm)
- AL8264.1 VATS Harken #2 Clamp - 95mm Fully Curved 1x2 DeBakey Atraumatic jaws, 10mm Shaft, (25cm Working Length), Stainless Steel, 14" (35.5cm)
- AL8264.12 VATS Harken #2 Clamp - 95mm Fully Curved 1x2 DeBakey Atraumatic jaws, 10mm Shaft, (25cm Working Length), w/Ratchet, Stainless Steel, 14" (35.5cm)



WEXLER MIS DEBAKEY FORCEPS

Round Squeeze Handle | Straight Jaws



FL8598.1
FL8600.1
FL8601.1



FL8604.1
FL8606.1
FL8607.1



FL8608.1
FL8610.1



FL8602.1



2.8MM TIPS

FL8604.1

Images not actual size

VATS•MICS

- FL8598.1 Wexler MIS DeBakey Forceps - Straight 1mm jaws, 5mm Shaft, 6.75" (17cm Working Length), Round Squeeze Handle, Stainless Steel, 11.75" (30cm)
- FL8600.1 Wexler MIS DeBakey Forceps - Straight 1mm jaws, 5mm Shaft, 10" (25cm Working Length), Round Squeeze Handle, Stainless Steel, 14" (35.5cm)
- FL8601.1 Wexler MIS DeBakey Forceps - Straight 1mm jaws, 5mm Shaft, 11" (28cm Working Length), Round Squeeze Handle, Stainless Steel, 16" (40.5cm)
- FL8602.1 Wexler MIS DeBakey Forceps - Angled 1mm jaws, 5mm Shaft, 10" (25cm Working Length), Round Squeeze Handle, Stainless Steel, 14" (35.5cm)
- FL8604.1 Wexler MIS DeBakey Forceps - Straight 2.8mm jaws, 5mm Shaft, 6.75" (17cm Working Length), Round Squeeze Handle, Stainless Steel, 11.75" (30cm)
- FL8607.1 Wexler MIS DeBakey Forceps - Straight 2.8mm jaws, 5mm Shaft, 11" (28cm Working Length), Round Squeeze Handle, Stainless Steel, 16" (40.5cm)
- FL8606.1 Wexler MIS DeBakey Forceps - Straight 2.8mm jaws, 5mm Shaft, 10" (25cm Working Length), Round Squeeze Handle, Stainless Steel, 14" (35.5cm)
- FL8608.1 Wexler MIS DeBakey Forceps - Straight 2x3 DeBakey w/ 3.2mm jaws, 5mm Shaft, 6.75" (17cm Working Length), Round Squeeze Handle, Stainless Steel, 11.75" (30cm)
- FL8610.1 Wexler MIS DeBakey Forceps - Straight 2x3 DeBakey w/ 3.2mm jaws, 5mm Shaft, 10" (25cm Working Length), Round Squeeze Handle, Stainless Steel, 14" (35.5cm)



WEXLER RESANO AND SERRATED FORCEPS

Round Squeeze Handle | Straight Jaws



FL8612.1
FL8614.1
FL8616.1



FL8624.14



FL8628.1
FL8630.1

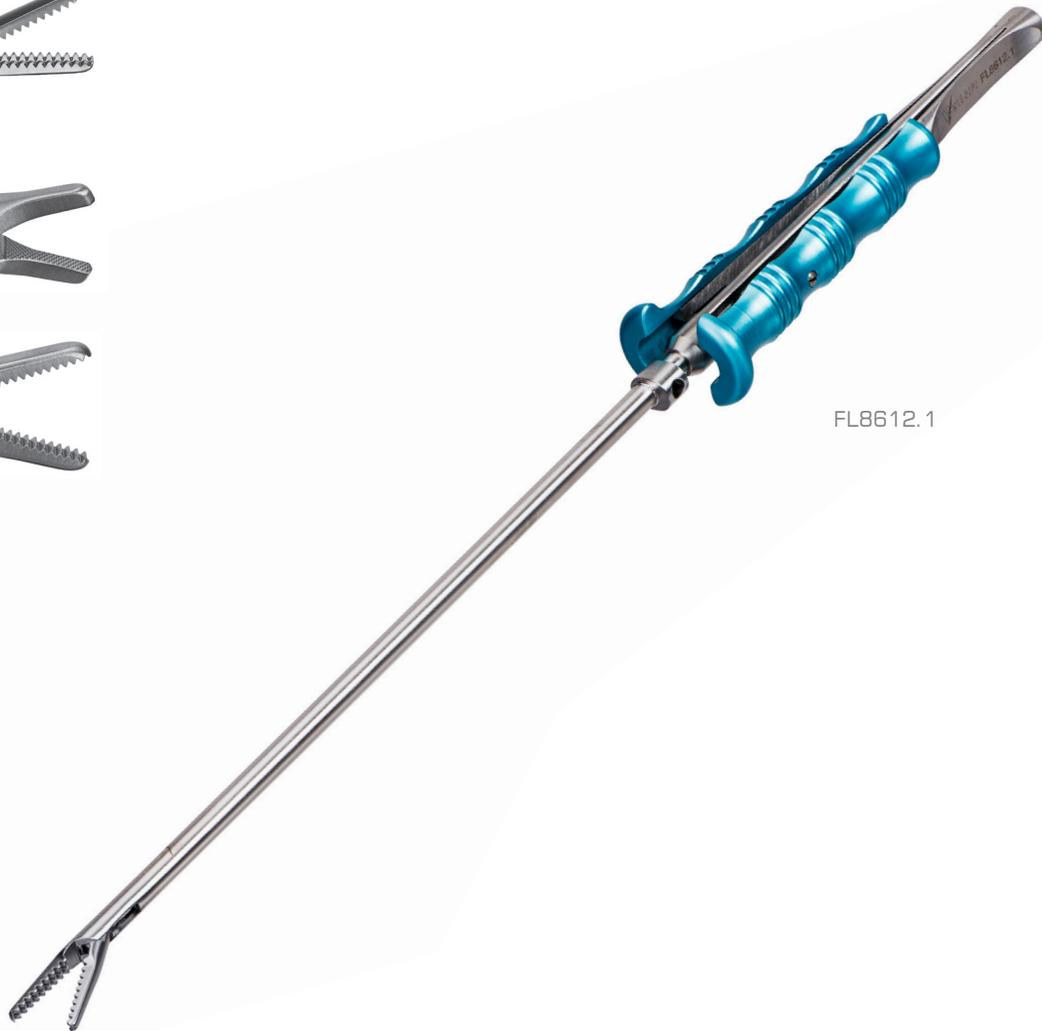

FL8612.1

Images not actual size

VATS•MICS

- FL8612.1 MIS Resano Forceps – Straight Atraumatic jaws, 5mm Shaft, 6.75" (17cm Working Length), Round Squeeze Handle, Stainless Steel, 11.75" (30cm)
- FL8614.1 MIS Resano Forceps – Straight Atraumatic jaws, 5mm Shaft, 10" (25cm Working Length), Round Squeeze Handle, Stainless Steel, 14" (35.5cm)
- FL8616.1 MIS Resano Forceps - Straight Atraumatic jaws, 5mm Shaft, 11" (28cm Working Length), Round Squeeze Handle, Stainless Steel, 16" (40.5cm)
- FL8624.14 MIS Forceps – Straight 1mm jaws w/ TC Inserts, 5mm Shaft, 6.75" (17cm Working Length), Round Squeeze Handle, Stainless Steel, 11.75" (30cm)
- FL8628.1 MIS Forceps – Straight 2.8mm Serrated jaws, 5mm Shaft, 6.75" (17cm Working Length), Round Squeeze Handle, Stainless Steel, 11.75" (30cm)
- FL8630.1 MIS Forceps - Straight 2.8mm Serrated jaws, 5mm Shaft, 10" (25cm Working Length), Round Squeeze Handle, Stainless Steel, 14" (35.5cm)



WEXLER RUSSIAN AND BIOPSY FORCEPS

Round Squeeze Handle | Curved/Straight Tips



FL8620.1



FL8634.1



FL8620.1

Images not actual size

VATS•MICS

- | | |
|----------|---|
| FL8620.1 | MIS Russian Forceps – Curved Left Oval Serrated Tips, 5mm Shaft, 10" (25cm Working Length), Round Squeeze Handle, Stainless Steel, 14" (35.5cm) |
| FL8634.1 | MIS Biopsy Forceps – Straight Oval Biopsy Tips, 5mm Shaft, 10" (25cm Working Length), Round Squeeze Handle, Stainless Steel, 14" (35.5cm) |



DISSECTOR FORCEPS

Ring Handle | Curved/Anged Jaws



FL8422.1
FL8422.12 w/Ratchet



FL8426.1
FL8426.12 w/Ratchet



FL8426.1F
FL8426.12F w/Ratchet



FL8418.1
FL8418.12 w/Ratchet

CURVED



FL8422.12

ANGLED

Images not actual size

VATS•MICS

CURVED	FL8418.1	VATS Mixer Dissector - Curved DeBakey 1x2 Atraumatic jaws, 5mm Shaft, 7.5" (19cm Working Length), Stainless Steel, 11.5" (29cm)
	FL8418.12	VATS Mixer Dissector - Curved DeBakey 1x2 Atraumatic jaws, 5mm Shaft, w/Ratchet, 7.5" (19cm Working Length), Stainless Steel, 11.5" (29cm)
	FL8422.1	VATS Curved Dissector - Serrated jaws, 7mm shaft, 9.125" (23.3cm Working Length), 13.25" (33.5cm)
	FL8422.12	VATS Curved Dissector - Serrated jaws, 7mm shaft, 9.125" (23.3cm Working Length), w/Ratchet, 13.25" (33.5cm)
ANGLED	FL8426.1	VATS Right Angle Dissector - DeBakey/Cooley Serrated jaws, 10mm shaft, 9.5" (24cm Working Length), 13.5" (34cm)
	FL8426.12	VATS Right Angle Dissector - DeBakey/Cooley Serrated jaws, 10mm shaft, 9.5" (24cm Working Length), w/Ratchet, 13.5" (34cm)
	FL8426.1F	VATS Right Angle Fine Dissector - DeBakey/Cooley Fine Serrated jaws, 7mm shaft, 9.5" (24cm) Working Length, 13.5" (34cm)
	FL8426.12F	VATS Right Angle Fine Dissector - DeBakey/Cooley Fine Serrated jaws, 7mm shaft, 9.5" (24cm) Working Length, w/Ratchet, 13.5" (34cm)



ALLIS FORCEPS

Ring Handle / Curved Shaft



FL8412.12



Images not actual size

VATS•MICS

FL8412.12 VATS Allis Forceps – Curved Left 6mm wide jaws, 7mm Shaft, w/Ratchet, 9.5"
(24cm Working Length), 13.5" (34cm)



VATS FOERSTER FORCEPS

Ring Handle | Curved Shaft



FL8438.1
FL8438.12 w/Ratchet



FL8439.12



FL8433.12 w/Ratchet
FL8436.1
FL8436.12 w/Ratchet
FL8437.12 w/Ratchet



FL8430.1
FL8430.12 w/Ratchet

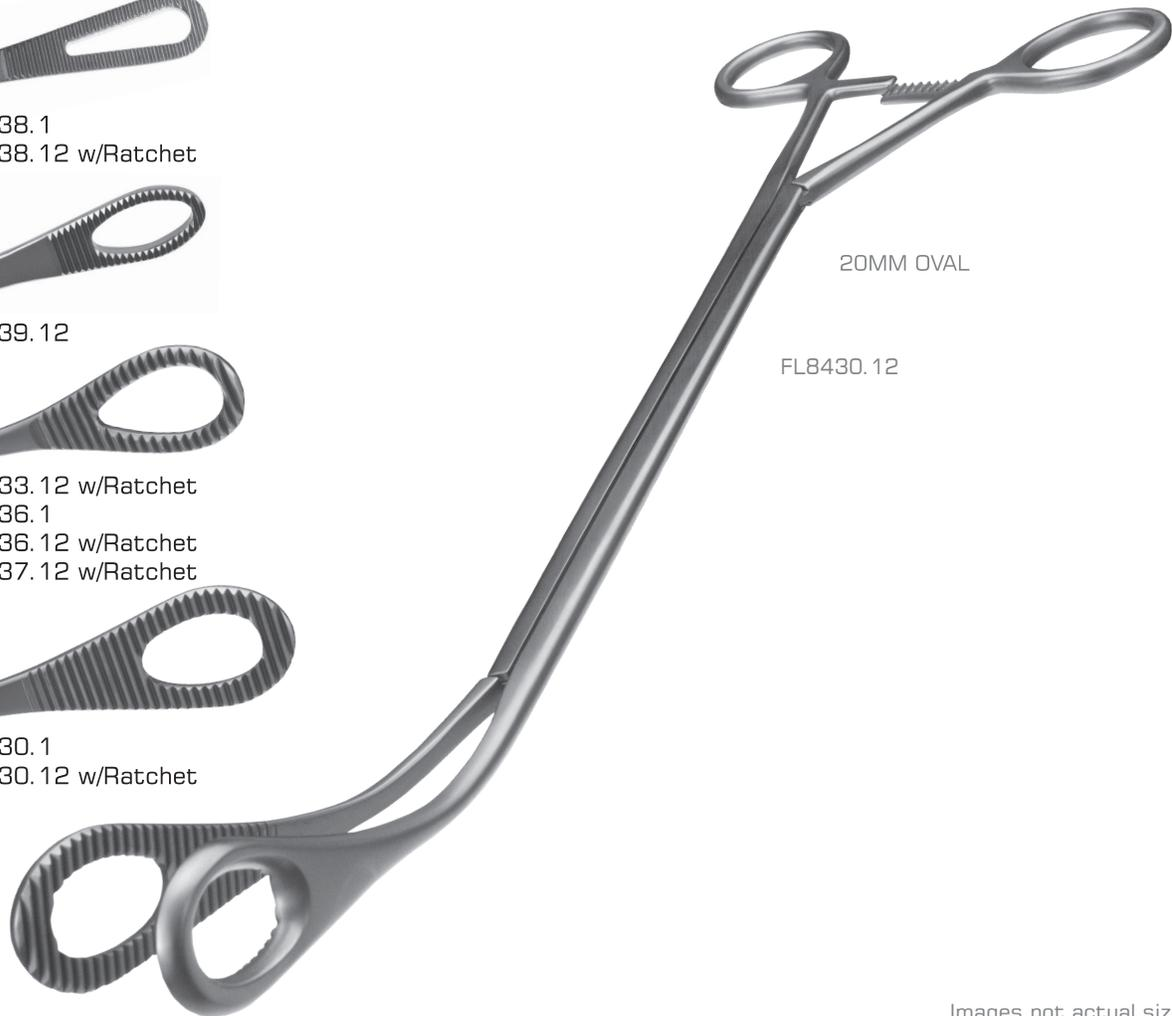

20MM OVAL

FL8430.12

Images not actual size

VATS

10mm OVAL

- FL8438.1 VATS Foerster Forceps – Curved Left 10mm Oval Serrated jaws, 7mm Shaft, 9.5" (24cm Working Length), Stainless Steel, 13.5" (34cm)
- FL8438.12 VATS Foerster Forceps – Curved Left 10mm Oval Serrated jaws, 7mm Shaft, w/Ratchet, 9.5" (24cm Working Length), Stainless Steel, 13.5" (34cm)
- FL8439.12 VATS K-Dyn Forceps - Curved Left 10mm Oval Serrated jaws, 5mm Shaft, w/Ratchet, 13.5" (35cm) Working Length, Stainless Steel, 17.5" (44.5cm)

12mm OVAL

- FL8433.12 VATS Foerster Forceps - Curved Left 12mm Oval Serrated jaws, 7mm Shaft, w/Ratchet, 7.5" (19cm Working Length), Stainless Steel, 11.5" (29cm)
- FL8436.1 VATS Foerster Forceps – Curved Left 12mm Oval Serrated jaws, 7mm Shaft, 9.5" (24cm Working Length), Stainless Steel, 13.5" (34cm)
- FL8436.12 VATS Foerster Forceps – Curved Left 12mm Oval Serrated jaws, 7mm Shaft, w/Ratchet, 9.5" (24cm Working Length), Stainless Steel, 13.5" (34cm)
- FL8437.12 VATS Foerster Forceps – Deeply Curved Left 12mm Oval Serrated jaws, 7mm Shaft, w/Ratchet, 9.5" (24cm Working Length), Stainless Steel, 13" (33cm)

20mm OVAL

- FL8430.1 VATS Foerster Forceps – Curved Left 20mm Oval Serrated jaws, 10mm Shaft, 9.5", (24cm Working Length), Stainless Steel, 13.5" (34cm)
- FL8430.12 VATS Foerster Forceps – Curved Left 20mm Oval Serrated jaws, 10mm Shaft, w/Ratchet, 9.5" (24cm Working Length), Stainless Steel, 13.5" (34cm)



VATS FOERSTER FORCEPS

Ring Handle | Straight Shaft



FL8435.12 w/Ratchet

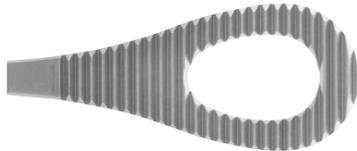

FL8431.12 w/Ratchet

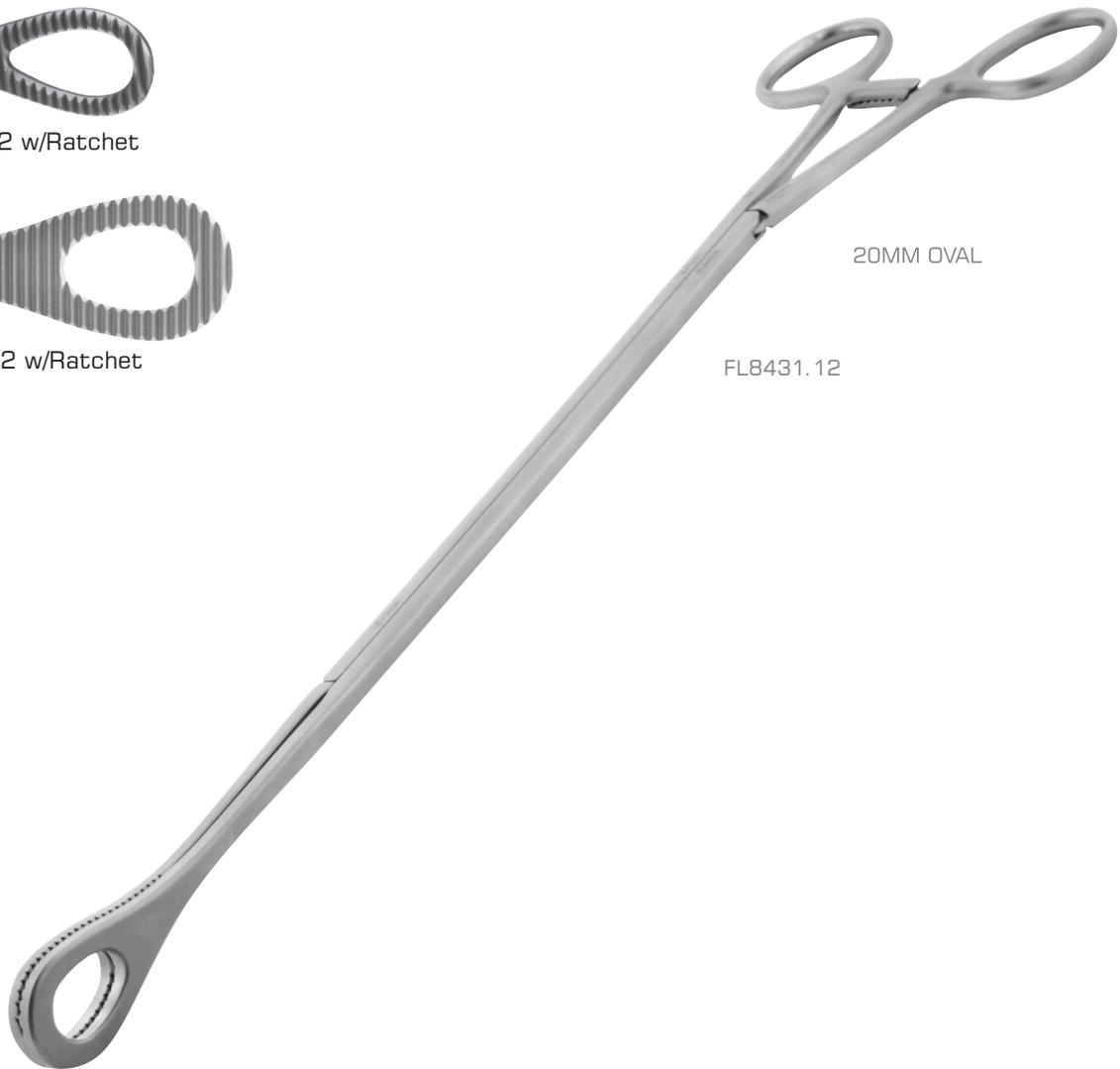

20MM OVAL

FL8431.12

Images not actual size

VATS

**12mm
OVAL**

FL8435.12

VATS Foerster Forceps - Straight 12mm Oval Serrated jaws, 7mm Shaft, w/Ratchet, 9.5" (24cm) Working Length, Stainless Steel, 13.5" (34cm)

**20mm
OVAL**

FL8431.12

VATS Foerster Forceps - Straight 20mm Oval Serrated jaws, 10mm Shaft, w/Ratchet, 9.5" (24cm) Working Length, Stainless Steel, 13.5" (34cm)



VATS DUVAL FORCEPS

Ring Handle | Curved Shaft

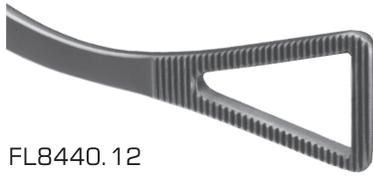

FL8440.12

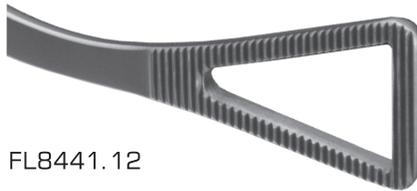

FL8441.12

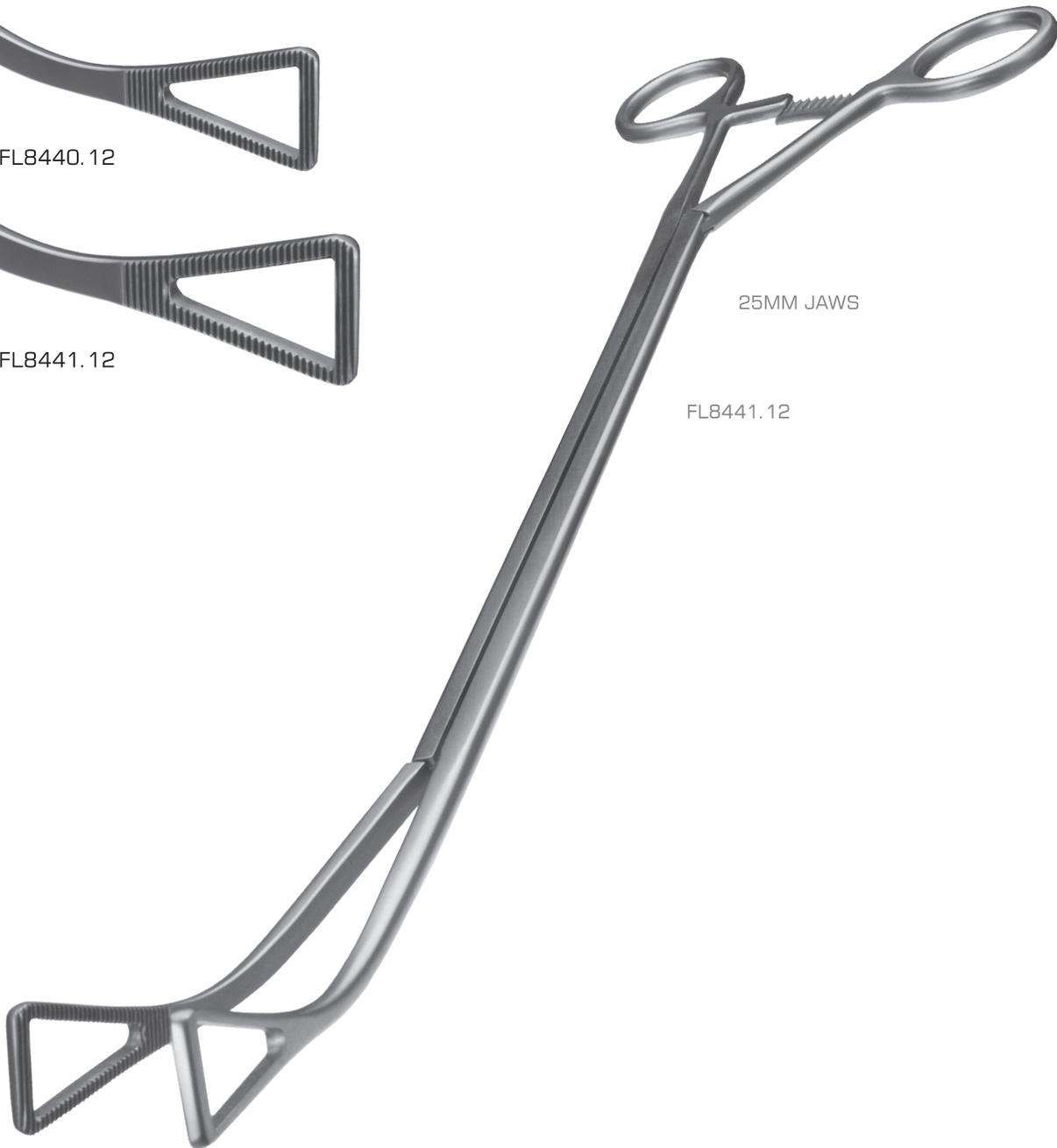

25MM JAWS

FL8441.12

Images not actual size

VATS

- FL8440.12 VATS Duval Clamp - Curved Left 15mm Triangular Serrated ring jaws, 10mm Shaft, w/Ratchet, 9.25" (23.5cm Working Length), 13.5" (34cm)
- FL8441.12 VATS Duval Clamp - Curved Left 25mm Triangular Serrated ring jaws, 10mm Shaft, w/Ratchet, 9.25" (23.5cm Working Length), 13.5" (34cm)



NODE GRASPING FORCEPS

Ring Handle | Straight / Curved Shaft

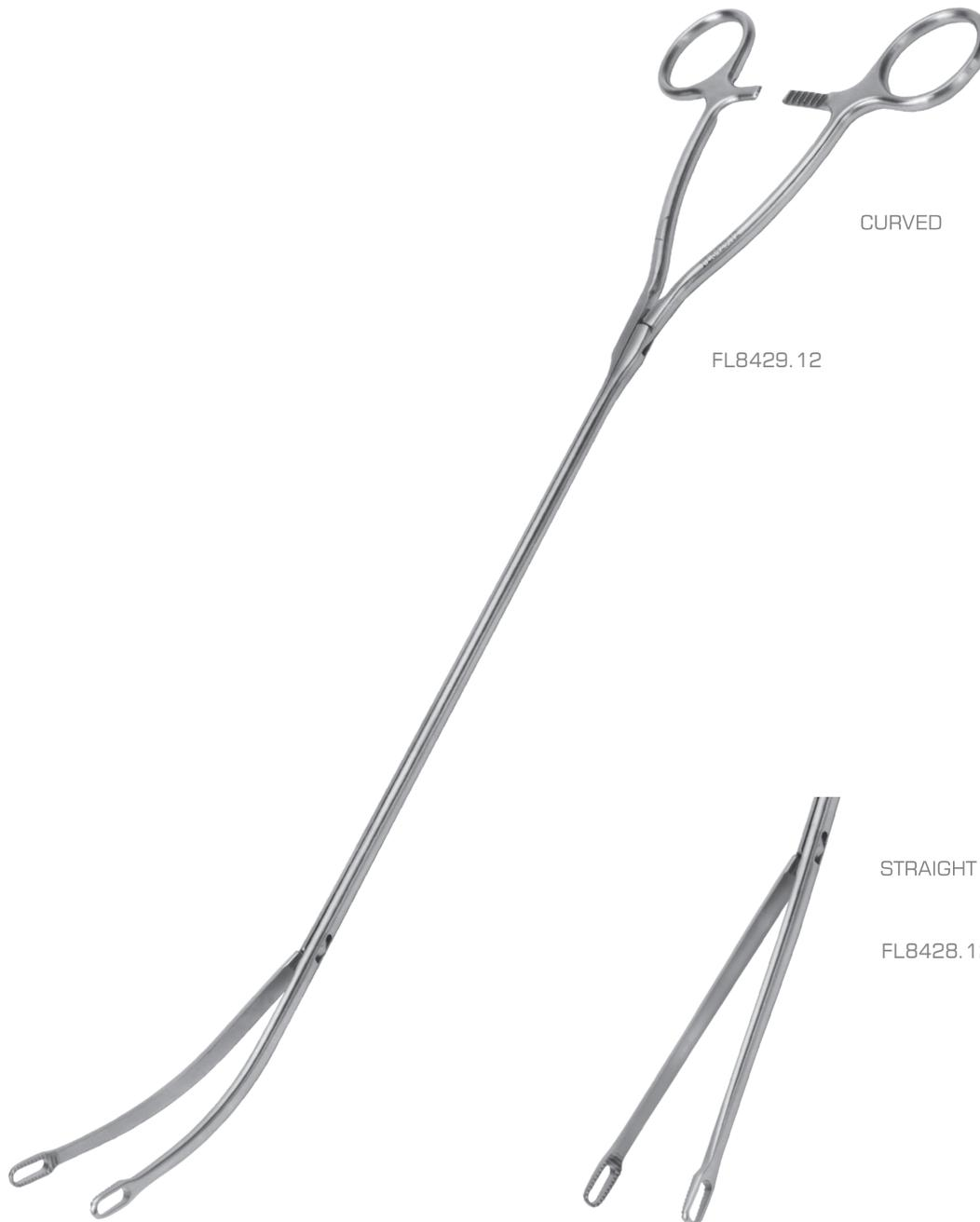

CURVED

FL8429.12

STRAIGHT

FL8428.12

Images not actual size

VATS•MICS

STRAIGHT	FL8428.12	VATS Node Grasping Forceps - Straight 11mm Oblong Serrated jaws, 5mm Shaft, w/Ratchet, 9" (23cm Working Length), Stainless Steel, 13" (33cm)
CURVED	FL8429.1	VATS Node Grasping Forceps - Curved Left 11mm Oblong Serrated jaws, 5mm Shaft, 9" (23cm Working Length), Stainless Steel, 13" (33cm)
	FL8429.12	VATS Node Grasping Forceps - Curved Left 11mm Oblong Serrated jaws, 5mm Shaft, w/Ratchet, 9" (23cm Working Length), Stainless Steel, 13" (33cm)
	FL8448.12	VATS Node Grasping Forceps - Curved Left 11mm Oblong Serrated jaws, 5mm Shaft, w/Ratchet, 7" (18cm Working Length), Stainless Steel, 11.25" (28cm)



MIS NEEDLE HOLDERS

Ring Handle | Straight Jaws



NL8402.13

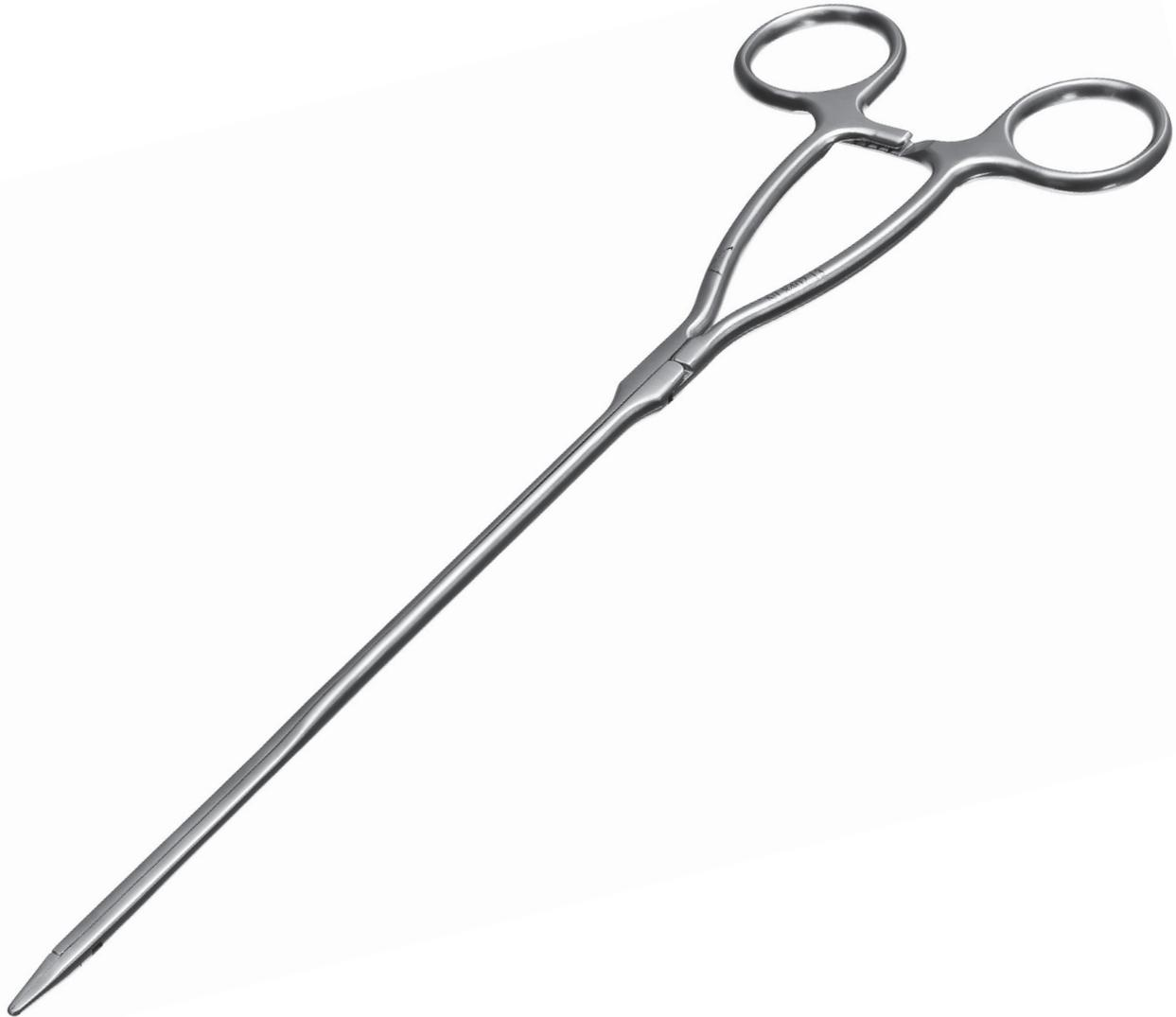

Images not actual size

MICS

STRAIGHT

NL8402.13

MIS Needle Holder – TC Coated jaws, w/Lock, 5mm Shaft, 6.5”
(16.5cm Working Length), Stainless Steel, 10.5” (26.5cm)



HEAVY & X-HEAVY NEEDLE HOLDERS

Ring Handle | Straight / Curved Jaws



NL8406.15

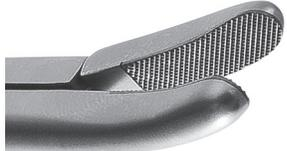

NL8408.15



NL8409.15
NL8410.15



NL8412.15



X-HEAVY

NL8412.15

HEAVY

NL8406.15

Images not actual size

VATS•MICS

HEAVY	NL8406.15	VATS Heavy Needle Holders – Straight Heavy jaws w/TC Inserts, 7mm Shaft, w/Ratchet, (21cm Working Length), Stainless Steel, 13.5" (34cm)
	NL8408.15	VATS Heavy Needle Holders – Curved Heavy jaws w/TC Inserts, 7mm Shaft, w/Ratchet, (21cm Working Length), Stainless Steel, 13.5" (34cm)
X-HEAVY	NL8409.15	VATS X-Heavy Needle Holders - Straight X-Heavy jaws w/TC Inserts, 7mm Shaft, w/Ratchet, (16cm Working Length), Stainless Steel, 11.25" (28.5cm)
	NL8410.15	VATS X-Heavy Needle Holders – Straight X-Heavy jaws w/TC Inserts, 10mm Shaft, w/Ratchet, (21cm Working Length), Stainless Steel, 13.5" (34cm)
	NL8412.15	VATS X-Heavy Needle Holders – Curved X-Heavy jaws w/TC Inserts, 10mm Shaft, w/Ratchet, (21cm Working Length), Stainless Steel, 13.5" (34cm)



WEXLER NEEDLE HOLDERS - (STRAIGHT)

Round Squeeze Handle | Straight Jaws



NL8600.13



NL8598.15
NL8600.15



NL8608.15
NL8610.15
NL8611.15



NL8612.15
NL8614.15



NL8612.15

Images not actual size

VATS•MICS

STRAIGHT

NL8598.15	MIS Needle Holder - Straight jaws w/TC-Inserts, w/Lock, 5mm Shaft, 6.75" (17cm Working Length), Round Squeeze Handle, Stainless Steel, 11.75" (30cm)
NL8600.13	MIS Needle Holder - Straight TC-Coated jaws, w/Lock, 5mm Shaft, 10" (25cm Working Length), Round Squeeze Handle, Stainless Steel, 14" (35.5cm)
NL8600.15	MIS Needle Holder - Straight jaws w/TC-Inserts, w/Lock, 5mm Shaft, 10" (25cm Working Length), Round Squeeze Handle, Stainless Steel, 14" (35.5cm)
NL8604.15	MIS Needle Holder - Straight jaws w/TC Inserts, w/Lock, 5mm Shaft, 11" (28cm Working Length), Round Squeeze Handle, Stainless Steel, 16" (40.5cm)
NL8608.15	MIS Needle Holder - Straight Ryder jaws w/TC-Inserts, w/Lock, 5mm Shaft, 6.75" (17cm Working Length), Round Squeeze Handle, Stainless Steel, 11.75" (30cm)
NL8610.15	MIS Needle Holder - Straight Ryder jaws w/TC-Inserts, w/Lock, 5mm Shaft, 10" (25cm Working Length), Round Squeeze Handle, Stainless Steel, 14" (35.5cm)
NL8611.15	MIS Needle Holder - Straight Ryder jaws w/TC Inserts, w/Lock, 5mm Shaft, 11" (28cm Working Length), Round Squeeze Handle, Stainless Steel, 16" (40.5cm)
NL8612.15	MIS Needle Holder - Short Straight Ryder jaws w/TC-Inserts, w/Lock, 5mm Shaft, 6.75" (17cm Working Length), Round Squeeze Handle, Stainless Steel, 11.75" (30cm)
NL8614.15	MIS Needle Holder - Short Straight Ryder jaws w/TC-Inserts, w/Lock, 5mm Shaft, 10" (25cm Working Length), Round Squeeze Handle, Stainless Steel, 14" (35.5cm)



WEXLER NEEDLE HOLDERS - (CURVED)

Round Squeeze Handle | Curved Jaws



NL8602.13



NL8601.15
NL8602.15



NL8603.15



NL8616.15
NL8618.15



NL8602.15

Images not actual size

VATS•MICS

CURVED

NL8601.15	MIS Needle Holder - Curved jaws w/TC-Inserts, w/Lock, 5mm Shaft, 6.75" (17cm Working Length), Round Squeeze Handle, Stainless Steel, 11.75" (30cm)
NL8602.13	MIS Needle Holder - Curved TC-Coated jaws, w/Lock, 5mm Shaft, 10" (25cm Working Length), Round Squeeze Handle, Stainless Steel, 14" (35.5cm)
NL8602.15	MIS Needle Holder - Curved jaws w/TC-Inserts, w/Lock, 5mm Shaft, 10" (25cm Working Length), Round Squeeze Handle, Stainless Steel, 14" (35.5cm)
NL8603.15	MIS Needle Holder - Curved jaws w/TC-Inserts, w/Lock, 5mm Shaft, 11" (28cm Working Length), Round Squeeze Handle, Stainless Steel, 16" (40.5cm)
NL8616.15	MIS Needle Holder - Short Curved jaws w/TC-Inserts, w/Lock, 5mm Shaft, 6.75" (17cm Working Length), Round Squeeze Handle, Stainless Steel, 11.75" (30cm)
NL8618.15	MIS Needle Holder - Short Curved jaws w/TC-Inserts, w/Lock, 5mm Shaft, 10" (25cm Working Length), Round Squeeze Handle, Stainless Steel, 14" (35.5cm)



KNOT TIER/PUSHER

Round Squeeze Handle | Angled Jaws



AL8450.1
AL8450.12 (w/Lock)

AL8452.1
AL8452.12 (w/Lock)



AL8450.1

Images not actual size

VATS•MICS

- | | |
|-----------|---|
| AL8450.1 | MIS Knot Pusher - 5mm Shaft, 6.75" (17cm Working Length), Round Squeeze Handle, Stainless Steel, 11.75" (30cm) |
| AL8450.12 | MIS Knot Pusher - 5mm Shaft w/Lock, 6.75" (17cm Working Length), Round Squeeze Handle, Stainless Steel, 11.75" (30cm) |
| AL8452.1 | MIS Knot Pusher - 5mm Shaft, 10" (25cm Working Length), Round Squeeze Handle, Stainless Steel, 15" (38cm) |
| AL8452.12 | MIS Knot Pusher - 5mm Shaft w/Lock, 10" (25cm Working Length), Round Squeeze Handle, Stainless Steel, 15" (38cm) |



MICS SCISSORS

Round Squeeze Handle | Curved / Strongly Curved / Full Curved



SL8618.1 | 15°
SL8620.1



SL8622.1
SL8624.1 | 30°
SL8625.1



SL8626.1
SL8628.1 | 70°
SL8630.1



SL8618.1

Images not actual size

VATS•MICS

CURVED	SL8618.1	MIS Scissors - 15° Curved Blades, 5mm Shaft, 6.75" (17cm Working Length), Round Squeeze Handle, Stainless Steel, 11.75" (30cm)
	SL8620.1	MIS Scissors - 15° Curved Blades, 5mm Shaft, 10" (25cm Working Length), Round Squeeze Handle, Stainless Steel, 14" (35.5cm)
STRONGLY CURVED	SL8622.1	MIS Scissors - 30° Strongly Curved Blades, 5mm Shaft, 6.75" (17cm Working Length), Round Squeeze Handle, Stainless Steel, 11.75" (30cm)
	SL8624.1	MIS Scissors - 30° Strongly Curved Blades, 5mm Shaft, 10" (25cm Working Length), Round Squeeze Handle, Stainless Steel, 14" (35.5cm)
	SL8625.1	MIS Scissors - Strongly Curved Blades, 5mm Shaft, 11" (28cm Working Length), Round Squeeze Handle, Stainless Steel, 16" (40.5cm)
FULL CURVED	SL8626.1	MIS Scissors - 70° Full Curved Blades, 5mm Shaft, 6.75" (17cm Working Length), Round Squeeze Handle, Stainless Steel, 11.75" (30cm)
	SL8628.1	MIS Scissors - 70° Full Curved Blades, 5mm Shaft, 10" (25cm Working Length), Round Squeeze Handle, Stainless Steel, 14" (35.5cm)
	SL8630.1	MIS Scissors - Full Curved Blades, 5mm Shaft, 11" (28cm Working Length), Round Squeeze Handle, Stainless Steel, 16" (40.5cm)



THORACOSCOPIC DISSECTING & METZENBAUM SCISSORS

Ring Handle / Curved Blades



SL8400.1S



SL8402.1S



SL8404.1S



METZENBAUM

SL8404.1S

DISSECTING

SL8402.1S

Images not actual size

VATS•MICS

- SL8400.1S Thoracoscopic Micro Scissors - Straight 1cm Razor Edge Blades w/Blunt Micro tips, 5mm Shaft, 6.5" (16.5cm Working Length), Stainless Steel, 10.5" (26.5cm)
- SL8402.1S Thoracoscopic Dissecting Scissors - Curved 3cm Blades w/Blunt tips, 5mm Shaft, 7.5" (19cm Working Length), Stainless Steel, 11.5" (29cm)
- SL8404.1S Thoracoscopic Metzenbaum Scissors - Curved 3.5cm Blades w/Blunt tips, 10mm Shaft, 7.75" (19cm Working Length), Stainless Steel, 11.5" (29cm)



FAN RETRACTOR

Straight Handle | Straight Articulating Shaft



TL8402.1

5MM ARTICULATING SHAFT
WITH 3 FINGERS

10MM ARTICULATING SHAFT
WITH 5 FINGERS

TL8404.1

Images not actual size

VATS•MICS

- TL8402.1 Thoracoscopic Fan Retractor - Straight 5mm Articulating Shaft w/3 Fingers, 13" (33cm Working Length), Stainless Steel, 19.5" (49.5cm)
- TL8404.1 Thoracoscopic Fan Retractor - Straight 10mm Articulating Shaft w/5 Fingers, 13" (33cm Working Length), Stainless Steel, 19.5" (49.5cm)



CHEST TUBE PASSER

Ring Handle | Curved Shaft



AL1300.1
AL1300.13 w/Ratchet
AL1302.1
AL1302.13 w/Ratchet

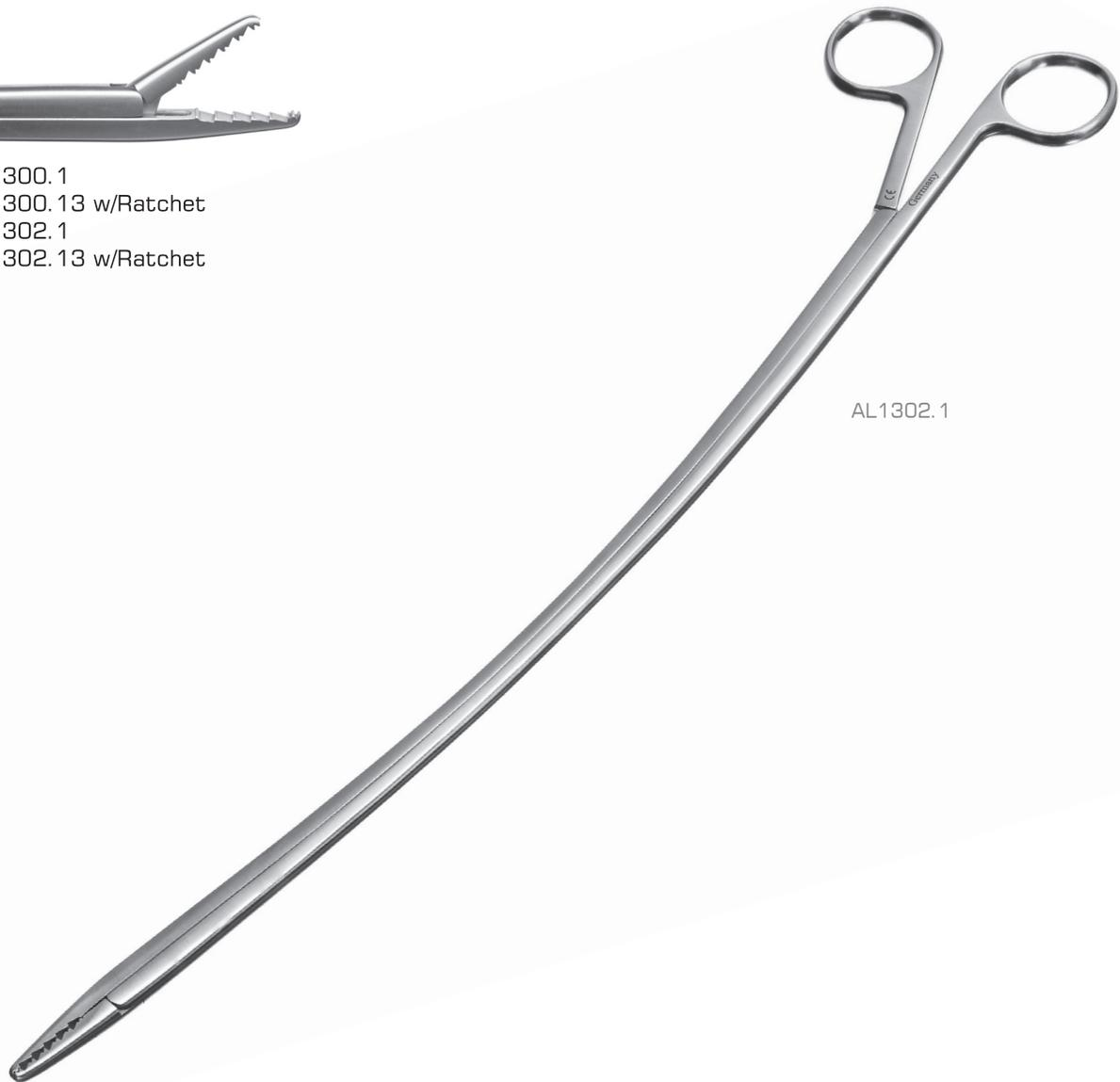

AL1302.1

Images not actual size

VATS•MICS

- | | |
|-----------|--|
| AL1300.1 | Chest Tube Passer – 10mm Curved Shaft, 6.75" (17.5cm Working Length), Stainless Steel, 9.75" (24cm) |
| AL1300.13 | Chest Tube Passer – 10mm Curved Shaft, 6.75" (17.5cm Working Length), w/Ratchet, Stainless Steel, 9.75" (24cm) |
| AL1302.1 | Chest Tube Passer – 10mm Curved Shaft, 11" (28cm Working Length), Stainless Steel, 14" (35.5cm) |
| AL1302.13 | Chest Tube Passer – 10mm Curved Shaft, 11" (28cm Working Length), w/Ratchet, Stainless Steel, 14" (35.5cm) |



HOOKS

Round Handle | Angled Tips



AL1106.1F



AL1106.1



AL1108.1

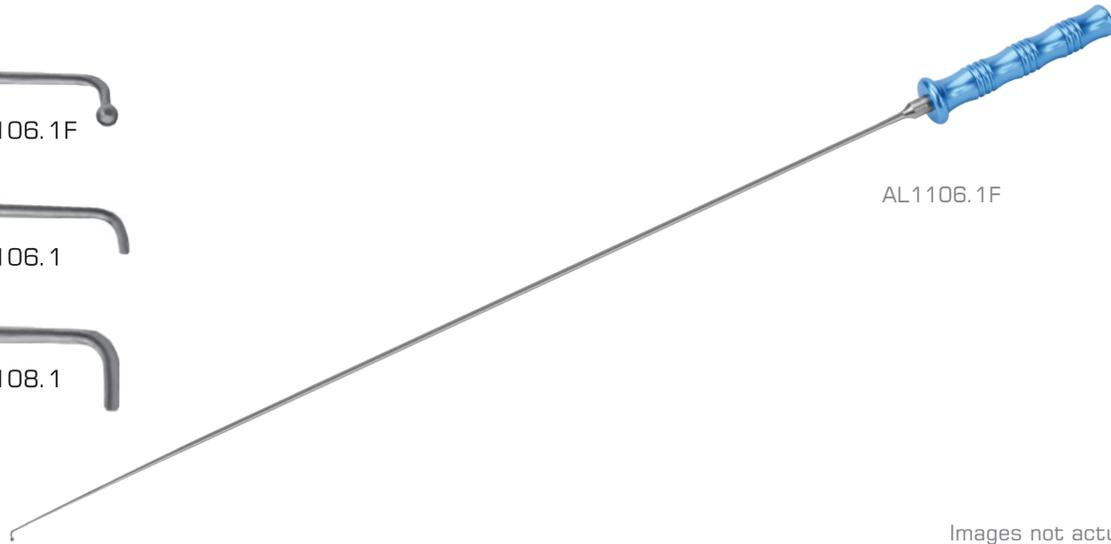

AL1106.1F

Images not actual size

VATS•MICS

- AL1106.1F Fine Nerve & Vessel Hook with Bead Tip - Round Handle, Stainless Steel, 13.75" (35cm)
- AL1106.1 Nerve & Vessel Hook - Round Handle, Stainless Steel, 13.75" (35cm)
- AL1108.1 Vessel Hook - Round Handle, Stainless Steel, 13.75" (35cm)



SUTURE PULLER

Round Handle | Straight Tip



HL1012.1

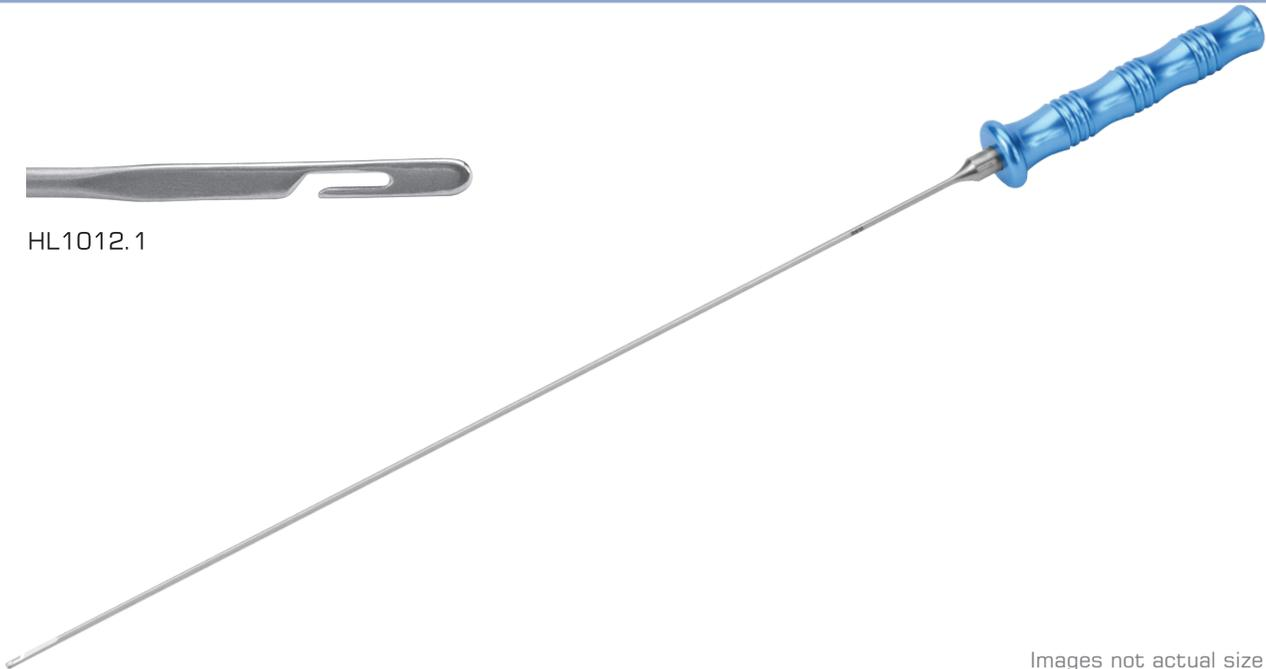

Images not actual size

VATS•MICS

- HL1012.1 Suture Puller - Round Handle, Stainless Steel, 13.75" (35cm)



SCALPEL BLADE HOLDER

Round Handle



Images not actual size

VATS•MICS

AL0199.1 Scalpel Blade Holder – Round Handle, Stainless Steel, 14.5" (37cm)



SUTURE PUSHER

Round Handle | Straight Tip



Images not actual size

VATS•MICS

HL1016.1 Suture Pusher - Round Handle, Stainless Steel, 13.75" (35cm)



NEEDLE / SYRINGE EXTENDER

Round Handle



Images not actual size

VATS•MICS

CL0730.1 Needle/Syringe Extender - 4mm tube, Nitinol, Malleable, 12" (30.5cm)



SUCTION INSTRUMENTS

Straight Handle | Straight Shaft

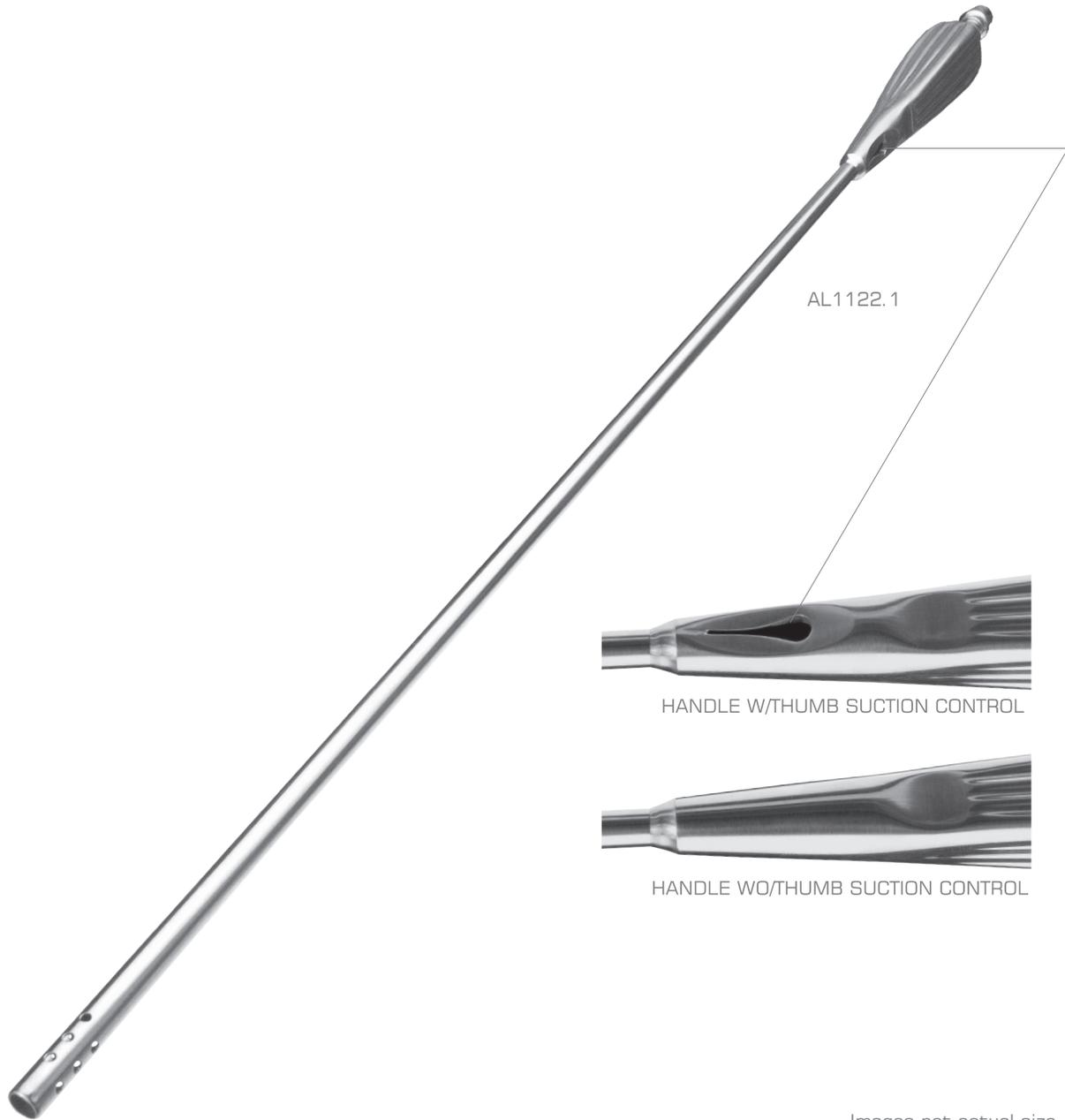

Images not actual size

VATS

- | | |
|----------|---|
| AL1120.1 | Suction Instrument – Straight 5mm tube, Yankauer Handle, 12.5" (32cm Working Length), Stainless Steel, 17.75" (45.5cm) |
| AL1122.1 | Suction Instrument – Straight 5mm tube, Yankauer Handle, w/Variable Suction, 12.5" (32cm Working Length), Stainless Steel, 17.75" (45.5cm) |
| AL1124.1 | Suction Instrument – Straight 10mm tube, Yankauer Handle, 12.5" (32cm Working Length), Stainless Steel, 17.75" (45.5cm) |
| AL1125.1 | Suction Instrument – Straight 10mm tube, Yankauer Handle, w/Variable Suction, 12.5" (32cm Working Length), Stainless Steel, 17.75" (45.5cm) |



SUCTION INSTRUMENTS

Straight Handle | Curved Shaft



AL1126.1 AL1114.1
 AL1128.1 AL1115.1
 AL1130.1 AL1118.1
 AL1132.1 AL1119.1



AL1136.1



AL1140.1
 AL1142.1

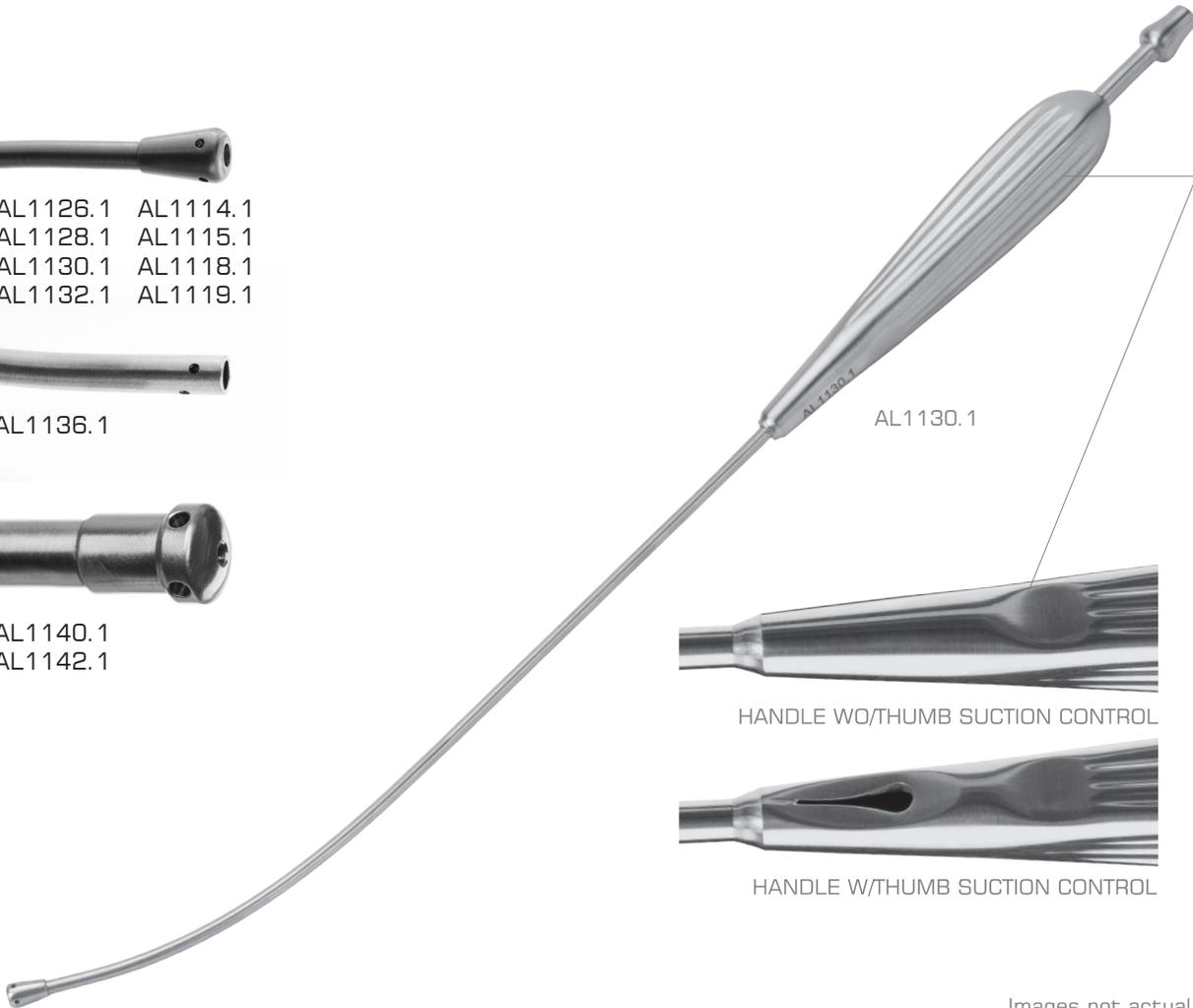

Images not actual size

VATS•MICS

AL1126.1	Suction Instrument - Curved 3.2mm tube, Yankauer Handle, 6.75" (17cm Working Length), Stainless Steel, 12.25" (31cm)
AL1128.1	Suction Instrument - Curved 3.2mm tube, Yankauer Handle, w/Variable Suction, 6.75" (17cm Working Length), Stainless Steel, 12.25" (31cm)
AL1130.1	Suction Instrument - Curved 3.2mm tube, Yankauer Handle, 8.75" (22cm Working Length), Stainless Steel, 14.25" (36cm)
AL1132.1	Suction Instrument - Curved 3.2mm tube, Yankauer Handle, w/Variable Suction, 8.75" (22cm Working Length), Stainless Steel, 14.25" (36cm)
AL1114.1	Suction Instrument - Curved 5mm tube, Yankauer Handle, 8.75" (22cm Working Length), Stainless Steel, 14.25" (36cm)
AL1115.1	Suction Instrument - Curved 5mm tube, Yankauer Handle, w/Variable Suction, 8.75" (22cm Working Length), Stainless Steel, 14.25" (36cm)
AL1118.1	Suction Instrument - Curved 5mm tube, Yankauer Handle, 12.5" (32cm Working Length), Stainless Steel, 17.75" (45.5cm)
AL1119.1	Suction Instrument - Curved 5mm tube, Yankauer Handle, w/Variable Suction, 12.5" (32cm Working Length), Stainless Steel, 17.75" (45.5cm)
AL1136.1	Suction Instrument - Curved 5mm tube, Yankauer Handle, w/Variable Suction, 12.5" (32cm Working Length), Stainless Steel, 17.75" (45.5cm)
AL1140.1	Fell Suction Instrument - Angled 8mm tube, Yankauer Handle, 7" (18cm Working Length), Stainless Steel, 13" (33cm)
AL1142.1	Suction Instrument - Straight 10mm tube Sump Tip, Yankauer Handle, 12.5" (32cm Working Length), Stainless Steel, 17.75" (45.5cm)



SUCTION BRUSH SETS

Straight Handle



Images not actual size

VATS

- DL0700 Brush Set for Straight Suction Instrument - 50cm x 5mm, White, Pack of 10 (Use with Wexler Item # AL1114.1, AL1115.1, AL1118.1, AL1119.1, AL1120.1, AL1122.1 and AL1136.1)
- DL0701 Brush Set for Straight Suction Instrument - 50cm x 10mm, White, Pack of 10 (Use with Wexler Item # AL1124.1 and AL1125.1)
- DL0702 Brush Set for Curved Suction Instrument - 47.5cm x 4mm, Green, Pack of 10 (Use with Wexler Item # AL1126.1, AL1128.1, AL1130.1 and AL1132.1)



Images not actual size

VATS

TL8470.1	Wexler Cannula - 5mm Cannula, Stainless Steel, 2.75" (7cm)
TL8471.1	Wexler Trocar - 5mm Trocar, Stainless Steel, 4.65" (11.8cm)
TL8475.1	Wexler Cannula - 7mm Cannula, Stainless Steel, 2.75" (7cm)
TL8476.1	Wexler Trocar - 7mm Trocar, Stainless Steel, 4.65" (11.8cm)
TL8480.1	Wexler Cannula - 10mm Cannula, Stainless Steel, 2.75" (7cm)
TL8481.1	Wexler Trocar - 10mm Trocar, Stainless Steel, 4.65" (11.8cm)
TL8485.1	Wexler Cannula - 12mm Cannula, Stainless Steel, 2.75" (7cm)
TL8486.1	Wexler Trocar - 12mm Trocar, Stainless Steel, 4.65" (11.8cm)
TL8490.1	Wexler Cannula - 15mm Cannula, Stainless Steel, 2.75" (7cm)
TL8491.1	Wexler Trocar - 15mm Trocar, Stainless Steel, 4.65" (11.8cm)



DL2230

Images not actual size

VATS•MICS

- | | |
|--------|---|
| DL2230 | Wexler Metal Sterilization Tray - Single level with 3 Silicone Brackets, 10.5" x 21.5" x 2.5" (26.6 x 53.3 x 6.3cm) |
| DL2231 | Wexler Metal Sterilization Tray - Single level with Pin Mat, 9.63" x 18", 10.5" x 21.5" x 2.5" (26.6 x 53.3 x 6.3cm) |
| DL2234 | Wexler Metal Sterilization Tray - Single level, 10.5" x 21.5" x 2.5" (26.6 x 53.3 x 6.3cm) (Holds 8 MICS Instruments) |

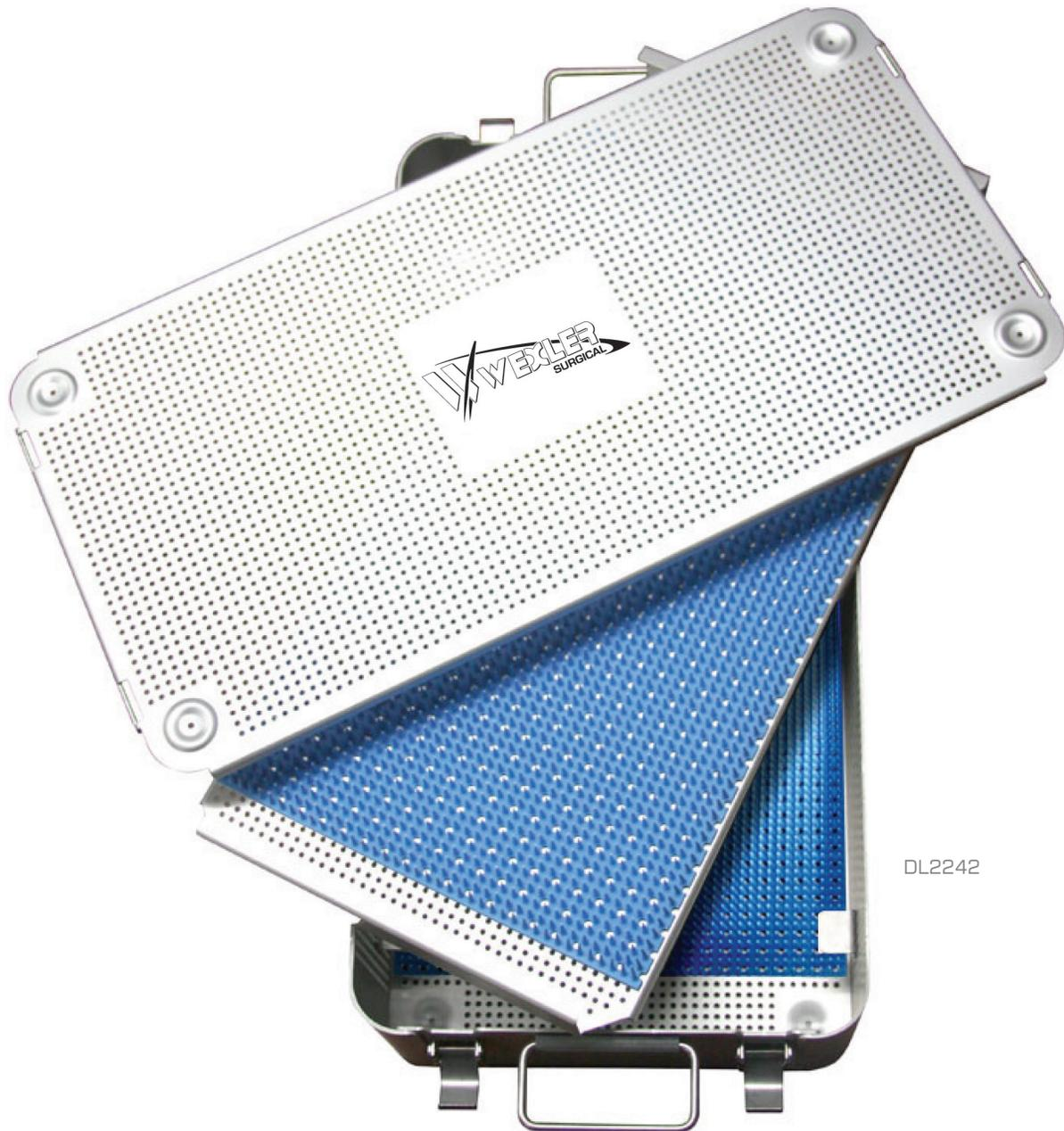

DL2242

Images not actual size

VATS•MICS

- | | |
|--------|---|
| DL2240 | Wexler Metal Sterilization Tray - Double level, Bottom level w/3 Silicone Brackets, Top level with full silicone mat, 10.25" x 21.75" x 4" (26 x 55.2 x 10cm) |
| DL2242 | Wexler Metal Sterilization Tray - Double level with full silicone mats, 10.25" x 21.75" x 5" (26 x 55.2 x 12.7cm) |
| DL2244 | Wexler Metal Sterilization Tray - Double level w/Silicone Brackets, 10.25" x 21.75" x 5" (26 x 55.2 x 12.7cm) |



WEXLER FORCEPS

Round Squeeze Handle | Straight Jaws



FL8590.1



FL8598.1

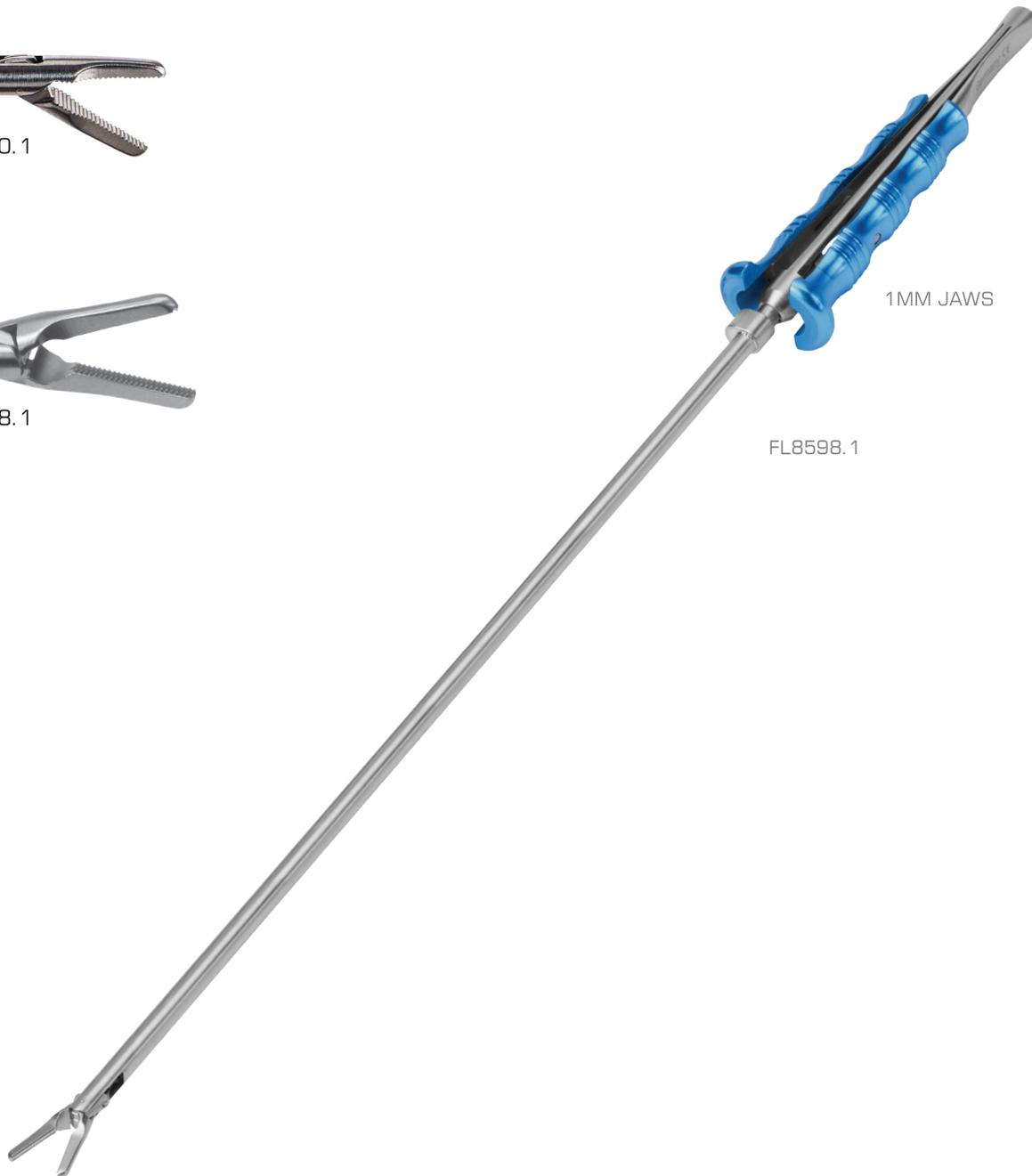

1MM JAWS

FL8598.1

Images not actual size

VATS•MICS

FL8590.1 MIS CABG Forceps – Straight 1mm Serrated jaws, 3mm Shaft, 6.75" (17cm Working Length), Round Squeeze Handle, Stainless Steel, 11.75" (30cm)

FL8598.1 MIS DeBakey Forceps - Straight 1mm jaws, 5mm Shaft, 6.75" (17cm Working Length), Round Squeeze Handle, Stainless Steel, 11.75" (30cm)



WEXLER MIS CLIP APPLIERS

Round Squeeze Handle



FL8639.1
FL8640.1



FL8641.1
FL8642.1



FL8640.1

Images not actual size

MICS

- | | |
|----------|--|
| FL8639.1 | MIS Clip Applier – For use with Small SLS/Vitalitec Clips, 5mm Shaft, 6.75" (17cm Working Length), Round Squeeze Handle, Stainless Steel, 11.75" (30cm) |
| FL8640.1 | MIS Clip Applier – For use with Small SLS/Vitalitec Clips, 5mm Shaft, 10" (25cm Working Length), Round Squeeze Handle, Stainless Steel, 14" (35.5cm) |
| FL8641.1 | MIS Clip Applier – For use with Medium SLS/Vitalitec Clips, 5mm Shaft, 6.75" (17cm Working Length), Round Squeeze Handle, Stainless Steel, 11.75" (30cm) |
| FL8642.1 | MIS Clip Applier – For use with Medium SLS/Vitalitec Clips, 5mm Shaft, 10" (25cm Working Length), Round Squeeze Handle, Stainless Steel, 14" (35.5cm) |



WEXLER MICS NEEDLE HOLDERS

Round Squeeze Handle | Straight / Curved Jaws



NL8590.13



NL8592.13

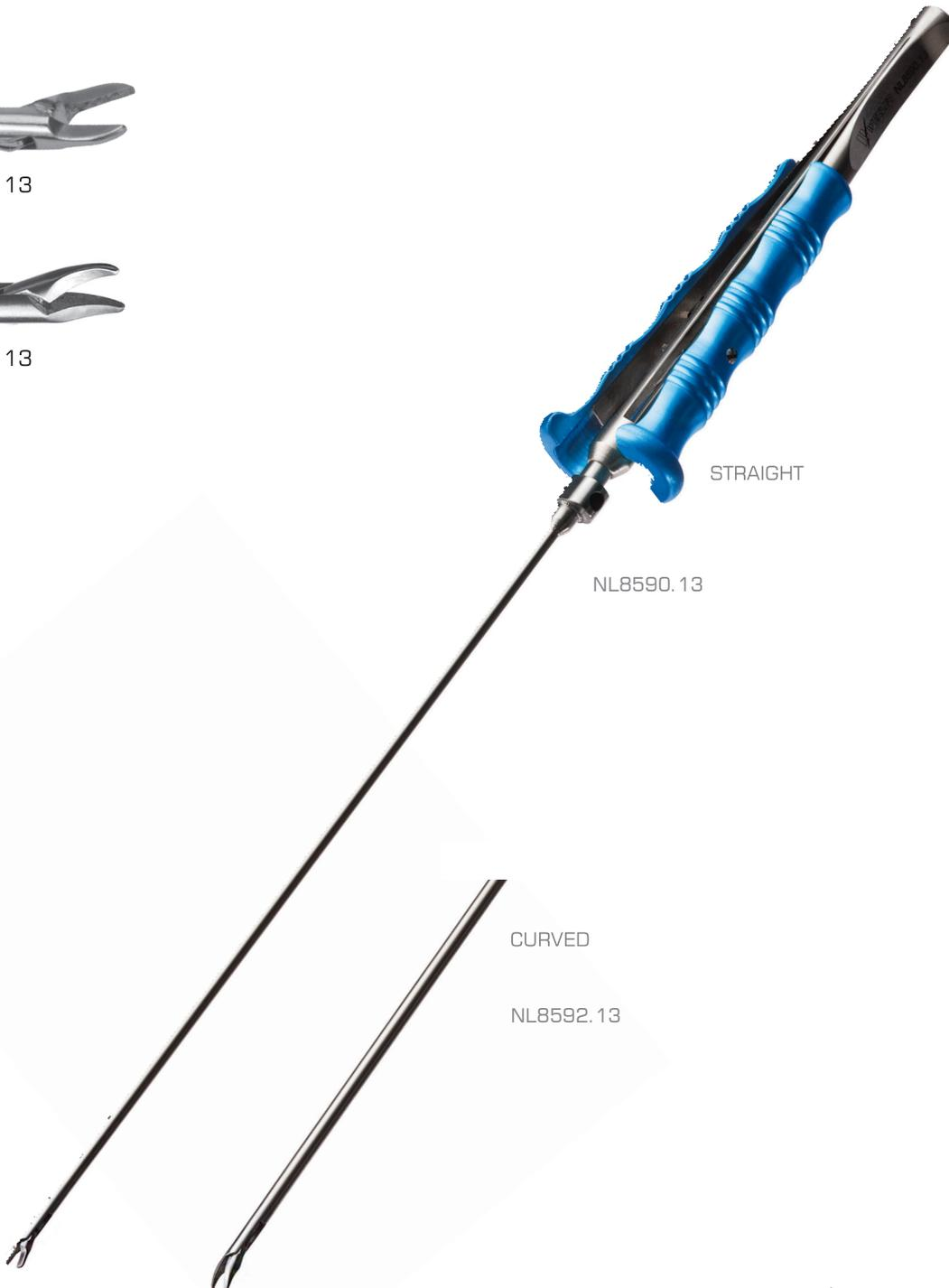

STRAIGHT

NL8590.13

CURVED

NL8592.13

Images not actual size

MICS

- NL8590.13 MIS CABG Needle Holder – Straight TC Coated jaws w/Lock, 3mm Shaft, 6.75" (17cm Working Length), Round Squeeze Handle, Stainless Steel, 11.75" (30cm)
- NL8592.13 MIS CABG Needle Holder – Curved TC Coated jaws w/Lock, 3mm Shaft, 6.75" (17cm Working Length), Round Squeeze Handle, Stainless Steel, 11.75" (30cm)



WEXLER KNOT TIER / PUSHER

Round Squeeze Handle | Angled Jaws



AL8450.1
AL8450.12 (w/Lock)

AL8452.1
AL8452.12 (w/Lock)

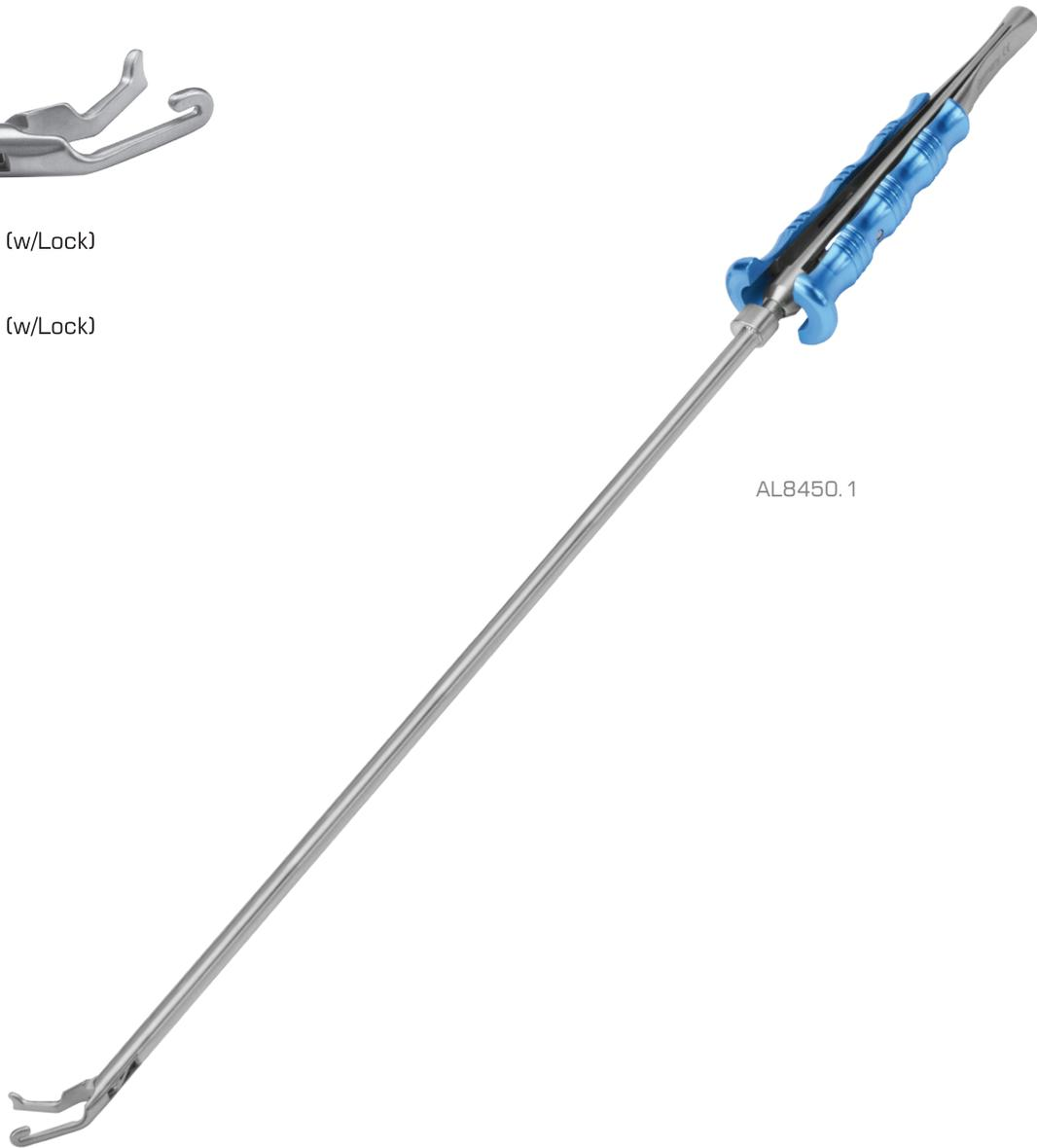

AL8450.1

Images not actual size

VATS•MICS

- | | |
|-----------|---|
| AL8450.1 | Knot Pusher - 5mm Shaft, 6.75" (17cm Working Length), Round Squeeze Handle, Stainless Steel, 11.75" (30cm) |
| AL8450.12 | Knot Pusher - 5mm Shaft w/Lock, 6.75" (17cm Working Length), Round Squeeze Handle, Stainless Steel, 11.75" (30cm) |
| AL8452.1 | Knot Pusher - 5mm Shaft, 10" (25cm Working Length), Round Squeeze Handle, Stainless Steel, 15" (38cm) |
| AL8452.12 | Knot Pusher - 5mm Shaft w/Lock, 10" (25cm Working Length), Round Squeeze Handle, Stainless Steel, 15" (38cm) |



WEXLER MICS SCISSORS

Round Squeeze Handle | Curved / Angled Blades



SL8618.1 | 15°



SL8640.1 | 25°



SL8642.1 | 45°



SL8648.1 | 125°



SL8642.1

Images not actual size

VATS•MICS

CURVED	SL8618.1	MIS Scissors – Curved Blades, 5mm Shaft, 6.75" (17cm Working Length), Round Squeeze Handle, Stainless Steel, 11.75" (30cm)
ANGLED	SL8640.1	MIS Scissors – 25° Angled Blades, 5mm Shaft, 10" (25cm Working Length), Round Squeeze Handle, Stainless Steel, 14" (35.5cm)
	SL8642.1	MIS Scissors – 45° Angled Blades, 5mm Shaft, 10" (25cm Working Length), Round Squeeze Handle, Stainless Steel, 14" (35.5cm)
	SL8648.1	MIS Scissors – 125° Angled Blades, 5mm Shaft, 10" (25cm Working Length), Round Squeeze Handle, Stainless Steel, 14" (35.5cm)



WEXLER CHEST TUBE PASSER

Ring Handle | Curved Shaft



AL1300.1
AL1300.13 w/Ratchet
AL1302.1
AL1302.13 w/Ratchet

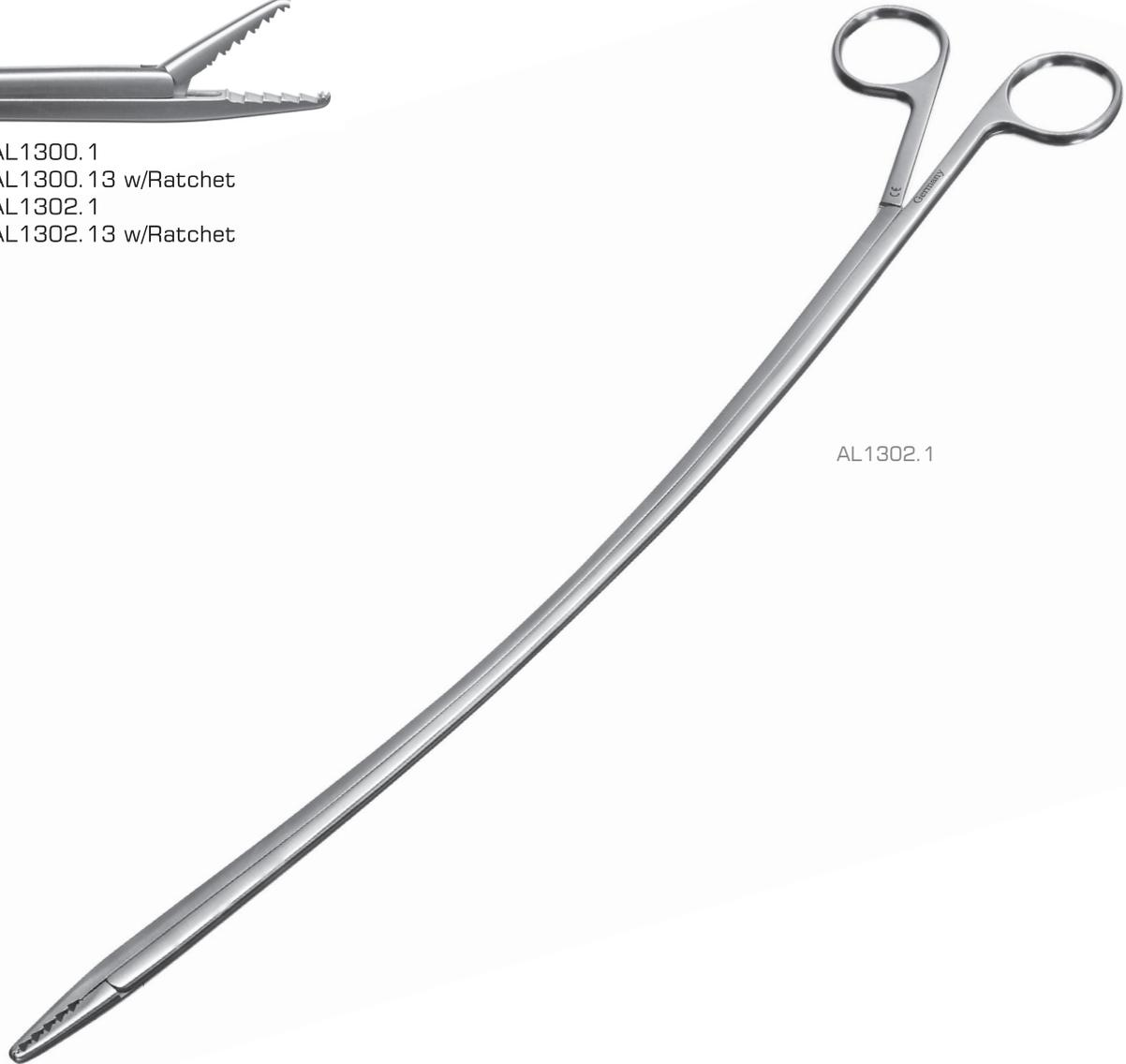

AL1302.1

Images not actual size

VATS•MICS

AL1300.1	Chest Tube Passer – 10mm Curved Shaft, 6.75" (17.5cm Working Length), Stainless Steel, 9.75" (24cm)
AL1300.13	Chest Tube Passer – 10mm Curved Shaft, 6.75" (17.5cm Working Length), w/Ratchet, Stainless Steel, 9.75" (24cm)
AL1302.1	Chest Tube Passer – 10mm Curved Shaft, 11" (28cm Working Length), Stainless Steel, 14" (35.5cm)
AL1302.13	Chest Tube Passer – 10mm Curved Shaft, 11" (28cm Working Length), w/Ratchet, Stainless Steel, 14" (35.5cm)



WEXLER DEBAKEY CLAMPS

Ring Handle | Curved Jaws



Images not actual size

MICS

AL2478.1 Tangential Occlusion Clamp - 34mm DeBaKey Atraumatic jaws, Slightly Curved Shanks, Stainless Steel, 9.25" (23.5cm)



Images not actual size

MICS

AL2125.1 DeBaKey Aorta Clamp - Full Curved DeBaKey Atraumatic jaws, Curved Shanks, Stainless Steel, 10.5" (26.5cm)



DL2230

Images not actual size

VATS•MICS

- | | |
|--------|---|
| DL2230 | Wexler Metal Sterilization Tray - Single level with 3 Silicone Brackets, 10.5" x 21.5" x 2.5" (26.6 x 53.3 x 6.3cm) |
| DL2231 | Wexler Metal Sterilization Tray - Single level with Pin Mat, 9.63" x 18", 10.5" x 21.5" x 2.5" (26.6 x 53.3 x 6.3cm) |
| DL2234 | Wexler Metal Sterilization Tray - Single level, 10.5" x 21.5" x 2.5" (26.6 x 53.3 x 6.3cm) (Holds 8 MICS Instruments) |



WEXLER STERILIZATION TRAYS

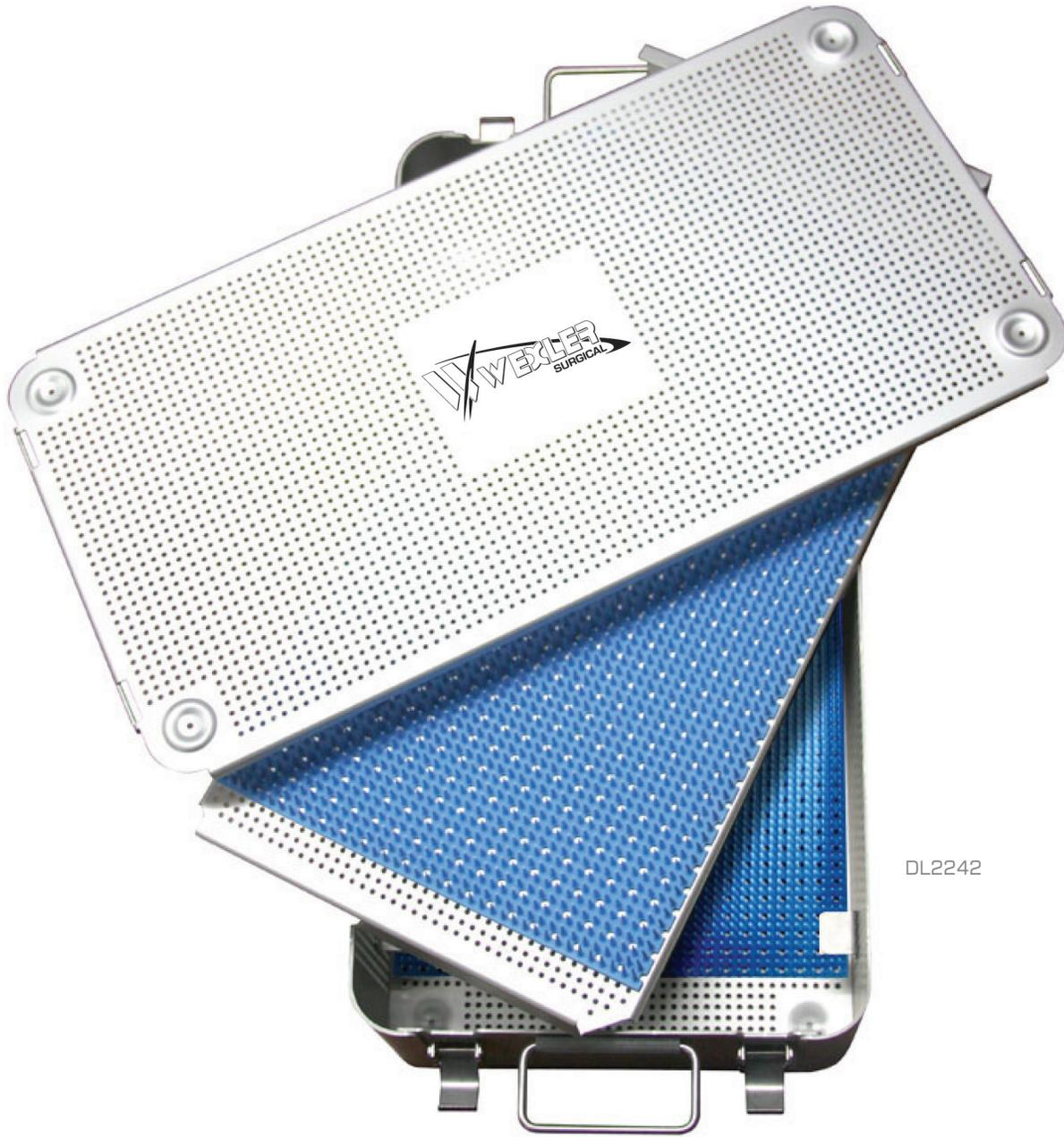

DL2242

Images not actual size

VATS•MICS

- | | |
|--------|---|
| DL2240 | Wexler Metal Sterilization Tray - Double level, Bottom level w/3 Silicone Brackets, Top level with full silicone mat, 10.25" x 21.75" x 4" (26 x 55.2 x 10cm) |
| DL2242 | Wexler Metal Sterilization Tray - Double level with full silicone mats, 10.25" x 21.75" x 5" (26 x 55.2 x 12.7cm) |
| DL2244 | Wexler Metal Sterilization Tray - Double level w/Silicone Brackets, 10.25" x 21.75" x 5" (26 x 55.2 x 12.7cm) |



WEXLER THORACOSCOPIC DEBAKEY CLAMPS

Ring Handle | Curved Jaws

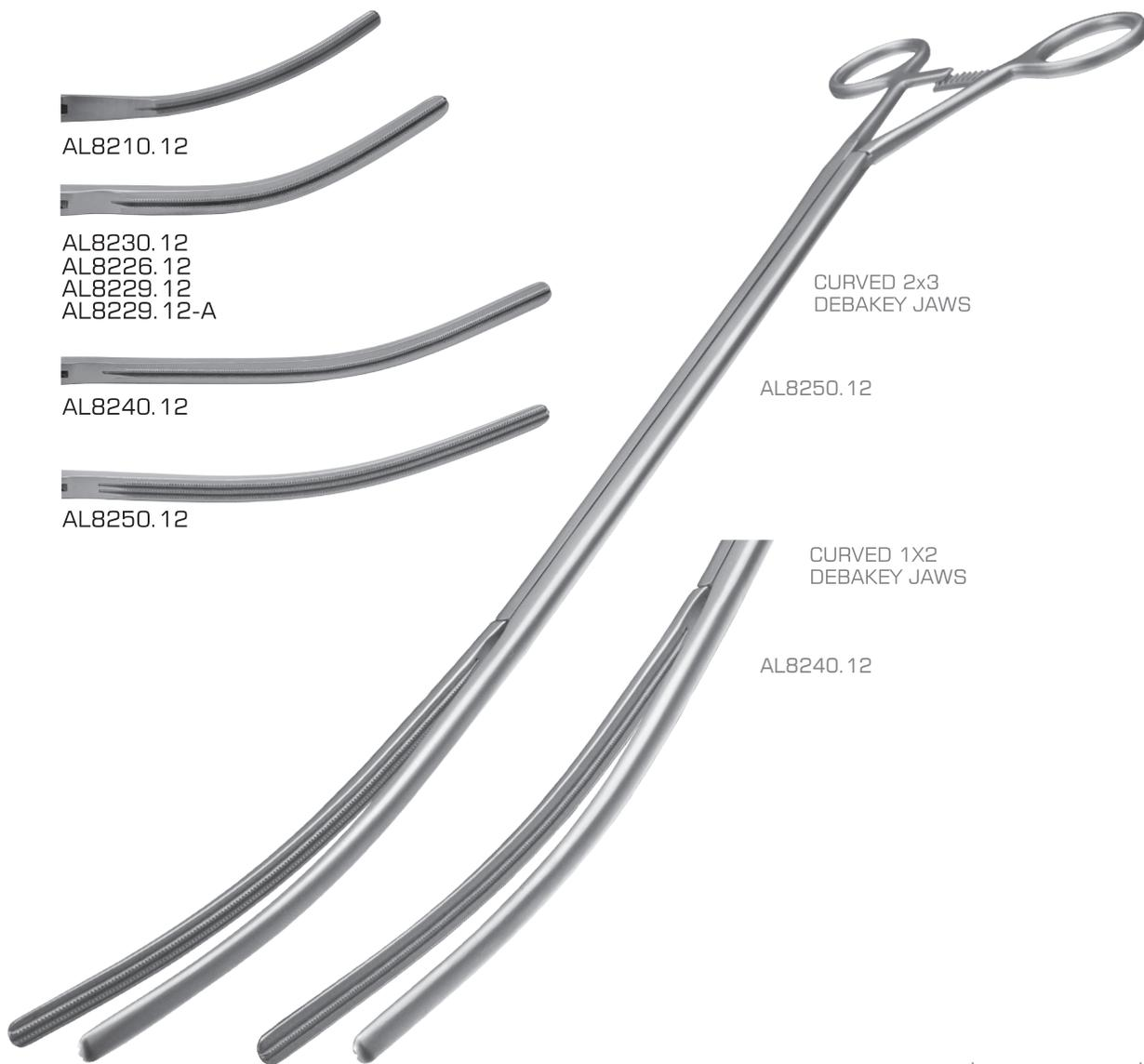

Images not actual size

VATS•MICS

- AL8210.12 Thoracoscopic DeBakey Clamp - 60mm Curved 1x2 DeBakey Atraumatic jaws, 5mm Shaft, w/Ratchet, (21cm Working Length), Stainless Steel, 12.25" (31cm)
- AL8226.12 Thoracoscopic DeBakey Clamp - 65mm Curved Right 1x2 DeBakey Atraumatic jaws, 10mm Shaft, w/Lock, (17cm Working Length), Stainless Steel, 10.25" (26.4cm)
- AL8229.12 Thoracoscopic DeBakey Clamp - 65mm Curved 1x2 DeBakey Atraumatic jaws, 10mm Shaft, w/Lock, (17cm Working Length), Stainless Steel, 10.25" (26.4cm)
- AL8229.12-A Thoracoscopic DeBakey Clamp - 65mm Curved 1x2 DeBakey Atraumatic jaws, 10mm Shaft, w/Lock, Angled Shanks, (17cm Working Length), Stainless Steel, 9.75" (24.8cm)
- AL8230.12 Thoracoscopic DeBakey Clamp - 65mm Curved 1x2 DeBakey Atraumatic jaws, 10mm Shaft, w/Ratchet, (23cm Working Length), Stainless Steel, 12.75" (32cm)
- AL8240.12 Thoracoscopic DeBakey Clamp - 100mm Curved 1x2 DeBakey Atraumatic jaws, 10mm Shaft, w/Ratchet, (25.5cm Working Length), Stainless Steel, 14.25" (36cm)
- AL8250.12 Thoracoscopic DeBakey Clamp - 100mm Curved 2x3 DeBakey Atraumatic jaws, 10mm Shaft, w/Ratchet, (25.5cm Working Length), Stainless Steel, 14.25" (36cm)



WEXLER MIS DEBAKEY FORCEPS

Round Squeeze Handle | Straight Jaws



FL8598.1
FL8600.1
FL8601.1



FL8604.1
FL8606.1
FL8607.1



FL8608.1
FL8610.1



FL8602.1



2.8MM JAWS

FL8604.1

Images not actual size

VATS•MICS

FL8598.1	Wexler MIS DeBakey Forceps - Straight 1mm jaws, 5mm Shaft, 6.75" (17cm Working Length), Round Squeeze Handle, Stainless Steel, 11.75" (30cm)
FL8600.1	Wexler MIS DeBakey Forceps - Straight 1mm jaws, 5mm Shaft, 10" (25cm Working Length), Round Squeeze Handle, Stainless Steel, 14" (35.5cm)
FL8601.1	Wexler MIS DeBakey Forceps - Straight 1mm jaws, 5mm Shaft, 11" (28cm Working Length), Round Squeeze Handle, Stainless Steel, 16" (40.5cm)
FL8602.1	Wexler MIS DeBakey Forceps - Angled 1mm jaws, 5mm Shaft, 10" (25cm Working Length), Round Squeeze Handle, Stainless Steel, 14" (35.5cm)
FL8604.1	Wexler MIS DeBakey Forceps - Straight 2.8mm jaws, 5mm Shaft, 6.75" (17cm Working Length), Round Squeeze Handle, Stainless Steel, 11.75" (30cm)
FL8606.1	Wexler MIS DeBakey Forceps - Straight 2.8mm jaws, 5mm Shaft, 10" (25cm Working Length), Round Squeeze Handle, Stainless Steel, 14" (35.5cm)
FL8607.1	Wexler MIS DeBakey Forceps - Straight 2.8mm jaws, 5mm Shaft, 11" (28cm Working Length), Round Squeeze Handle, Stainless Steel, 16" (40.5cm)
FL8608.1	Wexler MIS DeBakey Forceps - Straight 2x3mm jaws, 5mm Shaft, 6.75" (17cm Working Length), Round Squeeze Handle, Stainless Steel, 11.75" (30cm)
FL8610.1	Wexler MIS DeBakey Forceps - Straight 2x3mm jaws, 5mm Shaft, 10" (25cm Working Length), Round Squeeze Handle, Stainless Steel, 14" (35.5cm)



WEXLER RESANO & SERRATED FORCEPS

Round Squeeze Handle | Straight Jaws



FL8612.1
FL8614.1
FL8616.1



FL8624.14



FL8628.1
FL8630.1

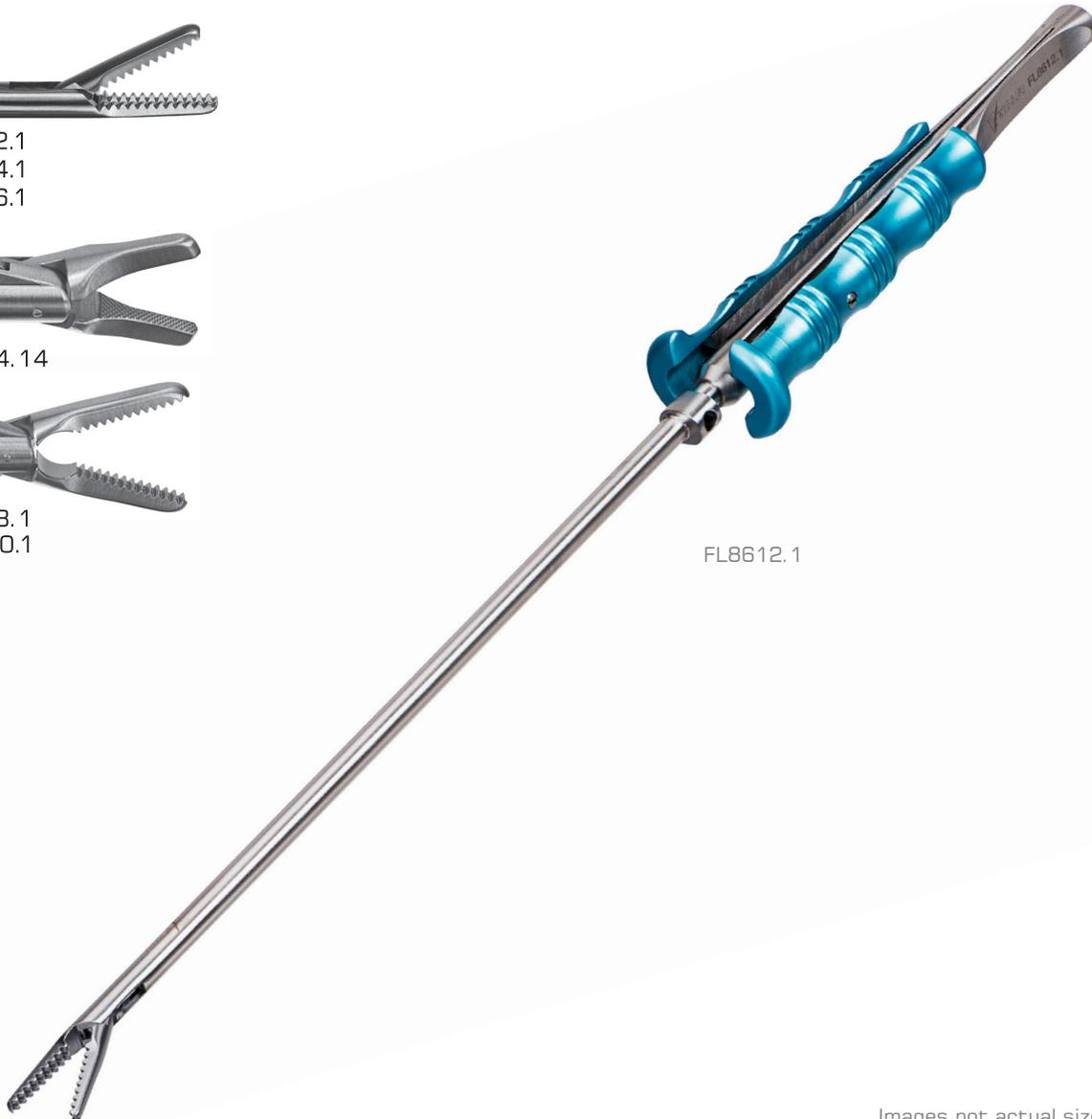

FL8612.1

Images not actual size

VATS•MICS

- FL8612.1 MIS Resano Forceps - Straight Atraumatic jaws, 5mm Shaft, 6.75" (17cm Working Length), Round Squeeze Handle, Stainless Steel, 11.75" (30cm)
- FL8614.1 MIS Resano Forceps - Straight Atraumatic jaws, 5mm Shaft, 10" (25cm Working Length), Round Squeeze Handle, Stainless Steel, 14" (35.5cm)
- FL8616.1 MIS Resano Forceps - Straight Atraumatic jaws, 5mm Shaft, 11" (28cm Working Length), Round Squeeze Handle, Stainless Steel, 16" (40.5cm)
- FL8624.14 MIS Forceps - Straight 1mm jaws w/ TC Inserts, 5mm Shaft, 6.75" (17cm Working Length), Round Squeeze Handle, Stainless Steel, 11.75" (30cm)
- FL8628.1 MIS Forceps - Straight 2.8mm Serrated jaws, 5mm Shaft, 6.75" (17cm Working Length), Round Squeeze Handle, Stainless Steel, 11.75" (30cm)
- FL8630.1 MIS Forceps - Straight 2.8mm Serrated jaws, 5mm Shaft, 10" (25cm Working Length), Round Squeeze Handle, Stainless Steel, 14" (35.5cm)



WEXLER RUSSIAN & BIOPSY FORCEPS

Round Squeeze Handle



FL8620.1



FL8634.1



FL8620.1

Images not actual size

VATS•MICS

- | | |
|----------|---|
| FL8620.1 | MIS Russian Forceps – Curved Left Oval Serrated Tips, 5mm Shaft, 10” (25cm Working Length), Round Squeeze Handle, Stainless Steel, 14” (35.5cm) |
| FL8634.1 | MIS Biopsy Forceps – Straight Oval Biopsy Tips, 5mm Shaft, 10” (25cm Working Length), Round Squeeze Handle, Stainless Steel, 14” (35.5cm) |



WEXLER MIS CLIP APPLIERS

Round Squeeze Handle



FL8639.1
FL8640.1



FL8641.1
FL8642.1



FL8640.1

Images not actual size

MICS

- | | |
|----------|--|
| FL8639.1 | MIS Clip Applier – For use with Small SLS/Vitalitec Clips, 5mm Shaft, 6.75" (17cm Working Length), Round Squeeze Handle, Stainless Steel, 11.75" (30cm) |
| FL8640.1 | MIS Clip Applier – For use with Small SLS/Vitalitec Clips, 5mm Shaft, 10" (25cm Working Length), Round Squeeze Handle, Stainless Steel, 14" (35.5cm) |
| FL8641.1 | MIS Clip Applier – For use with Medium SLS/Vitalitec Clips, 5mm Shaft, 6.75" (17cm Working Length), Round Squeeze Handle, Stainless Steel, 11.75" (30cm) |
| FL8642.1 | MIS Clip Applier – For use with Medium SLS/Vitalitec Clips, 5mm Shaft, 10" (25cm Working Length), Round Squeeze Handle, Stainless Steel, 14" (35.5cm) |



WEXLER NEEDLE HOLDERS - (STRAIGHT)

Ring Handle | Straight / Curved Jaws



NL8600.13



NL8598.15
NL8600.15



NL8608.15
NL8610.15
NL8611.15



NL8612.15
NL8614.15



NL8612.15

Images not actual size

VATS•MICS

STRAIGHT

NL8598.15	MIS Needle Holder - Straight jaws w/TC-Inserts, w/Lock, 5mm Shaft, 6.75" (17cm Working Length), Round Squeeze Handle, Stainless Steel, 11.75" (30cm)
NL8600.13	MIS Needle Holder - Straight TC-Coated jaws, w/Lock, 5mm Shaft, 10" (25cm Working Length), Round Squeeze Handle, Stainless Steel, 14" (35.5cm)
NL8600.15	MIS Needle Holder - Straight jaws w/TC-Inserts, w/Lock, 5mm Shaft, 10" (25cm Working Length), Round Squeeze Handle, Stainless Steel, 14" (35.5cm)
NL8604.15	MIS Needle Holder - Straight jaws w/TC Inserts, w/Lock, 5mm Shaft, 11" (28cm Working Length), Round Squeeze Handle, Stainless Steel, 16" (40.5cm)
NL8608.15	MIS Needle Holder - Straight Ryder jaws w/TC-Inserts, w/Lock, 5mm Shaft, 6.75" (17cm Working Length), Round Squeeze Handle, Stainless Steel, 11.75" (30cm)
NL8610.15	MIS Needle Holder - Straight Ryder jaws w/TC-Inserts, w/Lock, 5mm Shaft, 10" (25cm Working Length), Round Squeeze Handle, Stainless Steel, 14" (35.5cm)
NL8611.15	MIS Needle Holder - Straight Ryder jaws w/TC Inserts, w/Lock, 5mm Shaft, 11" (28cm Working Length), Round Squeeze Handle, Stainless Steel, 16" (40.5cm)
NL8612.15	MIS Needle Holder - Short Straight Ryder jaws w/TC-Inserts, w/Lock, 5mm Shaft, 6.75" (17cm Working Length), Round Squeeze Handle, Stainless Steel, 11.75" (30cm)
NL8614.15	MIS Needle Holder - Short Straight Ryder jaws w/TC-Inserts, w/Lock, 5mm Shaft, 10" (25cm Working Length), Round Squeeze Handle, Stainless Steel, 14" (35.5cm)



WEXLER NEEDLE HOLDERS - (CURVED)

Round Squeeze Handle | Curved Jaws



NL8602.13



NL8601.15
NL8602.15



NL8603.15



NL8616.15
NL8618.15



NL8602.15

Images not actual size

VATS•MICS

CURVED

NL8601.15	MIS Needle Holder - Curved jaws w/TC-Inserts, w/Lock, 5mm Shaft, 6.75" (17cm Working Length), Round Squeeze Handle, Stainless Steel, 11.75" (30cm)
NL8602.13	MIS Needle Holder - Curved TC-Coated jaws, w/Lock, 5mm Shaft, 10" (25cm Working Length), Round Squeeze Handle, Stainless Steel, 14" (35.5cm)
NL8602.15	MIS Needle Holder - Curved jaws w/TC-Inserts, w/Lock, 5mm Shaft, 10" (25cm Working Length), Round Squeeze Handle, Stainless Steel, 14" (35.5cm)
NL8603.15	MIS Needle Holder - Curved jaws w/TC-Inserts, w/Lock, 5mm Shaft, 11" (28cm Working Length), Round Squeeze Handle, Stainless Steel, 16" (40.5cm)
NL8616.15	MIS Needle Holder - Short Curved jaws w/TC-Inserts, w/Lock, 5mm Shaft, 6.75" (17cm Working Length), Round Squeeze Handle, Stainless Steel, 11.75" (30cm)
NL8618.15	MIS Needle Holder - Short Curved jaws w/TC-Inserts, w/Lock, 5mm Shaft, 10" (25cm Working Length), Round Squeeze Handle, Stainless Steel, 14" (35.5cm)



WEXLER MIS NEEDLE HOLDERS

Ring Handle | Straight Jaws



NL8402.13



Images not actual size

VATS•MICS

STRAIGHT

NL8402.13

MIS Needle Holder - TC-Coated jaws, w/Lock, 5mm Shaft, 6.5"
(16.5cm Working Length), Stainless Steel, 10.5" (26.5cm)



WEXLER KNOT / TIER PUSHER

Round Squeeze Handle | Angled Jaws



AL8450.1
AL8450.12 (w/Lock)

AL8452.1
AL8452.12 (w/Lock)



AL8450.1

Images not actual size

VATS•MICS

- AL8450.1 Knot Tier/Pusher - 5mm Shaft, 6.75" (17cm Working Length), Round Squeeze Handle, Stainless Steel, 11.75" (30cm)
- AL8450.12 Knot Tier/Pusher - 5mm Shaft w/Lock, 6.75" (17cm Working Length), Round Squeeze Handle, Stainless Steel, 11.75" (30cm)
- AL8452.1 Knot Tier/Pusher - 5mm Shaft, 10" (25cm Working Length), Round Squeeze Handle, Stainless Steel, 15" (38cm)
- AL8452.12 Knot Tier/Pusher - 5mm Shaft w/Lock, 10" (25cm Working Length), Round Squeeze Handle, Stainless Steel, 15" (38cm)



MICS SCISSORS

Round Squeeze Handle | Curved / Strongly Curved / Full Curved / Angled Blades



SL8618.1 | 15°
SL8620.1



SL8622.1 | 30°
SL8624.1



SL8626.1 | 70°
SL8628.1



SL8640.1 | 25°



SL8642.1 | 45°



SL8648.1 | 125°



SL8642.1

Images not actual size

VATS•MICS

CURVED

- SL8618.1 MIS Scissors - 15° Curved Blades, 5mm Shaft, 6.75" (17cm Working Length), Round Squeeze Handle, Stainless Steel, 11.75" (30cm)
- SL8620.1 MIS Scissors - 15° Curved Blades, 5mm Shaft, 10" (25cm Working Length), Round Squeeze Handle, Stainless Steel, 14" (35.5cm)

STRONGLY CURVED

- SL8622.1 MIS Scissors - 30° Strongly Curved Blades, 5mm Shaft, 6.75" (17cm Working Length), Round Squeeze Handle, Stainless Steel, 11.75" (30cm)
- SL8624.1 MIS Scissors - 30° Strongly Curved Blades, 5mm Shaft, 10" (25cm Working Length), Round Squeeze Handle, Stainless Steel, 14" (35.5cm)
- SL8625.1 MIS Scissors - 30° Strongly Curved Blades, 5mm Shaft, 11" (28cm Working Length), Round Squeeze Handle, Stainless Steel, 16" (40.5cm)

FULL CURVED

- SL8626.1 MIS Scissors - 70° Full Curved Blades, 5mm Shaft, 6.75" (17cm Working Length), Round Squeeze Handle, Stainless Steel, 11.75" (30cm)
- SL8628.1 MIS Scissors - 70° Full Curved Blades, 5mm Shaft, 10" (25cm Working Length), Round Squeeze Handle, Stainless Steel, 14" (35.5cm)
- SL8630.1 MIS Scissors - 70° Full Curved Blades, 5mm Shaft, 11" (28cm Working Length), Round Squeeze Handle, Stainless Steel, 16" (40.5cm)

ANGLED

- SL8640.1 MIS Scissors - 25° Angled Blades, 5mm Shaft, 10" (25cm Working Length), Round Squeeze Handle, Stainless Steel, 14" (35.5cm)
- SL8642.1 MIS Scissors - 45° Angled Blades, 5mm Shaft, 10" (25cm Working Length), Round Squeeze Handle, Stainless Steel, 14" (35.5cm)
- SL8648.1 MIS Scissors - 125° Angled Blades, 5mm Shaft, 10" (25cm Working Length), Round Squeeze Handle, Stainless Steel, 14" (35.5cm)



THORACOSCOPIC DISSECTING & METZENBAUM SCISSORS

Ring Handle | Curved Blades

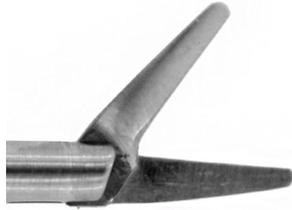

SL8400.1S



SL8402.1S



SL8404.1S

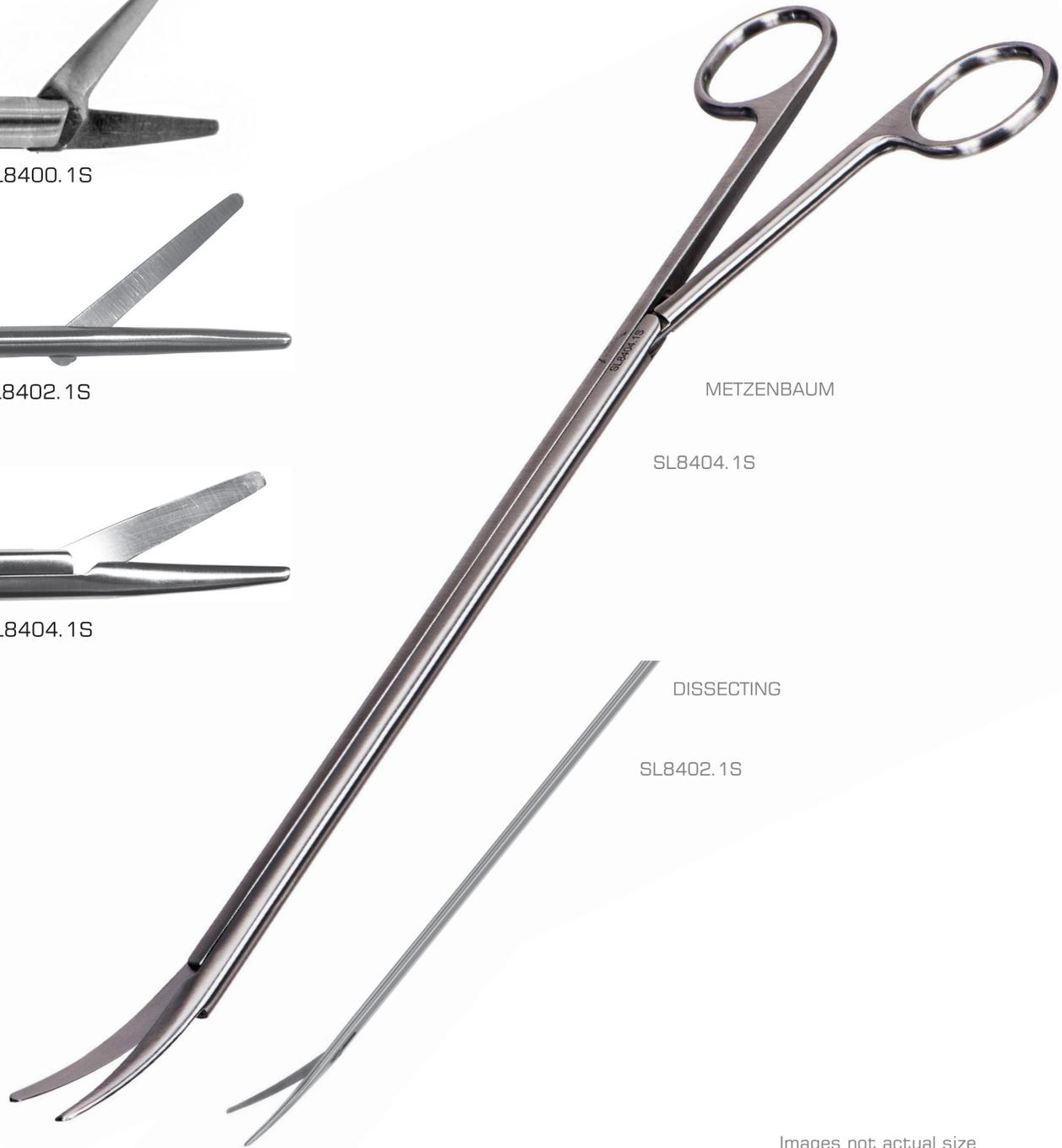

Images not actual size

VATS•MICS

SL8400.1S Thoracoscopic Micro Scissors - Straight 1cm Razor Edge Blades w/Blunt Micro tips, 5mm Shaft, 6.5" (16.5cm Working Length), Stainless Steel, 10.5" (26.5cm)

SL8402.1S Thoracoscopic Dissecting Scissors - Curved 3cm Blades w/Blunt tips, 5mm Shaft, 7.5" (19cm Working Length), Stainless Steel, 11.5" (29cm)

SL8404.1S Thoracoscopic Metzenbaum Scissors - Curved 3.5cm Blades w/Blunt tips, 10mm Shaft, 7.75" (19cm Working Length), Stainless Steel, 11.5" (29cm)



WEXLER CHEST TUBE PASSER

Ring Handle | Curved Shaft



AL1300.1
AL1300.13 w/Ratchet
AL1302.1
AL1302.13 w/Ratchet

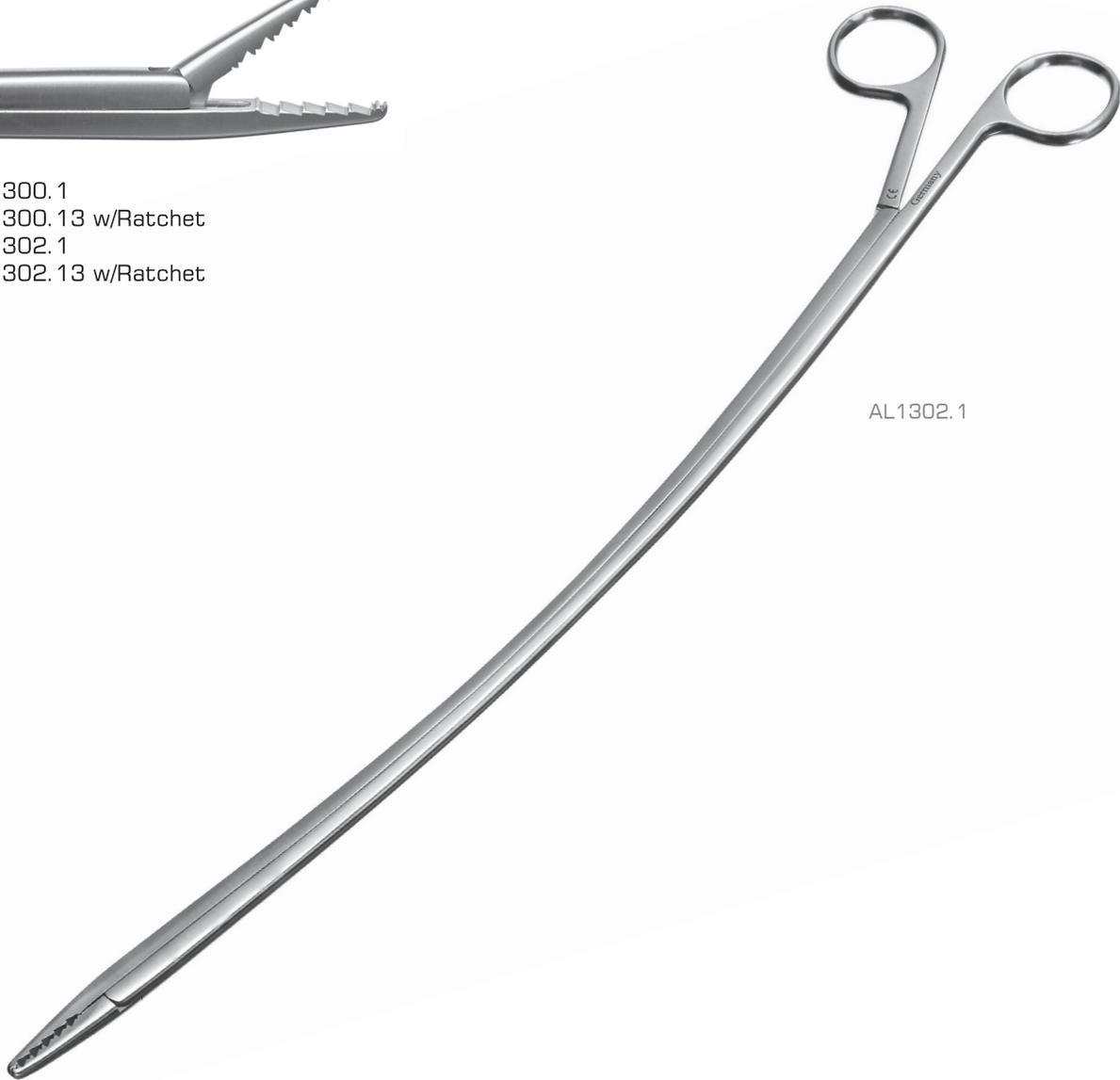

AL1302.1

Images not actual size

VATS•MICS

- | | |
|-----------|--|
| AL1300.1 | Chest Tube Passer - 10mm Curved Shaft, 6.75" (17.5cm Working Length), Stainless Steel, 9.75" (24cm) |
| AL1300.13 | Chest Tube Passer - 10mm Curved Shaft, 6.75" (17.5cm Working Length), w/Ratchet, Stainless Steel, 9.75" (24cm) |
| AL1302.1 | Chest Tube Passer - 10mm Curved Shaft, 11" (28cm Working Length), Stainless Steel, 14" (35.5cm) |
| AL1302.13 | Chest Tube Passer - 10mm Curved Shaft, 11" (28cm Working Length), w/Ratchet, Stainless Steel, 14" (35.5cm) |



HOOKS

Round Handle | Angled Tips



AL1106.1F



AL1106.1



AL1108.1

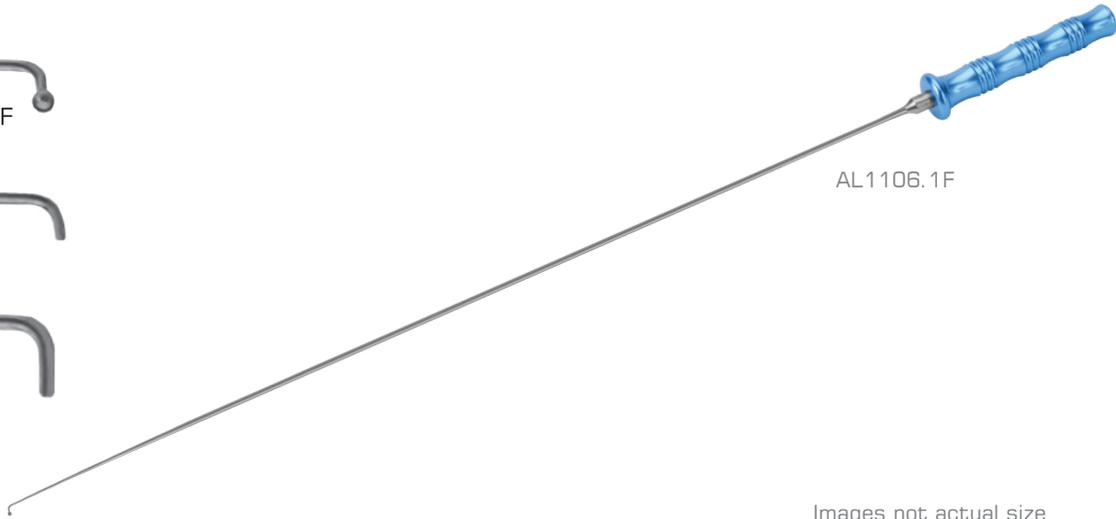

AL1106.1F

Images not actual size

VATS•MICS

- AL1106.1F Fine Nerve & Vessel Hook with Bead Tip - Round Handle, Stainless Steel, 13.75" (35cm)
- AL1106.1 Nerve & Vessel Hook - Round Handle, Stainless Steel, 13.75" (35cm)
- AL1108.1 Vessel Hook - Round Handle, Stainless Steel, 13.75" (35cm)



SUTURE PULLER / PUSHER

Round Handle | Straight Tip



HL1012.1



HL1016.1

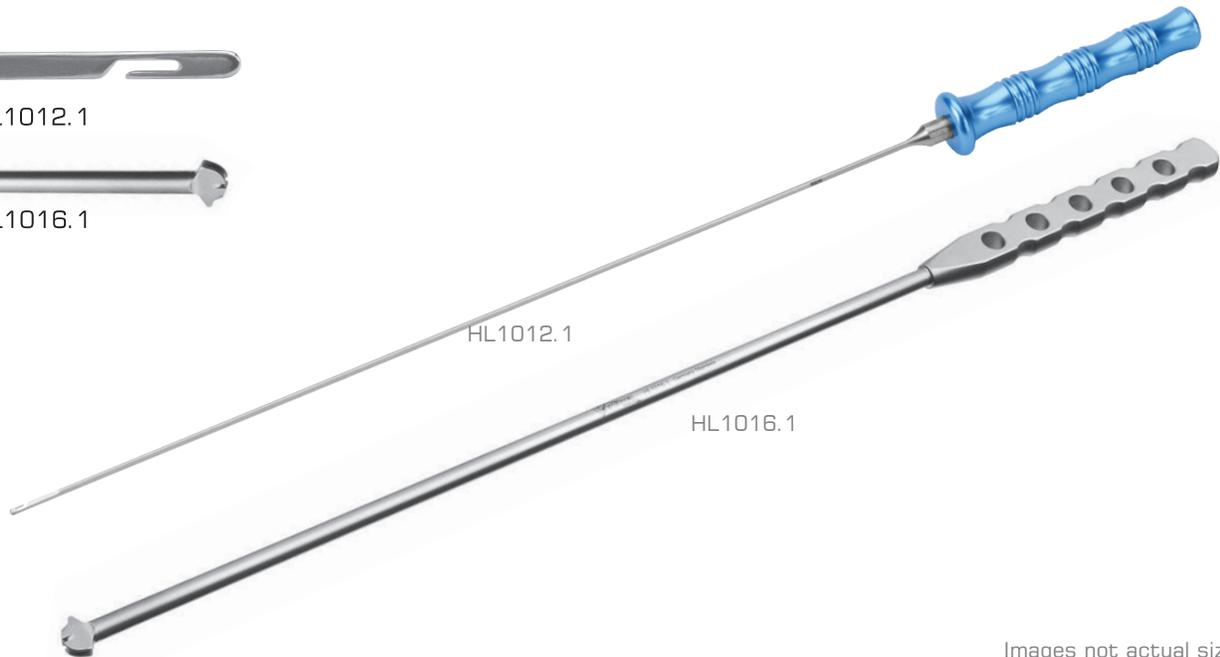

HL1012.1

HL1016.1

Images not actual size

VATS•MICS

- HL1012.1 Suture Puller - Round Handle, Stainless Steel, 13.75" (35cm)
- HL1016.1 Suture Pusher - Round Handle, Stainless Steel, 13.75" (35cm)



SCALPEL BLADE HOLDER

Round Handle



Images not actual size

VATS•MICS

AL0199.1 Scalpel Blade Holder – Round Handle, Stainless Steel, 14.5" (37cm)



SUTURE PULLER / PUSHER

Ring Handle | Straight Tip

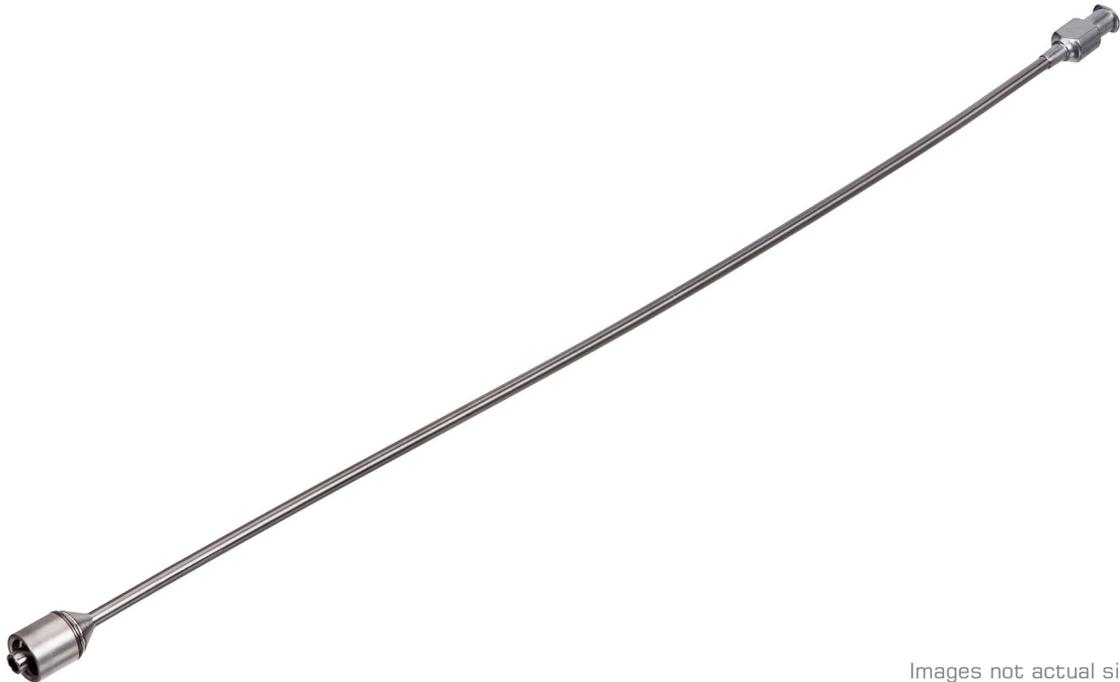

Images not actual size

VATS•MICS

CL0730.1 Needle/Syringe Extender - 4mm tube, Nitinol, Malleable, 12" (30.5cm)



SUCTION INSTRUMENTS

Straight Handle | Curved Shaft



AL1126.1
AL1128.1
AL1130.1
AL1132.1



AL1140.1
AL1142.1

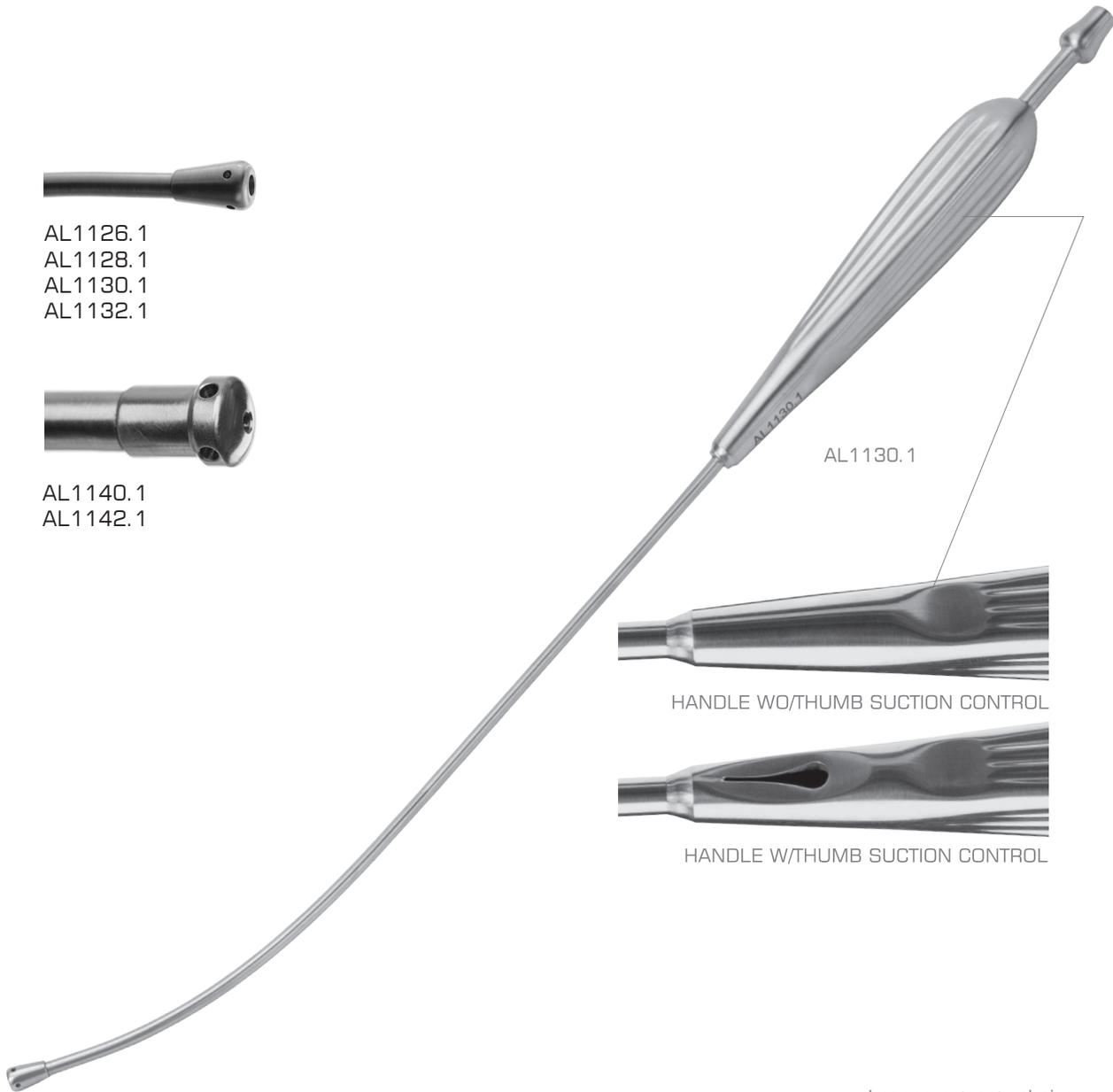

AL1130.1



HANDLE W/OUT THUMB SUCTION CONTROL



HANDLE W/THUMB SUCTION CONTROL

Images not actual size

VATS•MICS

- AL1126.1 Suction Instrument - Curved 3.2mm tube, Yankauer Handle, 6.75" (17cm Working Length), Stainless Steel, 12.25" (31cm)
- AL1128.1 Suction Instrument - Curved 3.2mm tube, Yankauer Handle, w/Variable Suction, 6.75" (17cm Working Length), Stainless Steel, 12.25" (31cm)
- AL1130.1 Suction Instrument - Curved 3.2mm tube, Yankauer Handle, 8.75" (22cm Working Length), Stainless Steel, 14.25" (36cm)
- AL1132.1 Suction Instrument - Curved 3.2mm tube, Yankauer Handle, w/Variable Suction, 8.75" (22cm Working Length), Stainless Steel, 14.25" (36cm)
- AL1140.1 Fell Suction Instrument - Angled 8mm tube, Yankauer Handle, 7" (18cm Working Length), Stainless Steel, 13" (33cm)
- AL1142.1 Suction Instrument - Straight 10mm tube Sump Tip, Yankauer Handle, 12.5" (32cm Working Length), Stainless Steel, 17.75" (45.5cm)



SUCTION BRUSH SETS

Straight Handle



Images not actual size

VATS•MICS

- DL0701 Brush Set for Straight Suction Instrument - 50cm x 10mm, White, Pack of 10 (For use with Wexler Item # AL1124.1 and AL1125.1)
- DL0702 Brush Set for Curved Suction Instrument - Pack of 10 (For use with Wexler Item # AL1126.1 and AL1128.1)



CHORDAE SIZER

Round Handle



Images not actual size

VATS•MICS

AL1190.1 Chordae Sizer - Blue Round Handle, 14.25" (36cm)



RONGUERS

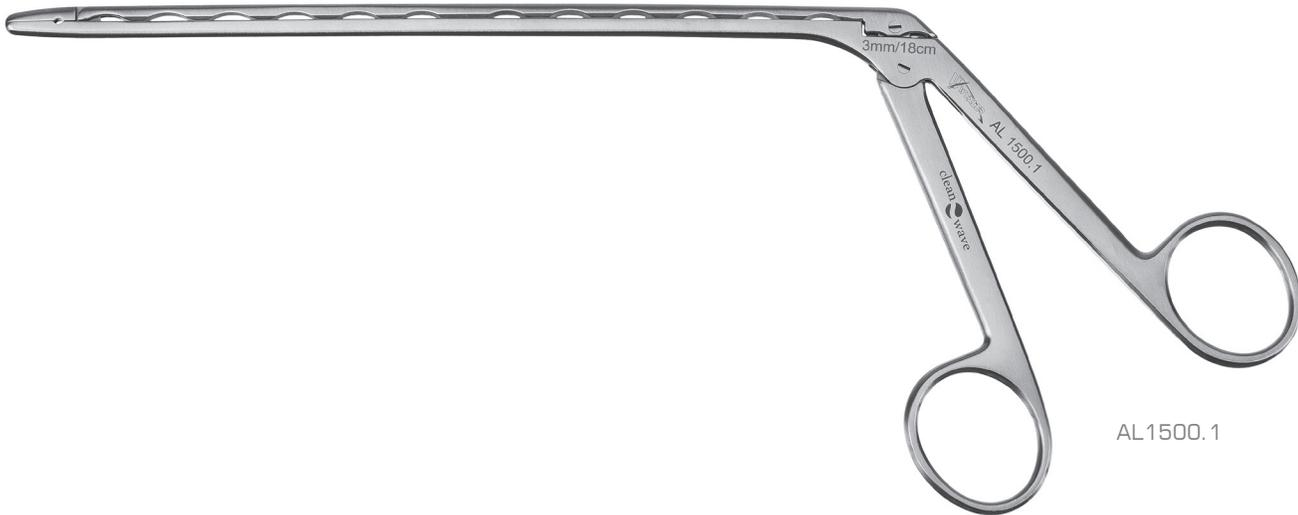

AL1500.1

Images not actual size

VATS•MICS

- AL1500.1 Ronguers - Straight 3mm x 10mm jaw, Stainless Steel, 7" (18cm)
- AL1506.1 Ronguers - Straight 3mm x 10mm jaw, Stainless Steel, 15.75" (40cm)
- AL1510.1 Ronguers - Angled 30° Up 3mm x 10mm jaw, Stainless Steel, 7" (18cm)
- AL1520.1 Ronguers - Angled 30° Down 3mm x 10mm jaw, Stainless Steel, 7" (18cm)



DL2230

Images not actual size

VATS•MICS

- | | |
|--------|---|
| DL2230 | Wexler Metal Sterilization Tray - Single level with 3 Silicone Brackets, 10.5" x 21.5" x 2.5" (26.6 x 53.3 x 6.3cm) |
| DL2231 | Wexler Metal Sterilization Tray - Single level with Pin Mat, 9.63" x 18", 10.5" x 21.5" x 2.5" (26.6 x 53.3 x 6.3cm) |
| DL2234 | Wexler Metal Sterilization Tray - Single level, 10.5" x 21.5" x 2.5" (26.6 x 53.3 x 6.3cm) (Holds 8 MICS Instruments) |



WEXLER STERILIZATION TRAYS

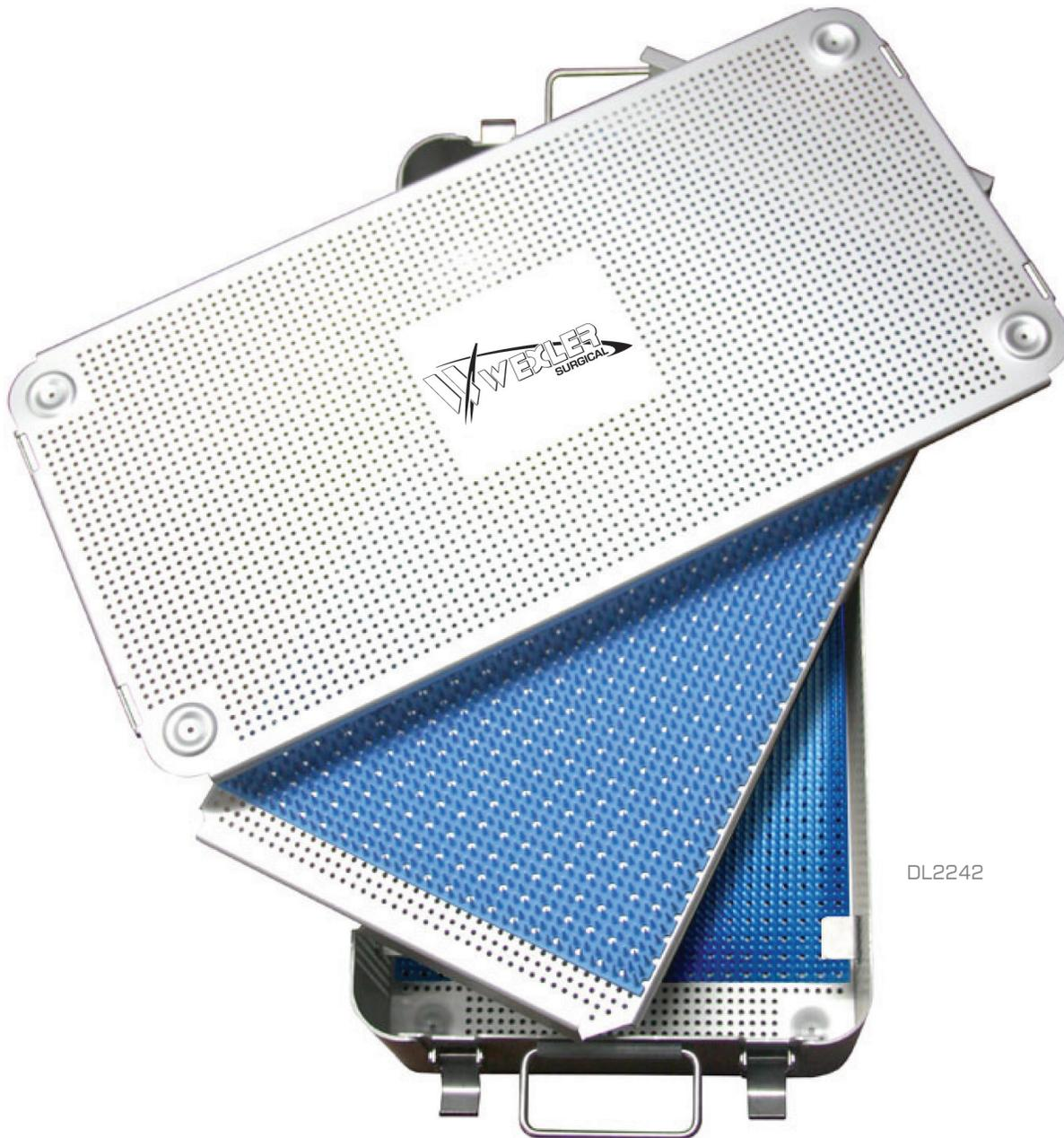

DL2242

Images not actual size

VATS•MICS

- DL2240 Wexler Metal Sterilization Tray - Double level, Bottom level w/3 Silicone Brackets, Top level with full silicone mat, 10.25" x 21.75" x 4" (26 x 55.2 x 10cm)
- DL2242 Wexler Metal Sterilization Tray - Double level with full silicone mats, 10.25" x 21.75" x 5" (26 x 55.2 x 12.7cm)
- DL2244 Wexler Metal Sterilization Tray - Double level w/Silicone Brackets, 10.25" x 21.75" x 5" (26 x 55.2 x 12.7cm)



EPIC VATS DEBAKEY CLAMP



AH8230.12



AH8250.12

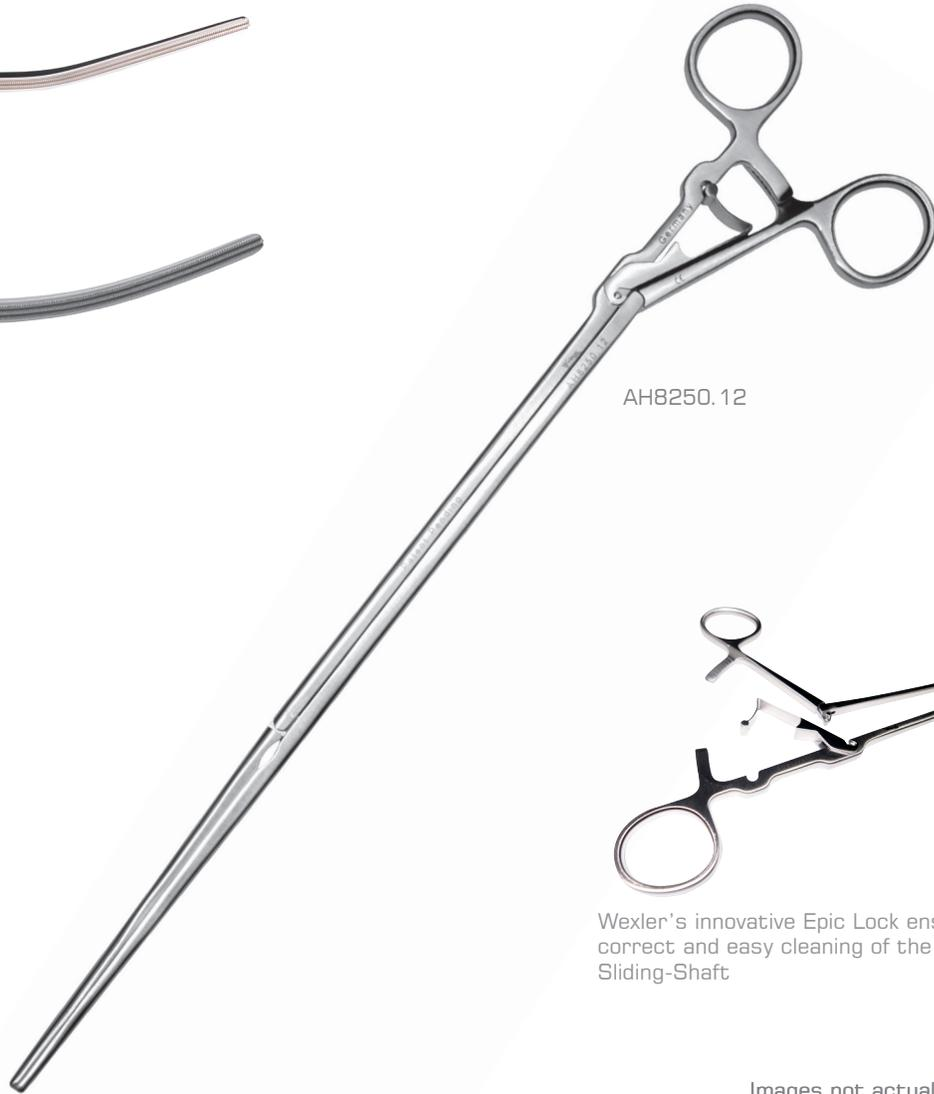

AH8250.12



Wexler's innovative Epic Lock ensures correct and easy cleaning of the Sliding-Shaft

Images not actual size

VATS•MICS

- AH8230.12 EPIC VATS DeBakey Clamp - 65mm Curved 1x2 DeBakey Atraumatic jaws, 10mm Shaft, w/Lock 23cm Working Length, 12.75" (32cm)
- AH8250.12 EPIC VATS DeBakey Clamp - 100mm Curved 2x3 DeBakey Atrumatic jaws, 10mm Shaft, w/Lock, 25.5cm Working Length, 14.25" (36cm)



EPIC VATS RIGHT ANGLE FINE DISSECTOR



FH8426.1F

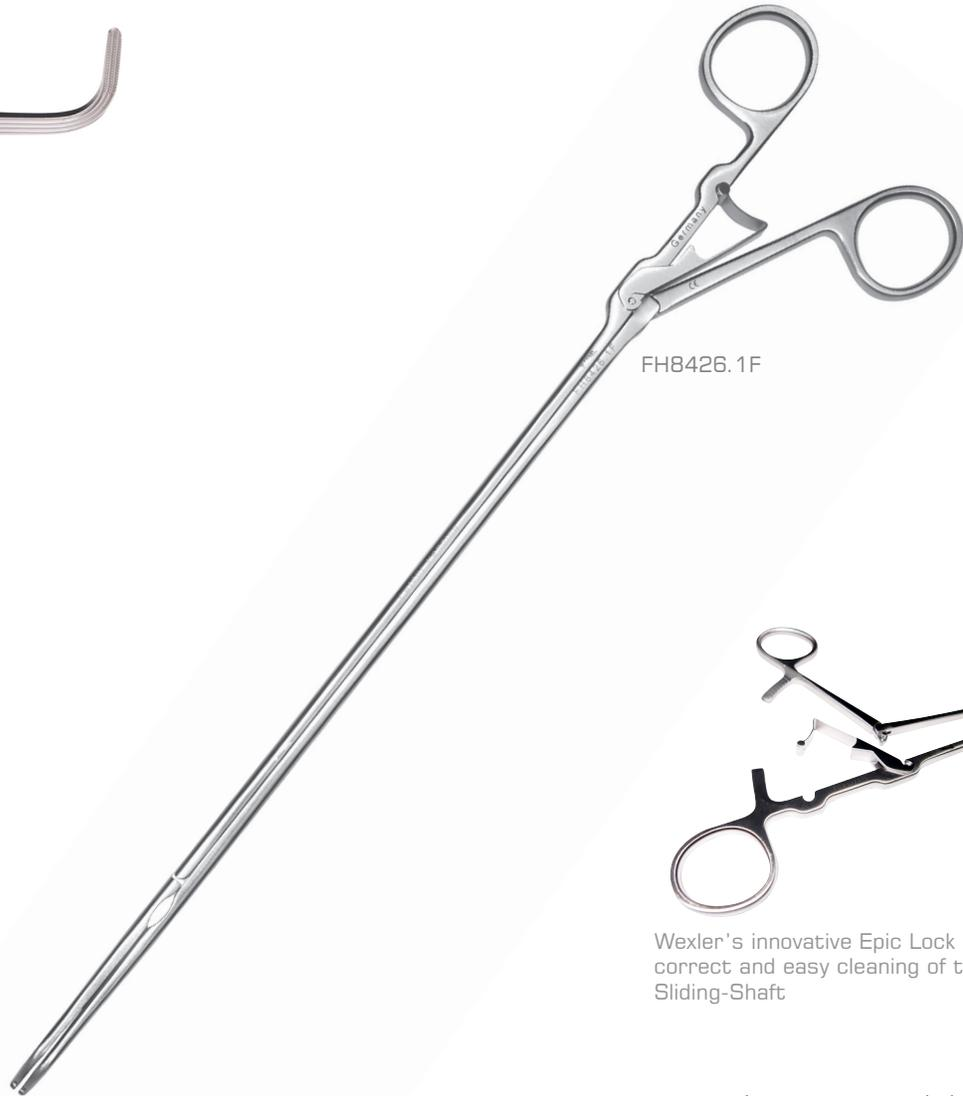

FH8426.1F



Wexler's innovative Epic Lock ensures correct and easy cleaning of the Sliding-Shaft

Images not actual size

VATS•MICS

FH8426.1F

EPIC VATS Right Angle Fine Dissector - DeBakey/Cooley Fine serrated jaws, 7mm Shaft, 9.5" (24cm) Working Length, 13.5" (34cm)



EPIC VATS FOERSTER FORCEPS



FH8438.12



FH8436.12

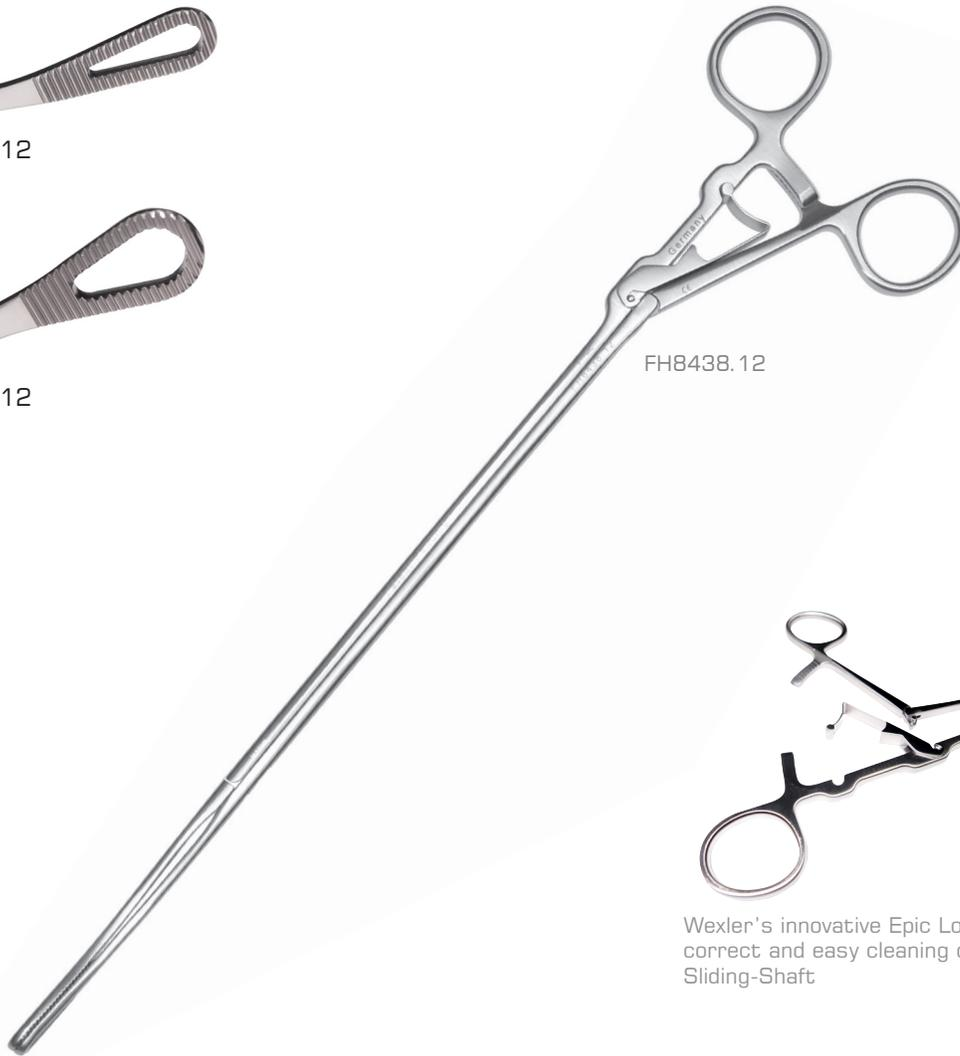

FH8438.12



Wexler's innovative Epic Lock ensures correct and easy cleaning of the Sliding-Shaft

Images not actual size

VATS•MICS

- FH8436.12 EPIC VATS Foerster Forceps - Curved Left 12mm Oval serrated jaws, 7mm Shaft, w/Ratchet, 9.5" (24cm Working Length), 13.5" (34cm)
- FH8438.12 EPIC VATS Foerster Forceps - Curved Left 10mm Oval Serrated jaws, 7mm Shaft, w, Ratchet, 9.5" (24cm Working Length), 13.5" (34cm)



SH8404.1S

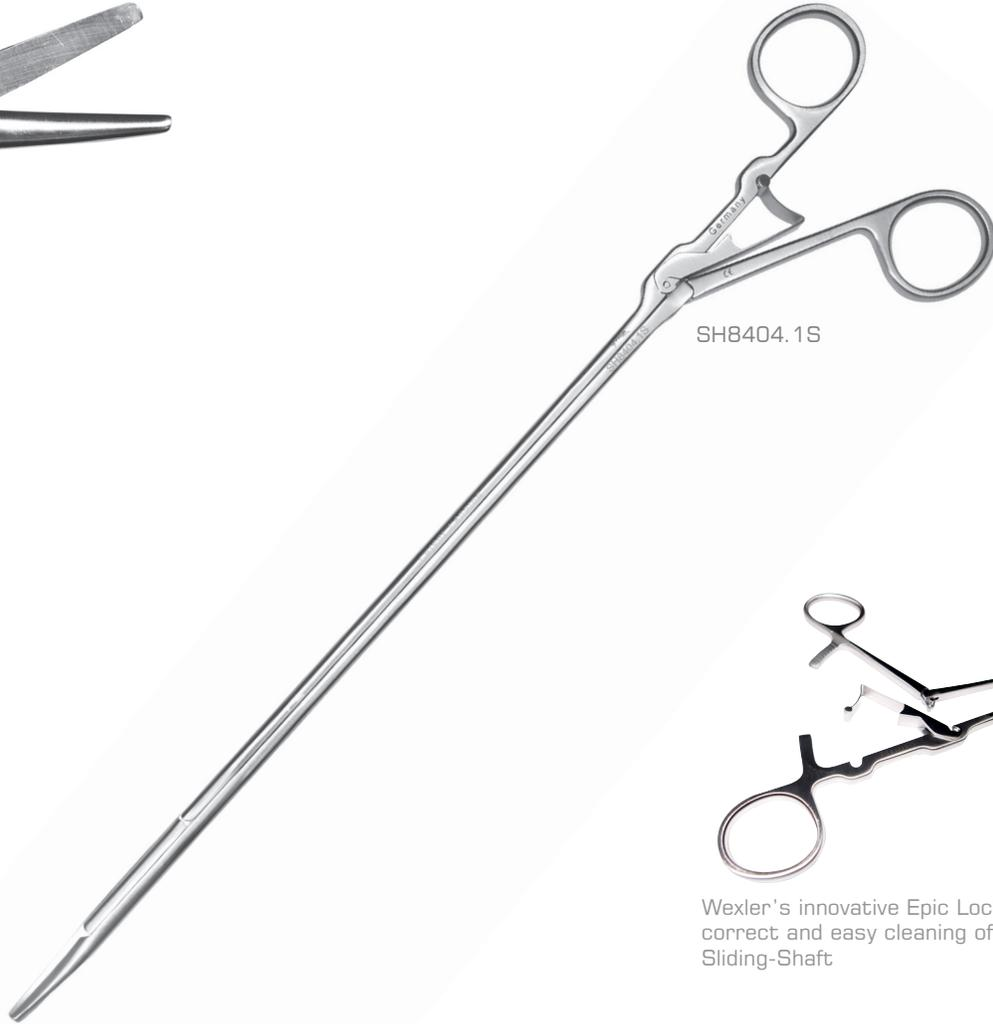

SH8404.1S



Wexler's innovative Epic Lock ensures correct and easy cleaning of the Sliding-Shaft

Images not actual size

VATS•MICS

SH8404.1S EPIC VATS Scissors - Curved 3.5cm Razor Edge blades w/Blunt tips, 7.5mm Shaft, 19.5cm Working Length, 11.5" (29cm)



WEXLER SURGICAL

11333 CHIMNEY ROCK ROAD,
SUITE #110, HOUSTON,
TEXAS 77035

.....
P (713) 723-6900
F (713) 723-6906
T (800) 414-1076
.....

SALES@WEXLERSURGICAL.COM
WWW.WEXLERSURGICAL.COM

