

Crystal Clean Auto Detailing  
3413 Eastern Avenue Southeast  
Wyoming, MI, 49508  
+16164016030

View Invoice - Crystal Clean Auto Detailing

Crystal Clean

3413 Eastern Ave SE  
Grand Rapids, MI 49508  
(616) 821-9074

11/26/2025 10:25

SALE

Trans #: 2 Batch #: 52  
VISA CONTACTLESS  
\*\*\*\*\*5968 \*\*/\*\*  
Base Amt: \$470.00  
Tip Amt: \$47.00  
Total: \$517.00  
RESP: APPROVAL 906252 00  
CODE: 906252  
REF #: 533015831773  
TRANSID: 585330555147045

Cardholder acknowledges receipt of goods  
and obligations set forth by the cardholder's  
agreement with issuer.

CARDHOLDER/VISA

CUSTOMER COPY

Thanks for your business!  
Contact us or leave a review!

Terms

Due on Receipt

Date

11/25/25

Invoice #

A142535

Description

1999 Porsche 996 911 Carrera Black

### Details

Description	Amount
Exterior Detail	\$180.00
Paint Touch-Up Paint touch-up will fill in chips pictured as well as any others found on the exterior of the vehicle.	\$60.00
Full Paint Restoration Our Paint Restoration is the most cost effective way to remove/reduce medium to heavy scratches on every panel of your vehicle. We complete a 3 stage buffing process on every panel to eliminate scratches to the best of our ability. Heavier scratches may not come out completely however they may improve.	\$180.00
Vehicle Photos	\$50.00
	<b>Total: \$470.00</b>

© 2025 - Crystal Clean Auto Detailing

**You purchased these items in-store**

CORE TRADE-IN \$-22.00P 1

-1 @ 1/22.00

\*000516423 CORE TRADE-IN H6-DL

**H6-DL**

**Duralast Battery**

EA

1 @ 1/174.99 \$174.99 P 1

000516423 H6-DL

**H6-DL**

**Duralast Battery**

EA

000516423 CORE CHARGE \$22.00 P

**Total Items Sold: 1**

**Subtotal:** \$174.99

State Tax @ 6.000%: \$10.50

**Transaction Total:** \$185.49

VISA XXXXXXXXXXXX5968 \$185.49

Approval #: 110332

Data Source: CHIP

App Name/Label: VISA CREDIT

AID: A0000000031010

TC 8C4CC94D01D5EB2F

**Total Paid:** \$185.49



**German Auto Service, Ltd**

2189 Avastar Parkway, Suite A  
Grand Rapids, MI 49544  
(616) 454-3289  
service@germanautoltd.com

**Invoice #64769**

Page 1 of 8  
07/19/2024 2:34 PM

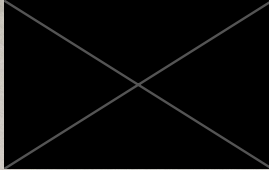

1999 Porsche 911  
WP0AA2999XS624988  
Engine: 3.4L H6 GAS FI  
Plate: CHIZ  
Odometer In: 51256  
Odometer Out:

Advisor: Drew Porritt  
Technician: Jeff Sawyer  
M268289

**GRAND TOTAL: \$1,278.89**

✓ PAID

**SERVICES**

**1 Engine Oil Service**

**SUBTOTAL: \$206.30**

**LABOR**

Perform engine oil service: This service includes a vehicle road test, installation of new engine oil filter, exchange of engine oil, topping off of all reasonably accessible vehicle fluids, adjustment of tire pressures, resetting of pertinent service reminders and installation of an oil change reminder sticker. \*\*\*Performed engine oil service to GAS standards.

Labor: \$71.53  
Parts: \$132.77  
Fees: \$2.00  
Sublet: \$0.00

**PARTS**

PARTS	QTY	EACH	TOTAL
Oil Filter	1.0	\$24.94	\$24.94
Oil-Mobil 1 98HC64/112628	9.5	\$11.35	\$107.83

**HAZMATS & FEES**

HAZMATS & FEES	QTY	FEE	TOTAL
Waste oil and filter disposal	1.0	\$2.00	\$2.00

**2 The Driver's Window Is Malfunctioning**

**SUBTOTAL: \$175.00**

It goes up and down but makes a terrible noise

**LABOR**

Inspect and advise \*\*\*Confirmed customer concern that drivers window moves up and down but makes very unhealthy sound while doing so. Noted that the window only made this sound in a certain position and while doing so the window would tilt slightly. Lowered window fully and pulled back window seal to inspect, found that the cable for the window regulator was loose on the rear pulley. This is often caused by the cable coming unwound in the main spool and is usually indicative of additional failures within the window regulator itself. - Recommend removing door panel to fully inspect regulator and replacing as needed.

Labor: \$175.00  
Parts: \$0.00  
Fees: \$0.00  
Sublet: \$0.00

**3 Door Panel Removal, Regulator Inspection, and Replacement if Needed**

**SUBTOTAL: \$822.69**

**LABOR**

Remove panel and replace regulator if needed \*\*\*Removed door panel to access regulator. With window removed, could hear/feel binding in regulator. Removed and replaced window regulator. Verified new regulator functions as designed and does not make abnormal sounds. Reinstalled all remaining parts and reset window limits.

Labor: \$525.00  
Parts: \$297.69  
Fees: \$0.00  
Sublet: \$0.00

**PARTS**

PARTS	QTY	EACH	TOTAL
Window Regulator	1.0	\$297.69	\$297.69

# Belle Tire

WP0AA2999XS624988  
9/23/22 10:51 AM

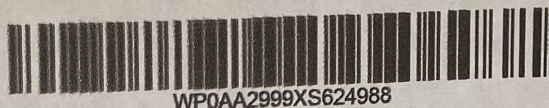

## Porsche 1999-2005 911 Carrera 4 996 (USA)

### Current Measurements

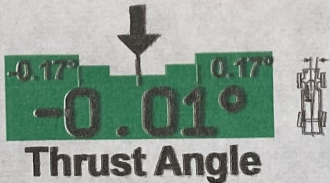
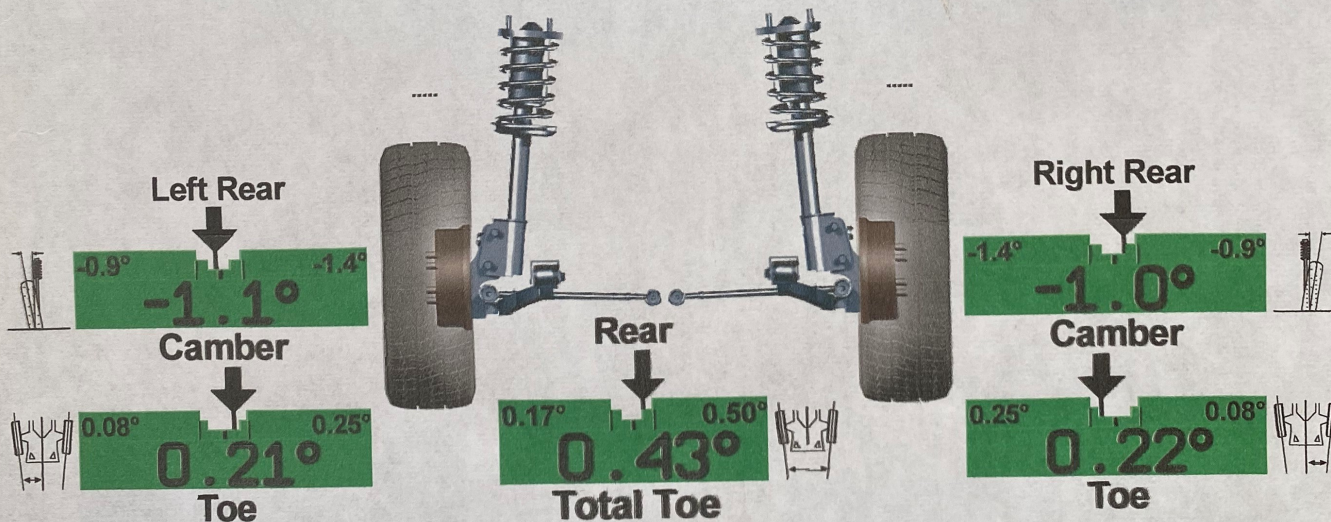
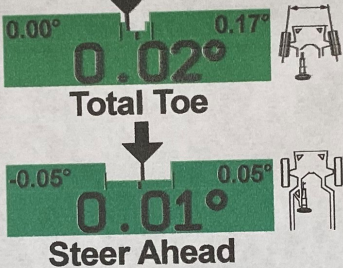
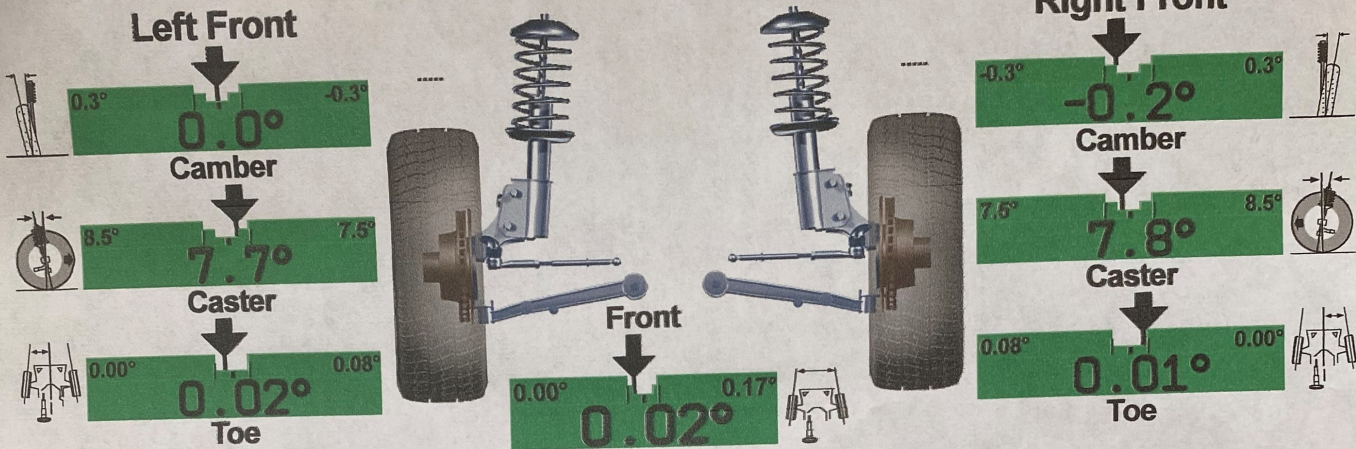





**German Auto Service, Ltd**  
 2189 Avastar Parkway, Suite A  
 Grand Rapids, MI 49544  
 (616) 454-3289  
 service@germanautoltd.com

**Invoice #54387**  
 Page 1 of 9  
 08/27/2021 3:36 PM



**1999 Porsche 911**  
 WP0AA2999XS624988  
 Engine: 3.4L H6 GAS FI  
 Plate: CHIZ  
 Odometer In: 49293  
 Odometer Out: 49293

**Advisor: Ben Zeeuw**  
 Technician: Jake Dillon  
 M273944

**GRAND TOTAL: \$3,039.97**

✓ PAID

**SERVICES**

**1 Perform Pre-Track Event Tech Inspection**

See customer supplied form.

**SUBTOTAL: \$59.50**

**LABOR**

Inspect and advise \*\*\*Vehicle failed tech inspection due to the following - Brake fluid is due for annual flush and tested at 2.5% water content - Left front strut bump stop is deteriorated and right front is cracking, recommend replacing both sides (as well as mounts since struts will be taken apart to replace) and alignment - Positive battery terminal is loose, should be able to tighten - There is an issue with the driver side wiper arm or linkage, it obstructs windshield when activated as if it pops out of socket. Need to investigate - Right front sway bar link is loose - Front brakes are below 50%. Rear brakes are borderline at 50% and should be addressed. Ideally, I would recommend replacement of all brakes. Front brake new lining thickness - 12mm Front brake current thickness - 5mm (Fail) Rear brake new lining thickness - 10.5mm Rear brake current thickness 6mm The rear wheels have minor bends and tires have very minor surface cracking as well as they are 8 years old. Not ideal for any but can still pass, Tires also need to be adjusted to factory pressure (currently 30-32psi, should be 36psi front, 44psi rear) Resolved all of the above issues and signed off on tech inspection.

Labor: \$59.50  
 Parts: \$0.00  
 Fees: \$0.00  
 Sublet: \$0.00

**2 Brake Fluid Flush**

**SUBTOTAL: \$130.05**

**LABOR**

Flush fluid from brake system and fill with new

Labor: \$96.75  
 Parts: \$27.00  
 Fees: \$6.30  
 Sublet: \$0.00

**PARTS**

	QTY	EACH	TOTAL
Brake Fluid-Pentosin DOT4 LV 1224116/1224204	3.0	\$9.00	\$27.00

**HAZMAT & FEES**

	QTY	FEE	TOTAL
Used brake fluid disposal	1.0	\$6.30	\$6.30

**3 Replace Front Bump Stops and Mounts - With Alignment**

**SUBTOTAL: \$1,065.70**

**LABOR**

Remove and replace front bump stops and mounts  
 Perform four wheel alignment

Labor: \$709.50  
 Parts: \$356.20  
 Fees: \$0.00  
 Sublet: \$0.00

**PARTS**

	QTY	EACH	TOTAL
Bump Stop-Front Strut	2.0	\$24.58	\$49.16
Strut Dust Boot	2.0	\$14.21	\$28.42
Strut Mount	2.0	\$79.13	\$158.26

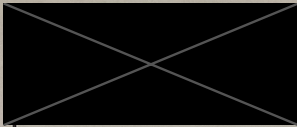

EURO AUTOWERKS  
 9240 BELDING RD  
 ROCKFORD MI, 49341  
 STATE REGISTRATION #F134326  
 616-874-7932

Year	1999	Engine			Page 1
Make	PORSCHE	TransInfo			
Model	CARRERA	Job Type	INVOICE	Date Started	10/01/15
License #		Odometer In	41517	Date Completed	10/09/15
Vin #	WP0AA2999XS624988	Odometer Out	0	Invoice #:	13467

Part Number	Qty	Description	Price	Extension
-------------	-----	-------------	-------	-----------

**A DIAGNOSIS**

Reported Problem -HAS OIL LEAK AT CAMSHAFT SOLENOID ADJUSTER- WOULD TIM SAID WOULD REALLY NOT WORRY ABOUT FIXING WOULD JUST KEEP MOTOR SPRAYED OFF AND CLEANED MAY BE ABLE TO FIX NEXT TIME IN FOR OIL SERVICE WOULD HAVE TO ORDER SEAL FROM DEALER

**A DIAGNOSIS 0.00**

**DISCOUNT**

PCA 1.00 PCA MEMBER DISCOUNT -90.00 -90.00  
**DISCOUNT -90.00**

**LABOR**

LUB4 1.00 OIL AND LUBE SERVICE 65.00 65.00  
 INCLUDES DRAIN AND REFILL ENGINE CRANKCASE, REMOVE AND REPLACE OIL FILTER, LUBE ALL DOOR HINGES, SPRAY DOOR MOLDINGS, CHECK ALL FLUID LEVELS, VISUALLY INSPECT BRAKES, BELTS AND HOSES

LABOR4 9.00 REPLACE CLUTCH KIT, FLYWHEEL AND IMS BEARING 94.00 846.00

**LABOR 911.00**

**PARTS**

99610421554 3.00 CAM PLUGS 10.00 30.00  
 99710121201 1.00 CRANKSHAFT SEAL 25.00 25.00  
 99611691100 1.00 CLUTCH KIT 780.00 780.00  
 99611401204 1.00 FLYWHEEL 800.00 800.00  
 99907309202 8.00 FLYWHEEL BOLTS 2.20 17.60  
 99610722553 1.00 OIL FILTER KIT 15.00 15.00  
 MOBIL I 0W40 8.50 MOBIL I 0W40 SYNTHETIC OIL 9.99 84.92  
 10608.4 1.00 INTERMEDIATE SHAFT BEARING 799.00 799.00

**PARTS 2551.52**

**SUPPLIES**

(616) 292-7342  
 Pay Method = CHECK 3573.31

**Sub Total 3,417.52**  
**Sales Tax 155.79**  
**Total 3,573.31**

Estimate good for 30 days. Not responsible for damage caused by theft, fire or acts of nature. I hereby authorize the above repairs, including sublet work, along with the necessary materials. You and your employees may operate my vehicle for the purpose of testing, inspection and delivery at my risk. If I cancel repairs prior to their completion for any reason, a teardown and reassemble fee of \$\_\_\_ will be applied.

x \_\_\_\_\_ Date \_\_\_\_\_

# DELTA IMPORTS *Only the Best.*

6025 28th Street SE  
Grand Rapids, MI 49512  
(616) 988-9797  
F-158622

CUSTOMER NO. <b>20205</b>	ADVISOR <b>MICHAEL VANDERHART 18057</b>	TAG NO. <b>7543</b>	INVOICE DATE <b>04/27/13</b>	INVOICE NO. <b>POCS628545</b>
[REDACTED]	LABOR RATE	LICENSE NO.	MILEAGE <b>35,881</b>	COLOR <b>/2DR CARRER</b>
	YEAR / MAKE / MODEL <b>99/PORSCHE/911 CARRERA/2DR CARRERA 4</b>			DELIVERY DATE
	VEHICLE I.D. NO. <b>W P O A A 2 9 9 9 X S 6 2 4 9 8 8</b>			SELLING DEALER NO.
	F.T.E. NO.			P.O. NO.
COMMENTS			R.O. DATE <b>04/25/13</b>	PRODUCTION DATE

MO: 35884

JOB# 1 CHARGES-----

FOLLOW UP CALL YES  NO

LABOR-----  
# 1 11POZ ENGINE MINOR TECH(S):755 340.00

CUST STATES COOLANT LEAKS, STATES ANOTHER SHOP REPALACED  
CAP. STILL LEAKING,  
ALSO GET RADIO WORKING--RADIO CODE  
ADVISE  
FOUND COOLANT LEAKING FROM COOLANT TANK. REPLACED TANK AND  
FILLED SYSTEM. NO FURTHER LEAKS FOUND.

PARTS	QTY	FP-NUMBER	DESCRIPTION	UNIT PRICE	PRICE
	1	996-106-147-56	WATER RESERVOIR	368.58	368.58
	1	997-641-503-00	LEVEL SWITCH, COO	47.24	47.24
	1	000-043-301-49	ANTIFREEZE 3.79	42.22	42.22
	1	999-707-554-40	RUBBER O-RING	4.46	4.46
TOTAL - PARTS					462.50

G.O.G. & SUPPLIES-----	
FREIGHT (PARTS)	35.00
TOTAL - GOG	35.00

JOB# 1 TOTALS-----	LABOR	340.00
	PARTS	462.50
	G.O.G.	35.00

JOB# 1 JOURNAL PREFIX POCS JOB# 1 TOTAL 837.50

MISC-----	CODE	DESCRIPTION	CONTROL NO
JOB # A	SC1	SHOP SUPPLIES	
TOTAL - MISC			20.00

ESTIMATE-----  
CUSTOMER HEREBY ACKNOWLEDGES RECEIVING  
ORIGINAL ESTIMATE OF \$100.00 (+TAX)

COMMENTS-----  
DROPOFF

TECHNICIAN CERTIFICATION-----  
755 NICHOLAS DYKSTRA M23777



YOU ARE ENTITLED BY LAW TO THE RETURN OF ALL PARTS REPLACED, EXCEPT THOSE WHICH ARE TOO HEAVY OR LARGE, AND THOSE REQUIRED TO BE SENT BACK TO THE MANUFACTURER OR DISTRIBUTOR BECAUSE OF WARRANTY WORK OR AN EXCHANGE AGREEMENT. YOU ARE ENTITLED TO INSPECT THE PARTS WHICH CANNOT BE RETURNED TO YOU.

NOTICE  
IN THE EVENT THAT YOU, THE CUSTOMER, AUTHORIZE COMMENCEMENT BUT DO NOT AUTHORIZE COMPLETION OF A REPAIR OR SERVICE, A CHARGE WILL BE IMPOSED FOR DISASSEMBLY, REASSEMBLY, OR PARTIALLY COMPLETED WORK. SUCH CHARGE WILL BE DIRECTLY RELATED TO THE ACTUAL AMOUNT OF LABOR OR PARTS INVOLVED IN THE INSPECTION, REPAIR OR SERVICE.

\*SHOP SUPPLIES OF 10% OF LABOR CHARGE, NOT TO EXCEED \$25.00 IS INCLUDED FOR SUPPLIES USED ON YOUR VEHICLE. APPLICABLE SUPPLY ITEMS ARE TAPE, AEROSPRAY, SOLVENT, RAGS, CLEANERS, ELECTRICAL WIRE AND TERMINALS. CHARGE ALSO INCLUDES HAZARDOUS WASTE DISPOSAL AND/OR RECYCLING COSTS OF OIL, SOLVENTS, AND CLEANERS.

CERTIFICATION: ALL REPAIRS AND PARTS LISTED WERE FURNISHED IN COMPLIANCE WITH MICHIGAN AUTO REPAIR ACT. (P.A. 300)

**DISCLAIMER OF WARRANTIES**  
Any warranties on the product sold hereby are those made by the manufacturer. The seller hereby expressly disclaims all warranties, either express or implied, including any implied warranty of merchantability or fitness for a particular purpose, and the seller neither assumes nor authorizes any other person to assume for it any liability in connection with the sale of said products. Any limitation contained herein does not apply where prohibited by law.

ALL REPAIRS PROPERLY COMPLETED AND CHECKED BY:

X

ALL PARTS INSTALLED ARE NEW UNLESS NOTED OTHERWISE.

MAI  
MAY 01 2013  
BY: [Signature]

The Reynolds and Reynolds Company EPANTIVE C0885838 Q (12/09)



EURO AUTOWERKS  
 9240 BELDING RD  
 ROCKFORD MI, 49341  
 STATE REGISTRATION #F134326  
 616-874-7932

Year	1999	Engine			
Make	PORSCHE	TransInfo			
Model	CARRERA	Job Type	INVOICE	Date Started	03/19/12
License #		Odometer In	33500	Date Completed	//
Vin #	WPOAA299XS624988	Odometer Out	0	Invoice #:	9038

Part Number	Qty	Description	Price	Extension
-------------	-----	-------------	-------	-----------

A DIAGNOSIS

Reported Problem		MAINT RECORDS POSS DUE FOR SOME		
VERUS	1.00	RUN DIAGNOSTIC SYSTEM, INCLUDING HISTORY AND CURRENT CODES P0131 151 137 157 ALL CODES FOR LOW VOLTAGE FROM ALL O2 SENSORS CLEARED CODES CKED READINGS ON O2 SENSORS THEY ARE RESPONDING DRIVE CAR IF LIGHT COMES BACK WE CAN RECHECK IT ENGINE FELLS A LITTLE ROUGH AT IDLE COULD BE SPARK PLUGS	65.00	65.00
			<b>A DIAGNOSIS</b>	<b>65.00</b>

LABOR

LABOR4	1.00	CK FOR OIL LEAK CLEAN UP BOTTOM VERY MINOR SEAPAGE LF SIDE OF ENGINE FIND TRANS LEAKING POSSS AT SENSOR CLEANED UP TO RECHECK AND REPLACE SENSOR SEAL	87.00	87.00
LABOR4	1.00	REPLACE CABIN FILTER AND AIR FILTER AS NEEDED	87.00	87.00
			<b>LABOR</b>	<b>174.00</b>

PARTS

75/90 SYNTHTIC GEAR L	1.00	SYN GEAR LUB	20.11	20.11
SEALS	2.00	OIL SEALS	0.65	1.30
99611013152	1.00	AIR FILTER	47.96	47.96
99757121901	1.00	CABIN FILTER	36.50	36.50
			<b>PARTS</b>	<b>105.87</b>

SUPPLIES

SHOP SUPPLIES	1.00	SHOP SUPPLIES	10.44	10.44
			<b>SUPPLIES</b>	<b>10.44</b>

(616) 292-7342

*Paid ✓ 1036*

<u>Sub Total</u>	<u>355.31</u>
<u>Sales Tax</u>	<u>6.98</u>
<u>Total</u>	<u>362.29</u>

Estimate good for 30 days. Not responsible for damage caused by theft, fire or acts of nature. I hereby authorize the above repairs, including sublet work, along with the necessary materials. You and your employees may operate my vehicle for the purpose of testing, inspection and delivery at my risk. If I cancel repairs prior to their completion for any reason, a teardown and reassemble fee of \$\_\_\_ will be applied.

x \_\_\_\_\_ Date \_\_\_\_\_

**ARLINGTON PERFORMANCE CENTER**  
315 W. RAND ROAD  
ARLINGTON HTS, IL 60004  
Phone: 847/392-3505 FAX: 847/577-2031

Work Order No.  
**000038991**

Page 1  
Order Date: 11/23/11 07:58 am

**THANK YOU FOR YOUR BUSINESS!!!!**

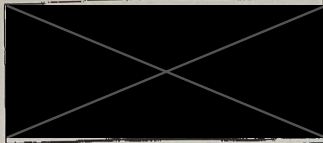

99 PORSCHE 911 BLK  
32676 MI.  
Lic: NONE H6Cyl 3.4 Eng  
Vin: WPOAA2999XS624988 12/98  
Eq:  
Profile:

Quotes  
1 11/08/11 10:12am 192.40  
PATRICK BMW in person.

**Job01 SCAN "AIR BAG" LIGHT & ADVISE** Labor: \$79.00

SCAN. 30,2D. DRIVERS AND PASSENGER SIDE SEAT BUCKLE. ERASE CODES. LIGHT DID NOT REAPPEAR. IF LIGHT REAPPEARS SEAT BUCKLES WILL BE NEEDED.

**Job02 LOF/9-1/2 SYNTHETIC MOTOR OIL** Labor: \$0.00

LOF/9 1/2 SYNTH MOTOR OIL & FILTER-N 1.0 @ 139.00 =\$ 139.00  
REPLACE MOTOR OIL & FILTER IN ACCORDANCE WITH CAR MANUFACTURER'S RECOMMENDATIONS.

**Job03 CHECK BRAKES** Labor: \$0.00

REMOVE WHEELS TO INSPECT FRONT AND REAR BRAKES. APPX 50% REMAINS AT FRONT AND REAR BRAKES.

**Job04 CHECK CLUTCH** Labor: \$0.00

CLUTCH OPERATION OK.

**Job05 REVERSE LIGHTS INOP** Labor: \$75.00

996 606 103 01 SWITCH-S 1.0 @ 20.00 =\$ 20.00  
DIAGNOSE AND REPLACE REVERSE LIGHT SWITCH.

**Job06 REAR DECK STRUT** Labor: \$35.00

996 512 551 03 STRUT-S 1.0 @ 41.00 =\$ 41.00

----->----->-----Continued on the next page----->----->----->

**Job06 REAR DECK STRUT**  
REPLACE

Payments to ARLINGTON PERFORMANCE CENTER	Cost Summary	
Status: New Work Order	Labor	189.00
	Parts	200.00
Payments:	Subtotal	389.00
	Tax	19.00
	Total	\$408.00
	Payments	0.00
	Bal Due	408.00